
Syntheses of Azaborine Polymers and Optimisation of Precursor Syntheses



Dissertation

zur Erlangung des Doktorgrades
der Mathematisch-Naturwissenschaftlichen Fakultät
der Christian-Albrechts-Universität zu Kiel

vorgelegt von

Birk Thiedemann

Kiel 2017

1. Gutachterin:	Prof. Dr. Anne Staubitz
2. Gutachter:	Prof. Dr. Ulrich Lüning
Tag der mündlichen Prüfung:	26.01.2017
Zum Druck genehmigt:	30.01.2017

gez. Prof. Dr. Natascha Oppelt, Dekanin

Die vorliegende Arbeit wurde unter Anleitung von
Prof. Dr. Anne Staubitz
in der Zeit vom 09. November 2012 bis zum 17. November 2016
am Otto Diels-Institut für Organische Chemie
der Christian-Albrechts-Universität zu Kiel
und
am Institut für Organische und Analytische Chemie
der Universität Bremen
angefertigt.

Hiermit erkläre ich, Birk Thiedemann, an Eides statt, dass ich die vorliegende Dissertation selbstständig und nur mit den angegebenen Hilfsmitteln angefertigt habe. Inhalt und Form dieser Arbeit sind, abgesehen von der Beratung durch meine Betreuerin Prof. Dr. Anne Staubitz, durch mich eigenständig erarbeitet und verfasst worden. Die Arbeit entstand unter Einhaltung der Regeln guter wissenschaftlicher Praxis der Deutschen Forschungsgemeinschaft. Weder die gesamte Arbeit noch Teile davon habe ich an anderer Stelle im Rahmen eines Prüfungsverfahrens eingereicht. Dies ist mein erster Prüfungsversuch.

Kiel, den 30.01.2017

(Birk Thiedemann)

Danksagung

An dieser Stelle möchte ich die Gelegenheit nutzen, mich bei einigen Personen aus ganzem Herzen zu bedanken, die mit tatvoller Unterstützung zum Gelingen dieser Arbeit beigetragen haben:

An erster Stelle möchte ich Prof. Dr. Anne Staubitz danken. Dass du mir das Vertrauen geschenkt hast, alleine auf dem kaum erforschten Themengebiet der hoch-sensitiven 1,2-Azaborine einzusteigen, hat der Entwicklung meiner Kompetenzen einen großen Schub gegeben. Zusätzlich möchte ich dir für deine ausgezeichnete Betreuung, dein Engagement und nochmals für dein Vertrauen in verschiedensten Situationen danken.

Ein weiteres Dankeschön gilt der Deutschen Forschungsgemeinschaft, die meine Chefin, Prof. Dr. Anne Staubitz, durch das Emmy Noether-Programm und somit auch mich in meinem Promotionsvorhaben finanziell unterstützt hat.

Prof. Dr. Frank D. Sönnichsen möchte für die Übernahme des Zweitgutachtens und für die Kooperation in meinen Forschungsprojekten danken. Ebenfalls möchte ich mich bei der spektroskopischen Abteilung in Kiel bedanken – besonders herausheben möchte ich Gitta und Marion: Danke für die Erfüllung von Sonderwünschen und vielen spontane Messungen. Ohne eure Hilfe wären meine Projekte nicht durchführbar gewesen. An dieser Stelle danke ich auch noch Dr. Paul Gates aus Bristol/UK: thank you very much for measuring all the high resolution mass spectra, Paul. Ebenfalls aus Bristol/UK kommt mein Kooperationspartner: big thanks to Paul Lawrence for measuring the ^{11}B NMR spectra of my polymers.

Für die Mitarbeit an meinen Projekten und die gemeinsame Zeit möchte ich meinen Praktikanten Christin und Jan-Ole sowie meiner Bachelor-Studentin Louise vielmals danken. Weiterhin bedanke ich mich bei Dr. Lu-Ying He für das entgegengebrachte Vertrauen während des Kooperationsprojektes. Vielen lieben Dank auch an die gesamte Arbeitsgruppe. Es herrschte eine sehr angenehme, hilfsbereite und humorvolle Atmosphäre.

Ein großes Danke geht auch an die Leute, die noch einmal Korrektur gelesen haben: Uta Corinna, Annika, Matti und Julian. Dankeschön!

Für eine besondere Entlastung in der Endphase haben auch meine Schwiegereltern in spe gesorgt. Vielen, vielen Dank, Susanne und Hinrich.

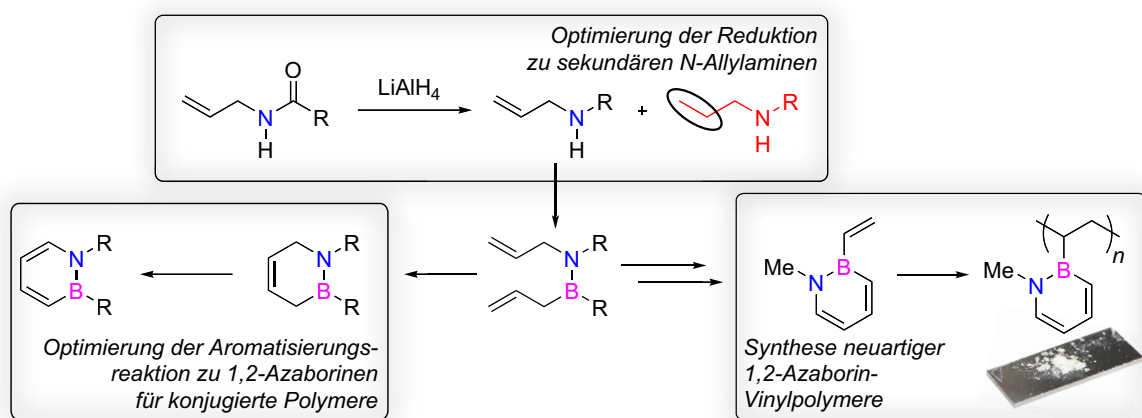
Eine besondere Rolle zum Erreichen meiner bisherigen Ziele spielten meine Eltern, mein Bruder und meine Großeltern. Ein ganz besonderes Dankeschön für eure Unterstützung und dass ihr mir immer wieder zeigt wie stolz ihr auf mich seid.

Zu guter Letzt möchte ich mich bei Uta Corinna bedanken. Deine unterstützenden, aufbauenden und liebenswerten Worte, deine Hilfsbereitschaft und die vielen unvergesslichen Momente während des Studiums als meine Kommilitonin, meine beste Freundin und meine Partnerin sind unersetzlich. Ohne dich wäre ich niemals bis hier her gekommen! Danke, danke, danke!

DANKE

Kurzzusammenfassung

Eine essentielle Komponente für die Synthese von 1,2-Azaborinen ist sekundäres Allylamin. Um dieses herzustellen, ist die Reduktion von Allylamiden mit Hilfe von Lithiumaluminiumhydrid eine gängige Methode. Die Anwendung von literaturbekannten Vorschriften führte allerdings zu einem Angriff auf die nicht aktivierte, unpolare Doppelbindung. Daraus resultierte ein Problem in der Separation von Produkt und Nebenprodukt. In Folge dessen wurden eine detaillierte Untersuchung des Mechanismus und eine Optimierung der Reaktionsbedingungen für die Synthese von Allylaminen durchgeführt.

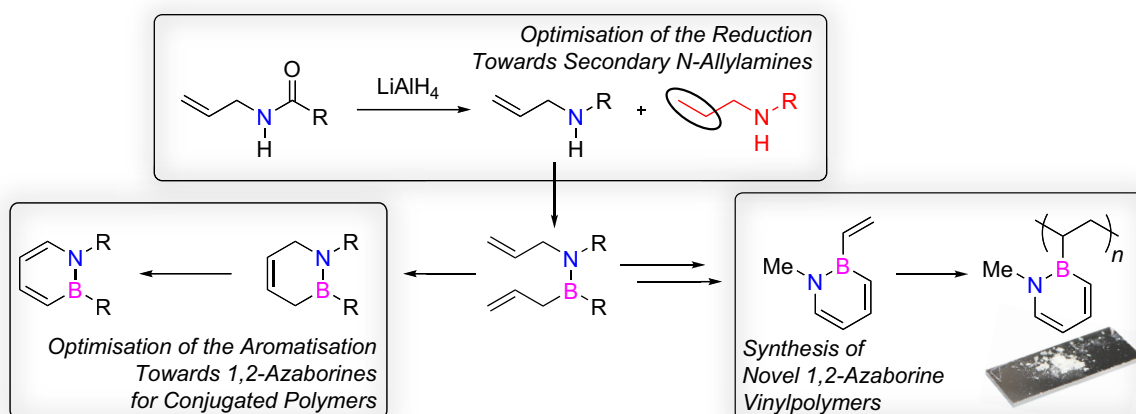


Bei der Synthese der Monomere für konjugierte 1,2-Azaborin-Polymere stellte sich die Aromatisierung (oxidative Dehydrogenierung) zu 1,2-Azaborinen als Nadelöhr-Reaktion mit mäßiger Umsetzung heraus. Eine Optimierung der Reaktionsbedingungen führte zwar zur Verbesserung der Umsetzung, aber durch die schnelle Desaktivierung durch den Arylbromid-Substituent auch zur Limitierung von Palladium als Katalysator dieser Reaktion.

Da allerdings die Aromatisierung zum N-methylierten Azaborin zu einer nahezu vollständigen Umsetzung führte und eine erfolgreiche Isolierung ermöglichte, konnte das N-Methyl-B-vinylazaborin synthetisiert werden. Eine anschließende freie radikalische Polymerisation ergab ein neuartiges Poly(vinylazaborin) – ein neues B-N-Analogon von Polystyrol. Darüber hinaus wurde das erste Copolymer seiner Art durch die Copolymerisation mit dem C-C-Analogon (2-Methylstyrol) erfolgreich hergestellt. Ein sorgfältiger Vergleich der Polymere mit Hilfe von NMR-Spektroskopie, Thermogravimetrie, dynamischer Differenzkalorimetrie, Gel-Permeations-Chromatographie, UV/Vis-Spektroskopie und IR-Spektroskopie zeigte signifikante Unterschiede der Eigenschaften.

Abstract

On the route to 1,2-azaborines, secondary allylamines were needed as starting materials. For the syntheses of these allylamines, the reduction of allylamides by lithium aluminium hydride is a common method. However, the application of reported procedures led to an unexpected attack of the unactivated nonpolar double bond and, consequently, to a separation problem of product and by-product. Therefore, an in-depth investigation of the mechanism and an optimisation of the reaction conditions were performed.



Towards the synthesis of monomers for conjugated 1,2-azaborine polymers, the aromatisation (oxidative dehydrogenation) to 1,2-azaborines emerged to be the bottleneck reaction with only moderate conversion. Consequently, an optimisation of the reaction conditions was performed which led to an improvement, but also revealed inherent limitations due to a fast catalyst deactivation by the aryl bromide substituent.

Since the aromatisation to the N-methylated azaborine led to nearly full conversion and a feasible isolation, N-methyl-B-vinylazaborine was successfully synthesised. A following free radical polymerisation resulted in a novel poly(vinylazaborine) – a new B-N analogue of polystyrene. Furthermore, a copolymerisation with the C-C analogue (2-methylstyrene) led to the first copolymer of its type. A thorough comparison of the polymers by NMR spectroscopy, thermogravimetry, differential scanning calorimetry, gel permeations chromatography, UV-Vis spectroscopy and infrared spectroscopy showed significant differences of their physical and chemical properties.

Abbreviations

2MeS	2-Methylstyrene
Abs	Absorption
Ac	Acetyl
ACHN	1,1'-Azobis(cyclohexanecarbonitrile)
AIBN	2,2'-Azobis(2-methylpropionitrile)
All	Allyl
a-PS	Atactic polystyrene
Ar	Aromatic cycle/substituent
ATR	Attenuated total reflectance
ATRP	Atom transfer radical polymerisation
Boc	<i>tert</i> -Butyloxycarbonyl
br	Broad (NMR)
calcd.	Calculated
COD	Cyclooctadiene
Cp	Cyclopentadienyl
d	Doublet (NMR)
DDQ	2,3-Dichloro-5,6-dicyano-1,4-benzoquinone
DMP	Dess-Martin Periodinane
DSC	Dynamic scanning calorimetry
E _g	Energy gap / band gap
EI	Electron ionisation
Et	Ethyl
FPT	Freeze, Pump and Thaw
FRP	Free radical polymerisation
GC	Gas Chromatography
GPC	Gel Permeation Chromatography
h	Hours
HH	Head-to-head
HT	Head-to-tail
IBX	2-Iodoxybenzoic Acid
LDA	Lithium diisopropylamide
m	Multiplet (NMR)
Me	Methyl
M _n	Number average molecular weight
M _w	Weight average molecular weight
MW	Microwave
NMe2VAB	<i>N</i> -Methyl-2-vinylazaborine
P2MeS	Poly(2-methylstyrene)
PDI	Polydispersity index
PE	Polyethylene
Ph	Phenyl
PNMe2VAB	Poly(<i>N</i> -methyl-2-vinylazaborine)
PP	Polypropylene
PPSE	Trimethylsilyl polyphosphate
PS	Polystyrene
PS-E	Extended Polystyrene

PTFE	Polytetrafluoroethylene
PVAB	Poly(vinylazaborine)
PVC	Poly(vinylchloride)
PVP	Poly(vinylpyridine)
R	Rectus (lat. for right)
RAFT	Radical addition fragmentation transfer
S	Sinister (lat. for left)
s	Singlet (NMR)
SFRP	Stable free radical polymerisation
s-PS	Syndiotactic polystyrene
<i>t</i> Bu	<i>tert</i> -Butyl
<i>t</i> BuOMe	<i>tert</i> -Butylmethyl ether
T_g	Glass transition temperature
TGA	Thermogravimetry
THF	Tetrahydrofuran
T_m	Melting point
TMSCl	Trimethylsilyl chloride
TOC	Table of contents
TT	Tail-to-tail

Table of Contents

1	A Guide Through This Thesis	1
2	Introduction.....	3
2.1	Vinyl Polymers.....	3
2.1.1	Ring Modified Polystyrene	4
2.1.2	Structural Characteristics of Vinylpolymers	5
2.1.3	Polymerisation Methods for Vinylpolymers.....	6
2.2	Boron-Nitrogen Bonds	9
2.3	Azaborines.....	10
2.4	Azaborine Polymers	12
2.4.1	Conjugated 1,2-Azaborine Containing Polymers.....	12
2.4.2	Non-Conjugated 1,2-Azaborine Containing Polymers.....	13
2.5	Common Synthetic Routes to 1,2-Dihydro-1,2-Azaborines.....	14
2.5.1	Synthesis of Secondary Allylamines	16
3	Results and Discussion.....	18
3.1	Accessing Allylamines	18
3.1.1	Reduction of <i>N</i> -Allylamides	19
3.2	Towards Conjugated 1,2-Azaborine Polymers.....	32
3.2.1	Optimisation of the Oxidative Dehydrogenation towards 1,2-Azaborines.....	34
3.3	1,2-Azaborine Vinylpolymers.....	44
3.3.1	First <i>N</i> -Methyl-2-vinylazaborine Polymer and Copolymer.....	44
3.3.2	Comparison of Poly(<i>N</i> -methyl- <i>B</i> -vinylazaborine) and Poly(<i>N</i> -hydro- <i>B</i> -vinylazaborine)	45
3.4	Cooperation project.....	51
3.4.1	Nucleophile-Selective Cross-Coupling Reactions	51

4	Summary and Outlook	57
4.1	Accessing Allylamines.....	57
4.2	Towards Conjugated 1,2-Azaborine Polymers	58
4.3	1,2-Azaborine Vinylpolymers	61
5	Experimental Section	65
5.1	Supporting Information on Chapter 3.1.....	65
5.1.1	Supporting Information for <i>J. Org. Chem.</i> 2014, 79, 10284.	65
5.2	Supporting Information on Chapter 3.2.....	66
5.2.1	General Methods	107
5.2.2	Analyses	107
5.2.3	Chemicals	108
5.2.4	Solvents.....	109
5.2.5	Syntheses of the Bachelor's Thesis by L. Dölger	110
5.2.6	Syntheses and Characterisation of Isolated Compounds	111
5.2.7	Oxidative Dehydrogenation Reaction Screening	131
5.3	Supporting Information on Chapter 3.3.....	150
5.3.1	Supporting Information for <i>Chem. Commun.</i> 2016, <i>submitted</i>	150
5.4	Supporting Information on Chapter 3.4.....	151
5.4.1	Supporting Information for <i>Eur. J. Org. Chem.</i> 2015, 2498.	195
6	References.....	269

1 A Guide Through This Thesis

One goal of this work was to prepare poly(*B*-vinylazaborine)s as the first azaborine analogues of polystyrene. The development of a general synthetic route towards 1,2-azaborines¹ by Ashe et al. in the year 2000 paved the way to a wide range of azaborines. Key starting materials in this route are allylamines. Therefore, the obvious and easiest way for varying 1,2-azaborines was the use of different substituted secondary allylamines. For these compounds, several synthetic methods exist in principle. The reduction of allylamides by using LiAlH₄ as reducing agent is the most versatile route to secondary allylamines. Theoretically, it should result in the corresponding amines, potentially with amides as side products in the worst case. Separation of amine and the corresponding amide is generally feasible. Thus, this synthetic route was applied to obtain secondary allylamines for the synthesis of 1,2-azaborines which were to be used in further projects (see **Chapter 3.3** and **3.2**). However, reduction by LiAlH₄ led to an unexpected attack of the double bond and as a consequence to a separation problem of product and by-product (**Figure 1**). For this reason, a mechanistic and optimisation study of this reaction was performed (see **Chapter 3.1.1**).

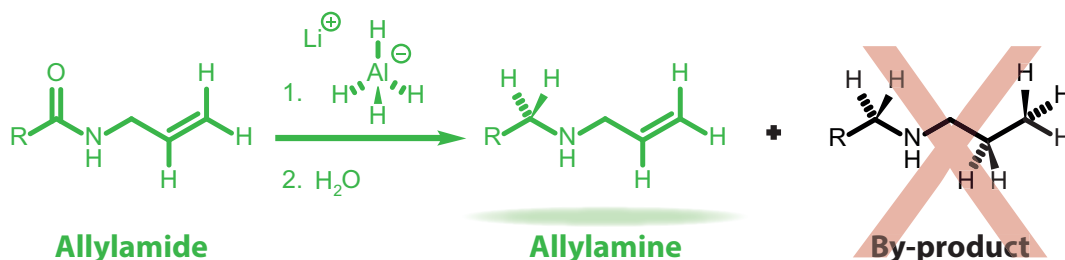


Figure 1. The objective for the first project was a mechanistic study on the over-reduction of secondary allylamines and an optimisation of the reaction conditions.

A second goal of this work was to optimise the oxidative dehydrogenation step which was pointed out as the bottle-neck reaction towards a monomer for conjugated azaborine polymers.

¹ In literature as well as in this thesis, the name “1,2-azaborine” or “azaborine” is often used as an abbreviation for the correct name “1,2-dihydro-1,2-azaborine”.

The following chapter is then concerned with the synthesis of vinylazaborines and their polymerisations (**Figure 2**). In addition, the feasibility of a copolymerisation with the corresponding C-C containing monomer was to be tested. A full comparison of the B-N polymer, the copolymer and the C-C polymer revealed novel insights into B-N/C-C isosterism and also into this new B-N material (**Chapter 3.3.1**).

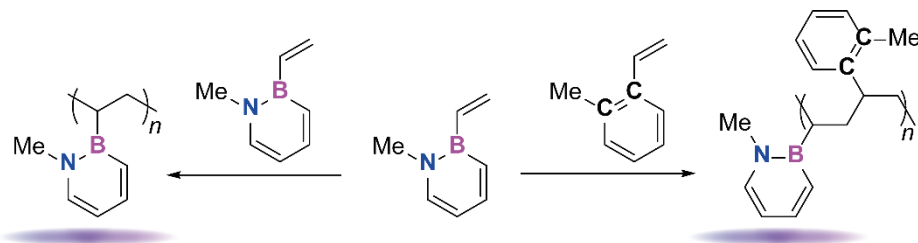


Figure 2. Is it possible to polymerise and copolymerise a B-N bond containing vinylazaborine? Which differences are between the B-N and the corresponding C-C type?

Besides these core projects dealing with azaborines, I collaborated with Dr. Lu-Ying He on a project in her PhD thesis on “Nucleophile-Selective Cross-Coupling Reactions with Vinyl and Alkynyl Bromides on a Dinucleophilic Aromatic Substrate” which resulted in a further publication (**Chapter 3.4**).

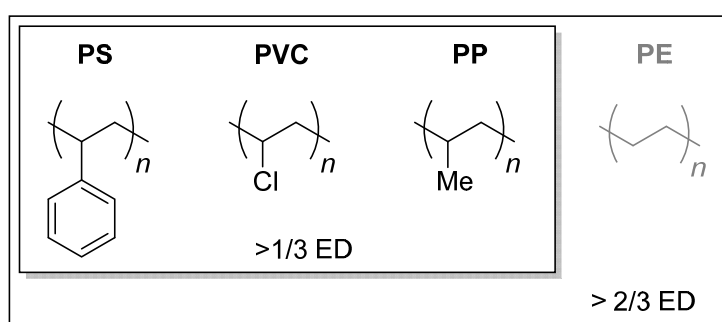
Numbering of compounds in this work

The compounds which are not published so far are numbered starting from number **1**. However, every publication has its own numbering of compounds. This will be integrated into this work, if needed, by adding a prefix: For example “**P1-**” which stands for “Publication 1”. Consequently, the **compound 1** of the **publication 1** will be numbered as “**P1-1**”.

2 Introduction

2.1 Vinyl Polymers

In the European plastics industry, the demand for vinyl polymers constitutes more than one third of all plastics. Including polyethylene (PE), polyolefines comprise more than two-thirds of the market with a turnover of over 350 billion € in 2014.¹ These enormous numbers demonstrate the high importance of this class of polymers (**Scheme 1**).



Scheme 1. Representatives of vinyl polymers with highest demand in European industry; PS = polystyrene, PVC = poly(vinylchloride), PP = polypropylene, PE = polyethylene, ED = european demand.¹

Not only for industry, but also for research groups these polymers are of high interest. A particular research field is the synthesis of functional polyolefines, especially those with polar functional groups, which can improve the properties in terms of adhesion, toughness, printability, miscibility and rheology.² For their preparation, different strategies are imaginable: for example postfunctionalisation of polymers or the copolymerisation of polar and nonpolar monomers (random, controlled alternating or blockcopolymerisation). The latter approach was chosen in this topic, where a novel olefinic monomer was developed and polymerised. This olefinic monomer, *N*-methyl-*B*-vinylazaborine, contains a polar boron-nitrogen bond.

Vinyl polymers, shown in **Scheme 1**, differ in their side chains. In this respect, polystyrene (PS) offers many variation possibilities due to the potential to substitute *ortho*-, *meta*- and *para*-positions on the benzene ring.³⁻⁹ This fact makes it easy to tune the properties of PS to the desired applications. Pure PS is remarkable for its high stiffness, medium hardness and strength but low impact resistance.¹⁰ Beyond the substitution pattern of PS, processing also influences the resulting material. Thus, polystyrene is used for example in different forms in

(food) packaging,¹¹⁻¹³ as expanded version (PS-E) in (thermal) insulations¹³⁻¹⁵ (**Figure 3; b and d**), as tough plastic for casing^{12,13,16} (**Figure 3; a**) and household objects^{12,13,17} (**Figure 3; c**) or as ingredient synthetic rubber for tires.¹⁸

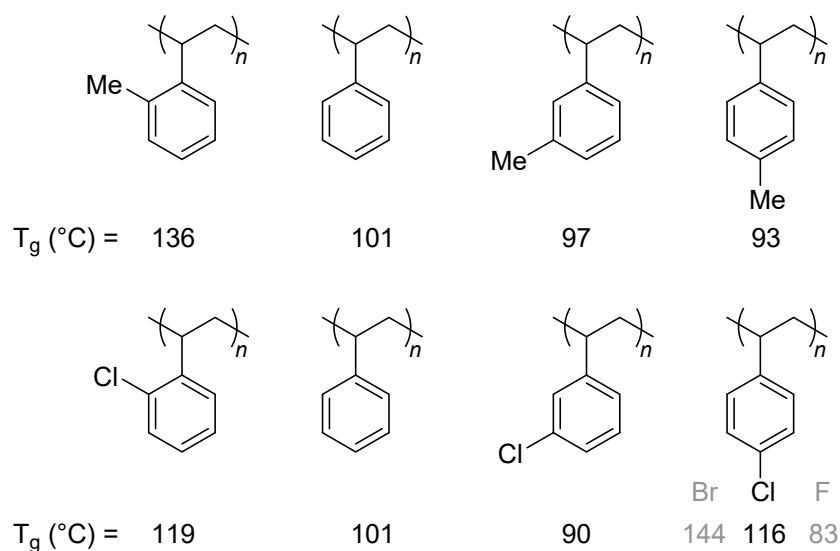


Figure 3. Collection of photographic images which show applications of polystyrene; a)¹⁶, b)¹⁴, c)¹⁷, d)¹⁵.

2.1.1 Ring Modified Polystyrene

Modifications at the benzene unit have a significant effect on the molecular packing behaviour, on the space between each side arm and consequently on the rotation ability of the backbone.^{19,20} In early 1963, Dunham et al. investigated a range of differently substituted PS and found correlations between the substitution position, the substituent bulkiness and the glass transition temperature (T_g), in which the latter is a first indication for free rotation of the backbone. Mono methyl substitution on *ortho*-position increased the T_g compared to PS whereas a methyl group on *meta*- and *para*-position decreased the T_g . For mono chloro substitutions on *ortho*- and *meta*-position similar behaviours were observable, although *para*-chlorinated PS showed an increase of the T_g . Beside the steric effect, which is underlined by an increase in T_g with increasing size of the halogen atom, other influences are obviously more dominant in the *para*-position (**Scheme 2**).⁹

For the substitution of hydrogen of the benzene ring almost infinite possibilities are imaginable. Additionally, it is also considerable to exchange one or more carbon atoms for heteroatoms, which still further extends the variety. In the case of nitrogen as heteroatom, the resulting polymers are poly(vinylpyridine)s (PVP)s, which are both more polarized compared to PS and capable to bind metals and metal complexes with the free electron pair of the nitrogen.^{21,22}



Scheme 2. Comparison of the glass transition temperatures (T_g) of differently substituted polystyrenes.⁹

2.1.2 Structural Characteristics of Vinylpolymers

Except for polymers made of symmetric vinyl monomers (e.g. polyethylene [PE] or poly[tetrafluoroethylene] [PTFE]), every second carbon atom in the backbone of vinyl polymers is a stereogenic center. Consequently, two vinyl polymers with identical monomer units can be fundamentally different. Thus, it is important to further distinguish the description of the polymer by the sequence of the absolute configuration along the backbone. For this, two repeat units with the same absolute configuration (e.g. R-R or S-S) are defined as *meso diad (m)*; with a different configuration (e.g. R-S or S-R) they are defined as *racemic diad (r)*. In polymers, R-R and S-S diads as well as R-S and S-R are almost not distinguishable after rotation by 180 degrees, which results in defined categories: isotactic, syndiotactic, atactic and heterotactic polymers (**Figure 4**).²³

In the case of PS, the isotactic and syndiotactic polymers are highly crystalline. Both polystyrenes form helical structures, in which even four different modifications (δ , α , β , ϵ) are known for s-PS.^{20,24,25} In comparison, atactic PS (a-PS) is amorphous but has a much higher solubility for example in ketones and is the most important form in industry.²⁶ The effect of tacticity on thermal properties as T_g or melting point (T_m) is negligible for PS. However, the comparison of PS with the related poly(*ortho*-methylstyrene) shows an important difference: the T_g of isotactic (96 °C)²⁷ and atactic (136 °C)⁹ poly(*ortho*-methylstyrene) indicates a significant effect of tacticity – at least for the glass transition. Melting temperatures of poly(*ortho*-methylstyrene)s

with different tacticity are not available in literature. Furthermore, the chain length or molecular weight of the polymer can be a crucial factor for thermal properties. In case of PS, the T_g clearly decreases below 20.000 g/mol.^{28,29} Polymer length and tacticity can be influenced or even controlled depending on the polymerisation method.

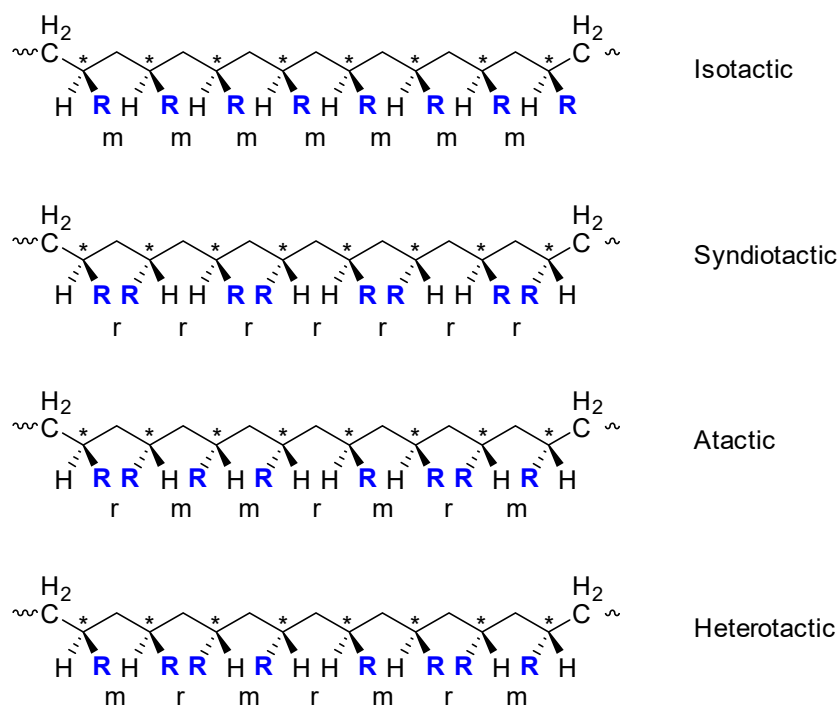


Figure 4. Illustration of the four possible tacticities for vinyl polymerisation.

2.1.3 Polymerisation Methods for Vinylpolymers

Polymerisation of vinylpolymers is possible by three main types: *radical*, *ionic* and *metal complex polymerisation*. In this work, only the first type was applied. Thus, only this polymerisation method will be explained in more detail.

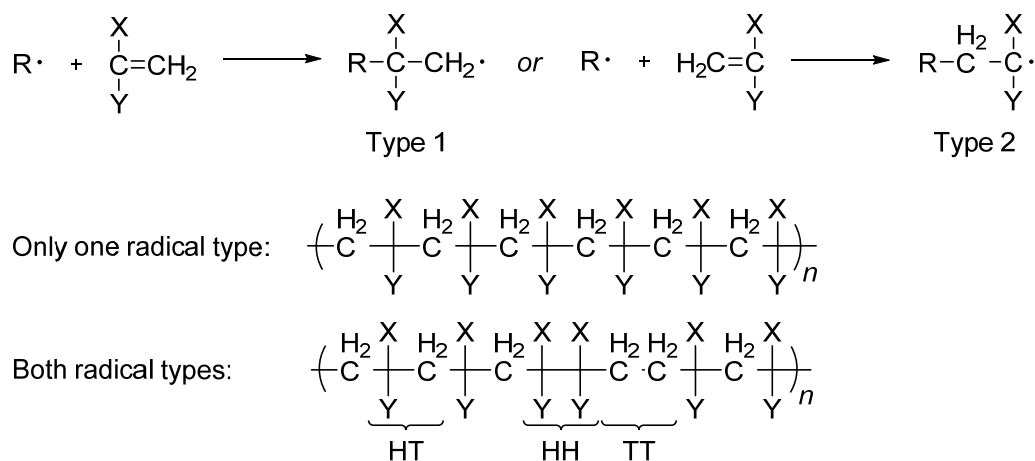
2.1.3.1 Radical Polymerisation

Free Radical Polymerisation

Free radical polymerisation (FRP) is applicable to a wide range of monomer types and is of high interest for commercial polymer production. To start the polymerisation, a radical initiator is necessary (thermal or photo-sensitive). Common representatives are peroxides, hydroperoxides, azo compounds, photoinitiators and redox initiators. In addition, initialisations by

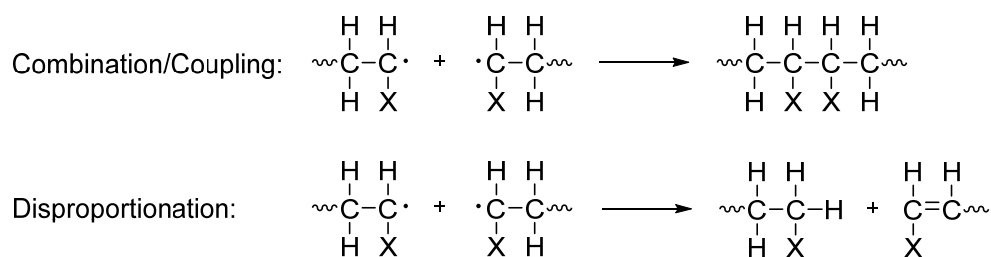
thermal (usually above 50 °C) or electrochemical methods are also possible. Furthermore, vinyl polymers can be obtained by techniques in *bulk*, *suspension*, *solution* or *emulsion*. Except for bulk reactions, all other techniques offer a fast heat transfer.³⁰

In FRP of vinyl monomers, the radicals (initiator and growing chain) can attack the vinyl double bond from two sides – either the CH₂ group or the higher substituted carbon. This results in theoretically three connections: head-to-head (HH); head-to-tail (HT) or tail-to-tail (TT). However, experiments revealed that in general no more than 1-2% of HH occurs in various vinyl polymerisations. Only if the substituent is very small as in the case of fluoride, the HH proportion may increase to 12%. These low HH amounts are explained by both steric reasons and the strong difference between the radical stabilisation energies of the radical types 1 and 2 (**Scheme 3**).³¹



Scheme 3. Two different modes of chain propagation in a radical polymerisation of vinyl monomers due to two possibly attackable carbon atoms of the vinyl substituent; illustration slightly modified from literature.³¹

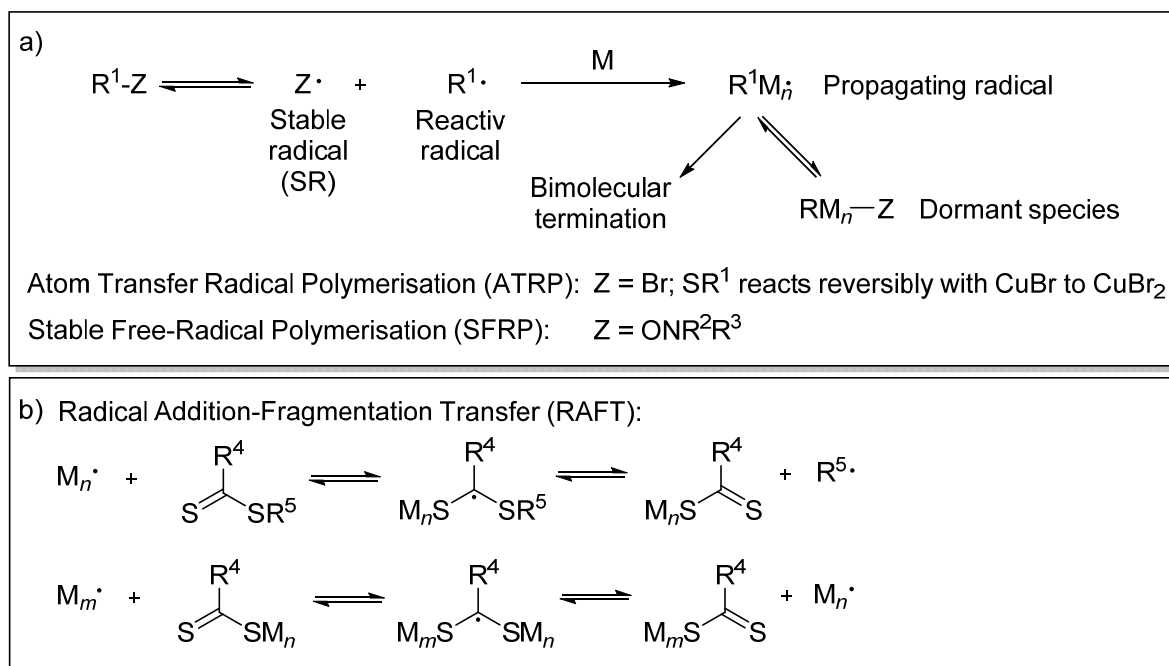
The propagation rate constant of most vinyl monomers is very large and leads to a rapid chain growth to high polymer weights. The chain growth can be stopped by different termination processes: by combination of two radicals and by disproportionation (**Scheme 4**). The latter is less probable in the beginning of the process due to radical concentration.³¹



Scheme 4. Termination processes by combination of propagating radicals (or one propagating radical and one initiator) and by disproportionation of two propagating radicals to one saturated and one unsaturated polymer chain.

Living radical polymerisation as special case of radical polymerisation

Beyond the FRP, there are “living” adaptations of this polymerisation type: For example *atom transfer radical polymerisation (ATRP)*, *stable free radical polymerisation (SFRP)* and *radical addition fragmentation transfer (RAFT)*. All three living radical polymerisations are related to each other by a reversible termination step and an equilibrium between the propagating radical and a dormant species. Hence, the reactive centre will theoretically “live” during the whole polymerisation process. For achieving this, special initiators were developed which decompose into one reactive and one stable radical, where the second is not initiating polymerisation. However, the stable radical is able to react in a reversible manner with the propagating radical to form the dormant species (**Scheme 5**). This living characteristic is interesting for the control of block copolymerisations and, consequently, for well-directed adaptation of copolymer properties.³¹ The RAFT method was applied on a vinylazaborine, which was published nearly simultaneously to this thesis by Wan et al.³², and will be discussed in later chapters (**2.4.2** and **3.3**).



Scheme 5. a) General mechanism of the living radical polymerisations (ATRP and SFRP); b) Slightly different mechanism of RAFT compared to ATRP and SFRP.

2.2 Boron-Nitrogen Bonds

Nowadays, organic chemistry without the element boron is nearly inconceivable. Due to its great importance, Lipscomb (1976),³³ Brown (1979)³⁴ and Suzuki (2010)³⁵ were honoured with the Nobel prize. In the last years, special attention was drawn to compounds containing boron-nitrogen (B-N) bonds caused by research in the fields of hydrogen storage,³⁶⁻³⁹ biomedical research⁴⁰ and optoelectronic materials.⁴¹⁻⁴⁵ Here, the focus is mainly on the incorporation of the carbon-carbon (C-C) isosteric B-N bond. Although the B-N unit has the same amount of valence electrons compared to C-C, it brings a dipole moment into the organic compound (ammonia-borane = 5.2 Debye; aminoborane = 1.8 Debye).^{46,47} In addition, the bond dissociation energy is lower than for the respective C-C counterpart: ammonia-borane (27.2 kcal/mol) vs. ethane (90.1 kcal/mol) (**Figure 5**, left) or aminoborane (139.7 kcal/mol) vs. ethene (174.1 kcal/mol) (**Figure 5**, middle).⁴⁸

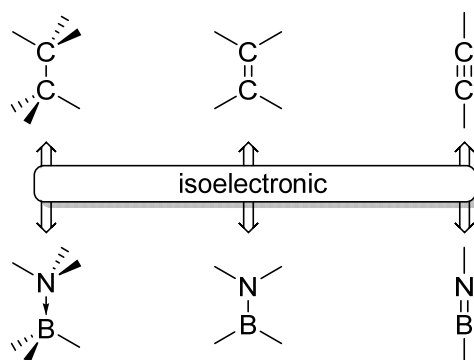


Figure 5. Comparison of the C-C bonds and their isoelectronic B-N analogues.

One approach for incorporating B-N units is to use well established C-C structures and substitute one or more C-C units by B-N. Especially in aromatic scaffolds, a B-N unit can result in a significant change in electronic properties.⁴⁸ A substitution of a C-C unit by B-N in the simplest carbon aromatic compound, benzene, leads to 1,2-dihydro-1,2-azaborine.

2.3 Azaborines

Azaborines are cyclic hybrid molecules that are located in the range between organic benzene on the one hand and inorganic borazine on the other hand. These show more or less aromaticity and stability depending on both the arrangement and the number of nitrogen and boron atoms.^{49,50} Based on calculations, the stability decreases in the order 1,2-dihydro-1,2-azaborine > 1,4-dihydro-1,4-azaborine > 1,3-dihydro-1,3-azaborine. However, the order of aromaticity differs from the stability (1,3-dihydro-1,3-azaborine > 1,2-dihydro-1,2-azaborine > 1,4-dihydro-1,4-azaborine) but all azaborines are more aromatic than the pure inorganic borazine (**Figure 6**) – even diazadiborines (containing 2 boron and 2 nitrogen atoms),⁵¹ which will not be further analysed due to the scope of this thesis.

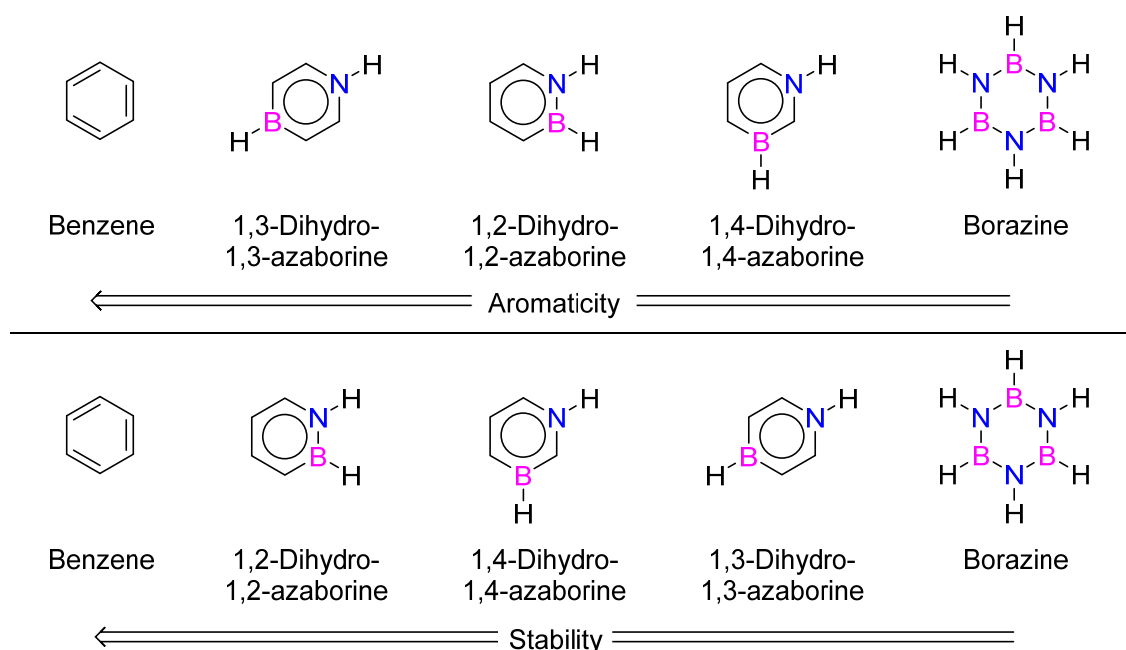


Figure 6. Aromaticity and stability order of azaborines compared to benzene as pure C-C analogue and borazine as pure B-N analogue based on calculation by Baranac-Stojanovic.⁵¹

In addition to the stability, the azaborine is highly sensitive towards water if the boron site is halogenated, but it is hydrolytically stable, if it is alkylated, alkoxyated, protonated or is bearing a phenyl group. However, the stability towards oxygen is a different matter. Various azaborines are slightly sensitive to oxygen, but only for azaborines carrying alkyl groups on the boron strong decomposition is discernible.⁵²

Azaborine, benzene and borazine are not only different in terms of stability but also with regard to their optical properties. The strongest absorption band in the UV/Vis spectrum of benzene is at 208 nm ($\epsilon = 12380 \text{ M}^{-1}\text{cm}^{-1}$) accompanied by a low α band at 255 nm ($\epsilon = 977 \text{ M}^{-1}\text{cm}^{-1}$). In contrast, the absorption spectrum of 1,2-dihydro-1,2-azaborine reveals a much stronger absorbance in this range at 269 nm ($\epsilon = 15632 \text{ M}^{-1}\text{cm}^{-1}$). Furthermore, the azaborine has two further strong absorption bands at 205 nm ($\epsilon = 7459 \text{ M}^{-1}\text{cm}^{-1}$) and 219 nm ($\epsilon = 8495 \text{ M}^{-1}\text{cm}^{-1}$). Compared to benzene and azaborine, the absorption spectrum of borazine shows only a weak band at 203 nm ($\epsilon = 1299 \text{ M}^{-1}\text{cm}^{-1}$) and further very weak absorption in the range around 250 nm. Generally, the azaborine has a broader absorption spectrum than benzene and borazine (**Figure 7**).⁵³ Correspondingly, 1,2-azaborine has a HOMO-LUMO band gap (E_g) lowered by 1.3 eV compared to benzene, which makes this molecule pattern particularly interesting as electron acceptor with regard to optical applications.^{53,54}

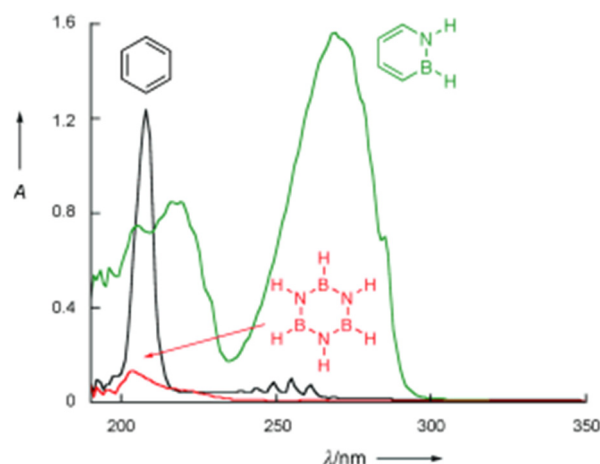


Figure 7. UV/Vis absorption spectra of 1,2-dihydro-1,2-azaborine, benzene, and borazine. All substrates were diluted to 10^{-4} M in pentane; reprinted with permission from Marwitz, A. J. V.; Matus, M. H.; Zakharov, L. N.; Dixon, D. A.; Liu, S. Y. *Angew. Chem. Int. Ed.* **2009**, *48*, 973. © 2009 John Wiley & Sons.

2.4 Azaborine Polymers

Available polymers containing 1,2-azaborine units, are rather rare. They can be classified into conjugated polymers and non-conjugated polymers with the azaborine unit in the side chain.

2.4.1 Conjugated 1,2-Azaborine Containing Polymers

To this day, there has only one conjugated 1,2-azaborine-containing polymer been reported in literature by Baggett et al.⁵⁵ (**Figure 8**). The investigation of this polymer and the comparison to monomer and oligomer units ($n = 2, 3$) showed a dramatic bathochromic shift of the lowest-energy absorption band as the backbone is enlarged – from 277 nm ($n = 1$) to 334 nm ($n = 2$) to 383 nm ($n = 3$) to 462 nm (polymer with $n = \sim 16$). The E_g of the polymer could not be determined but the oligomer with three repeat units already possessed a low E_g of 2.91 eV. Additional calculations revealed a better conjugation with increasing number of repeat units compared to the C-C analogue (poly[*p*-phenylene]). These results were rationalised by a coplanar arrangement which was favoured due to the N-H $\cdots\pi$ interactions. In addition, the small contributions of N and B to the frontier orbitals rather lead to a similarity to poly(cyclohexadiene) and *trans-cisoid* poly(acetylene).⁵⁶

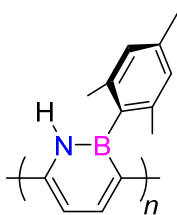


Figure 8. The only 1,2-azaborine unit containing conjugated polymer so far published by Baggett et al.⁵⁶

2.4.2 Non-Conjugated 1,2-Azaborine Containing Polymers

Non-conjugated 1,2-azaborine containing polymers are also rare. The first two examples were published in 2016 just before the results in this thesis (see **Chapter 3.3**) and the thesis itself were submitted. Wan et al. synthesised a poly(1,2-azaborine) in which the nitrogen atom has only a hydrogen substituent.³² The molecular weights they obtained by free radical polymerisation were $M_w = 6.7$ kDa (for RAFT: $M_w = 1.1$ kDa). The polymer was markedly more difficult to polymerise than PS. The second azaborine polymer, which was reported, was a PS with an 1,2-azaborine moiety in *para* position and, not surprisingly, the polymerisation led to a high molecular weight polymer (FRP: $M_w = 88.2$ kDa; RAFT: $M_w = 3.2$ kDa) (**Figure 9**). Both polymers showed neither an evidence for branching nor crosslinking, which was a phenomenon reported for the completely inorganic analogue, poly(vinylborazine).⁵⁷

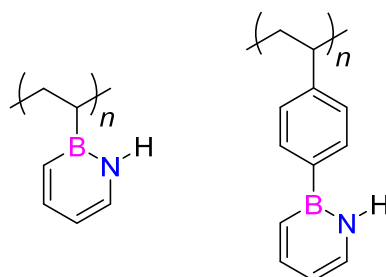


Figure 9. First published non-conjugated olefinic 1,2-azaborine containing polymers by Wan et al.³²; left: a poly(*N*-hydro-*B*-vinylazaborine), right: a poly(styrene) with *p*-azaborinyl moiety.

Beside the polymerisation behaviour of poly(2-vinylazaborine), which is significantly different from PS, this novel polymer showed further different properties. In the UV/Vis spectra, the absorption maximum of poly(*N*-hydro-*B*-vinylazaborine) was bathochromically shifted to 277 nm compared to PS (261 nm) and had a much higher extinction coefficient ($6720 \text{ M}^{-1}\text{cm}^{-1}$; PS = $311 \text{ cm}^{-1}\text{M}^{-1}$). Furthermore, the polymers showed a clear trend for the T_g : Poly(*N*-hydro-

B-vinylazaborine) ($T_g = 93\text{ }^\circ\text{C}$; $M_n = 1.1\text{ kDa}$) had a much higher T_g than poly(styrene) ($T_g = 55\text{-}60\text{ }^\circ\text{C}$; $M_n = 2\text{ kDa}$) for the reported molecular weight, which is dramatically influencing the T_g under 20 kDa.^{28,29,58} The poly(*p*-azaborinylstyrene) reached a 42 K higher T_g (180 °C) than the corresponding C-C analogue, poly(4-vinylbiphenyl). Wan et al. suggested that the presence of *N*-H groups might result in hydrogen bonding interactions, which also make these polymers soluble in water or alcohols.

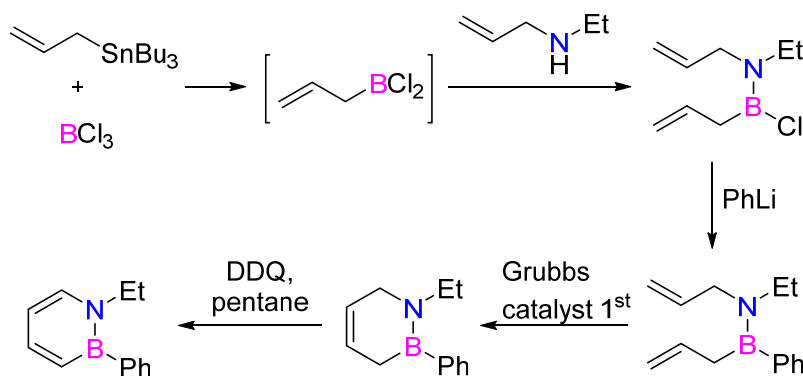
Whether the trend in thermal behaviour and the difficulty in polymerisation of poly(vinylazaborines) are universally true, will be discussed on the basis of a new poly(vinylazaborine) within the results of this thesis (**Chapter 3.3**).

These few numbers of this polymer type which were just recently published on the one hand show the high novelty, on the other hand they demonstrate the lack of knowledge in this research field.

To extend the amount of poly(vinylazaborine)s and therefore the portfolio of potentially applicable plastics, a much higher variety by the synthesis of additional monomers has to be developed.

2.5 Common Synthetic Routes to 1,2-Dihydro-1,2-Azaborines

The 1,2-azaborine is the only one of all three azaborines which contains a B-N bond. Although Dewar and Marr in 1962,⁵⁹ White⁶⁰ in 1963 and Wille and Goubeau⁶¹ in 1972 could synthesise 1,2-azaborines, they did not find a general method with easy access to these molecules. It was to be about 28 years and the discovery of the ring-closing metathesis until Ashe et al. published a synthetic route to 1,2-azaborines under very mild conditions.⁶² Since this breakthrough, research on this molecule dramatically increased and it is therefore the most investigated azaborine.⁴⁸ For this revolutionary synthetic route, Ashe used allyltributyltin and boron trichloride to form allylboron dichloride which further reacted with the allylamine species to yield a diallylic aminoborane. The reactive boron chloride bond was used to introduce a phenyl group on the boron site. The last but crucial steps included a ring closing metathesis with subsequent aromatisation with the oxidation reagent 2,3-dichloro-5,6-dicyano-1,4-benzoquinone (DDQ) (**Scheme 6**).

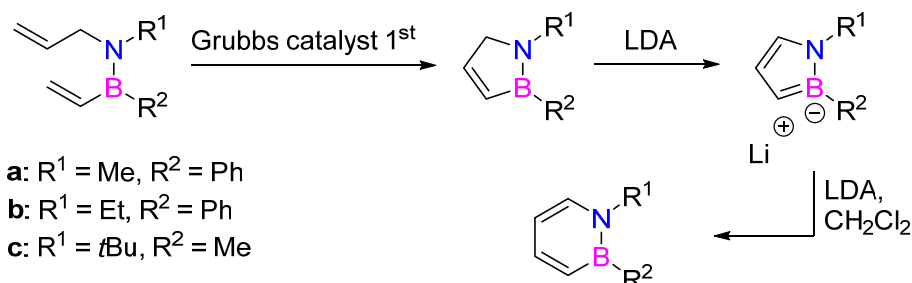


Scheme 6. Revolutionary synthetic route to 1,2-azaborine via ring closing metathesis by Ashe and Fang in 2000.⁶²

Beside the first published route by Ashe, he and his coworkers also presented an alternative route by ring-expansion, where allylamines are also necessary. However, this route is not applicable to species bearing a proton neither on the boron nor on the nitrogen (**Scheme 7**).⁶³

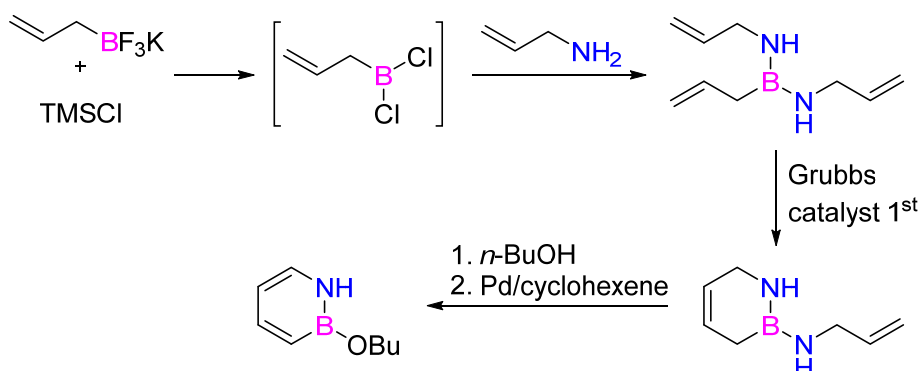
Both synthetic routes by Ashe are highly sensitive to oxygen or moisture depending on the stage of the reaction sequence and substituents on the boron. Therefore, suitable equipment for working under inert conditions is essential. Even the aromatic azaborine is not absolutely stable under normal atmospheric conditions as described in **Chapter 2.3**.

The reactive boron chloride bond (see **Scheme 6**) offers a possibility for a broad range of differently substituted azaborines. Here, the chloride substitution is also feasible after aromatisation and consequently reduces time and costs for the synthesis of different systems.⁶⁴ To adjust the azaborine on the nitrogen site after aromatisation, protecting group chemistry has to be applied.⁵³ A synthetically simpler strategy is to consider the nitrogen substituent in the beginning of the synthetic route.



Scheme 7. Alternative route to 1,2-azaborines by Ashe and coworkers.⁶³

For a protecting-group-free access to an *N*-H-functionalised 1,2-azaborine, Abbey et al. published a synthetic route which started from potassium trifluoroborate, which served as reagent for an in situ generation of allylboron dichloride.⁶⁵ Addition of allylamine led to a twice allylamine-substituted allyborane. A ring-closing metathesis followed by a reaction with *n*-BuOH and a subsequent oxidation with palladium/cyclohexene resulted in a *N*-H-functionalised 1,2-azaborine. From this compound, different N-substitutions or B-substitutions are feasible according to Abbey et al. (**Scheme 8**).⁶⁵

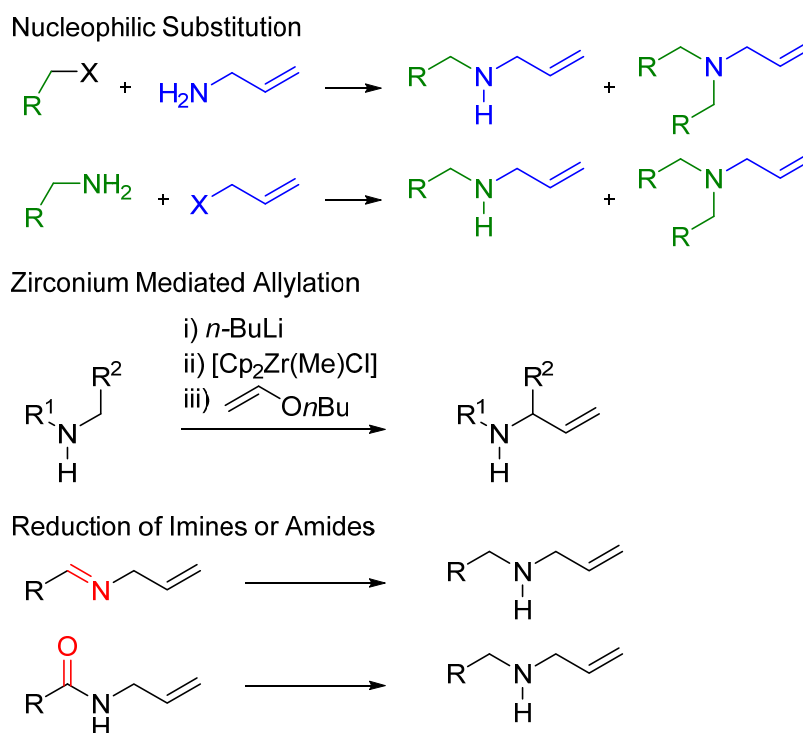


Scheme 8. Protecting group free synthesis to a *N*-H-functionalised 1,2-azaborine by Abbey et al.⁶⁵

2.5.1 Synthesis of Secondary Allylamines

As the nitrogen component within the azaborine synthesis plays a decisive part in the final substitution pattern, its making is of certain significance. There are different methods to obtain the necessary secondary allylamines. The synthetically easiest route is the allylation of primary amines or the substitution of allylamines. Here, the prevention of over-alkylation to tertiary allylamines is the main challenge.⁶⁶ A very recent and noteworthy method is the introduction of allylamines by a zirconium mediated coupling reaction between amines and enol ethers. This route is very efficient, but the zirconium reagent is not commercially available.⁶⁷ In contrast, a quite established route to secondary amines is the reduction of imines or iminium salts.⁶⁸⁻⁷¹ However, the poor stability of many imines or imine salts towards hydrolysis and its consequently difficult isolation makes it complicated to handle with. The reduction of much more hydrolytically stable amides by lithium aluminium hydride (LiAlH_4) is therefore the most versatile route to secondary amines and allylamines (**Scheme 9**). However, for absolute purity of secondary allylamines, a carefully adaption of the reaction conditions is needed.

Otherwise, over-reduction can easily take place and will lead to an inseparable by-product (see **Chapter 3.1**).⁷²



Scheme 9. Overview of synthetic routes to secondary allylamines (X = halides);⁷² reprinted with permission from Thiedemann, B.; Schmitz, C. M. L.; Staubitz, A. *J. Org. Chem.* **2014**, 79, 10284. © 2014 American Chemical Society.

3 Results and Discussion

3.1 Accessing Allylamines

Due to the need for allylamines as starting materials for the synthesis of 1,2-azaborines, the reduction of allylamides by LiAlH_4 was applied to open access to different allylamines. Although this method is common for preparing amines from various amides, the use of allylamides led to an unexpected problem: In addition to the amide function, the double bond was reduced, which is entirely unusual for an unactivated nonpolar double bond. As consequence, an in-depth investigation of the cause and mechanism of this issue was performed and published in the *Journal of Organic Chemistry*.

3.1.1 Reduction of *N*-Allylamides

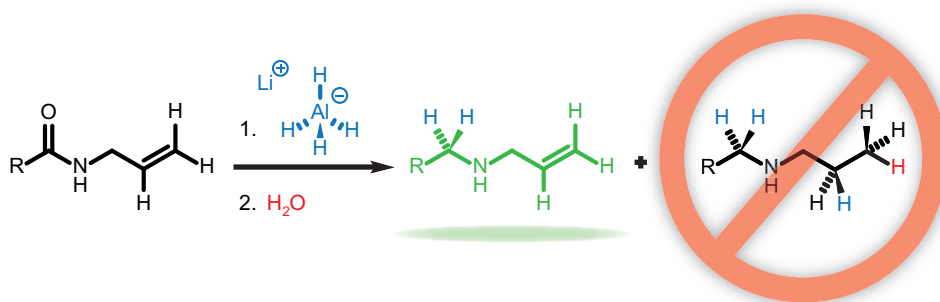
“Reduction of *N*-Allylamides by LiAlH₄: Unexpected Attack of the Double Bond with Mechanistic Studies of Product and By-product Formation”

Thiedemann, B.; Schmitz, C. M. L.; Staubitz, A. *J. Org. Chem.* **2014**, *79*, 10284.

Reprinted with permission from ACS Publications. © 2014 American Chemical Society.

DOI: 10.1021/jo501907v

Abstract: The reduction of secondary allyl amides with LiAlH₄ can lead to a concomitant reduction of the double bond. Previously, an excess of LiAlH₄ in hazardous solvents was used for the reduction. This work discusses optimized reaction conditions in *t*BuOMe as a safe solvent, with only a 1.5 fold excess of LiAlH₄, without reduction of the double bond in most cases. ¹H and ²D NMR spectroscopic studies give evidence for the mechanism of the reduction of the amide as well as the double bond: Amide reduction generally precedes double bond reduction. Sterically hindered allylamides are an exception. They are reduced considerably more slowly at higher temperatures and double bond reduction is observed before amide reduction has gone to completion.



TOC Graphic 1. A mechanistic study and reaction optimisation of the allylamide reduction by LiAlH₄ were performed.

Scientific contribution to this paper

In this project, I carried out all syntheses and experimental work except for the following support by the coauthors: C. M. L. Schmitz worked under my supervision on the synthesis of allylamides **P1-9**, **P1-10**, **P1-17**, **P1-19** and **P1-30** during a lab internship preparatory to her B.Sc. thesis. A. Staubitz synthesised the amides **P1-6**, **P1-11**, **P1-13** and **P1-32** and wrote this article in cooperation with me.

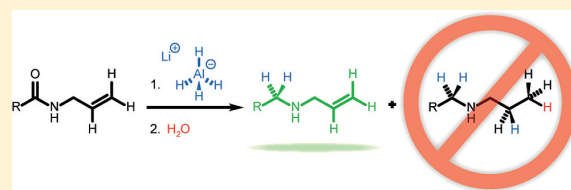
Reduction of *N*-Allylamides by LiAlH₄: Unexpected Attack of the Double Bond with Mechanistic Studies of Product and Byproduct Formation

Birk Thiedemann, Christin M. L. Schmitz, and Anne Staubitz*

Otto-Diels-Institute for Organic Chemistry, University of Kiel, Otto-Hahn-Platz 4, 24098 Kiel, Germany

S Supporting Information

ABSTRACT: The reduction of secondary allyl amides with LiAlH₄ can lead to a concomitant reduction of the double bond. Previously, an excess of LiAlH₄ in hazardous solvents was used for the reduction. This work discusses optimized reaction conditions in *t*BuOMe as a safe solvent, with only a 1.5-fold excess of LiAlH₄, without reduction of the double bond in most cases. ¹H and ²D NMR spectroscopic studies give evidence for the mechanism of the reduction of the amide as well as the double bond: Amide reduction generally precedes double bond reduction. Sterically hindered allylamides are an exception. They are reduced considerably more slowly at higher temperatures, and double bond reduction is observed before amide reduction has gone to completion.



INTRODUCTION

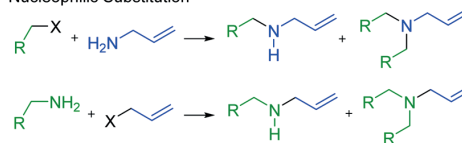
In organic chemistry, the allylamine motif constitutes a highly interesting unit, especially in the pharmaceutical industry. Allylamines are often present in pharmaceuticals including the potent antifungal drugs naftifine,¹ terbinafine,¹ cytosinine,² oryzoxymicine,^{3–5} and gabaculine.^{6–9} In combination with a phosphate unit, as a phosphoramidate, allylamine moieties were investigated as flame retardants in polyurethane foams due to their low volatility, easy synthesis, and low evolution of toxic gases and smoke.¹⁰ Furthermore, allylamines are used in synthesis of indoles¹¹ and various heterocycles^{12–14} or as precursor to important compounds as α - and β -amino acids,^{15–18} alkaloids,^{19,20} carbohydrate derivatives,²¹ and for the synthesis of poly(allylamines) as weak polyelectrolytes.^{22–24}

There are several methods to synthesize allylamines (Scheme 1). For symmetrical tertiary allylamines, AllylNR₂, easy synthetic routes are available for example by allylation of primary^{25,26} or secondary amines.²⁷ In contrast, secondary allylamines represent a major difficulty because of overalkylation to tertiary allylamines.²⁵ Very recent developments are the introduction of allylamine by the Petasis reaction²⁸ or by a zirconium mediated coupling reaction between amines and enol ethers. This method is very efficient, but it relies on bis(cyclopentadienyl)zirconium methyl chloride, which is not commercially available.²⁹ A more commonly used route to secondary allylamines is therefore the reduction of imines or iminium salts.^{30–33}

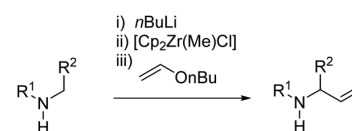
However, many imines and iminium salts are unstable toward hydrolysis, and therefore, these precursors may be difficult to isolate. The reduction of the much more hydrolytically stable amides, which are easily accessible from acyl halides and allylamine, using LiAlH₄ as the reductant is therefore the most versatile route to secondary allylamines (Scheme 1).^{34–36} However, as we demonstrate in this report, the double bond of

Scheme 1. Overview of Synthetic Routes to Secondary Allylamines (X = Halides)

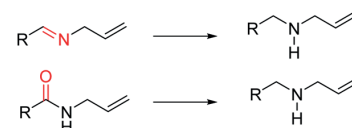
Nucleophilic Substitution



Zirconium Mediated Allylation



Reduction of Imines or Amides



the allylamine can be reduced under some conditions, leading to a *n*-propylamine byproduct which cannot be removed from the product mixture.

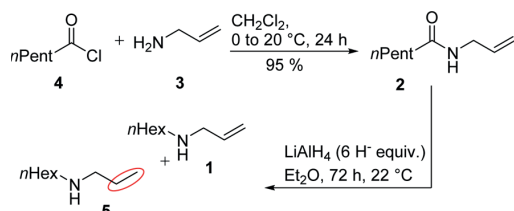
That issue prompted this investigation into the factors contributing to this problem. This study leads to general recommendations for performing that important reaction.

Received: August 18, 2014

Published: October 27, 2014

RESULTS

For our current research program, we required the secondary *N*-allyl-*N*-*n*-hexylamine **1**, which we wished to prepare by simply reducing the easily synthesized amide **2** with LiAlH_4 . The amide **2** was readily accessible from allylamine **3** and *n*-hexanoyl chloride **4** in an excellent yield of 95% (Scheme 2).³⁷

Scheme 2. Syntheses of Allylamine **1** and the Unexpected Byproduct **5**

For the subsequent reduction of the amide functional group, half an equivalent of LiAlH_4 (two hydride equivalents with respect to the functional group) should be sufficient. A literature procedure for the reduction of the very similar *N*-*n*-heptylacetamide, a compound which does not have the additional complication of a double bond present, described the use of 12 hydride equivalents.³⁷ This seemed not only excessive, but also the quenching of the reaction was a major safety concern due to its exothermic nature and release of hydrogen. We therefore opted for using a smaller excess of LiAlH_4 (6 H^- equiv) in Et_2O . After 72 h at 22 °C, we did indeed obtain the secondary allylamine product **1**, but an NMR analysis revealed that it was contaminated with byproduct **5** where the double bond had also been reduced in a ratio of **1**:**5** = 1:2 (Figure 1).

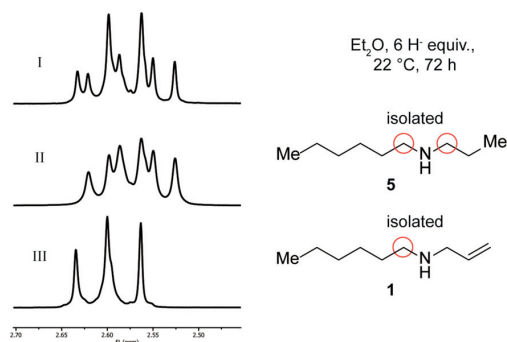


Figure 1. Section of stacked ^1H NMR spectra of crude reaction mixture (I), isolated byproduct **5** (II), and isolated product **1** (III).

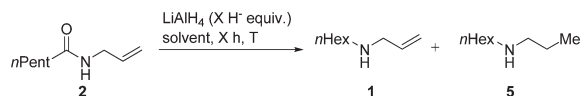
Due to these results, the procedure of Wu et al.³⁸ was used, which employed 16 H^- equivalents on the related *N*-allyl-*S*-phenylpent-4-ynamide, but did not report an attack of the double bond. This large excess of LiAlH_4 in combination with Et_2O as solvent led to a very violent and potentially dangerous quenching procedure even though it was performed by the slow addition of ice cold water with ice cooling the reaction vessel. However, surprisingly, GC analysis showed a better yield of 96% amine **1** accompanied by 1% of hydrogenated byproduct **5** compared to the previously described procedure with six hydride equivalents. This result was unexpected because, intuitively, with more

equivalents of hydride, the potential for reducing the double bond should be increased. These strikingly different results prompted us to investigate the reduction reaction systematically (Table 1).

Our aims were, first, to find reaction conditions that give the product **1** in high yields without over-reduction to product **5**. Second, the amount of LiAlH_4 should be minimized, both for atom and financial economy, as well as for safety reasons. Third, the solvent used should in the ideal case be safe, with a high boiling point and no danger of peroxide formation, because the production of secondary allylamines is of high importance in industry. Lastly, we decided to investigate the mechanism of the reaction and the behavior of other allylamides to be able to draw general conclusions for conducting allylamide reductions. For this, all reductions were carried out on a 20 mmol scale and a concentration of 0.33 mol/L in *t*BuOMe. As over-reduction could potentially happen during the exothermic first reduction step, we investigated cooling during addition of amide **2** to 0 °C (Table 1, entries 1, 2, 3). However, this led to similar results compared to the reaction carried out without cooling; the yield of **1** and **5** was 96% and 1%, respectively. To achieve the first aim of the optimization, to reduce the amount of LiAlH_4 , reactions with the theoretical minimum amount of LiAlH_4 (2 H^- equiv), at 22 °C, were performed in the solvents (*t*BuOMe, THF, and Me-THF).⁴⁰ All of these solvents have a higher boiling point than diethyl ether, although THF and Me-THF both can form peroxides and are not ideal from a safety perspective. In all of these cases, GC analysis showed that the conversion stopped at approximately 40% (Table 1, entries 6, 7, 8) with no formation of the byproduct **5**. Even reactions at higher temperatures of 35 and 55 °C in *t*BuOMe showed no significant difference (Table 1, entries 9, 10) with a product yield of ca. 40%, but no over-reduced byproduct. Because of this surprising result, the amount of LiAlH_4 was raised to three H^- equivalents. For both *t*BuOMe and Me-THF as solvents after 24 h at 22 °C, good yields of product **1** of 89% and 76%, respectively, were found, without significant amount of hydrogenated byproduct **5** (1% and no detectable amounts, respectively). However, the same reaction in THF showed almost no conversion, giving only 8% of the product (Table 1, entry 14). Because the type of solvent was clearly important, we reintroduced Et_2O to our comparative studies. In comparison to *t*BuOMe as solvent, Et_2O showed a similar yield (Table 1, entries 11, 12) of 91%, with ca. 1% of over-reduced product **5**. The increase in temperature (35 °C) reduced the reaction time to 4 h with similar yields as those obtained at 22 °C of 82%, 87%, and 83%, respectively, except for THF (8%). In none of these was byproduct **5** detected (Table 1, entries 15–18).

Longer reaction times, however, led to a marked increase of the amount of **5** up to 15% (Table 1 in the Supporting Information; entries 4–6, 12–15, 21, 24). The tendency to faster reaction times at higher temperatures was confirmed by obtaining similar yields (82% to 87%) at 55 °C with half the reaction times compared to reactions at 35 °C, because the higher thermal energy allowed a faster hydride transfer. Even in THF, the reduction at 55 °C reached a similar yield of 78%. That THF is only a good solvent at higher temperatures can be explained by the lower solubility of LiAlH_4 in this solvent (compared to Et_2O)⁴¹ and the type of solvation (contact ion pairs or separated ion pairs).⁴²

In order to understand the formation of the hydrogenated byproducts, there were several questions to address: First, does the attack of the double bond by hydride happen before or during

Table 1. Optimization of the Reaction Conditions for Reduction of *n*-Hexylallylamide (2) by Adapting Solvent, Temperature, and LiAlH₄ (H⁻ equiv), and Monitoring the Reaction Time³⁹

entry	solvent	LiAlH ₄ (H ⁻ equiv)	T (°C)	time (h)	2 ^a (%)	1 ^a (%)	5 ^a (%)
1	Et ₂ O	16	0 °C → 22 °C ^b	12	22	77	0
2	Et ₂ O	16	0 °C → 22 °C ^c	12	3	96	1
3	Et ₂ O	16	22 °C	12	3	96	1
4	Et ₂ O	6	22 °C	4 (24)	9 (3)	90 (80)	1 (15)
5	Et ₂ O	6	35 °C	1 (2)	15 (6)	82 (86)	0 (3)
6	<i>t</i> BuOMe	2	22	24	50	40	0
7	THF	2	22	24	58	37	0
8	Me-THF	2	22	24	52	26	0
9	<i>t</i> BuOMe	2	35	24	49	44	0
10	<i>t</i> BuOMe	2	55	24	49	39	0
11	Et ₂ O	3	22	24	7	91	1
12	<i>t</i> BuOMe	3	22	24	9	89	1
13	THF	3	22	24	92	8	0
14	Me-THF	3	22	24	14	76	0
15	Et ₂ O	3	35	4	16	82	0
16	<i>t</i> BuOMe	3	35	4	12	87	0
17	THF	3	35	4	92	8	0
18	Me-THF	3	35	4	13	83	0
19	<i>t</i> BuOMe	3	55	2	9	84	0
20	THF	3	55	2	11	78	0
21	Me-THF	3	55	2	3	87	1

^aYields measured by GC using 1,3,5-triisopropylbenzene as an internal standard. ^bIce bath slowly warmed up. ^cIce bath removed after amide addition.

quenching reaction? Second, does the hydride attack the double bond selectively on one carbon or does it attack randomly both double bond positions? Third, if the hydride attacks selectively, which position of the double bond is attacked and does this allow drawing conclusions as to the geometry of the substrate–lithium aluminum hydride complex or the partially oxidized aluminum hydride species respectively?

To investigate the reaction mechanism the reduction process was monitored by No-D ¹H NMR spectroscopy. For this purpose, we used *N*-allylbenzamide 6 as starting material because this compound has fewer alkyl proton signals than 2 and its products, which was expected to simplify the analysis. For the reduction of the amide 6, we had detected 14% of over-reduced byproduct 7 after 2 days. As reducing agents, LiAlH₄ (Figure 2a) as well as LiAlD₄ (Figure 2b) were used, and for quenching both H₂O and D₂O were employed.

Immediately after the addition of LiAlH₄ to 6, which proceeds with a marked exotherm, a substantial shift of the protons of the allyl group was observed: Both doublets of doublet of triplets for the protons H1a and H2a were shifted upfield from 5.69 to 5.59 ppm and 5.57 to 5.53 ppm, respectively, whereas the apparent triplet for the allylic methylene group at 4.53 ppm shifted to 4.29 ppm. All peaks became broader and less well-defined. After about 47 min, the signal intensity for the starting material started to decrease, and gradually a new set of signals at 5.46, 5.44, and 4.46 ppm appeared. This was fully developed after 19 h 21 min and corresponds most likely to metal complex of amine 8, which releases the amine 8 after quenching with water (Figure 2).

These signal assignments were further supported by conducting the experiment with LiAlD₄ as the reducing agent (Figure 2b). The methylene proton signals H4 of the product 8

did not appear at all (4.55 and 4.46 ppm), indicating deuteration at this position (Figure 2b). In the reduction with LiAlH₄, aside from the signals for the product 8, after 1 d 21 h a further signal at 4.62 ppm appeared. Although this singlet signal can be ascribed to benzylic protons of Ph–CH₂–N (Figure 2, red circle), its shift reveals that it belongs to the prequenching species (i.e., the metal complex) of byproduct 7. This assignment was further supported by newly emerged alkyl signals at 3.07, 2.30, and 0.54 ppm which are indicative of the propyl chain of 7 (Figures S9 and 60, Supporting Information).

To gain further insight in the position of the aluminum hydride complex during attack on the double bond, we quenched the reaction once with H₂O and once with D₂O. ¹H NMR analysis showed different byproducts for each approach. First, reducing the amide 6 by LiAlH₄ and quenching with H₂O led to product 8 (with the significant signals at 5.93, 5.20, 5.11, and 3.28 ppm, for the allyl moiety) accompanied by a triplet at 2.54 ppm, a triplet of quartet at 1.50 ppm, and a triplet at 0.85 ppm for the byproduct 7 (Figure 3a). By choosing LiAlD₄ as reductant and quenching by H₂O, we obtained a doublet at 2.54 ppm for the α proton, a signal for the β proton with reduced intensity, and also a doublet signal for the γ proton. This result supports the selective hydride attack in the β position (Figure 3b). For the identification of the origin of the proton of the reduced double bond in the *n*-propylamide byproduct, we chose LiAlH₄ as reductant in a further experiment and quenched it with D₂O. In the corresponding ¹H NMR spectrum, the triplet signal at 2.54 ppm, the quartet of doublet signal at 1.48 ppm, and the intensity reduced triplet signal at 0.85 ppm indicated the presence of a deuterium atom at γ position (Figure 3c). This assignment was further supported by the ¹H

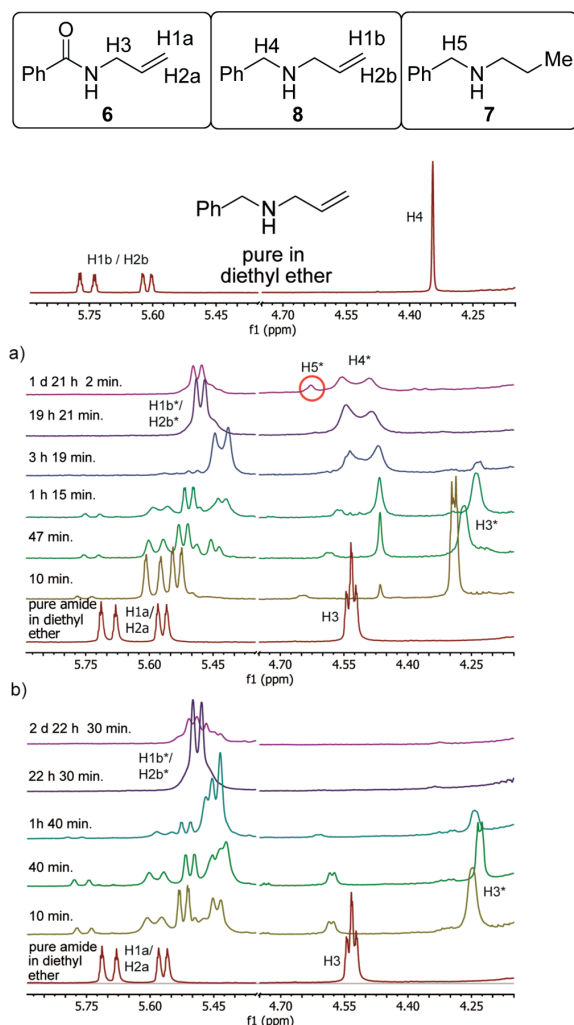


Figure 2. Section of No-D ^1H NMR spectra for the sequence of the reduction of *N*-allylbenzamide (**6**) by LiAlH_4 (a) and by LiAlD_4 (b) in Et_2O . Only a selection of spectra is displayed. For the fully recorded sequence see Supporting Information.

NMR of the approach with LiAlD_4 as reductant and D_2O as quenching reagent (Figure 3d).

It was then important to elucidate if other secondary amides would behave similarly under the same conditions. For this purpose, a range of amides were prepared from the corresponding acid chlorides and allylamine in excellent yields or in one case from ethyl formate and allylamine. All amides were subjected to the optimized reaction conditions for the reduction of *N*-allyl-*N*-*n*-hexylamide **2**, using three hydride equivalents in *t*BuOMe as a solvent at 35°C , while the reaction was monitored by GC analysis (Table 2).

First, as a comparison to the amide **2** (Table 2, entry 1), where the corresponding amine **1** was isolated in a yield of 69%, we tested the reaction conditions with a longer (Table 2, entry 2) and shorter (Table 2, entry 3) alkyl chain moiety. Both starting materials **9** and **10** were reduced in similar yields (65–68%) in a reaction time of 4 h, without any observation of the over-reduced byproduct. For volatile amines, high yields could only be

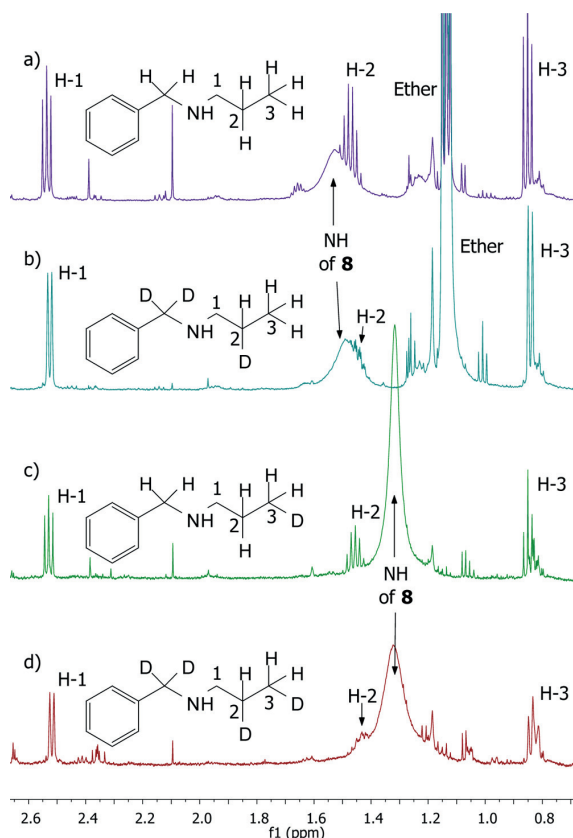


Figure 3. Stacked section of ^1H NMR spectra of the deuteration experiments zoomed in for clearly visible byproduct signals. The spectra were obtained from mixtures and contained residual solvent (Et_2O): (a) 1. LiAlH_4 , 2. H_2O ; (b) 1. LiAlD_4 , 2. H_2O ; (c) 1. LiAlH_4 , 2. D_2O ; (d) LiAlD_4 , 2. D_2O .

obtained by transforming them to the hydrochloride before removing the solvent. The formyl allylamine **11** reacted much faster with full conversion after 1 h. Although no reduction of the double bond was observed, an entirely unexpected new byproduct emerged: 22% of allylamine hydrochloride **12** was unequivocally identified (Table 2, entry 4). To the best of our knowledge, this is the first carbon–nitrogen cleavage reaction as side reaction in a reduction of an amide by LiAlH_4 .^{43,44}

To investigate more sterically hindered amides, isobutyramide **13** was reduced, which gave a slightly lower yield of 58% of amine **14** than the linear alkylated amines (Table 2, entry 5). However, when the steric hindrance was only slightly increased further to butyl-2-ethyl-, ^1H NMR and GC analysis showed no allylamine **15** after 6 h at 35°C . If the reduction was heated to 55°C , we obtained 25% of amine **15** after 2 h (Table 2, entry 6). The mesitylallylamine **16** with a similar bulky residue compared to butyl-2-ethylamine **17** revealed the same behavior with no conversion after 4 h at 35°C . But even additional heating of 2 h at 55°C failed to yield any of the amine **18**.

The similarly bulky but less flexible cyclohexyl moiety on the other hand led to a much higher isolated yield of 79% in respect to the linear alkylated amides (Table 2, entry 8). This high yield decreased to 65%, if the cyclohexyl ring was replaced by a flat aromatic ring as amide substituent (Table 2, entry 9). A CH_2 group as spacer between phenyl and amide functional group

Table 2. Overview of Several Synthesized Amides and Their Corresponding Amines by Optimized Reduction Conditions

Entry	Amide	Amine	Time	Yield
1			4 h	69 %
2			4 h	65 %
3			4 h	68 %
4		 +	1 h: 100 % conversion 29 / 12 = 78 / 22	
5			4 h	58 %
6			6 h + 2 h at 55 °C	0 % 25 %
7			6 h + 2 h at 55 °C	0 % 0 %
8			4 h	79 %
9			4 h	65 %
10		 	4 h + 2 h at 55 °C	0 % 26 % (20) 8 % (21)
11		 	After 2 h: Both DB attacked; Several not assignable signals.	

which allows more torsional flexibility for this substituent led to a poorer reduction. However, in this case, the limited solubility of the amide **19** forced us to add the amide as suspension, which could have artificially reduced the yield. After 6 h, ^1H NMR spectroscopy of the crude mixture showed only 26% allylamine byproduct **21** (Table 2, entry 10).

To expand the range of allylamides, we also investigated a α,β -unsaturated compound (Table 2, entry 11). After 2 h, all starting material was converted, but a large amount of the α,β -double bond had also been attacked. 45 ^1H NMR indicated the presence of product **22** and about 50% of butylallylamine **23** as byproduct.

DISCUSSION

Although the reduction of amides by LiAlH_4 in general is a relatively common reaction, very little research effort has been dedicated to elucidating its mechanism. 46,47

Reduction of the Amide. For reductions of carbonyl functional groups by LiAlH_4 , a reasonable assumption is the

coordination of the Lewis acidic Li^+ ion to the oxygen atom of the carbonyl functional group (Scheme 3, A).

This assumption is supported by the immediately observed exotherm of the reaction straight after the addition of LiAlH_4 to the solution of the amide. This exotherm cannot be the result of the reduction reaction itself: This happens on a much slower time scale as was clearly proved by the NMR experiments. The addition of LiAlH_4 only shifted the signals of the allyl protons and only after ca. 40–50 min new sets of signals started to appear. By the help of the deuteration studies, the hydrides or deuterides which were transferred to the carbonyl group were clearly identified. Further support of the hypothesis that coordination by Li^+ is a vital step in the reaction includes the observations of the reactions with sterically hindered carbonyl compounds. In extreme cases, we obtained only starting material after quenching under the same reaction conditions as for unhindered allylamides (Table 2, entries 6, 7). For the 2-ethyl-butyl moiety, heating up to 55 °C for 2 h led to a reduction reaction of 37% (Table 2, entry 6). We purport that the flexible steric residues only allow the

Scheme 3. Proposed Mechanism Based on the Results of the Mechanistic Study

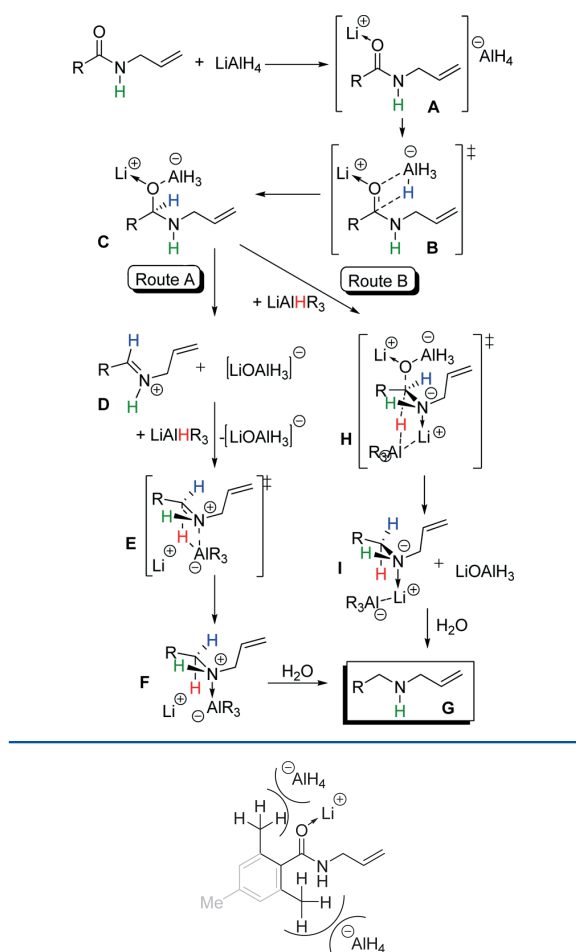


Figure 4. Prevention of the reduction by steric repulsion between bulky moieties and aluminum hydride anions.

coordination of the Li^+ on the less hindered side of the allylamide residue. It thereby prevents the approach of the AlH_4^- ion to the carbonyl center (Figure 4).

Once the lithium cation has coordinated to the oxygen and leads to an even more polarized carbonyl group, the aluminum hydride ion could transfer a hydride to the carbonyl carbon atom via a four membered ring intermediate (B). Originating from the hemiaminal species formed (C), where the lithium aluminum hydride ion pair is coordinated or bonded to the oxygen, we can consider two possible routes.

Route A presupposes that the hemiaminal compound (C) is unstable and decomposes to the corresponding iminium ion by elimination (D). Then, a second aluminum hydride species transfers the hydride to the iminium double bond via a four membered ring intermediate (hydroalumination) (E). The aminoaluminate (F) which is then formed can be quenched by water to give the secondary allylamine as product (G).

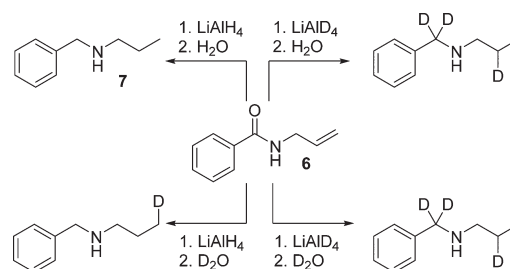
Route B assumes that the hemiaminal compound (C) is stable and a second lithium aluminum compound can coordinate to the nitrogen and then transfer a hydride to the double bond via a five membered ring intermediate (H). The lithiated aluminum oxide

compound serves as leaving group. For the coordination of the second reducing reagent to the nitrogen, it is likely that the lithium cation plays a crucial role in coordinating directly to the nitrogen and bringing the aluminum hydride into close proximity. By quenching the complexed amine species (I) with water, the secondary allylamine (G) will then also be obtained (Scheme 3). Route A appears less likely, because no signal could be identified that would correspond to a proton of a $\text{N}=\text{C}-\text{H}$ group which would have a chemical shift similar to aldehyde protons.⁴⁸ Moreover, such a species would also be comparatively unhindered and should be easily reduced, even in sterically crowded cases. However, such amides were very resistant to reduction, and double bond reduction was an earlier side reaction (for a discussion see below).

The first reduction step of the polarized carbonyl group is no doubt faster than the second one as was shown by the No-D ^1H NMR spectroscopic measurements of the reduction of 6 (Figure 2). It can clearly be seen that this step has gone to completion before 3 h 19 min. It is then the second reduction step that is rate limiting. This is also a possible explanation for why the reaction comes to a halt if only two equivalents of hydride are used: The $\text{LiAlH}_x\text{OR}_y$ species which are formed in the reaction should have a decreasing reducing power with decreased hydride content, due to the electron withdrawing effects of the oxygen substituents. Therefore, not only is the amide more susceptible to reduction, but also it is more likely to be reduced by a more powerful reductant than are species C or D.

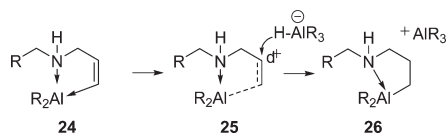
Reduction of the Allylic Double Bond. ^1H NMR spectra (Figure 1) and GC analysis (Figures 49–53 Supporting Information) show clearly that the allylic double bond in the allyl amide 2 was attacked by LiAlH_4 (or a related species, AlH_xR_y^- with $x + y = 4$) during the reduction to give amine 1. However, this problem could not be overcome by reducing the amount of LiAlH_4 to the formally required two hydrogen equivalents, because the reduction of the amide comes to a halt (see above).

The hydride attack on the allylic double bond by the aluminum species was investigated with No-D NMR sequences of the reduction of allylbenzamide 6 (Figure 2) and several deuteration experiments (Scheme 4).

Scheme 4. Overview of Deuteration Results with Reactions Carried out in Et_2O at 22 °C

After a reaction time of about 3 h, when the first reduction step is complete, a downfield shift of the terminal allylic proton signal and the presence of a second similarly shifted signal (Figure 2a, H_4^*) appeared. This could indicate the coordination of the lithium aluminum hydride species to the double bond (24, Scheme 5). At this stage, no double bond reduction takes place, presumably because the reduction of the hemiaminal species is faster. However, this shift indicates already that the double bond

Scheme 5. Possible Mechanism of the Allylic Double Bond Attack



is capable of an interaction with the reductant. Such a coordination may lead to a polarization of the double bond and enable a second lithium aluminum species to transfer a hydride to the allylic β -position (25, Scheme 5). This double bond coordination was confirmed by deuteration experiments, which clearly demonstrated the selective hydride transfer to the allylic β carbon as well as continuance of the lithium aluminum species on γ position (26, Scheme 5). The high regioselectivity suggests that the reaction proceeds via a five membered ring as an intermediate. That this hydride transfer happened *in situ* before quenching the reaction was confirmed by proton signals at 4.62 ppm accompanied by the signals at 3.07, 2.30, and 0.54 ppm belonging to the propyl chain (Figures S9 and S60 Supporting Information).

In the case of sterically hindered amides, however, species H (Scheme 3) may be formed only with difficulty if the substituent R on the hemiaminal species is large. In this case, it is conceivable that hydrogen transfer to the double bond, which is comparatively unhindered, could proceed with a higher rate constant than the second reduction.

CONCLUSION

In the reduction of allylamides, LiAlH_4 can also reduce the double bond of the allyl group. Consequently, a mixture of inseparable products (allylamines and *n*-propylamines) may be obtained. An analysis of the reaction parameters solvent, temperature, and added hydride⁻ equivalents was performed with a view of finding safe and generally applicable reaction conditions. From these investigations, *t*BuOMe emerged as the best solvent, at a slightly elevated reaction temperature of 35 °C. Contrary to previous reports, only three hydride equivalents are required. Under those conditions, byproduct formation can be entirely suppressed. Mechanistic NMR studies and deuteration experiments revealed that, in the unhindered case, the allylic double bond attack occurred as a sequential reaction *after* product formation and at a much slower reaction rate compared to the amide reduction.

However, if the amide is sterically hindered in the α -position, the temperature will have to be increased to reflux, and longer reaction times will be required. In such cases, concomitant reduction of the allylic double bond may be observed.

In summary, the reduction of allylamides with LiAlH_4 is a very useful method, but great care has to be taken to analyze the reaction carefully for the occurrence of over-reduced byproducts, which may be very easy to overlook.

EXPERIMENTAL SECTION

All reagents used were commercially available and used without further purification. For their purities see the Supporting Information. All solvents that were used in reactions were dried prior to use. For exact drying procedures see Supporting Information.

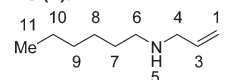
All syntheses were carried out using standard Schlenk techniques or in a glovebox under a dry and inert nitrogen atmosphere. Glassware and NMR tubes were dried in an oven at 200 °C for at least 2 h before use. Reaction vessels were heated under vacuum and purged with nitrogen

three times before adding reagents. The container with LiAlH_4 was opened in the glovebox. For all reductions with LiAlH_4 or LiAlD_4 , the entire reaction apparatus was assembled in the glovebox. The reaction vessels were charged with LiAlH_4 or LiAlD_4 in the glovebox and were then brought out of the glovebox and attached to the Schlenk line under vigorous exclusion of air and moisture.

All NMR spectra were recorded on a 500 or 600 MHz spectrometer (with respect to the proton resonance). ^1H NMR and ^{13}C NMR spectra were referenced against the solvent residual proton signals (^1H) or the solvent itself (^{13}C).

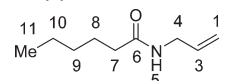
The exact assignment of the peaks was proved by ^1H , ^{13}C DEPT and two-dimensional NMR spectroscopy such as ^1H COSY, ^{13}C HSQC, or $^1\text{H}/^{13}\text{C}$ HMBC when possible.

N-Allylhexanamine (1).⁴⁹

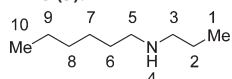


This compound has also been synthesized by Yadav et al. using a different method.⁴⁹ To a suspension of LiAlH_4 (656 mg, 15.1 mmol) in dry *t*-BuOMe (60 mL) in a Schlenk flask under a nitrogen atmosphere was added *N*-allylhexanamide (3.129 g, 20.20 mmol) via a syringe. The addition was continued while the reaction mixture started to reflux. The overall addition time was 3 min. The suspension was heated and stirred at 35 °C oil bath temperature for 4 h and quenched by adding H_2O (5 mL) while cooling the mixture (ice bath). The resulting suspension was dried over MgSO_4 and filtered. The filter cake was washed with Et_2O (120 mL). Evaporation of solvent on a rotary evaporator and subsequent Kugelrohr distillation (70 °C; 10 mbar) yielded in 1.960 g (13.9 mmol; 69%) isolated product as colorless oil. ^1H NMR (500 MHz, CDCl_3) δ = 5.91 (1 H, ddt, J = 17.1, 10.2, 6.0 Hz, 3-H), 5.16 (1 H, ddt, J = 17.1, 1.7, 1.6 Hz, 1-H), 5.08 (1 H, ddt, J = 10.2, 1.7, 1.3 Hz, 2-H), 3.25 (2 H, ddd, J = 6.0, 1.6, 1.3 Hz, 4-H), 2.60 (2 H, t, J = 7.3, 7.3 Hz, 6-H), 1.48 (2 H, m, 7-H), 1.30 (6 H, m, 8-H, 9-H, 10-H), 1.10 (1 H, s, 5-H), 0.88 (3 H, t, J = 7.0 Hz, 11-H) ppm. ^{13}C NMR (126 MHz, CDCl_3) δ = 137.2 (C-1), 115.8 (C-2), 52.7 (C-4), 49.7 (C-6), 32.0 (C-8/9/10), 30.3 (C-7), 27.2 (C-8/9/10), 22.8 (C-8/9/10), 14.2 (C-11) ppm. IR (ATR): 2957 (m), 2925 (s), 2872 (m), 2857 (m), 2810 (m), 1456 (m), 1124 (m), 993 (m), 915 (s), 724 (m) cm^{-1} . HRMS (EI-TOF) m/z : $[\text{M}]^+$ calcd for $\text{C}_9\text{H}_{19}\text{N}_1$ 141.1518; found 141.1512.

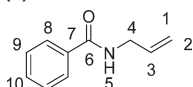
N-Allylhexanamide (2).⁵⁰



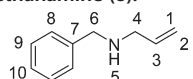
This compound has also been synthesized by Cadierno et al. using a different method.⁵⁰ In a dried flask, a solution of allylamine (3) (20.0 mL, 267 mmol) and triethylamine (50.0 mL, 270 mmol) in CH_2Cl_2 (250 mL) was cooled in an ice bath (<0 °C). Hexanoyl chloride (4) (37.0 mL, 265 mmol) was gradually added over the course of 10 min. The ice bath was removed, and the solution was allowed to warm to 20 °C. After 24 h, water (150 mL) was added, and the organic layer was separated. The aqueous layer was extracted with CH_2Cl_2 (3 \times 180 mL). The combined organic extracts were washed with a 10% aqueous HCl solution (70 mL), a saturated NaHCO_3 solution (70 mL), and brine (70 mL). The organic phase was dried over MgSO_4 . After removal of solvent in vacuo, the crude mixture was distilled by using a distillation bridge (oil bath: 155 °C; 7 mbar). The first fraction gave 39.016 g (95%) of the pure product. ^1H NMR (500 MHz, CDCl_3) δ = 5.83 (1 H, ddt, J = 17.1, 10.2, 5.7 Hz, 3-H), 5.58 (1 H, s, 5-H), 5.17 (1 H, ddt, J = 17.1, 1.5, 1.5 Hz, 1-H), 5.12 (1 H, ddt, J = 10.2, 1.5, 1.5 Hz, 2-H), 3.88 (1 H, dddd, J = 5.7, 5.7, 1.5, 1.5 Hz, 4-H), 2.18 (2 H, t, J = 7.7 Hz, 7-H), 1.64 (2 H, m, 8-H), 1.31 (4 H, m, 9-H, 10-H), 0.89 (3 H, t, J = 7.0 Hz, 11-H) ppm. ^{13}C NMR (126 MHz, CDCl_3) δ = 173.1 (C=O), 134.6 (C-1), 116.4 (C-3), 42.0 (C-4), 36.9 (C-7), 31.6 (C-9/10), 25.6 (C-8), 22.5 (C-9/10), 14.1 (C-11) ppm. IR (ATR): 3282 (br), 3084 (w), 2958 (s), 929 (s), 2873 (m), 2860 (m), 1641 (vs), 1544 (vs), 1256 (s), 988 (s), 916 (s) cm^{-1} . HRMS (EI-TOF) m/z : $[\text{M} + \text{H}]^+$ calcd for $\text{C}_9\text{H}_{18}\text{N}_1\text{O}_1$ 156.1383; found 156.1390.

N-Propylhexanamine (5).⁵¹

This compound has also been synthesized by Stein and Breit using a different method.⁵¹ A solution of *N*-propylhexanamide (1.30 g, 8.27 mmol) in THF (2 mL) was added dropwise over a course of 2 min to a suspension of LiAlH_4 (940 mg, 24.8 mmol) in dry THF (10 mL). The suspension was heated to reflux temperature for 16 h, cooled in an ice bath, and quenched with H_2O (1 mL), 15% aqueous NaOH solution (1.5 mL), and additional H_2O (1 mL). The resulting suspension was filtered and flushed with Et_2O (10 mL), and the filtrate was dried over MgSO_4 . After removal of the solvent on a rotary evaporator (40 °C, 10 mbar), 0.634 g (54%) of the product was obtained as colorless oil. ^1H NMR (600 MHz, CDCl_3) δ = 2.58 (4 H, m, 3-H, 5-H), 1.68 (1 H, s, 4-H), 1.51 (4 H, m, 2-H, 6-H), 1.28 (6 H, m, 7-H, 8-H, 9-H), 0.91 (3 H, t, J = 7.4 Hz, 1-H), 0.88 (3 H, t, J = 6.9 Hz, 10-H) ppm. ^{13}C NMR (151 MHz, CDCl_3) δ = 52.1 (C-3), 50.2 (C-5), 31.9 (C-7/8/9), 30.2 (C-6), 27.2 (C-7/8/9), 23.3 (C-2), 22.8 (C-7/8/9), 14.2 (C-10), 11.9 (C-1) ppm. IR (ATR): 2957 (m), 2927 (s), 2874 (m), 2856 (m), 2809 (m), 1458 (m), 1131 (m), 723 (m) cm^{-1} . HRMS (EI-TOF) m/z : $[\text{M}]^+$ calcd for $\text{C}_9\text{H}_{21}\text{N}$ 143.1674; found 143.1668.

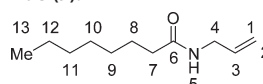
N-Allylbenzamide (6).⁵²

This compound has also been synthesized by Prediger et al.⁵² In a dried flask under an atmosphere of nitrogen, a solution of allylamine (3) (9.00 mL, 120 mmol) and triethylamine (16.5 mL, 120 mmol) in CH_2Cl_2 (120 mL) was cooled in an ice bath to 0 °C. Then benzoyl chloride (17.5 mL, 150 mmol) was added over the course of 1 h. After this time, the ice bath was removed, and the solution was allowed to warm to 22 °C. After 1 h at 22 °C, water (150 mL) was added, and the organic layer was separated. The aqueous layer was extracted with CH_2Cl_2 (3 × 150 mL). The combined organic extracts were washed with brine (100 mL) and dried over Na_2SO_4 and the solvent removed. The crude product was purified by column chromatography [silica; eluent, gradient *n*-hexane/ Et_2O from 90% *n*-hexane to 100% Et_2O ; R_f of product = 0.25; R_f of acid chloride = 0.53 (in $\text{Et}_2\text{O}/n$ -hexane = 1:1)]. After removal of the solvent in vacuo, 19.223 g (99%) of the product was obtained as colorless oil. ^1H NMR (600 MHz, CDCl_3) δ = 7.78 (2 H, m, 8-H), 7.47 (1 H, m, 10-H), 7.40 (2 H, m, 9-H), 6.55 (1 H, a br s, 5-H), 5.91 (1 H, ddt, J = 17.2, 10.3, 5.7 Hz, 3-H), 5.23 (1 H, ddt, J = 17.2, 1.7, 1.7 Hz, 1-H), 5.15 (1 H, ddt, J = 10.3, 1.6, 1.6 Hz, 2-H), 4.06 (1 H, dddd, J = 5.7, 5.7, 1.7, 1.6 Hz, 4-H) ppm. ^{13}C NMR (151 MHz, CDCl_3) δ = 167.5 (C-6), 134.5 (C-7), 134.3 (C-3), 131.6 (C-10), 128.6 (C-9), 127.1 (C-8), 116.6 (C-1), 42.5 (C-4) ppm. IR (ATR): 3073 (w), 3068 (w), 2913 (w), 1636 (vs), 1603 (m), 1578 (m), 1531 (vs), 1489 (s), 1294 (s), 917 (s), 691 (m) cm^{-1} . HRMS (EI-TOF) m/z : $[\text{M}]^+$ calcd for $\text{C}_{10}\text{H}_{11}\text{NO}$ 161.0841; found 161.0836.

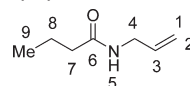
N-Allylbenzenemethanamine (8).⁵³

This compound has also been synthesized by Petersen et al. using a different method.⁵³ To a suspension of LiAlH_4 (657 mg, 15.1 mmol) in dry *t*-BuOMe (60 mL) in a Schlenk flask under nitrogen atmosphere was added *N*-allylbenzamide (3.241 g, 20.10 mmol) via syringe. Addition was continued while the reaction mixture started to reflux. The overall addition time was 3 min. The suspension was heated and stirred at 35 °C oil bath temperature for 4 h and quenched by adding H_2O (5 mL) while cooling the mixture (ice bath). The resulting suspension was dried over MgSO_4 and filtered. The filter cake was washed with Et_2O (120 mL). Evaporation of the solvent with a rotary evaporator and subsequent Kugelrohr distillation (50 °C; 2×10^{-1} mbar) yielded 1.910 g (13.0 mmol; 65%) of the product as colorless oil. ^1H NMR (500 MHz, CDCl_3) δ = 7.32 (4 H, m, 8-H, 9-H), 7.25 (1 H, m, 10-H), 5.93 (1 H, ddt, J = 17.3, 10.3, 6.0 Hz, 3-H), 5.20 (1 H, ddt, J = 17.3, 1.7, 1.4 Hz, 1-

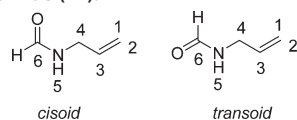
H), 5.11 (1 H, ddt, J = 10.3, 1.7, 1.4 Hz, 2-H), 3.79 (2 H, s, 6-H), 3.28 (2 H, ddd, J = 6.0, 1.4, 1.4 Hz, 4-H), 1.40 (1 H, s, 5-H)⁵⁴ ppm. ^{13}C NMR (126 MHz, CDCl_3) δ = 140.4 (C-7), 136.9 (C-3), 128.5 (C-9), 128.3 (C-8), 127.1 (C-10), 116.1 (C-1), 53.4 (C-6), 51.9 (C-4) ppm. IR (ATR): 3064 (w), 3028 (w), 2914 (w), 2812 (w), 1454 (m), 993 (m), 915 (s), 733 (s), 697 (vs) cm^{-1} . HRMS (EI-TOF) m/z : $[\text{M}]^+$ calcd for $\text{C}_{10}\text{H}_{13}\text{N}$ 147.1048; found 147.1043.

N-Allyloctanamide (9).⁵⁵

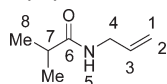
This compound has also been synthesized by Allen et al. using a different method.⁵⁵ In a dried flask under an atmosphere of nitrogen, a solution of allylamine (3) (9.00 mL, 120 mmol) in CH_2Cl_2 (120 mL) and triethylamine (16.6 mL, 120 mmol) was cooled in an ice bath. Octanoyl chloride (20.5 mL, 120 mmol) was added over the course of 1 h. The cooling bath was removed, and the reaction mixture stirred for a further 1 h. Then, water (150 mL) was added, and the organic layer was separated. The aqueous layer was extracted with CH_2Cl_2 (2 × 150 mL). The combined organic extracts were washed with brine (1 × 100 mL) and dried over Na_2SO_4 . The solvent and the remaining triethylamine were removed on a rotary evaporator. The product was obtained without further purification as colorless oil that solidifies slightly below 22 °C (ambient temperature) in a yield of 19.595 g, 89%. Mp: 25 °C. ^1H NMR (500 MHz, CDCl_3) δ = 5.84 (1 H, ddt, J = 17.1, 10.2, 5.7 Hz, 3-H), 5.52 (1 H, s, 5-H), 5.18 (1 H, ddt, J = 17.1, 1.6, 1.4 Hz, 1-H), 5.12 (1 H, ddt, J = 10.2, 1.4, 1.4 Hz, 2-H), 3.88 (2 H, dddd, J = 5.7, 5.7, 1.6, 1.4 Hz, 4-H), 2.19 (2 H, t, J = 7.5 Hz, 7-H), 1.63 (2 H, tt, J = 7.5, 7.5 Hz, 8-H), 1.29 (8 H, m, 12-H, 11-H, 10-H, 9-H), 0.87 (3 H, t, J = 7.0 Hz, 13-H) ppm. ^{13}C NMR (126 MHz, CDCl_3) δ = 173.1 (C-6), 134.6 (C-3), 116.4 (C-1), 42.0 (C-4), 37.0 (C-7), 31.8 (C-9/10/11/12), 29.4 (C-9/10/11/12), 29.1 (C-9/10/11/12), 25.9 (C-8), 22.7 (C-9/10/11/12), 14.2 (C-13) ppm. IR (ATR): 3297 (br), 3083 (w), 2956 (s), 2923 (m), 2856 (m), 1638 (vs), 1544 (vs), 1247 (m), 988 (m), 918 (s) cm^{-1} . HRMS (EI-TOF) m/z : $[\text{M}]^+$ calcd for $\text{C}_{11}\text{H}_{21}\text{N}_1\text{O}_1$ 183.1623; found 183.1616.

N-Allylbutanamide (10).⁵⁶

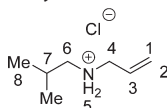
This compound has also been synthesized by Forjan et al.⁵⁶ In a dried flask under an atmosphere of nitrogen, a solution of allylamine (3) (9.00 mL, 6.85 g, 120 mmol) in CH_2Cl_2 (120 mL) was prepared. This solution was cooled in an ice bath, and triethylamine (16.6 mL, 120 mmol) was added. Butanoyl chloride (12.5 mL, 120 mmol) was added over the course of 1 h. After this time, the ice bath was removed, and the solution was allowed to warm to 22 °C. A colorless salt was formed. After 1 h, de-ionized water (150 mL) was added, and the organic layer was separated. The aqueous layer was extracted with CH_2Cl_2 (3 × 150 mL). The combined organic extracts were washed with brine (100 mL) and dried over Na_2SO_4 . The solvent and the remaining triethylamine were removed on a rotary evaporator. A yellowish liquid was obtained. The liquid was again dissolved in CHCl_3 (250 mL) and was washed with half saturated Na_2CO_3 and dried over Na_2SO_4 . The solvent was removed on a rotary evaporator to give the pure product (14.40 g; 94%) as colorless liquid. ^1H NMR (500 MHz, CDCl_3) δ = 5.84 (1 H, ddt, J = 17.2, 10.2, 5.7 Hz, 3-H), 5.55 (1 H, s, 5-H), 5.17 (1 H, ddt, J = 17.2, 1.6, 1.4 Hz, 1-H), 5.12 (1 H, ddt, J = 10.2, 1.4, 1.4 Hz, 2-H), 3.88 (2 H, dddd, J = 5.7, 5.7, 1.6, 1.4 Hz, 4-H), 2.17 (2 H, t, J = 7.4 Hz, 7-H), 1.67 (2 H, tq, J = 7.4, 7.4 Hz, 8-H), 0.95 (3 H, t, J = 7.4 Hz, 9-H) ppm. ^{13}C NMR (126 MHz, CDCl_3) δ = 172.9 (C-6), 134.6 (C-3), 116.4 (C-1), 42.0 (C-4), 38.8 (C-7), 19.3 (C-8), 13.9 (C-9) ppm. IR (ATR): 3289 (br), 3078 (w), 2964 (m), 2932 (w), 2874 (w), 1640 (vs), 1545 (vs), 989 (m), 917 (m) cm^{-1} . HRMS (EI-TOF) m/z : $[\text{M}]^+$ calcd for $\text{C}_7\text{H}_{13}\text{N}_1\text{O}_1$ 127.0997; found 127.0994.

N-Allylformamide (11).⁵²

This compound has also been synthesized by Prediger et al.⁵² A solution of allylamine (11.2 mL, 8.56 g, 150 mmol) in CH_2Cl_2 (50 mL) was cooled in an ice bath. To this solution, ethyl formate (10.1 mL, 18.5 g, 250 mmol) was added over the course of 10 min. After 30 min, the ice bath was removed, the solution was allowed to warm to 22 °C, and the reaction mixture was allowed to stir for 16 h. Then the solvent and residual starting materials were removed under reduced pressure (30 °C, 6 mbar). The crude product was purified by Kugelrohr distillation (70 °C, 0.5 mbar) to give a clear colorless liquid (4.745 g, 37%) in a mixture of cisoid/transoid of ca. 17/83. As the compound is relatively volatile, it is likely that prolonged application of vacuum reduces the yield substantially. ¹H NMR (500 MHz, CDCl_3), cisoid, δ = 8.09 (1H, s, 6-H), 6.80 (1H, s, 5-H) 5.82–5.68 (1H, m, 3-H), 5.15–5.08 (1H, m, 1-H), 5.05 (1H, ddd, J = 10.3, 2.9, 1.5 Hz, 2-H), 3.83–3.77 (2H, m, 4-H); transoid, δ = 7.93 (1H, d, J_{trans} = 12.0 Hz, 6-H; for CH-NH coupling constants of similar amides, see LaPlanche, L. A.; Rogers, M. T. *J. Am. Chem. Soc.* **1964**, *86*, 337), 6.44 (1H, s, 5-H), 5.82–5.68 (1H, m, 3-H), 5.18–5.11 (2H, m, 1-H, 2-H), 3.77–3.72 (2H, m, 4-H). ¹³C NMR (126 MHz, CDCl_3), cisoid, δ = 161.5 (C-6), 133.5 (C-3), 116.3 (C-2), 40.4 (C-4); transoid, δ = 165.1 (C-6), 134.4 (C-3), 116.7 (C-2), 44.0 (C-4). IR (of cisoid/transoid mixture) (ATR): 3280 (br), 3048 (br), 2865 (br), 1655 (vs), 1643 (vs), 1528 (m), 1382 (s), 917 (m) cm^{-1} . HRMS (EI-TOF) m/z : $[\text{M}]^+$ calcd for $\text{C}_4\text{H}_7\text{N}_1\text{O}_1$, 85.0528; found 85.0525.

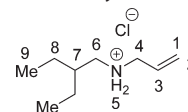
N-Allylisobutyramide (13).⁵⁷

This compound has also been synthesized by Buswell et al.⁵⁷ In a dried flask under an atmosphere of nitrogen, a solution of allylamine (3) (9.00 mL, 120 mmol) and triethylamine (16.6 mL, 120 mmol) in CH_2Cl_2 (120 mL) was cooled in an ice bath to 0 °C. Then, isobutyryl chloride (15.7 mL, 150 mmol) was added over the course of 1 h. After this time, the ice bath was removed, and the solution was allowed to warm to 22 °C. After 1 h at 22 °C, water (150 mL) was added, and the organic layer was separated. The aqueous layer was extracted with CH_2Cl_2 (3 × 150 mL). The combined organic extracts were washed with brine (100 mL) and dried over Na_2SO_4 and the solvent removed. The crude product was purified by column chromatography (silica; eluent, gradient *n*-hexane/chloroform from 100% *n*-hexane to 100% chloroform; R_f in chloroform = 0.13). As the product contained ca. 10% of isobutyric acid, it was dissolved in chloroform (200 mL) and extracted with a solution of half-saturated Na_2CO_3 (2 × 100 mL). The organic phase was dried over Na_2SO_4 and the solvent removed to obtain the product as a colorless solid (11.565 g, 76%). Mp: 36 °C. ¹H NMR (500 MHz, CDCl_3) δ = 5.83 (1 H, ddt, J = 17.1, 10.3, 5.7 Hz, 3-H), 5.61 (1 H, s, 5-H), 5.16 (1 ddt, J = 17.1, 1.7, 1.5 Hz, 1-H), 5.12 (1 H, ddt, J = 10.3, 1.7, 1.5 Hz, 2-H), 3.87 (2 H, ddd, J = 5.7, 1.5, 1.5 Hz, 4-H), 2.38 (1 H, sept, J = 6.9 Hz, 7-H), 1.16 (6 H, d, J = 6.9 Hz, 8-H) ppm. ¹³C NMR (126 MHz, CDCl_3) δ = 177.0 (C-6), 134.5 (C-3), 116.3 (C-1), 41.9 (C-4), 35.8 (C-7), 19.8 (C-8) ppm. IR (ATR): 3289 (br), 3083 (w), 2968 (m), 2935 (w), 2877 (w), 1642 (vs), 1539 (vs), 1240 (s), 988 (m), 917 (s) cm^{-1} . HRMS (EI-TOF) m/z : $[\text{M}]^+$ calcd for $\text{C}_7\text{H}_{13}\text{N}_1\text{O}_1$, 127.0997; found 127.0995.

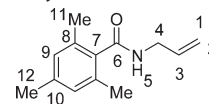
N-Allylisobutanamine Hydrochloride (14).

To a suspension of LiAlH_4 (658 mg, 15.2 mmol) in dry *t*-BuOMe (55 mL) in a Schlenk flask under a nitrogen atmosphere was added *N*-allylisobutyramide (2.554 g, 20.1 mmol) in dry *t*-BuOMe (5 mL) via syringe. Addition was continued while the reaction mixture started to

reflux. The overall addition time was 3 min. The suspension was heated and stirred at 35 °C oil bath temperature for 4 h and quenched by adding H_2O (5 mL) while cooling the mixture (ice bath). The resulting suspension was filtered, and the filter cake was washed with Et_2O (120 mL). To the filtrate was added hydrochloric acid (37%; 4 mL), and the mixture was stirred for 5 min. By evaporation of solvent on a rotary evaporator, a colorless salt was obtained which contained residual amide (~24%). A subsequent Kugelrohr distillation (60 °C; 5×10^{-2} mbar) yielded 1.743 g (11.6 mmol; 58%) of isolated product as colorless hygroscopic solid. ¹H NMR (500 MHz, CDCl_3) δ = 9.56 (2 H, as, 5-H), 6.12 (1 H, ddt, J = 17.2, 10.3, 7.0 Hz, 3-H), 5.46 (2 H, m, 1-H, 2-H), 3.62 (2 H, m, 4-H), 2.71 (2 H, m, 6-H), 2.23 (1 H, tsept, J = 6.7, 6.7 Hz, 7-H), 1.09 (6 H, d, J = 6.7 Hz, 8-H) ppm. ¹³C NMR (126 MHz, CDCl_3) δ = 128.2 (C-3), 124.2 (C-1/2), 53.6 (C-6), 50.2 (C-4), 26.0 (C-7), 20.7 (C-8) ppm. IR (ATR): 2962 (br s), 2755 (br s), 2425 (br), 446 (s), 993 (s), 928 (s) cm^{-1} . HRMS (EI-TOF) m/z : $[\text{M} - \text{HCl}]^+$ calcd for $\text{C}_7\text{H}_{15}\text{N}$ 113.1205; found 113.1205.

N-Allyl-2-ethylbutanamine Hydrochloride (15).

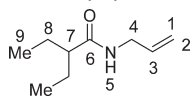
To a suspension of LiAlH_4 (656 mg, 15.1 mmol) in dry *t*-BuOMe (55 mL) in a Schlenk flask under nitrogen atmosphere was added *N*-allyl-2-ethylbutanamide (3.112 g, 20.04 mmol) in dry *t*-BuOMe (5 mL) via syringe. Addition was continued while the reaction mixture started to reflux. The overall addition time was 3 min. The suspension was heated and stirred at 35 °C oil bath temperature for 4 h and an additional 2 h at 55 °C. Then the reaction mixture was quenched by adding H_2O (5 mL) while cooling the mixture (ice bath). The resulting suspension was filtered, and the filter cake was washed with Et_2O (120 mL). To the filtrate was added hydrochloric acid (37%; 4 mL), and the mixture was stirred for 5 min. By evaporation of solvent on a rotary evaporator, a colorless salt was obtained which contained residual amide (~63%). A subsequent Kugelrohr distillation (80 °C; 2×10^{-1} mbar) yielded 874 mg (4.92 mmol; 25%) of the isolated product as colorless hygroscopic solid. ¹H NMR (500 MHz, CDCl_3) δ = 9.50 (2 H, as, 5-H), 6.13 (1 H, ddt, J = 17.2, 10.3, 7.0 Hz, 3-H), 5.46 (2 H, m, 1-H, 2-H), 3.61 (2 H, m, 4-H), 2.78 (2 H, m, 6-H), 1.83 (1 H, m, 7-H), 1.51 (4 H, m, 8-H), 0.89 (6 H, t, J = 7.4 Hz, 9-H) ppm. ¹³C NMR (126 MHz, CDCl_3) δ = 128.3 (C-3), 124.1 (C-1/2), 50.2 (C-4), 49.0 (C-6), 37.7 (C-7), 23.3 (C-8), 10.4 (C-9) ppm. IR (ATR): 2963 (s), 2932 (m), 2877 (m), 2798 (w), 2737 (m), 1462 (m), 1449 (m), 993 (m), 925 (s) cm^{-1} . HRMS (EI-TOF) m/z : $[\text{M}]^+$ calcd for $\text{C}_9\text{H}_{19}\text{N}_1$ 141.1518; found 141.1521.

N-Allyl-(2,4,6-trimethyl)benzamide (16).

In a dried flask under an atmosphere of nitrogen, a solution of allylamine (4.30 mL, 3.28 g, 57.5 mmol) in CH_2Cl_2 (50 mL) and triethylamine (7.97 mL, 5.82 g, 57.5 mmol) was cooled in an ice bath. 2,4,6-Trimethylbenzoyl chloride (9.55 mL, 10.5 g, 57.5 mmol) was added over the course of 60 min. The cooling bath was removed and the reaction mixture stirred for a further 1 h. Then, water (150 mL) was added, and the organic layer was separated. The aqueous layer was extracted with CH_2Cl_2 (2 × 150 mL). The combined organic extracts were washed with brine (1 × 100 mL) and dried over Na_2SO_4 . The solvent and the remaining triethylamine were removed on a rotary evaporator. The product was obtained without further purification as a colorless solid in a yield of 10.4538 g, 99%. Mp: 112 °C. ¹H NMR (600 MHz, CDCl_3) δ = 6.84 (as, 1H, 9-H), 5.93 (1 H, ddt, J = 16.2, 10.4, 5.8 Hz, 3-H), 5.66 (1 H, s, 5-H), 5.27 (1 H, m, 1-H), 5.18 (1 H, m, 2-H), 4.09 (1 H, dd, J = 5.8, 5.8 Hz, 4-H), 2.29 (6 H, s, 11-H), 2.27 (3H, s, 12-H). ¹³C NMR (151 MHz, CDCl_3) δ = 170.5 (C-6), 138.6 (C-11), 135.0 (C-12), 134.3 (C-7/9), 134.2 (C-7/9), 128.4 (C-8), 117.0 (C-1), 42.1 (C-4), 21.2 (C-12), 19.3 (C-11). IR (ATR): 3255 (br), 3083 (w), 2977 (w), 2916 (w), 2855 (w), 1635 (s), 1613 (m), 1545 (m), 1294 (m), 917

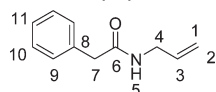
(m), 858 (m) cm^{-1} . HRMS (EI-TOF) m/z : $[M]^+$ calcd for $\text{C}_{13}\text{H}_{17}\text{N}_1\text{O}_1$ 203.1310; found 203.1312.

N-Allyl-2-ethylbutanamide (17).



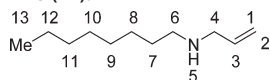
In a dried flask under an atmosphere of nitrogen was prepared a solution of allylamine (3) (8.98 mL, 6.85 g, 120 mmol) in CH_2Cl_2 (120 mL). This solution was cooled in an ice bath, and triethylamine (16.63 mL, 120 mmol) was added. 2-Ethylbutanoyl chloride (20.60 mL, 150 mmol) was added over the course of 1 h. After this time, the ice bath was removed, and the solution was allowed to warm to 22 °C. A colorless precipitate was formed. After 1 h, water (150 mL) was added, and the organic layer was separated. The aqueous layer was extracted with CH_2Cl_2 (3×150 mL). The combined organic extracts were washed with brine (100 mL) and dried over Na_2SO_4 and the solvent removed. The crude product was purified by column chromatography (silica; eluent, gradient cyclohexane/chloroform from 100% cyclohexane to 100% chloroform; R_f in chloroform = 0.25). After removing solvent, we obtained the pure product as colorless solid (18.316 g, 98%). Mp: 62 °C. ^1H NMR (600 MHz, CDCl_3) δ = 5.84 (1 H, ddt, J = 17.1, 10.2, 5.7 Hz, 3-H), 5.53 (1 H, s, 5-H), 5.19 (1 H, ddt, J = 17.1, 1.6, 1.4 Hz, 1-H), 5.12 (1 H, ddt, J = 10.2, 1.4, 1.3 Hz, 2-H), 3.91 (2 H, dddd, J = 5.7, 1.6, 1.3, 1.3, 4-H), 1.86 (1 H, m, 7-H), 1.62 (2 H, m, 8-H), 1.43 (2 H, m, 8-H), 0.87 (6 H, t, J = 7.5 Hz, 9-H) ppm. ^{13}C NMR (151 MHz, CDCl_3) δ = 175.7 (C-6), 134.8 (C-3), 116.4 (C-1), 51.8 (C-7), 41.9 (C-4), 25.9 (C-8), 12.3 (C-9) ppm. IR (ATR): 3287 (br s), 3077 (w), 2963 (s), 2928 (s), 2876 (m), 2862 (m), 1637 (s), 1538 (s), 1238 (m), 925 (s), 709 (s) cm^{-1} . HRMS (EI-TOF) m/z : $[M]^+$ calcd for $\text{C}_9\text{H}_{17}\text{N}_1\text{O}_1$ 155.1310; found 155.1306.

N-Allyl-2-phenylacetamide (19).⁵⁸



This compound has also been synthesized by Mahé et al. using a different method.⁵⁸ In a dried flask under an atmosphere of nitrogen was prepared a solution of allylamine (3) (8.98 mL, 120 mmol) in CH_2Cl_2 (120 mL). This solution was cooled in an ice bath, and triethylamine (16.6 mL, 120 mmol) was added. Phenylacetyl chloride (19.84 mL, 150 mmol) was added over the course of 1 h. Then the solution was allowed to warm to 22 °C. A colorless solid was formed. After 1 h, water (150 mL) was added, and the organic layer was separated. The aqueous layer was extracted with CH_2Cl_2 (3×150 mL). The combined organic extracts were washed with brine (100 mL) and dried over Na_2SO_4 and the solvent removed. A colorless solid was obtained. Recrystallization from Et_2O yielded in 10.38 g (49%) of product. Mp: 63 °C. ^1H NMR (500 MHz, CDCl_3) δ = 7.32 (5 H, m, 11/10/9-H), 5.76 (1 H, ddt, J = 17.0, 10.4, 5.5 Hz, 3-H), 5.47 (1 H, s, 5-H), 5.06 (1 H, ddt, J = 10.4, 1.4, 1.4 Hz, 1-H), 5.05 (1 H, ddt, J = 17.0, 1.6, 1.4 Hz, 2-H), 3.84 (2 H, dddd, 5.6, 1.6, 1.4, 1.4 Hz, 4-H), 3.60 (2 H, s, 7-H) ppm. ^{13}C NMR (126 MHz, CDCl_3) δ = 170.9 (C-6), 135.0 (C-8), 134.2 (C-3), 129.6 (C-10/9), 129.2 (C-10/9), 127.5 (C-11), 116.2 (C-1), 44.0 (C-7), 42.0 (C-4) ppm. IR (ATR): 3236 (m), 3073 (w), 3066 (w), 3008 (w), 1625 (s), 1556 (br s), 1493 (m) cm^{-1} . HRMS (EI-TOF) m/z : $[M]^+$ calcd for $\text{C}_{11}\text{H}_{13}\text{N}_1\text{O}_1$ 175.0997; found 175.0991.

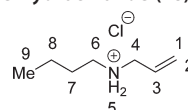
N-Allyloctanamide (27).⁵⁹



This compound has also been synthesized by Carrera et al. using a different method.⁵⁹ To a suspension of LiAlH_4 (657 mg, 15.1 mmol) in dry *t*-BuOMe (60 mL) in a Schlenk flask under nitrogen atmosphere was added *N*-allyloctanamide (3.678 g, 20.1 mmol) via syringe. Addition was continued while the reaction mixture started to reflux. The overall addition time was 3 min. The suspension was heated and stirred at 35 °C oil bath temperature for 4 h and quenched by adding H_2O (5 mL) while

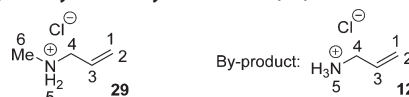
cooling the mixture (ice bath). The resulting suspension was dried over MgSO_4 and filtered. The filter cake was washed with Et_2O (120 mL). Evaporation of solvent and subsequent Kugelrohr distillation (40 °C; 2×10^{-1} mbar) yielded 2.192 g (16 mmol; 65%) of isolated product. ^1H NMR (500 MHz, CDCl_3) δ = 5.91 (1 H, ddt, J = 17.1, 10.2, 6.0 Hz, 3-H), 5.17 (1 H, ddt, J = 17.1, 1.6, 1.4 Hz, 1-H), 5.08 (1 H, ddt, J = 10.2, 1.7, 1.3 Hz, 2-H), 3.25 (2 H, ddd, J = 6.0, 1.5, 1.4 Hz, 4-H), 2.60 (2 H, t, J = 7.3 Hz, 6-H), 1.48 (2 H, m, 7-H), 1.30 (10 H, m, 12-H, 11-H, 10-H, 9-H, 8-H), 1.16 (1 H, s, 5-H), 0.87 (3 H, t, J = 7.0 Hz, 13-H) ppm. ^{13}C NMR (126 MHz, CDCl_3) δ = 137.3 (C-3), 115.7 (C-1), 52.7 (C-4), 49.7 (C-6), 32.0 (C-7), 30.3 (C-12/11/10/9/8), 29.7 (C-7), 29.4 (C-12/11/10/9/8), 27.5 (C-12/11/10/9/8), 22.8 (C-12/11/10/9/8), 14.2 (C-13) ppm. IR (ATR): 2957 (m), 2924 (vs), 2855 (s), 2811 (m), 1458 (m), 1123 (m), 993 (m), 916 (s), 723 (m) cm^{-1} . HRMS (EI-TOF): $[M]^+$ calcd for $\text{C}_{11}\text{H}_{23}\text{N}$ 169.1831; found 169.1829.

N-Allylbutanamine Hydrochloride (28).



To a suspension of LiAlH_4 (655 mg, 15.1 mmol) in dry *t*-BuOMe (60 mL) in a Schlenk flask under nitrogen atmosphere was added *N*-allylbutanamide (2.578 g, 20.3 mmol) via syringe. Addition was continued while the reaction mixture started to reflux. The overall addition time was 3 min. The suspension was heated and stirred at 35 °C oil bath temperature for 4 h and quenched by adding H_2O (5 mL) while cooling the mixture (ice bath). The resulting suspension was filtered, and the filter cake was washed with Et_2O (120 mL). To the filtrate, hydrochloric acid (37%, 4 mL) was added, and the mixture was stirred for 5 min. By evaporation of solvent on a rotary evaporator, a colorless salt was obtained which contained residual amide (~18%). A subsequent Kugelrohr distillation (60 °C; 5×10^{-2} mbar) yielded 2.036 g (13.6 mmol; 68%) of the isolated product as colorless hygroscopic solid. ^1H NMR (500 MHz, CDCl_3) δ = 9.64 (2 H, s, 5-H), 6.09 (1 H, ddt, J = 17.2, 10.2, 6.9 Hz, 3-H), 5.47 (1 H, ddt, J = 17.2, 1.3, 1.0 Hz, 1-H), 5.44 (1 H, dd, J = 10.2, 1.0 Hz, 2-H), 3.57 (2 H, m, 4-H), 2.87 (2 H, m, 6-H), 1.84 (2 H, m, 7-H), 0.95 (3 H, t, J = 7.4 Hz, 9-H) ppm. ^{13}C NMR (126 MHz, CDCl_3) δ = 128.0 (C-3), 124.0 (C-1), 49.6 (C-4), 46.3 (C-6), 27.9 (C-7), 20.3 (C-8), 13.6 (C-9) ppm. IR (ATR): 2962 (br s), 2935 (br s), 2877 (m), 2735 (br s), 2439 (m), 1453 (s), 992 (m), 930 (m) cm^{-1} . HRMS (EI-TOF): $[M - \text{HCl}]^+$ calcd for $\text{C}_7\text{H}_{13}\text{N}$ 113.1205; found 113.1204.

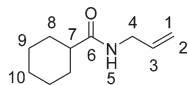
N-Allylmethylamine Hydrochloride (29).



To a suspension of LiAlH_4 (653 mg, 15.1 mmol) in dry *t*-BuOMe (60 mL) in a Schlenk flask under a nitrogen atmosphere was added *N*-allylformamide (1.718 g, 20.2 mmol) via syringe. Addition was continued while the reaction mixture started to reflux. The overall addition time was 3 min. The suspension was heated and stirred at 35 °C oil bath temperature for 1 h and quenched by adding H_2O (5 mL) while cooling the mixture (ice bath). The resulting suspension was filtered, and the filter cake was washed with Et_2O (120 mL). To the filtrate was added hydrochloric acid (37%, 4 mL), and the mixture was stirred for 5 min. By evaporation of solvent on a rotary evaporator, a colorless high hygroscopic salt (1.826 g; 85%) was obtained which contained allylamine hydrochloride (12 (~22%)). ^1H NMR (29, 500 MHz, CDCl_3) δ = 9.51 (2 H, s, 5-H), 6.04 (1 H, m, 3-H), 5.51 (1 H, m, 1-H), 5.49 (1 H, m, 2-H), 3.61 (2 H, m, 4-H), 2.65 (3 H, t, J = 7.4 Hz, 6-H) ppm. ^1H NMR (12, 500 MHz, CDCl_3): δ = 8.46 (3 H, s, 5-H), 6.04 (1 H, m, 3-H), 5.50 (1 H, m, 1-H), 5.38 (1 H, m, 2-H), 3.63 (2 H, m, 4-H) ppm. ^{13}C NMR (29, 126 MHz, CDCl_3) δ = 127.6 (C-3), 124.5 (C-1), 51.1 (C-4), 31.8 (C-6) ppm. ^{13}C NMR (12, 126 MHz, CDCl_3) δ = 129.5 (C-3), 121.8 (C-1), 42.1 (C-4) ppm. IR (mixture of 29 and 12; ATR): 2951 (br s), 2711 (br s), 2425 (m), 1465 (m), 1427 (m), 995 (m), 940 (s) cm^{-1} . HRMS (29; EI-TOF) m/z : $[M - \text{HCl}]^+$ calcd for $\text{C}_4\text{H}_9\text{N}$

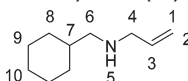
71.0735; found 71.0733. HRMS (12; EI-TOF) m/z : the mass of 12 was too low for detecting high resolution mass on our systems.

N-Allylcyclohexanamide (30).



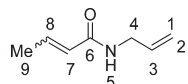
In a dried flask under an atmosphere of nitrogen was cooled a solution of allylamine (3) (9.0 mL, 120 mmol) in CH_2Cl_2 (120 mL) and triethylamine (16.6 mL, 120 mmol) in an ice bath. Cyclohexanoyl chloride (20.2 mL, 150 mmol) was added over the course of 1 h. The cooling bath was removed and the reaction mixture stirred for a further 1 h. Then, water (150 mL) was added, and the organic layer was separated. The aqueous layer was extracted with CH_2Cl_2 (3 \times 150 mL). The combined organic extracts were washed with brine (1 \times 100 mL) and dried over Na_2SO_4 . The solvent and the remaining triethylamine were removed on a rotary evaporator. The crude product was purified by column chromatography (silica; eluent, gradient *n*-hexane/diethyl ether from 90% to 50% *n*-hexane; R_f in *n*-hexane/diethyl ether 1:1 = 0.15). After removal of the solvent on the rotary evaporator, the product was obtained as colorless solid (17.210 g, 82%). Mp: 74 °C. ^1H NMR (600 MHz, CDCl_3) δ = 5.83 (1 H, ddt, J = 17.1, 10.3, 5.7, 3-H), 5.56 (1 H, s, 5-H), 5.16 (1 H, ddt, J = 17.1, 1.6, 1.5, 1-H), 5.11 (1 H, ddt, J = 10.2, 1.5, 1.3, 2-H), 3.87 (2 H, dddd, J = 5.7, 5.7, 1.5, 1.3, 4-H), 2.09 (1 H, tt, J = 11.9, 3.4, 7-H), 1.86 (2 H, m, 10/9/8-H), 1.79 (2 H, m, 10/9/8-H), 1.66 (1 H, m, 10/9/8-H), 1.44 (1 H, m, 10/9/8-H), 1.23 (3 H, m, 10/9/8-H) ppm. ^{13}C NMR (151 MHz, CDCl_3) δ = 176.0 (C-6), 134.6 (C-3), 116.3 (C-1), 45.7 (C-7), 41.8 (C-4), 29.9 (C-8), 25.9 (C-10, C-9) ppm. IR (ATR): 3291 (s), 3082 (w), 2928 (vs), 2853 (s), 1638 (vs), 1547 (vs), 1255 (m), 997 (s), 919 (vs), 702 (s) cm^{-1} . HRMS (EI-TOF) m/z : $[\text{M}]^+$ calcd for $\text{C}_{10}\text{H}_{17}\text{N}_1\text{O}_1$ 167.1310; found 167.1307.

N-Allyl-(cyclohexylmethyl)amine (31).



This compound has also been synthesized by Denes et al. using a different method.⁶⁰ To a suspension of LiAlH_4 (659 mg, 17.143 mmol) in dry *t*-BuOMe (45 mL) in a Schlenk flask under nitrogen atmosphere was added *N*-allylcyclohexanamide (3.349 g, 20 mmol) in dry *t*-BuOMe (15 mL) via syringe. Addition was continued while the reaction mixture started to reflux. The overall addition time was 3 min. The suspension was heated and stirred at 35 °C oil bath temperature for 4 h and quenched by adding H_2O (5 mL) while cooling the mixture (ice bath). The resulting suspension was dried over MgSO_4 and filtered. The filter cake was washed with Et_2O (120 mL). Evaporation of solvent and subsequent Kugelrohr distillation (30 °C; 2×10^{-1} mbar) yielded 2.413 g (15.7 mmol; 79%) of colorless oil as isolated product. ^1H NMR (500 MHz, CDCl_3) δ = 5.90 (1 H, ddt, J = 17.1, 10.3, 6.0 Hz, 3-H), 5.16 (1 H, ddt, J = 17.1, 1.7, 1.6 Hz, 1-H), 5.07 (1 H, ddt, J = 10.3, 1.7, 1.4 Hz, 2-H), 3.22 (2 H, ddd, J = 6.0, 1.6, 1.4 Hz, 4-H), 2.43 (2 H, d, J = 6.7 Hz, 6-H), 1.68 (5 H, m, 10/9/8-H, 5-H), 1.45 (1 H, m, 7-H), 1.19 (4 H, m, 10/9/8-H), 0.90 (2 H, m, 10/9/8-H). ^{13}C NMR (151 MHz, CDCl_3) δ = 137.4 (C-3), 115.7 (C-1), 56.4 (C-6), 52.9 (C-4), 38.2 (C-7), 31.6 (C-8), 26.8 (C-10/9) 26.2 (C-10/9) ppm. IR (ATR): 2920 (vs), 2852 (m), 2810 (w), 1449 (s), 1123 (w), 993 (m), 915 (s) cm^{-1} . HRMS (EI-TOF) m/z : $[\text{M}]^+$ calcd for $\text{C}_{10}\text{H}_{19}\text{N}_1$ 153.1518; found 153.1518.

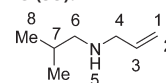
N-Allylbut-2-enamide (32).



To a solution of allylamine (3) (8.98 mL, 6.85 g, 120 mmol) and triethylamine (16.63 mL, 120 mmol) in CH_2Cl_2 (120 mL) at 0 °C was added crotonyl chloride (14.37 mL, 150 mmol, *trans/cis* = 90/10) over the course of 1 h. The ice bath was removed, and the solution was allowed to stir at 22 °C for a further 1 h. Then, water (150 mL) was added, and the organic layer was separated. The aqueous layer was extracted with CH_2Cl_2 (3 \times 150 mL). The combined organic extracts were washed with brine (100 mL) and dried over Na_2SO_4 . The solvent

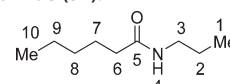
and the remaining triethylamine were removed on a rotary evaporator, and the remaining material was distilled with a 10 cm Vigreux column. The product could be isolated as a colorless liquid (10.946 g, 84%, *trans/cis* = 98/2) that easily solidified at a steam temperature of $T = 104$ °C, pressure = 1 mbar. Because the product was obtained as a *cis/trans* mixture, no mp was determined. ^1H NMR (600 MHz, CDCl_3 , *trans* product) δ = 6.84 (1 H, dq, J = 15.2, 6.9 Hz, 8-H), 5.85 (1 H, ddt, J = 17.1, 10.3, 5.7 Hz, 3-H), 5.81 (1 H, dq, J = 15.2, 1.7 Hz, 7-H), 5.63 (1 H, s, 5-H), 5.19 (1 H, ddt, J = 17.1, 1.6, 1.2 Hz, 1-H), 5.13 (1 H, ddt, J = 10.3, 1.4, 1.2 Hz, 2-H), 3.94 (2 H, dddd, J = 5.7, 5.7, 1.6, 1.2 Hz, 4-H), 1.85 (3 H, dd, J = 6.9, 1.7 Hz, 9-H) ppm. ^1H NMR (600 MHz, CDCl_3 , *cis* product)⁶¹ δ = 6.12 (dq, J = 11.5, 7.2 Hz, 8-H), 5.73 (dq, J = 11.5, 1.8 Hz, 7-H), 2.13 (dd, J = 7.2, 1.8 Hz, 9-H) ppm. ^{13}C NMR (151 MHz, CDCl_3 , *trans* product)⁶² δ = 165.9 (C-6), 140.2 (C-8), 134.4 (C-3), 125.0 (C-7), 116.5 (C-1), 42.0 (C-4), 17.8 (C-9) ppm. IR (ATR): 3281brm, 3076 (br w), 2916 (w), 1675 (s), 1632 (s), 1545 (m) cm^{-1} . HRMS (EI-TOF) m/z : $[\text{M}]^+$ calcd for $\text{C}_7\text{H}_{11}\text{N}_1\text{O}_1$ 125.0841; found 125.0841.

N-Allylisobutanamine (33).



This compound has also been synthesized by D'hooghe et al. using a different method.⁶³ To a suspension of LiAlH_4 (654 mg, 15.1 mmol) in dry *t*-BuOMe (55 mL) in a Schlenk flask under nitrogen atmosphere was added *N*-allylisobutyramide (2.584 g, 20.3 mmol) in dry *t*-BuOMe (5 mL) via syringe. Addition was continued while the reaction mixture started to reflux. The overall addition time was 3 min. The suspension was heated and stirred at 35 °C oil bath temperature for 4 h and quenched by adding H_2O (5 mL) while cooling the mixture (ice bath). The resulting suspension was dried over MgSO_4 and filtered. The filter cake was washed with Et_2O (120 mL). Evaporation of solvent on a rotary evaporator and subsequent Kugelrohr distillation (60 °C; 60 mbar) yielded 0.648 g (5.7 mmol; 29%) of isolated product as a colorless oil. ^1H NMR (500 MHz, CDCl_3) δ = 5.91 (1 H, ddt, J = 17.1, 10.3, 6.0 Hz, 3-H), 5.17 (1 ddt, J = 17.1, 1.7, 1.5 Hz, 1-H), 5.08 (1 H, ddt, J = 10.3, 1.7, 1.4 Hz, 2-H), 3.24 (2 H, ddd, J = 6.0, 1.5, 1.4 Hz, 4-H), 2.42 (2 H, d, J = 6.7 Hz, 6-H), 1.75 (1 H, tsept, J = 6.7, 6.7 Hz, 7-H), 1.09 (1 H, s, 5-H), 0.91 (6 H, d, J = 6.7 Hz, 8-H) ppm. ^{13}C NMR (126 MHz, CDCl_3) δ = 137.4 (C-3), 115.7 (C-1), 57.7 (C-6), 52.8 (C-4), 28.5 (C-7), 20.3 (C-8) ppm. IR (ATR): 2955 (s), 2837 (m), 2810 (m), 1470 (m), 1449 (m), 993 (m), 917 (vs) cm^{-1} . HRMS (EI-TOF) m/z : $[\text{M}]^+$ calcd for $\text{C}_7\text{H}_{15}\text{N}$ 113.1205; found 113.1207.

N-Propylhexanamide (34).



This compound has also been synthesized by Zyryanov and Rudkevich using a different method.⁶⁴ In a dried flask, a solution of allylamine (3) (4.1 mL, 50 mmol) and triethylamine (7.3 mL, 54 mmol) in toluene (100 mL) was cooled in an ice bath (<0 °C). Hexanoyl chloride (8.0 mL, 58 mmol) was gradually added over the course of 5 min. The ice bath was removed, and the solution was allowed to warm to 18 °C. After 12 h, water (50 mL) was added, and the organic layer was separated. The aqueous layer was extracted CH_2Cl_2 (3 \times 200 mL). The combined organic extracts were washed with a 10% aqueous HCl solution (30 mL), a saturated NaHCO_3 solution (50 mL), and brine (50 mL). The organic phase was dried over MgSO_4 . After removal of solvent in vacuo, 8.720 g (91%) of the product was obtained as a colorless oil. ^1H NMR (600 MHz, CDCl_3) δ = 5.46 (1 H, s, 4-H), 3.21 (2 H, td, J = 7.3, 6.7 Hz, 3-H), 2.15 (2 H, t, J = 7.6 Hz, 6-H), 1.63 (2 H, tt, J = 7.6, 7.6 Hz, 7-H), 1.51 (2 H, tq, J = 7.3, 7.3 Hz, 2-H), 1.31 (4 H, m, 8-H, 9-H), 0.92 (3 H, t, J = 7.3 Hz, 1-H), 0.89 (3 H, t, J = 7.0 Hz, 10-H) ppm. ^{13}C NMR (126 MHz, CDCl_3) δ = 173.3 (C-5), 41.3 (C-3), 37.0 (C-z6), 31.6 (C-8), 25.7 (C-7), 23.1 (C-2), 22.6 (C-9), 14.1 (C-10), 11.5 (C-1) ppm. IR (ATR): 3292 (br), 3084 (w), 2960 (s), 2931 (s), 2874 (m), 863 (m), 1642 (vs), 1549 (vs), 1254 (m) cm^{-1} . HRMS (EI-TOF): $[\text{M}]^+$ calcd for $\text{C}_9\text{H}_{19}\text{N}_1\text{O}_1$ 157.1467; found 157.1468.

■ ASSOCIATED CONTENT

■ Supporting Information

Purities of the compounds used, drying procedures for the solvents, ^1H NMR and ^{13}C NMR spectra for all compounds, calculations and spectra of the LiAlH_4 titration, complete optimization data, and additional ^1H NMR spectra of the mechanistic study. This material is available free of charge via the Internet at <http://pubs.acs.org>.

■ AUTHOR INFORMATION

Corresponding Author

*E-mail: astaubitz@oc.uni-kiel.de.

Notes

The authors declare no competing financial interest.

■ ACKNOWLEDGMENTS

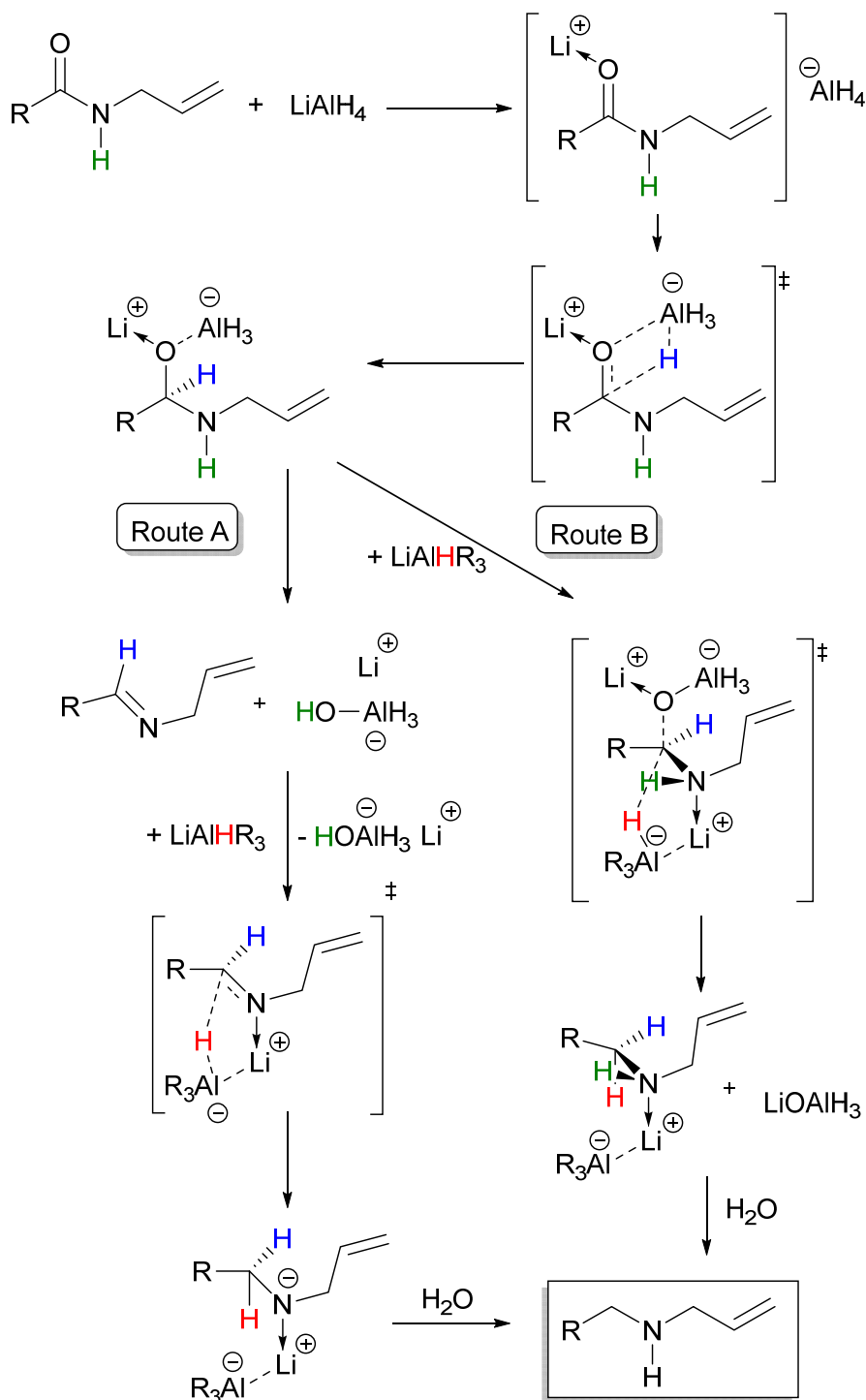
B.T. and A.S. thank the Deutsche Forschungsgemeinschaft (DFG) for an Emmy-Noether-Fellowship to A.S. which provided funding for this research.

■ REFERENCES

- Suvanprakorn, P.; Vayumhasuwan, P.; Zaias, N., Increased effectiveness of allylamine drug compounds for topical treatment of fungal infections of the skin and skin appendages. U.S. Pat. Appl. US20120087974, 2012.
- Kondo, T.; Nakai, H.; Goto, T. *Tetrahedron* **1973**, *29*, 1801.
- Hashimoto, T.; Kondo, S.; Naganawa, H.; Takita, T.; Maeda, K.; Umezawa, H. *J. Antibiot.* **1974**, *27*, 86.
- Hashimoto, T.; Umezawa, H.; Takahashi, S.; Takita, T.; Naganawa, H.; Maeda, K. *J. Antibiot.* **1972**, *25*, 350.
- Teng, C. Y. P.; Ganem, B. *Tetrahedron Lett.* **1982**, *23*, 313.
- Rando, R. R.; Bangerter, F. W. *J. Am. Chem. Soc.* **1976**, *98*, 6762.
- Kobayashi, K.; Miyazawa, S.; Terahara, A.; Mishima, H.; Kurihara, H. *Tetrahedron Lett.* **1976**, 537.
- Rando, R. R.; Bangerter, F. W. *J. Am. Chem. Soc.* **1977**, *99*, 5141.
- Allan, R. D.; Johnston, G. A. R.; Twitchin, B. *Neurosci. Lett.* **1977**, *4*, 51.
- Neisius, M.; Liang, S.; Misprouve, H.; Gaan, S. *Ind. Eng. Chem. Res.* **2013**, *52*, 9752.
- Cacchi, S.; Fabrizi, G.; Goggiamani, A.; Sferrazza, A. *Org. Biomol. Chem.* **2011**, *9*, 1727.
- Nag, S.; Batra, S. *Tetrahedron* **2011**, *67*, 8959.
- Ashe, A. J.; Fang, X. D. *Org. Lett.* **2000**, *2*, 2089.
- Ashe, A. J.; Fang, X. D.; Fang, X. G.; Kampf, J. W. *Organometallics* **2001**, *20*, 5413.
- Hayashi, T.; Yamamoto, A.; Ito, Y.; Nishioka, E.; Miura, H.; Yanagi, K. *J. Am. Chem. Soc.* **1989**, *111*, 6301.
- Jumnah, R.; Williams, J. M. J.; Williams, A. C. *Tetrahedron Lett.* **1993**, *34*, 6619.
- Bower, J. F.; Jumnah, R.; Williams, A. C.; Williams, J. M. J. *J. Chem. Soc., Perkin Trans. 1* **1997**, 1411.
- Burgess, K.; Liu, L. T.; Pal, B. *J. Org. Chem.* **1993**, *58*, 4758.
- Trost, B. M. *Angew. Chem., Int. Ed.* **1989**, *28*, 1173.
- Magnus, P.; Lacour, J.; Coldham, I.; Mugrage, B.; Bauta, W. B. *Tetrahedron* **1995**, *51*, 11087.
- Trost, B. M.; Vanranken, D. L. *J. Am. Chem. Soc.* **1993**, *115*, 444.
- Seo, T.; Take, S.; Akimoto, T.; Hamada, K.; Iijima, T. *Macromolecules* **1991**, *24*, 4801.
- Carretti, E.; Dei, L.; Baglioni, P.; Weiss, R. G. *J. Am. Chem. Soc.* **2003**, *125*, 5121.
- Seo, T.; Take, S.; Miwa, K.; Hamada, K.; Iijima, T. *Macromolecules* **1991**, *24*, 4255.
- Falbe, J.; Schulze-Steinen, H.-J.; Korte, F. *Chem. Ber.* **1965**, *98*, 1923.
- Zhou, C.-Y.; Yu, W.-Y.; Chan, P. W. H.; Che, C.-M. *J. Org. Chem.* **2004**, *69*, 7072.
- Awasthi, A. K.; Paul, K. *Org. Process Res. Dev.* **2001**, *5*, 528.
- Davis, A. S.; Pyne, S. G.; Skelton, B. W.; White, A. H. *J. Org. Chem.* **2004**, *69*, 3139.
- Barluenga, J.; Rodriguez, F.; Alvarez-Rodrigo, L.; Zapico, J. M.; Fananas, F. J. *Chem.—Eur. J.* **2004**, *10*, 109.
- Guerin, C.; Bellosta, V.; Guillamot, G.; Cossy, J. *Org. Lett.* **2011**, *13*, 3534.
- D'hooghe, M.; De Kimpe, N. *ARKIVOC* **2007**, 365.
- Blackburn, L.; Taylor, R. J. K. *Org. Lett.* **2001**, *3*, 1637.
- Panayides, J. L.; Pathak, R.; de Koning, C. B.; van Otterlo, W. A. L. *Eur. J. Org. Chem.* **2007**, 4953.
- Braxmeier, T.; Friedrichson, T.; Jennings, G.; Knölker, H. J.; Schlechtingen, G., Oxygenated amino- or ammonium-containing sulfonic acid, phosphonic acid and carboxylic acid derivatives and their medical use. Patent WO2012EP59810 20120525, 2012.
- Chowdhury, G.; Calcutt, M. W.; Nagy, L. D.; Guengerich, F. P. *Biochemistry* **2012**, *51*, 9995.
- Bougeois, J. L.; Stella, L.; Surzur, J. M. *Tetrahedron Lett.* **1981**, *22*, 61.
- Briggs, J.; Klosin, J.; Whiteker, G. *Org. Lett.* **2005**, *7*, 4795.
- Wu, H.; He, Y.-P.; Gong, L.-Z. *Adv. Synth. Catal.* **2012**, *354*, 975.
- The GC could be calibrated for the starting material **2**, the product **1**, and the byproduct **5** by using clean samples of the compounds that were obtained later after the optimization process described in Table 1.
- The activity of LiAlH_4 was tested by titration according to: Hoye, T. R.; Aspaas, A. W.; Eklov, B. M.; Ryba, T. D. *Org. Lett.* **2005**, *7*, 2205.
- Finholt, A. E.; Bond, A. C.; Schlesinger, H. I. *J. Am. Chem. Soc.* **1947**, *69*, 1199.
- Bikiel, D. E.; Di Salvo, F.; Lebrero, M. C. G.; Doctorovich, F.; Estrin, D. A. *Inorg. Chem.* **2005**, *44*, 5286.
- It is in fact commonly accepted and written in chemistry textbooks that such a reaction does not take place.
- Bruckner, R.; Harmata, M. *Organic Mechanisms: Reactions, Stereochemistry and Synthesis*; Springer: Berlin, 2010.
- Hochstein, F. A.; Brown, W. G. *J. Am. Chem. Soc.* **1948**, *70*, 3484.
- Micovic, V. M.; Mihailovic, M. L. *J. Org. Chem.* **1953**, *18*, 1190.
- Newman, M. S.; Fukunaga, T. *J. Am. Chem. Soc.* **1960**, *82*, 693.
- Naeimi, H.; Salimi, F.; Rabiei, K. *J. Mol. Catal. A: Chem.* **2006**, *260*, 100.
- Yadav, J. S.; Madhuri, C.; Reddy, B. V. S.; Reddy, G. S. K. K.; Sabitha, G. *Synth. Commun.* **2002**, *32*, 2771.
- Cadierno, V.; Gimeno, J.; Nebra, N. *Chem.—Eur. J.* **2007**, *13*, 6590.
- Stein, M.; Breit, B. *Angew. Chem., Int. Ed.* **2013**, *52*, 2231.
- Prediger, P.; Barbosa, L. F.; Genisson, Y.; Correia, C. R. D. *J. Org. Chem.* **2011**, *76*, 7737.
- Petersen, M. T.; Nielsen, T. E. *Org. Lett.* **2013**, *15*, 1986.
- The NH signal was only visible if dried CDCl_3 was used.
- Allen, C. L.; Lapkin, A. A.; Williams, J. M. J. *Tetrahedron Lett.* **2009**, *50*, 4262.
- Forjan, D. M.; Kontrec, D.; Vinkovic, V. *Chirality* **2006**, *18*, 857.
- Buswell, M.; Fleming, L.; Ghosh, U.; Mack, S.; Russell, M.; Clark, B. P. *Org. Biomol. Chem.* **2004**, *2*, 3006.
- Mahe, O.; Desroches, J.; Paquin, J. F. *Eur. J. Org. Chem.* **2013**, *2013*, 4325.
- Carrera, G. V. S. M.; Frade, R. F. M.; Aires-de-Sousa, J.; Afonso, C. A. M.; Branco, L. C. *Tetrahedron* **2010**, *66*, 8785.
- Denes, F.; Perez-Luna, A.; Chemla, F. *J. Org. Chem.* **2007**, *72*, 398.
- Integration at this low level of intensity is unreliable and is therefore not reported. Peak assignments were made by analyzing coupling constants and a COSY NMR spectrum. 5-H, 4-H, 3-H, 2-H and 1-H could not be identified because corresponding signals probably are overlaid from trans product signals.
- Only few of the signals of the cis product were visible and were therefore not assigned.
- D'hooghe, M.; De Kimpe, N. *Chem. Commun.* **2007**, 1275.
- Zyryanov, G. V.; Rudkevich, D. M. *Org. Lett.* **2003**, *5*, 1253.

Corrigendum

In Figure 4 of the publication “Reduction of *N*-Allylamides by LiAlH_4 : Unexpected Attack of the Double Bond with Mechanistic Studies of Product and By-product Formation”, there is a typographical mistake. This has been corrected in the Figure below.



Corrigendum 1. Negative charge of the nitrogen in the transition stage of “Route B” is a mistake and was corrected.

3.2 Towards Conjugated 1,2-Azaborine Polymers

For developing conjugated polymers, we decided to synthesise 1,3-bridged 1,2-azaborine systems. The monomers needed to contain a substituent that would facilitate the solubilisation of the polymer. For synthetic reasons, this substituent was chosen to be attached to the boron atom (R^1) (**Figure 10**).

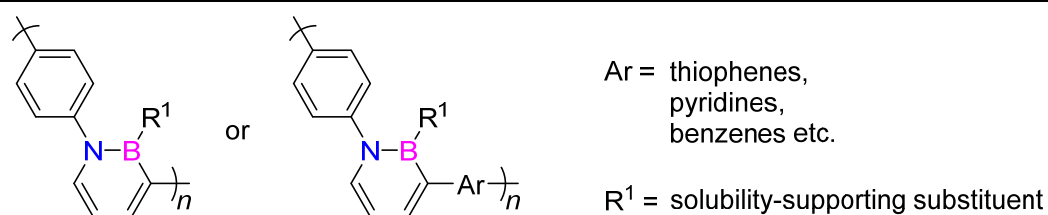
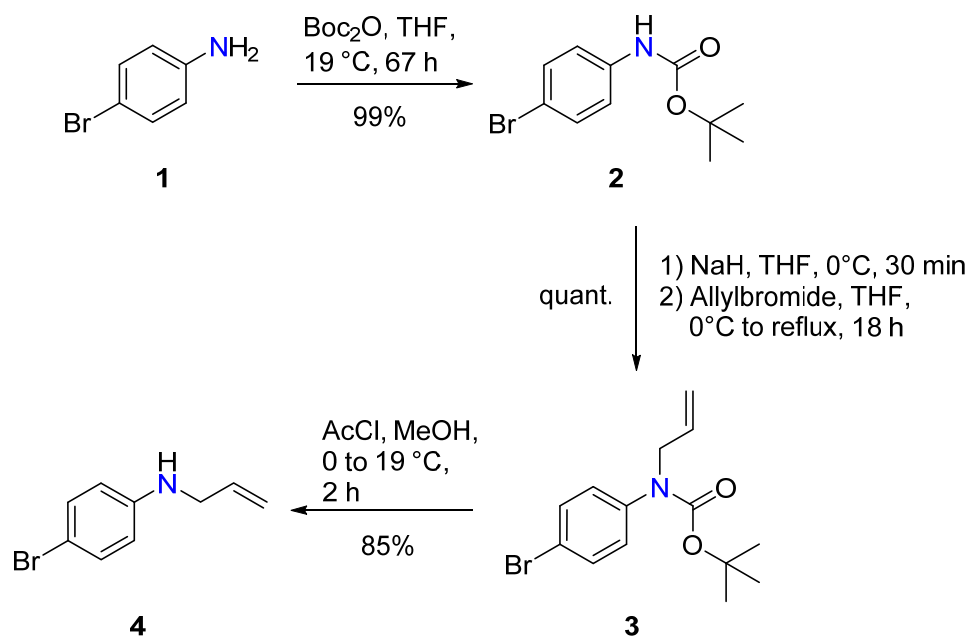


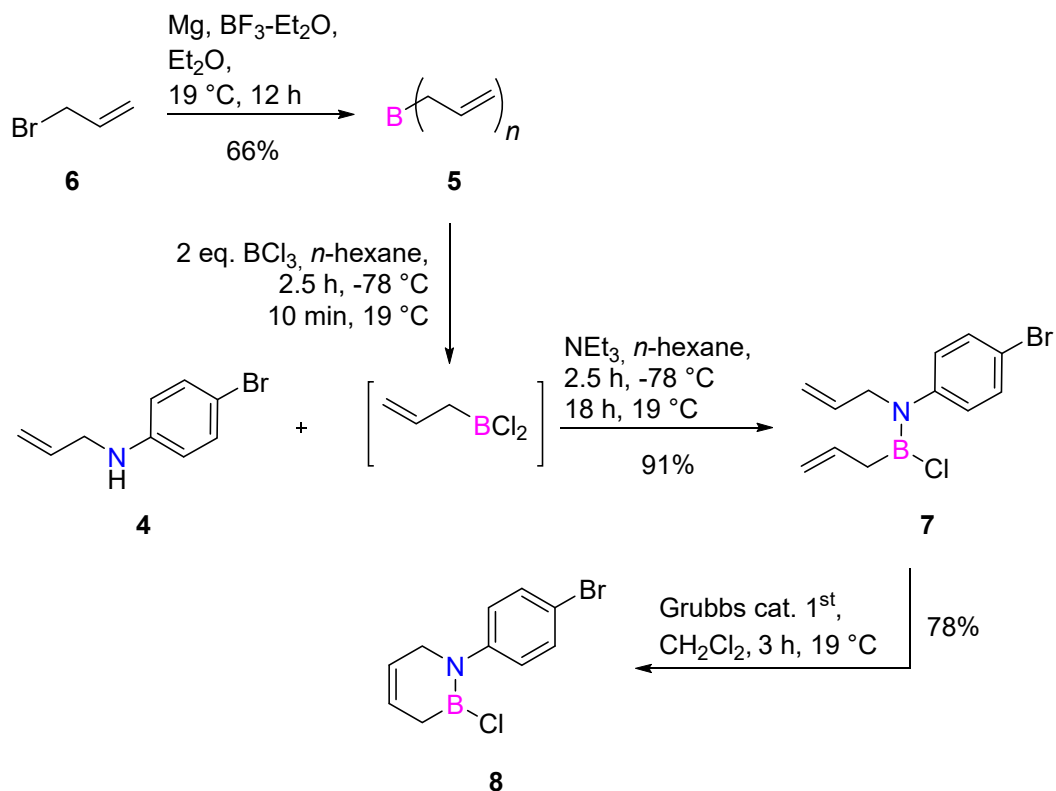
Figure 10. Pattern of partly conjugated 1,2-azaborine polymers.

The syntheses towards the 1,2-azaborine monomer were conducted by the bachelor student L. Dölger during her bachelor's thesis under my supervision.⁷³ She started with the *N*-Boc-protection of 4-bromoaniline **1** to amide **2**, which was necessary to avoid the introduction of two allyl groups in the following step to compound **3**. By deprotection, she obtained the amine species **4** (**Scheme 10**; for procedures: see **Chapter 5.2.5**).



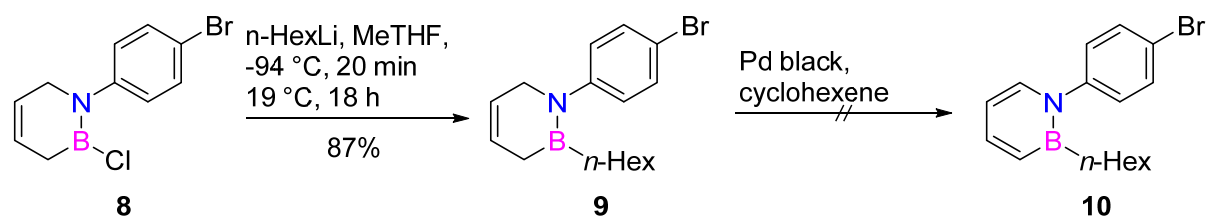
Scheme 10. Synthesis of a secondary amine component **4** by L. Dölger.⁷³

The boron component **5** was obtained via a Grignard reaction with allylbromide **6** and a subsequent transmetallation with BF_3 etherate. In a next step, borane **5** and boron trichloride formed an allylboron dichloride species which could react further with amine **4** to diallylaminoborane **7**. The final ring formation towards the azaborine precursor **8** was carried out by a ring-closing metathesis (**Scheme 11**).



Scheme 11. Synthetic route to the azaborine precursor **8** by L. Dölger.⁷³

As one result of this work, the oxidative dehydrogenation was proven to be the main difficulty within the synthetic route. Oxidation of the alkylated azaborine precursor **9** by using common and usually effective systems (Pd black/cyclohexene) led to an unsatisfactory conversion that implicate an impossible separation of product **10** and starting material **9** by any practical methods (**Scheme 12**).



Scheme 12. This approach failed to aromatise a precursor for a monomer towards a conjugated polymer by L. Dölger.⁷³

3.2.1 Optimisation of the Oxidative Dehydrogenation towards 1,2-Azaborines

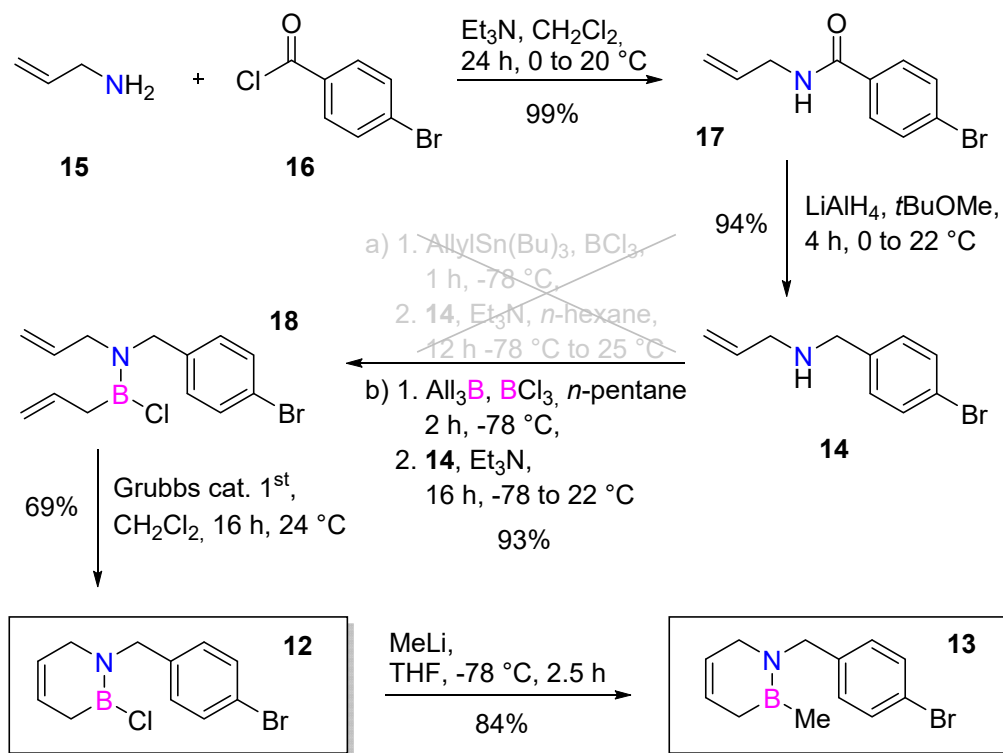
The oxidation step is the bottleneck reaction for reaching the aim of obtaining the 1,3-substituted azaborine and consequently the corresponding polymers. That is why it was necessary to investigate and optimise the oxidative 1,2-dehydrogenation. Compared to the methyl-substituted 1,2-azaborine precursor **11** (see **Table 1** and **Chapter 3.3**) which is convertible into the aromatic compound **P2-1** by using Pd black in cyclohexene, obvious differences are: firstly the electronic properties of the substituents, secondly the increased steric hindrance and thirdly the bromide functional group.

To investigate the electronic influences of the *N*-substituent on the oxidative step, the sterically similar but CH_2 -bridged 4-bromobenzyl substituted azaborine precursor **12** was synthesised as well as the B-Me analogue **13** (**Scheme 13**).

The synthesis of the amine species **14** was performed via a substitution reaction of allylamine (**15**) and the benzoyl chloride **16** to compound **17** followed by a reduction in excellent yields of 99% and 94%, respectively (see **Chapter 3.1** for the optimisation of the process). For the additional step to aminoborane **18**, a reported procedure by Ashe and Fang was adapted to our system.⁶² Allyltributylstannane as reagent led to by-products which could not be separated from the product **18** by distillation or crystallisation. Because of this, an alternative route similar to Lamm's general procedure was applied.⁷⁴ Here, triallylborane (synthesis: see **Chapter 5.3.1**) was used as a reagent with a lower molecular weight generating thus less heavy by-products. This synthesis yielded in 93% of a crude mixture with the desired aminoborane **18** and 12% by-product. The isolation by distillation of **18** was not feasible because of the vacuum limitation.^a Using the crude mixture, a following ring-closing metathesis to the final 1,2-

^a Our Kugelrohr apparatus with connected equipment is limited to a vacuum of approx. 8×10^{-2} .

azaborine precursor **12** resulted in a yield of 69% after sublimation. A further methylation with methyl lithium in THF opened access to the precursor **13** which is an electronically similar and easier accessible prototype of the *n*-hexyl substituted azaborine precursor **9** of the bachelor's thesis of L. Dölger. Furthermore, the oxidation test reaction of **13** revealed deeper insight into influences on the dehydrogenation reaction of 1,2-azaborines (**Scheme 13**).



Scheme 13. Synthetic route to the 4-bromobenzyl substituted azaborine precursors **12** and **13** for investigating different influences on the dehydrogenation process; synthesis of triallylborane: see **Chapter 5.3**.

Starting from compounds **12** and **11**, reaction conditions for the oxidative dehydrogenation were screened based on the common oxidising agent DDQ (**Table 1**).^{62,75}

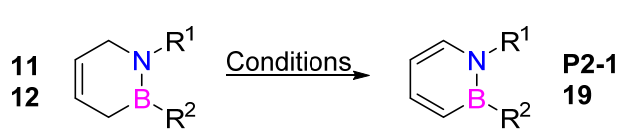
Owing to promising results for DDQ as oxidant applied to similar compounds in the literature,^{62,75,76} these successful reaction conditions were transferred to the 4-bromobenzyl-substituted aminoborane **12**. A first attempt in *n*-hexane at 25 °C showed low solubility of DDQ and consequently a low conversion of 7% after 48 h (**Table 1, Entry 1**). However, only one decomposition product was obtained by changing the solvent to CH_2Cl_2 to increase the solubility of DDQ (**Table 1, Entry 2**). A similar result was obtained by trying to oxidise the methylated aminoborane **11** by DDQ in toluene at 21 °C for 1 h (**Table 1, Entry 3**). The increase in

3 Results and Discussion

temperature under microwave conditions again led to a full degradation of the starting material to undefined products (**Table 1, Entry 4**). In comparison to **Entry 1** of **Table 1**, twice the amount of the oxidant in *n*-hexane and an increase in temperature to 120 °C under microwave conditions even decreased the detectable amount of the product (**19**: 7%, **P2-1**: 0%).

Table 1. Oxidative dehydrogenation approaches with DDQ as oxidising agent.

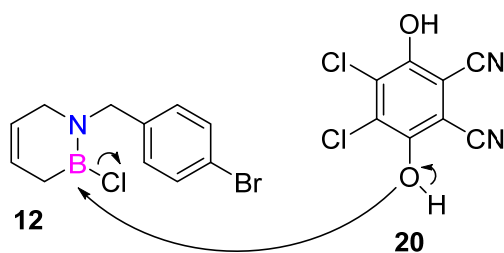
Entry	Starting material	Conditions	Conversion ^a
1	12	1 eq. DDQ, <i>n</i> -hexane, 25 °C, 48 h	7%
2	12	1 eq. DDQ, CH ₂ Cl ₂ , 25 °C, 48 h	- ^b
3	11	1 eq. DDQ, toluene, 21 °C, 1 h	- ^b
4	11	1 eq. DDQ, toluene, 80 °C, 4 h, MW	- ^b
5	11	2 eq. DDQ, <i>n</i> -hexane, 120 °C, 2.5 h, MW	0%
6	11	2 eq. DDQ, CH ₂ Cl ₂ , 60 °C, 1 h, MW	- ^{b,c}


12, 19: R¹ = 4-BrBn, R² = Cl
11, P2-1: R¹ = Me, R² = Cl

^a conversion measured by ¹H NMR of the crude mixture based on remained starting material (not isolated); ^b no starting material left, possibly due to degradation; ^c no signals in ¹H and ¹¹B NMR in crude mixture anymore.

Improved solubility of DDQ by changing the solvent to dichloromethane led to the immediate degradation of aminoborane **12** as well **11** (**Table 1, Entry 2 and 6**), which probably occurred by reaction with the already reduced DDQ **20** (**Scheme 14**).^a In conclusion, it turned out that DDQ is no practical reagent for oxidative 1,2-dehydrogenation to azaborines containing both a sterically demanding *N*-substituent and a highly reactive boron chloride bond. Both substituents are crucial differences to the reported starting materials bearing a phenyl group or double bond.^{62,75,76}

^a Reactions of boron chlorides with phenolic hydroxyl groups: Seven, Ö.; Bolte, M.; Lerner, H.-W.; Wagner, M. *Organometallics* **2014**, *33*, 1291.



Scheme 14. Possible attack of the reduced DDQ as by-product with aminoborane; partial reduced DDQ is also considerable.

In view of the sensitive chloride function, palladium in combination with cyclohexene as a hydride acceptor appeared to be a more compatible system.^{52-54,64,74,77,78} In case of the 4-bromophenyl-substituted aminoborane **8**, which was synthesised during L. Dölger's bachelor's thesis,⁷³ these reaction conditions resulted in a conversion of 21% after 20 h under reflux at ambient pressure (**Table 2, Entry 1**). In my work, applying microwave conditions allowed higher temperatures and pressures, which accelerated the conversion towards **21** and increased the amount of azaborine up to 26% after 1 h, but additional 3 h reaction time raised the yield only up to 29%. Visual inspection of the reaction mixture showed agglomerated Pd black (**Table 2, Entry 2**). Similar reaction conditions for dehydrogenation towards the 4-bromobenzyl-substituted azaborine **19** led to both a conversion of 13% and agglomeration of Pd black after 4 h. (**Table 2, Entry 3**).

Comparison of benzyl- and phenyl-substituted aminoboranes (**12** and **8**) revealed a significant difference in conversion, although the molecules differ only by a CH₂ spacer. The substitution of chloride by a methyl group on the boron site further inhibited the dehydrogenation reaction. Only 9% of aminoborane **13** was converted to the corresponding azaborine **22** (**Table 2, Entry 4**). Comparison of oxidation towards azaborines **19** and **21** (**Table 2, Entry 3** and **2**) to the easy accessible methyl-substituted azaborine **P2-1** (88% conversion, **Table 2, Entry 5**) under same conditions suggests a hindered oxidation by bulky substituents on the nitrogen site (c.f. **Chapter 3.3**). Furthermore, a ¹H NMR spectrum of the crude reaction mixture revealed a high amount of formation of benzene during this reaction, possibly by simultaneous oxidative dehydrogenation of cyclohexene (**Table 2, Entry 5**).

Beside electronic and steric differences between the well convertible *N*-methyl-substituted azaborine precursor **11** and the 4-bromobenzyl- or 4-bromophenyl-substituted aminoborane (**12** and **8** respectively), the bromide functional group on the *N*-substituent could play a crucial

role for the oxidative dehydrogenation by Pd black in cyclohexene. Influences by halogen-halogen bridges,^{79,80} halogen-hydrogen bridges,⁸¹ halogen-nitrogen bridges⁸² or catalyst poisoning^{83,84} are conceivable. The halogen-halogen bridges are already excluded by the oxidation approach of the methylated bromobenzyl-aminoborane **22** (**Table 2, Entry 4**), because the missing chloride on the boron atom is preventing effects on the aminoborane ring by intermolecular halogen-halogen bonds. Consequently, the conversion should be increased and not decreased to 9%. A final test, by adding one equivalent bromobenzene to the active reaction mixture of the N-methylated aminoborane and Pd black in cyclohexene, a strong inhibition or even complete poisoning of the palladium catalyst by the arylbromide was observed: without bromobenzene, the mixture showed 88% conversion of starting material (**Table 2, Entry 5**). However, in the presence of bromobenzene, there was no conversion and the palladium catalyst was visibly agglomerated after a short time after adding the arylbromide (**Table 2, Entry 6**). In addition, the ¹H NMR spectrum of the crude mixture (**Figure SI- 29**) showed only approximately 60% remaining bromobenzene, which gave rise to the suspicion that 40% bromobenzene was now adsorbed on or reacted with 20% Pd black (bromobenzene : Pd = 2 : 1) – possibly by insertion of Pd into the aryl-Br bond.⁸⁵ Additionally, this finding could explain the fast agglomeration of Pd black with arylbromide functionalised azaborine precursors at least in cyclohexene as solvent. For a final answer, further investigations need to be done.

Table 2. Oxidative dehydrogenation approaches with palladium as hydride transfer reagent in cyclohexene.

Entry	Starting material	Conditions	Conversion ^a
1	8	50 mol% Pd black, cyclohexene, 83 °C, 20 h	21% ^{b,c}
2	8	20 mol% Pd black, cyclohexene, 4 h, 180 °C, MW	29% ^c (1 h: 26%)
3	12	20 mol% Pd black, cyclohexene, 1 h, 200 °C, MW	13% ^c
4	13	20 mol% Pd black, cyclohexene, 4 h, 180 °C, MW	9% ^c
5	11	20 mol% Pd black, cyclohexene, 4 h, 120 °C, MW	88% ^e (71% yield) ^d
6	11	20 mol% Pd black, 1 eq. bromobenzene cyclohexene, 4 h, 120 °C, MW	0% ^c

^a conversion measured by ¹H NMR of the crude mixture based on remained starting material (not isolated); ^b carried out by Dölger⁷³ ^c Pd was agglomerated; ^d isolated yield after purification by Kugelrohr distillation; ^e Pd is not agglomerated, cyclohexene is also nearly fully converted.

Since Iosub and Stahl described a significant difference between the nonpolar mesitylene and the polarised chlorobenzene as solvent for their aerobic oxidative dehydrogenation reactions based on palladium catalysts,⁸⁶ the solvent was changed to chlorobenzene for further tests. This solvent cannot serve as a hydrogen acceptor like cyclohexene, but it allows much higher reaction temperatures. Thus, this treatment could improve the disproportionation reaction in which the aminoborane is both oxidant and reductant. Due to that, aminoborane **12** was tried to dehydrogenate by palladium black in chlorobenzene. These conditions led to a conversion of 27% after 4 h at 220 °C under microwave conditions, which was measured by taking a sample from the crude mixture (**Table 3, Entry 1**). This ¹H NMR spectrum showed no significant

3 Results and Discussion

signal for the CH_2 protons of a reduced species **23** which should exist in same amounts in the mixture due to disproportionation (**Figure 11**).

Table 3. Oxidative dehydrogenation approaches with palladium as hydride transfer reagent in chlorobenzene.

Entry	Conditions	Conversion ^a
1	20 mol% Pd black, chlorobenzene, 4 h, 220 °C, MW	27% ^b
2	20 mol% Pd black, chlorobenzene, 4 h, 220 °C, additional 6 h, 250 °C, MW	58% ^b
3	20 mol% Pd black, chlorobenzene, 24 h, 250 °C, MW	66% ^b

$R^1 = 4\text{-BrBn}, R^2 = \text{Cl}$

^a Conversion measured by ^1H NMR of the crude mixture based on remained starting material (not isolated); ^b Pd is not agglomerated as for cyclohexene as solvent.

On account of no obvious agglomeration of Pd black, the mixture was heated under microwave conditions for additional 6 h at an even higher temperature of 250 °C. The increased conversion (58%) proved that the surface of palladium was still intact (**Table 3, Entry 2**). Beyond this, the conversion passed 50%, which should be the maximum for a disproportionation reaction. One reason could be that the commercially available extra dry chlorobenzene, which was packed under inert gas, was not absolutely oxygen-free. The oxygen can possibly serve as co-oxidant as described by Iosub and Stahl and therefore the conversion could pass the 50% mark.⁸⁶ The suspicion is intensified by a further approach, in which the reaction was carried out for 24 h without interruption and resulted in 66% of conversion (**Table 3, Entry 3**). This result is only explicable by side-reactions of **12** which would lower the remaining amount in the crude mixture and consequently give a wrong ratio of starting material and product. On a closer examination of the ^1H NMR spectrum of the approach that yielded 66% (**Figure SI- 33**), it was clearly visible that the signals of chlorobenzene (solvent) changed. This observation points to reactions of this aryl chloride, for example palladium-catalysed coupling reactions with elemental palladium.^{87,88} Assuming that the oxidation state of palladium could have

changed during the reaction, homocoupling of the aryl bromide moieties (*N*-substituent) could have taken place.⁸⁹ These different side reactions and consequently a range of side products could explain the two further proton signals of the benzylic *N*-CH₂ group in the ¹H NMR spectrum of the crude mixture (**Figure SI- 33**). If these signals corresponded to a non-oxidised azaborine species, then it would also support the apparently decreased starting material amount in the crude mixture (see above).

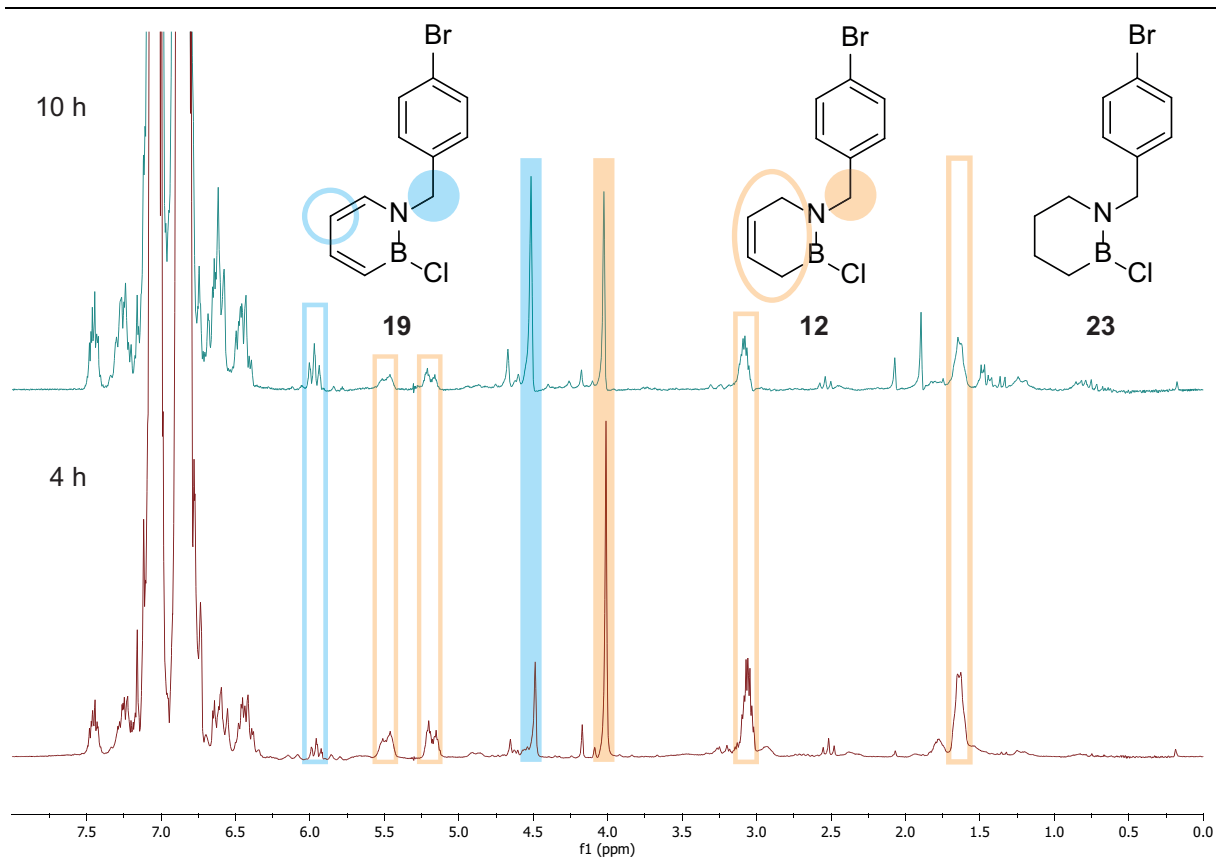


Figure 11. ¹H NMR spectra comparison of the crude mixtures of the dehydrogenation reactions after 4 h and 10 h (additional 6 h) shows only main signals for the aromatised product **19** and the starting material **12**.

Surprisingly, the mass of the product **19** and its expected hydrolysed derivative **24** were found in the GC-MS spectrum of the crude mixture (palladium was separated by filtration), although the azaborine **19** was expected to be highly sensitive to hydrolysis. Azaborine **P2-1** (**Table 2, Entry 5**) was not observable in GC-MS. This result supported the existence of **19** after dehydrogenation process (**Figure 12**).

However, the isolation of azaborine **19** by sublimation at 120 °C and 8×10^{-2} mbar did not lead to success. This isolation procedure was accompanied by decomposition reactions. Evidence for this was that a broad proton signal at approx. 9.7 ppm appeared in the first (**Figure SI- 35**)

and second (**Figure SI- 36**) fraction of the Kugelrohr sublimation. Beyond that, the benzylic CH_2 proton signal of the starting material **12** was missing in both sublimation fractions and the CH_2 proton signal adjacent to the boron atom remained. Thus, these results give rise to the suspicion that the N-C bond between the 4-bromobenzyl-substituent and the N-B cycle is unstable under these conditions.

A separation of the species in the crude mixture is discernible between both fractions. However, another isolation method or procedure has to be developed for this case. The GC-MS trace gave clear evidence for a possible separation of this azaborine by chromatography with specifically treated columns (**Figure 12**). This measurement resulted in three main signals in the GC trace, which were identified as the desired product **19**, the starting material **12** and a methoxy-substituted azaborine **24**. Here, it seems reasonable to assume that a partial methoxy-substitution of **19** took place by remaining traces of methanol in the injection needle, which served as standard washing solvent. The resulting hydrolysed species could then have reacted with CH_2Cl_2 to **24** before or after injection into the GC-MS apparatus. Consequently and with the assumption that the detectability of all three compounds is nearly equal, the peak areas reveal a clear surplus of product **19** in the crude mixture. This result would be in agreement with the detected integrals of the crude 1H NMR spectrum (**Figure SI- 33**).

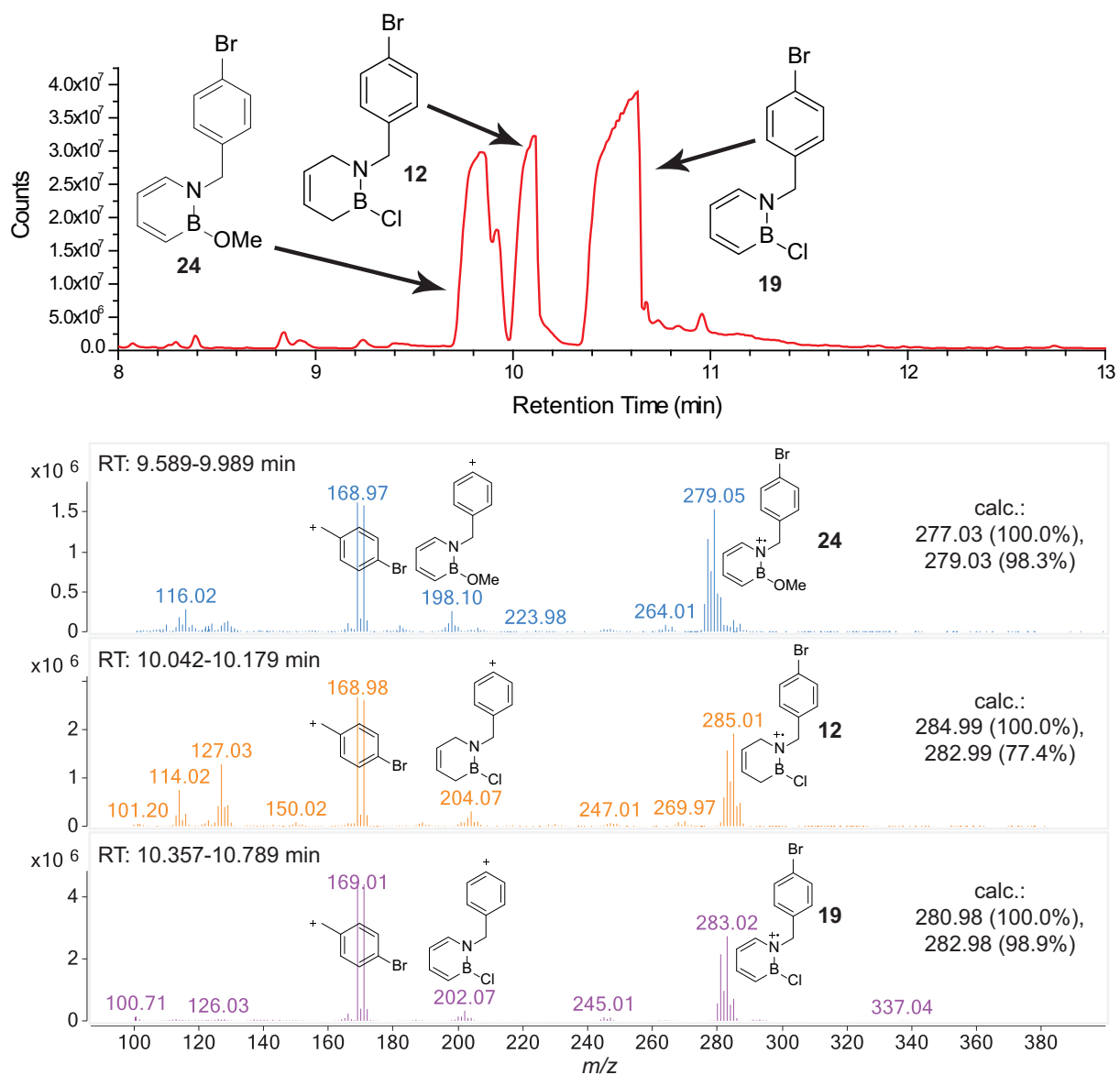


Figure 12. Section of the GC-MS trace of the crude mixture (measured in CH₂Cl₂) after 24 h dehydrogenation reaction of **12** with Pd black in chlorobenzene (**Table 3, Entry 3**) shows clear evidence of the desired product **19**; for a full GC trace see **Figure SI- 43**.

3.3 1,2-Azaborine Vinylpolymers

3.3.1 First *N*-Methyl-2-vinylazaborine Polymer and Copolymer

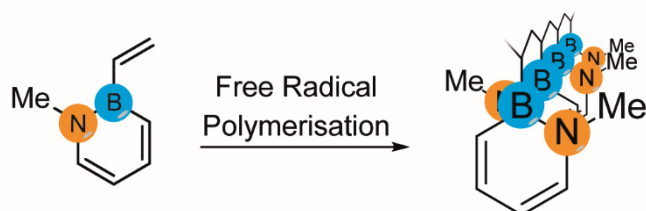
“High molecular weight poly(*N*-methyl-*B*-vinylazaborine) – a semi-inorganic B-N polystyrene analogue”

Thiedemann, B.; Gliese, P. J.; Hoffmann, J.; Lawrence, P. G.; Sonnichsen, F. D.; Staubitz, A. *Chem. Commun.* **2017**.

Reprinted with permission from The Royal Society of Chemistry. © 2017 The Royal Society of Chemistry.

DOI: 10.1039/C6CC08599G

Abstract: We present the synthesis of a B–N analogue of polystyrene, poly(*N*-methyl-*B*-vinylazaborine) in high molecular weight ($M_w = 24.9$ kDa). Furthermore, it was possible to prepare a copolymer with the C–C analogue. A thorough comparison between the polymers by NMR spectroscopy, TGA, DSC and GPC showed significant differences between these polymers.



TOC Graphic 2. The published poly(vinylazaborine) was synthesised by free radical polymerisation.

Scientific contribution to this paper

In this project, I carried out all syntheses and experimental work with the support of following coauthors: P. J. Gliese reproduced the polymer syntheses, J. Hoffmann performed additional calculations for interpretation purpose within the revision process, P. G. Lawrence contributed the ^{11}B NMR studies of the polymers, F. D. Sönnichsen recorded all other NMR spectra. A. Staubitz and I wrote the communication together.



ChemComm

COMMUNICATION

View Article Online
View Journal

Cite this: DOI: 10.1039/c6cc08599g

Received 25th October 2016,
Accepted 22nd December 2016

DOI: 10.1039/c6cc08599g

www.rsc.org/chemcomm

High molecular weight poly(*N*-methyl-*B*-vinylazaborine) – a semi-inorganic B–N polystyrene analogue†

Birk Thiedemann,^{abc} Philipp J. Gliese,^{abc} Jonas Hoffmann,^c Paul G. Lawrence,^d
Frank D. Sönnichsen*^c and Anne Staubitz*^{abc}

We present the synthesis of a B–N analogue of polystyrene, poly(*N*-methyl-*B*-vinylazaborine) in high molecular weight ($M_w = 24.9$ kDa). Furthermore, it was possible to prepare a copolymer with the C–C analogue. A thorough comparison between the polymers by NMR spectroscopy, TGA, DSC and GPC showed significant differences between these polymers.

Polyolefins, among them polystyrene (PS) and polystyrene analogues, are the most important industrial polymers. Due to the unparalleled number of available polymerisation techniques, there is an ongoing quest for the development of analogues of styrene that can be polymerised under well-established conditions, yet leading to entirely new polymers with new functions.¹ There are still relatively few semi-inorganic monomers, mainly due to their synthetic accessibility. The range of inorganic motifs in the ring of PS analogs reaches from phosphorus,^{2–4} silicon^{5,6} to sulfur.^{7–9}

Despite a long standing interest in the isoelectronic relationship between group 13–group 15 bonds (*i.e.* boron–nitrogen (B–N) or boron–phosphorus (B–P)) and carbon–carbon (C–C) bonds, and increasing research efforts to create analogues,^{10–13} non-olefinic polymers based on B–N compounds are still rarely reported: azaborines have been successfully introduced into the main chain of short semiconducting polymers,¹⁴ polyaromatic B–N containing monomers have been polymerised¹⁵ and aromatic rings have been interspersed with B–N^{16,17} or N–B–N motifs.¹⁸ Polyolefin analogues are equally scarce: well-defined polyaminoboranes^{19–21} or polyphosphinoboranes^{22–25} have been developed. A further exciting development was the synthesis of poly(*B*-vinylborazine) by

Sneddon, using a radical polymerisation.²⁶ This polymerisation was remarkable in that borazine itself is not a thermally very stable heterocycle, but it can dehydrocouple under loss of hydrogen. The paper by Sneddon shows very convincingly how this may lead to light cross-linking of the material. However, polymers with an all carbon–polyolefin backbone, but a B–N containing aromatic heterocycle (as opposed to borazinyli) in the side chain, as analogues of PS, are not available so far.

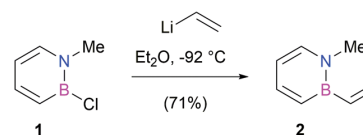
Herein we report a novel azaborine analogue of polystyrene – a poly(vinylazaborine).²⁷

The synthesis of a suitable monomer was possible by modifying routes to azaborines that have been developed by Liu and co-workers.²⁸ An azaborine **1** that is chlorinated at the boron atom easily undergoes nucleophilic substitution with vinyl lithium in a good yield of 71% (Scheme 1, for experimental details see ESI†).

We specifically decided to use an *N*-methylated monomer, because we suspected that a hydrogen atom in this position might lead to future chemical complications as it could be easily abstracted as a proton (with a view for developing anionic polymerisations in the future).²⁹ More importantly for this work, the methyl group would provide an NMR spectroscopic probe to analyse the polymer product in terms of tacticity of the backbone.

The vinylazaborine polymer **3** was prepared by a free radical bulk polymerisation with 2,2'-azobis(2-methylpropio-nitrile) (AIBN) as a radical starter at 85 °C (Scheme 2).

During the reaction, the mixture turned increasingly viscous, which was a good indication that a high molecular weight polymer



Scheme 1 Synthesis of the monomer **2** by nucleophilic substitution of the *B*-chlorinated azaborine **1** in a yield of 71%.

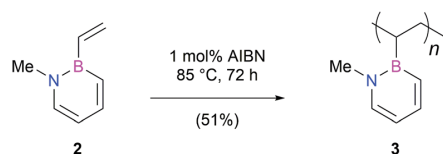
^a Institute for Organic and Analytical Chemistry, Leobener Str. NW2C, University of Bremen, 28359 Bremen, Germany. E-mail: staubitz@uni-bremen.de

^b MAPEX Center for Materials and Processes, University of Bremen, Bibliothekstraße 1, 28359 Bremen, Germany

^c Otto-Diels-Institute for Organic Chemistry, University of Kiel, Otto-Hahn-Platz 4, 24098 Kiel, Germany. E-mail: fsoennichsen@oc.uni-kiel.de

^d School of Chemistry, University of Bristol, Cantock's Close, Bristol BS8 1TS, UK

† Electronic supplementary information (ESI) available: Detailed experimental procedures, images of all spectra, thermoanalytical measurements, GPC data. See DOI: 10.1039/c6cc08599g



Scheme 2 Synthesis of the new B–N polystyrene analogue **3** by free radical polymerisation of **2** in a yield of 51%.

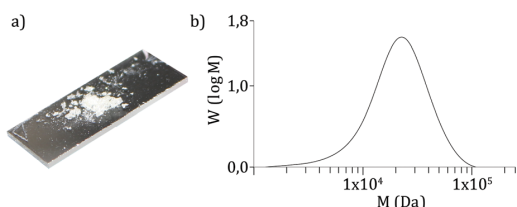


Fig. 1 (a) Photographic image of PNMe2VAB **3** on a glass slide on a black background; (b) GPC mass distribution curve (universal calibration; polystyrene standards, eluent THF with 1 mL min⁻¹).

had been formed. After 72 h reaction time, the crude product was dissolved in toluene (it was also well soluble in CH₂Cl₂, CHCl₃ and benzene) and subsequently precipitated into methanol to give a colourless solid (Fig. 1a) which was investigated by NMR spectroscopy, IR spectroscopy, differential scanning calorimetry (DSC), thermogravimetric analysis (TGA) and gel permeation chromatography (GPC) (Fig. 1b).

In the ¹¹B NMR spectrum, the polymer showed a single broad peak at *ca.* $\delta = 44$ ppm (Fig. S20, ESI[†]). This is very similar to the observation by Jäkle and Liu and co-workers.³⁰ ¹H NMR spectroscopy revealed more structural features. Despite prolonged exposure to a vacuum (*ca.* 10⁻² mbar, 40 °C, 24 h), residual solvent (toluene) from the precipitation procedure was still detectable, which suggested that it is confined by the 3D arrangement of the polymer chains. The ¹H NMR spectrum of **3** showed very broad signals in the aromatic range as well in the aliphatic region, which is a typical feature of polymers. A small high-field shift of the proton signals in the aromatic ring compared to monomer **2** was observed (Fig. 2a and b).

Three clearly separated proton signals of the methyl group (2.5–3.4 ppm) revealed at least three evidently different magnetic environments. However, these three peaks display a finer substructure, indicating that in addition to tacticity, more structurally different environments might be present (Fig. 2b). The ¹³C{¹H} NMR spectrum (Fig. S17 and S19, ESI[†]) showed also a threefold separation for the CH₃ signal; this feature could also be identified for the CH₂ signal, which was less well separated in the case of the ¹H NMR spectrum. The aromatic carbon signals also show several peaks (Fig. S18, ESI[†]).

For this polymer, a number of different configurations are conceivable: first, different sequences of *meso* (m) and *racemo* (r) (mm, rm/mr, rr) diads (Fig. 3a), which is typical for all polyolefins with atactic chains. Secondly, however, two different orientations of the methyl group with respect to consecutive monomer

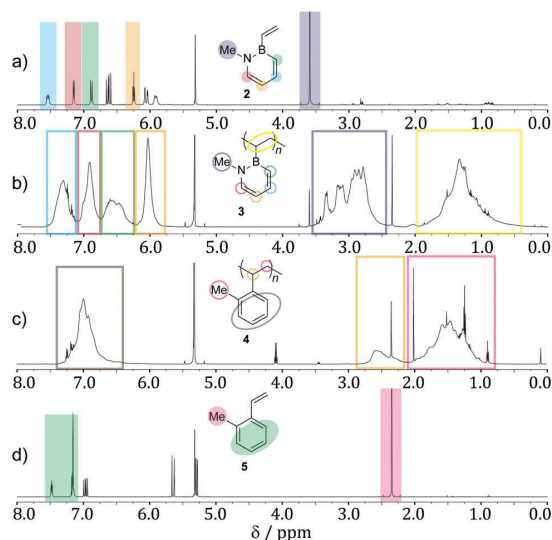


Fig. 2 ¹H NMR spectra to compare the homopolymers **3** and **4** with the monomers **2** and **5**. All spectra were recorded at 300 K, 500 MHz in CD₂Cl₂.

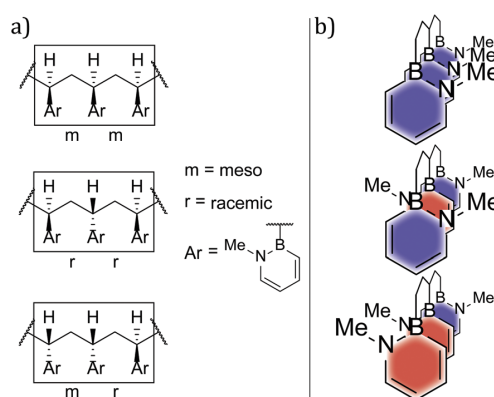


Fig. 3 (a) Possible triads in PNMe2VAB (**3**); (b) conceivable methyl group orientations (simplified backbone).

units may lead to three further local environments (Fig. 3b). Furthermore, the dipole character of the B–N bond should affect the intra- as well as the intermolecular distance between the aromatic rings, in which intramolecular interaction could cause a significant shift of the methyl proton signal.

The molecular weight of the polymer **3** was analysed by (GPC) using universal calibration and THF as an eluent. Assuming a random coil under these conditions, the polymer was determined to have a weight average molecular weight of $M_w = 25$ kDa and a polydispersity index (PDI) of 1.5 (Table 1). Dynamic scanning calorimetry of PNMe2VAB (**3**) with a heating rate of 8 K min⁻¹ (Fig. S26, ESI[†]) showed a glass transition temperature (T_g) of 85 °C; thermogravimetric analysis (TGA) under nitrogen revealed a decomposition temperature of 380 °C

Table 1 Overview of the polymerisation results

Entry	Polymer	Conversion [%]	Yield [%]	M_w^a (kDa)	PDI ^a	T_g [°C]	T_d [°C]	$\lambda_{(\max)}$ [nm]
1	PNMe2VAB 3	89	51	24.9	1.51	85	380	279
2	PNMe2VAB/P2MeS 6	72/99 ^b	86	36.9	1.69	114	378	279
3	P2MeS 4	92	87	86.0	1.84	132	365	265

^a Values are presented as universal/standard calibration against polystyrene. ^b Conversion of each co-monomer (2/5) due to different reaction rates.

(Table 1; entry 1). However, in air, the polymer gradually decomposed to give an insoluble brown solid (Fig. 4).

In order to assess the influence of the B–N substitution compared to the C–C analogue, we also synthesised the carbon equivalent of PNMe2VAB 3–poly(2-methylstyrene) (P2MeS, **4**) under the same conditions and characterised it. A higher weight average molecular weight of $M_w = 86$ kDa (PDI = 1.84) was found (Table 1; entry 3). Compared to the proton signals of monomer **5** (Fig. 2d), all of the P2MeS **4** signals were up-field shifted (Fig. 2c). In contrast to PNMe2VAB **3** no clear separation of the CH_3 signals in different tactic environments was observable. The alkyl signals of the CH proton at 2.1–2.8 ppm were broad and those of the CH_3 at 0.9–2.1 ppm were equally wide with little fine structure (Fig. 2b and d). Unsurprisingly, this polymer was stable in air and showed no discolouration (Fig. 4c). The glass transition temperature of 132 °C and the decomposition temperature of 365 °C was consistent with other reports.^{31–33} We hypothesise that the significantly lower glass transition temperature of PNMe2VAB is due to a decreased order of the system in the solid state. Because the polymer backbone is always attached to the boron atom, the dipoles of the azaborines are likely to push these side chains away from one another, decreasing stacking interactions.

An interesting comparison can be made with the T_g of poly(2-vinylpyridine) (P2VP), which is perhaps the electronically most similar organic polymer to PNMe2VAB **3**.^{34–36} A polymer of similar length (30 kDa) was reported to have a T_g of ca. 94 °C³⁷ compared to a T_g of PS with 35 kDa at ca. 103 °C.³⁸ This means that the substitution of one CH by an N has just little effect on the chain mobility in the solid state; however if an additional boron atom replaces a carbon atom as in our material, the effect is substantial (for BN vs. CC $\Delta T_g = 47$ K in our case).

This also suggested that copolymerisation – if possible – might be used to tune the materials properties. To explore the copolymerisation ability of NMe2VAB, we polymerised it with 2MeS in a ratio of 1 : 1 under same conditions as for the homopolymerisations. We received a polymer with a weight average molecular weight of $M_w = 36.9$ kDa (PDI = 1.69) and a T_g of 114 °C (Table 1; entry 2) which was between both homopolymers **3** and **4**.

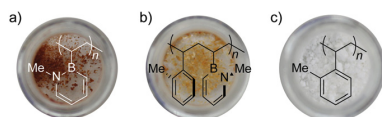


Fig. 4 Photographic images of PNMe2VAB (**3**; left; brownish red), PNMe2VAB/P2MeS copolymer (**6**; center; orange) and P2MeS (**4**; right; colourless) after 72 h under air conditions.

According to the calculation based on the aromatic range integrals of the 1H NMR spectrum, **6** had a composition of approx. 3 : 2 (monomer **5** : monomer **2**). Surprisingly, the splitting pattern of the CH_3 signal of **3** (2.5–3.4 ppm) was not present in the copolymer, which is indicative of very few adjacent azaborine units; the monomer distribution in the polymer must therefore be relatively random with only some gradient character. This assumption was supported by comparison of the $^{13}C\{^1H\}$ NMR spectra. The threefold splitting pattern of the CH_3 signal (41.5–40 ppm) and the CH_2 signal (28.5–27.0 ppm) in **3** (Fig. S48, blue, ESI[†]) was not present in the copolymer **6** (Fig. S48, red, ESI[†]). This may be explicable by the missing NMe2VAB–NMe2VAB sequence. However, four new signals for the new 2MeS–NMe2VAB–2MeS sequence appeared (41.0, 37.5, 26.0 and 24.0 ppm) beside the still present 2MeS–2MeS sequence signals (Fig. S48, red and green, ESI[†]). For such a random polymer to form, the rates of polymerisation of the two monomers amongst themselves and with one another must be in the same order of magnitude. This was confirmed by monitoring the progress of the separate reactions and mixture of the monomers by 1H NMR spectroscopy (see ESI[†]).

Decomposition under a nitrogen atmosphere was very similar to PNMe2VAB at 378 °C. Under an air atmosphere however, the copolymer changed much more slowly to a brown insoluble solid than PNMe2VAB (Fig. 4). This confirmed a lower percentage of azaborine in the polymer compared to the homopolymer would increase air stability.

In conclusion, the first high molecular weight B–N polystyrene analogue with one C–C replacement in the ring by B–N has been prepared. This was possible by radical polymerisation. The polymer is a white powder and readily forms films. A detailed NMR study revealed that besides different magnetic environments due to tacticity, the arrangement of the heterocycle with respect to the chain also plays an important role. Compared to the C–C analogue, there are fundamental differences in the material's behaviour: while its glass transition is substantially lower, its thermal decomposition temperature under inert conditions is higher. Conversely, however, the C–C analogue is entirely air stable whereas the B–N analogue decomposes gradually. Copolymerisation of the two monomers is facile, leading to a nearly random atactic polymer. This allows the tuning of the materials' properties in copolymers; decomposition in air can be slowed down and the T_g increased. In addition, this study adds to the mounting evidence that the relationship between the heterocycles borazine and azaborine, and benzene, is merely formal; the chemistry and by extension materials science of such compounds is very different.

While this study is of a fundamental character, potential applications for PNMe2VAB may be envisioned. Such types of

polymer could be used for the tuning the properties of vinyl-polymers in copolymers or blends. It is also conceivable to use these polymers as precursors for the incorporation of the B-N motif into carbonised materials.^{39–42} The complexation of anions and incorporation into block copolymers will be analysed in future work.^{41–46}

A. S. and B. T. thank the DFG for funding (Emmy-Noether-Fellowship to A. S.) (STA1195/2-1). This research has been supported by the Institutional Strategy of the University of Bremen, funded by the German Excellence Initiative.

Notes and references

- 1 PlasticsEurope, *Plastics – the Facts 2015*, PlasticsEurope, 2015.
- 2 O. Petreus, E. Avram, G. Lisa and D. Serbezeanu, *J. Appl. Polym. Sci.*, 2010, **115**, 2084–2092.
- 3 A. Chiotis, G. Clouet and J. Brossas, *Polym. Bull.*, 1982, **7**, 83–87.
- 4 J. Furukawa, E. Kobayashi and T. Wakui, *Polym. J.*, 1980, **12**, 277–285.
- 5 Y. Qin, V. Sukul, D. Pagakos, C. Z. Cui and F. Jäkle, *Macromolecules*, 2005, **38**, 8987–8990.
- 6 C. W. Lewis and D. W. Lewis, *J. Polym. Sci.*, 1959, **36**, 325–328.
- 7 M. P. de Jong, L. J. van IJzendoorn and M. J. A. de Voigt, *Appl. Phys. Lett.*, 2000, **77**, 2255–2257.
- 8 A. S. Michaels and R. G. Miekka, *J. Phys. Chem.*, 1961, **65**, 1765–1773.
- 9 H. W. Heuer, R. Wehrmann and S. Kirchmeyer, *Adv. Funct. Mater.*, 2002, **12**, 89–94.
- 10 A. Staubitz, A. P. M. Robertson, M. E. Sloan and I. Manners, *Chem. Rev.*, 2010, **110**, 4023–4078.
- 11 P. G. Campbell, A. J. V. Marwitz and S. Y. Liu, *Angew. Chem., Int. Ed.*, 2012, **51**, 6074–6092.
- 12 X.-Y. Wang, A. Narita, X. Feng and K. Müllen, *J. Am. Chem. Soc.*, 2015, **137**, 7668–7671.
- 13 X. Y. Wang, F. D. Zhuang, X. C. Wang, X. Y. Cao, J. Y. Wang and J. Pei, *Chem. Commun.*, 2015, **51**, 4368–4371.
- 14 A. W. Baggett, F. Guo, B. Li, S. Y. Liu and F. Jäkle, *Angew. Chem., Int. Ed.*, 2015, **54**, 11191–11195.
- 15 X.-Y. Wang, F.-D. Zhuang, J.-Y. Wang and J. Pei, *Chem. Commun.*, 2015, **51**, 17532–17535.
- 16 M. Grosche, E. Herdtweck, F. Peters and M. Wagner, *Organometallics*, 1999, **18**, 4669–4672.
- 17 M. Fontani, F. Peters, W. Scherer, W. Wachter, M. Wagner and P. Zanella, *Eur. J. Inorg. Chem.*, 1998, 1453–1465.
- 18 T. Lorenz, A. Lik, F. A. Plamper and H. Helten, *Angew. Chem., Int. Ed.*, 2016, **55**, 7236–7241.
- 19 A. Staubitz, A. Presa Soto and I. Manners, *Angew. Chem., Int. Ed.*, 2008, **47**, 6212–6215.
- 20 A. Staubitz, M. E. Sloan, A. P. M. Robertson, A. Friedrich, S. Schneider, P. J. Gates, J. S. a. d. Günne and I. Manners, *J. Am. Chem. Soc.*, 2010, **132**, 13332–13345.
- 21 A. P. M. Robertson, E. M. Leitao, T. Jurca, M. F. Haddow, H. Helten, G. C. Lloyd-Jones and I. Manners, *J. Am. Chem. Soc.*, 2013, **135**, 12670–12683.
- 22 H. Dorn, J. M. Rodezno, B. Brunnhofer, E. Rivard, J. A. Massey and I. Manners, *Macromolecules*, 2003, **36**, 291–297.
- 23 C. Marquardt, T. Jurca, K. C. Schwan, A. Stauber, A. V. Virovets, G. R. Whittell, I. Manners and M. Scheer, *Angew. Chem., Int. Ed.*, 2015, **54**, 13782–13786.
- 24 C. Marquardt, T. Jurca, K.-C. Schwan, A. Stauber, A. V. Virovets, G. R. Whittell, I. Manners and M. Scheer, *Angew. Chem., Int. Ed.*, 2015, **54**, 13469.
- 25 U. S. D. Paul, H. Braunschweig and U. Radius, *Chem. Commun.*, 2016, **52**, 8573–8576.
- 26 K. Su, E. E. Remsen, H. M. Thompson and L. G. Sneddon, *Macromolecules*, 1991, **24**, 3760–3766.
- 27 While this work was submitted, a very similar polymer was presented by Jäkle and Liu. These researchers prepared the azaborine monomer without methyl group on the nitrogen, but with a proton in this position, leading to an alteration in the polymer's properties: W.-M. Wan, A. W. Baggett, F. Cheng, H. Lin, S.-Y. Liu and F. Jäkle, *Chem. Commun.*, 2016, **52**, 13616–13619.
- 28 A. J. V. Marwitz, E. R. Abbey, J. T. Jenkins, L. N. Zakharov and S. Y. Liu, *Org. Lett.*, 2007, **9**, 4905–4908.
- 29 The methyl group could potentially be problematic in a radical reaction as a hydrogen atom might be abstracted, leading to chain transfer and thus only oligomers rather than polymers. Such observations have been made by Gates and co-workers (P. W. Siu, S. C. Serin, I. Krummenacher, T. W. Hey and D. P. Gates, *Angew. Chem., Int. Ed.*, 2013, **52**, 6967). This was not observed in our case. For a discussion see the ESI†.
- 30 W. M. Wan, A. W. Baggett, F. Cheng, H. Lin, S. Y. Liu and F. Jäkle, *Chem. Commun.*, 2016, **52**, 13616–13619.
- 31 K. R. Dunham, J. W. H. Faber, J. Vandenberghe and W. F. Fowler, *J. Appl. Polym. Sci.*, 1963, **7**, 897–908.
- 32 L. Costa, G. Camino, A. Guyot, G. Clouet and J. Brossas, *Polym. Degrad. Stab.*, 1986, **15**, 251–264.
- 33 S. L. Malhotra, P. Lessard, L. Minh and L. P. B. Hard, *J. Macromol. Sci., Chem.*, 1980, **14**, 517–540.
- 34 E. F. Kalafus and S. C. Sharma, *U.S. Pat.*, no. 4134869, 1979.
- 35 T. Pietsch, E. Metwalli, S. V. Roth, R. Gebhardt, N. Gindy, P. Muller-Buschbaum and A. Fahmi, *Macromol. Chem. Phys.*, 2009, **210**, 864–878.
- 36 J. F. Gohy, *Block Copolymers II*, 2005, **190**, 65–136.
- 37 P. Papadopoulos, D. Peristeraki, G. Floudas, G. Koutalas and N. Hadjichristidis, *Macromolecules*, 2004, **37**, 8116–8122.
- 38 Hitachi High-Tech Application Brief, *DSC Measurements of Polystyrene – The Effects of Molecular Weight on Glass Transition*, TA No. 68, Hitachi High-Tech Science Corporation.
- 39 B. Jaschke, U. Klingebiel, R. Riedel, N. a. Doslik and R. Gadow, *Appl. Organomet. Chem.*, 2000, **14**, 671–685.
- 40 D. Seyferth, N. Bryson, D. P. Workman and C. A. Sobon, *J. Am. Ceram. Soc.*, 1991, **74**, 2687–2689.
- 41 Y. Kimura, Y. Kubo and N. Hayashi, *Compos. Sci. Technol.*, 1994, **51**, 173–179.
- 42 J.-K. Ewert, C. Denner, M. Friedrich, G. Motz and R. Kempe, *Nanomaterials*, 2015, **5**, 425.
- 43 J. Pan, J. W. Kampf and A. J. Ashe, *J. Organomet. Chem.*, 2009, **694**, 1036–1040.
- 44 J. Pan, J. W. Kampf and A. J. Ashe, *Organometallics*, 2009, **28**, 506–511.
- 45 J. Pan, J. W. Kampf and A. J. Ashe, *Organometallics*, 2006, **25**, 197–202.
- 46 A. J. Ashe, X. D. Fang, X. G. Fang and J. W. Kampf, *Organometallics*, 2001, **20**, 5413–5418.

3.3.2 Comparison of Poly(*N*-methyl-*B*-vinylazaborine) and Poly(*N*-hydro-*B*-vinylazaborine)

After the submission of our publication to *Chem. Commun.*, Wan et al. published the synthesis of a B-N polystyrene, poly(*N*-hydro-*B*-vinylazaborine) (**BN-PS**).^{32, a} Owing to the similarity of both vinylazaborines, **BN-PS** and **P2-3**, a comparison of both could lead to a deeper insight of these types of polymer.

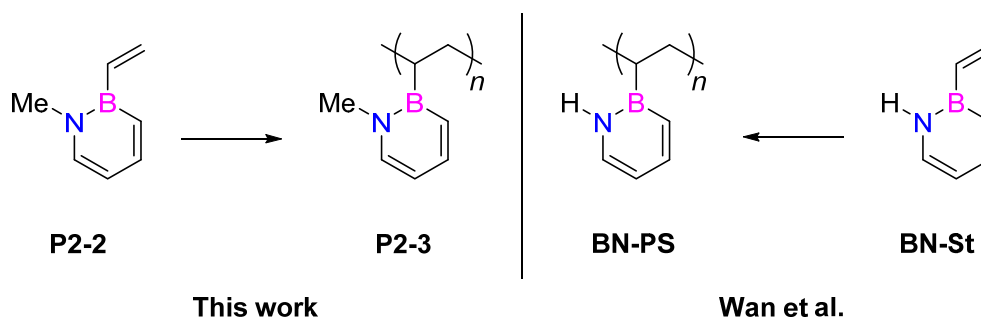


Figure 13. First published vinylazaborines: **P2-3** (this work), **BN-PS** (Wan et al.³²).

Apart from the different synthetic routes to the monomers (**P2-2** and **BN-St**), they differ only in the *N*-substituents, which are a methyl group and a proton respectively. The monomer **BN-St** was hard to polymerise by free radical polymerisation (FRP) and led only to a molecular weight of 6.7 kDa, whereas **P2-2** could be polymerised up to a molecular weight of $M_n = 16.5$ kDa ($M_w = 24.9$ kDa).^b Apparently, the *N*-H-functionality of **BN-St** makes a FRP more difficult than for an *N*-methylated vinylazaborine **P2-2**. Wan et al. detected no conversion of **BN-St** while a FRP attempt in THF and only 48% conversion (low yield of 36%) after 48 h with changing to ACHN as initiator in DMF. In another approach, **BN-St** was polymerised via RAFT polymerisation^c but with even lower conversion (27%), yield (18%) and molecular weight ($M_n = 1.1$ kDa). Here, the acidity of the *N*-H proton and conceivable intermolecular hydrogen bonding interactions could play a crucial role in the polymerisability. For a deeper insight,

^a Abbreviations are from the publication for better comparability: Wan, W.-M.; Baggett, A. W.; Cheng, F.; Lin, H.; Liu, S.-Y.; Jäkle, F. *Chem. Commun.* **2016**.

^b Wan et al. did not explain which calibration method they used and, consequently, molecular weights should be compared with care.

^c For explanation of RAFT polymerisation see **Chapter 2.1.3.1**.

3 Results and Discussion

more studies with monomer **BN-St** and other *N*-H-vinylazaborines have to be carried out. Furthermore, for better comparability, the polymerisations should be performed without solvent to minimise influences.

Despite the hardly comparable results of the polymerisations, the dynamic scanning calorimetry measurements of the polymers **P2-3** and **BN-PS** revealed interesting insights. The glass transition temperature for **P2-3** ($T_g = 85\text{ °C}$) is lower than for **BN-PS** ($T_g = 93\text{ °C}$), despite **P2-3** bearing a bulkier *N*-substituent next to the polymer backbone. Actually, a hindrance in backbone rotation by bulky substituents should increase the T_g .^{29,90} Possibly, the hydrogen bonding interactions limit this backbone rotation, which was already suspected by Wan et al.³²

Table 4. Overview of the analytic data corresponding to the first poly(vinylazaborines) **P2-3** and **BN-PS**.

Polymer	Conversion	Yield	M_n	PDI ^a	T_g	λ_{abs}
P2-3	89%	51%	16.5 kDa	1.51	85 °C	279 nm
BN-PS	48%	36%	6.7 kDa	2.49	93 °C	277 nm

^a PDI = polydispersity index (M_w/M_n); PDI is hardly comparable because of different work-up procedures.

3.4 Cooperation project

3.4.1 Nucleophile-Selective Cross-Coupling Reactions

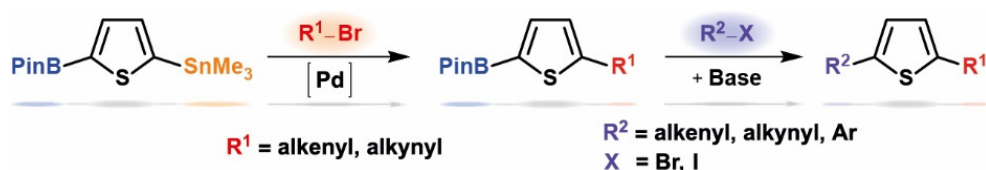
“Nucleophile-Selective Cross-Coupling Reactions with Vinyl and Alkynyl Bromides on a Dinucleophilic Aromatic Substrate”

He, L. Y.; Schulz-Senft, M.; Thiedemann, B.; Linshoef, J.; Gates, P. J.; Staubitz, A. *Eur. J. Org. Chem.* **2015**, 2498.

Reprinted with permission from WILEY-VCH. © 2015 WILEY-VCH Verlag GmbH & Co. KGaA, Weinheim.

DOI: 10.1002/ejoc.201500138

Abstract: A nucleophile-selective cross-coupling reaction on an aromatic compound bearing two metal groups, Bpin and SnMe₃, has been developed. Previously, only aryl bromides and iodides could be used as electrophilic components, but in this work, the scope could be extended to vinyl and alkynyl bromides as electrophiles. This means that the roles typical in Sonogashira couplings or Heck reactions of the aromatic ring as the dielectrophile coupling to vinyl and alkynyl metal species are reversed, which presents a new tool for organic synthesis. The first nucleophilic site to react is the stannyl group, and subsequently, a Suzuki–Miyaura cross-coupling reaction can take place on the same molecule.



TOC Graphic 3. Cross-coupling reactions with vinyl and alkynyl bromides on an aromatic dinucleophile.

Scientific contribution to this paper

In this project, I contributed four syntheses of which only three led to success and were published (syntheses to compounds **P3-7c**, **P3-7d** and **P3-7e**). Furthermore, I designed the TOC graphic. All other experiments and work were done by the other authors.

DOI: 10.1002/ejoc.201500138

Nucleophile-Selective Cross-Coupling Reactions with Vinyl and Alkynyl Bromides on a Dinucleophilic Aromatic Substrate

Lu-Ying He,^[a] Mathias Schulz-Senft,^[a] Birk Thiedemann,^[a] Julian Linshoef,^[a]
Paul J. Gates,^[b] and Anne Staubitz*^[a]

Keywords: Cross-coupling / Palladium / C–C coupling / Chemoselectivity / Sulfur heterocycles

A nucleophile-selective cross-coupling reaction on an aromatic compound bearing two metal groups, Bpin and SnMe₃, has been developed. Previously, only aryl bromides and iodides could be used as electrophilic components, but in this work, the scope could be extended to vinyl and alkynyl bromides as electrophiles. This means that the roles typical

in Sonogashira couplings or Heck reactions of the aromatic ring as the dielectrophile coupling to vinyl and alkynyl metal species are reversed, which presents a new tool for organic synthesis. The first nucleophilic site to react is the stannyl group, and subsequently, a Suzuki–Miyaura cross-coupling reaction can take place on the same molecule.

Introduction

Cross-coupling reactions (CCRs) of organometallic compounds R–M with organic compounds R–X have evolved into powerful and general methodologies for carbon–carbon bond formation.^[1] CCRs pervade all areas of organic synthesis^[2] from the construction of polymers,^[3] pharmaceuticals^[4] to natural products. In many cases, functional group tolerance is high, but to build up complex organic scaffolds, highly selective CCRs are essential. Research on electrophile-selective CCRs [differentiating between R–X¹ and R–X² (X = I, Br, Cl, OTf, etc.)] has been intensively pursued.^[5] For Stille reactions, the order of reactivity of halides is I > Br > Cl.^[6] However, nucleophile-selective CCRs with dimetallic (hetero)-aromatic substrates have been very rarely examined.^[7]

In our group, a nucleophile-selective one pot reaction was developed recently on a new thiophene building block that contains both a stannyl group and a boronic ester functional group.^[7c] Furthermore, this reaction was extended to both nucleophile- and electrophile-selective CCRs with aromatic rings based on a thiophene building block.^[7d] For both reactions, excellent chemoselectivity was observed in Stille CCRs with mono-halogenated or di-halogenated electrophiles in high yields.

However, the two reactions could be carried out only with aromatic electrophiles. As double and triple bonds are also very important functional groups that can be intro-

duced by cross-coupling methods, we now focussed on establishing nucleophile-selective CCRs with halogenated vinyl or alkynyl compounds.

Results and Discussion

As a test reaction, dinucleophilic thiophene **1** was cross-coupled with the commercially available β-bromostyrene (**2a/2a'** = 8:1) in toluene at 80 °C under microwave conditions with [Pd(PPh₃)₄] as the catalyst. After 1 h, the starting material was completely consumed, and the products **3a** and **3a'** were isolated in a combined yield of 36%. Although the reaction was highly selective for the nucleophile and no Suzuki–Miyaura cross-coupling occurred, two major homocoupling byproducts, the biaryl **4** in a yield of 17%, and 1,4-diphenylbutadiene **5** in yield of 10% were isolated. Oxidative homocoupling reactions leading to byproducts such as **4** may occur when oxygen is not rigorously excluded,^[8] but the reactions were performed under nitrogen with rigorous exclusion of air and a repeat experiment yielded similar results. Ozawa and co-workers have recently performed a thorough investigation into a similar reaction:^[9] When (*E*)-β-bromostyrene reacted with phenylboronic acid under Suzuki cross-coupling conditions, they also found substantial amounts of byproduct **5** as an *E/Z* mixture and biphenyl. Their detailed mechanistic studies suggested that oxidative addition of the (*E*)-β-bromostyrene to the Pd-centre was followed by a metathesis reaction with (*E*)-β-bromostyrene leading to the homocoupled styryl–styryl species **5** and [Pd(L)₂Br₂]. The latter may be reduced by the aryl–metal species present, giving rise to biaryl compounds such as **4**. This reactivity was not observed for (*Z*)-β-bromostyrene, because of the higher stability of its oxidative insertion product, (*Z*)-styryl–Pd(L)₂Br, towards reac-

[a] Otto Diels-Institute for Organic Chemistry, University of Kiel, Otto-Hahn-Platz 4, 24098 Kiel, Germany
E-mail: astaubitz@oc.uni-kiel.de
<http://www.otto-diels-institut.de/staubitz/>

[b] School of Chemistry, University of Bristol, Cantock's Close, Bristol BS8 1TS, UK

Supporting information for this article is available on the WWW under <http://dx.doi.org/10.1002/ejoc.201500138>.

tion with another equivalent of (*Z*)- β -bromostyrene. As the relative kinetic stabilities of the intermediates in a catalytic cycle are highly dependent on the reaction conditions, it seemed plausible that this reaction could be optimized to improve the yield of the product and minimize the amount of byproducts. Over 40 different reaction conditions were screened (solvents, catalysts, temperature, catalyst loading, reaction time, concentration; for details see the Supporting Information Table S1), all reactions were monitored and quantified by gas chromatography (GC).

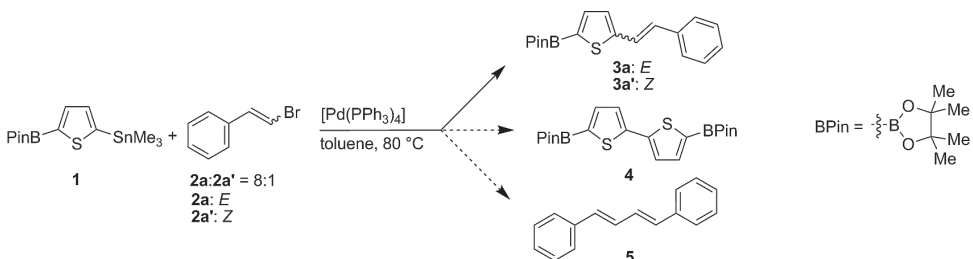
Conversion and yield were highly dependent on the catalysts, solvents and temperature. It emerged that for bidentate and/or very bulky ligands, in the catalysts [Pd(dppe)Cl₂], [Pd(OAc)₂/SPhos], [Pd(dppf)Cl₂] and [Pd(P*t*Bu₃)₂], the yields were low (25, 30, 46 and 39% respectively, Table S1, entries 13–16) because considerable amounts of homocoupled byproducts **4** and **5** formed alongside other non-identified byproducts. Presumably, the intermediate styryl–Pd(L)₂Br species, which forms by oxidative addition, is very reactive towards vinyl bromides in the case of catalysts with bulky ligands. This might be because in the products of the homocoupling reaction, i.e., the complex [PdL₂Br₂] and the byproducts **4** and **5**, steric strain can be released. Therefore, [Pd(PPh₃)₄] as the least hindered catalyst (up to three ligands dissociate)^[10] proved the most suitable catalyst for this reaction (Table 1). Solvent screening of dioxane, toluene, THF, pyridine, acetonitrile and DMF (Table 1, entries 1–6) showed that DMF was the most suitable solvent, giving a combined yield of **3a** + **3a'** of 95% at 60 °C (Table 1, entry 6). However, polarity of the solvent cannot be the only parameter influencing the reaction, because the much less polar toluene, for example, also

gave a good combined yield of **3a** and **3a'** of 66% (Table 1, entry 2). The catalyst loading could be lowered to 1 mol-%, and the product was obtained in 97% yield (**3a** + **3a'**, Table 1, entry 7). The reaction was also efficient at a lower temperature of 40 °C (Table 1, entry 8); whereas 20 °C led to very long reaction times (Table 1, entries 9 and 10). Moreover, at 40 °C, fewer homocoupled byproducts were observed than at 60 °C.

Based on these results, the best reaction conditions for the nucleophile-selective CCR were a catalyst loading of [Pd(PPh₃)₄] as low as 1 mol-% in DMF as the solvent, either at 40 °C or 60 °C. The next aim was to establish whether these conditions would be suitable for a variety of vinyl (Table 2) and alkynyl bromides (Table 3) as electrophiles.

Vinyl bromides were synthesized from corresponding α , β -unsaturated carboxylic acids^[11] or carboxaldehyde^[12] in good yields (see Supporting Information for details). The alkynyl bromides were also easily available in high yields from the corresponding terminal alkynes.^[11] For both types of electrophiles, all reactions were entirely nucleophile-selective (as detectable by GC–MS and NMR spectroscopy) and generally very tolerant towards the electrophiles used. In the case of vinyl bromides, especially for electron-rich compounds, good to excellent yields of the corresponding products were obtained at 40 °C (74–77%; Table 2, **3b**, **3c** and **3e**). However, the amine **3d** could be isolated in only 43% yield because despite the higher temperature of 60 °C and a significantly longer reaction time of 168 h, the conversion to the product was low. Even longer reaction times did not improve the result, which may be caused by the binding of the amine to the Pd centre.^[13] With electron-neutral electro-

Table 1. Optimization of reaction conditions.^[a]

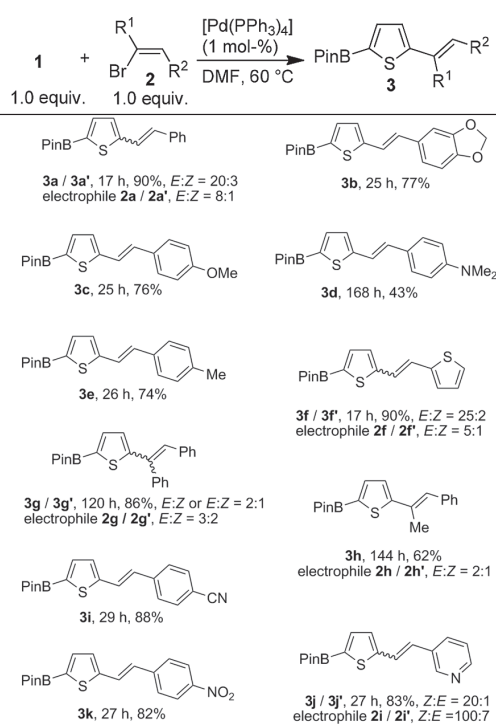


Entry	Solvent	Concentration [mmol/mL]	Cat. loading [mol-%]	<i>T</i> [°C]	<i>t</i> [h]	Conv. ^[b] [%]	Yield [%] ^[c]			
							3a	3a'	4	5
1	Dioxane	0.25	5	60	17	83	51	5	3	0
2	Toluene	0.25	5	60	17	91	59	7	9	6
3	THF	0.25	5	60	17	94	73	8	6	3
4	Pyridine	0.25	5	60	17	93	37	3	16	14
5	MeCN	0.25	5	60	17	100	43	10	22	14
6	DMF	0.25	5	60	17	100	83	12	2	0
7	DMF	0.25	1	60	17	100	86	11	2	0
8	DMF	0.5	1	40	17	96	86	4	1	0
9	DMF	0.5	5	20	17	40	12	0	1	0
10	DMF	0.5	5	20	65	93	70	1	4	0

[a] **1** (1.1 equiv.), **2** (1.0 equiv.). [b] Conversion is based on **2**. [c] Determined by GC with triisopropylbenzene as the internal calibration standard.

FULL PAPER

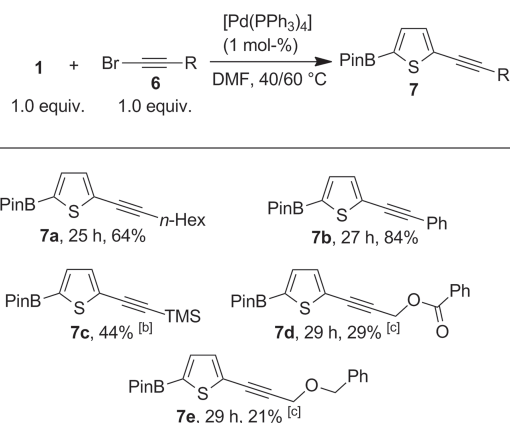
philes, β -bromostyrene **3a** and 2-(2-bromovinyl)-thiophene **3f** also gave good yields of 90%, albeit at 60 °C, i.e., 20 °C higher than for electron-rich vinyl bromides. However, the reaction to form **3g** required about seven times as long as **3e**, which can be attributed to the much greater steric hindrance due to the additional phenyl group geminal to the reacting centre. If the steric hindrance was instead provided by a methyl group (product **3h**), a longer reaction time of 144 h was required. Electron-deficient vinyl bromides gave excellent yields of the products **3i**, **3j** and **3k** in relatively short reaction times of about 30 h (88, 83 and 82%, respectively).

Table 2. Nucleophile-selective CCRs with various vinyl bromides.^[a]

[a] The reactions to obtain **3a**, **3b**, and **3d** were performed at 40 °C.

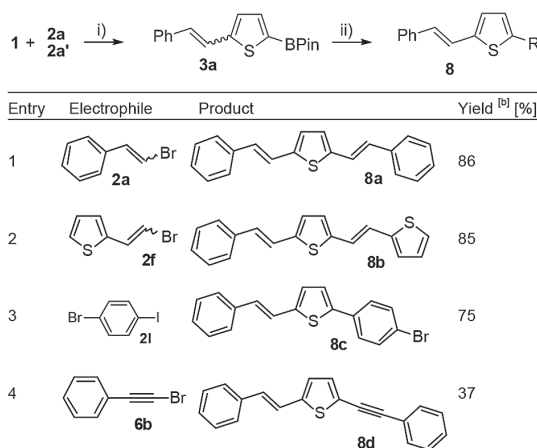
The reaction was further analysed with respect to alkynyl bromides as electrophilic coupling partners (Table 3). For alkynyl bromides with a simple *n*-hexyl (**6a**) or phenyl substituent (**6b**), the reaction gave good yields of 64 and 84%, respectively at 40 °C. However, the reaction with **6c** (*R* = TMS), only afforded **7c** in a yield of 44% (and could only be isolated as a 1:1 mixture with starting material **1**, even at a temperature of 60 °C and a significantly longer reaction time of 168 h). Although no byproduct formation was observed, the reactivity of the electrophilic component was exceedingly low. For **6d** and **6e**, both reactions were complete in 29 h at 60 °C, but the isolated yield was relatively low. In these cases, the issue was not conversion, but purification. Both products decomposed on a silica column, and it was also not possible to purify them by Kugelrohr distillation. This was a general observation for all products of

type **7** (see Supporting Information for details): If Kugelrohr distillation was not possible, then no pure products could be obtained due to over-absorption onto silica gel, possibly due to interactions of the vacant orbital on boron with nucleophilic moieties in silica gel.^[14]

Table 3. Stille CCRs of alkynyl bromides.^[a]

[a] The reactions to obtain **7a** and **7b** were performed at 40 °C, and those for **7c–7e** were performed at 60 °C. [b] As a 1:1 mixture with the starting material **1**. [c] Contains impurities, for details see the Supporting Information.

After the chemoselective Stille CCR, the products still contain a boronic ester functional group, which can be further coupled with a second electrophile by a Suzuki–Miyaura CCR. By merely adding K_2CO_3 as a base, water and a second electrophile to the reaction mixture after completion of the Stille CCR, this could be accomplished. All of these subsequent reactions were stirred at 100 °C for 6 h (Table 4). This allowed the synthesis of **8a** and **8b** in yields of 86 and 85%, respectively. The synthesis of **8b** demon-

Table 4. Chemoselective one-pot CCRs of thiophene **1**.^[a]

[a] i) **1** (1.0 equiv.), **2a + 2a'** (1.0 equiv.) $[\text{Pd}(\text{PPh}_3)_4]$ (1 mol-%), DMF, 60 °C, 17 h. ii) Electrophiles (1.0 equiv.), K_2CO_3 (2.0 equiv.), H_2O , 100 °C, 6 h. [b] Yields of isolated products.

strates that the strategy of using a nucleophile-selective cross-coupling reaction allows very easy access to non-symmetric di-stilbene-like materials. Aryl iodides can also be used as the second electrophile and in the case of **2l**, the reaction is also highly electrophile selective as shown by the high yield of 75%. In addition, no unselectively cross-coupled byproduct could be detected by GC-MS or NMR spectroscopy. The second Suzuki-Miyaura coupling was also performed with an alkynyl bromide, **6b**, but the yield was lower in this case, reflecting the lower efficiency of such substrates in cross-coupling reactions, as described above (Table 4).

Conclusions

In conclusion, reaction conditions for a nucleophile-selective CCR between vinyl and alkynyl bromides with a dinucleophilic thiophene substrate were established. Although homocoupling of the nucleophile and electrophile, respectively, are potential competing reactions, careful optimisation of the reaction conditions led to a process in which these side reactions could be largely suppressed in all cases. These reactions are general with respect to a wide variety of electrophiles. For vinyl bromides, all products were obtained in good to excellent yields, although time and temperature needed to be adjusted from case to case. Alkynyl bromides proved more difficult electrophilic components, mainly due to purification issues, which are apparently intrinsic for these types of boronic ester containing thiophene alkynyl groups. In both cases, the resulting products are extremely versatile building blocks: they still contain a boronic ester that can be further coupled with a second electrophile by a Suzuki-Miyaura cross-coupling in one-pot reactions. Furthermore, the reactions with the alkynyl bromides provide access to aromatic alkynyl compounds, with a reversal of the roles of nucleophile and electrophile compared with Sonogashira CCRs. This makes this reaction a valuable alternative for volatile aromatic alkynyl compounds, in cases where Sonogashira couplings fail or are unselective. The main advantage of a nucleophile-selective cross-coupling reaction is that a further organometallic site remains for subsequent functionalisation reactions. This was also demonstrated: by merely adding water and a base, a Suzuki-Miyaura reaction could be added to the reaction sequence. Aryl bromides and iodides as well as vinyl bromides and alkynyl bromides react under these conditions.

Experimental Section

General Procedure for Nucleophile-selective CCRs with Various Vinyl Bromides: A solution of **1** (373 mg, 1.00 mmol), the vinyl bromide (1.00 mmol), and [Pd(PPh₃)₄] (11.6 mg, 10.0 μmol, 1 mol-%) in DMF (4 mL) was heated to 40 or 60 °C for a specific time (for details with respect to specific electrophiles see the Supporting Information). The mixture was filtered through a short plug of celite with *n*-hexane (500 mL) as the solvent. The solvent was removed in vacuo and the crude product was purified by Kugelrohr

distillation or column chromatography (for details with respect to specific electrophiles see the Supporting Information).

General Procedure for Nucleophile-selective CCRs with Various Alkynyl Bromides: A solution of **1** (373 mg, 1.00 mmol), the alkynyl bromide (1.00 mmol), and [Pd(PPh₃)₄] (11.6 mg, 10.0 μmol, 1 mol-%) in DMF (4 mL) was heated to 40 or 60 °C for a specific time (for details with respect to specific electrophiles see the Supporting Information). The mixture was filtered through a short plug of celite with *n*-hexane (500 mL) or diethyl ether (50 mL) as the solvent. The solvent was removed in vacuo and the crude product was purified by Kugelrohr distillation or column chromatography (for details with respect to specific electrophiles see the Supporting Information).

General Procedure for Chemo-selective One-pot CCR of Thiophene 1: A solution of **1** (186 mg, 500 μmol), β-bromostyrene (*E/Z* = 8:1; 91.0 mg, 500 μmol), and [Pd(PPh₃)₄] (5.78 mg, 5.00 μmol, 1 mol-%) in DMF (4 mL) was heated to 60 °C for 17 h. Then the second electrophile (500 μmol) in DMF (4 mL) was added to the solution in one portion in addition to K₂CO₃ (138 mg, 1.00 mmol) in degassed water (1 mL). The solution was heated to 100 °C for 6 h. After the solution cooled down to 20 °C, the solution was diluted with CH₂Cl₂ (8 mL) and filtered through a short plug of silica with CH₂Cl₂ (250 mL). After removing the volatile components in vacuo, the crude product was purified by column chromatography (for details with respect to specific electrophiles see the Supporting Information).

Acknowledgments

L. Y. H. thanks the China Scholarship Council (CSC) for a Ph. D. scholarship and Prof. Zheng-Guo Zhang's and Prof. Xiao-Ming Fang's support for her work.

- [1] a) A. Suzuki, *Chem. Commun.* **2005**, 4759–4763; b) C. L. Sun, B. J. Li, Z. J. Shi, *Chem. Commun.* **2010**, 46, 677–685.
- [2] U. Kazmaier, M. Pohlman, *Metal-Catalyzed Cross-Coupling Reactions, Vol. 1*, 2nd ed., Wiley-VCH, Weinheim, **2004**.
- [3] a) A. D. Schlueter, *J. Polym. Sci., Part A* **2001**, 39, 1533–1556; b) T. Yamamoto, *Bull. Chem. Soc. Jpn.* **2010**, 83, 431–455.
- [4] a) C. Torborg, M. Beller, *Adv. Synth. Catal.* **2009**, 351, 3027–3043; b) J. Magano, J. R. Dunetz, *Chem. Rev.* **2011**, 111, 2177–2250; c) M. L. Crawley, B. M. Trost, *Applications of Transition Metal Catalysis in Drug Discovery and Development: An Industrial Perspective*, John Wiley & Sons, Hoboken, **2012**.
- [5] a) G. Y. Cho, P. Remy, J. Jansson, C. Moessner, C. Bolm, *Org. Lett.* **2004**, 6, 3293–3296; b) S. H. Lee, B. B. Jang, Z. H. Kafafi, *J. Am. Chem. Soc.* **2005**, 127, 9071–9078; c) S. Shekhar, J. F. Hartwig, *Organometallics* **2007**, 26, 340–351; d) M. Mosrin, P. Knochel, *Chem. Eur. J.* **2009**, 15, 1468–1477; e) J. J. Peterson, Y. C. Simon, E. B. Coughlin, K. R. Carter, *Chem. Commun.* **2009**, 4950–4952; f) M. Kienle, A. Unsinn, P. Knochel, *Angew. Chem. Int. Ed.* **2010**, 49, 4751–4754; *Angew. Chem.* **2010**, 122, 4860; g) A. Martins, D. A. Candito, M. Lautens, *Org. Lett.* **2010**, 12, 5186–5188.
- [6] N. Miyaura, A. Suzuki, *Chem. Rev.* **1995**, 95, 2457–2483.
- [7] Nucleophile-selective reactions on aromatic compounds: a) E. J. Roskamp, P. S. Dragovich, J. B. Hartung, S. F. Pedersen, *J. Org. Chem.* **1989**, 54, 4736–4737; b) D. R. Williams, A. A. Shah, *Chem. Commun.* **2010**, 46, 4297–4299; c) J. Linschoeft, A. C. J. Heinrich, S. A. W. Segler, P. J. Gates, A. Staubitz, *Org. Lett.* **2012**, 14, 5644–5647; d) A. C. J. Heinrich, B. Thiedemann, P. J. Gates, A. Staubitz, *Org. Lett.* **2013**, 15, 4666–4669; nucleophile-selective reactions on other tin/boron reagents: e) F. Lhermitte, B. Carboni, *Synlett* **1996**, 377–379; f) R. S. Coleman, M. C. Walczak, *Org. Lett.* **2005**, 7, 2289–2291; g) R. S.

- Coleman, X. L. Lu, I. Modolo, *J. Am. Chem. Soc.* **2007**, *129*, 3826–3827; h) M. Altendorfer, D. Menche, *Chem. Commun.* **2012**, *48*, 8267–8269; nucleophile-selective reactions on other boron/boron reagents: i) S. J. Lee, K. C. Gray, J. S. Paek, M. D. Burke, *J. Am. Chem. Soc.* **2008**, *130*, 466–468; j) G. A. Molander, D. L. Sandrock, *J. Am. Chem. Soc.* **2008**, *130*, 15792–15793; k) H. Noguchi, T. Shioda, C. M. Chou, M. Suginoe, *Org. Lett.* **2008**, *10*, 377–380; l) M. Tobisu, N. Chatani, *Angew. Chem. Int. Ed.* **2009**, *48*, 3565–3568; *Angew. Chem.* **2009**, *121*, 3617; m) N. Iwada, M. Suginoe, *J. Am. Chem. Soc.* **2010**, *132*, 2548–2549; n) R. R. Singidi, T. V. Rajan-Babu, *Org. Lett.* **2010**, *12*, 2622–2625; o) E. M. Woerly, A. H. Cherney, E. K. Davis, M. D. Burke, *J. Am. Chem. Soc.* **2010**, *132*, 6941–6943; p) S. Fujii, S. Y. Chang, M. D. Burke, *Angew. Chem. Int. Ed.* **2011**, *50*, 7862–7864; *Angew. Chem.* **2011**, *123*, 8008; q) J. C. H. Lee, R. McDonald, D. G. Hall, *Nature Chem.* **2011**, *3*, 894–899; r) K. C. Gray, D. S. Palacios, I. Dailey, M. M. Endo, B. E. Uno, B. C. Wilcock, M. D. Burke, *Proc. Natl. Acad. Sci. USA* **2012**, *109*, 2234–2239; s) L. Xu, S. Y. Ding, P. F. Li, *Angew. Chem. Int. Ed.* **2014**, *53*, 1822–1826; t) L. Xu, P. F. Li, *Synlett* **2014**, *25*, 1799–1802; nucleophile-selective reactions on other boron/zinc reagents: u) Y. Nagashima, R. Takita, K. Yoshida, K. Hirano, M. Uchiyama, *J. Am. Chem. Soc.* **2013**, *135*, 18730–18733; nucleophile-selective reactions on other silicon/boron reagents: v) M. G. McLaughlin, C. A. McAdam, M. J. Cook, *Org. Lett.* **2015**, *17*, 10–13.
- [8] C. Adamo, C. Amatore, I. Ciofini, A. Jutand, H. Lakmini, *J. Am. Chem. Soc.* **2006**, *128*, 6829–6836.
- [9] M. Wakioka, M. Nagao, F. Ozawa, *Organometallics* **2008**, *27*, 602–608.
- [10] a) M. Ahlquist, P. Fristrup, D. Tanner, P. O. Norrby, *Organometallics* **2006**, *25*, 2066–2073; b) Z. Li, Y. Fu, Q. X. Guo, L. Liu, *Organometallics* **2008**, *27*, 4043–4049.
- [11] a) J. P. Das, S. Roy, *J. Org. Chem.* **2002**, *67*, 7861–7864; b) R. A. Fursule, P. O. Patil, B. D. Shewale, S. B. Kosalge, P. K. Deshmukh, D. A. Patil, *Chem. Pharm. Bull.* **2009**, *57*, 1243–1245.
- [12] A. Hayford, J. Kaloko, S. El-Kazaz, G. Bass, C. Harrison, T. Corprew, *Org. Lett.* **2005**, *7*, 2671–2673.
- [13] a) Y. Li, M. A. El-Sayed, *J. Phys. Chem. B* **2001**, *105*, 8938–8943; b) J. H. Li, W. J. Liu, *Org. Lett.* **2004**, *6*, 2809–2811.
- [14] S. Hitosugi, D. Tanimoto, W. Nakanishi, H. Isobe, *Chem. Lett.* **2012**, *41*, 972–973.

Received: January 28, 2015
Published Online: February 27, 2015

4 Summary and Outlook

This work aimed at the synthesis and characterisation of the first 1,2-azaborine containing polymers. On the route towards the target polymers, different challenges appeared: First, for the synthesis of 1,2-azaborines it was necessary to obtain absolutely pure allylamines. An unexpected by-product that occurred by over-reduction and was not separable from the product led to the first sub-project (“**Accessing Allylamines**”; **Chapter 3.1**). For the second project (“**Towards Conjugated 1,2-Azaborine Polymers**”; **Chapter 3.2**), a particular 1,2-azaborine unit for the synthesis of conjugated polymers was targeted. On the synthetic route towards this molecule, one key step turned out to be synthetically very challenging and was therefore further investigated. In a third project, my goals were both to synthesise an 1,2-azaborine analogue of styrene and then to polymerise this monomer (“**1,2-Azaborine Vinylpolymers**”; **Chapter 3.3**). A collaborative contribution to a synthetic project outside the scope of the central theme of azaborines of this thesis was also added (“**Nucleophile-Selective Cross-Coupling Reactions**”; **Chapter 3.4**).

4.1 Accessing Allylamines

On the synthetic route to *n*-hexylallylamine, an inseparable by-product was identified as *n*-hexylpropylamine via an extensive GC and NMR analysis. The by-product was verified by an additional synthesis and overlay of the spectra. In the literature, it had never been reported that allylamines can be reduced by LiAlH₄. Based on this finding, an optimisation of the reaction conditions was carried out with respect to aspects of greener chemistry, cost effectiveness and safety. An additional in situ reaction monitoring by NMR analysis (with LiAlH₄, LiAlD₄ as reducing agents and H₂O and D₂O as quenching agents) led to first mechanistic insights. Only the double bond of the allylamine is attacked while the double bond of the allylamide remains intact. This attack must be induced by an aluminium hydride species, which coordinates on the nitrogen and the terminal carbon of the double bond to form a five-membered ring. By this increased polarisation of the olefinic bond, a second aluminium hydride species can easily transfer a hydride to the β -position of the allylamine and remains attached to the terminal carbon.

Furthermore, the reduction behaviour of additional 11 allylamides was screened to analyse the influences of different *N*-substituents: A significant inhibition effect of steric demanding functional groups was detected as well as the reduction of the double bond of α,β -unsaturated allylamides. Finally, a new mechanism for the reduction of allylamides by LiAlH_4 was proposed. All these results were published in the *Journal of Organic Chemistry* of the American Chemical Society in 2014 (Thiedemann, B.; Schmitz, C. M. L.; Staubitz, A. *J. Org. Chem.* **2014**, *79*, 10284).

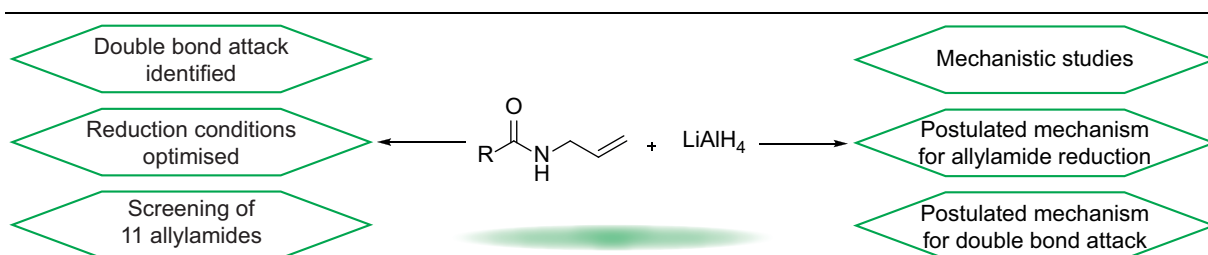


Figure 14. Summarising illustration of the publication “Thiedemann, B.; Schmitz, C. M. L.; Staubitz, A. *J. Org. Chem.* **2014**, *79*, 10284”.

In this publication, we pointed out that the optimised synthetic conditions are applicable for a broad range of allylamides. However, for a few substitution patterns, these conditions led to no conversion (for carbonyl substituents = mesityl, 2-ethylbutyl and benzyl). Thus, it would be a great advantage to find conditions, which would be applicable for every substitution pattern and, furthermore, to absolutely exclude the over-reduction of allylamines by LiAlH_4 . One conceivable approach could be the use of a suitable double bond complexing reagent, which serves as a kind of protection group for the allylic double bond.⁹¹ Another possibility could be the use of a reducing agent with less hydrides and bulkier ligands. A sterically demanding lithium aluminium hydride complex could maintain a distance from the double bond. For a further study, commercially available aluminium hydrides could be sodium *bis*(2-methoxyethoxy)aluminium hydride, *diisobutyl*aluminium hydride or lithium *tri-tert*-butoxyaluminium hydride.

4.2 Towards Conjugated 1,2-Azaborine Polymers

For accessing conjugated 1,2-azaborine polymers, a *N*-(4-bromophenyl) substituted azaborine precursor **8** was successfully synthesised by a bachelor student under my supervision, L. Dölger. However, oxidative dehydrogenation approaches resulted in only low conversions

of **8**. A failed isolation of the product **21** forced an optimisation of the reaction conditions. For this purpose, a more easily accessible but similar azaborine precursor **12** was synthesised. With this compound, several conditions were screened based on DDQ or Pd black in cyclohexene as oxidising agents. Here, DDQ led to a very low conversion (up to 7%) or even decomposition of the starting material. Pd black in cyclohexene revealed a lower conversion (13% after 1 h) of **12** compared to the approach with **8** (26% after 1 h). The reaction of a methyl substituted precursor **13** resulted in an even lower conversion of 9% and indicated an electronical influence on the dehydrogenation process. A final test with the Pd/cyclohexene system included an addition of bromobenzene to a well reacting azaborine precursor, which resulted in both 0% conversion and the understanding that bromobenzene as well as bromobenzene functionalities inhibit the dehydrogenation reaction with Pd black.

A solvent change to chlorobenzene, which allows higher reaction temperatures, has the disadvantage that it is usually no hydrogen acceptor. Consequently, only a disproportionation reaction of **12** with a conversion maximum of 50% should be achievable. Though, this procedure showed the highest conversion (66%). This unexpected high conversion could be explained by side-reactions of **12** which were indicated by ^1H NMR. These side-reactions would lead to an error in the calculation of the conversion to the desired product **19**, because the integral of the remaining starting material **12** is the reference. Finally, the isolation by sublimation of the 66%-approach failed due to decomposition.

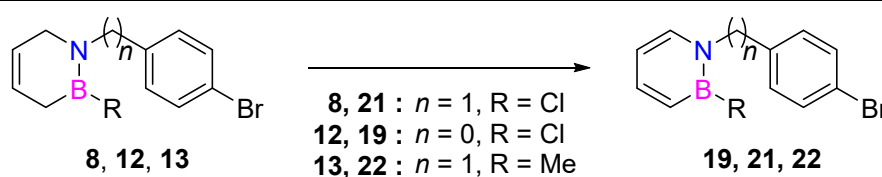
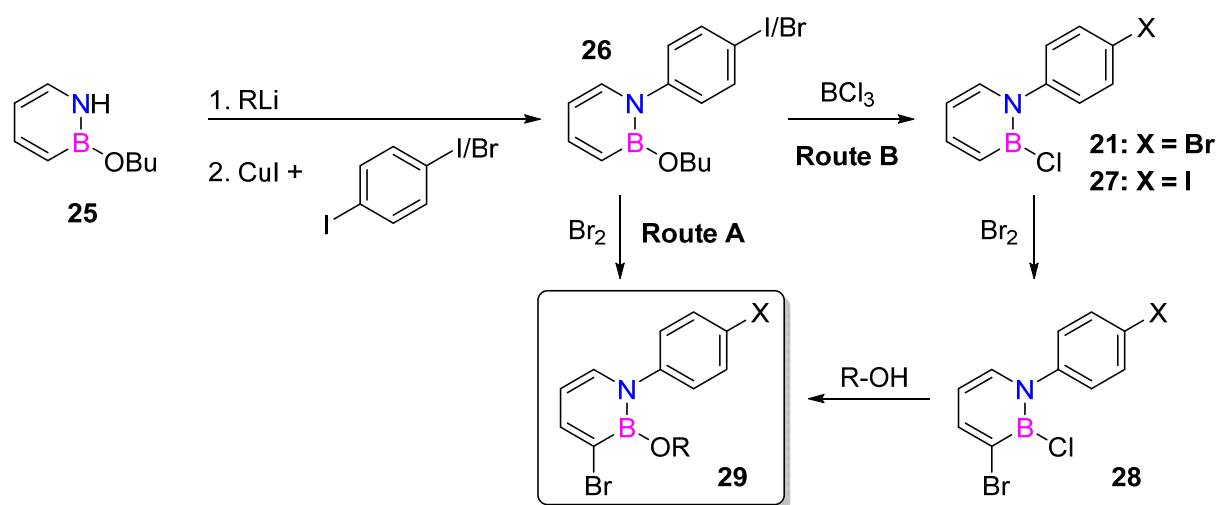


Figure 15. The oxidative dehydrogenation of the arylbromide-functionalised azaborine precursor was proven to be the bottleneck step towards the wanted monomers for conjugated polymers.

To improve the oxidative dehydrogenation step, a further screening of oxidation catalysts or C-H activation reagents can be performed. A first selection (IBX, DMP, SeO_2 -PPSE and $[\text{Ir}(\text{COD})(\text{OMe})\text{I}_2]$) were screened by P. Gliese in his master's thesis but without any breakthrough.⁹² For next studies, other iridium⁹³⁻⁹⁵ or nickel⁹⁶ catalysts are conceivable.

A further approach towards the conjugated polymers (see **Chapter 3.2**) could be an incorporation of the 4-bromophenyl substituent after the oxidative dehydrogenation. For this plan,

the Liu group paved the way by reporting a protecting group-free synthesis of a *N*-H-function-alised 1,2-azaborine **25**.⁷⁸ Starting from **25**, a lithiation of the nitrogen and a subsequent copper(I)-supported reaction⁹⁷ with *p*-halogenated iodobenzene could preferably result in azaborine **26**. Then, route A could be a direct bromination to a monomer **27**. An alternative route B would be the reaction of **26** with BCl₃ which should lead to the desired azaborine **21** or the iodinated derivative **28**. Afterwards, a bromination would result in an azaborine species **29** which is bearing three different halogens. On this stage, a broad range of possible boron substituents can be introduced to monomer species **27** for adjusting the solubility of the later polymer (**Scheme 15**).^{52,64,74,78,98}



Scheme 15. Alternative route to the desired monomer species **27** for conjugated polymers.

A final project will be the copolymerisation of **27** via cross-coupling reaction with a dinucleophilic aromatic compound.⁹⁹ For a homopolymerisation, a common metal group has to be incorporated into **27**, for example tin or boron by cross-coupling reactions with their dimetallic species.¹⁰⁰⁻¹⁰²

Beside the substitution pattern shown in **Scheme 15**, other linking positions are accessible according to reported literature, in which the 3,6-linkage was already used for the first conjugated azaborine polymer by the Liu group (see **Chapter 2.4.1**).⁵⁶ However, the 1,5-, 2,5-, 2,6- and 3,5-linkages are interesting for studying the conjugation through the azaborine ring and the effects of the B-N bond position (**Figure 16**).

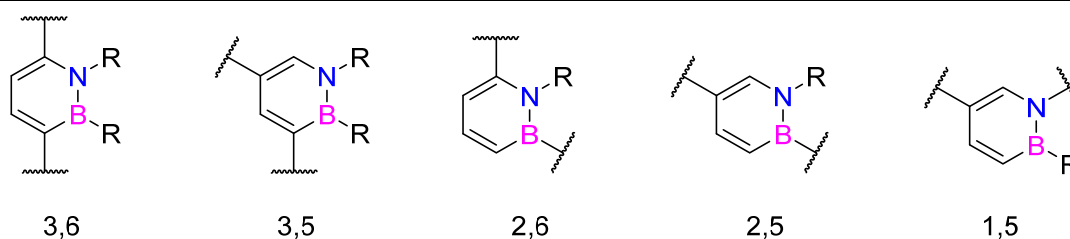


Figure 16. Further possible linkages for conjugated azaborine polymers based on publications.

4.3 1,2-Azaborine Vinylpolymers

1,2-Azaborine is isoelectronic to its carbon analogue, benzene and related aromatic rings, and it is currently of high interest to many research groups. However, it is becoming increasingly clear that the analogy is merely a formal one and that the differences between carbon cycles and hetero cycles are substantial. Since poly(vinylbenzene), better known as poly(styrene) (PS), is nowadays one of the most demanded plastics in the world, it was the aim of this work to expand the portfolio of polyolefines by synthesising and characterising a poly(vinyl-azaborine) (PVAB), a B-N analogue of PS.

Therefore, the monomer of choice, *N*-methyl-2-vinyl-1,2-azaborine (**NMe2VAB**), was synthesised in a 5-step synthesis. Each of these syntheses had to be performed under inert conditions due to the high sensitivity towards oxygen or/and moisture of all intermediates and the final product. The development of handling procedures and special glassware enabled the isolation of a suitable azaborine monomer.

NMe2VAB was polymerised by free radical polymerisation with AIBN as radical starter in a yield of 51% and in a high average molecular weight (24.9 kDa). Furthermore, a copolymerisation with the C-C analogue, 2-methylstyrene, was performed. A thorough comparison of all polymers (**PNMe2VAB**, **PNMe2VAB/P2MeS** copolymer and **P2MeS**) by NMR spectroscopy, thermal analysis (thermogravimetry [TGA] and dynamic scanning calorimetry [DSC]) and gel permeation chromatography (GPC) revealed significant differences in chemical and physical properties.

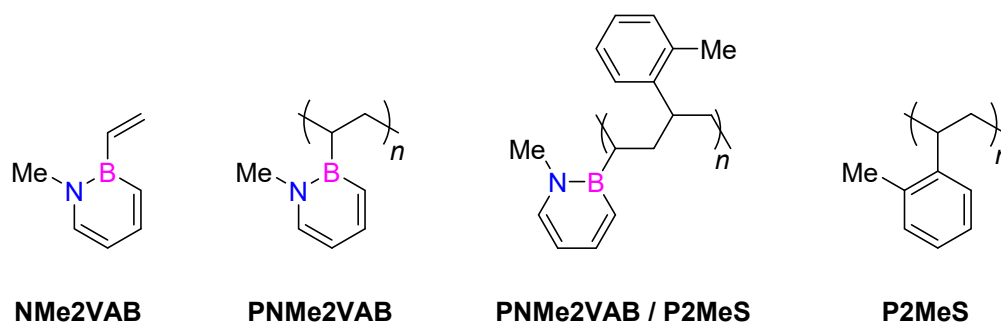


Figure 17. Overview of the synthesised monomer NMe2VAB, the corresponding polymer PNMe2VAB, the copolymer PNMe2VAB/P2MeS and the C-C analogue P2MeS.

Owing to the sensitivity of the **PNMe2VAB** and its copolymer towards oxygen, it is conceivable to apply these polymers as material in oxygen sensors. Furthermore, it can be incorporated into other (vinyl-)polymers by copolymerisation or in a blend to tune the polymer properties.

Due to the limited availability of other PVABs, there is enormous potential in this research field. The obvious next step is to vary the substitution pattern of the vinylazaborine to both improve the stability under air conditions and receive more insight in correlations between structure and properties of the corresponding vinylazaborine polymers.

Based on the already synthesised **NMe2VAB**, the substituents of the azaborine ring could be changed to investigate their influences on both the stability and the physical properties. One idea is to shield the sensitive B-backbone bond by adjacent bulky substituents. Several substitution reactions are reported.^{52,64,74,78,98} Probably, the main risk of this approach will be the blocking of further approaching vinylmonomers during the polymerisation and consequently a slowing down of the polymerisation rate or even an inhibition of polymerisation (**Figure 18, A**). As the Liu group reported, stability of a B-alkyl bond in azaborines against oxygen can be increased by chlorination or bromination in 3-position. Based on this results, a Cl- or Br-substituent adjacent to the boron-vinyl bond could improve the storage under ambient conditions. At the same time, these halides are more sterically demanding than hydrogen and, consequently, this change in substitution could inhibit the polymerisation (**Figure 18, B**).

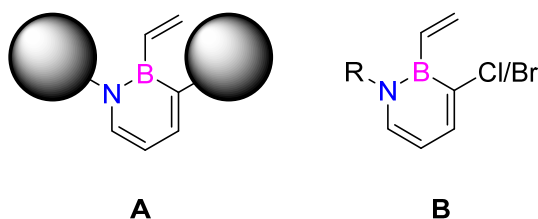
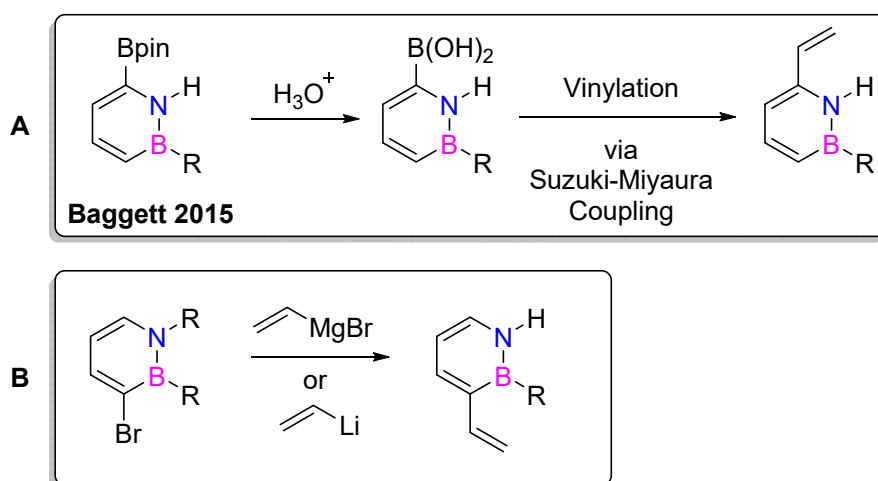


Figure 18. Bulky substituents next to the oxygen sensitive boron-vinyl bond (**A**) or halogenation on the carbon atom adjacent to boron (**B**) could make the corresponding vinylazaborine polymers more resistant against oxygen.

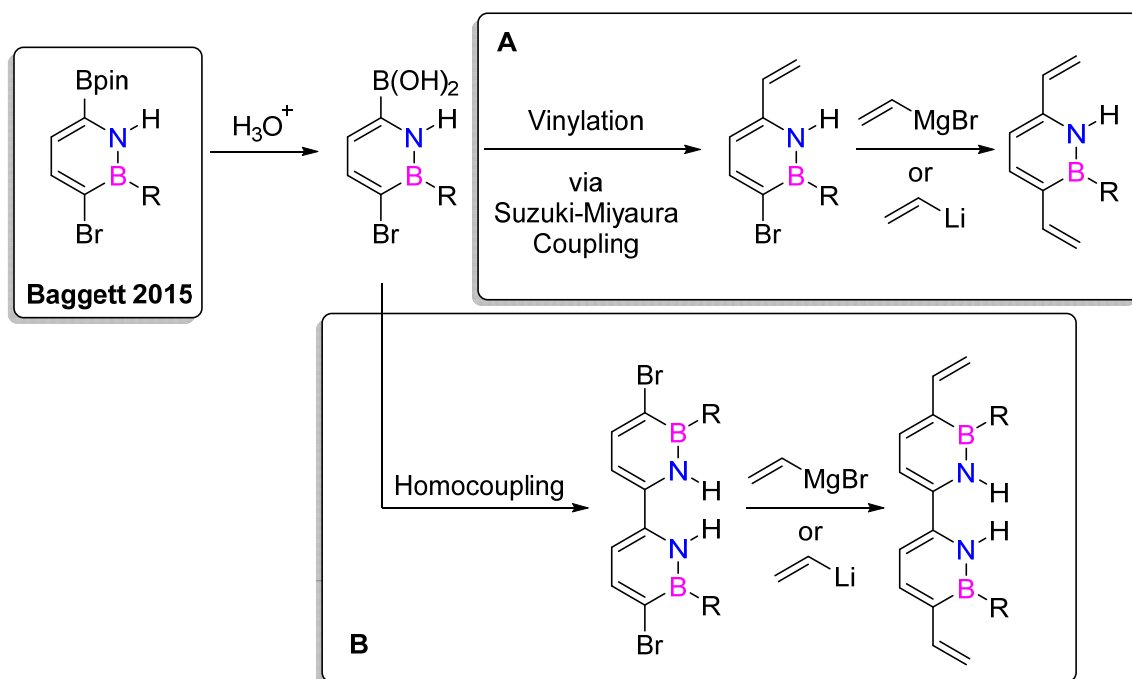
A next approach to improve and extend the portfolio of vinylazaborines, would be the move of the vinyl group to a more stable C-C bond in the corresponding vinylpolymer. Since Baggett et al. showed that a C-H activation in the 6-position is feasible and Otley and Ellman reported a direct vinylation method towards styrene derivatives, a vinylation next to the nitrogen atom is conceivable (**Scheme 16, A**).^{100,103,104} A probably less problematic vinylation could be performed on the 3-position. After the already reported bromination on this position,⁹⁸ the reaction with vinyl lithium or with a vinyl Grignard reagent should result in a 3-vinylazaborine. Here, it is important to substitute the boron-chloride bond by a more stable B-alkyl, -alkoxy or -aryl bond beforehand (**Scheme 16, B**). For both, **A** and **B**, it should be payed attention to the sterically hindrance towards the polymer backbone.



Scheme 16. Two possible approaches to move the vinyl group to vary the range of available vinylazaborines.

By assembling the previous ideas of vinylmonomers, a divinylazaborine as linker would open access to a three-dimensional polymer network. Here, one approach would be the double

vinylation on one azaborine ring (**Scheme 17, A**), in which the bromide of the azaborine could compete with the vinyl coupling reagent and therefore this would be one challenge. Another problem could appear at the second vinylation step: the metal-vinyl reagent could react with the already incorporated vinyl group. A second approach for double vinylation could be a first homocoupling of two azaborine rings and a subsequent double vinylation. (**Scheme 17, B**).^{56,105-107}



Scheme 17. Ideas for synthetic access to divinylazaborines starting from the Bpin- and bromide-functionalised azaborine published by Baggett et al.⁵⁶

For further projects, the attention should be turned to applications. Here, the investigation of the hydrogen storage capability of PVABs, which bearing a boron-hydride functionality, could be interesting. A water resistant PVABs could find its way into biomedicine applications. Beyond that, some azaborines are able to form a complex with heavy metals^{63,108-110} and one thought further could lead to a novel filtration material made of PVAB.

5 Experimental Section

5.1 Supporting Information on Chapter 3.1

5.1.1 Supporting Information for *J. Org. Chem.* 2014, 79, 10284.

Supporting Information

for

Reduction of *N*-Allylamides by LiAlH₄:

Unexpected Attack of the Double Bond.

Mechanistic Studies of Product and By-Product Formation.

Birk Thiedemann¹, Christin L. M. Schmitz¹, and Anne Staubitz^{1,*}

¹*Otto-Diels-Institute for Organic Chemistry, University of Kiel, Otto-Hahn-Platz 4, 24098 Kiel (Germany).*

*astaubitz@oc.uni-kiel.de

Table of Contents

Chemicals.....	SI 2
Solvents.....	SI 3
¹ H NMR and ¹³ C NMR Spectra	SI 4
LiAlH ₄ Titration.....	SI 29
Complete Optimisation Data.....	SI 33
Mechanistic Study.....	SI 39

Chemicals

All reagents were used without further purification unless noted otherwise.

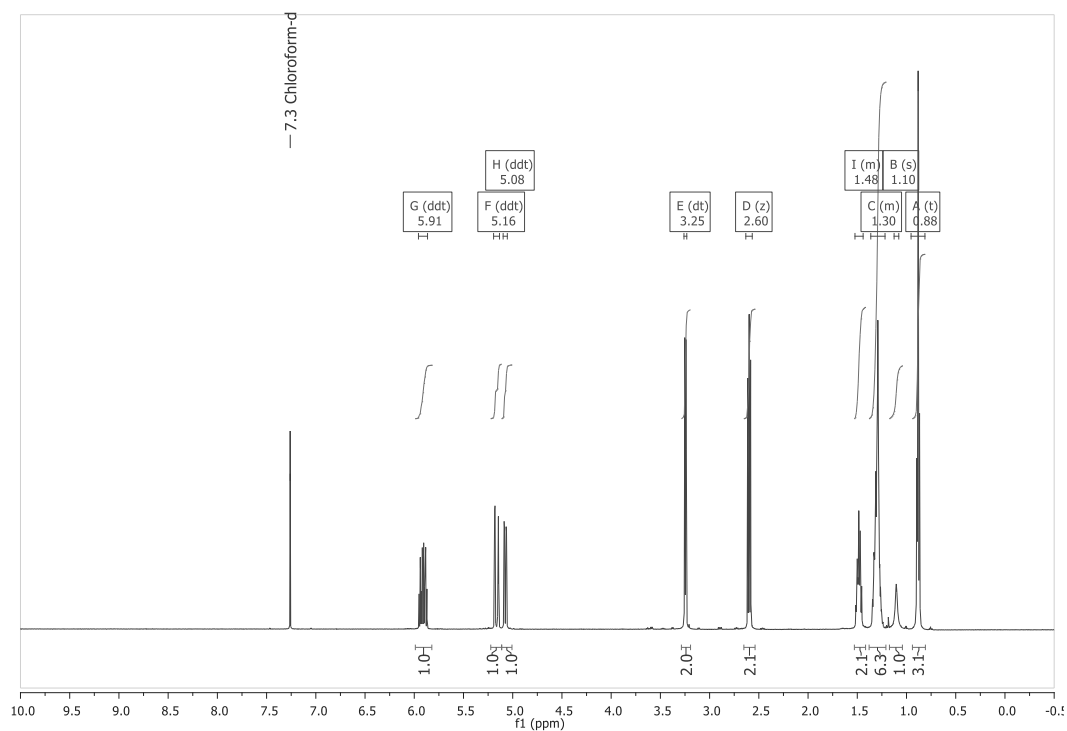
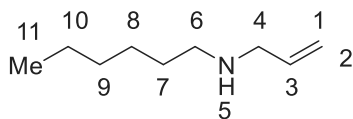
Compound	Purity	Comment
1-Propylamine	98 %	
2-Ethylbutyryl chloride	97 %	
Allylamine	98 %	Dried and distilled from CaH ₂ , stored over molecular sieve (3 Å)
Benzyl chloride	>99 %	
Butyryl chloride	98 %	
Calcium hydride	90-95 %	
Crotonyl chloride	90 %	
Cyclohexanecarbonyl chloride	98 %	
Ethyl formate	98 %	
Hexanoylchloride	98 %	
Isobutyl chloride	98 %	
Lithium aluminium deuteride	98 atom%	
Lithium aluminium hydride	95 %	
Magnesium sulphate	99 %	
Octanoyl chloride	99 %	
Oxalyl chloride	98 %	
<i>p</i> -Anisaldehyde	>99 %	
Phenylacetyl chloride	98 %	
Silica gel		0.040-0.063 mm
Sodium		Rods in paraffin oil
Sodium carbonate	99 %	
Sodium chloride	99.5 %	

Sodium sulphate	≥99 %	
Triethyl amine	99 %	Dried and distilled from CaH ₂ , stored over molecular sieve (3 Å)

Solvents

All solvents were used freshly distilled after refluxing for several hours over the specified drying agent under nitrogen and were stored in a J. Young's-tube. Dried solvents were regularly tested for water content by Karl Fischer titration. If no drying agent is noted, the solvents were only distilled for purification purposes.

Solvent	Drying procedure	Water content
CH ₂ Cl ₂	Distilled and stored at least for 1 d over molecular sieve (3 Å)	< 15 ppm
CH ₂ Cl ₂	For column chromatography and work-up: only distilled for purification	
CHCl ₃	For column chromatography and work-up: only distilled for purification	
Et ₂ O	Predried over KOH; dried over sodium and stored over molecular sieve (3 Å)	< 10 ppm
Et ₂ O	For column chromatography and work-up: only distilled for purification	
Me-THF	Predried over KOH; dried over sodium and stored over molecular sieve (3 Å)	< 10 ppm
<i>n</i> -Hexane	For column chromatography and work-up: only distilled for purification	
<i>t</i> -BuOMe	Predried over CaCl ₂ , dried over sodium and stored over molecular sieve (3 Å)	< 15 ppm
THF	Predried over KOH; dried over sodium and stored over molecular sieve (3 Å)	< 10 ppm

^1H NMR and ^{13}C NMR Spectra***N*-Allylhexanamine (1)****Figure SI-1** ^1H NMR spectrum of *N*-allylhexanamine 1.

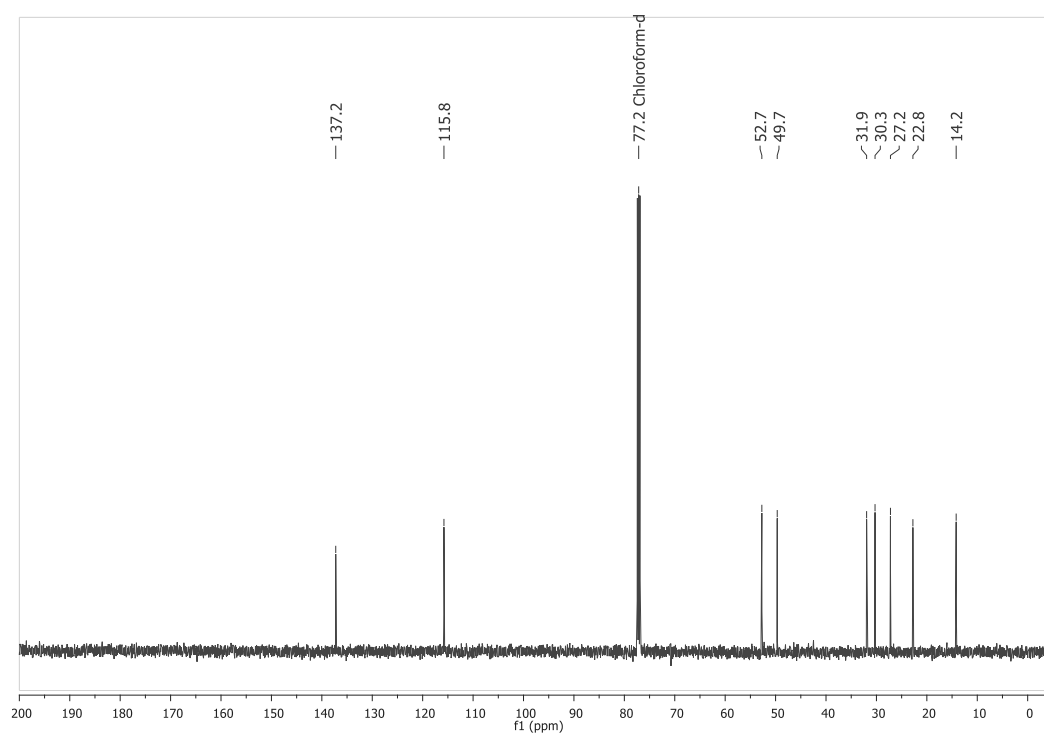
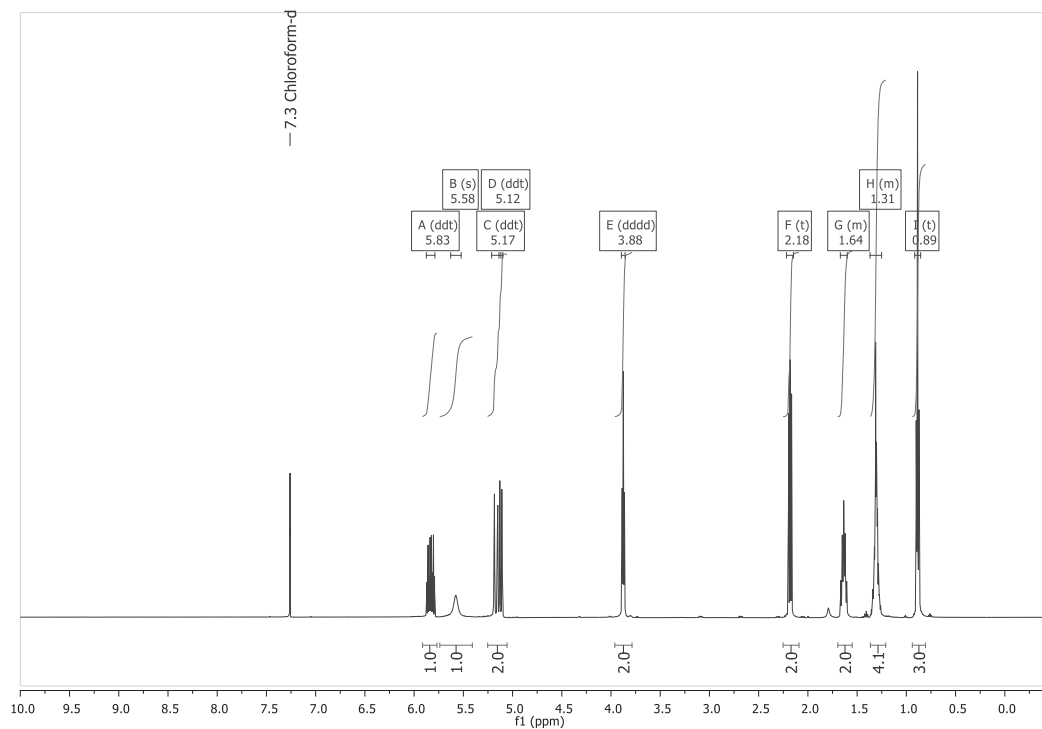
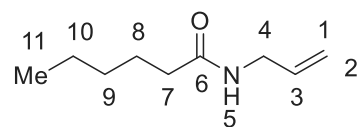
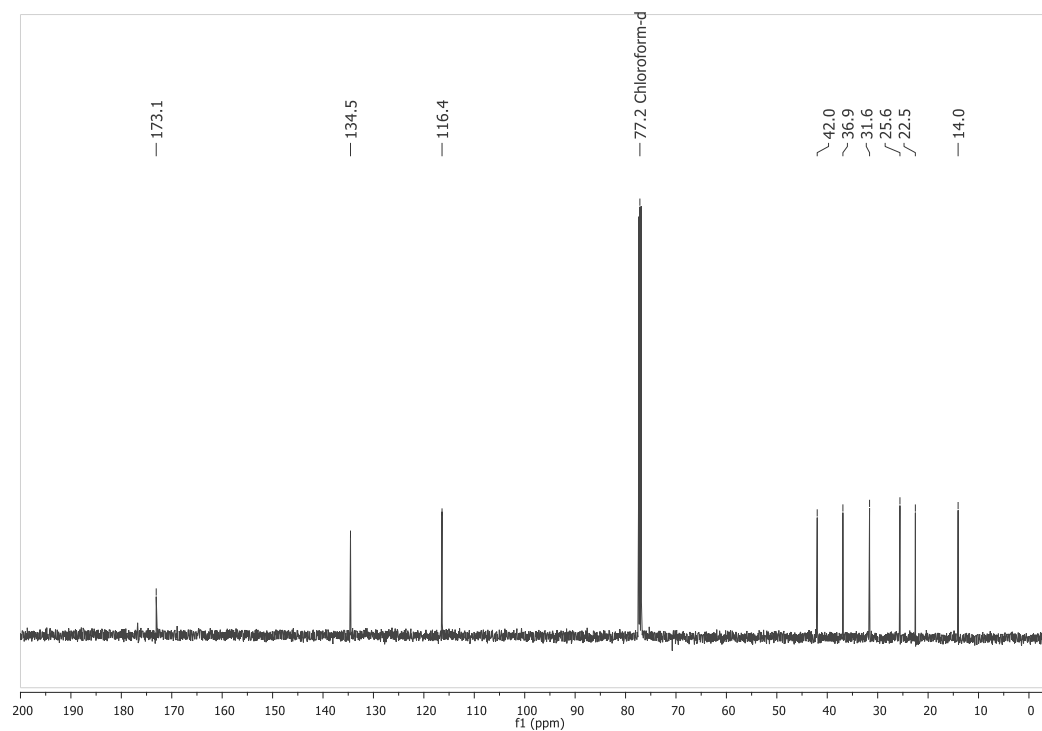
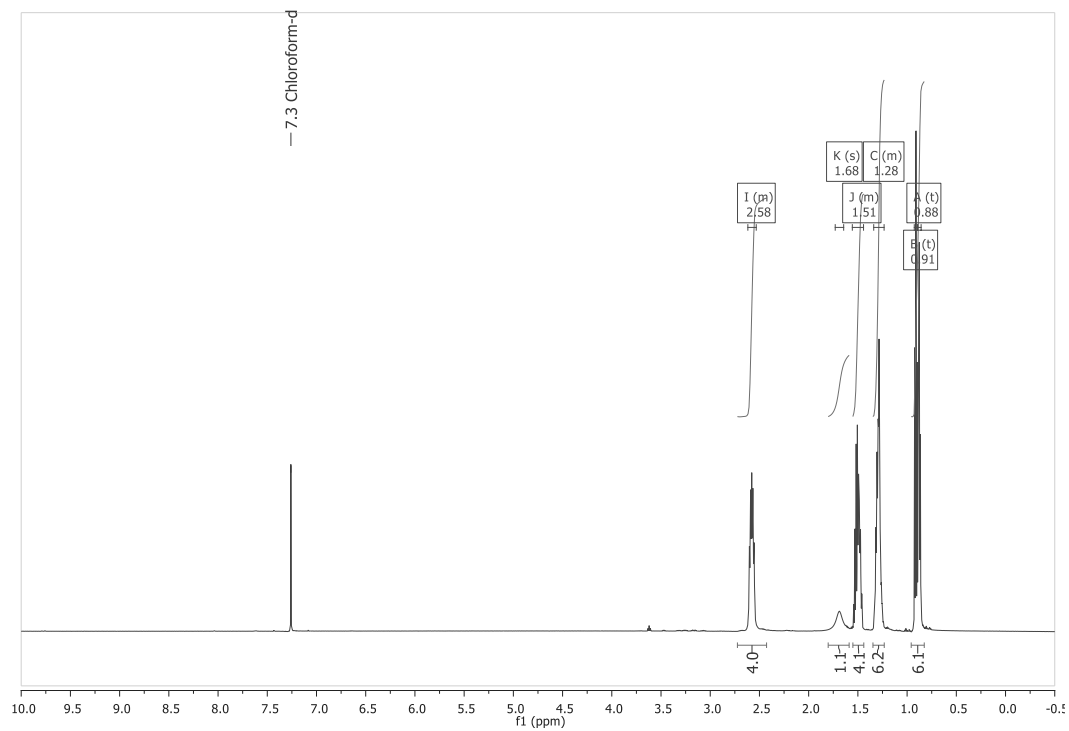
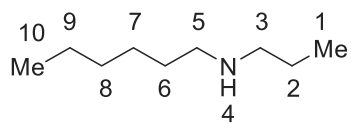
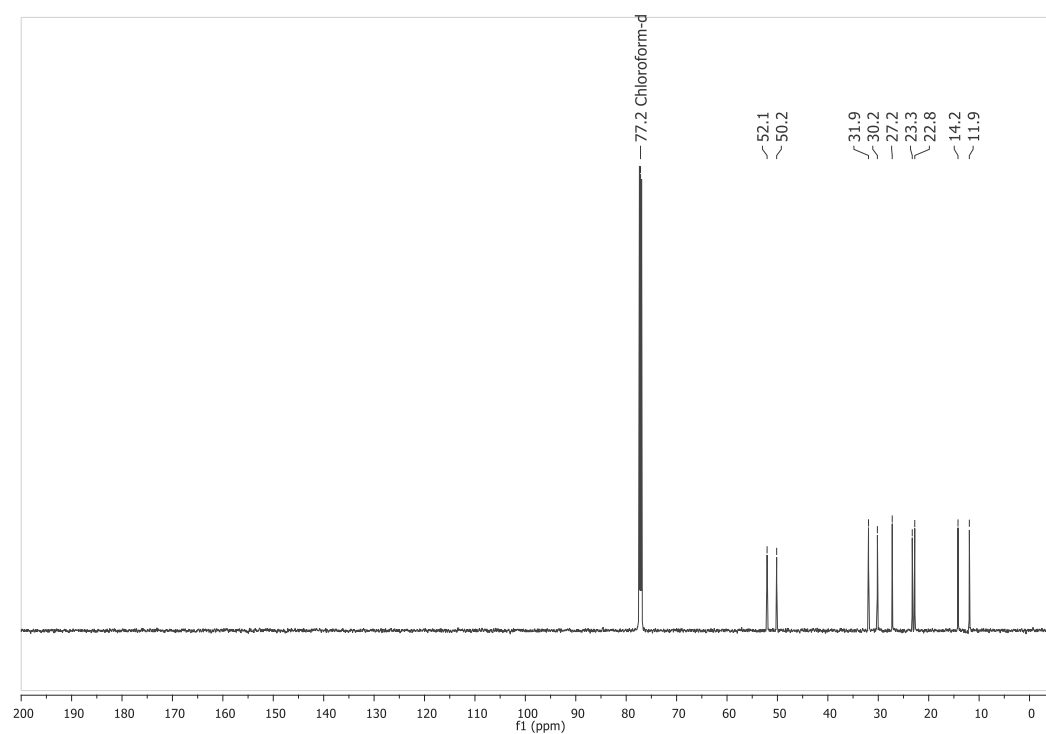
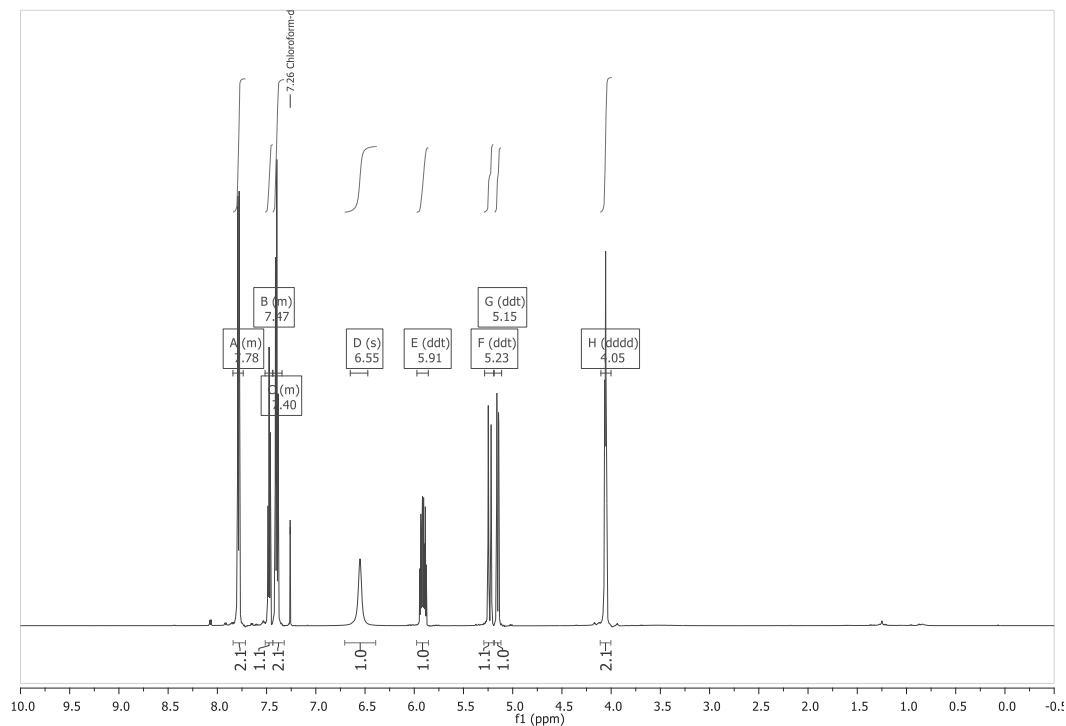
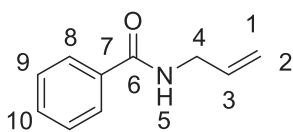
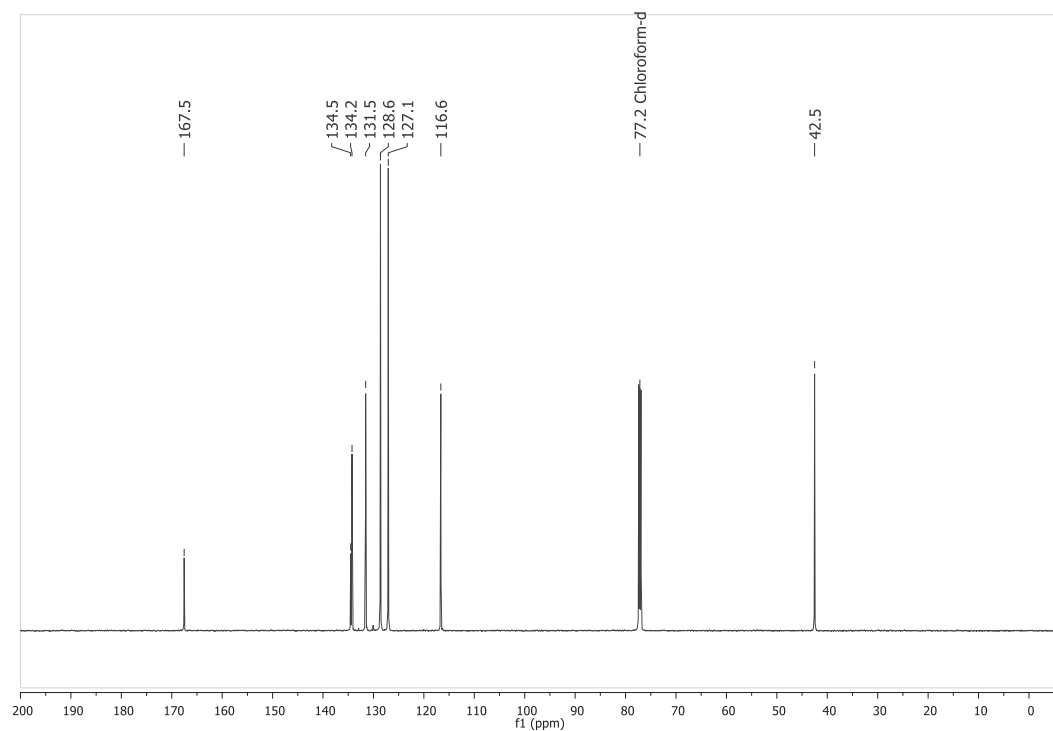


Figure SI-2 ^{13}C NMR spectrum of *N*-allylhexanamine 1.

***N*-Allylhexanamide (2)****Figure SI-3** ^1H NMR spectrum of *N*-allylhexanamide **2**.**Figure SI-4** ^{13}C NMR spectrum of *N*-allylhexanamide **2**.

***N*-Propylhexanamine (5)****Figure SI-5** ¹H NMR spectrum of *N* propylhexanamine 5.**Figure SI-6** ¹³C NMR spectrum of *N*-propylhexanamine 5.

***N*-Allylbenzamide (6)****Figure SI-7** ¹H NMR spectrum of *N*-allylbenzamide 6.**Figure SI-8** ¹³C NMR spectrum of *N*-allylbenzamide 6.

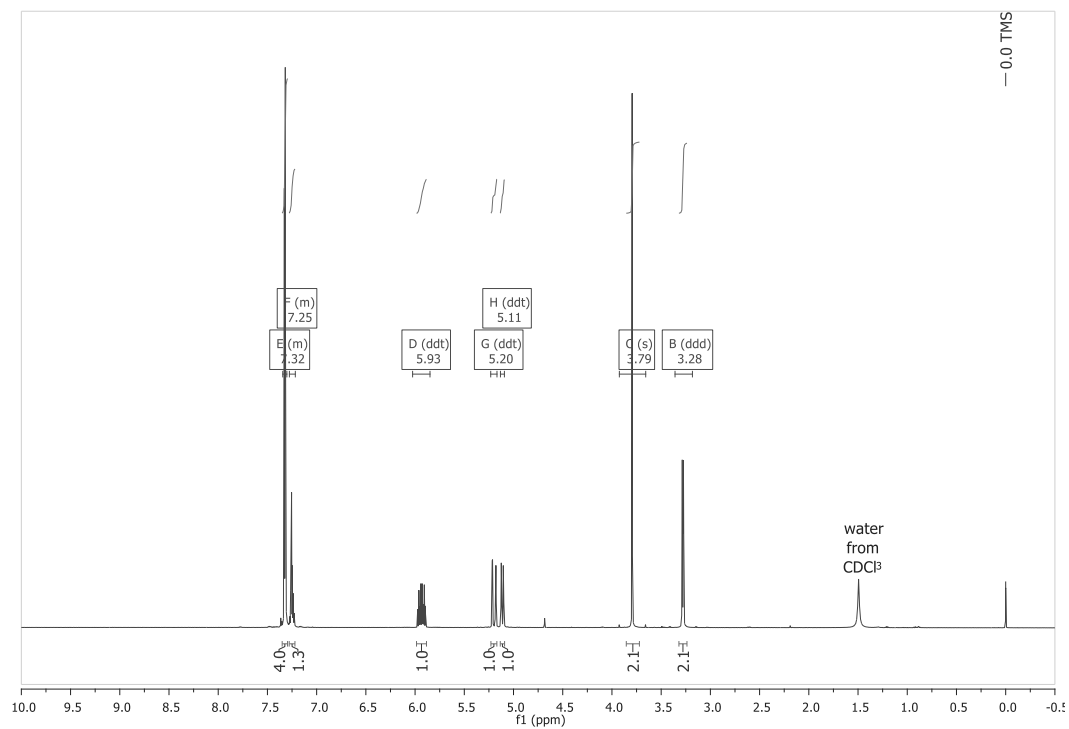
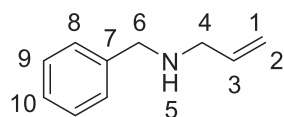
***N*-Allyl-*N*-benzylamine (8)**

Figure SI-9 ^1H NMR spectrum of *N*-allyl-*N*-benzylamine **8**.

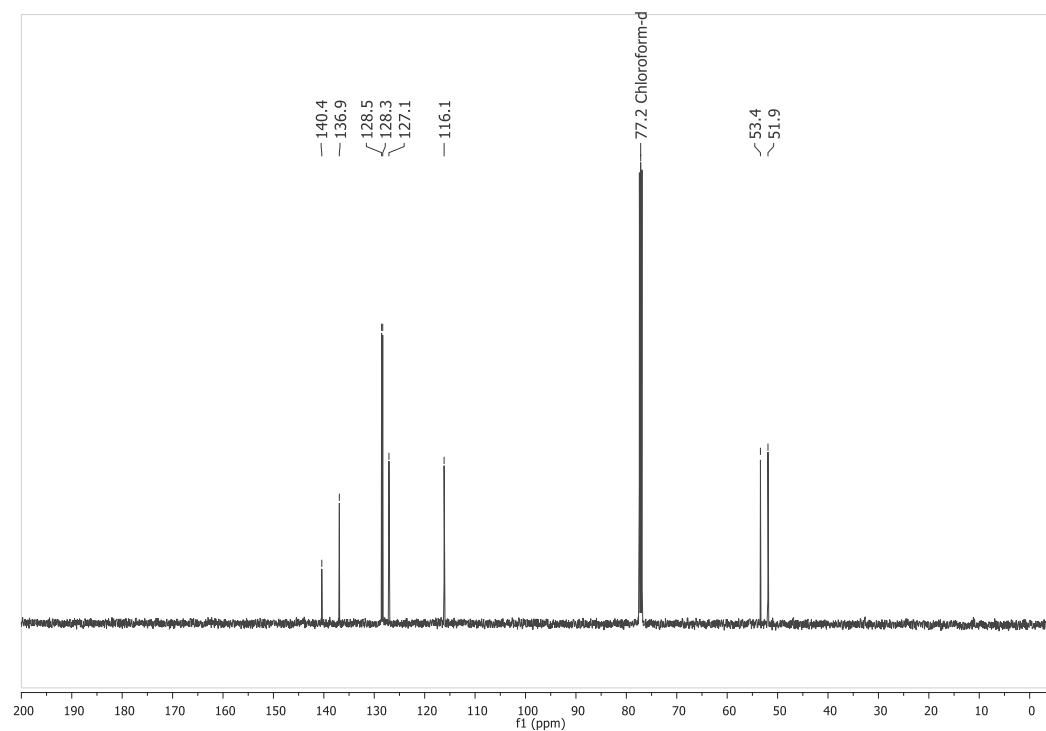
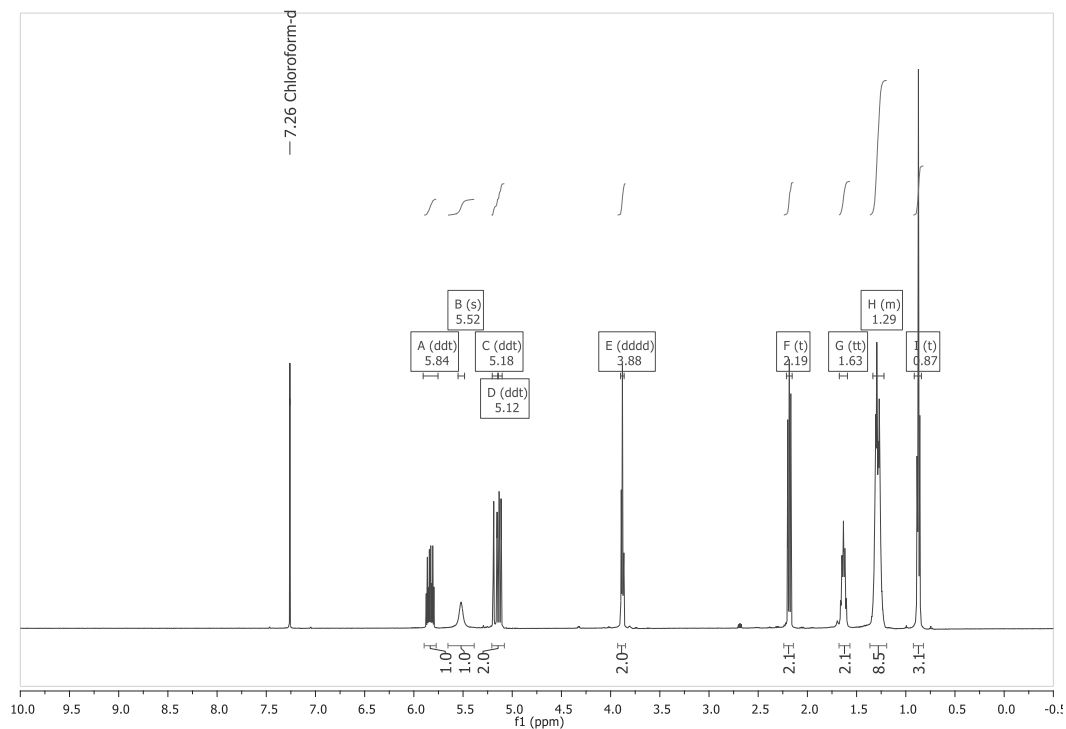
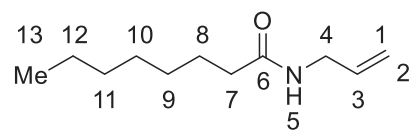
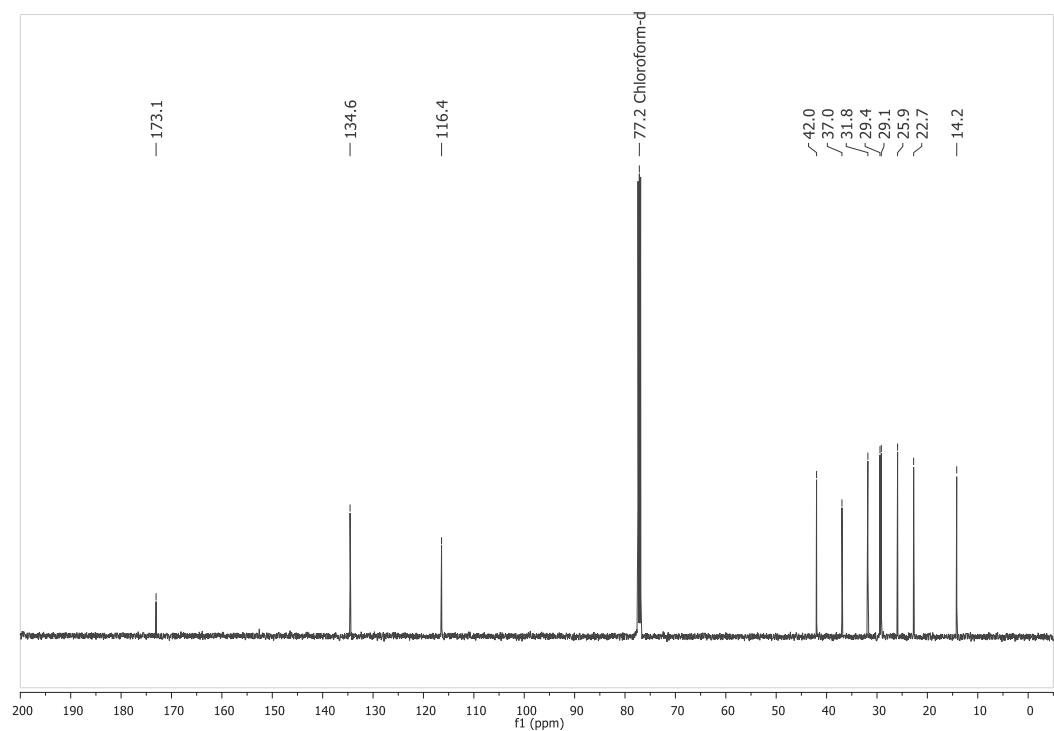
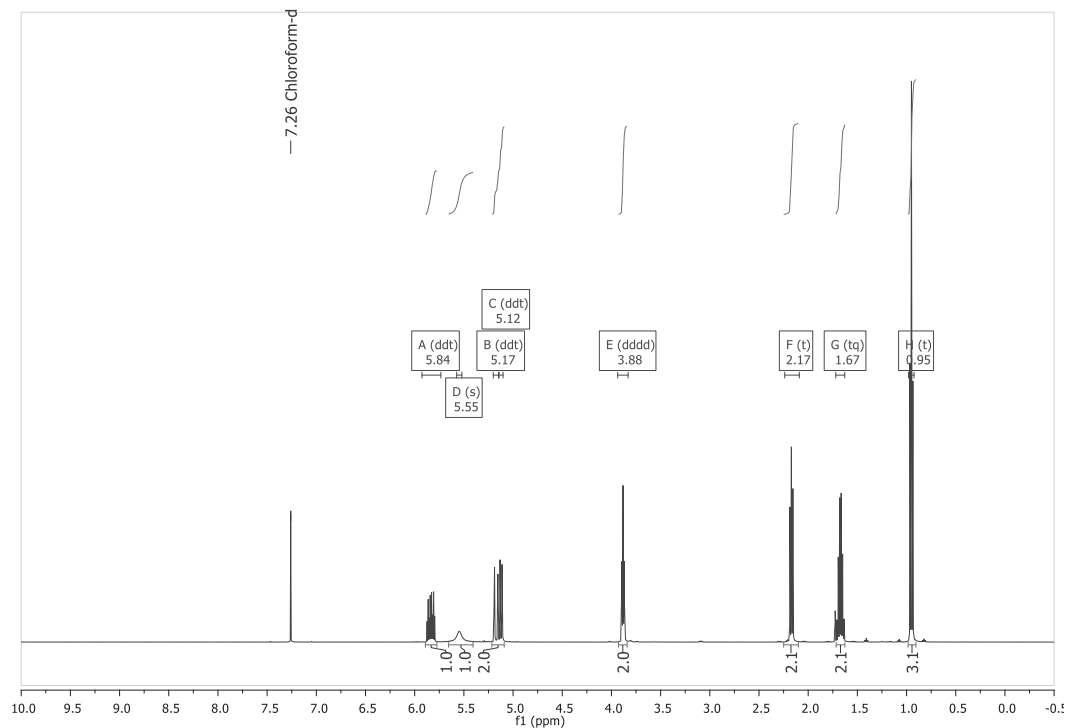
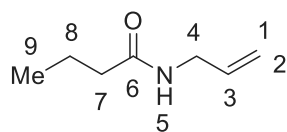
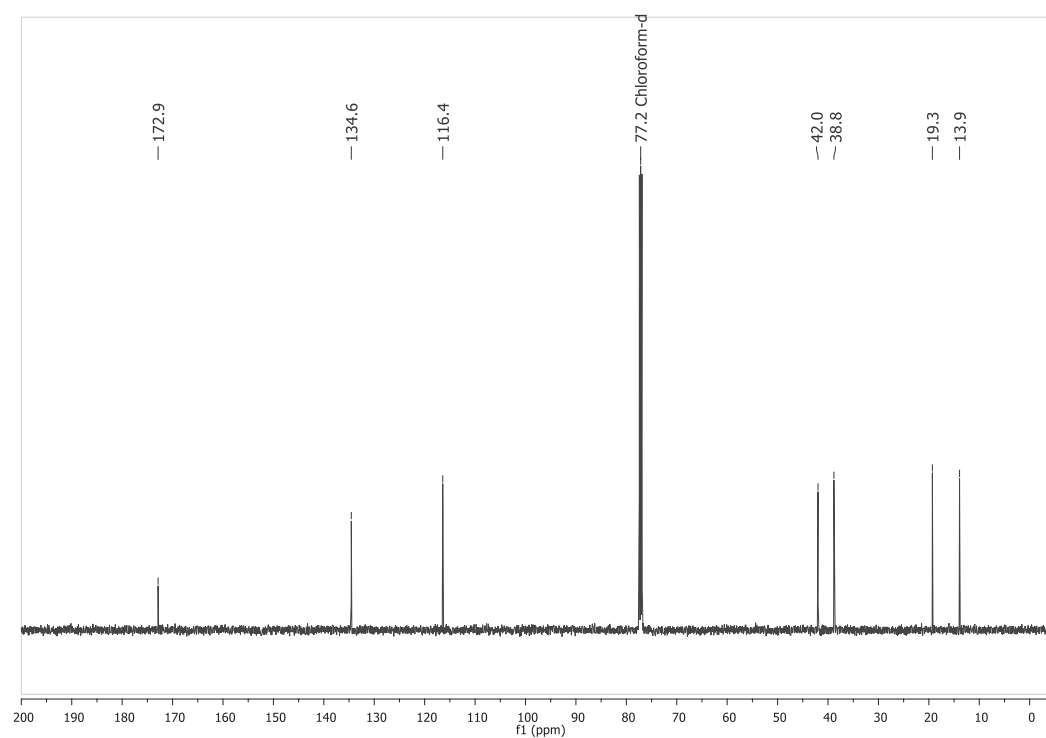
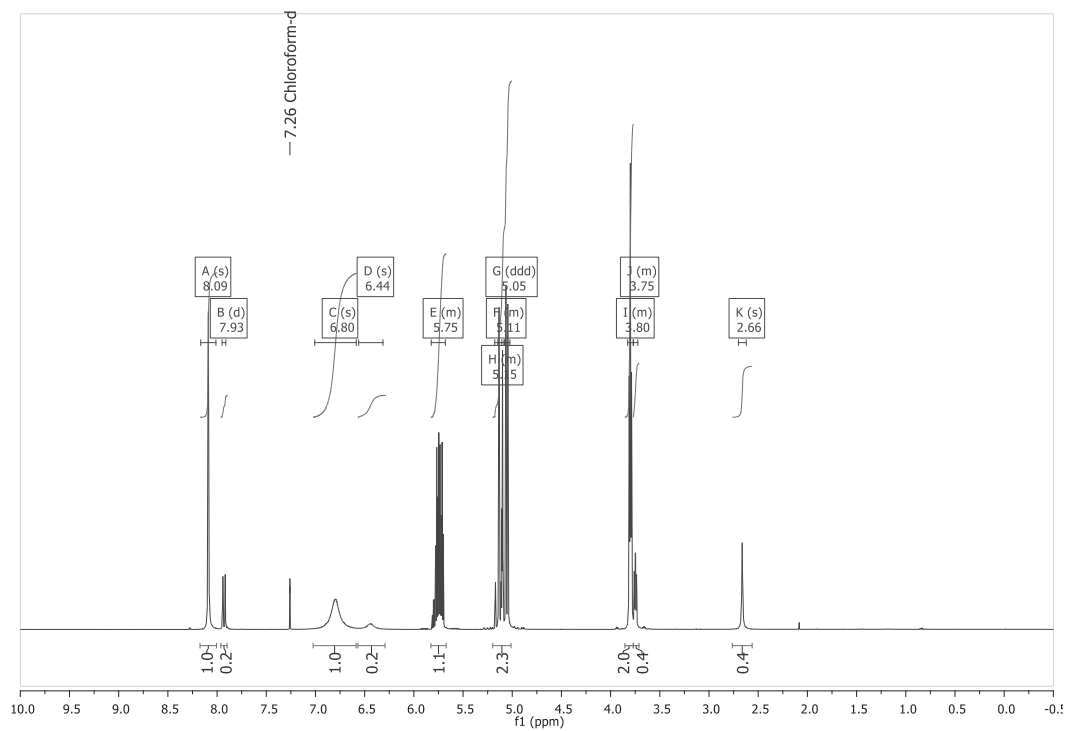
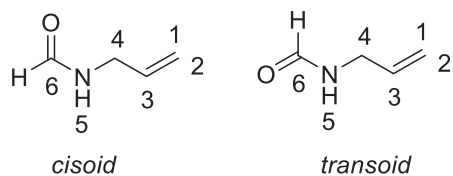
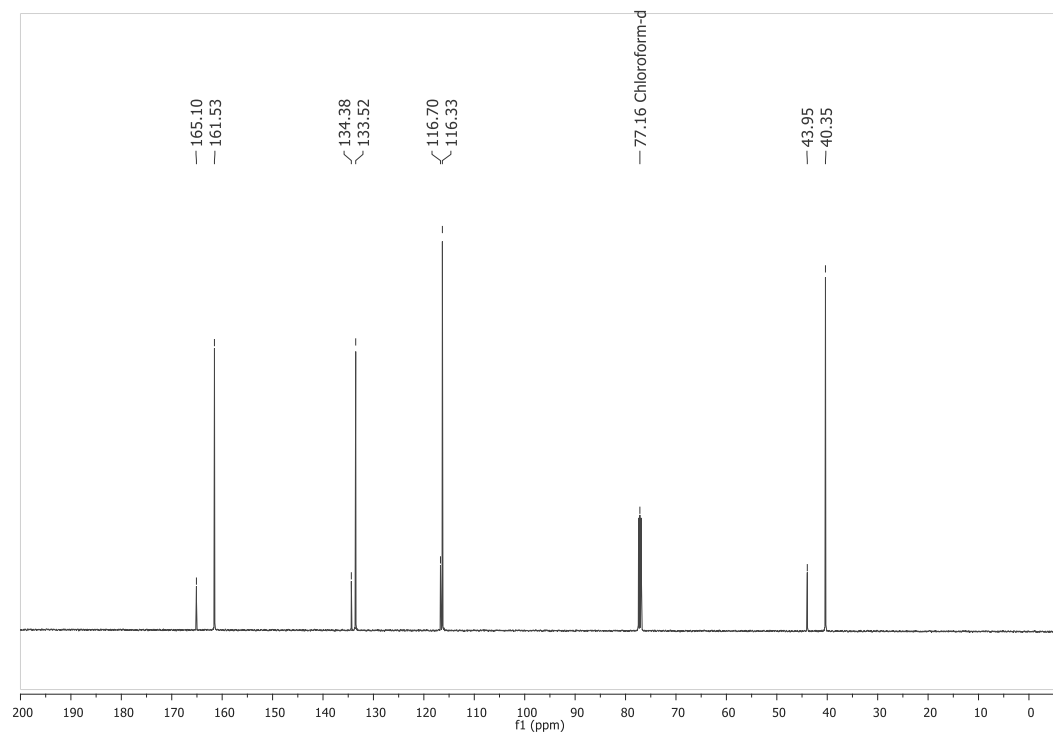
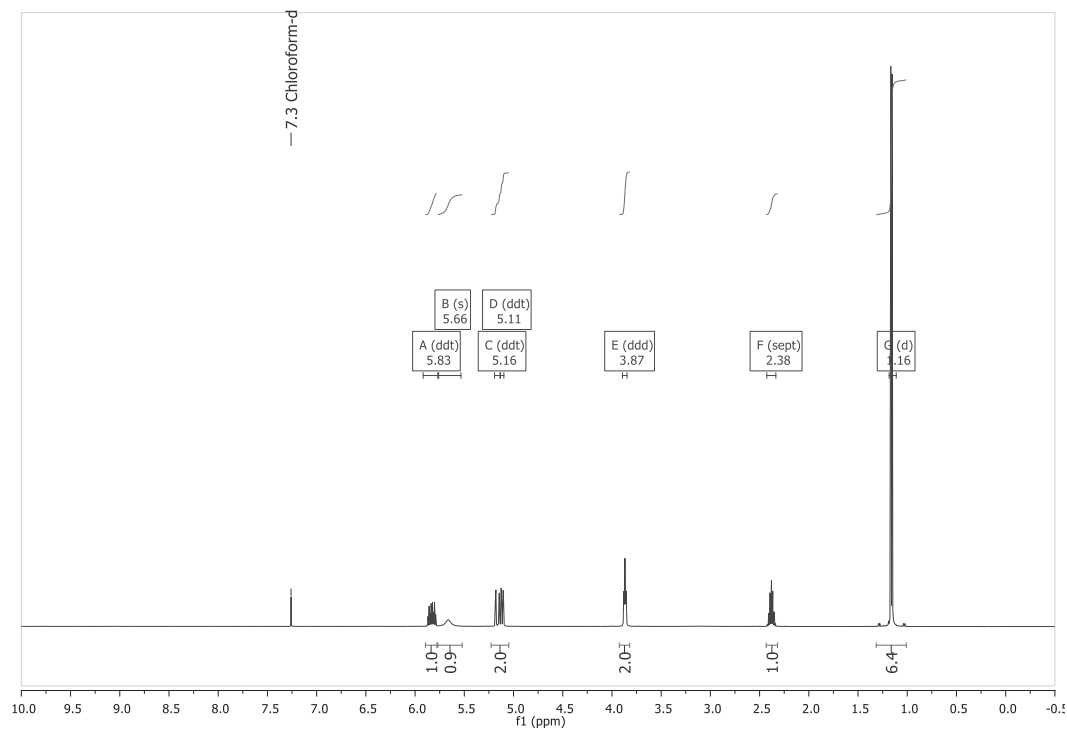
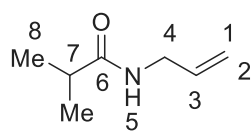
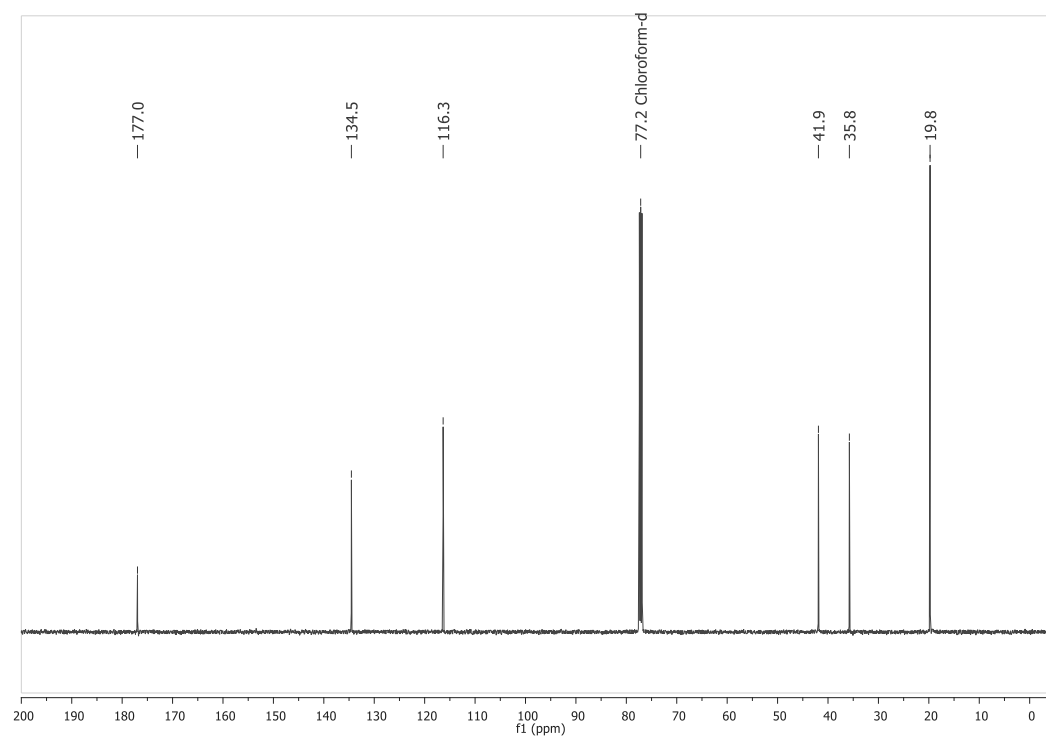


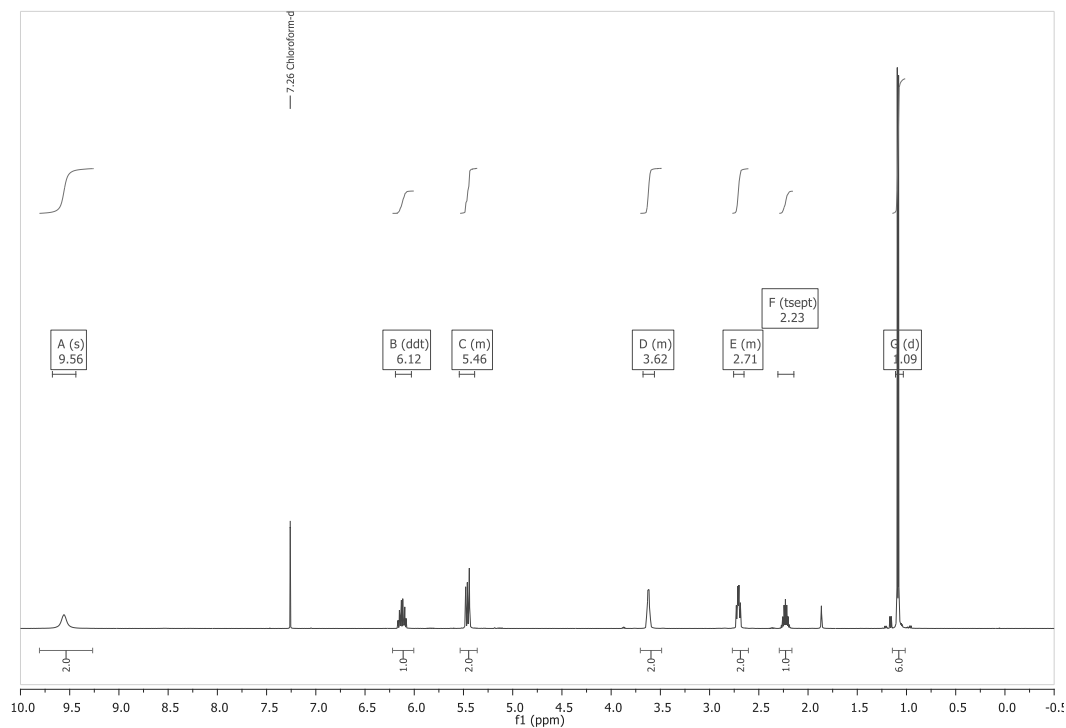
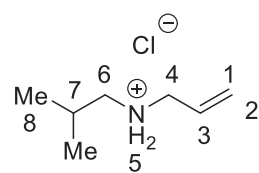
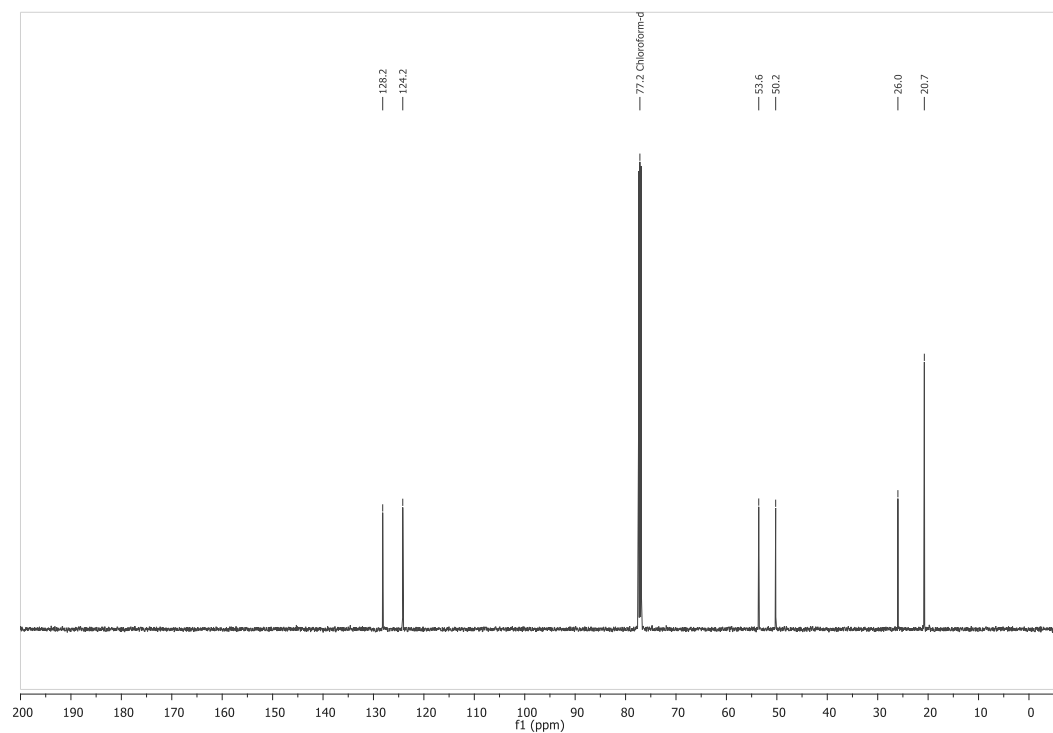
Figure SI-10 ^{13}C NMR spectrum of *N*-allyl-*N*-benzylamine **8**.

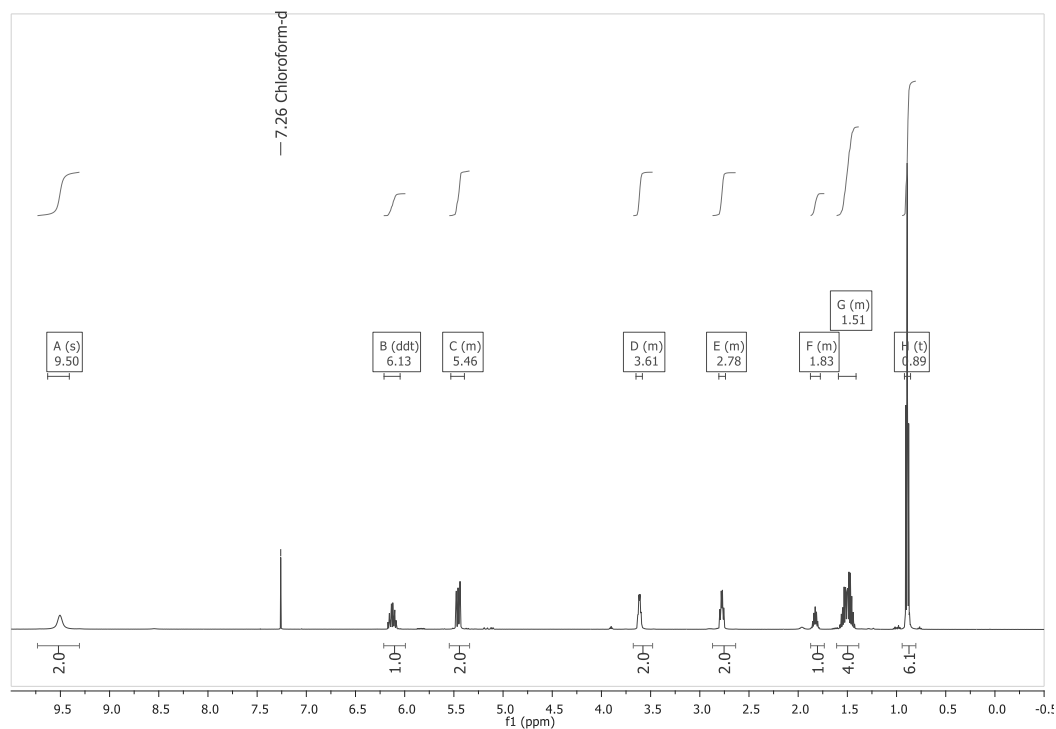
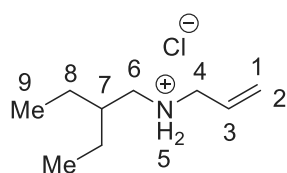
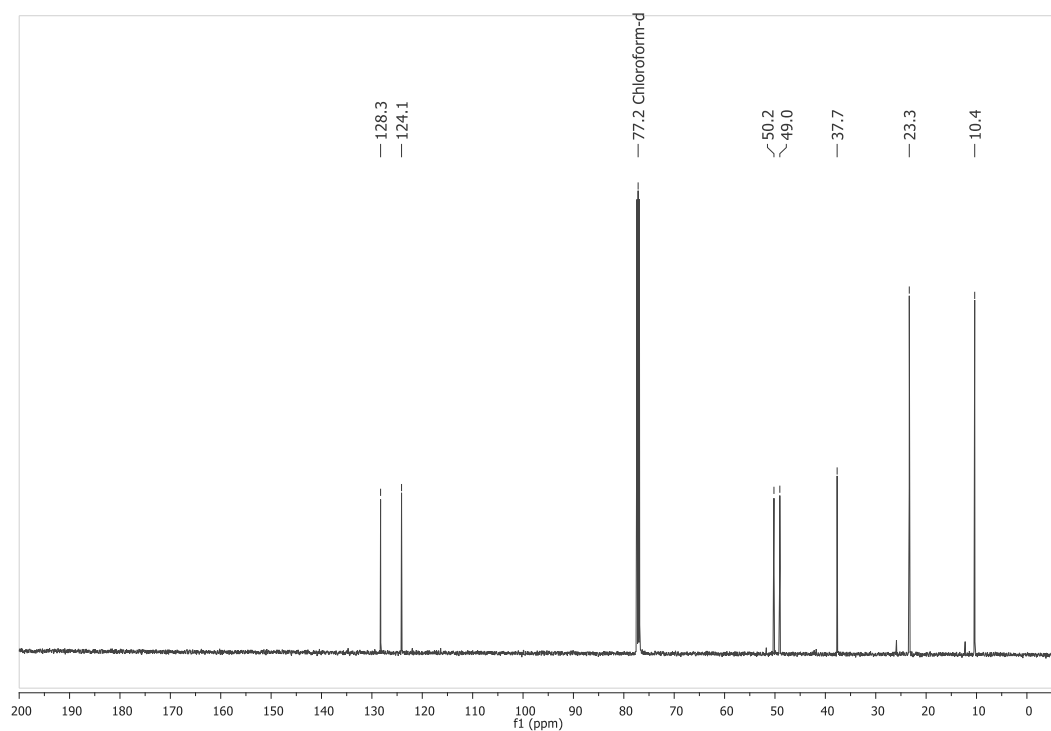
***N*-Allyloctanamide (9)****Figure SI-11** ^1H NMR spectrum of *N*-allyloctanamide 9.**Figure SI-12** ^{13}C NMR spectrum of *N*-allyloctanamide 9.

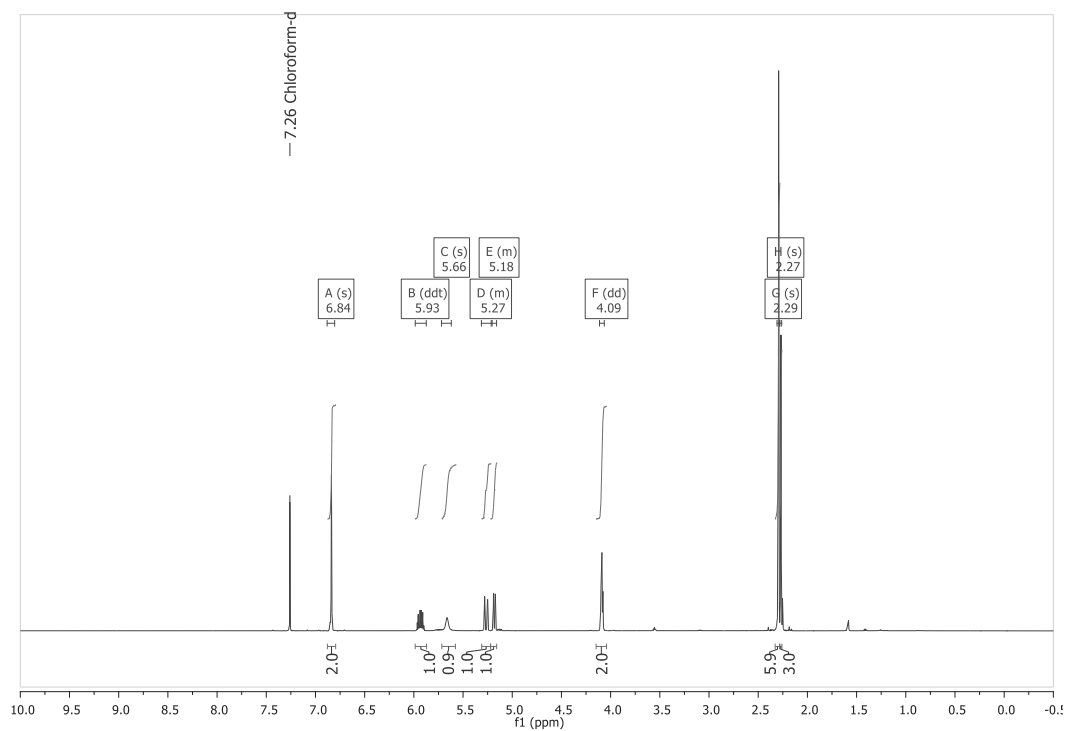
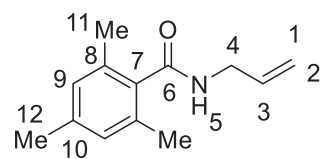
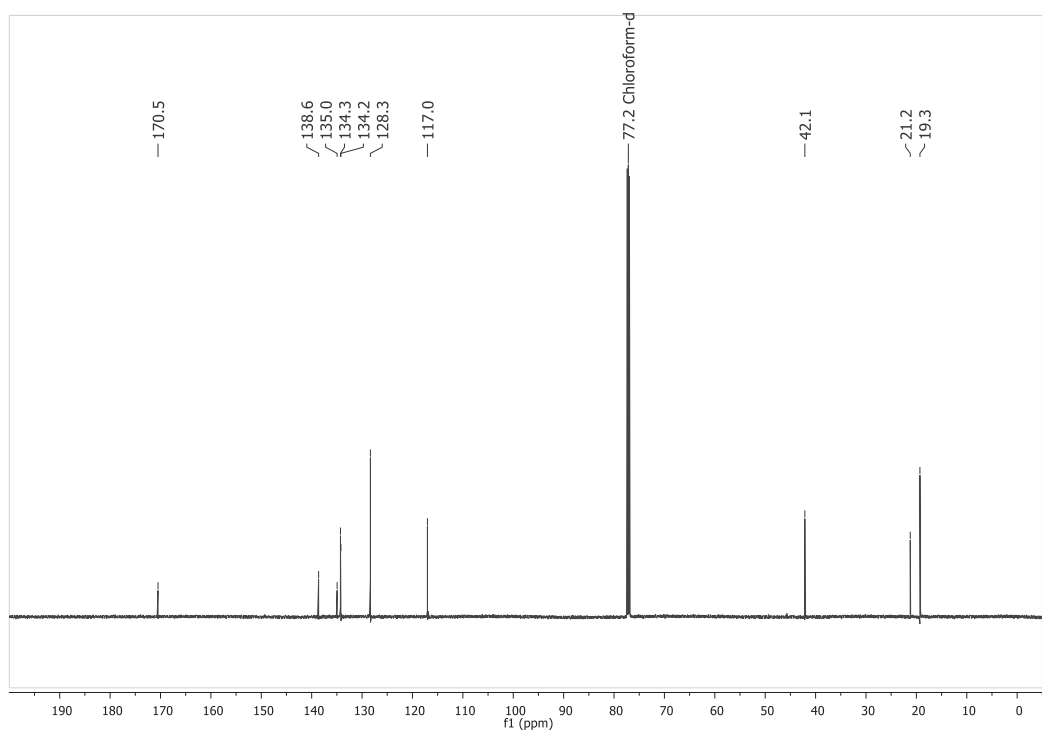
***N*-Allylbutanamide (10)****Figure SI-13** ^1H NMR spectrum of *N*-allylbutanamide **10**.**Figure SI-14** ^{13}C NMR spectrum of *N*-allylbutanamide **10**.

***N*-Allylformamide (11)****Figure SI-15** ^1H NMR spectrum of *N*-allylformamide **11**.**Figure SI-16** ^{13}C NMR spectrum of *N*-allylformamide **11**.

***N*-Allylisobutyramide (13)****Figure SI-17** ^1H NMR spectrum of *N*-allylisobutyramide **13**.**Figure SI-18** ^{13}C NMR spectrum of *N*-allylisobutyramide **13**.

***N*-Allylisobutanamine hydrochloride (14)****Figure SI-19** ^1H NMR spectrum of *N*-allylisobutanamine hydrochloride **14**.**Figure SI-20** ^{13}C NMR spectrum of *N*-allylisobutanamine hydrochloride **14**.

***N*-Allyl-2-ethylbutanamine (15)****Figure SI-21** ^1H NMR spectrum of *N*-allyl-2-ethylbutanamine **15**.**Figure SI-22** ^{13}C NMR spectrum of *N*-allyl-2-ethylbutanamine **15**.

***N*-Allyl-(2,4,6-trimethyl)benzamide (16)****Figure SI-23** ^1H NMR spectrum of *N*-allyl-2,4,6-trimethylbenzamide **16**.**Figure SI-24** ^{13}C NMR spectrum of *N*-allyl-2,4,6-trimethylbenzamide **16**.

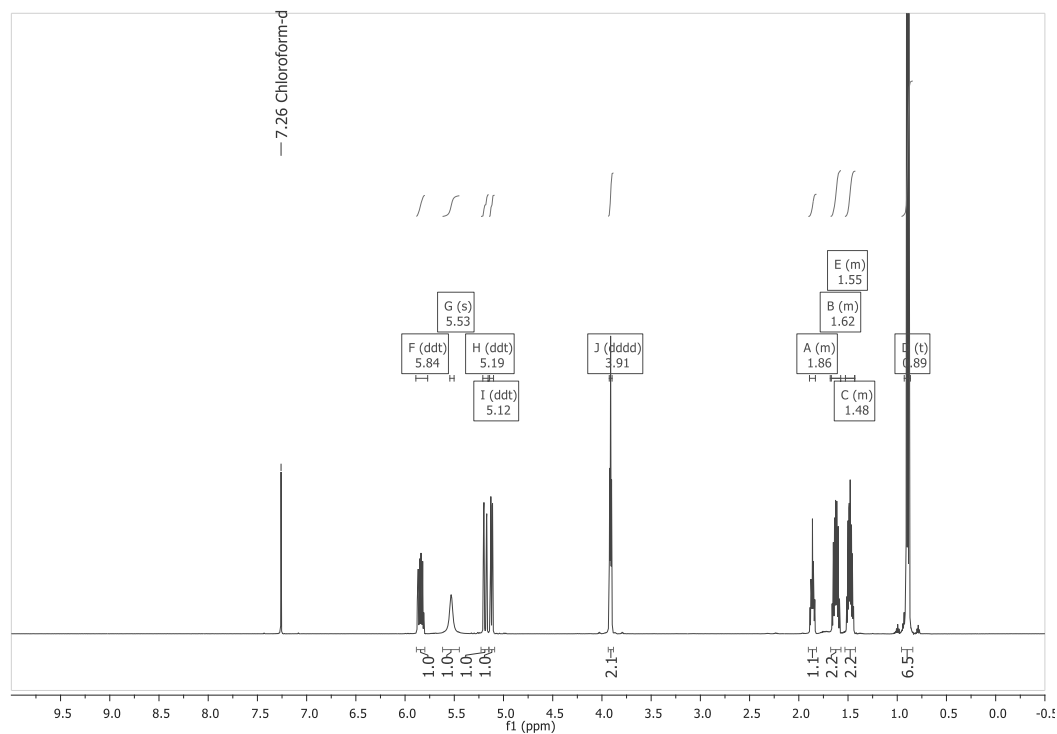
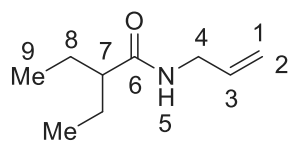
***N*-Allyl-2-ethylbutanamide (17)**

Figure SI-25 ^1H NMR spectrum of *N*-allyl-2-ethylbutanamide **17**.

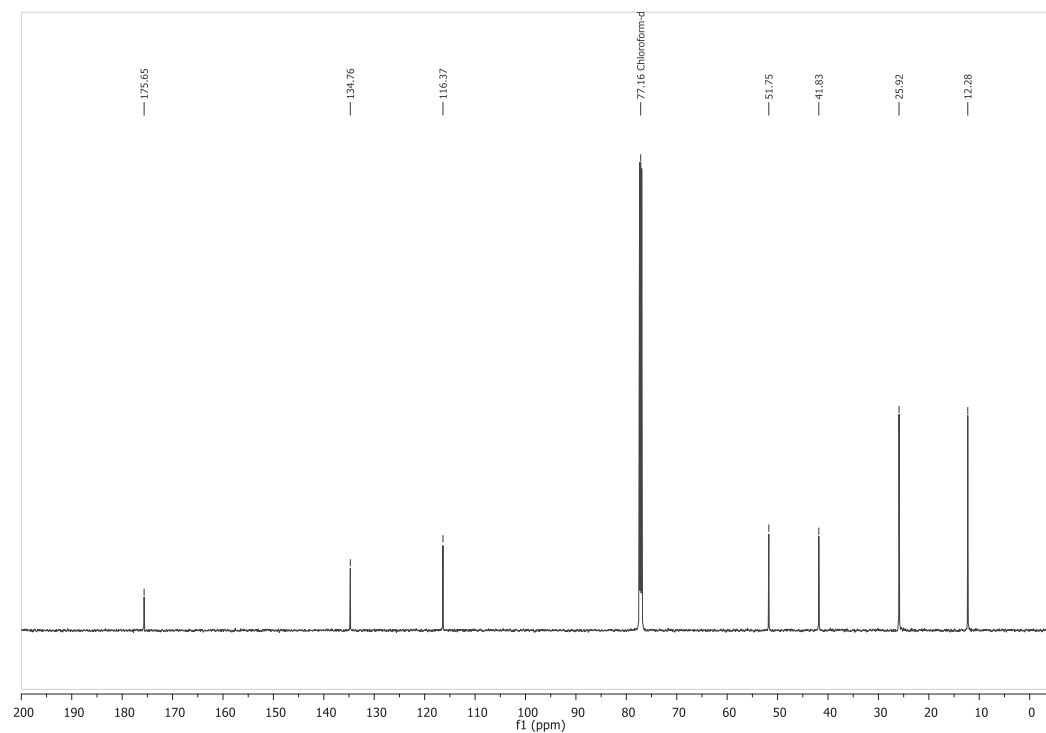
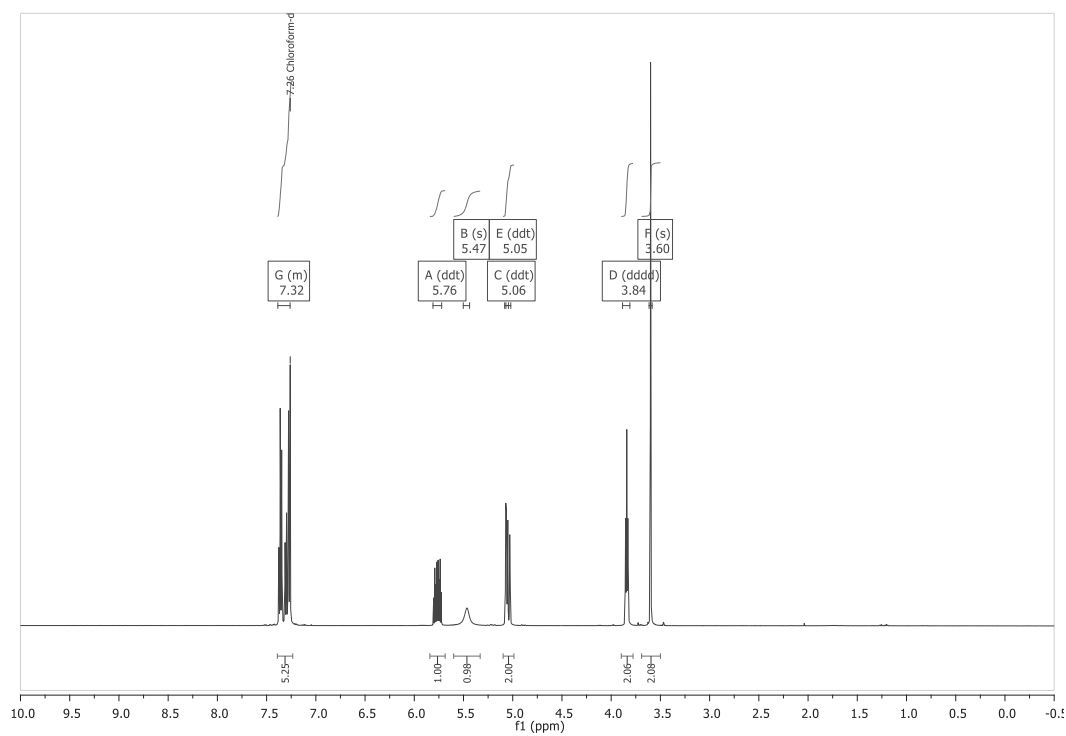
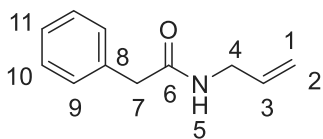
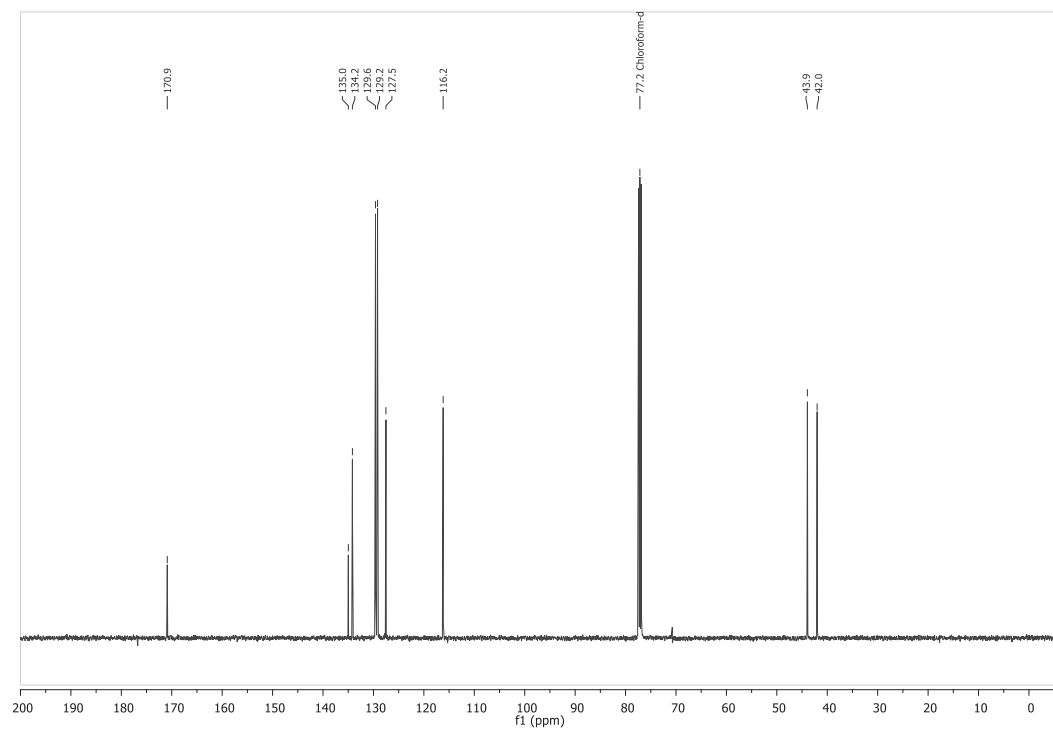


Figure SI-26 ^{13}C NMR spectrum of *N*-allyl-2-ethylbutanamide **17**.

***N*-Allyl-2-phenylacetamide (19)****Figure SI-27** ¹H NMR spectrum of *N*-allyl-2-phenylacetamide **19**.**Figure SI-28** ¹³C NMR spectrum of *N*-allyl-2-phenylacetamide **19**.

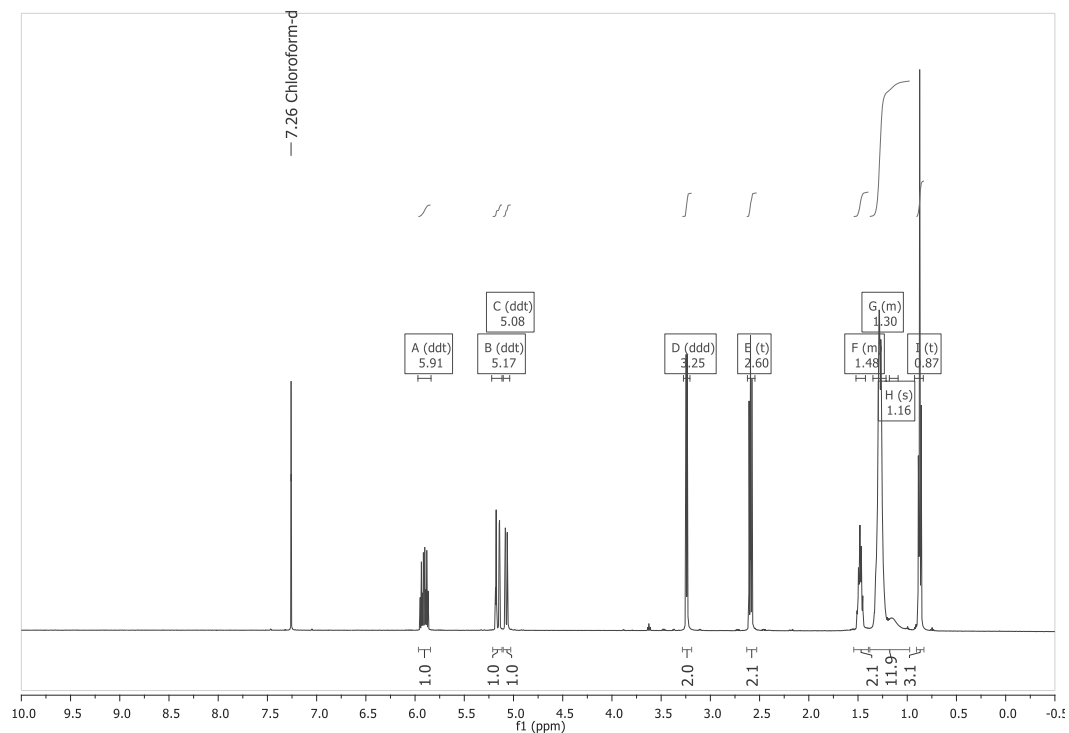
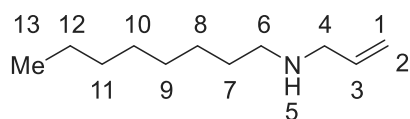
***N*-Allyloctanamine (27)**

Figure SI-29 ¹H NMR spectrum of *N*-allyloctanamine 27.

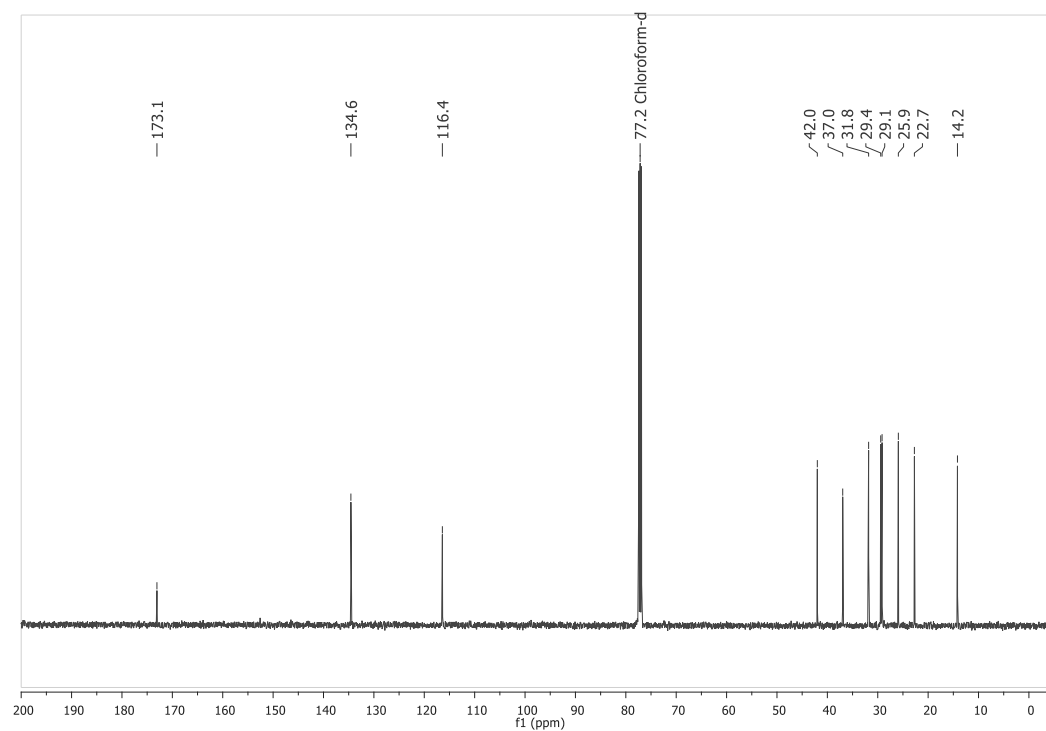
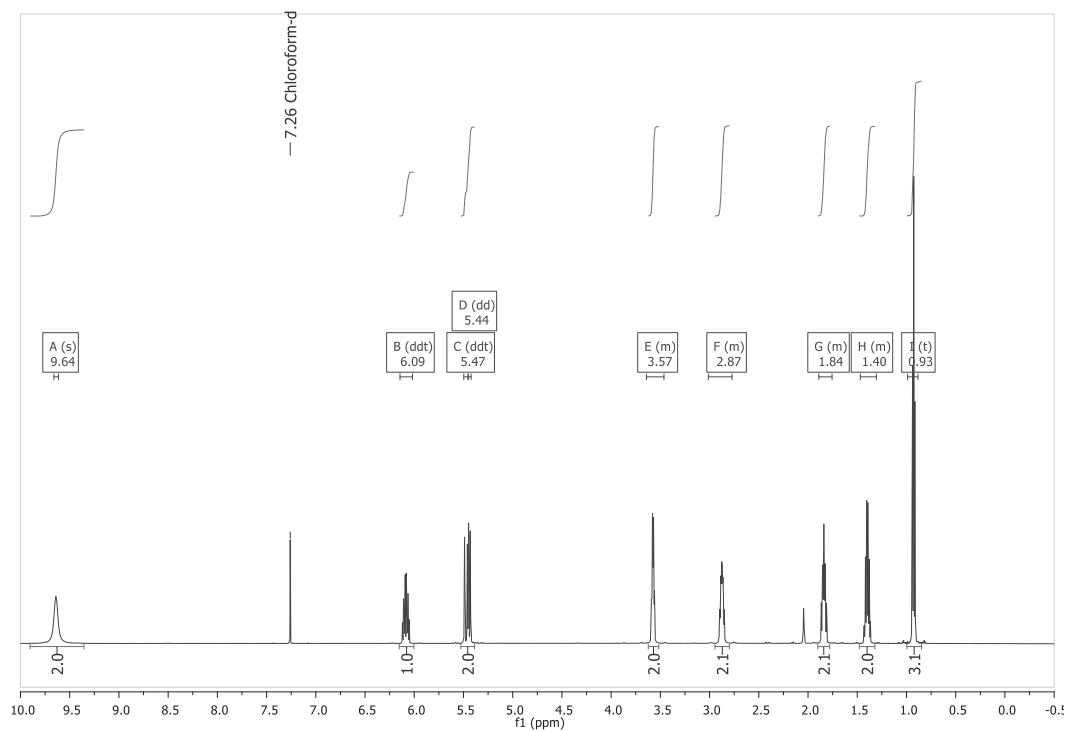
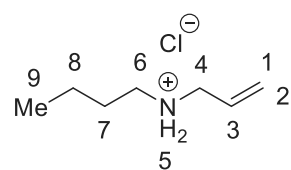
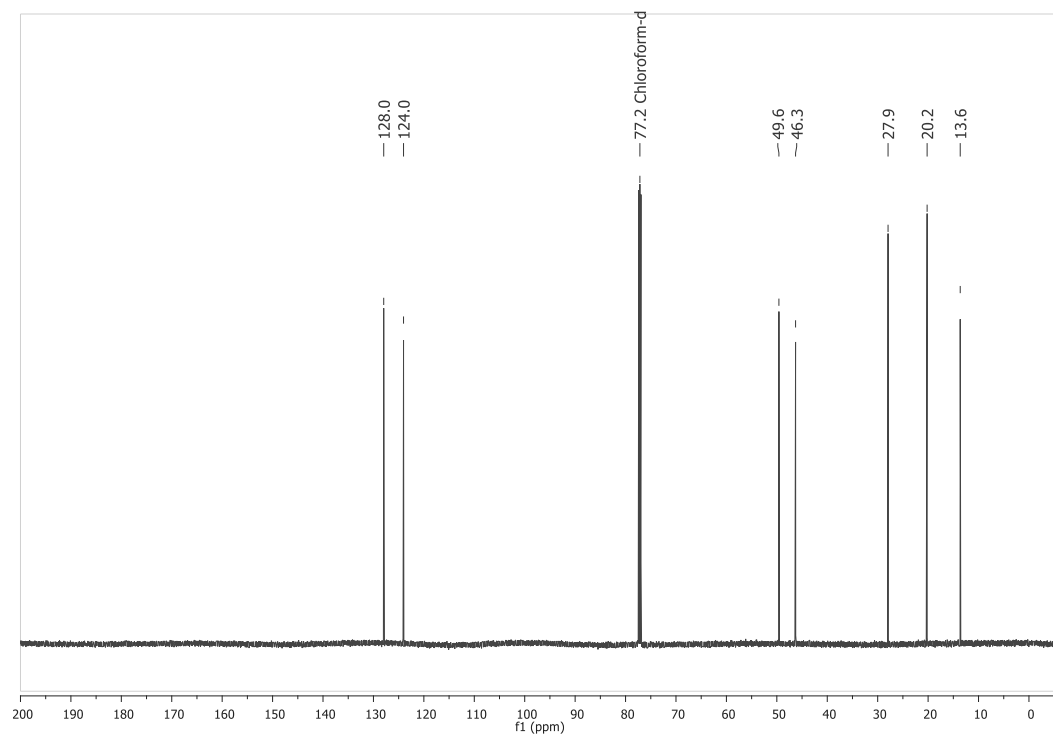


Figure SI-30 ¹³C NMR spectrum of *N*-allyloctanamine 27.

***N*-Allylbutanamine hydrochloride (28)****Figure SI-31** ^1H NMR spectrum of *N*-allylbutanamine **28**.**Figure SI-32** ^{13}C NMR spectrum of *N*-allylbutanamine **28**.

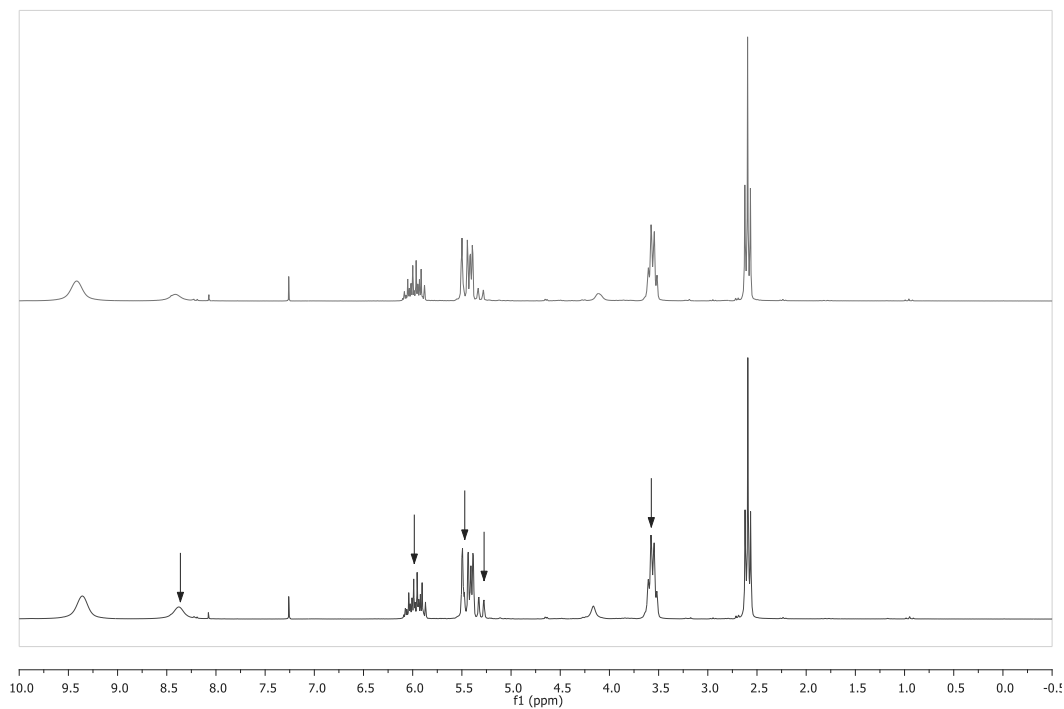
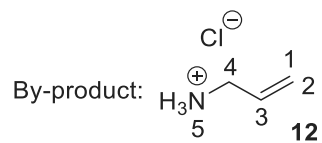
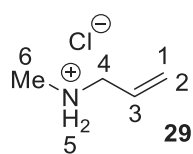
***N*-Allylmethylamine hydrochloride (29)**

Figure SI-33 a) ¹H NMR spectrum of *N*-allylmethylamine hydrochloride **29** contaminated with allylamine hydrochloride **12**; b) ¹H NMR spectrum of *N*-allylmethylamine hydrochloride **29** contaminated with allylamine hydrochloride **12**; To prove allylamine hydrochloride **12** as by-product, low amount of **12** was added to the crude mixture; No new signals appeared, only the signal integrals changed (marked with arrows).

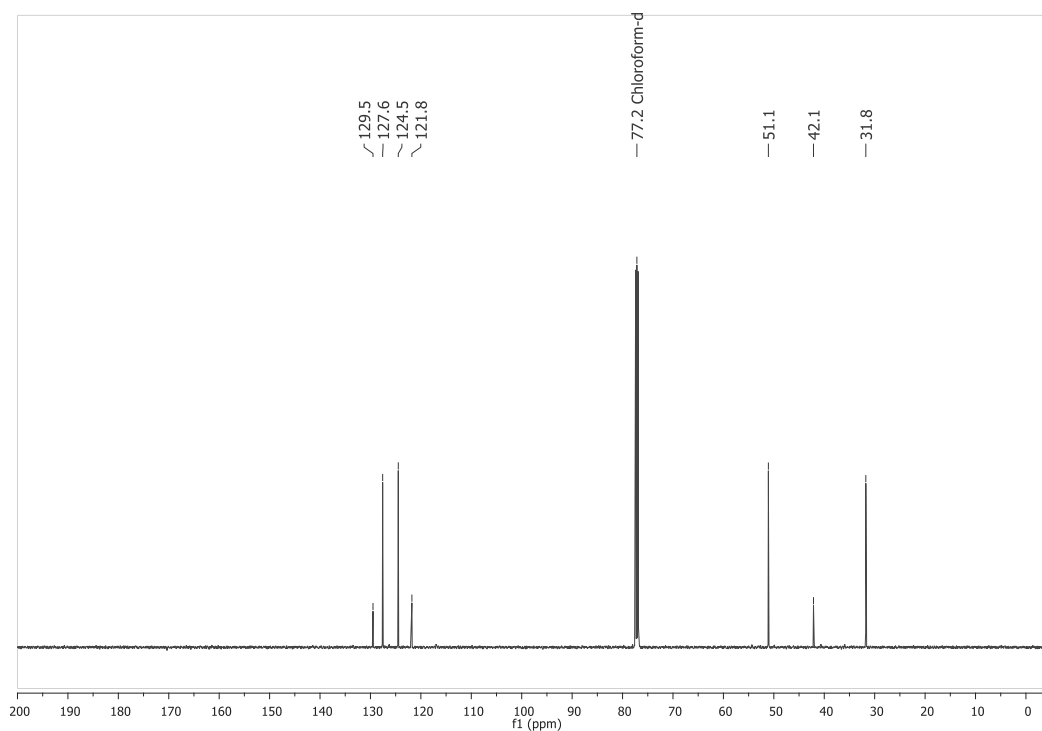


Figure SI-34 ^{13}C NMR spectrum of *N*-allylmethylamine hydrochloride **29** contaminated with allylamine hydrochloride **12**.

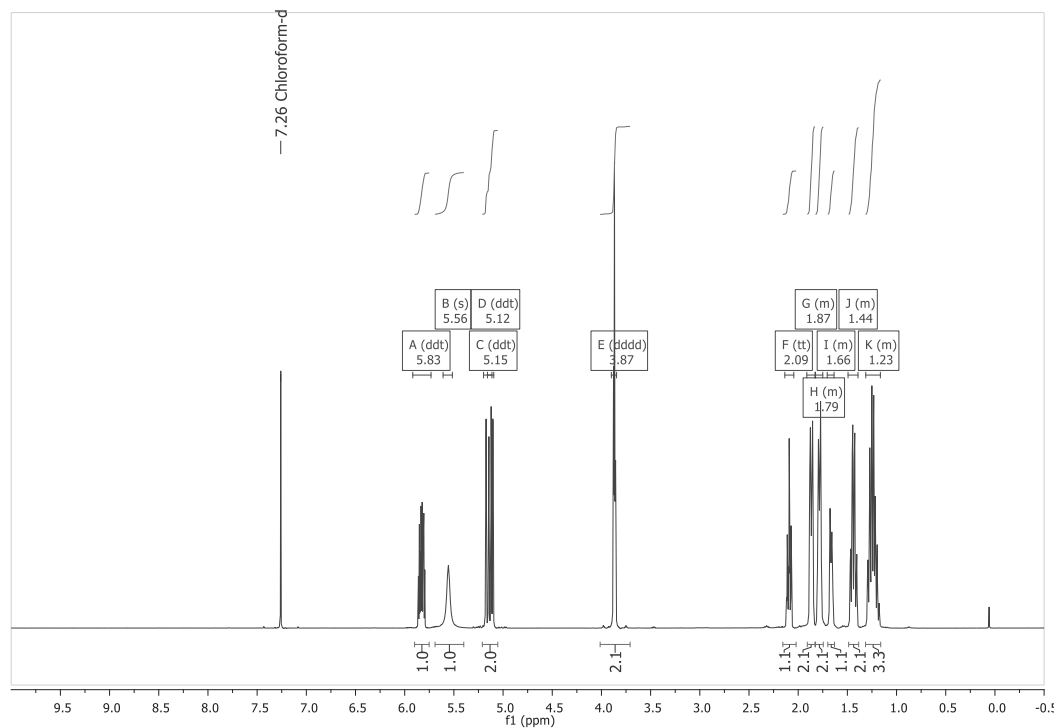
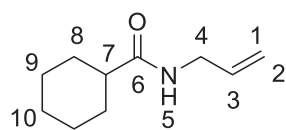
***N*-Allylcyclohexanamide (30)**

Figure SI-35 ^1H NMR spectrum of *N*-allylcyclohexanamide **30**.

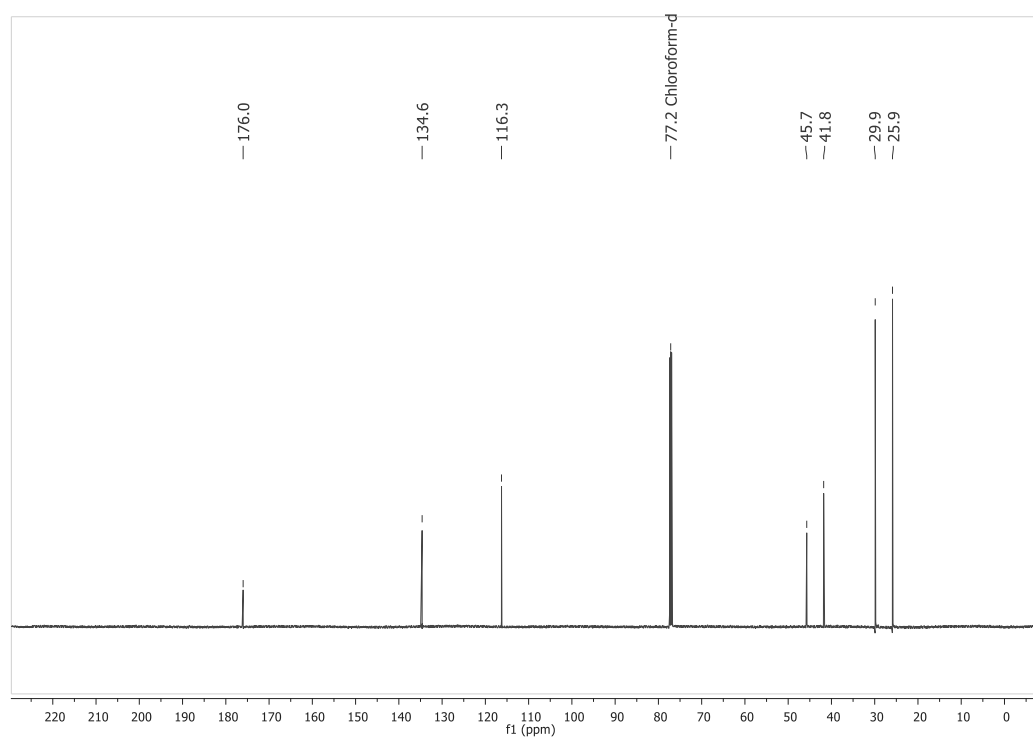
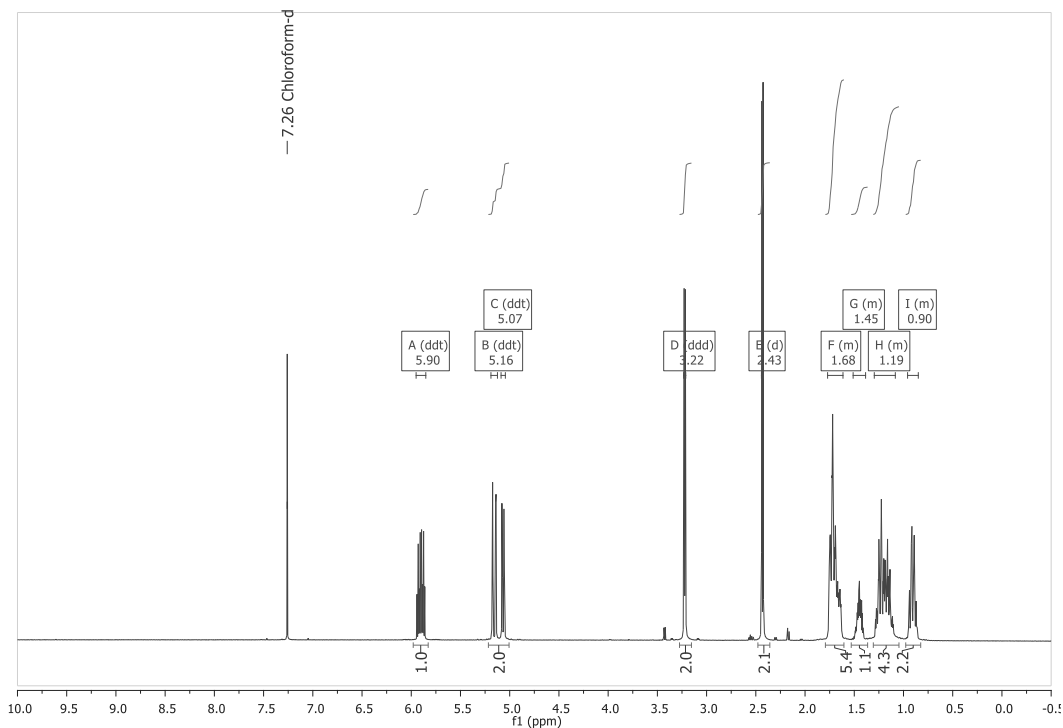
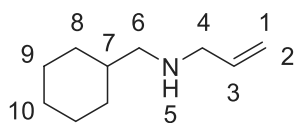
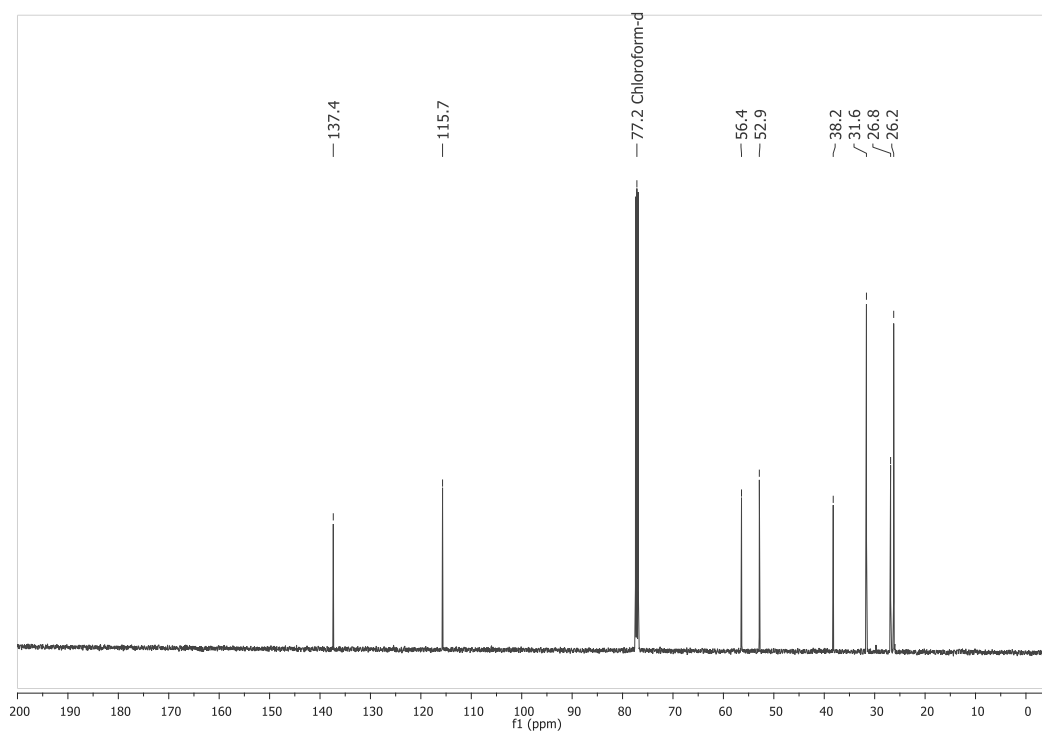
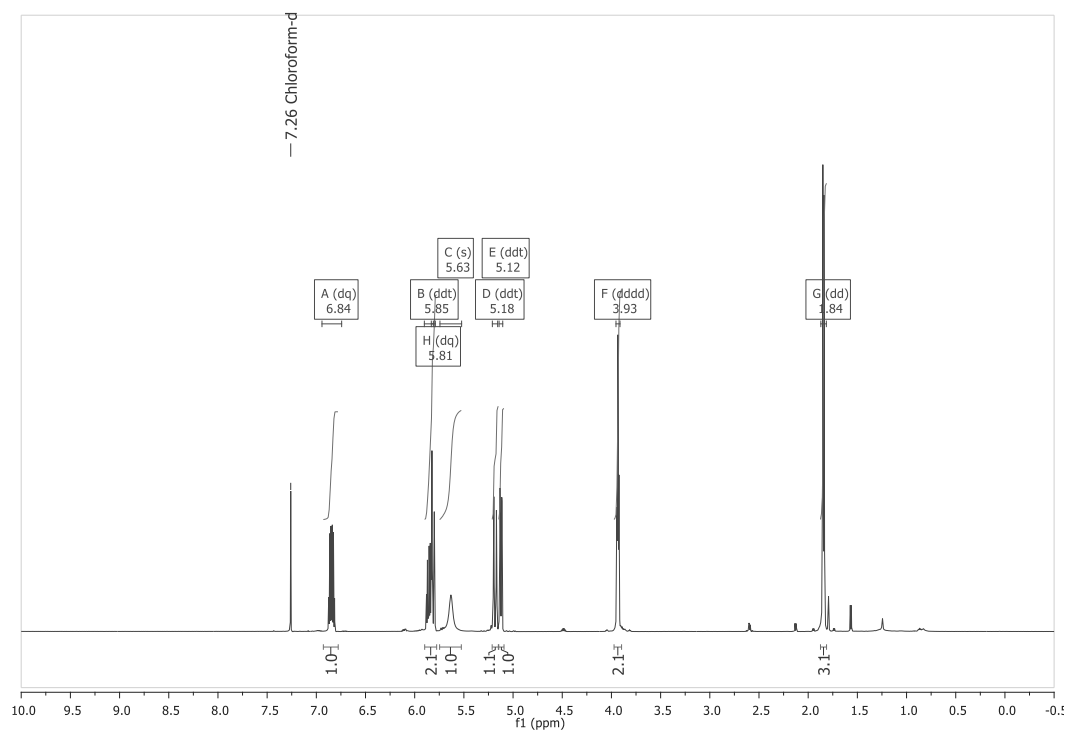
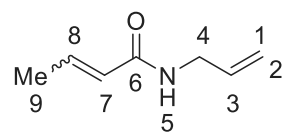
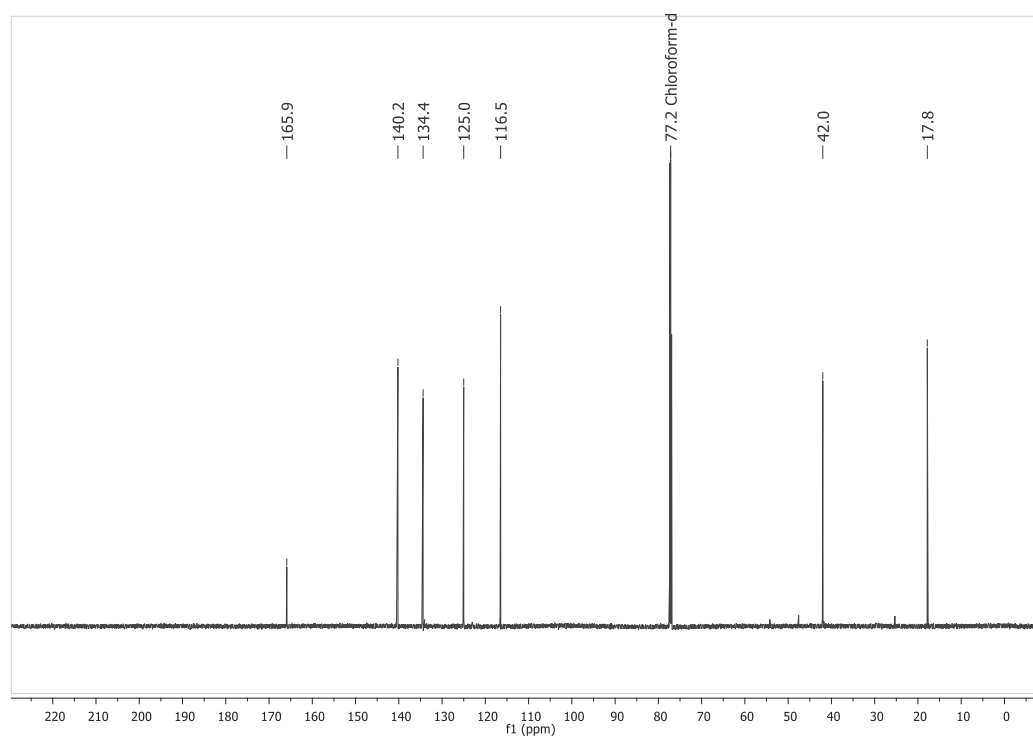


Figure SI-36 ^{13}C NMR spectrum of *N*-allylcyclohexanamide **30**.

***N*-Allyl-(cyclohexylmethan)amine (31)****Figure SI-37** ^1H NMR spectrum of *N*-allyl-(cyclohexylmethan)amine **31**.**Figure SI-38** ^{13}C NMR spectrum of *N*-allyl-(cyclohexylmethan)amine **31**.

***N*-Allylbut-2-enamide (32)****Figure SI-39** ^1H NMR spectrum of *N*-allylbut-2-enamide **32**.**Figure SI-40** ^{13}C NMR spectrum of *N*-allylbut-2-enamide **32**.

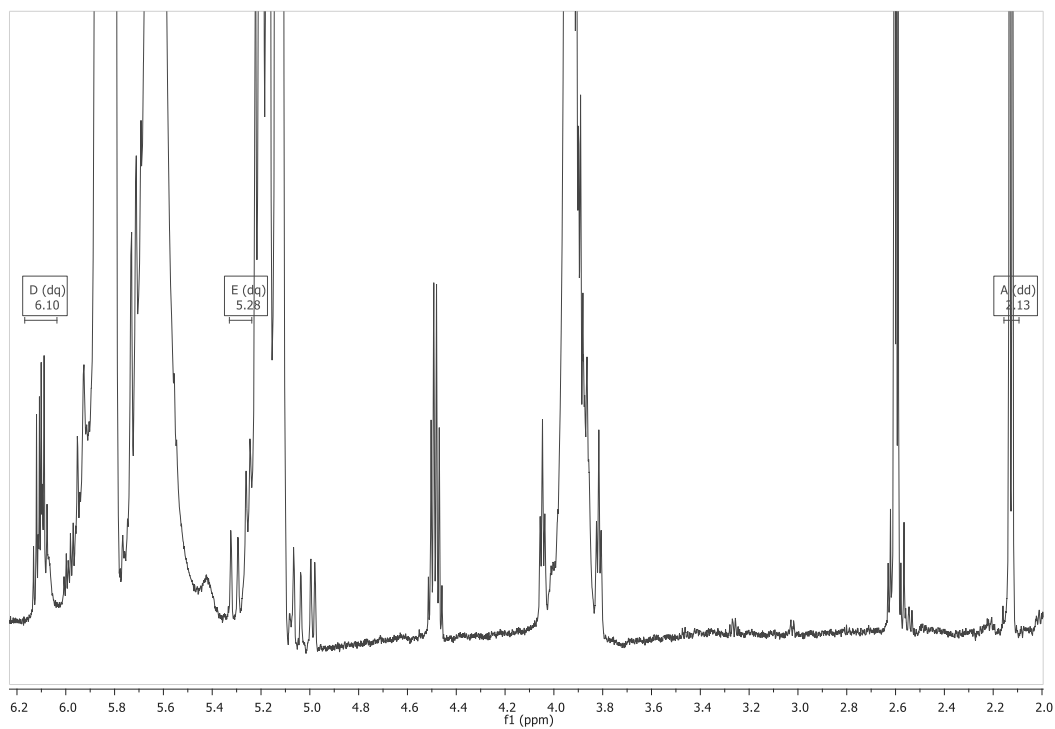
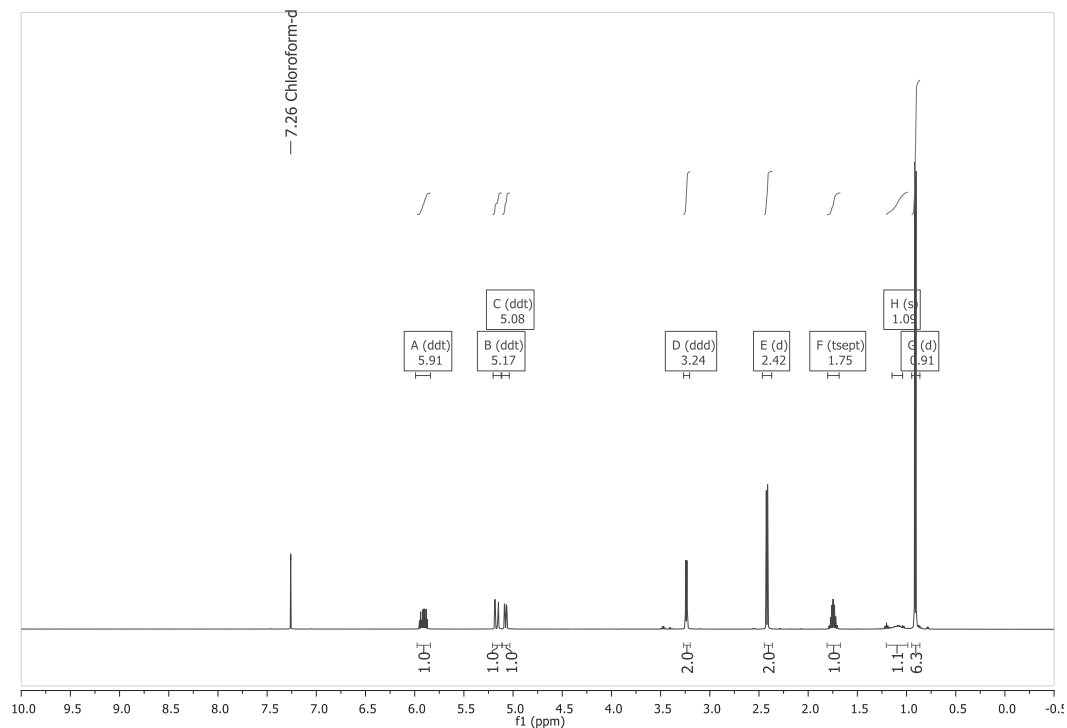
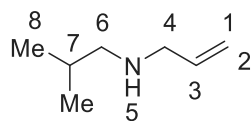
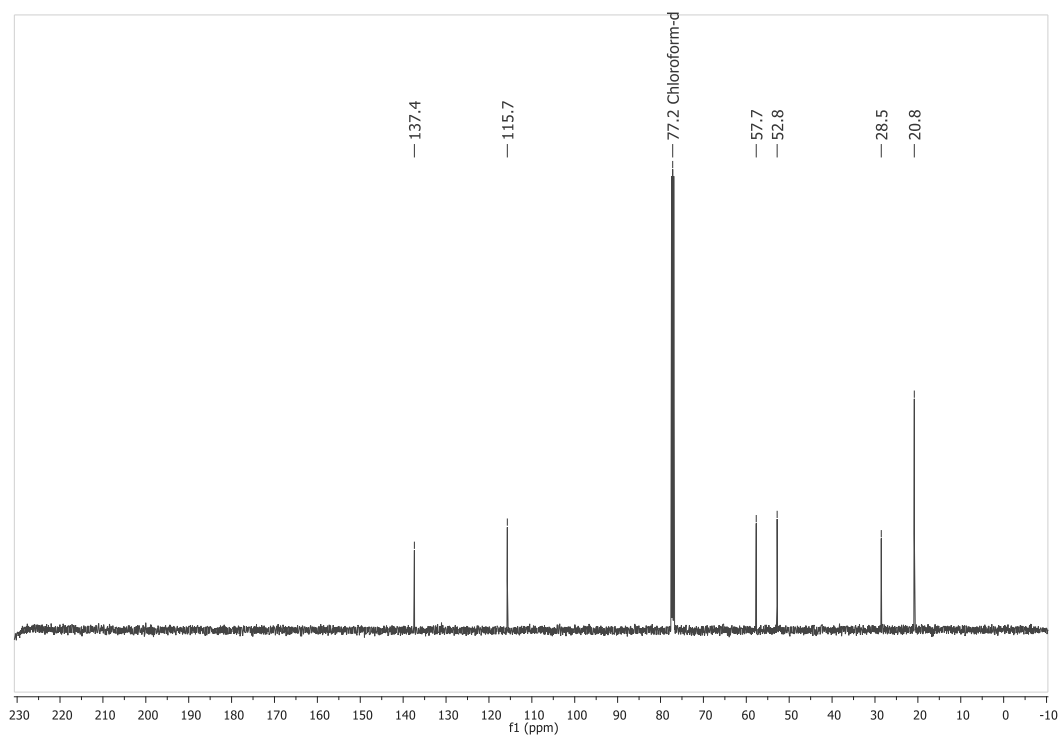
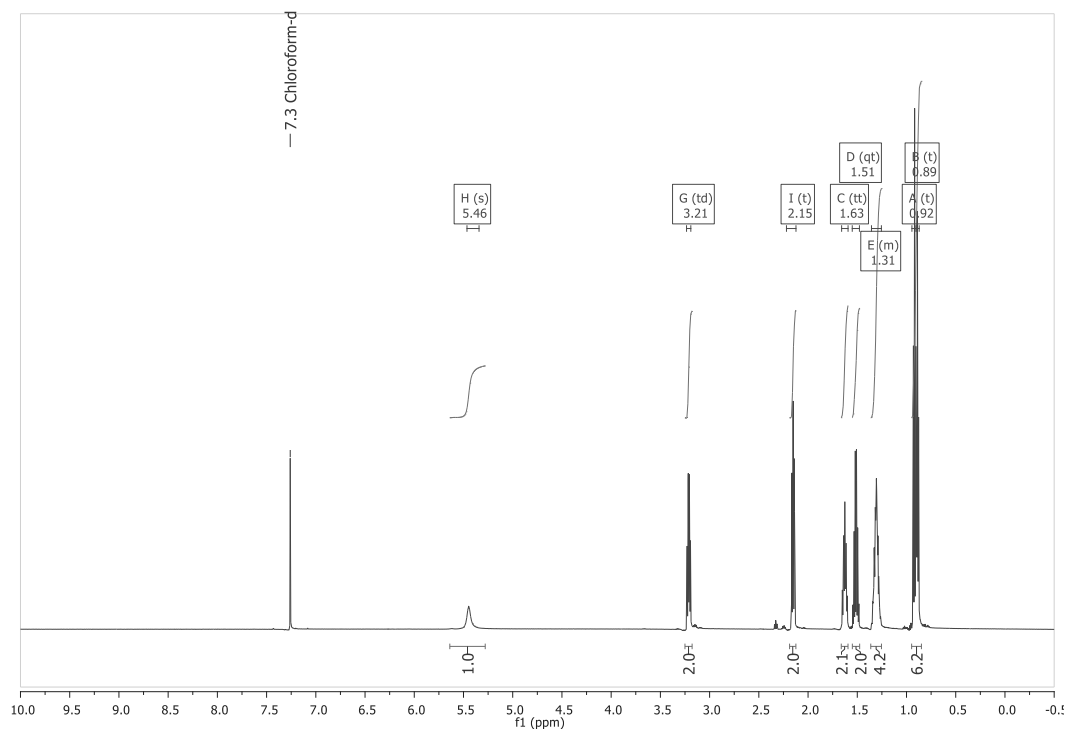
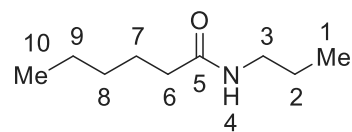
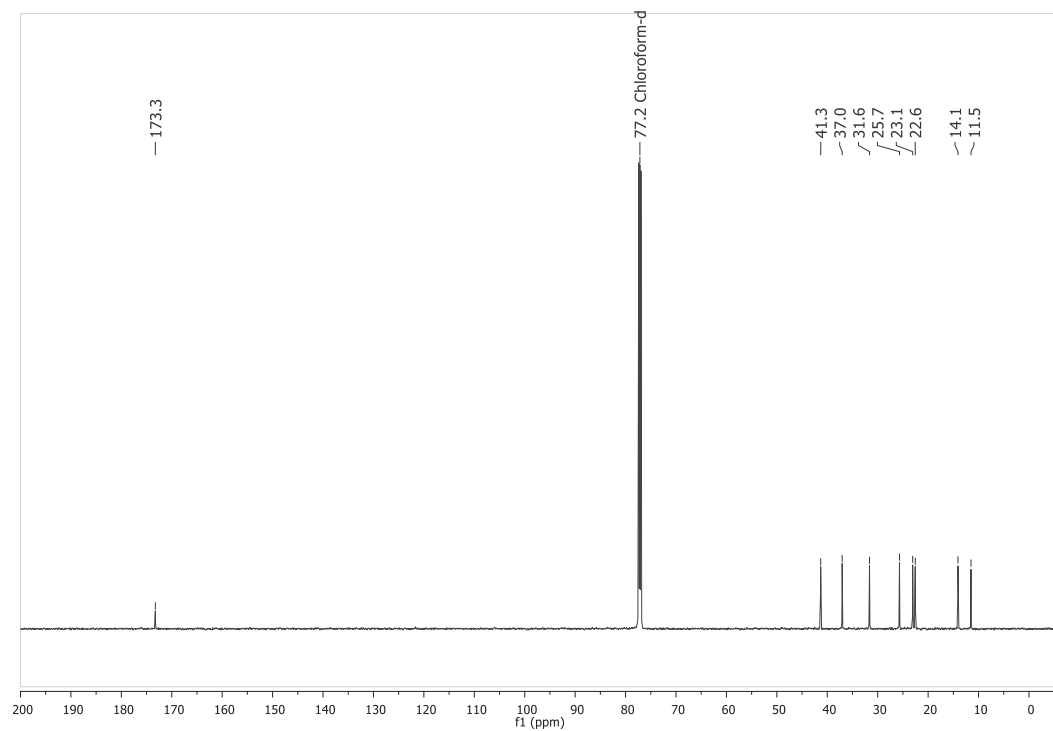
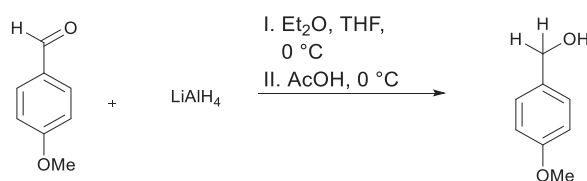


Figure SI-41 ¹H NMR spectrum of *N*-allylbut-2-enamide **32** – peak labeling for the *cis* product.

***N*-Allylisobutanamine (33)****Figure SI-42** ^1H NMR spectrum of *N*-allylisobutanamine **33**.**Figure SI-43** ^{13}C NMR spectrum of *N*-allylisobutanamine **33**.

***N*-Propylhexanamide (34)****Figure SI-44** ^1H NMR spectrum of *N*-Propylhexanamide 34.**Figure SI-45** ^{13}C NMR spectrum of *N*-Propylhexanamide 34.

LiAlH₄ Titration¹

Under a nitrogen atmosphere, an accurately weighed sample of *p*-anisaldehyde (ca. 1050 mg, ca. 7.7 mmol) in THF (10 mL) was cooled to 0 °C. A precisely measured volume of LiAlH₄ solution (ca. 1.30 mmol, ca. 50 mg in 2 mL Et₂O) was added dropwise over ca. 60 s. The mixture was stirred for 5 min, and glacial acetic acid (2 mL) was added rapidly (ca. 5-10 s) with vigorous stirring. An aliquot of the resulting homogeneous solution (ca. 0.6 mL) was transferred to a 5 mm NMR tube. The tube was capped and the spectrum was recorded.

Calculation:

$$[\text{LiAlH}_4] = \frac{[\text{st. material (mmol)}] \times [\text{conversion}]}{[\text{volume of LiAlH}_4 \text{ (mL)}]}$$

$$[\text{conversion}] = \frac{\text{integral of product}}{(\text{integral st. material}) + (\text{integral product})}$$

For calculation, integrals for the two aromatic proton signals were averaged.

¹ T. R. Hoye, A. W. Aspaas, B. M. Eklov and T. D. Ryba, *Org. Lett.*, 2005, 7, 2205.

5 Experimental Section

Results:

Titration 1

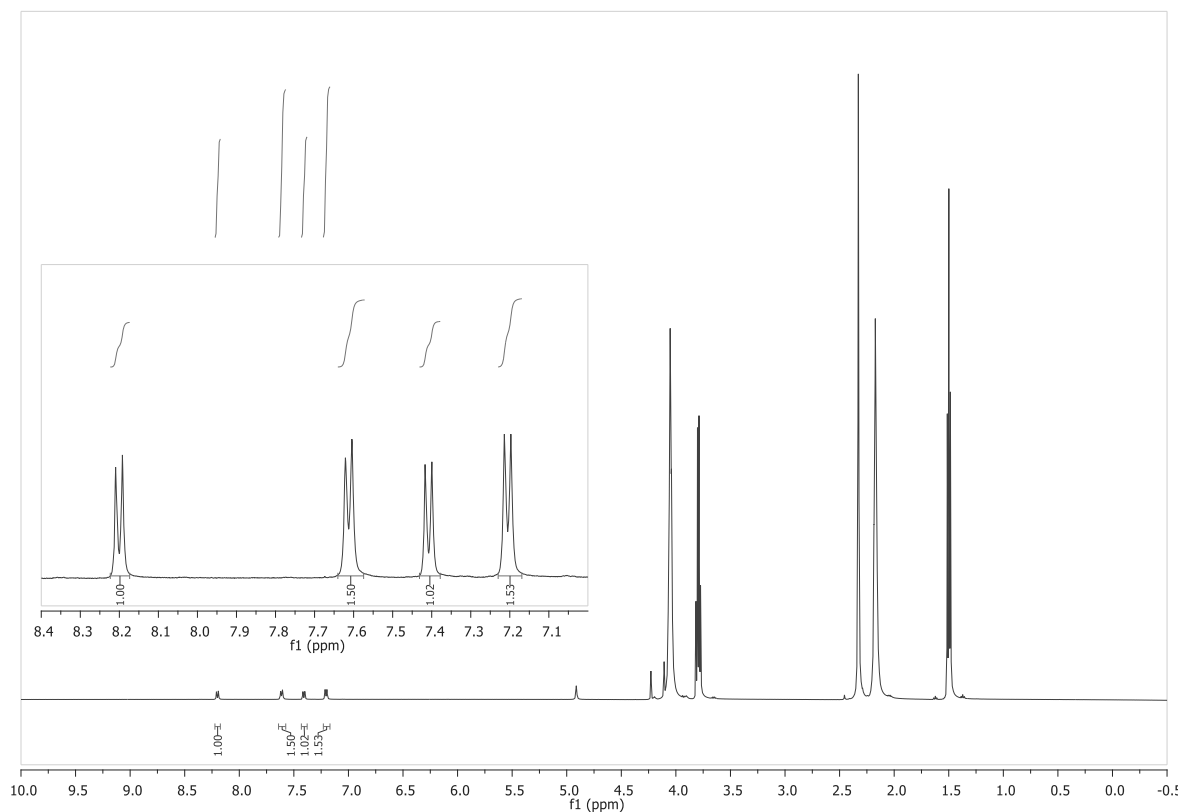


Figure SI-46 No-D ¹H NMR spectrum of the first *p*-anisaldehyde reduction which shows signals for starting material and product for determination of the LiAlH₄ purity.

$$\frac{\text{measured conc.}}{\text{theoretical conc.}} = \frac{0.78 \left[\frac{\text{mol}}{\text{L}} \right]}{0.88 \left[\frac{\text{mol}}{\text{L}} \right]} = 88 \% \text{ purity}$$

Titration 2

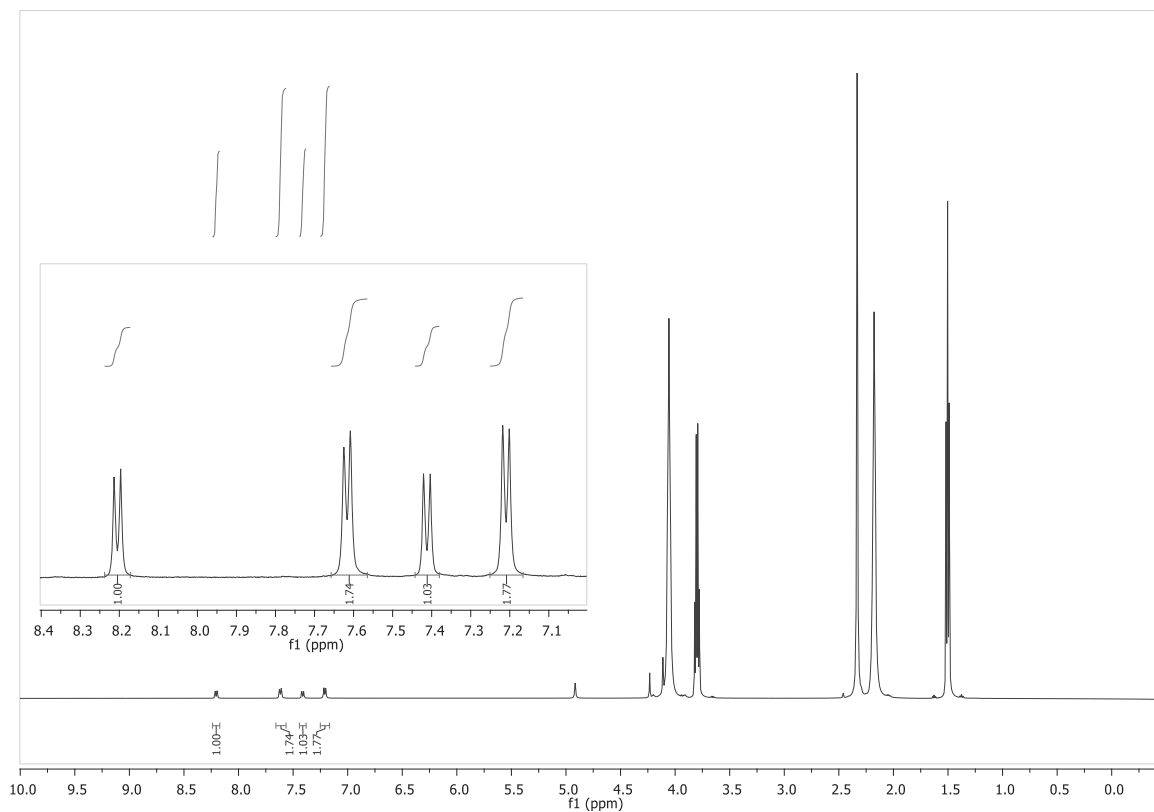


Figure SI-47 No-D ^1H NMR spectrum of the second *p*-anisaldehyde reduction which shows signals for starting material and product for determination of the LiAlH_4 purity.

$$\frac{\text{measured conc.}}{\text{theoretical conc.}} = \frac{0.81 \left[\frac{\text{mol}}{\text{L}} \right]}{0.91 \left[\frac{\text{mol}}{\text{L}} \right]} = 88 \% \text{ purity}$$

Titration 3

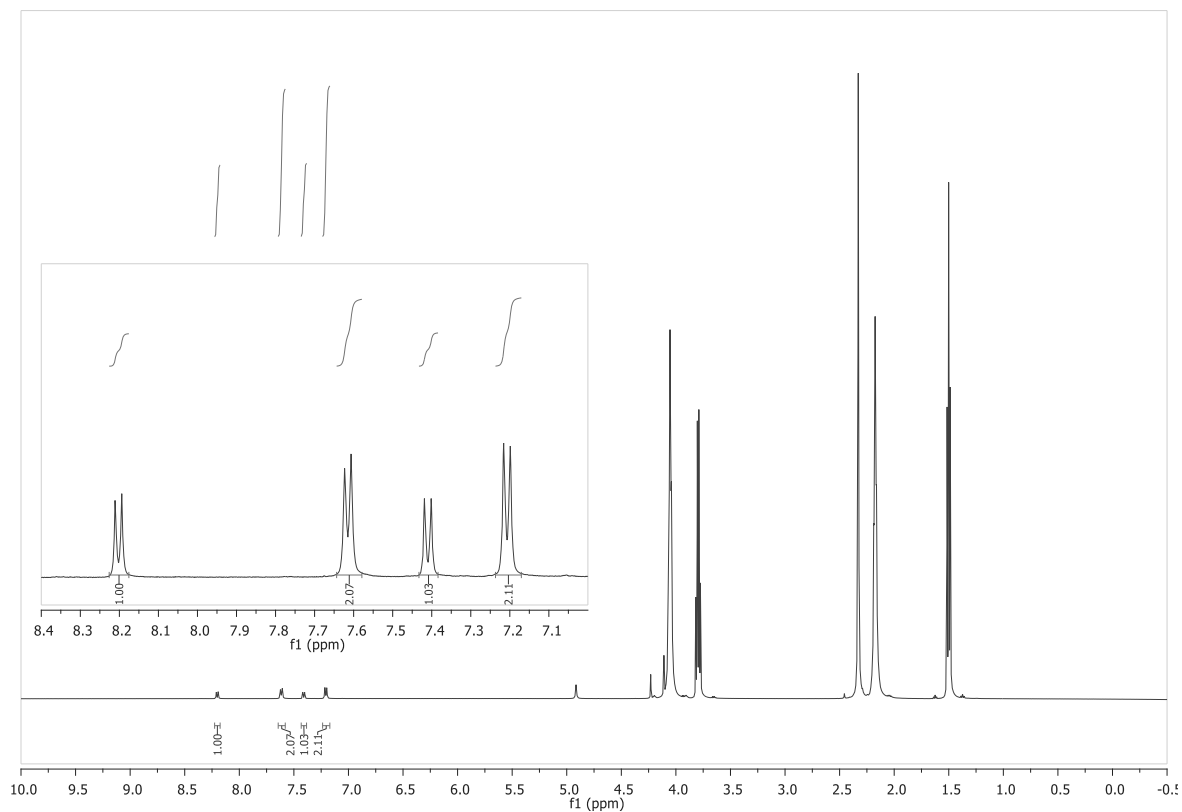


Figure SI-48 No-D ^1H NMR spectrum of the third *p*-anisaldehyde reduction which shows signals for starting material and product for determination of the LiAlH_4 purity.

$$\frac{\text{measured conc.}}{\text{theoretical conc.}} = \frac{0.86 \left[\frac{\text{mol}}{\text{L}} \right]}{0.98 \left[\frac{\text{mol}}{\text{L}} \right]} = 88 \% \text{ purity}$$

Complete Optimisation Data

Signal Separation

The signals of product **1** and by-product **5** could be separated by testing several GC columns. The best separation could be achieved with the “Optima-5 amine” column (30 m length; 0.25 mm ID; 0.5 μm film thickness) from Macherey & Nagel.

Illustrative examples:

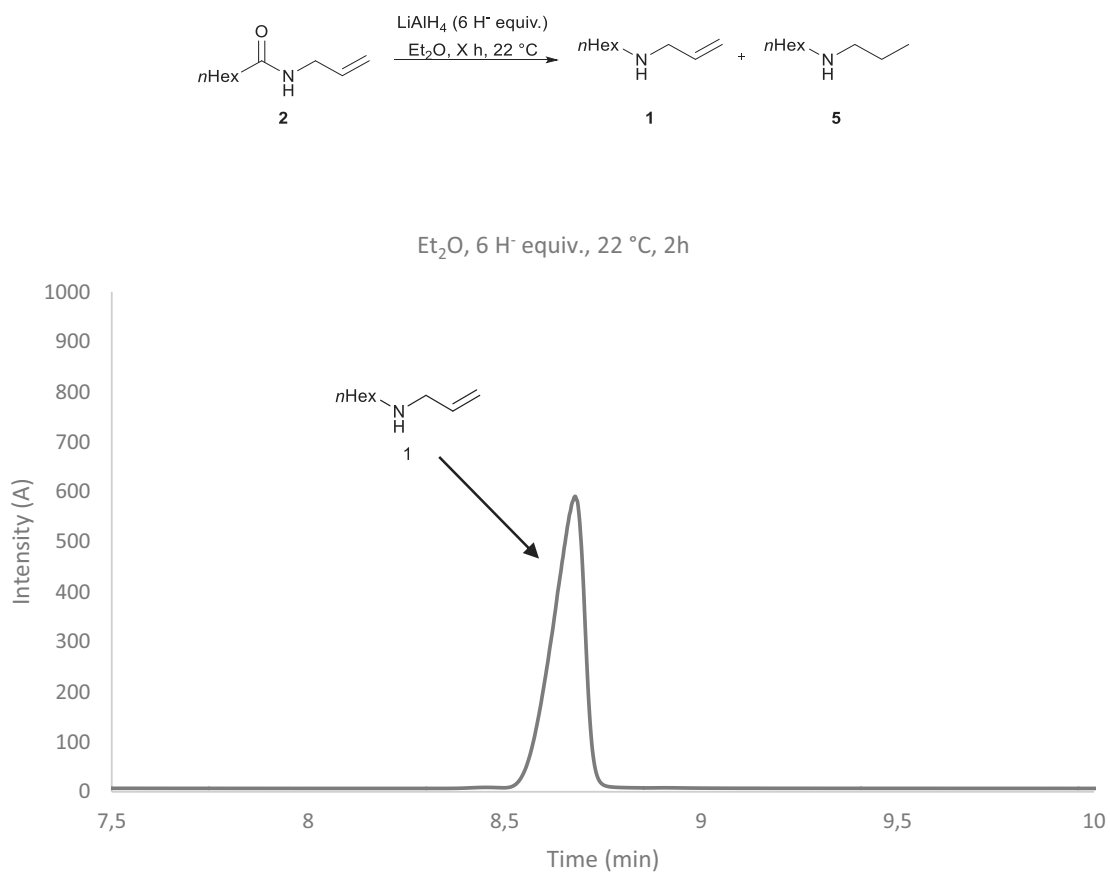


Figure SI-49 Reaction monitoring and detection of product **1** and by-product **5** by GC analysis; spectrum section of the amine species **1** and **5**; reaction conditions: Et_2O , LiAlH_4 (6 H⁻ equiv.), 22 °C, 2 h. At this stage, no **5** was observed.

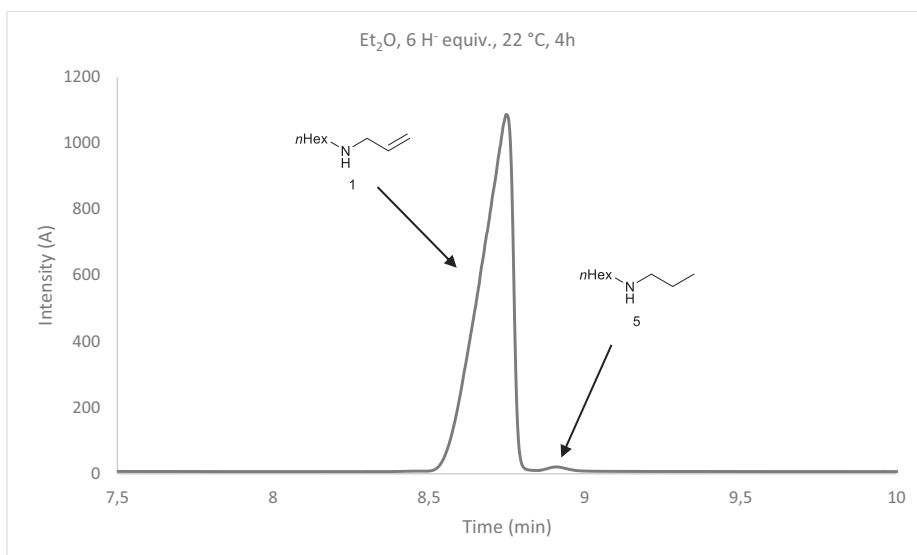


Figure SI-50 Reaction monitoring and detection of product **1** and by-product **5** by GC analysis; spectrum section of the amine species **1** and **5**; reaction conditions: Et₂O, LiAlH₄ (6 H⁻ equiv.), 22 °C, 4 h. At this stage, 1 % of **5** was observed.

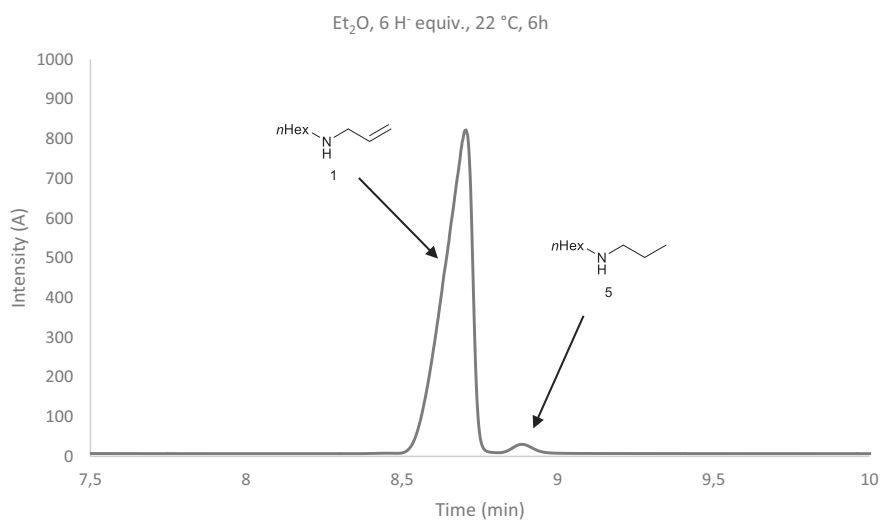


Figure SI-51 Reaction monitoring and detection of product **1** and by-product **5** by GC analysis; spectrum section of the amine species **1** and **5**; reaction conditions: Et₂O, LiAlH₄ (6 H⁻ equiv.), 22 °C, 6 h. At this stage, 2 % of **5** was observed.

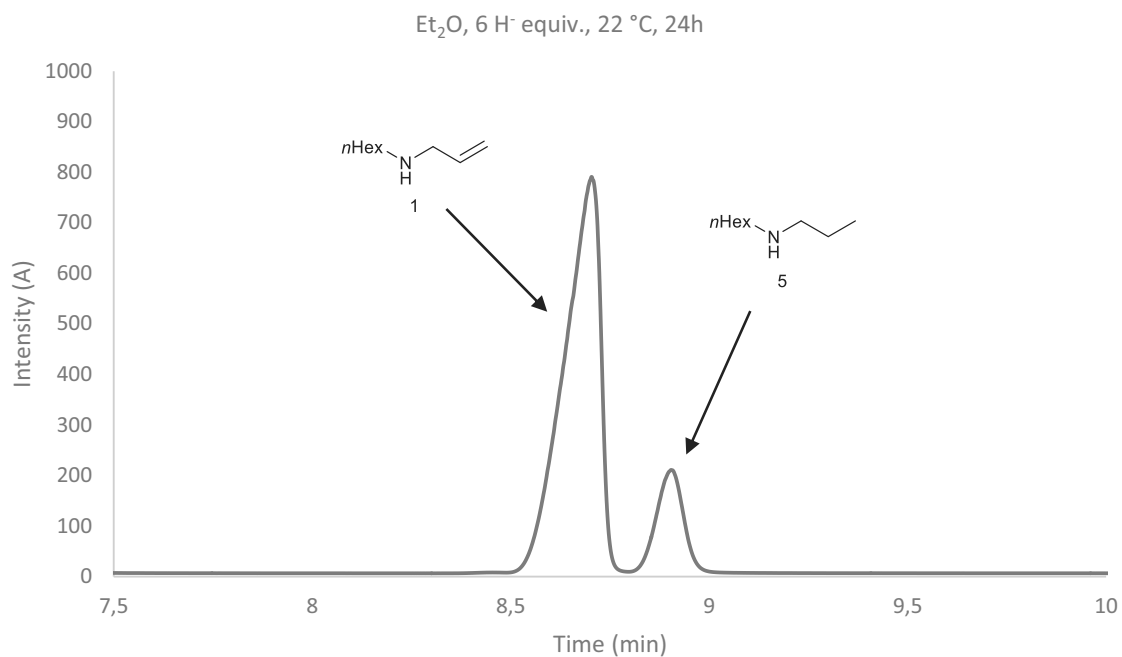


Figure SI-52 Reaction monitoring and detection of product **1** and by-product **5** by GC analysis; spectrum section of the amine species **1** and **5**; reaction conditions: Et₂O, LiAlH₄ (6 H⁻ equiv.), 22 °C, 24 h. At this stage, 15 % of **5** was observed.

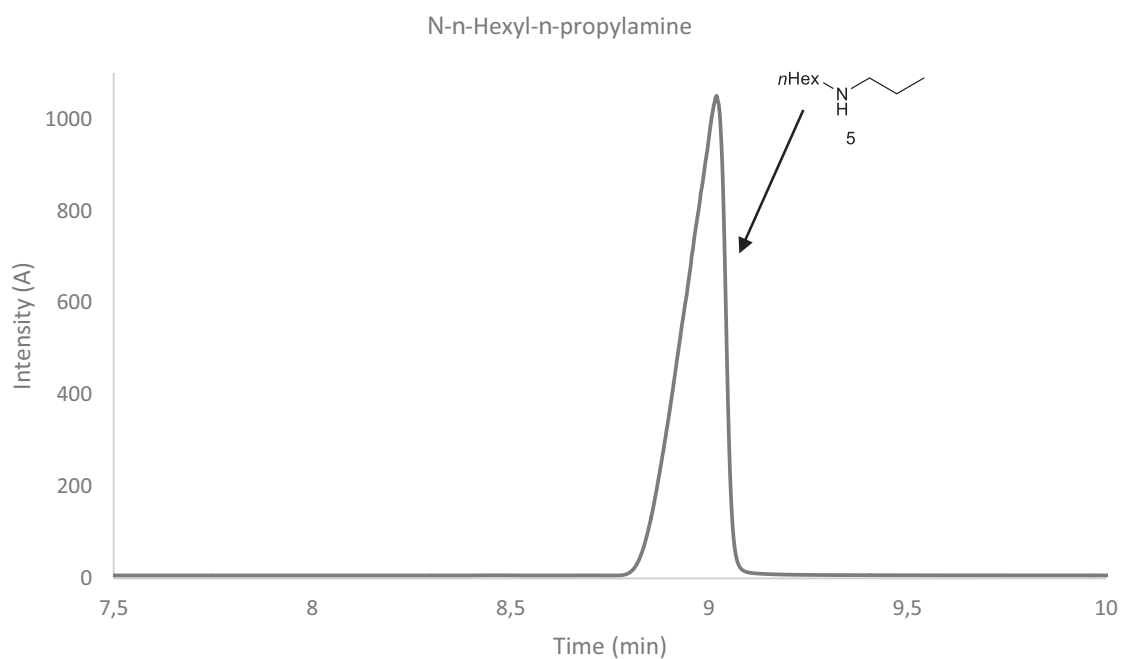


Figure SI-53 GC spectrum section of by-product **5** as comparison and confirmation to the double bond attack.

GC Calibration

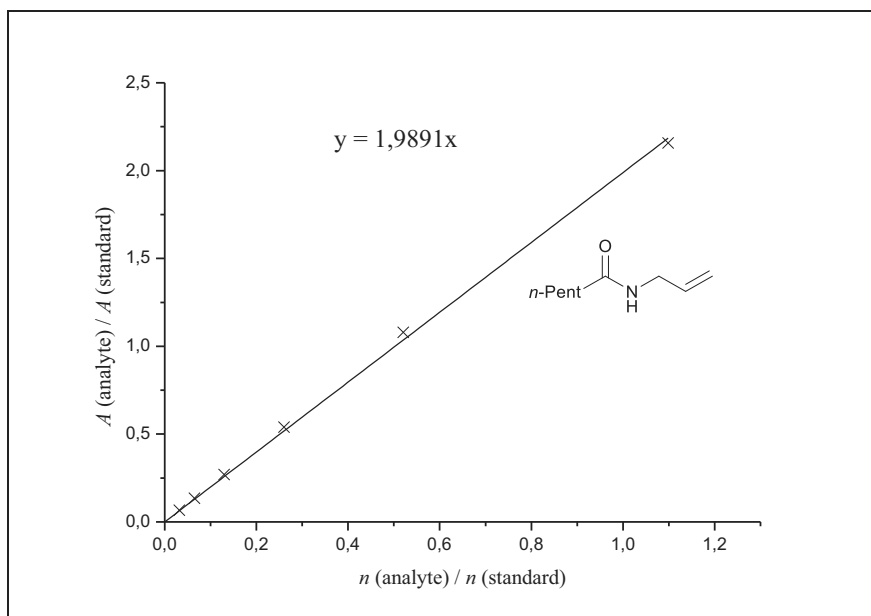


Figure SI-54 Calibration curve for *N*-allyl-*N*-*n*-hexylamide **2**, using 1,3,5-triisopropylbenzene as an internal standard.

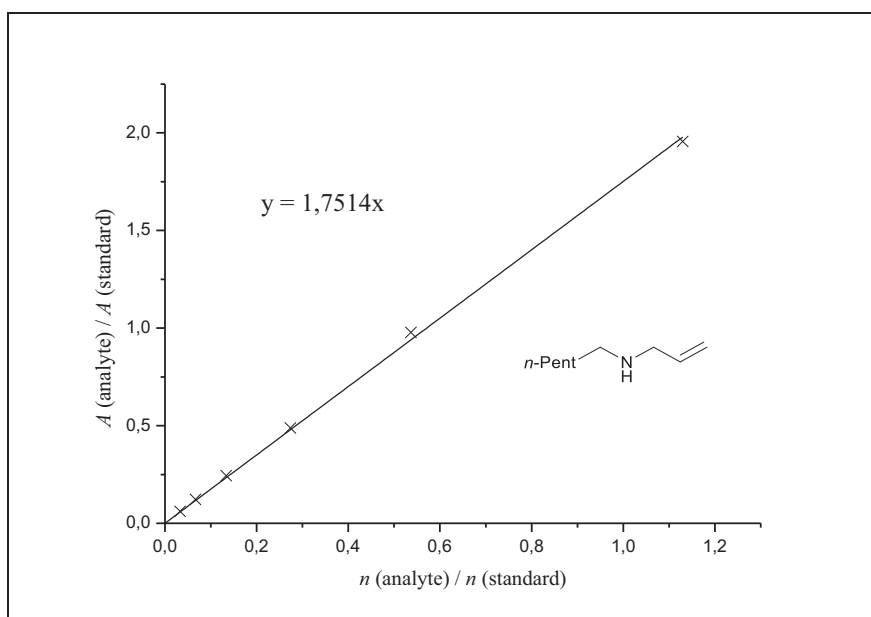


Figure SI-55 Calibration curve for *N*-allyl-*N*-*n*-hexylamine **1**, using 1,3,5-triisopropylbenzene as an internal standard.

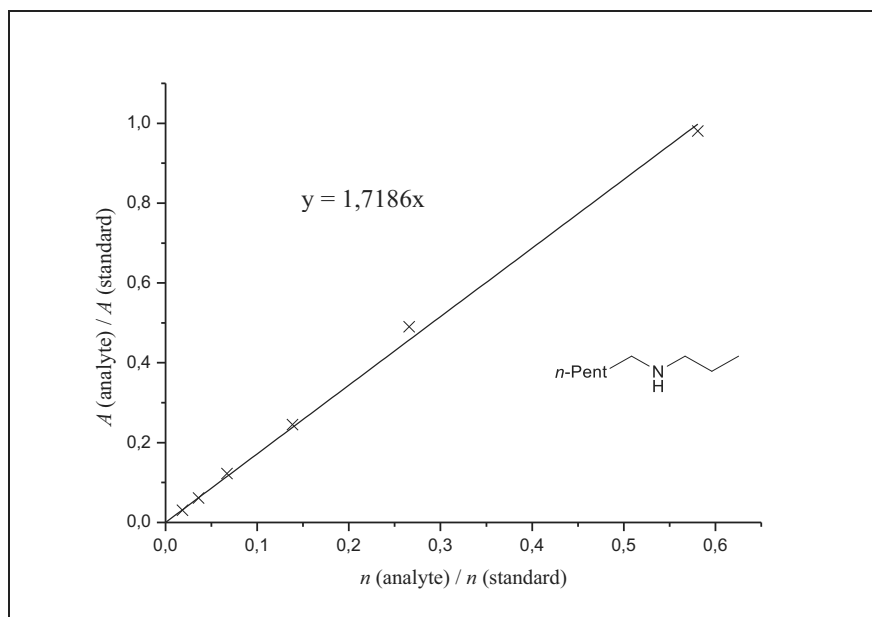
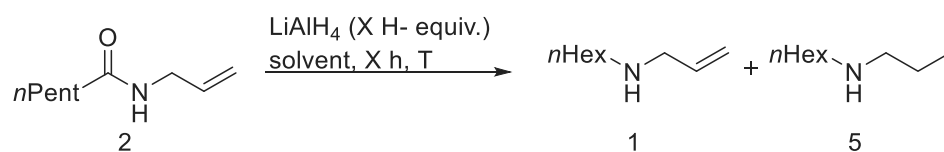


Figure SI-56 Calibration curve for *N-n*-hexyl-*N*-propylamine **5**, using 1,3,5-triisopropylbenzene as an internal standard.

5 Experimental Section

Table SI-1 Overview of GC results from reaction optimisation.



Entry	Solvent	LiAlH ₄ (H ⁻ equiv.)	Temperature (°C)	Time (h)	2 (%)	1 (%)	5 (%)
1	Et ₂ O	16	0 °C → 22 °C ^a	12	22	77	0
2	Et ₂ O	16	0 °C → 22 °C ^b	12	3	96	1
3	Et ₂ O	6	35	1	15	82	0
4	Et ₂ O	6	35	2	6	86	3
5	Et ₂ O	6	22	4	9	90	1
6	Et ₂ O	6	22	6	6	92	2
7	Et ₂ O	6	22	24	3	80	15
8	Et ₂ O	3	35	4	16	82	0
9	Et ₂ O	3	22	4	15	84	0
10	Et ₂ O	3	22	24	7	91	1
11	THF	3	35	4	88	12	0
12	THF	3	22	24	94	6	0
13	<i>t</i> BuOMe	6	35	2	8	89	3
14	<i>t</i> BuOMe	6	35	4	5	82	12
15	<i>t</i> BuOMe	6	22	4	7	92	1
16	<i>t</i> BuOMe	6	22	24	3	84	12
17	<i>t</i> BuOMe	3	35	2	15	84	0
18	<i>t</i> BuOMe	3	35	4	12	87	0
19	<i>t</i> BuOMe	3	22	6	14	85	0
20	<i>t</i> BuOMe	3	22	24	9	89	1
21	Me-THF	6	35	4	61	38	0
22	Me-THF	6	35	24	1	95	2
23	Me-THF	6	22	24	78	22	0
24	Me-THF	3	35	4	78	21	0
25	Me-THF	3	35	24	0	93	3
26	Me-THF	3	22	24	14	76	0
27	THF	3	55	2	12	84	0
28	<i>t</i> BuOMe	3	55	2	10	86	0
29	Me-THF	3	55	1	5	90	0
30	Me-THF	3	55	2	3	87	1
31	<i>t</i> BuOMe	2	35	24	43	42	0
32	<i>t</i> BuOMe	2	55	24	36	44	0

^a ice bath slowly warmed up; ^b ice bath removed after amide addition.

Mechanistic Study

GC

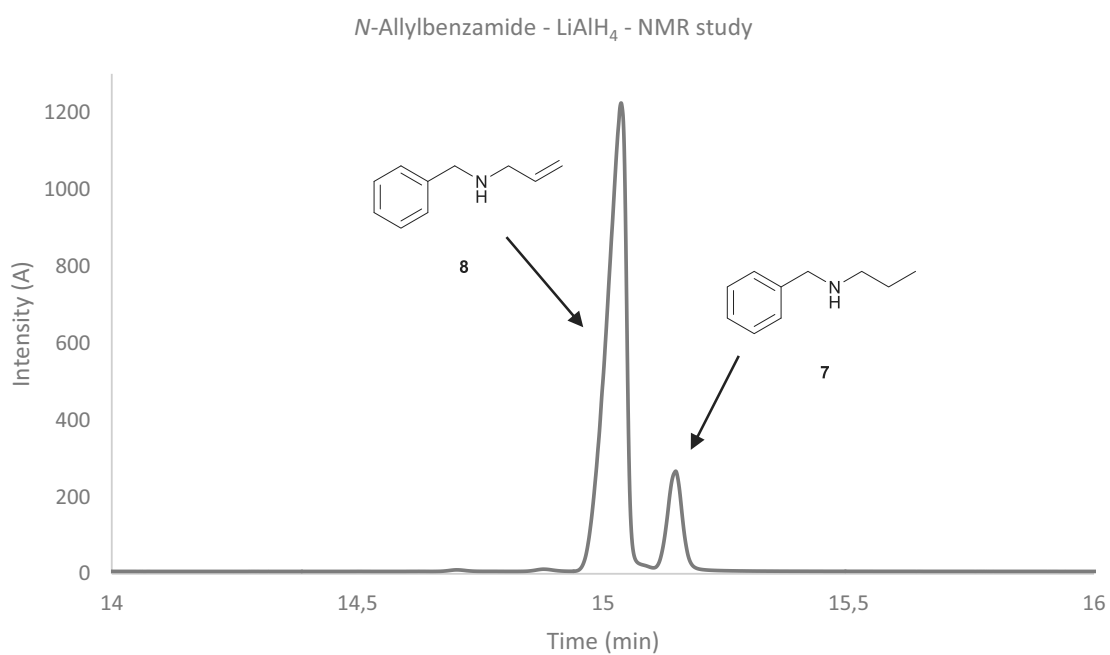
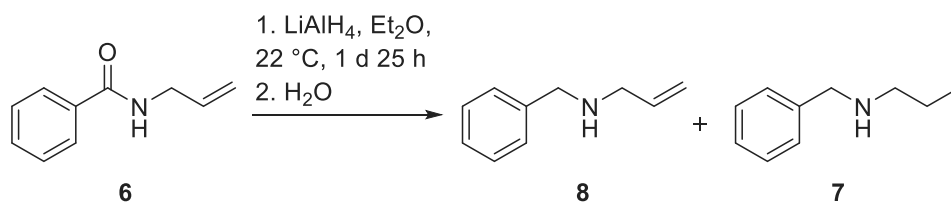


Figure SI-57 GC spectrum section of the reaction mixture after the corresponding No-D ^1H NMR sequence showing *N*-allyl-*N*-benzylamine **8** and by-product **7**; reaction conditions: 1. Et_2O , LiAlH_4 , 1 d 25 h., 2. H_2O .

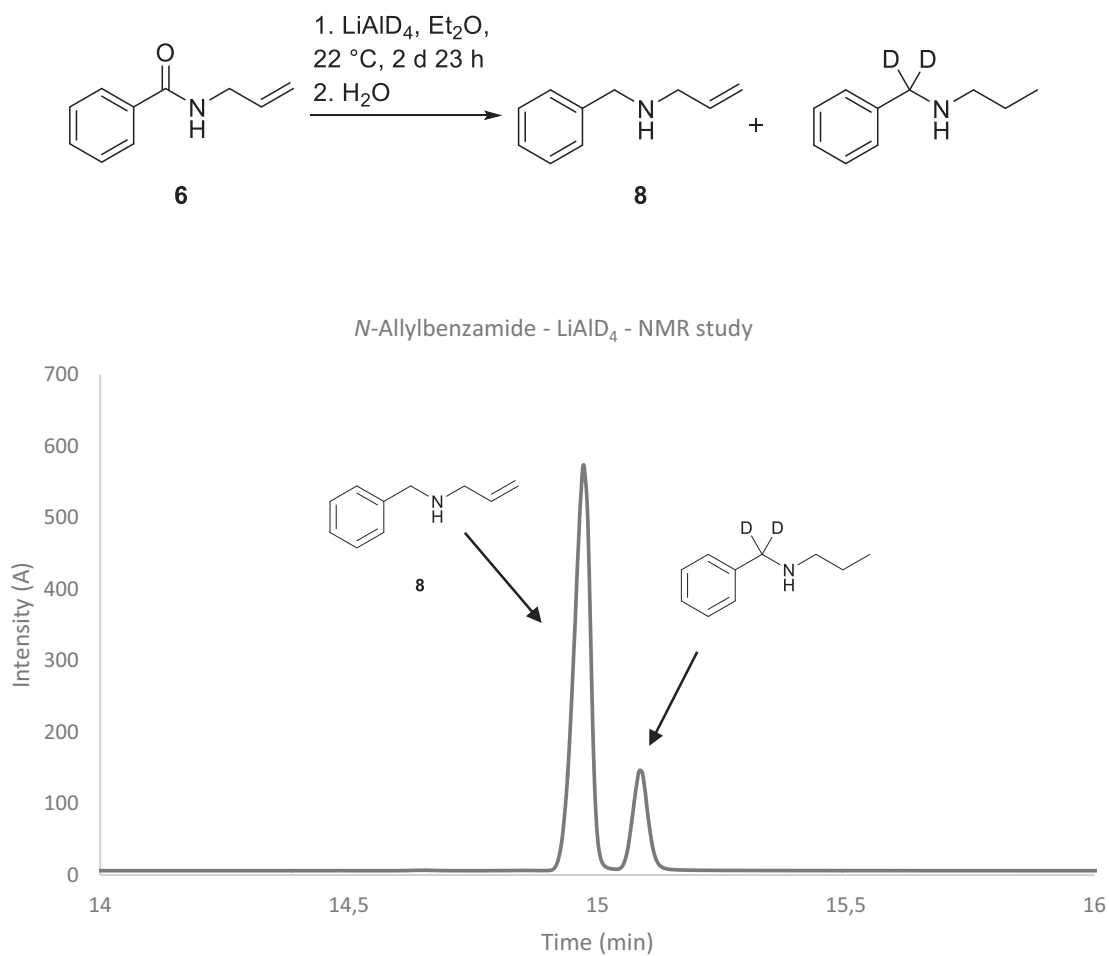


Figure SI-58 GC spectrum section of the reaction mixture after the corresponding No-D ¹H NMR sequence showing *N*-allyl-*N*-benzylamine **8** and by-product; reaction conditions: 1. Et₂O, LiAlD₄, 2 d 23 h., 2. H₂O.

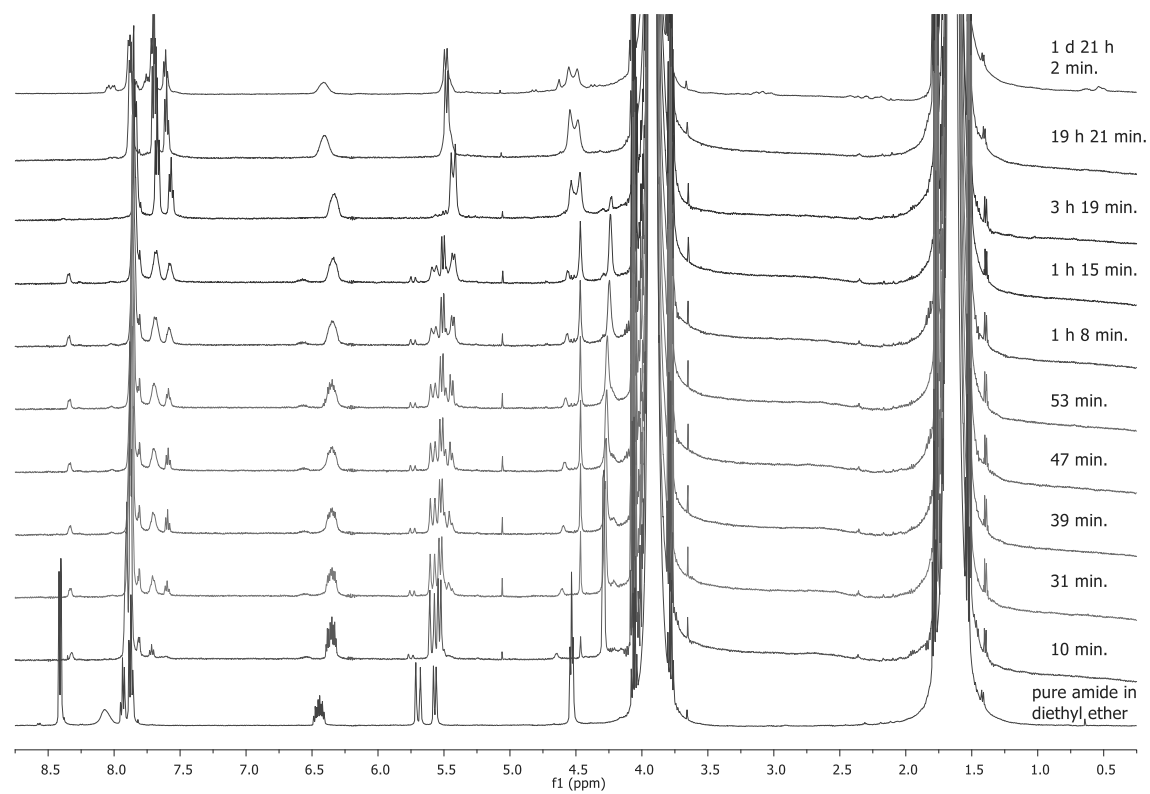


Figure SI-59 No-D NMR sequence of the *N*-allylbenzamide **6** reduction using LiAlH₄ in Et₂O.

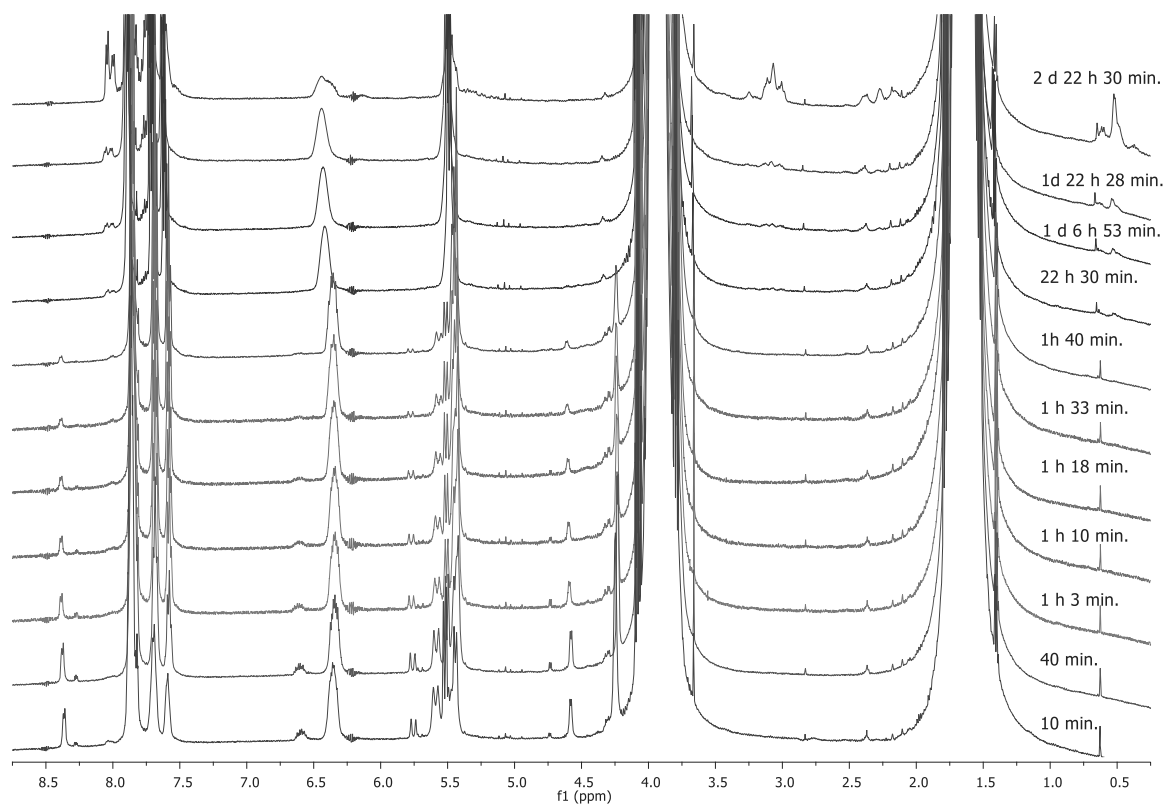


Figure SI-60 No-D NMR sequence of the *N*-allylbenzamide **6** reduction using LiAlD_4 in Et_2O .

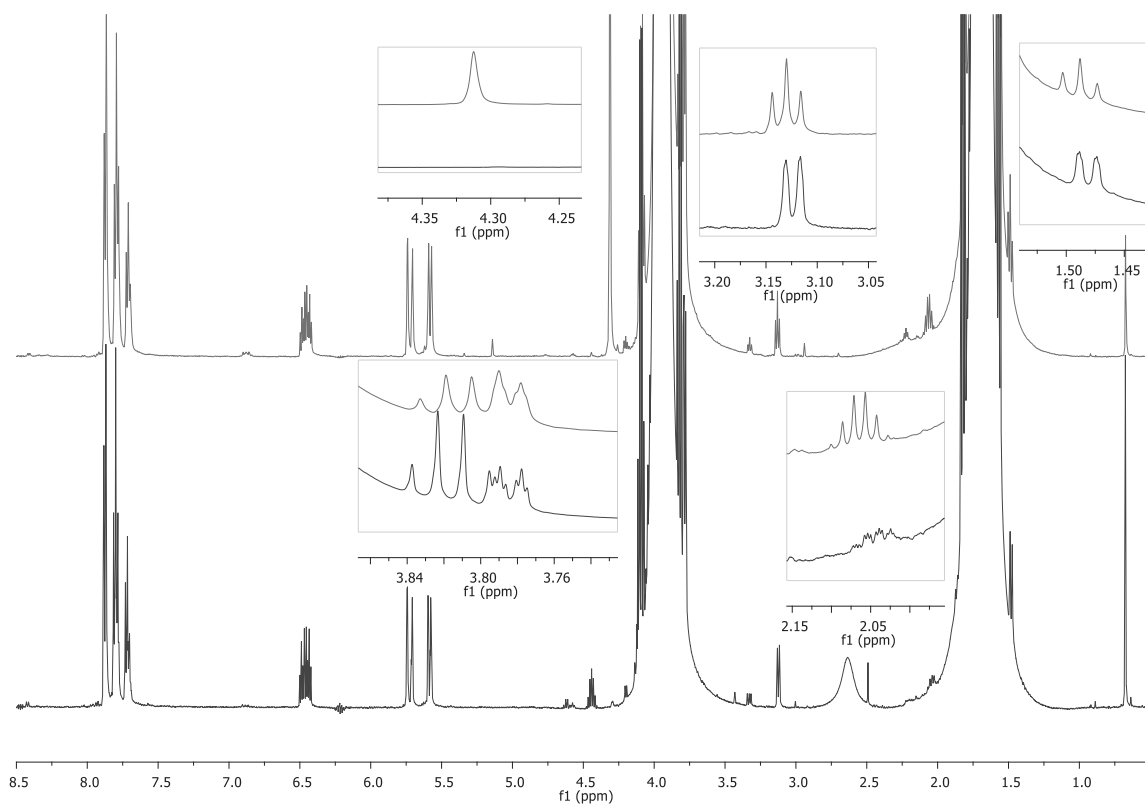


Figure SI-61 Comparison of the *N*-allylbenzamide reductions using LiAlH_4 (top) and LiAlD_4 (bottom) after quenching with H_2O ; No-D ^1H NMR in Et_2O .

5.2 Supporting Information on Chapter 3.2

5.2.1 General Methods

All syntheses were carried out using standard Schlenk techniques or in a glovebox (INERT[®] PURE LAB) under a dry and inert nitrogen atmosphere. Glassware and NMR-tubes were dried in an oven at 200 °C for at least 2 h prior to use. Reaction vessels were heated under vacuum and purged with nitrogen three times before adding reagents.

5.2.2 Analyses

¹H NMR, ¹³C{¹H} NMR and ¹¹B{¹H} NMR spectra were recorded at 300 K.

¹H NMR spectra were recorded on a Bruker[®] DRX 500 (500 MHz) spectrometer or a Bruker[®] AV 600 (600 MHz) spectrometer. Reaction monitoring was carried out on a Bruker DPX200 (200 MHz). ¹³C{¹H} NMR spectra were recorded on a Bruker[®] DRX 500 (126 MHz) spectrometer. ¹¹B{¹H} NMR spectra were recorded on a Bruker[®] DRX 500 (161 MHz) spectrometer or for compound **13** on a Bruker Avance AC 360 (116 MHz). The signals were referenced externally to BF₃·OEt₂.

The exact assignment of the peaks was proved by ¹H, ¹³C{¹H} DEPT and two-dimensional NMR spectroscopy such as ¹H COSY, ¹³C HSQC(-DEPT) or ¹H/¹³C HMBC when possible.

GC-MS analyses were performed using an Agilent Technologies[®] 7890B with Agilent Technologies[®] 5977A mass selective detector and an Agilent Technologies[®] dimethylpolysiloxane column (19091S-931E, length = 30 m, diameter = 0.25 mm, grain size = 0.25 μm).

High resolution mass spectrometry experiments were carried out on a JEOL[®] AccuTOF JMS-T100GCV mass spectrometer with electron ionisation (EI, 70 eV).

All microwave irradiation reactions were carried out on a Biotage[®] Initiator 60EXP.

Kugelrohr distillations were performed with a BÜCHI Kugelrohr apparatus equipped with distillation balls and stopcock adapter. The Kugelrohr was connected via cooling trap to a N₂ line and either a rotation controlled vacuum pump or the vacuum line of the Schlenkline.

5.2.3 Chemicals

All reagents were degassed via the freeze-pump-thaw technique (>3 cycles), dried and stored under a N₂ atmosphere, if not mentioned otherwise.

Compound	Purity	Supplier
2,3-Dichloro-5,6-dicyano-1,4-benzoquinone, DDQ	98% ^a	Sigma Aldrich
4-bromobenzoyl chloride	98+%	Alfa Aesar
Allylamine	98% ^b	Acros Organics
Boron trichloride, BCl ₃	1.0 M in hexanes	Acros Organics
Cyclohexene	>99%; inhibitor-free; ^b	Sigma Aldrich
Grubbs Catalyst 1st Generation	97% ^a	Sigma Aldrich
Lithium aluminium hydride, LiAlH ₄	95% ^a	Acros Organics
Magnesium sulphate, MgSO ₄	99%	Gruessing
Methyl lithium, MeLi	1.6 M in diethyl ether	Acros Organics
Palladium black, Pd black	>97% ^a	ABCR
Sodium hydroxide, NaOH	99.9%	Gruessing
Triethylamine, Et ₃ N	99% ^b	Acros Organics

^a Degassed under vacuum for 16 h, stored under N₂.

^b 5 x FPT, dried over molecular sieve (3 Å), stored under N₂.

5.2.4 Solvents

Solvent	Supplier	Note
Benzene- <i>d</i> ₆ , C ₆ D ₆	Deutero	^a
Chlorobenzene	Acros Organics	AcroSeal [®] , 99.8%; stored under N ₂
Chloroform- <i>d</i> ₁ , CDCl ₃	Deutero	99.8%
Dichloromethane, CH ₂ Cl ₂	VWR	^b
Dichloromethane- <i>d</i> ₂ , CD ₂ Cl ₂	Deutero	>99.6%
<i>n</i> -Hexane	VWR	^b
<i>n</i> -Pentane	VWR	^b
<i>tert</i> -Butylmethylether	Sigma Aldrich	≥98%, ^b
Tetrahydrofuran, THF	VWR	^b
Toluene	BCD	^a

^a Dried and distilled over sodium, >3 x FPT, stored over molecular sieve (3 Å) and N₂.

^b Purified by solvent purification system, 3 x FPT, stored over molecular sieve (3 Å) and N₂.

5.2.5 Syntheses of the Bachelor's Thesis by L. Dölger

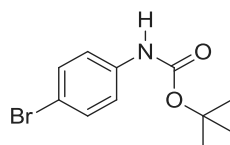
In this section, original parts of the bachelor's thesis of L. Dölger are presented, due to reproduction reasons. For that, the permission of L. Dölger was given.⁷³

The numbering of compounds within this dissertation are different to the bachelor's thesis of L. Dölger. The relevant assignments are listed in Table SI- 1.

Table SI- 1. Compound assignment of the bachelor's thesis of L. Dölger within this thesis.

Compound Number (this thesis)	Compound Number (B.Sc. thesis L. Dölger⁷³)
2	13
3	14
4	8
5	9
7	10
8	11
9	22
21	21

4.2 Syntheses

4.2.1 *tert*-Butyl (4-bromophenyl)carbamate (**13**)

In a glovebox at 19 °C, a solution of di-*tert*-butyl dicarbonate (24.4 g, 112 mmol) in dry THF (40 mL) was added to a solution of 4-bromoaniline (**8**) (17.3 g, 100 mmol) in dry THF (200 mL). The reaction mixture was stirred at 19 °C for 67 h under nitrogen. The solvent and volatiles were removed under reduced pressure. The excess di-*tert*-butyl dicarbonate was removed in vacuo by placing the round bottom flask in a water bath at 60 °C at a Schlenk line for 27 h. The product **8** was afforded in 99% yield (27.2 g, 97% purity) as a colourless solid with the main by-product being the double protected species **15**.^b

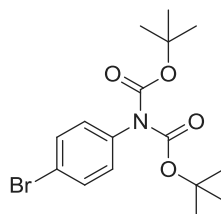
¹H NMR (500 MHz, CDCl₃): δ = 7.39 (d, ³J = 8.9 Hz, 2 H, *H*-3,5), 7.26 (*H*-2,6)^c, 6.43 (wide s, 1 H, NH), 1.51 (s, 9H, CH₃) ppm.

¹³C NMR (126 MHz, CDCl₃): δ = 152.6 (C=O), 137.6 (C-1), 132.0 (C-3,5), 120.2 (C-2,6), 115.6 (C-4), 81.1 (C-(CH₃)₃), 28.5 (CH₃) ppm.

IR (ATR): $\tilde{\nu}$ = 3368 (m), 2983 (m), 1694 (s), 1590 (m), 1514 (s), 1490 (m), 1395 (m), 1152 (s), 1070 (s), 814 (s) cm⁻¹.

MS (EI, 70 eV): *m/z* (%) = 271/273 (22) [M]⁺, 215/217 (98) [M-C₄H₉]⁺, 197/199 (10) [M-C₄H₉OH]⁺, 171/173 (100) [M-C₅H₉O₂]⁺.

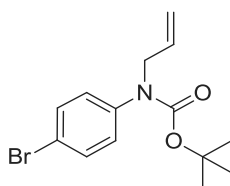
HRMS (EI): *m/z* found 271.0210; calcd. for C₁₁H₁₄BrN₁O₂ 271.0208.

By-product: di-*tert*-Butyl (4-bromophenyl)-*N,N*-dicarbamate (**15**)

¹H NMR (500 MHz, CDCl₃): δ = 7.38 (m, 2 H, *H*-3,5), 7.25 (m, 2 H, *H*-2,6), 1.53 (s, 9H, CH₃) ppm.

^b The procedure was adapted from Brucelle and Renaud, yet they only characterised the end product **8**.²⁷

^c The coupling constant and integral could not be assigned due to solvent signal overlap.

4.2.2 *tert*-Butyl allyl(4-bromophenyl)carbamate (14**)²⁷**

Under nitrogen, **13** (26.8 g, 97% purity, 95.5 mmol) was dissolved in dry THF (500 mL) at 0 °C and NaH (60% dispersion in oil, 6.00 g, 150 mmol) was added portionwise. The reaction mixture was allowed to warm up to 19 °C for 30 min, then allyl bromide (13.0 mL, 150 mmol) was added dropwise within 10 min at 0 °C. The reaction mixture was stirred at 0 °C for 5 min and heated to reflux for 18 h. The reaction was cooled to 19 °C and slowly poured onto ice (600 mL) and brine (150 mL). The two layers were separated. The aqueous layer was extracted with Et₂O (3 x 750 mL). The combined organic layers were washed with brine (1 x 1500 mL), dried over MgSO₄, filtered and concentrated under reduced pressure. The crude product (32.7 g, 91% purity) was a yellow liquid afforded in an apparent 105% yield, including a higher molecular alkyl compound as by-product.^d

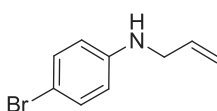
¹H NMR (500 MHz, CDCl₃): δ = 7.42 (d, ³J = 8.8 Hz, 2 H, *H*-3,5), 7.11 (d, ³J = 8.8 Hz, 2H, *H*-2,6), 5.88 (m_c, 1 H, CH=CH₂), 5.15 (m_c, 1 H, CH=CH_{trans}), 5.12 (m_c, 1 H, CH=CH_{cis}), 4.19 (dt, ³J = 5.6 Hz, ⁴J = 1.5 Hz, 2 H, CH₂-N), 1.44 (s, 9 H, CH₃) ppm.

¹³C NMR (126 MHz, CDCl₃): δ = 154.1 (C=O), 141.0 (C-1), 131.6 (CH=CH₂), 128.0 (C-3,5), 127.9 (C-2,6), 119.0 (CH₂=CH), 116.7 (C-4), 80.8 (C-CH₃), 52.8 (CH₂-N), 28.3 (CH₃) ppm.

IR (ATR): $\tilde{\nu}$ = 2977 (m), 1698 (s), 1646 (w), 1589 (w), 1590 (s), 1366 (s), 1147 (s), 991 (m), 827 (s) cm⁻¹.

MS (EI, 70 eV): *m/z* (%) = 311/312 (10) [M]⁺, 255/257 [M-C₄H₈]⁺, 211/213 (54) [C₈H₆BrNO]⁺, 130 (48) [C₆H₁₂NO₂]⁺.

HRMS (EI): *m/z* found 311.0517; calcd. for C₁₄H₁₈BrNO₂ 311.0521.

4.2.3 *N*-Allyl-4-bromoaniline (8**)²⁷**

Acetyl chloride (70.0 mL, 981 mmol) was carefully added dropwise within 8 min to dry MeOH (250 mL) at 0 °C under nitrogen, then **14** (32.7 g, 91% purity, 95.5 mmol) in a solution of dry MeOH (90 mL) was

^d The procedure was adapted from Brucele and Renaud, yet they only characterised the end product **8**.²⁷

added dropwise at this temperature within 10 min. The reaction mixture was allowed to warm up to 19 °C and stirred for 3 h. The mixture was concentrated under reduced pressure. The residue was treated with a NaOH (1 M) solution (500 mL) at 0 °C until alkaline and extracted with Et₂O (3 x 40 mL). The combined organic layers were dried over MgSO₄, filtered and concentrated under reduced pressure. Purification by flash column chromatography (cyclohexane/AcOEt 95:5, *R_f* = 0.30) and distillation (3.4 mbar, 140 °C) gave **8** (17.3 g, 81.4 mmol, 85%) as a pale yellow liquid.

¹H NMR (500 MHz, CDCl₃): δ = 7.25 (d, ³*J* = 8.9 Hz, 2 H, *H*-3,6), 6.50 (d, ³*J* = 8.9 Hz, 2 H, *H*-2,5), 5.92 (ddt, ³*J* = 17.2, 10.4, 5.3 Hz, CH=CH₂), 5.26 (dd, ³*J* = 17.2 Hz, ²*J* = 1.5 Hz, 1 H, CH_{trans}=CH), 5.18 (dd, ³*J* = 10.4 Hz, ²*J* = 1.5 Hz, 1 H, CH_{cis}=CH), 3.82 (wide s, 1 H, NH), 3.75 (dt, ³*J* = 5.3 Hz, ⁴*J* = 1.6 Hz, 2 H, CH₂-N) ppm.

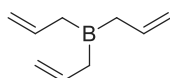
¹³C NMR (126 MHz, CDCl₃): δ = 147.2 (C-1), 135.0 (CH=CH₂), 132.04 (C-3,5), 116.6 (CH₂=CH), 114.7 (C-2,6), 109.2 (C-4), 46.6 (CH₂-N) ppm.

IR (ATR): $\tilde{\nu}$ = 3216 (m), 3082 (w), 1645 (w), 1594 (s), 1495 (s), 1314 (m), 997 (m), 918 (s), 810 (s) cm⁻¹.

MS (EI, 70 eV): *m/z* (%) = 211/213 (100) [M]⁺, 184/186 (92) [M-C₂H₃]⁺, 130/132 (76) [C₄H₃Br]⁺, 105 (20) [M-C₂H₃Br]⁺, 91 (30) [C₆H₅N]⁺.

HRMS (EI): *m/z* found 210.9994; calcd. for C₉H₁₀Br₁N₁ 210.9997.

4.2.4 Triallylborane (**9**)²⁸



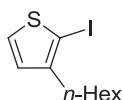
Allyl bromide (**16**) (26 mL, 300 mmol) was added dropwise to dry magnesium turnings (9.73 g, 400 mmol), anhydrous diethyl ether (100 mL) and BF₃OEt₂ (12.5 mL, 100 mmol) in a round bottom, two-neck Schlenk flask with a frit and stopcock at one neck over a period of 3 h under nitrogen. Diethyl ether (20 mL) was added to facilitate stirring. After the addition, the reaction mixture was stirred for 15 h at 19 °C. The clear ether layer was transferred over the frit into a two-neck round bottom flask. The Mg salts were washed with anhydrous diethyl ether (80 mL) and this ether layer was also transferred into the distillation flask. Diethyl ether was distilled (50 °C, 900 mbar) followed by the boron trifluoride etherate residue (60 °C, 200 mbar). Finally the product was distilled under vacuum in a short-path distillation (70-95 °C, 10-15 mbar) to afford **9** (8.80 g, 65.7 mmol, 66%) as a clear colourless liquid.

¹H NMR (500 MHz, C₆D₆): δ = 5.81 (m_c, 3 H, CH=CH₂), 5.07-4.81 (m, 6 H, CH=CH₂), 2.24-1.81 (m, 6 H, CH₂-B) ppm.

^{13}C NMR (125 MHz, C_6D_6): δ = 135.2 ($\text{CH}=\text{CH}_2$), 114.9 ($\text{CH}=\text{CH}_2$), 34.8 ($\text{CH}_2\text{-B}$) ppm.

^{11}B NMR (161 MHz, C_6D_6): δ = 81.0 ppm.^e

4.2.5 3-*n*-Hexyl-2-iodothiophene (**17**)²⁹



This reaction was not performed under Schlenk conditions. NIS (7.06 g, 31.4 mmol) was added in portions to a solution of 3-*n*-hexylthiophene (**18**) (4.98 g, 29.6 mmol) in CHCl_3 (50 mL) and acetic acid (50 mL), shielded from light, within 3 min at 0 °C and the mixture was stirred for 11 h at 19 °C. The red solution was quenched with a saturated solution of sodium hydroxide (40 mL) and water (300 mL) was added to dissolve the precipitation. The solution was extracted with CHCl_3 (3 x 80 mL). The remaining iodine was removed by washing the combined organic layers with sodium thiosulphate (140 mL). The organic layers were dried with magnesium sulfate and the volatiles were removed *in vacuo*. The crude product was distilled by Kugelrohr distillation (9.98×10^{-2} mbar; 70 °C) to afford **17** (5.54 g, 18.8 mmol, 64%) as a yellow liquid.

^1H NMR (500 MHz, CDCl_3): δ = 7.38 (d, 3J = 5.5 Hz, 1 H, *H*-5), 6.75 (d, 3J = 5.5 Hz, 1 H, *H*-4), 2.54 (m_c, 2 H, $\text{CH}_2\text{-C}$), 2.29-1.61 (m, 8 H, $(\text{CH}_2)_4\text{-CH}_3$), 0.89 (m_c, 3 H, CH_3) ppm.

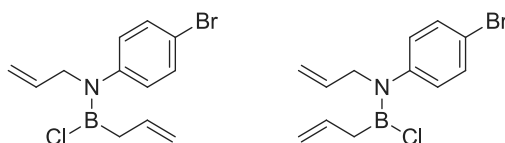
^{13}C NMR (126 MHz, CDCl_3): δ = 147.3 (C-3), 130.4 (C-5), 128.1 (C-4), 74.1 (C-2), 32.2 ($\text{CH}_2\text{-CH}_2\text{-CH}_3$), 31.8 (Ar- $\text{CH}_2\text{-CH}_2$), 30.2 (Ar- CH_2), 29.1 (Ar- $\text{CH}_2\text{-CH}_2\text{-CH}_2$), 22.8 ($\text{CH}_2\text{-CH}_3$), 14.3 (CH_3) ppm.

IR (ATR): $\tilde{\nu}$ = 2954 (m), 2925 (s), 1678 (s), 1455 (m) 1397 (w), 1087 (m), 828 (s), 713 (s) cm^{-1} .

MS (EI, 70 eV): m/z (%) = 294.02 (25) $[\text{M}]^+$, 222.93 (58) $[\text{M}-\text{C}_5\text{H}_{11}]^+$, 167.10 (7) $[\text{M}-\text{I}]^+$, 97.02 (100) $[\text{C}_5\text{H}_4\text{S}]^+$.

HRMS (EI): m/z found 293.9944; calcd. for $\text{C}_{10}\text{H}_{15}\text{I}_1\text{S}_1$ 293.9939.

4.2.6 *N*-1-Diallyl-*N*-(4-bromophenyl)-1-chloroboranimine (**10**)



^e Mass and IR spectra were not measured due to significant oxygen and moisture sensitivity.

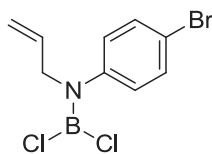
A solution of BCl_3 (1.0 M in heptanes; 16.7 mL; 16.7 mmol) in *n*-hexane (120 mL) was cooled to $-78\text{ }^\circ\text{C}$ under nitrogen. **9** (1.12 g; 8.30 mmol) was added dropwise within 5 min. The reaction mixture was stirred at $-78\text{ }^\circ\text{C}$ for 2 hours and then the cooling bath was removed for 10 min to allow the reaction mixture to warm up. At $-78\text{ }^\circ\text{C}$, a solution of **8** (5.66 g, 25.0 mmol) and NEt_3 (2.53 g, 25.0 mmol) in *n*-hexane (10 mL) was added using a syringe pump (0.12 mL/min). After addition, the mixture was allowed to warm up to $19\text{ }^\circ\text{C}$ without removing the cooling bath. After 65 h of stirring, the mixture was transferred into the glovebox where it was filtrated through a frit and washed with *n*-hexane (40 mL). The filtrate was connected to a Schlenk line for solvent evaporation under reduced pressure ($50\text{ }^\circ\text{C}$, 3.5 mbar) to afford a 91% yield of **10** (6.82 g, 94% purity) as a pale orange liquid in a rotamer ratio 1.0:0.2. The by-product was the dichloride species **20**.

$^1\text{H NMR}$ (500 MHz, C_6D_6): $\delta = 7.15$ ($H'-3,5$)^f, 7.08 (d, $^3J = 8.7\text{ Hz}$, 2 H, $H-3,5$), 6.52 (d, $^3J = 8.7\text{ Hz}$, 0.4 H, $H'-2,6$), 6.38 (d, $^3J = 8.7\text{ Hz}$, 2 H, $H-2,6$), 6.05 (ddt, $^3J = 17.4, 10.0, 7.4\text{ Hz}$, 0.2 H, $\text{CH}'\text{-CH}_2\text{B}$), 5.91 (ddt, $^3J = 17.4, 10.0, 7.4\text{ Hz}$, 1 H, $\text{CH-CH}_2\text{B}$), 5.55 (ddt, $^3J = 17.1, 10.2, 6.1\text{ Hz}$, 1 H, $\text{CH-CH}_2\text{N}$), 5.4-5.35 (m, 0.2 H, $\text{CH}'\text{-CH}_2\text{N}$), 5.11-5.05 (m, 0.4 H, $\text{CH}'_2=\text{CH-CH}_2\text{B}$), 4.96 – 4.77 (m, 4.4 H, $\text{CH}'_2=\text{CH-CH}_2\text{B}$, $\text{CH}'_2\text{-CH-CH}_2\text{N}$, $\text{CH}_2\text{-CH-CH}_2\text{N}$), 3.91 (dt, $^3J = 6.1\text{ Hz}$, $^4J = 1.3\text{ Hz}$, 2 H, $\text{CH}_2\text{-N}$), 3.58 (dt, $^3J = 6.0\text{ Hz}$, $^4J = 1.3\text{ Hz}$, 0.4 H, $\text{CH}'_2\text{-N}$), 2.03 (m_c , 0.4 H, $\text{CH}'_2\text{-B}$), 1.72 (m_c , 2 H, $\text{CH}'_2\text{-B}$) ppm.

$^{13}\text{C NMR}$ (126 MHz, C_6D_6): $\delta = 145.9$ ($\text{C}'\text{-1}$), 145.3 (C-1), 134.8 ($\text{CH-CH}_2\text{N}$), 134.7 ($\text{C}'\text{H-CH}_2\text{N}$), 134.6 ($\text{C}'\text{H-CH}_2\text{B}$), 134.5 ($\text{CH-CH}_2\text{B}$), 132.4 (C-3,5), 132.3 ($\text{C}'\text{-3,5}$), 130.0 ($\text{C}'\text{-2,6}$), 129.6 (C-2,6), 120.4 (C-4), 120.1 ($\text{C}'\text{-4}$), 117.5 ($\text{CH}_2\text{-CH-CH}_2\text{N}$), 117.1 ($\text{C}'\text{H}_2\text{-CH-CH}_2\text{N}$), 115.5 ($\text{C}'\text{H}_2\text{-CH-CH}_2\text{B}$), 115.3 ($\text{CH}_2\text{-CH-CH}_2\text{B}$), 56.5 ($\text{CH}_2\text{-N}$), 56.0 ($\text{C}'\text{H}_2\text{-N}$), 27.8 ($\text{CH}_2\text{-B}$), 27.4 ($\text{C}'\text{H}_2\text{-B}$) ppm.

$^{11}\text{B NMR}$ (161 MHz, C_6D_6): $\delta = 39.3\text{ ppm}$.^g

By-product: *N*-Allyl-*N*-(4-bromophenyl)-1,1-dichloroaminoborane (20**)**



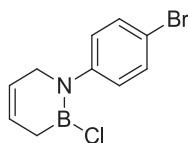
$^1\text{H NMR}$ (500 MHz, CDCl_3): $\delta = 6.95$ (d, $^3J = 8.8\text{ Hz}$, 2 H, $H-3,5$), 6.34 (d, $^3J = 8.8\text{ Hz}$, 2 H, $H-2,6$), 5.67-5.60 (m, 1 H, $\text{CH-CH}_2\text{N}$), 4.91-4.88 (m, $\text{CH}_2\text{-CH-CH}_2\text{N}$)^h, 3.83 (dt, $^3J = 5.7\text{ Hz}$, $^4J = 1.4\text{ Hz}$, 2 H, $\text{CH}_2\text{-N}$), ppm.

$^{11}\text{B NMR}$ (161 MHz, C_6D_6): $\delta = 31.9\text{ ppm}$.

^f The coupling constant and integral could not be assigned due to solvent signal overlap.

^g Mass spectrometry could not be performed as the compound was too sensitive towards moisture and oxygen. IR spectrum could not be measured with the available equipment.

^h Due to product signal overlap, integrals could not be assigned.

4.2.7 1-(4-Bromophenyl)-2-chloro-3,6-dihydro-1,2-azaborine (11)

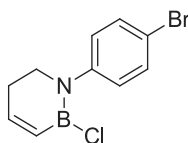
In a glovebox, **10** (6.82 g, 94% purity) was dissolved in CH_2Cl_2 (20 mL). Grubbs catalyst 1st gen (172 mg, 209 μmol , 1 mol%) was dissolved in CH_2Cl_2 (20 mL) and added to the aminoborane solution. The mixture was stirred for 19 h before the solvent was removed under reduced pressure. To remove the Grubbs catalyst, the product was sublimed (heating bath 70 °C, $8 \cdot 10^{-2}$ mbar) to give **11** and the isomer **11'** (10:1 ratio) as colourless crystals (4.81 g, 17.8 mmol) with a yield of 78%.

¹H NMR (500 MHz, C_6D_6): δ = 7.16 (*H*-3,5)ⁱ, 6.49 (d, 3J = 8.4 Hz, 2 H, *H*-2,6), 5.58 (m_c, 1 H, *CH*- CH_2B), 5.24 (dt, 3J = 10.1, 3.0 Hz, 4J = 2.0 Hz, 1 H, *CH*- CH_2N), 3.42 (m_c, 2 H, CH_2 -N), 1.77 (m_c, 2 H, CH_2 -B) ppm.

¹³C NMR (126 MHz, C_6D_6): δ = 146.0 (C-1), 132.5 (C-3,5), 129.0 (C-2,6), 124.9 (*CH*- CH_2N), 123.8 (*CH*- CH_2B), 120.1 (C-4), 53.9 (CH_2 -N), 11.6 (CH_2 -B) ppm.

¹¹B NMR (161 MHz, C_6D_6): δ = 38.7 ppm.

The mass spectrum showed no product signal for **11**. We presumed that **11** had hydrolysed when it came into contact with air moisture during injection. Therefore we prepared the hydrolysed product **27** from **11** to verify this assumption.

Isomer: 1-(4-Bromophenyl)-2-chloro-5,6-dihydro-1,2-azaborine (11')

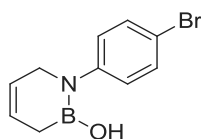
¹H NMR (500 MHz, C_6D_6): δ = 7.17 (*H*-3,5)^j, 6.73 (d, 3J = 8.8 Hz, 0.2 Hz, *H*-2,6), 6.38-6.31 (m, 0.1 H, *CH*=*CH*-B), 6.00 (dt, 3J = 11.8, 1.7 Hz, 0.1 H, *CH*-B), 2.90 (t, 3J = 7.2 Hz, 0.2 H, *CH*-N), 1.83-1.78 (m, 0.2 H, *CH*-*CH*-N) ppm.

¹¹B NMR (161 MHz, C_6D_6): δ = 34.1 ppm.

ⁱ The coupling constant and integral could not be assigned due to solvent signal overlap.

^j The coupling constant and integral could not be assigned due to solvent signal overlap.

4.2.8 1-(4-Bromophenyl)-3,6-dihydro-1,2-azaborinin-2-ol (27)



In a sealable NMR tube, the azaborine **11** (13 mg, 48.0 μmol) was dissolved in benzene- d_6 (7 mL) and the ^1H and ^{11}B NMR were measured. Then the NMR tube was opened for 5 minutes, sealed and shaken. This was repeated five times. Then a full NMR spectrum set was measured.

^1H NMR (500 MHz, C_6D_6): δ = 7.00 (d, 3J = 8.9 Hz, 2 H, *H*-3,5), 6.67 (d, 3J = 8.9 Hz, 2 H, *H*-2,6), 5.80 (m_c, 1 H, *CH*- CH_2 -B), 5.00 (m_c, 1 H, *CH*- CH_2 -N), 3.07 (m_c, 2 H, CH_2 -N), 1.96-1.90 (m, 2 H, CH_2 -B) ppm.

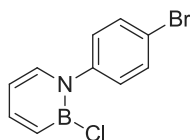
^{13}C NMR (126 MHz, C_6D_6): δ = 146.8 (*C*-1), 131.8 (*C*-3,5), 125.2 (*C*-2,6), 132.0 (CH_2 -*CH*-B), 119.5 (CH - CH_2 -N), 118.9 (*C*-4), 53.5 (*CH*-N), 28.4 (*CH*-B) ppm.

^{11}B NMR (161 MHz, C_6D_6): δ = 28.3 ppm.

MS (EI, 70 eV): m/z (%) = 251/253 (100) [M]⁺, 235/237 (30) [M -O]⁺, 197/199 (40) [M - $\text{C}_2\text{H}_4\text{BO}$]⁺.

HRMS (EI): m/z found 251.0124; calcd. for $\text{C}_{10}\text{H}_{11}\text{BBrNO}$ 251.0117.^k

4.2.9 1-(4-Bromophenyl)-2-chloro-1,2-dihydro-1,2-azaborine (21)



At 19 °C, **11** (812 mg, 3.00 mmol) was given into a sublimation flask and dissolved in cyclohexene (20 mL). Palladium black (162 mg, 1.52 mmol) was added and the flask was sealed. The reaction mixture was heated to 95 °C and stirred at reflux for 20 h. After cooling to 19 °C, the solvent was removed under reduced pressure. The crude product (573 mg) was separated from the catalyst via sublimation (heating bath 65 °C, cooling liquid -25 °C, $1.1 \cdot 10^{-1}$ mbar) and formed colourless crystals. The yield of 21% had to be calculated from the product/starting material *H*-2,6 integral ratio (1.0:3.7), as both sublimed together and could not be separated.

^1H NMR (500 MHz, C_6D_6): δ = 7.37-7.30 (m, 1 H, *CH*-*CH*-B), 7.07 (d, 3J = 8.7 Hz, 2 H, *H*-3,5), 6.91 (m_c, 1 H, *CH*-B), 6.55 (m_c, 1 H, *CH*-N), 6.45 (d, 3J = 8.7 Hz, 2 H, *H*-2,6), 5.95 (m_c, 2 H, *CH*-*CH*-N) ppm.^l

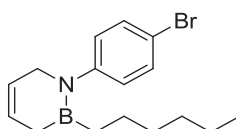
^k IR spectrum could not be measured with the available equipment.

^l See Appendix (Figure 13, 14).

^{13}C NMR (126 MHz, C_6D_6): δ = 145.9 (C-1), 145.3 (CH-CH-B), 132.2 (C-3,5), 128.9 (CH-B), 138.4 (CH-N), 128.5 (C-2,6), 120.1 (C-4), 110.7 (CH-CH-N) ppm.

^{11}B NMR (161 MHz, C_6D_6): δ = 33.2 ppm. ^m

4.2.10 1-(4-Bromophenyl)-2-hexyl-3,6-tetrahydro-1,2-azaborine (22)



A solution of **11** (811 mg, 3.00 mmol) in 2-MeTHF (10 mL) was given to a Schlenk flask at $-94\text{ }^\circ\text{C}$., followed by the dropwise addition of *n*-hexyllithium (1.30 mL, 3.00 mmol, 2.3 M in hexane) via syringe pump (0.1 mL/min). The reaction mixture was stirred for 20 min at $-94\text{ }^\circ\text{C}$ and then stirred for 18 h at $19\text{ }^\circ\text{C}$. The reaction mixture was transferred into a glovebox. The precipitation was filtered off and washed with *n*-hexane (20 mL). The remaining solvent was removed under reduced pressure (50 $^\circ\text{C}$, 3.2 mbar). **22** (838 mg, 2.62 mmol) was afford as a pale brown liquid in 87% yield.

^1H NMR (500 MHz, C_6D_6): δ = 7.18 (d, 3J = 8.6 Hz, 2 H, *H*-3,5), 6.52 (d, 3J = 8.6 Hz, 2 H, *H*-2,6), 5.91 (m_c, 1 H, CH-CH₂-B), 5.49 (m_c, 1 H, CH-CH₂-N), 3.60 (m_c, 2 H, CH₂-N), 1.69 (m_c, 2 H, CH-CH₂-B), 1.32-1.20 (m, 8 H, (CH₂)₄-CH₃), 0.67 (m_c, 2 H, CH₂-CH₂-B) ppm.

^{13}C NMR (126 MHz, C_6D_6): δ = 148.6 (C-1), 142.6 (CH₂-CH₂-B), 132.4 (C-3,5), 129.0 (C-2,6), 125.7 (CH-CH₂-B), 124.2 (CH-CH₂-N), 119.2 (C-4), 53.1 (CH₂-N), 32.2 (CH₃-CH₂-CH₂), 25.7 (CH₃-CH₂-CH₂-CH₂), 23.0 (CH₂-CH₃, CH₂-CH₂-B), 17.0 (CH-CH₂-B), 14.4 (CH₃) ppm.

^{11}B NMR (161 MHz, C_6D_6): δ = 45.0 ppm.

MS (EI, 70 eV): *m/z* (%) = 319/321 (28) [M]⁺, 265/267 (33) [M-C₄H₆]⁺, 235/237 (100) [M-C₆H₁₂]⁺, 183 (70) [M-C₃H₇Br]⁺.

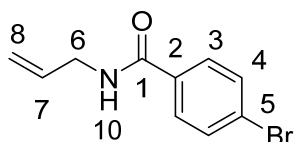
HRMS (EI): *m/z* found 319.1110; calcd. for C₁₆H₂₃BBrN 319.1109.ⁿ

^m IR spectrum could not be measured with the available equipment. The mass spectrum could not analysed sue to the overriding starting material signals.

ⁿ IR spectrum could not be measured with the available equipment.

5.2.6 Syntheses and Characterisation of Isolated Compounds

5.2.6.1 N-Allyl-4-bromobenzamide (17)¹¹¹



In a dried Schlenk flask under nitrogen atmosphere, a solution of allylamine (8.70 mL, 116 mmol) in CH_2Cl_2 (100 mL) was cooled to 2 °C. Triethylamine (16.6 mL, 120 mmol) was added before 4-bromobenzoyl chloride (25.2 g, 115 mmol) in CH_2Cl_2 (20 mL) was dropped into the solution via syringe pump (1 mL/min). After 26 h, water (60 mL) was added and the organic layer was separated. The aqueous layer was extracted with CH_2Cl_2 (3 x 100 mL). The combined organic extracts were washed with 10% aqueous HCl solution (30 mL), saturated NaHCO_3 solution (30 mL) and saturated NaCl solution (30 mL) before drying over MgSO_4 and solvent evaporation under reduced pressure yielded in **99%** (26.6 g) of the product **17** as a colourless solid.

$^1\text{H NMR}$ (500 MHz, CDCl_3): δ = 7.61 (m, 4H, H-3, H-4), 6.16 (s, 1H, H-10), 5.94 (ddt, J = 17.1, 10.3, 5.7 Hz, 1H, H-7), 5.23 (m, 2H, H-8_{cis/trans}), 4.08 (tm, J = 5.7 Hz, 2H, H-6) ppm.

$^{13}\text{C NMR}$ (126 MHz, CDCl_3): δ = 166.5 (C1), 134.0 (C7), 133.4 (C2), 132.0, 128.7 (C3, C4), 126.3 (C5), 117.1 (C8), 42.7 (C6) ppm.

5 Experimental Section

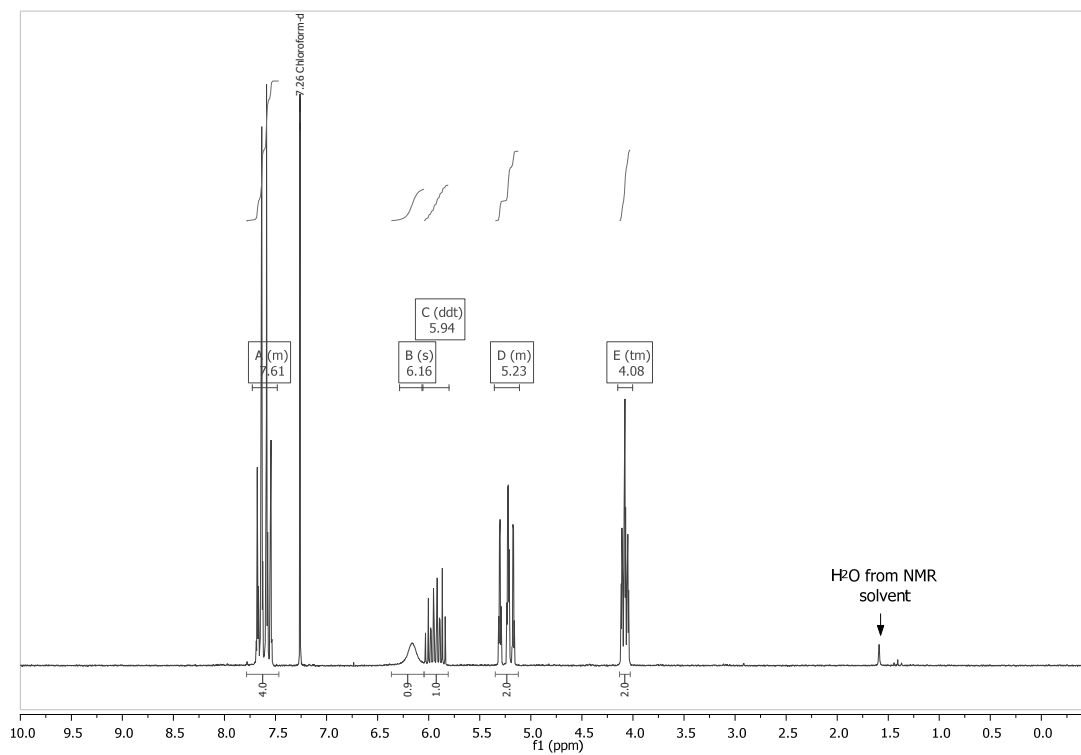


Figure SI- 1. ^1H NMR spectrum of amide **17**.

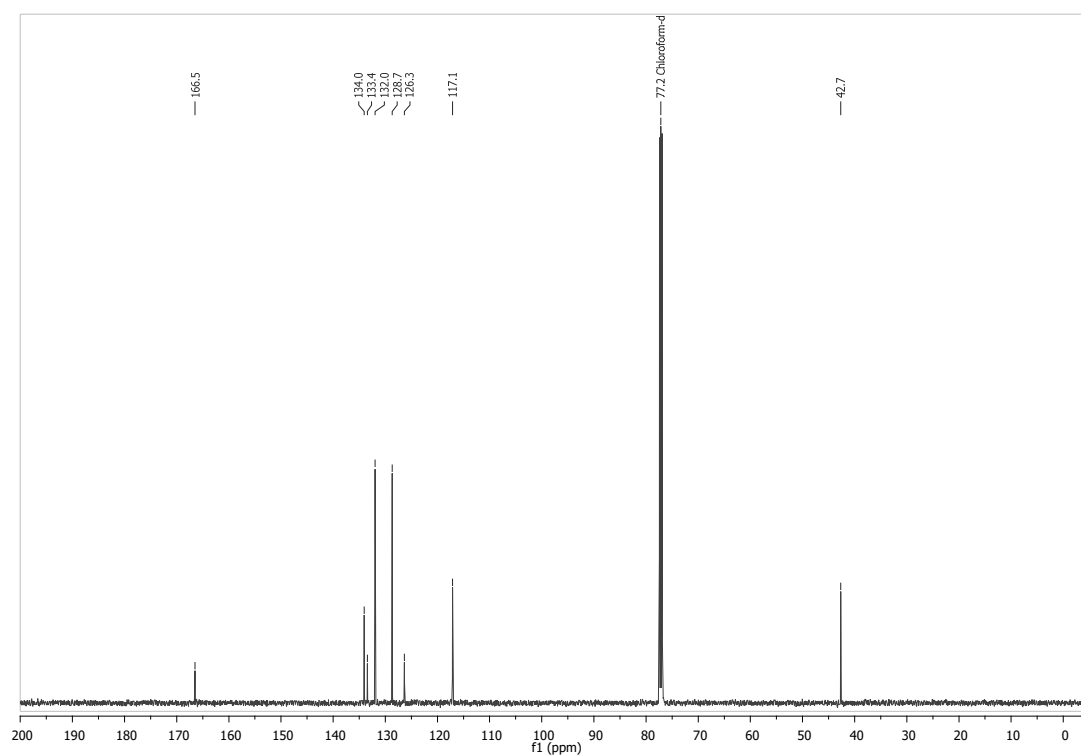
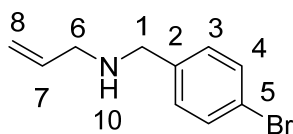


Figure SI- 2. $^{13}\text{C}\{^1\text{H}\}$ NMR spectrum of amide **17**.

5.2.6.2 *N*-Allyl-*N*-(4'-bromobenzyl)amine (**14**)¹¹²

In a Schlenk flask, *N*-allyl-4-bromobenzamide **17** (3.66 g, 15.0 mmol) in dry *t*BuOMe (60 mL) was added dropwise (course of 30 min) to a suspension of LiAlH₄ (1.30 g, 30.0 mmol) in dry *t*BuOMe (60 mL) at -10 °C. The suspension was stirred for 4 h at 22 °C (intensive green colour), cooled to 0 °C and carefully quenched with H₂O (5 mL), NaOH solution (15%, 3 mL) and further H₂O (3 mL). The suspension was filtered and the filtrate was dried over MgSO₄. Solvent evaporation resulted in **96%** (3.26 g) of product **14** as colourless oil.

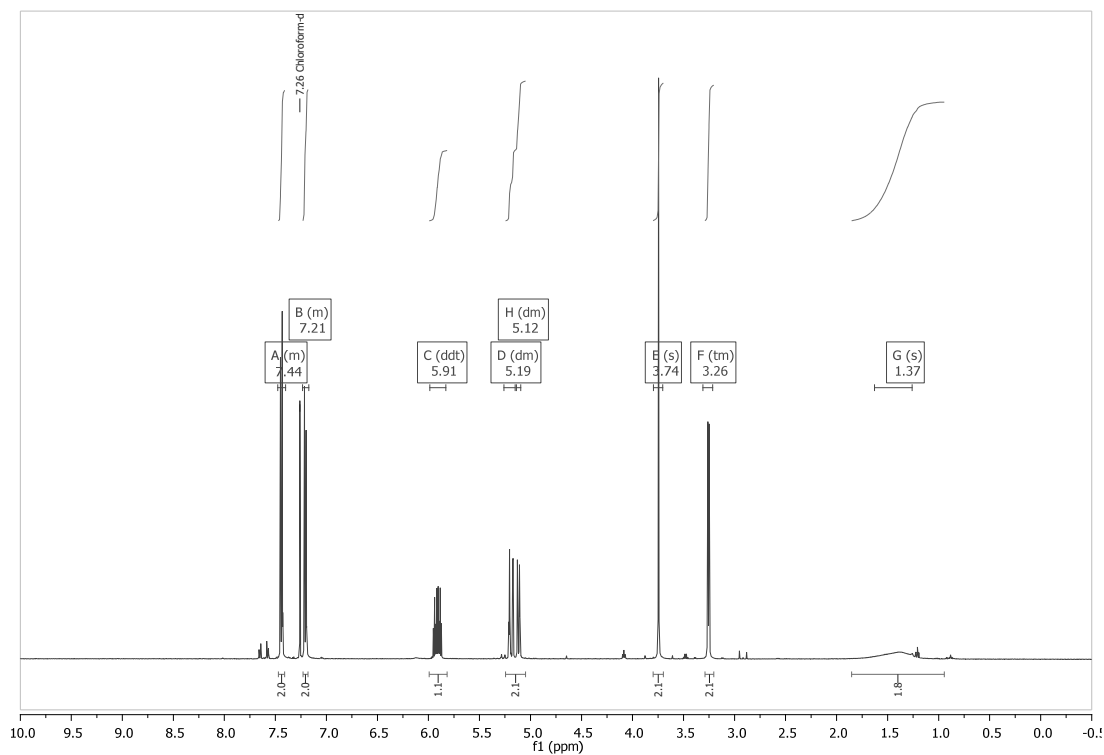
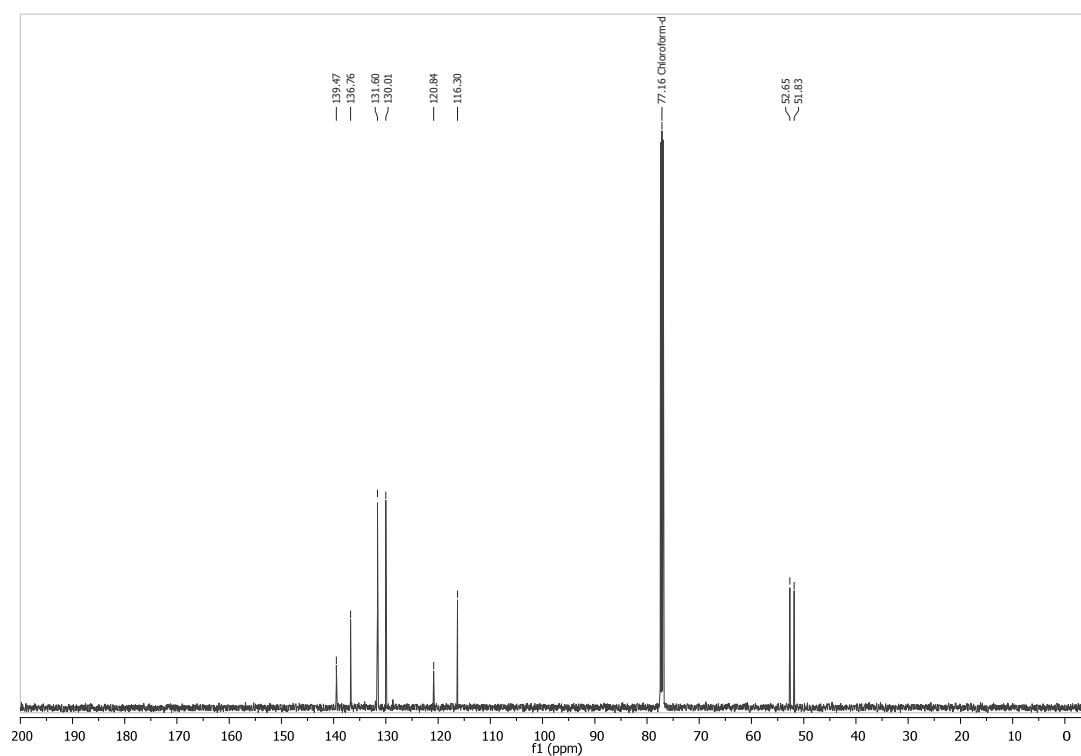
¹H NMR (500 MHz, CDCl₃): δ = 7.44 (m, 2H, H-3), 7.21 (m, 2H, H-4), 5.91 (ddt, *J* = 17.1, 10.3, 6.0 Hz, 1H, H-7), 5.26 (dm, *J* = 17.1 Hz, 1H, H-8_{trans}), 5.19 (dm, *J* = 10.3 Hz, 1H, H-8_{cis}), 3.74 (s, 2H, H-1), 3.26 (dm, *J* = 6.0 Hz, 2H, H-6), 1.37 (s, 1H, H-10) ppm.

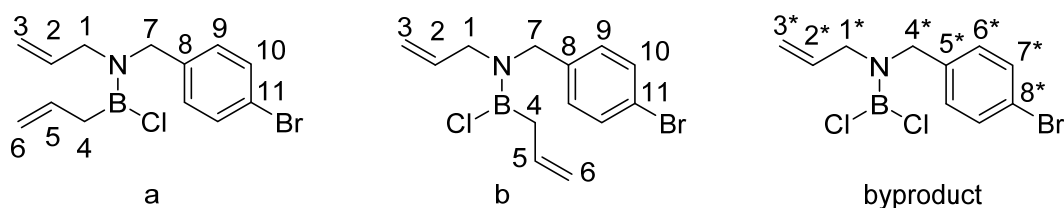
¹³C NMR (126 MHz, CDCl₃): δ = 139.5 (C2), 136.8 (C7), 131.6 (C4), 130.0 (C3), 120.8 (C5), 116.3 (C8), 52.7 (C1), 51.8 (C6) ppm.

IR (ATR) $\tilde{\nu}_{\max}$ = 3077, 2978, 2816, 1643, 1591, 1486, 1450, 1403, 1102, 1069, 1011, 993, 917, 793 cm⁻¹

GC-MS *m/z*: [M+H]⁺ 225.96/223.96 (15%/16%), [C₇H₆Br]⁺ 170.98/168.97 (95%/100%).

HRMS (EI⁺) (*m/z*): [M - H]⁺ Calcd for C₁₀H₁₁N⁷⁹Br, 224.0075; found, 224.0076.

Figure SI- 3. ^1H NMR spectrum of amine **14**.Figure SI- 4. $^{13}\text{C}\{^1\text{H}\}$ NMR spectrum of amine **14**.

5.2.6.3 1,2-Diallyl-1-(4'-bromobenzyl)-2-chloroboranamine (18)

In a Schlenk flask, a solution of BCl_3 (40.0 mL, 40.0 mmol, 1.00 M in hexanes) in *n*-pentane (180 mL) was cooled to $-92\text{ }^\circ\text{C}$ under an atmosphere of nitrogen. Triallylborane^a (1.34 g, 10.0 mmol) was added dropwise over a course of 1 min. The reaction mixture was stirred at $-92\text{ }^\circ\text{C}$ for 2 h before **14** (4.27 g, 60.0 mmol) and Et_3N (6.07 g, 60.0 mmol) in *n*-pentane (5 mL) were added dropwise using a syringe pump (0.12 mL/min). After addition, the mixture was allowed to warm to $22\text{ }^\circ\text{C}$. After 20 h of stirring, solvent was evaporated under inert conditions until approx. half volume and the mixture was filtrated through a syringe filter (pore size = $0.45\text{ }\mu\text{m}$). Solvent evaporation (until $40\text{ }^\circ\text{C}$, 5 mbar) resulted in a yield of **93%** (8.45 g, 27.1 mmol; 2:1.5 mixture of **a** and **b**) containing **12%** of by-product.

Kugelrohr distillation was not possible due to vacuum limits of the apparatus.

^1H NMR (500 MHz, C_6D_6): δ = 7.21 (m, 3.5H, H-10_{a/b}), 5.74 (m, 2H, 9-H_{a/b}), 6.59 (m, 1.5H, 9-H_{a/b}), 6.00 (m, 1.75H, 5-H_{a/b})^b, 5.41 (m, 1.75H, 2-H_{a/b}), 4.94 (m, 7H, 3-H_{a/b}, 6-H_{a/b}), 4.14 (s, 2H, 7-H_{a/b}), 3.82 (s, 1.5H, 7-H_{a/b}), 3.56 (m, 1.5H, 1-H_{a/b}), 3.21 (m, 2H, 1-H_{a/b}), 1.96 (s, 3.5H, 4-H_{a/b}) ppm.

By-product: δ = 7.26 (m, H-7*), 6.80 (m, H-6*), 5.56 (m, H-2*), 4.06 (s, H-4*), 3.42 (s, H-1*) ppm.^c

^{13}C NMR (91 MHz, C_6D_6): δ = 137.5, 137.2 (C8_{a,b}), 134.9, 134.9 (C5_{a,b}), 134.6, 134.5 (C2_{a,b}), 132.0, 131.9 (C9_{a,b}), 129.7, 129.1 (C10_{a,b}), 121.4 (C11_{a,b}), 116.8, 116.6 (C3_{a,b}), 115.4 (C6_{a,b}), 51.4, 51.2 (C7_{a,b}), 50.9, 50.3 (C1_{a,b}), 26.9 (C4) ppm.

^{11}B NMR (161 MHz, C_6D_6): δ = 39.1 ppm.

IR:^d

^a The reaction procedure is published in **Chapter 5.3**.

^b The integral of this proton is usually lower than expected for all similar species.

^c Proton H-3* is covered by the product proton signals between 5.08 and 4.78 ppm.

^d With our available equipment, IR measurements cannot be performed for air sensitive compounds.

HRMS (EI⁺) (*m/z*): [M – C₃H₅BCl]⁺ Calcd for C₁₀H₁₁N⁷⁹Br, 224.0075; found, 224.0069.

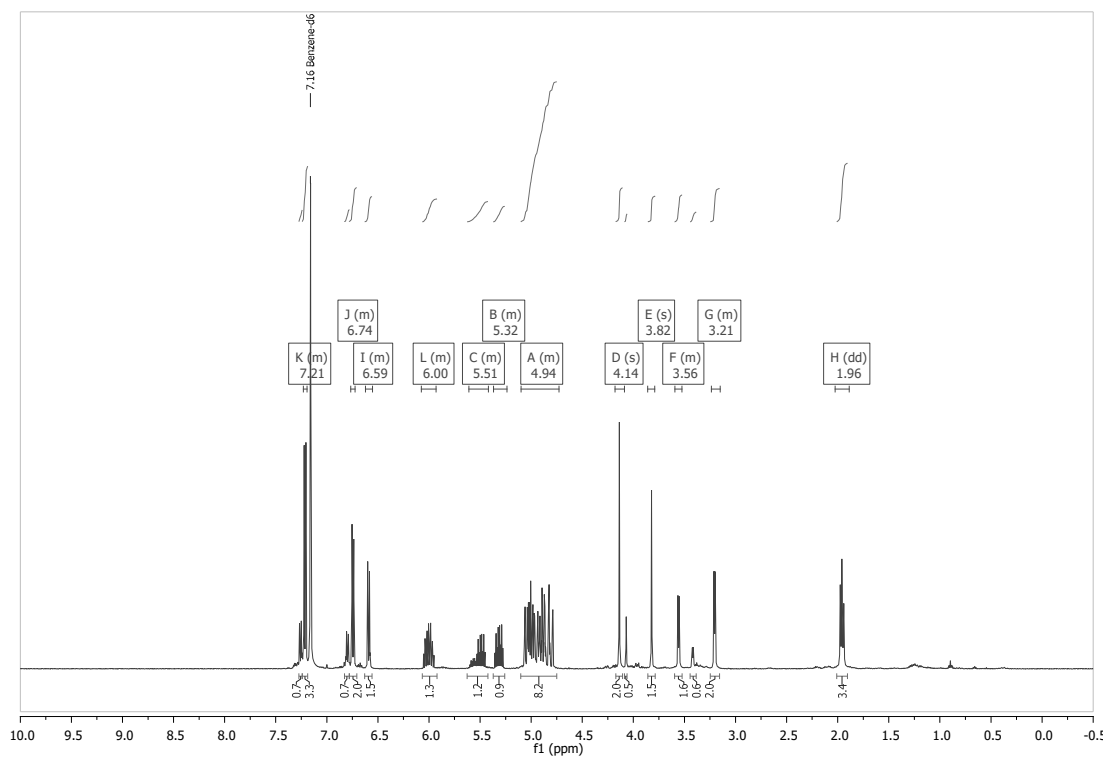


Figure SI- 5. ¹H NMR spectrum of aminoborane **18**.

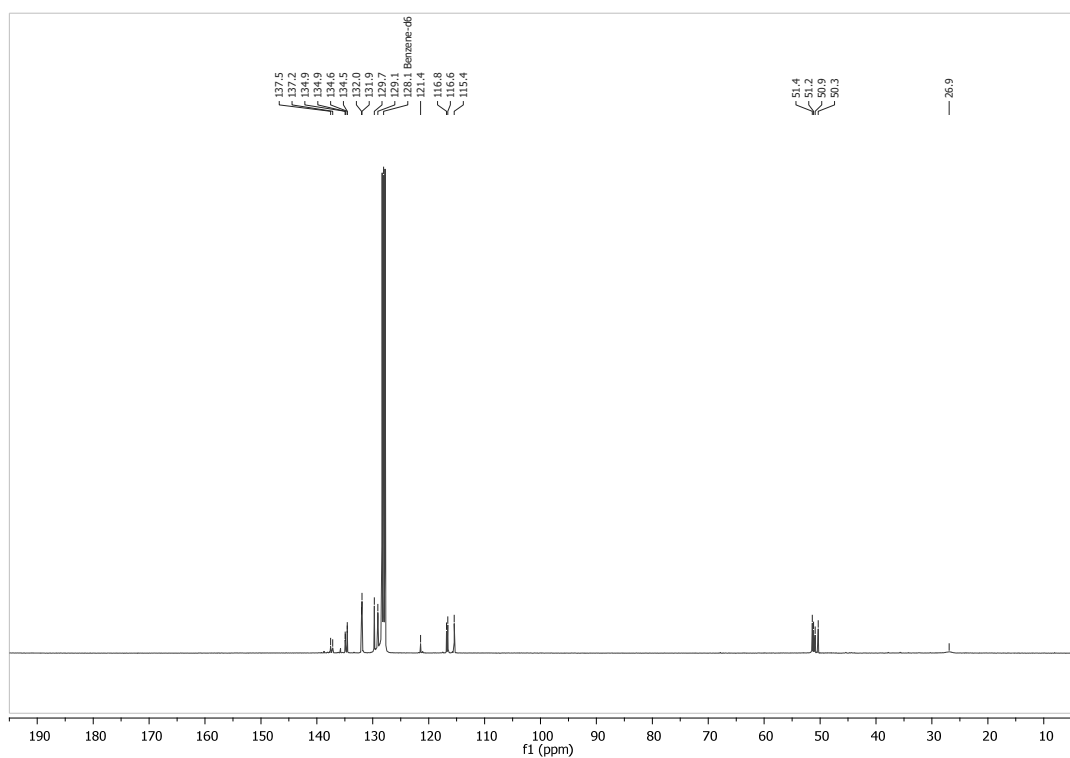


Figure SI- 6. ¹³C{¹H} NMR spectrum of aminoborane **18**.

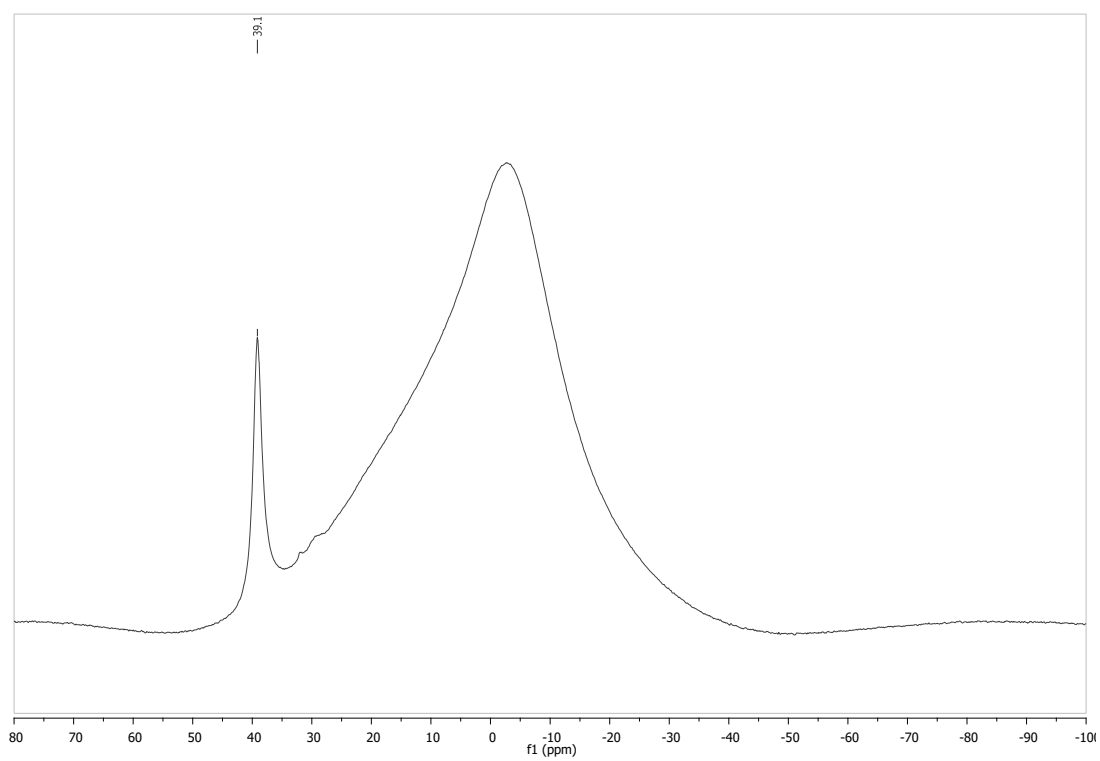
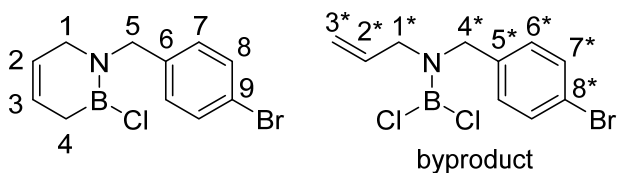


Figure SI- 7. $^{11}\text{B}\{^1\text{H}\}$ NMR spectrum of aminborane **18**.

5.2.6.4 1-(4'-bromobenzyl)-2-chloro-3,6-dihydro-1,2-azaborine (**12**)

In a glovebox, a 150 mL Schlenk flask was charged with **18** (8.04 g; 25.7 mmol) and CH_2Cl_2 (200 mL). Grubbs catalyst 1st generation (212 mg; 257 μmol) in CH_2Cl_2 (20 mL) was added dropwise over the course of 1 min. to the aminoborane solution. The mixture was stirred for 20 h at 20 °C before the solvent was removed under reduced pressure (40 °C, until 10 mbar). Purification by sublimation under inert conditions (65 °C, 3×10^{-2} mbar) led to a yield of **62%** (4.53 g, 15.9 mmol) of **12**.

¹H NMR (500 MHz, C_6D_6): δ = 7.20 (m, 2H, H-8), 6.72 (m, 2H, H-7), 5.52 (m, 1H, H-3), 5.16 (m, 1H, H-2), 3.99 (s, 2H, H-5), 3.01 (m, 2H, H-1), 1.73 (m, 2H, H-4) ppm.

By-product: δ = 7.29 (m, H-7*), 6.88 (m, H-6*), 5.62 (m, H-2*), 4.94 (m, H-3*), 3.99 (s, H-4*), 3.11 (s, H-1*) ppm.

¹³C NMR (126 MHz, C_6D_6): δ = 137.1 (C6), 131.9 (C8), 129.7 (C7), 124.8 (C3), 123.9 (C2), 121.5 (C9), 53.4 (C5), 49.0 (C1) ppm.^a

¹¹B NMR (161 MHz, C_6D_6): δ = 38.5 ppm.

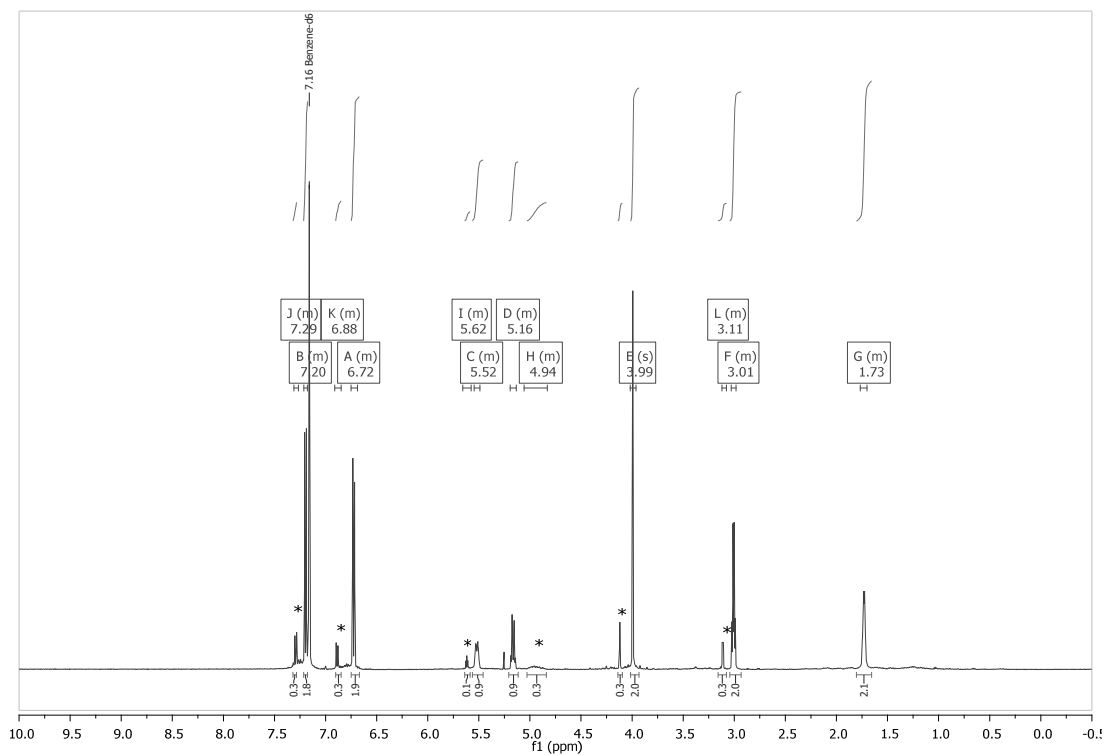
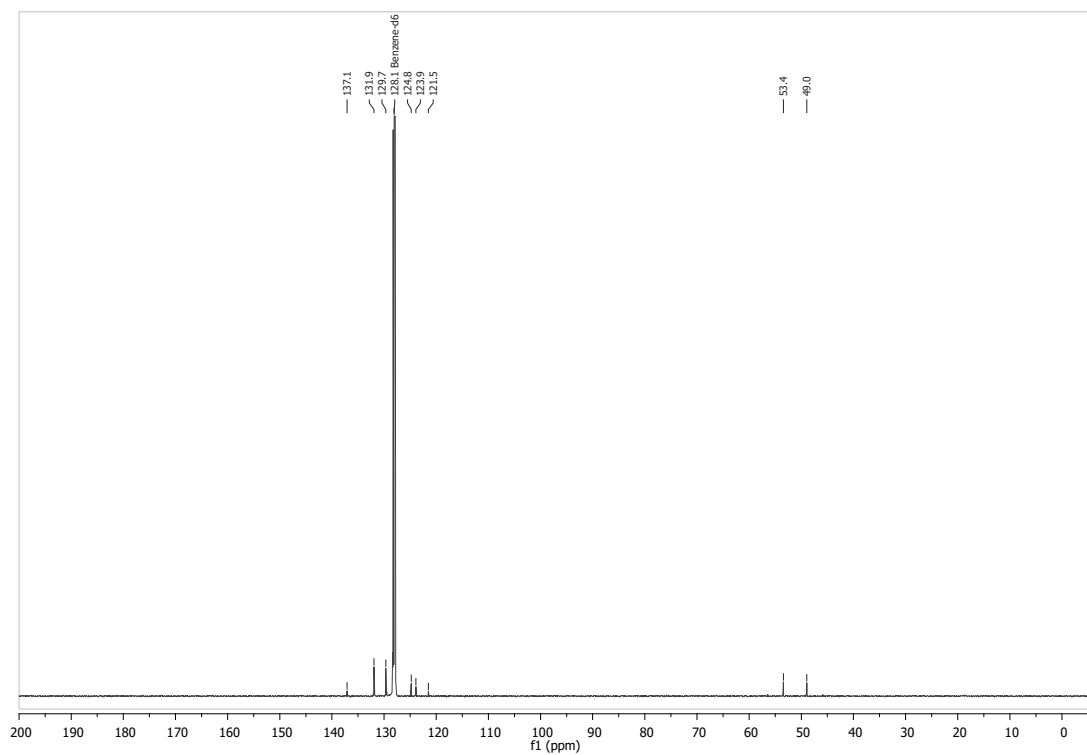
IR:^b.

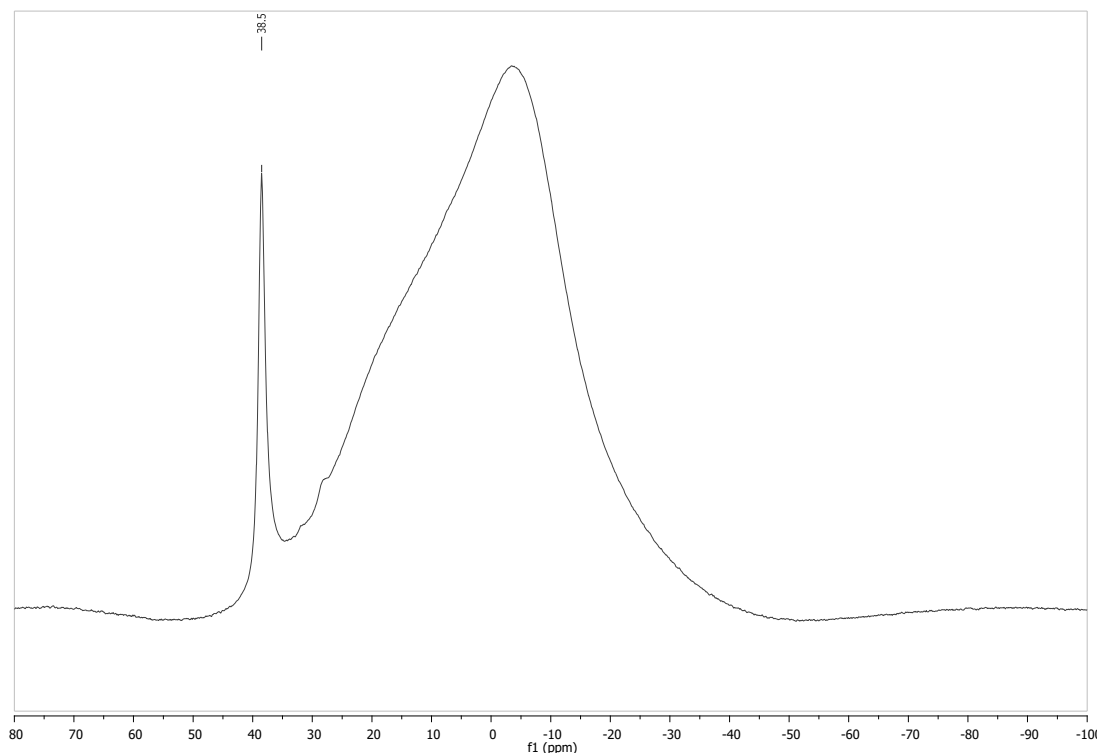
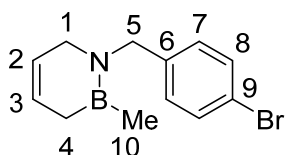
HRMS:^c.

^a The signal for the carbon (C-4) adjacent to boron was not visible in the ¹³C NMR spectrum.

^b With our available equipment, IR measurements cannot be performed for air sensitive compounds.

^c With our available equipment, high resolution mass spectrometry cannot be performed for this air sensitive compound.

Figure SI- 8. ^1H NMR spectrum of aminoborane **12**.Figure SI- 9. $^{13}\text{C}\{^1\text{H}\}$ NMR spectrum of aminoborane **12**.

Figure SI- 10. $^{11}\text{B}\{^1\text{H}\}$ NMR spectrum of aminoborane **12**.5.2.6.5 1-(4'-bromobenzyl)-2-methyl-3,6-dihydro-1,2-azaborine (**13**)

In a Schlenk flask, aminoborane **12** (569 mg; 2.00 mmol) was dissolved in THF (20 mL) and cooled to $-78\text{ }^{\circ}\text{C}$. Over a course of 5 min. methyl lithium (1.6 M in THF; 1.25 mL; 2.00 mmol) was added via syringe to the stirring solution. After stirring for 30 min. at $-78\text{ }^{\circ}\text{C}$ and additional 2 h at $21\text{ }^{\circ}\text{C}$, the solution was concentrated to approx. $\frac{1}{4}$ volume under vacuum ($40\text{ }^{\circ}\text{C}$, until 5 mbar). The precipitate was filtered via a PTFE syringe filter (pore size = $0.45\text{ }\mu\text{m}$) under inert conditions. A further solvent evaporation ($40\text{ }^{\circ}\text{C}$, until 5 mbar) and a subsequent Kugelrohr distillation ($120\text{ }^{\circ}\text{C}$; 5×10^{-1} mbar) led to **84%** of product **13** with a purity of approx. 92% (calculated by ^1H NMR).

^1H NMR (500 MHz, CD_2Cl_2): δ = 7.45 (m, 2H, H-8), 7.14 (m, 2H, H-7), 5.75 (m, 1H, H-3), 5.51 (m, 1H, H-2), 4.24 (s, 2H, H-5), 3.42 (m, 2H, H-1), 1.54 (m, 2H, H-4), 0.37 (m, 2H, H-10) ppm.

^{13}C NMR (126 MHz, CD_2Cl_2): δ = 139.3 (C6), 132.0 (C8), 129.6 (C7), 126.0 (C3), 124.9 (C2), 121.0 (C9), 49.0 (C5), 18.5 (C4), 2.6 (C10) ppm.^a

^{11}B NMR (116 MHz, CD_2Cl_2): δ = 44.9 ppm.

IR:^b

HRMS (EI^+) (m/z): $[\text{M}]^{+\bullet}$ Calcd for $\text{C}_{12}\text{H}_{15}\text{BNBr}$, 263.0481; found, 263.0479.

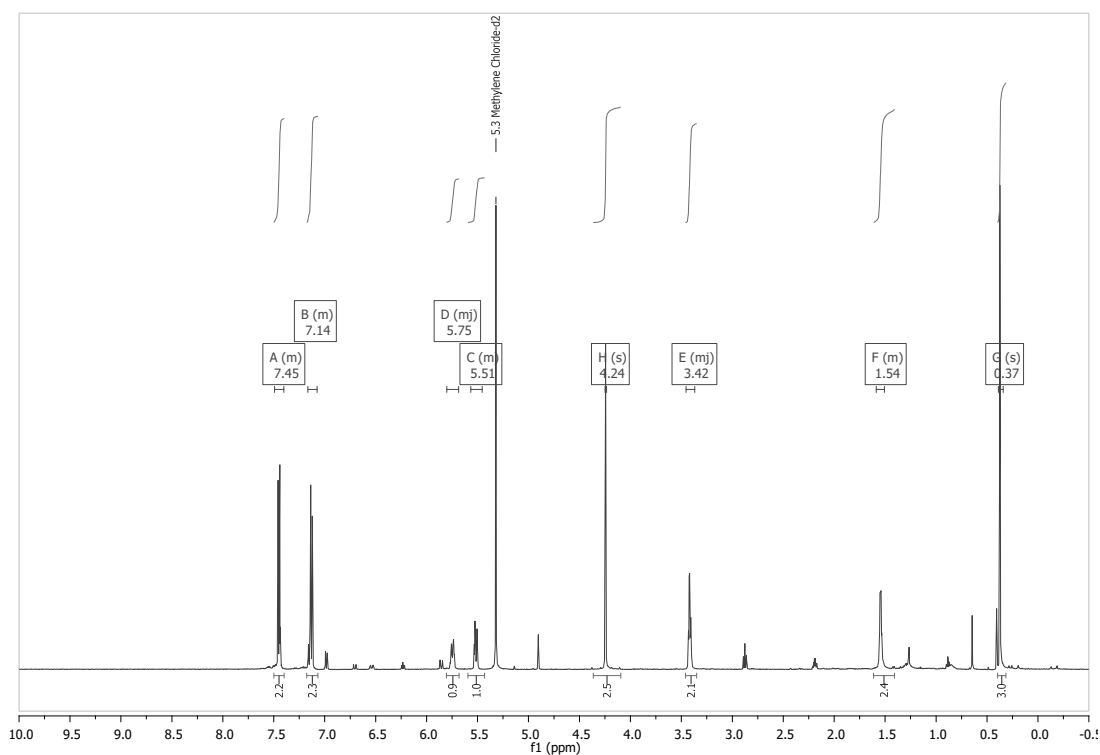
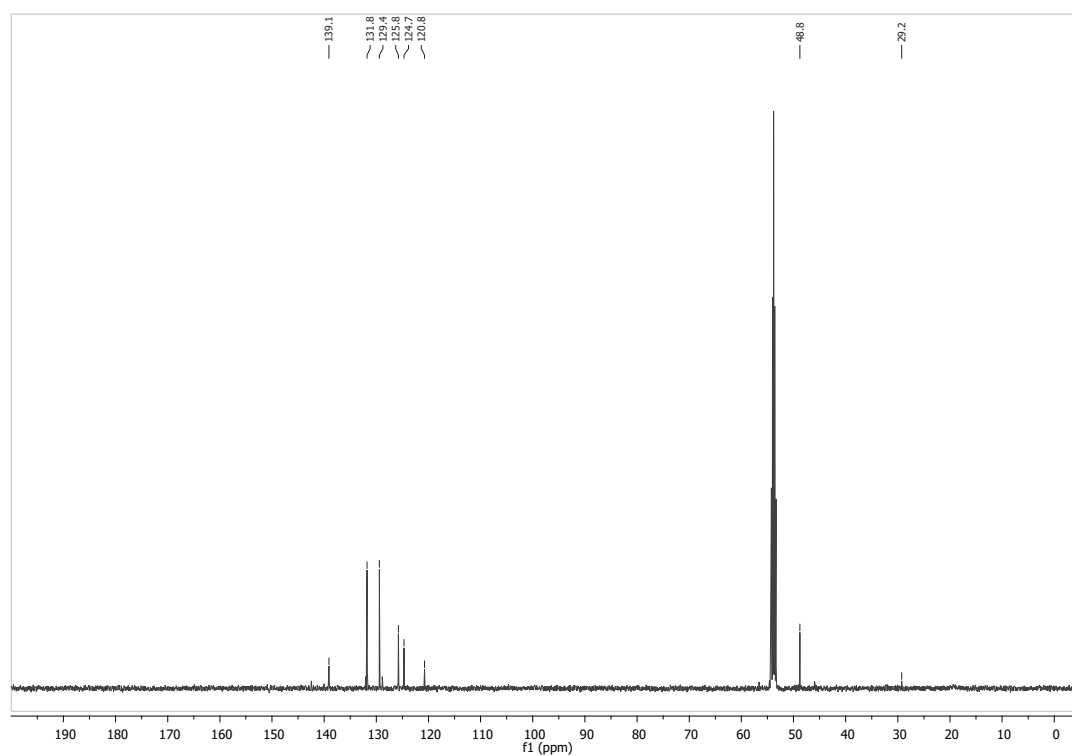
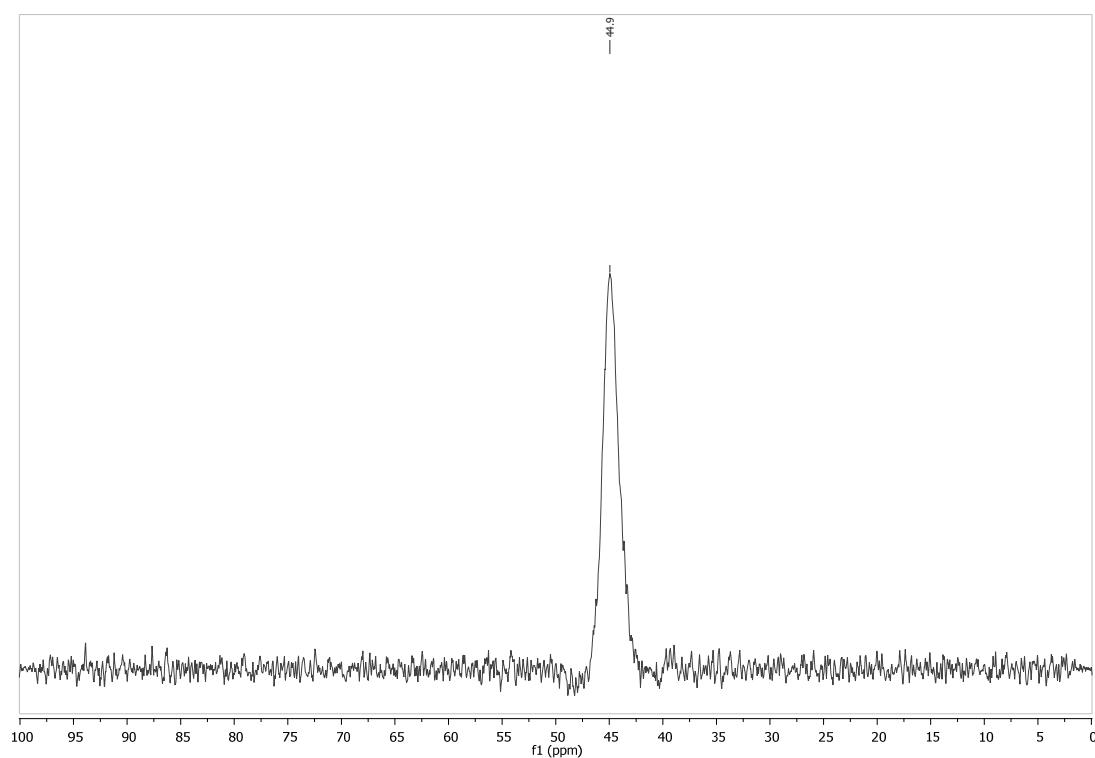


Figure SI- 11. ^1H NMR spectrum of aminoborane **13**.

^a The carbon signals C4 and C10 are only visible in the HSQC spectrum.

^b With our available equipment, IR measurements cannot be performed for air sensitive compounds.

Figure SI- 12. $^{13}\text{C}\{^1\text{H}\}$ NMR spectrum of aminoborane **13**.Figure SI- 13. $^{11}\text{B}\{^1\text{H}\}$ NMR spectrum of aminoborane **13** in CD_2Cl_2 .

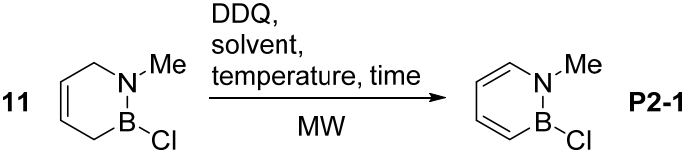
5.2.7 Oxidative Dehydrogenation Reaction Screening

5.2.7.1 Reaction procedures

With a microwave apparatus:

In a glovebox, the **reducing agent (DDQ or Pd black)** was filled into a microwave vial equipped with a microwave stirring bar. Afterwards, the vial was filled with the **solvent**, before the **starting material** was added. The reaction vial was sealed with a microwave cap (with a PTFE septum). Outside the glovebox, the reaction vial was directly put into the microwave irradiated to the target **reaction temperature**. After the **irradiation time**, the vial was transferred into the glovebox for work-up. The mixture was filtered via syringe filter and subsequently a ^1H NMR spectrum of the crude mixture was measured to determine the conversion.

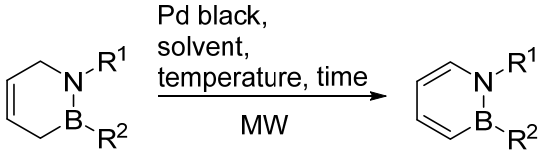
Table SI- 2. Dehydrogenation approaches with azaborine precursor **11** and DDQ as reducing agent under microwave conditions; for synthesis of **11**: see **Chapter 5.3.1**.

						
En-try	Starting material	DDQ	Solvent	Temperature	Time	Conversion ^a
1	11 (65 mg; 500 μmol)	113 mg; 500 μmol	toluene	80 °C	4 h	- ^b
2	11 (65 mg; 500 μmol)	227 mg; 1.00 mmol	<i>n</i> -hexane	120 °C	2.5 h	0%
3	11 (65 mg; 500 μmol)	231 mg; 1.02 mmol	CH_2Cl_2	60 °C	1 h	- ^{b,c}

^a conversion measured by ^1H NMR of the crude mixture based on remained starting material (not isolated); ^b no starting material left, possibly due to degradation; ^c no signals in ^1H and ^{11}B NMR in crude mixture anymore.

5 Experimental Section

Table SI- 3. Dehydrogenation approaches with Pd black as reducing agent under microwave conditions.

						
<p>8, 21: R¹ = 4-BrPh, R² = Cl 11, P2-1: R¹ = Me, R² = Cl 12, 19: R¹ = 4-BrBn, R² = Cl 13, 22: R¹ = 4-BrBn, R² = Me</p>						
Entry	Starting material	Pd black	Solvent	Temperature	Time	Conversion ^a
1	8 (135 mg; 500 μmol)	11 mg; 100 μmol	cyclohexene	180 °C	4 h	29% ^b (26% after 1 h)
2	12 (142 mg; 499 μmol)	11 mg; 100 μmol	cyclohexene	200 °C	1 h	13% ^b
3	13 (138 mg; 523 μmol)	10 mg; 94 μmol	cyclohexene	180 °C	4 h	9% ^b
4	11 (65 mg; 500 μmol)	11 mg; 100 μmol	cyclohexene	120 °C	4 h	100% ^{c, d} (71% yield)
5	11 (129 mg; 1.00 mmol), ^e	22 mg; 200 μmol	cyclohexene	120 °C	4 h	0% ^{b, e}
6	12 (142 mg; 499 μmol)	11 mg; 100 μmol	chlor-benzene	220 °C (250 °C)	4 h (+6 h)	27% ^{f, g} (58%)
7	12 (142 mg; 499 μmol)	11 mg; 100 μmol	chlor-benzene	250 °C	24 h	66% ^f

^a conversion measured by ¹H NMR spectrum of the crude mixture based on remained starting material (not isolated); ^b Pd was agglomerated; ^c in brackets: Isolated yield of a 11.5 mmol approach after purification by Kugelrohr distillation; ^d Pd was not agglomerated, cyclohexene was also nearly full converted; ^e bromobenzene (157 mg; 1.00 mmol) was added to test the inhibitor effect of aromatic bromides; ^f Pd was not agglomerated as for cyclohexene as solvent; ^g in brackets: Irradiation of the mixture was continued.

With conventional heating:

The reactions without irradiation in the microwave were prepared in the same way as for microwave reactions – with the exception of heating in a microwave apparatus. Instead, the mixture was stirred at the target **reaction temperature** in a microwave vial inside the glovebox.

Table SI- 4. Dehydrogenation approaches with DDQ as reducing agent under inert conditions in the glovebox.

<p> 11, P2-1: R¹ = Me, R² = Cl 12, 19: R¹ = 4-BrBn, R² = Cl </p>						
Entry	Starting material	DDQ	Solvent	Temperature	Time	Conversion ^a
1	12 (500 mg; 1.76 mmol)	439 μg; 1.93 mmol	<i>n</i> -hexane	25 °C	48 h	7%
2	12 (500 mg; 1.76 mmol)	432 μg; 1.90 mmol	CH ₂ Cl ₂	25 °C	48 h	- ^b
3	11 (65 mg; 500 μmol)	113 mg; 500 μmol	toluene	21 °C	1 h	- ^b

^a conversion measured by ¹H NMR spectroscopy of the crude mixture based on remaining starting material (not isolated); ^b no starting material left, possibly due to degradation.

5 Experimental Section

5.2.7.2 ^1H and $^{11}\text{B}\{^1\text{H}\}$ NMR spectra for conversion control

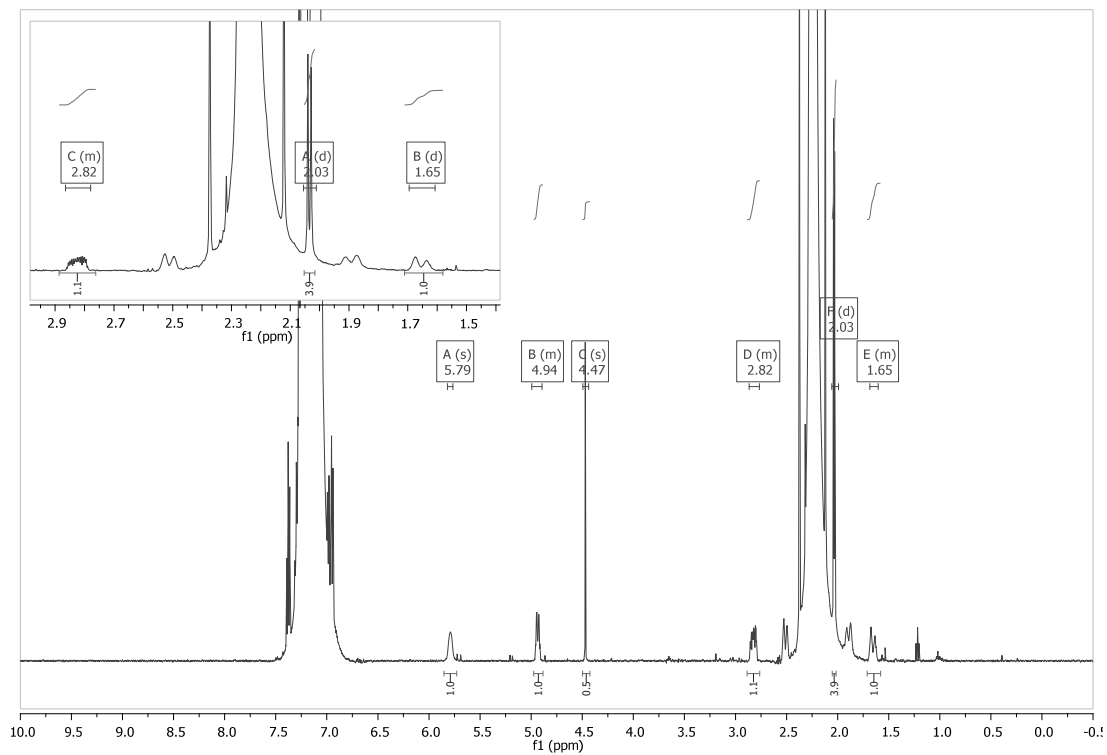


Figure SI- 14. Crude ^1H NMR spectrum of **Entry 1, Table SI- 2.**

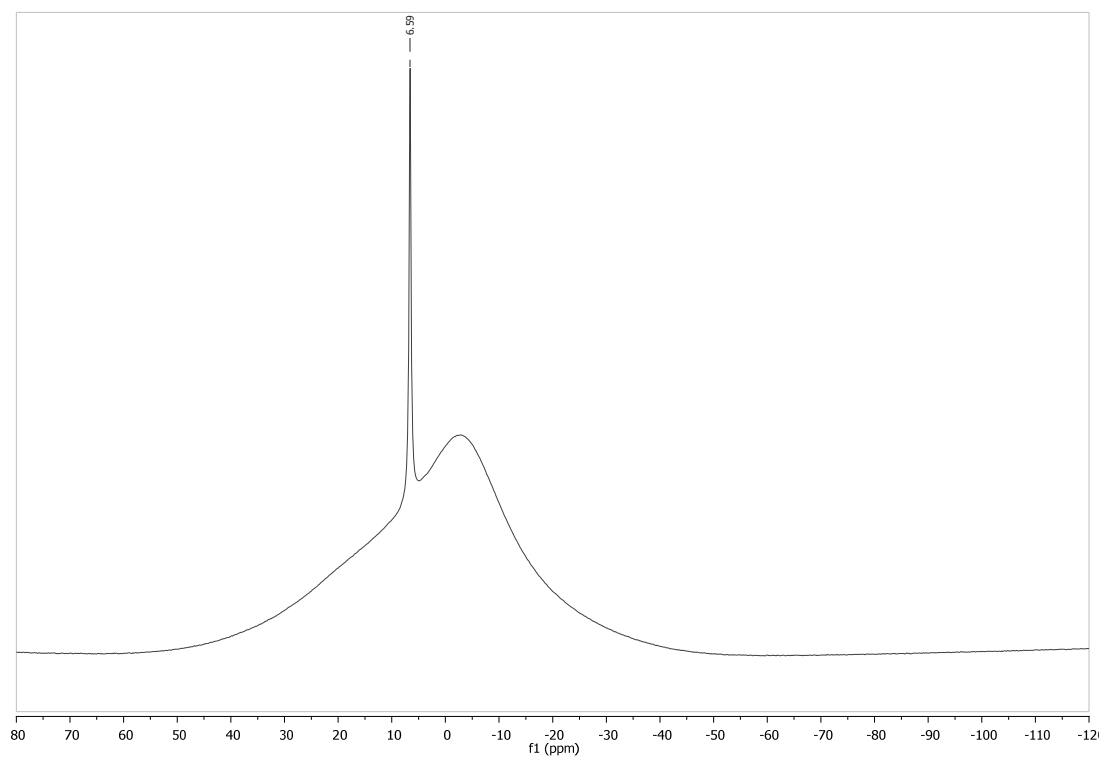
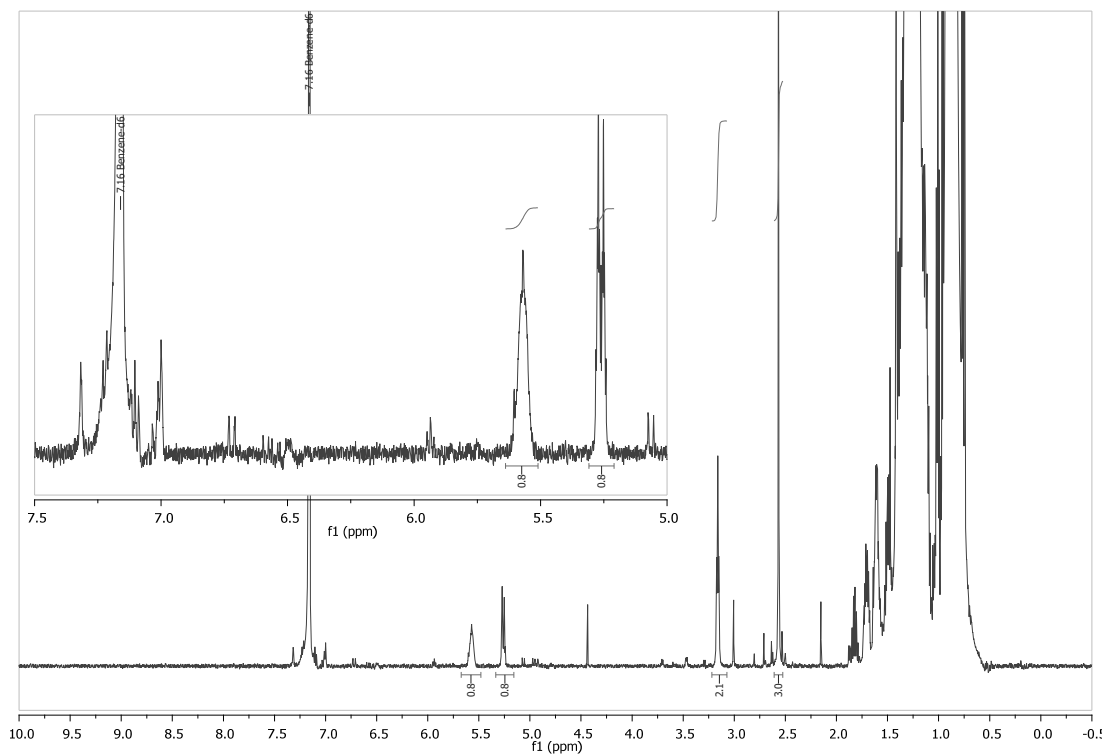
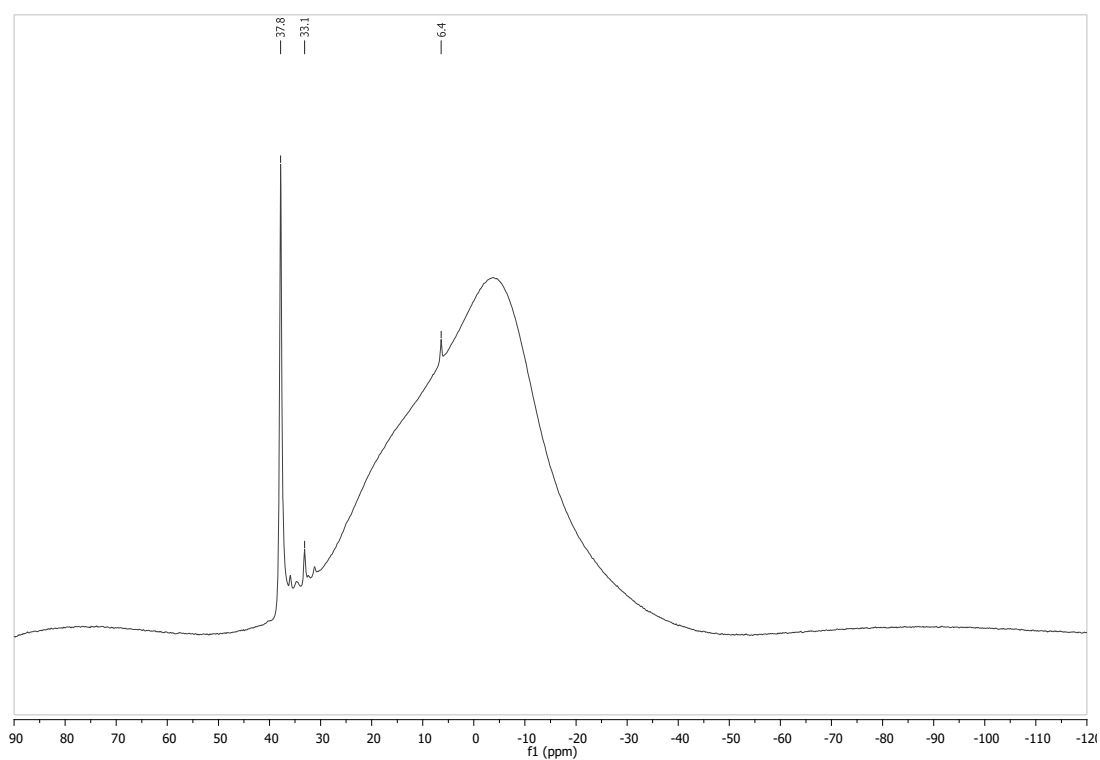


Figure SI- 15. Crude $^{11}\text{B}\{^1\text{H}\}$ NMR spectrum of **Entry 1, Table SI- 2.**

Figure SI- 16. Crude ^1H NMR spectrum of Entry 2, Table SI- 2.Figure SI- 17. Crude $^{11}\text{B}\{^1\text{H}\}$ NMR spectrum of Entry 2, Table SI- 2.

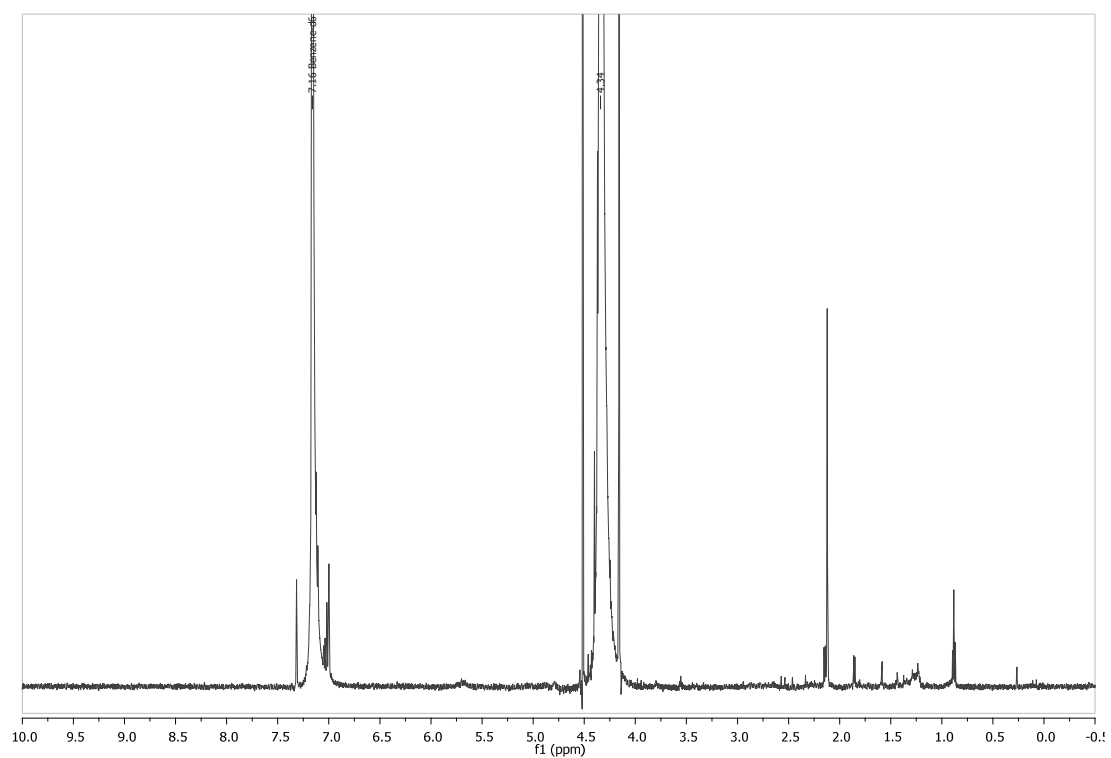


Figure SI- 18. Crude ^1H NMR spectrum of **Entry 3, Table SI- 2.**

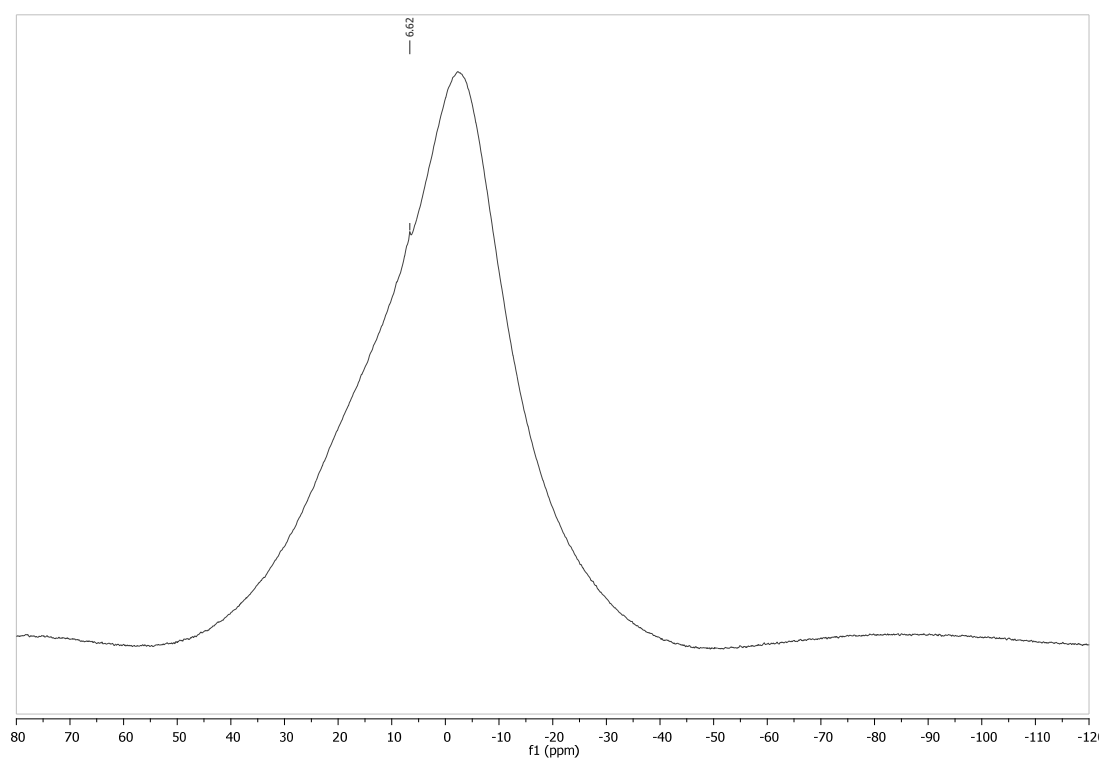


Figure SI- 19. Crude $^{11}\text{B}\{^1\text{H}\}$ NMR spectrum of **Entry 3, Table SI- 2.**

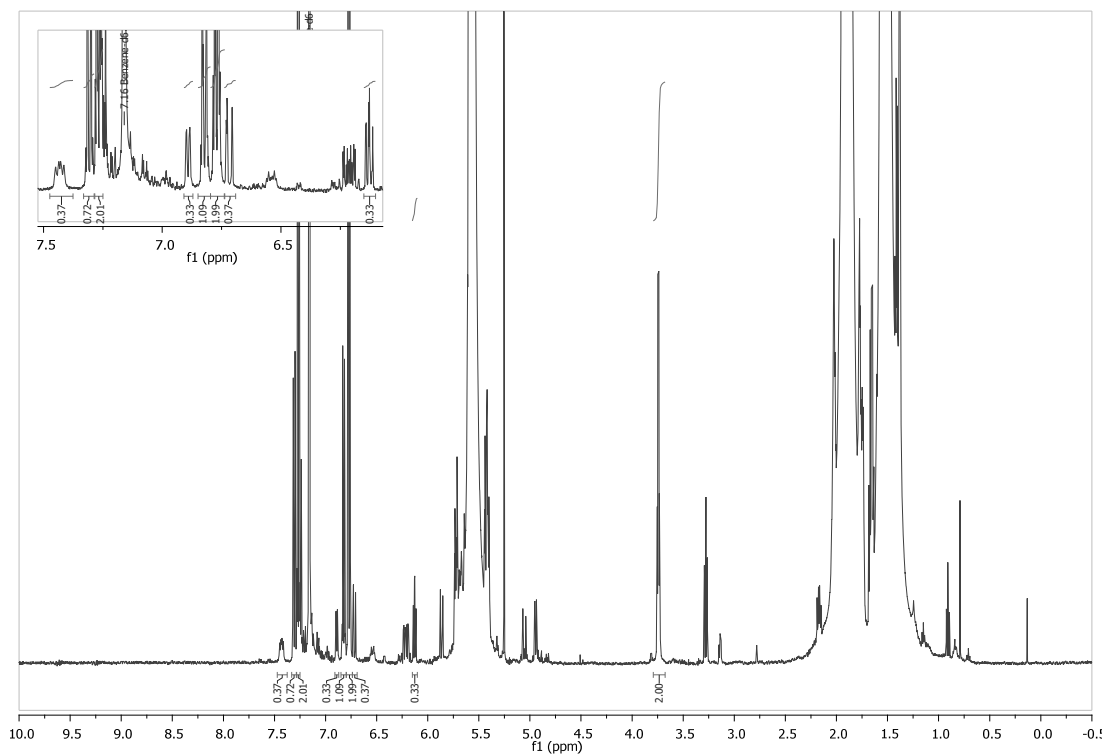


Figure SI- 20. Crude ^1H NMR spectrum of **Entry 1, Table SI- 3** after 1 h reaction time.

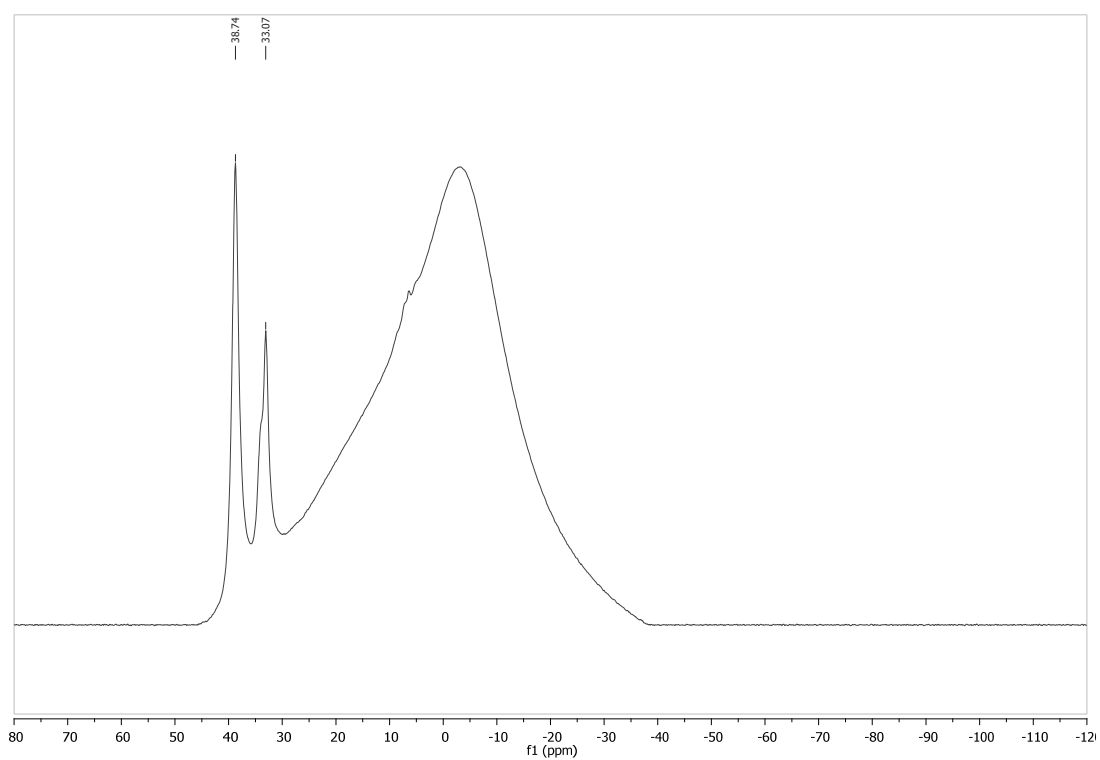


Figure SI- 21. Crude $^{11}\text{B}\{^1\text{H}\}$ NMR spectrum of **Entry 1, Table SI- 3** after 1 h reaction time.

5 Experimental Section

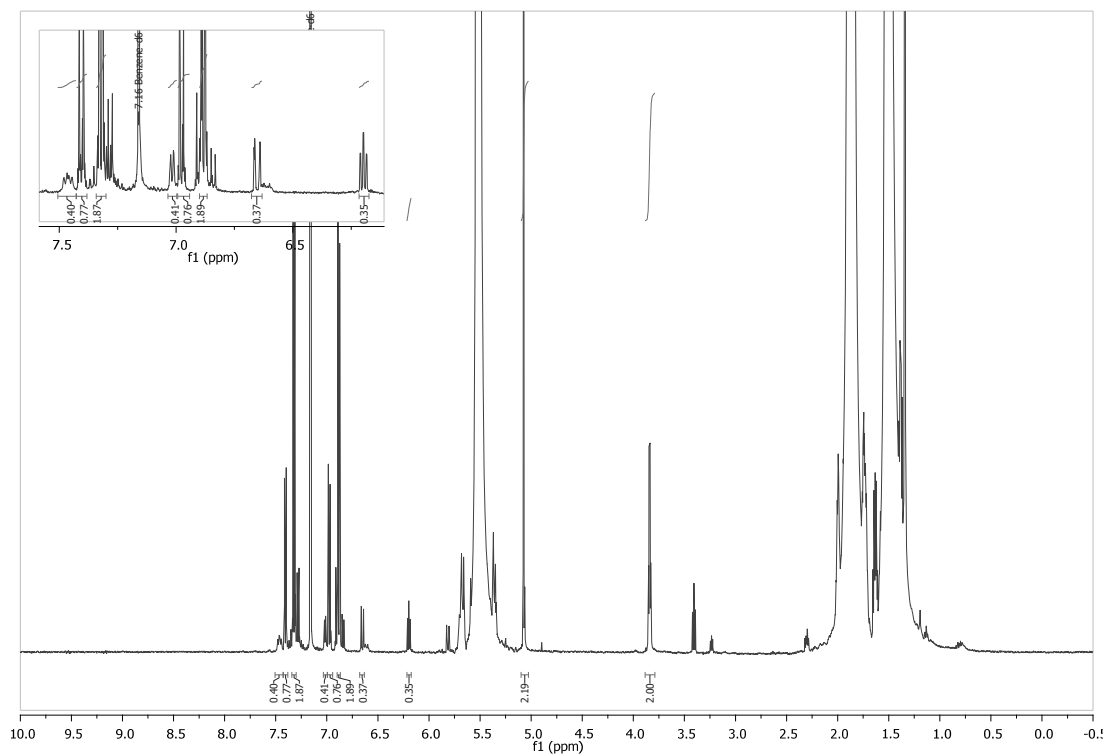


Figure SI- 22. Crude ^1H NMR spectrum of **Entry 1, Table SI- 3** after 4 h reaction time.

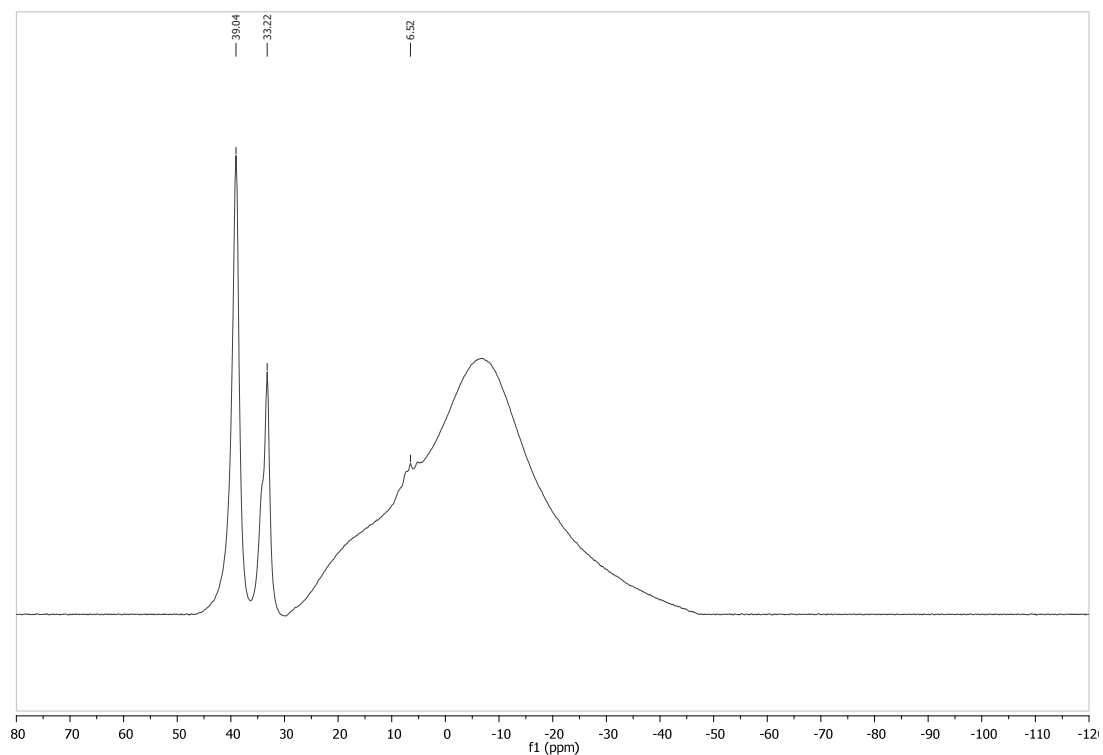
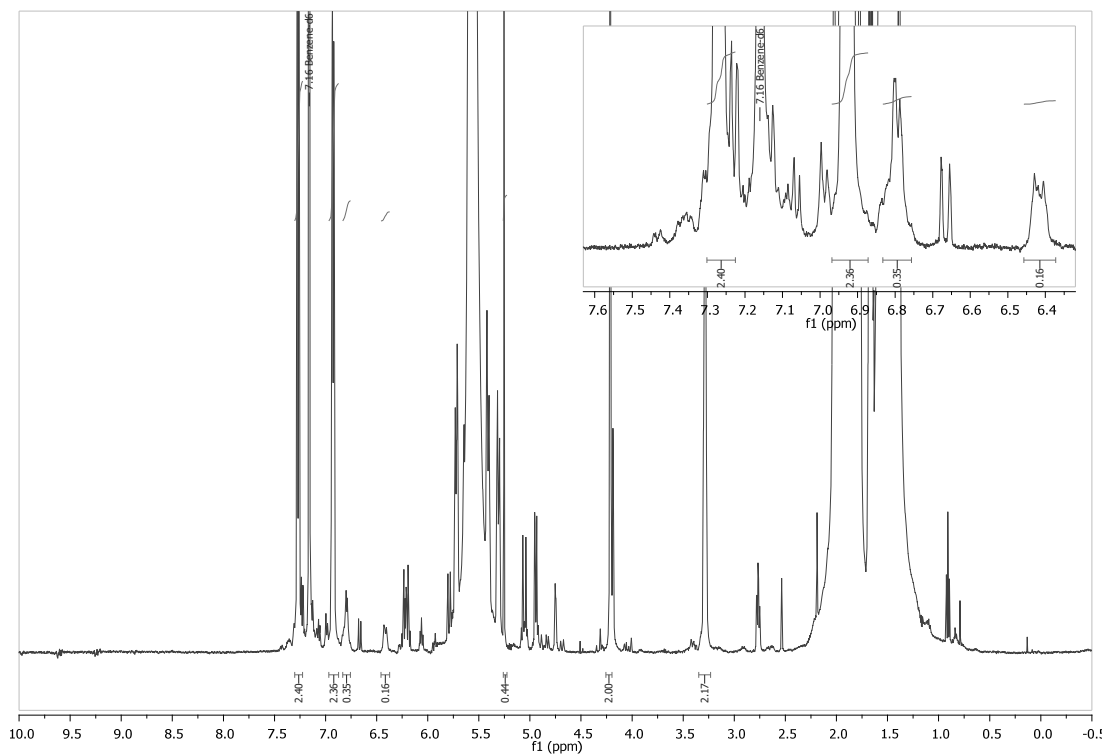
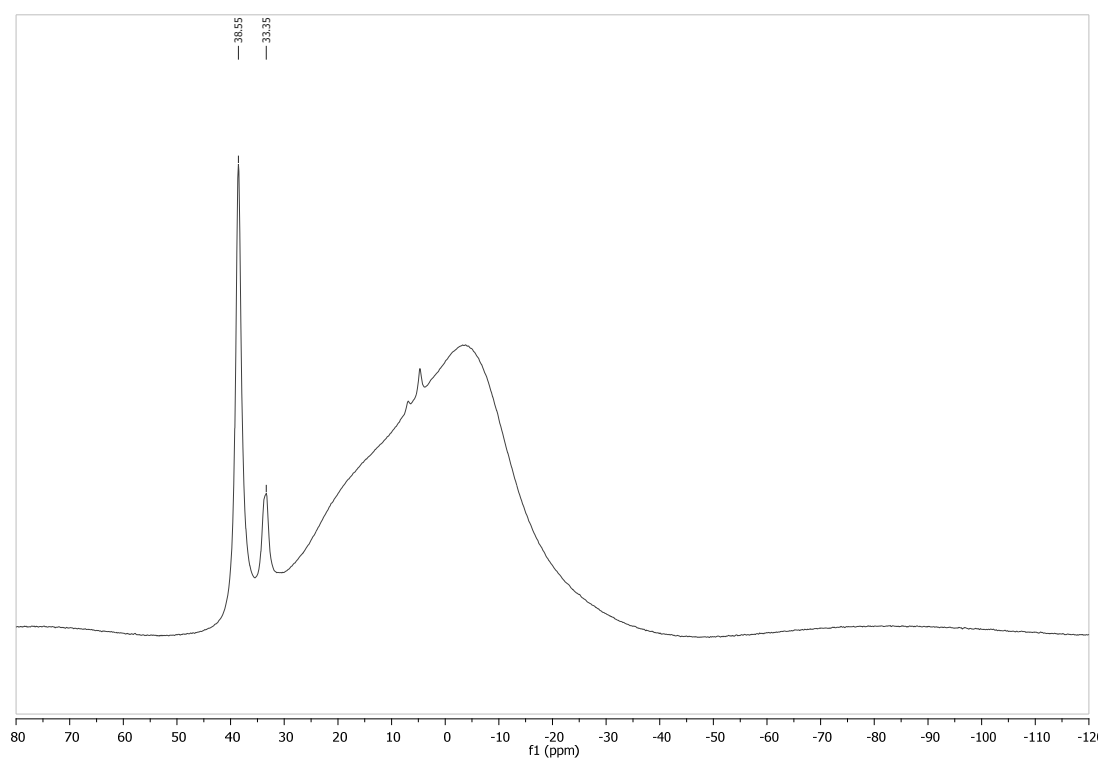


Figure SI- 23. Crude $^{11}\text{B}\{^1\text{H}\}$ NMR spectrum of **Entry 1, Table SI- 3** after 4 h reaction time.

Figure SI- 24. Crude ^1H NMR spectrum of Entry 2, Table SI- 3.Figure SI- 25. Crude $^{11}\text{B}\{^1\text{H}\}$ NMR spectrum of Entry 2, Table SI- 3.

5 Experimental Section

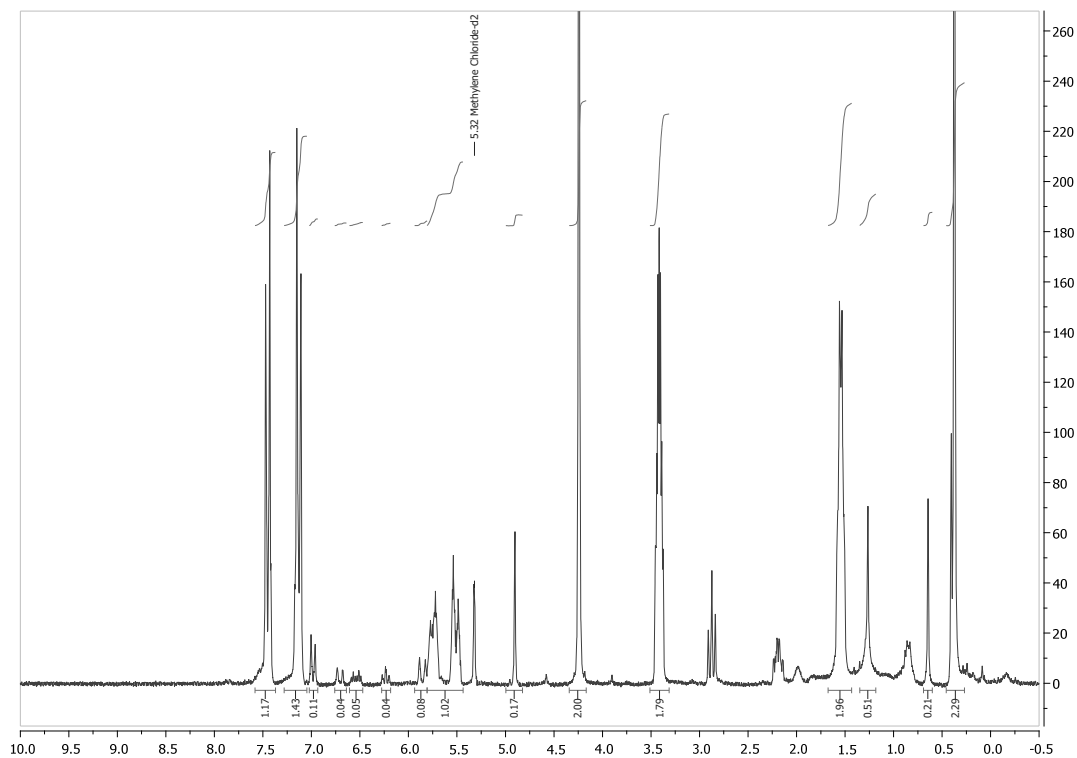


Figure SI- 26. Crude ^1H NMR spectrum of Entry 3, Table SI- 3.

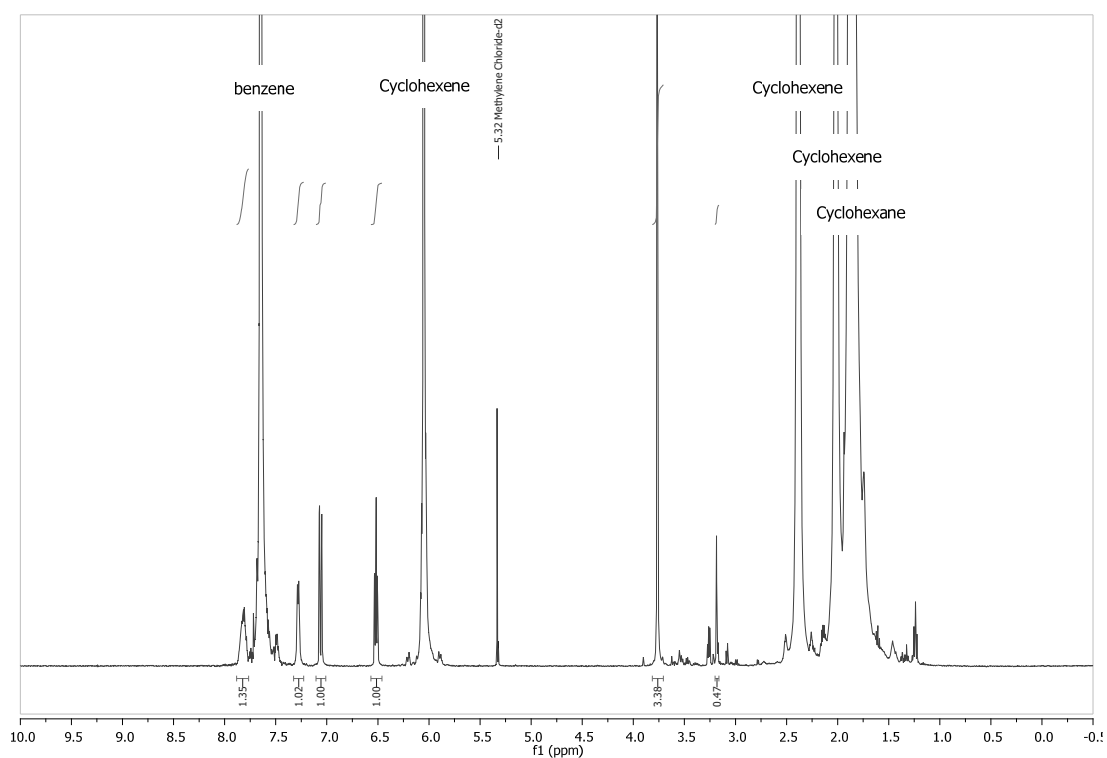
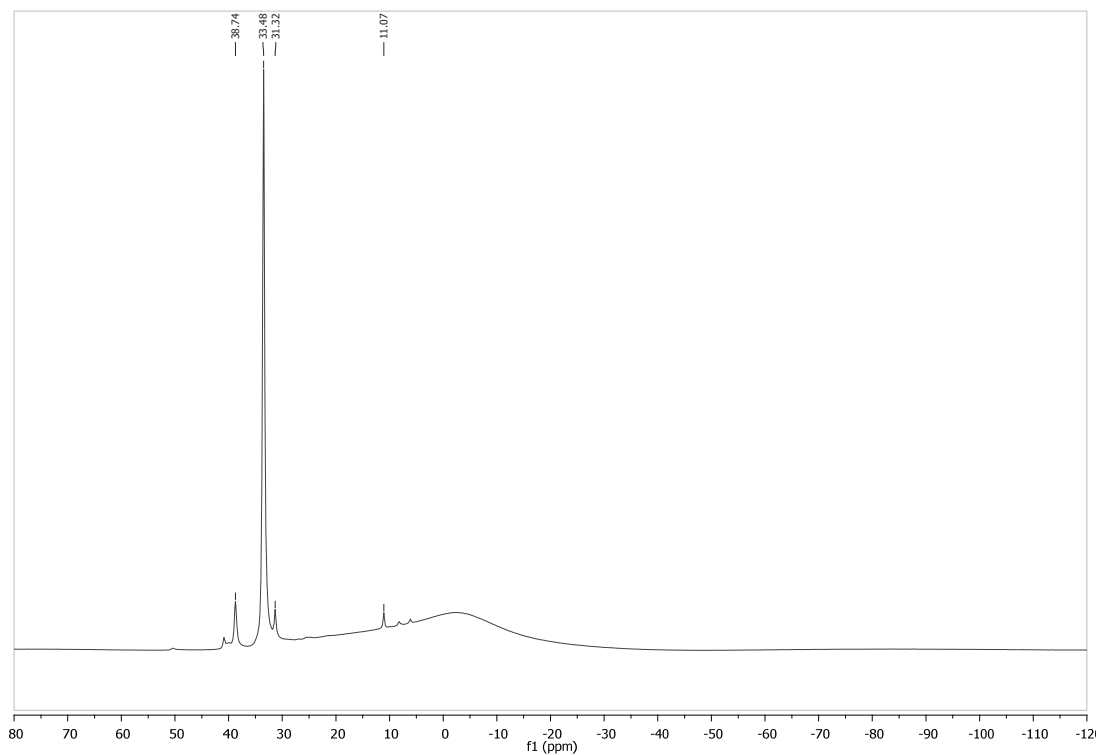
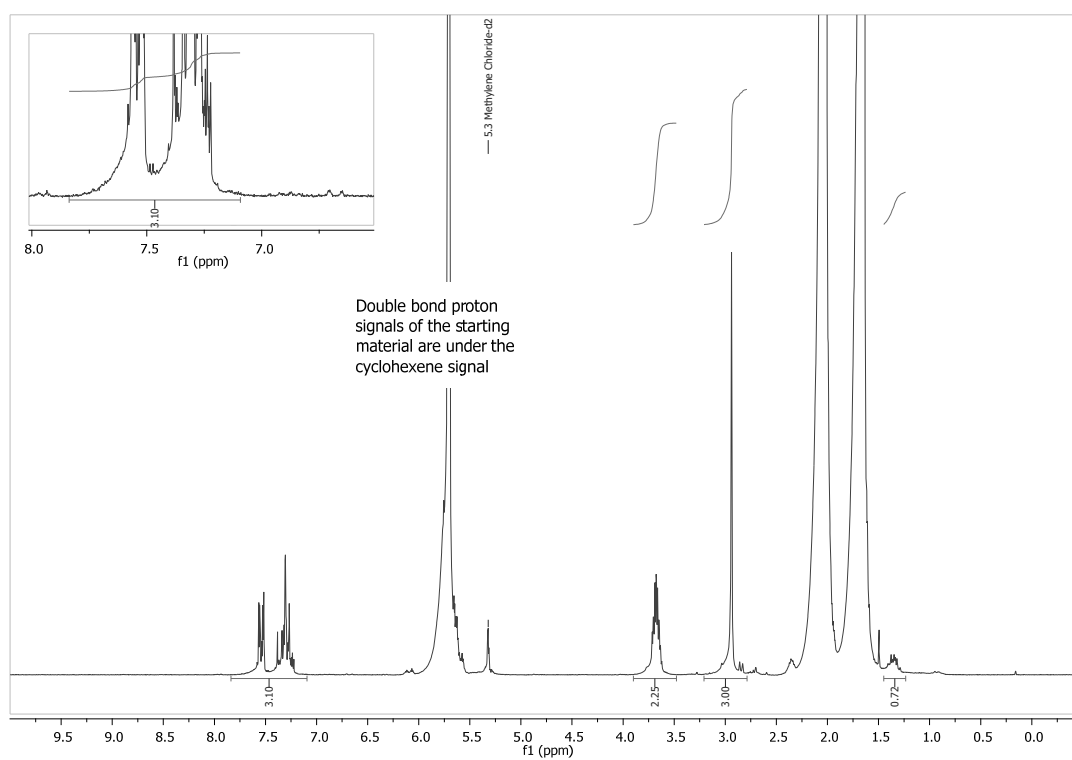


Figure SI- 27. Crude ^1H NMR spectrum of Entry 4, Table SI- 3.

Figure SI- 28. Crude $^{11}\text{B}\{^1\text{H}\}$ NMR spectrum of Entry 4, Table SI- 3.Figure SI- 29. Crude ^1H NMR spectrum of Entry 5, Table SI- 3; only 60% bromobenzene remained in solution.

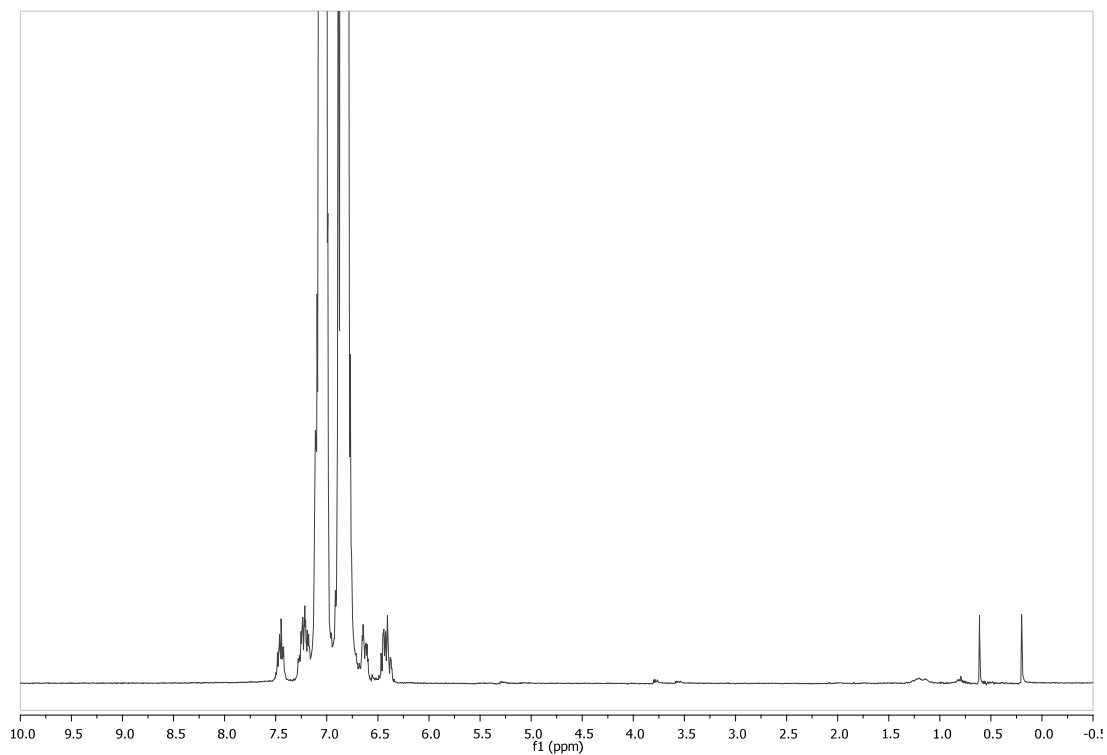


Figure SI- 30. ^1H NMR spectrum of chlorobenzene (solvent) for **Entry 6** and **7**, **Table SI- 3**; zoomed in for better comparison to following crude ^1H NMR spectra.

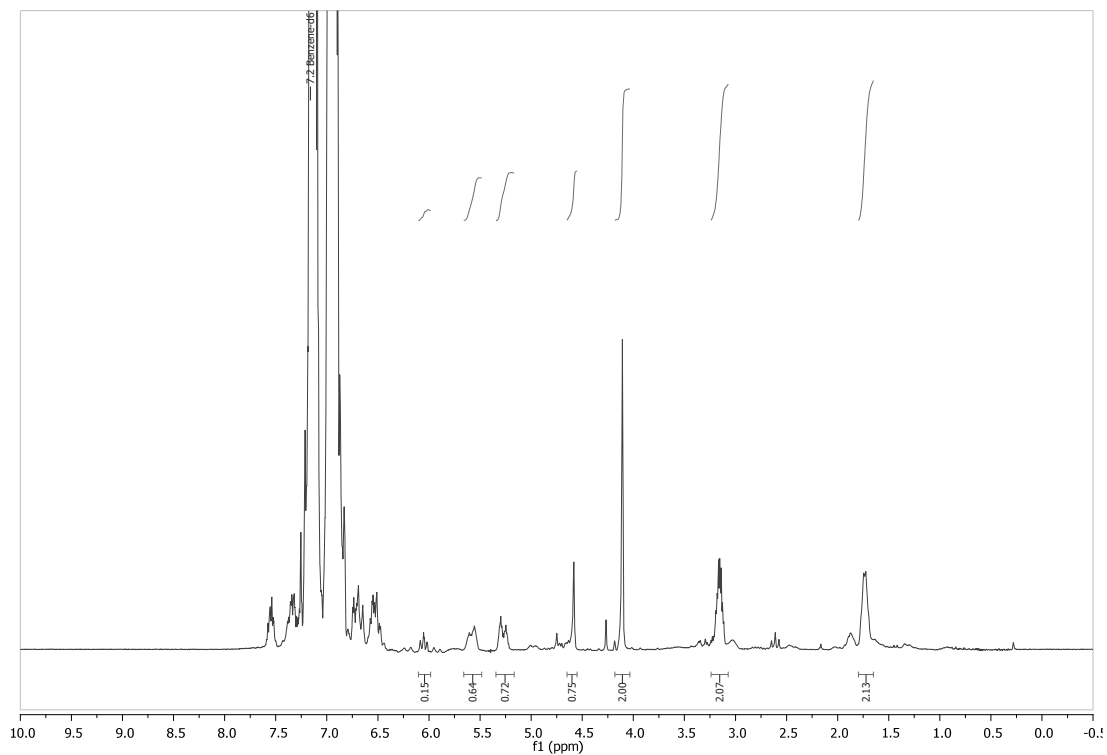


Figure SI- 31. Crude ^1H NMR spectrum of **Entry 6**, **Table SI- 3** after 4 h reaction time

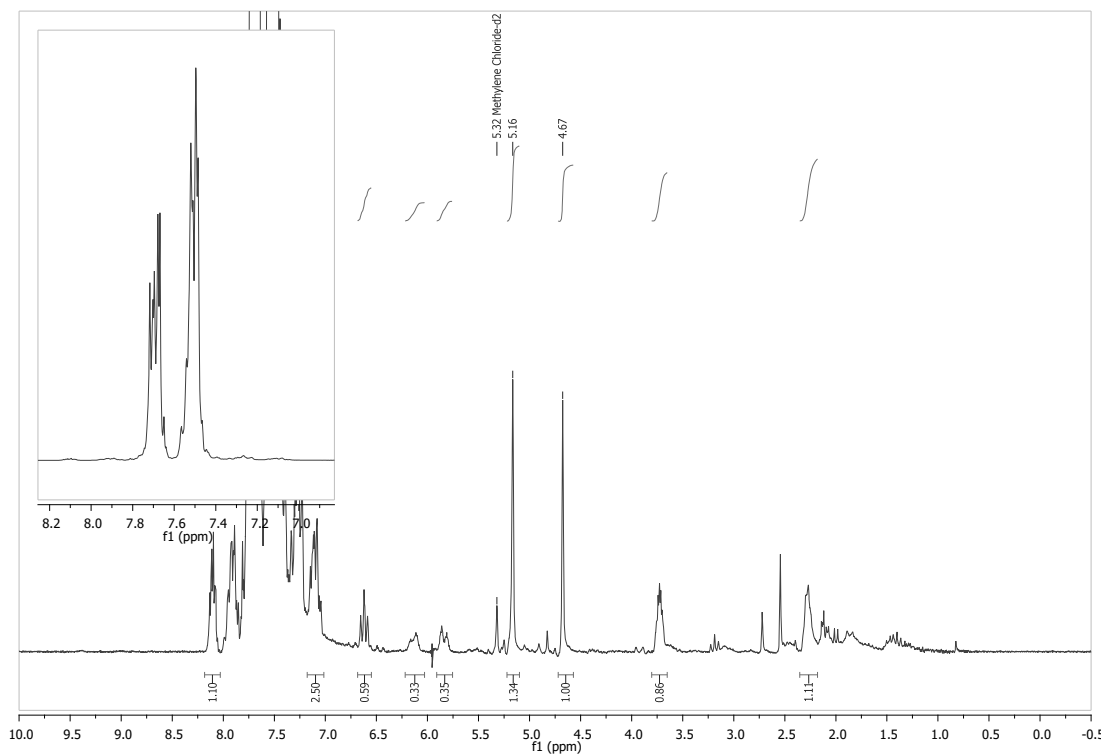


Figure SI- 32. Crude ^1H NMR spectrum of **Entry 6, Table SI- 3** after 10 h reaction time; additional zoom (x 0.1) of the chlorobenzene signals.

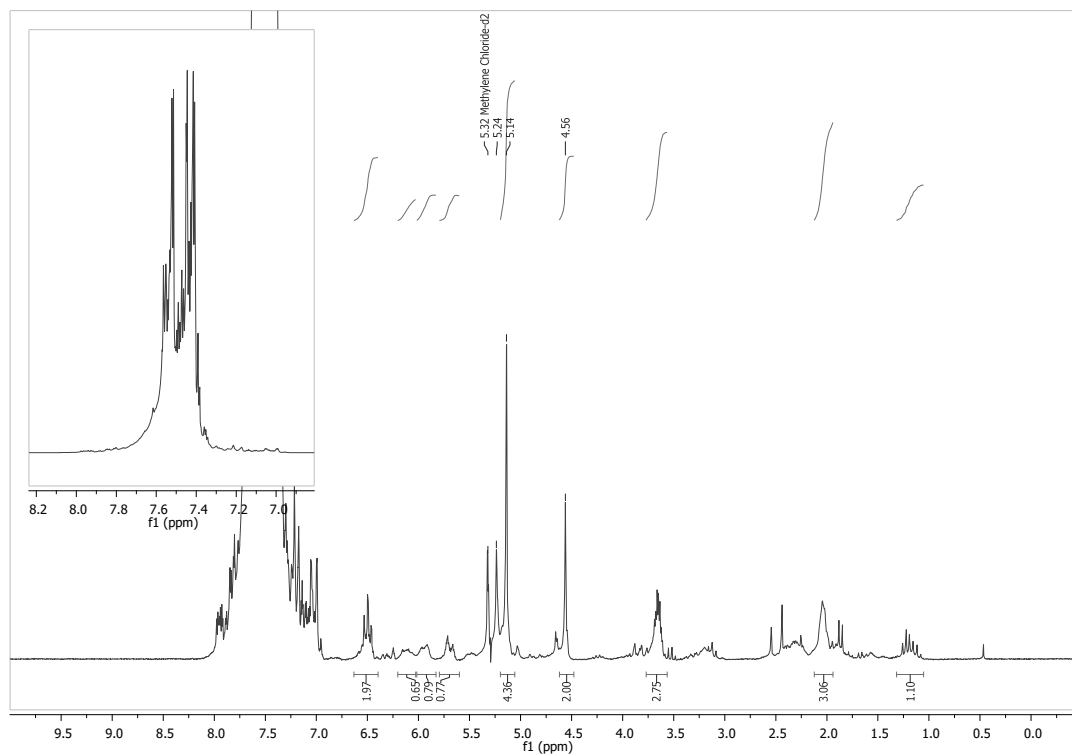
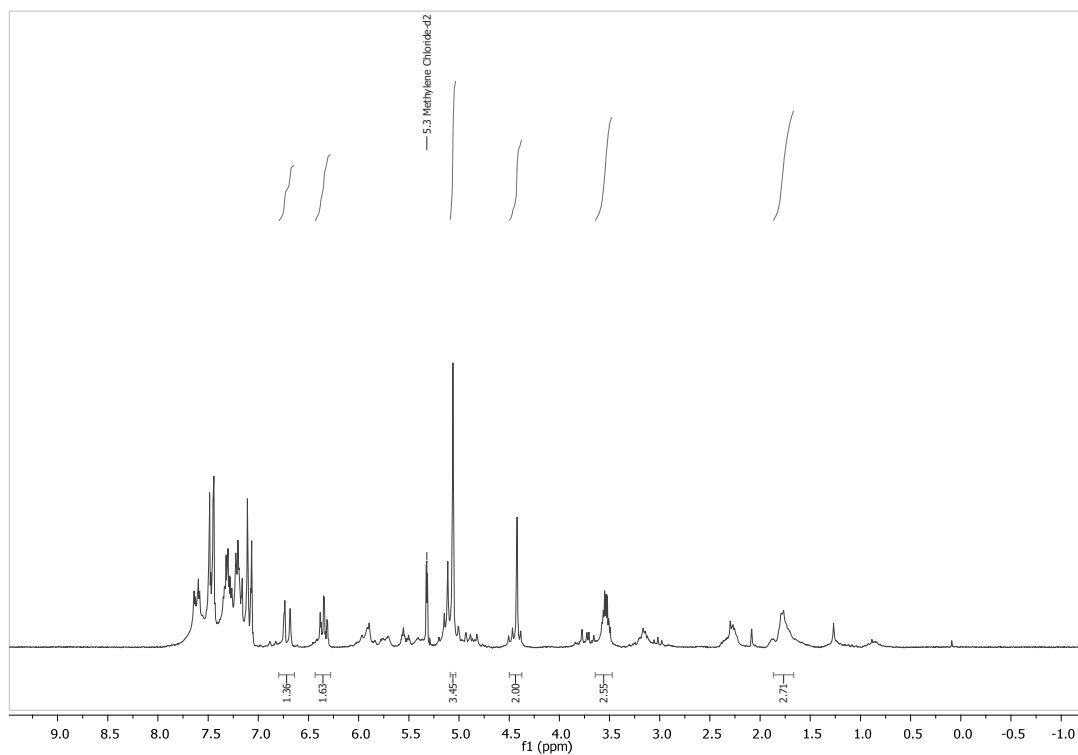
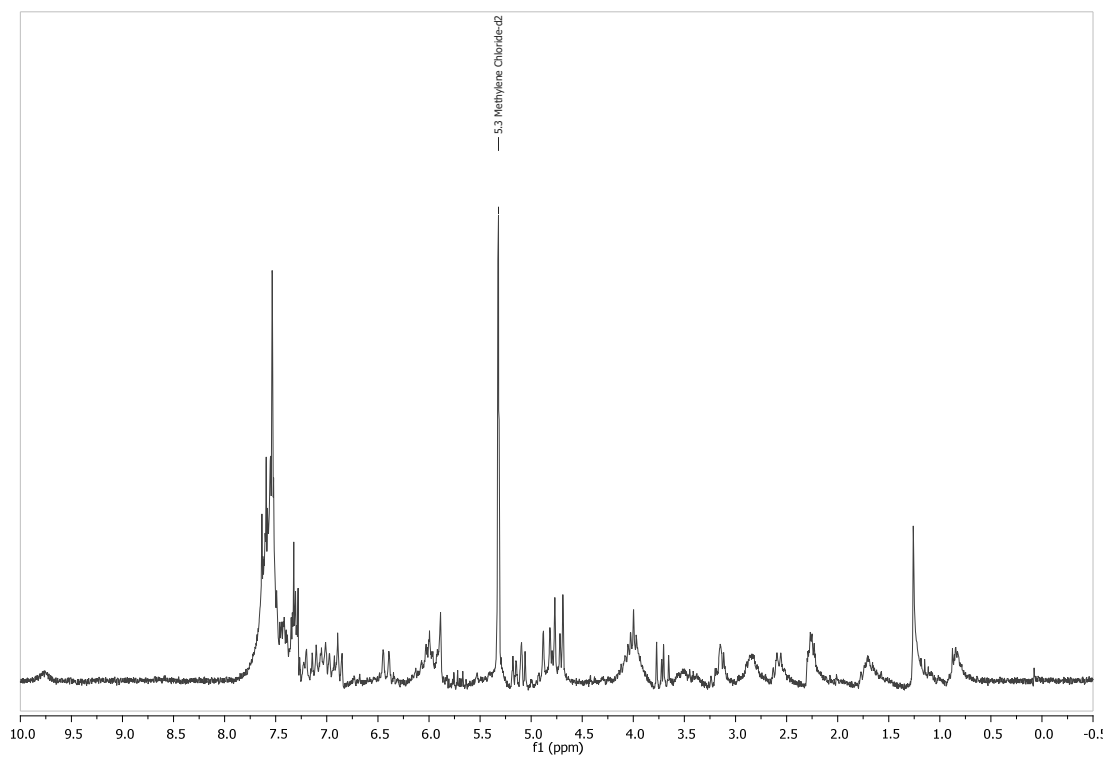


Figure SI- 33. Crude ^1H NMR spectrum of **Entry 7, Table SI- 3**; additional zoom (x 0.1) of the chlorobenzene signals.

Figure SI- 34. Crude ^1H NMR spectrum of **Entry 7, Table SI- 3** after nearly complete solvent evaporation.Figure SI- 35. Crude ^1H NMR spectrum of **Entry 7, Table SI- 3**; first fraction of the sublimation.

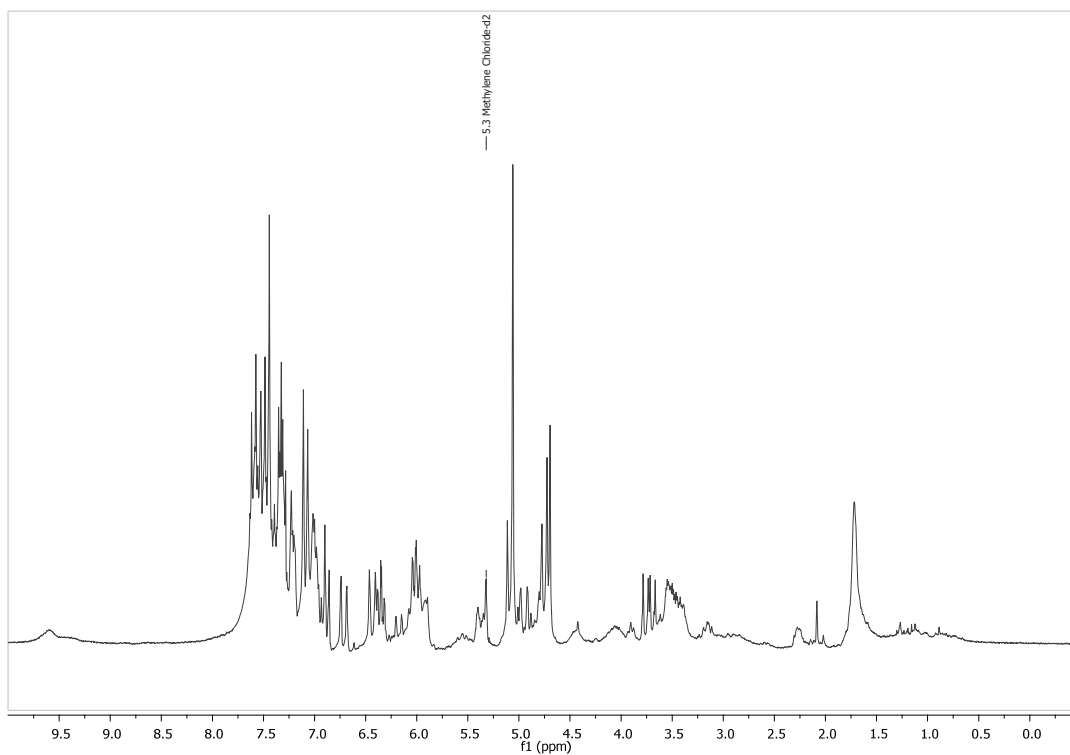


Figure SI- 36. Crude ¹H NMR of **Entry 7, Table SI- 3**; second fraction of the sublimation.

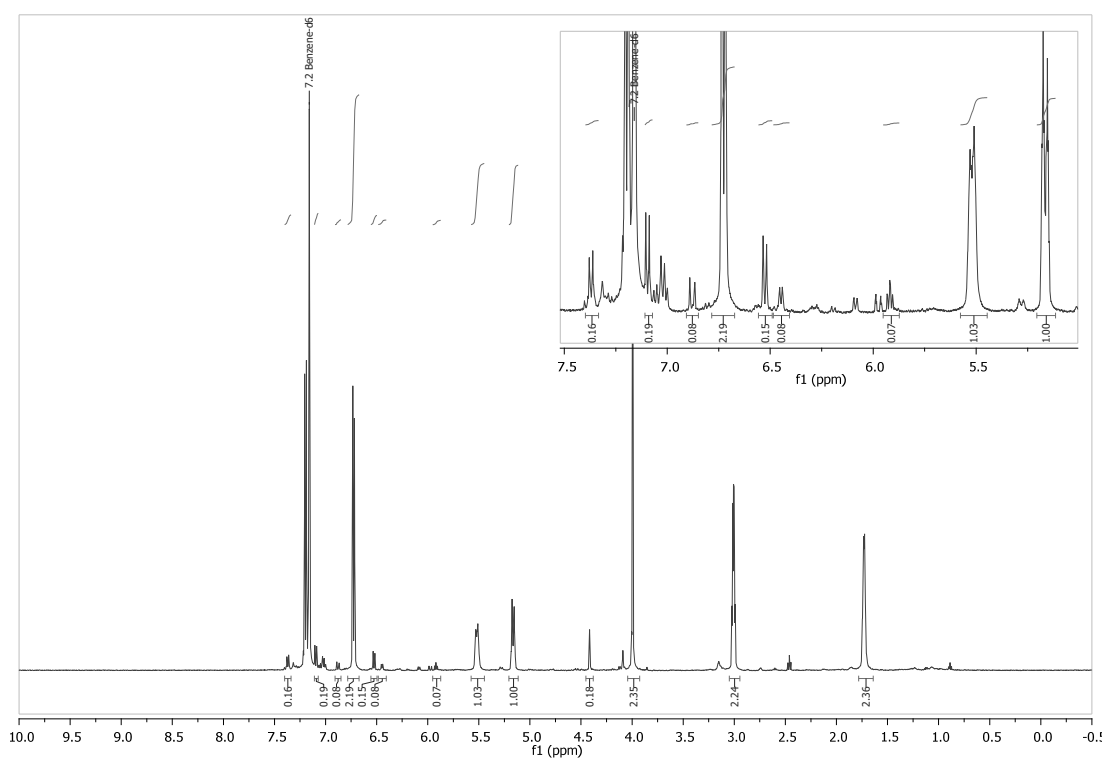


Figure SI- 37. Crude ¹H NMR spectrum of **Entry 1, Table SI- 4** after solvent evaporation; additional zoom (x 5) of the aromatic range.

5 Experimental Section

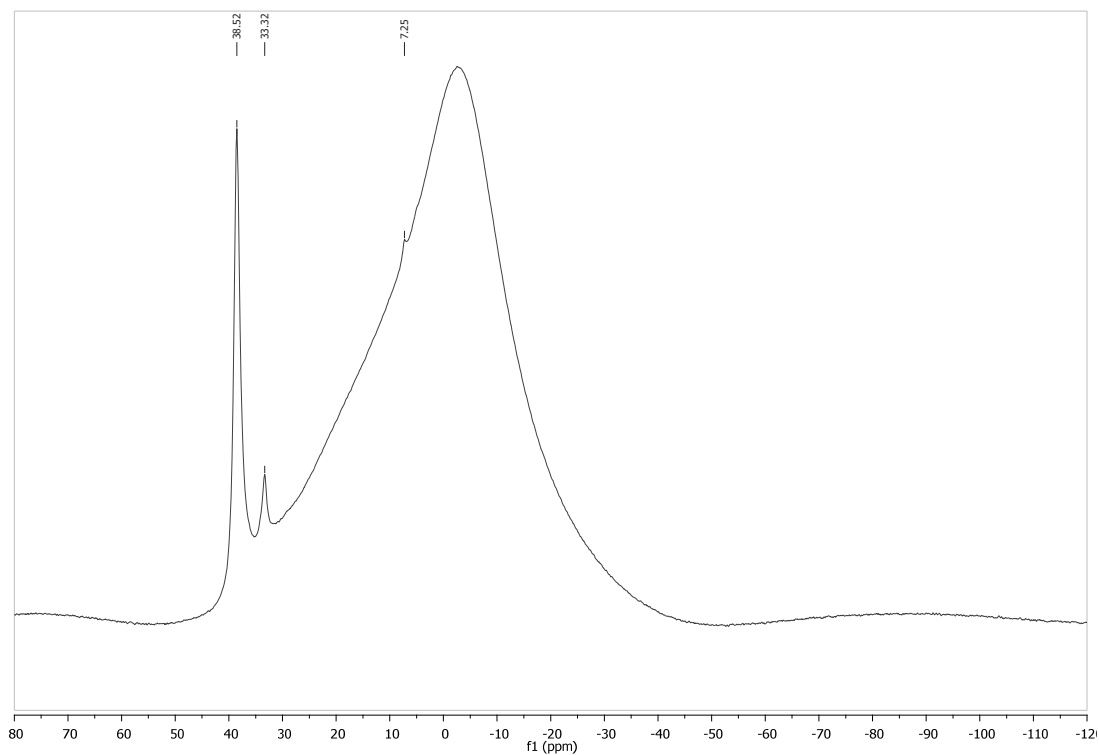


Figure SI- 38. Crude $^{11}\text{B}\{^1\text{H}\}$ NMR spectrum of **Entry 1, Table SI- 4** after solvent evaporation.

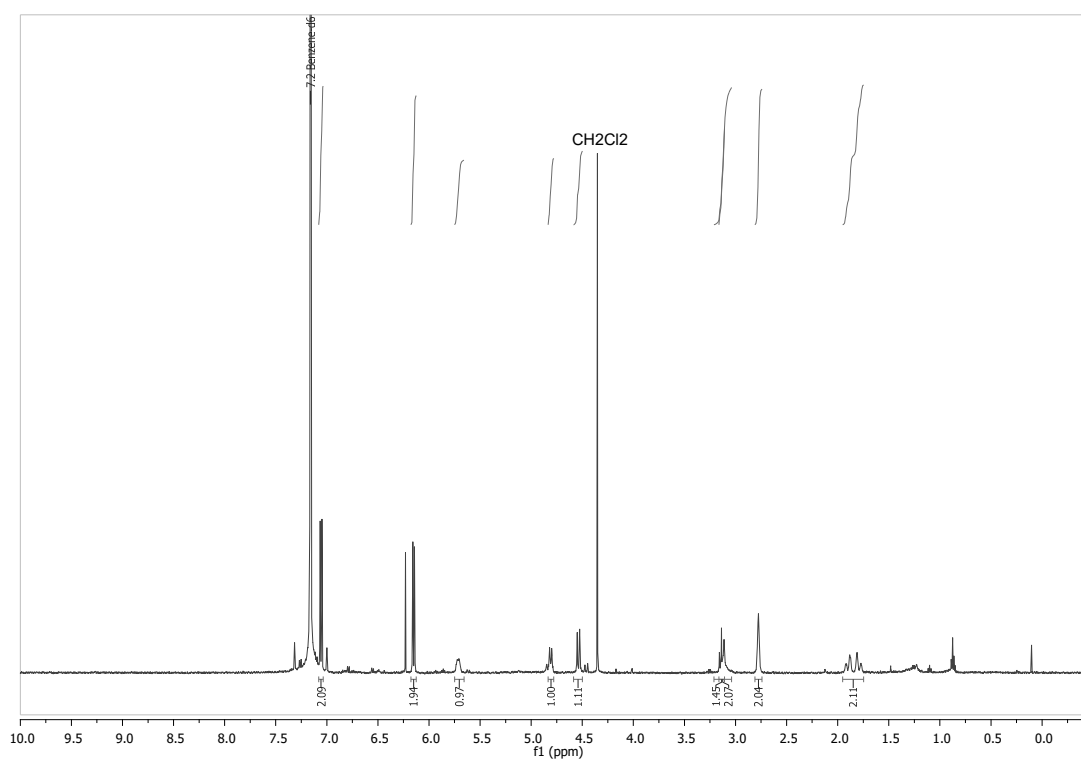


Figure SI- 39. Crude ^1H NMR spectrum of **Entry 2, Table SI- 4** after solvent evaporation.

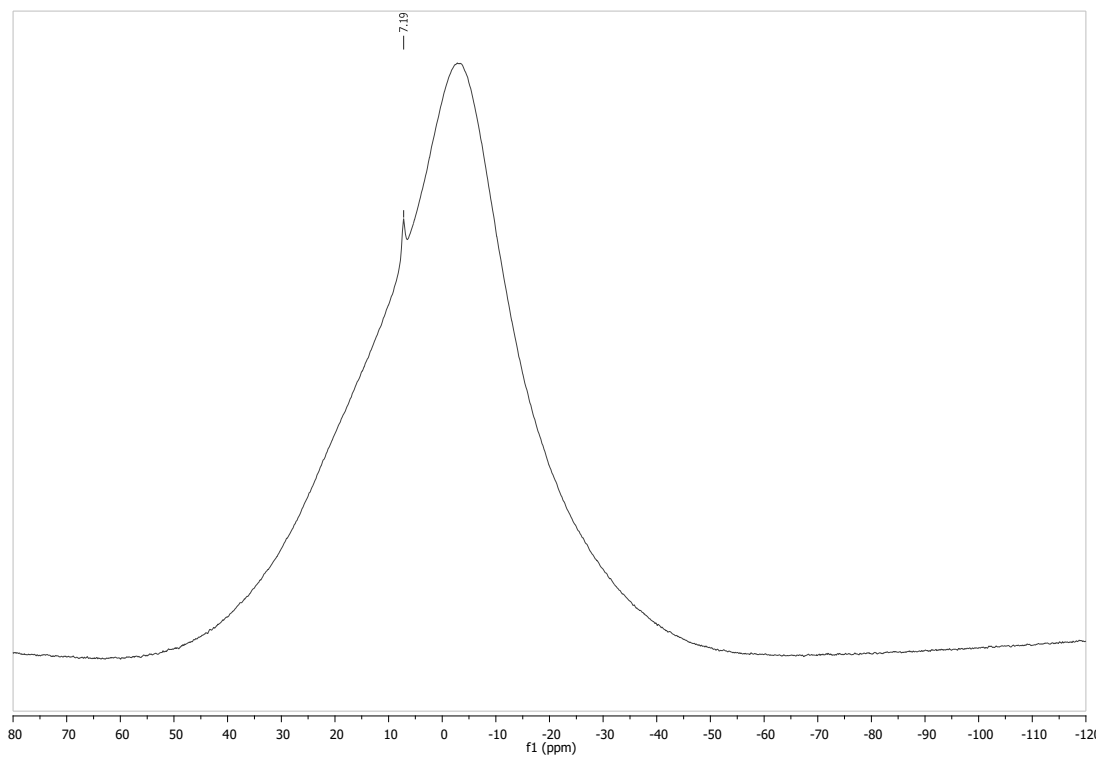


Figure SI- 40. Crude $^{11}\text{B}\{^1\text{H}\}$ NMR spectrum of **Entry 2, Table SI- 4** after solvent evaporation.

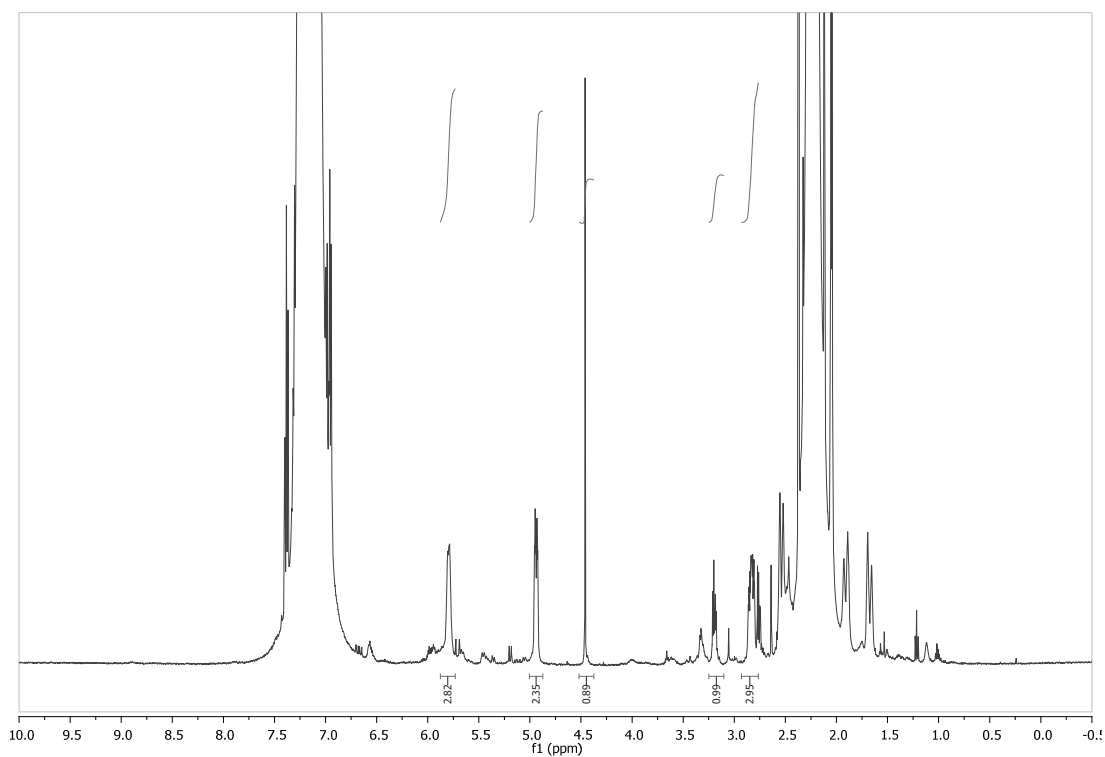


Figure SI- 41. Crude ^1H NMR spectrum of **Entry 3, Table SI- 4**.

5 Experimental Section

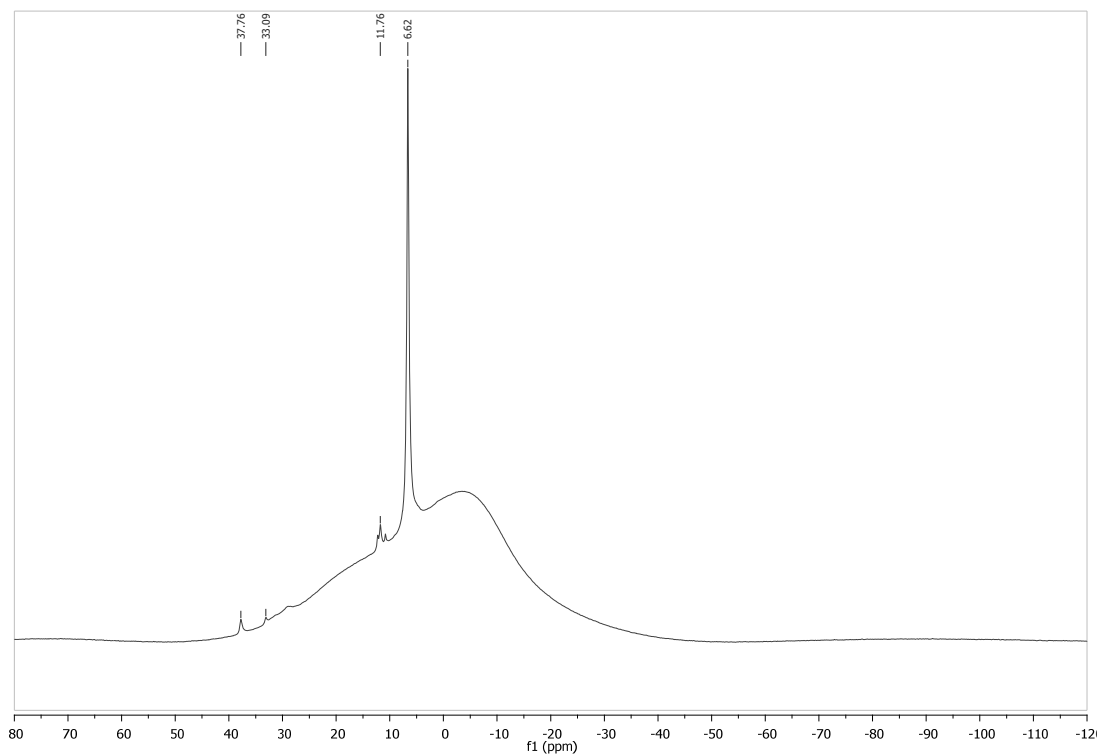


Figure SI- 42. Crude $^{11}\text{B}\{^1\text{H}\}$ NMR spectrum of **Entry 3, Table SI- 4**.

5.2.7.3 GC/MS spectra

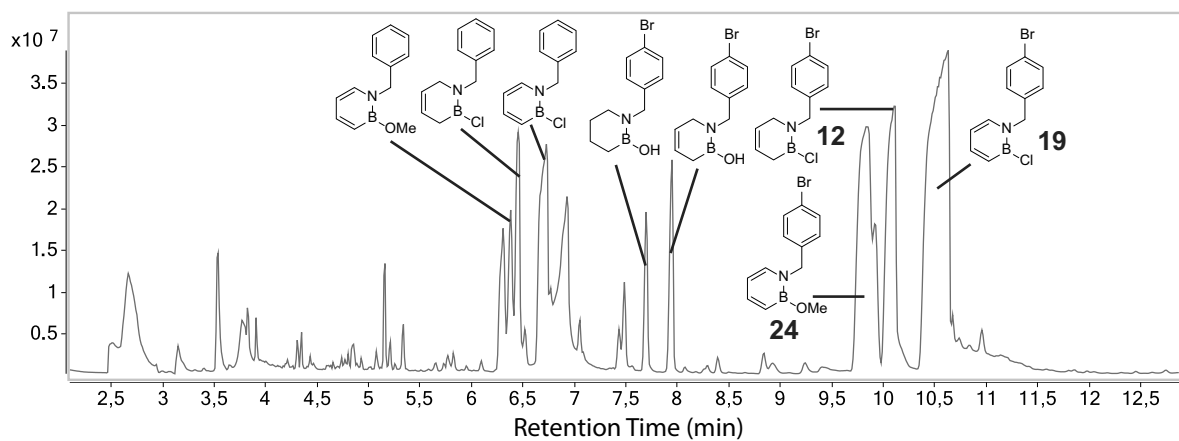


Figure SI- 43. GC trace of the crude mixture of the dehydrogenation approach towards **19** by chlorobenzene as solvent (**Entry 7, Table SI- 3**).

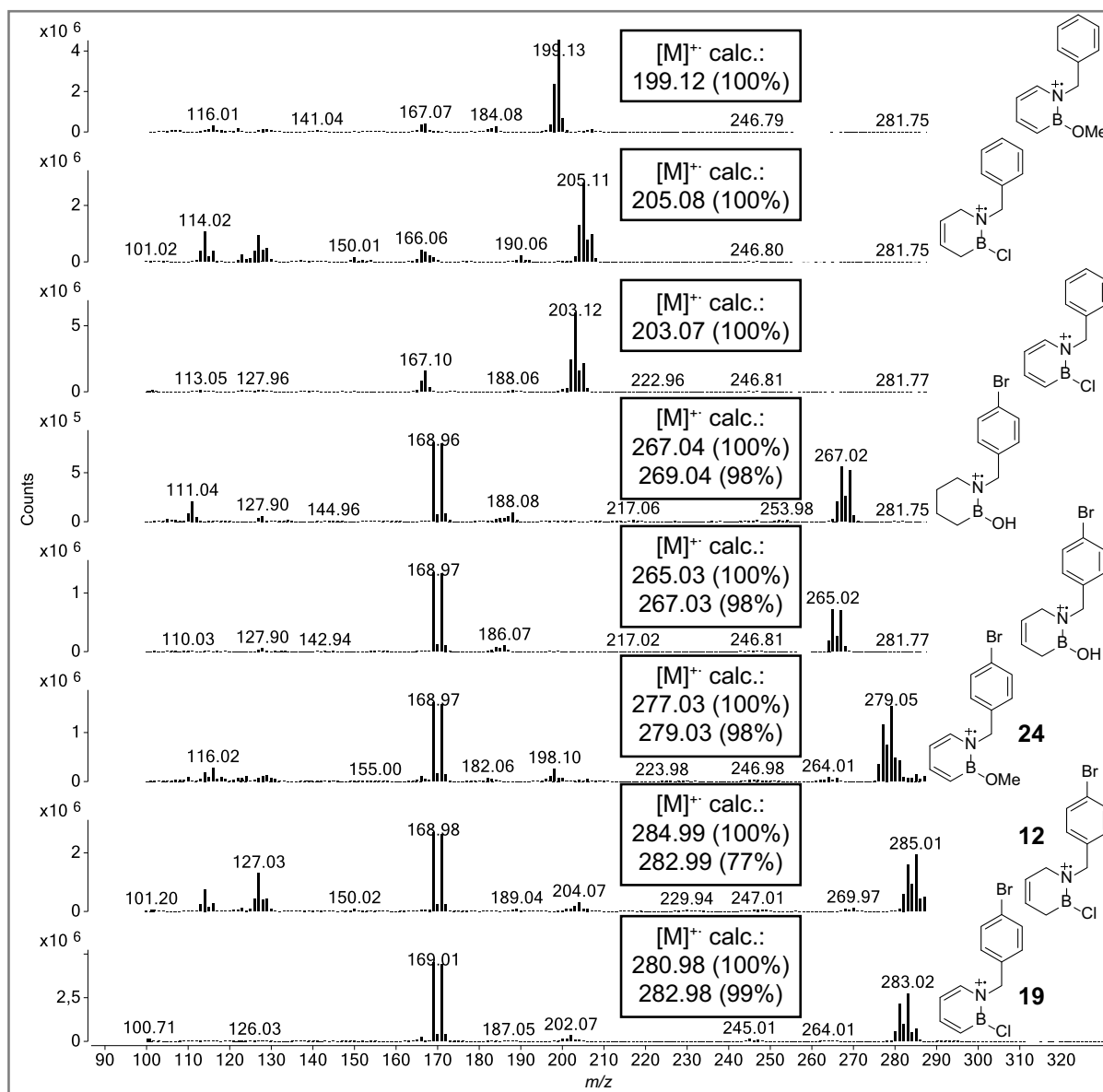


Figure SI- 44. MS spectra values to the corresponding GC trace (**Figure SI- 43**) with proposed compounds and their calculated m/z values.

5.3 Supporting Information on Chapter 3.3

5.3.1 Supporting Information for *Chem. Commun.* 2016, *submitted*.

Supporting Information

for

High Molecular Weight Poly(*N*-methyl-2-vinylazaborine) – A Semi-Inorganic B-N Polystyrene Analog

Birk Thiedemann,^{†‡} Paul G. Lawrence,^Ω Frank D. Sönnichsen,^{‡*} Anne Staubitz^{†‡*}.

[†] *Institute for Organic and Analytical Chemistry, University of Bremen, Leobener Straße NW2c 28359 Bremen, Germany.*

[‡] *Otto Diels Institute for Organic Chemistry, University of Kiel, Otto-Hahn-Platz 4, 24098 Kiel, Germany.*

^Ω *School of Chemistry, University of Bristol, Cantock's Close, Bristol BS8 1TS, UK.*

[‡] *MAPEX Center for Materials and Processes, University of Bremen, Bibliothekstraße 1, 28359 Bremen, Germany.*

*fsönnichsen@oc.uni-kiel.de; *staubitz@uni-bremen.de

**Chemical Communications**

COMMUNICATION

Supporting Information

for

**High Molecular Weight Poly(*N*-methyl-2-vinylazaborine) –
A Semi-Inorganic B-N Polystyrene Analogue**

Birk Thiedemann,^{a,b,c} Philipp J. Gliese,^{a,b,c} Jonas Hoffmann,^c Paul G. Lawrence,^d Frank D. Sönnichsen*^c
and Anne Staubitz*^{a,b,c}

a Institute for Organic and Analytical Chemistry, University of Bremen, Leobener Straße NW2c 28359 Bremen, Germany.

b MAPEX Center for Materials and Processes, University of Bremen, Bibliothekstraße 1, 28359 Bremen, Germany.

c Otto Diels Institute for Organic Chemistry, University of Kiel, Otto-Hahn-Platz 4, 24098 Kiel, Germany.

d School of Chemistry, University of Bristol, Cantock's Close, Bristol BS8 1TS, UK.

*fsoennichsen@oc.uni-kiel.de; *staubitz@uni-bremen.de

Table of Contents

General Methods and Materials	3
Analyses	3
Chemicals.....	3
Solvents.....	4
Syntheses.....	5
Monomer Synthesis and Characterization	5
Triallylborane ¹	5
1,2-Diallyl-2-chloro-1-methylaminoborane ⁴	8
2-Chloro-1-methyl-3,6-dihydro-1,2-azaborine ⁴	11
2-Chloro-1-methyl-1,2-azaborine (1) ⁴	13
1-Methyl-2-vinyl-1,2-azaborine (2)	15
Polymerizations and Characterizations.....	18
Poly(1-methyl-2-vinylazaborine) (3).....	18
Poly(1-methyl-2-vinylazaborine-2'-methylstyrene) (6)	26
Poly(2-methylstyrene) (4)	32
Additional Comparisons.....	37
¹ H NMR comparison.....	37
¹³ C{ ¹ H} NMR comparison.....	38
IR comparison	39
UV-vis comparison	39
Kinetic measurements (monomer conversion control by ¹ H NMR).....	41
Discussion of a Possible Involvement of the <i>N</i> -Methyl Group in the Polymerization	43
Abbreviations	44
Literature.....	45

General Methods and Materials

All syntheses were carried out using standard Schlenk techniques or in a glovebox (INERT PURE LAB) under a dry and inert nitrogen atmosphere. Glassware and NMR-tubes were dried in an oven at 200 °C for at least 2 h prior to use. Reaction vessels were heated under vacuum and purged with nitrogen three times before adding reagents.

Analyses

^1H NMR, $^{13}\text{C}\{^1\text{H}\}$ NMR and ^{11}B NMR spectra were recorded at 300 K.

^1H NMR spectra were recorded on a Bruker DRX 500 (500 MHz) spectrometer or a Bruker AV 600 (600 MHz) spectrometer. Reaction monitoring was carried out on a Bruker DPX200 (200 MHz). $^{13}\text{C}\{^1\text{H}\}$ NMR spectra were recorded on a Bruker DRX 500 (500 MHz) spectrometer or a Bruker AV 600 (126 MHz) spectrometer. ^{11}B NMR spectra were recorded on a Bruker DRX 500 (160.46 MHz) spectrometer with 2048 scans, and a spectral width of 40000 Hz (250 ppm), a relaxation delay of 0.15 s, and an acquisitions delay of 0.1 s. The signals were referenced externally to $\text{BF}_3\cdot\text{OEt}_2$.

The exact assignment of the peaks was proved by ^1H , $^{13}\text{C}\{^1\text{H}\}$ DEPT and two-dimensional NMR spectroscopy such as ^1H COSY, ^{13}C HSQC(-DEPT) or $^1\text{H}/^{13}\text{C}$ HMBC when possible.

IR spectra were recorded on a Perkin Elmer Paragon 1000 FT-IR spectrometer with an A531-G Golden-Gate-ATR-unit.

The high resolution EI mass spectra were measured on a VG Analytical Autospec apparatus.

Thermogravimetric analyses (TGA) were conducted on a Mettler Toledo TGA/DSC 3+ Star^c System.

Differential scanning calorimetry (DSC) measurements were conducted on a Mettler Toledo DSC 3+ Star^c System.

For Gel permeation chromatography (GPC) measurements, a PSS GPC/SEC System equipped with three separation columns (1.000 Å, 100.000 Å and 1.000.000 Å), a RI detector, viscometer (DVD1260) and diode array detector (DAD1260).

All microwave irradiation reactions were carried out on a Biotage Initiator 60EXP.

Chemicals

All reagents were degassed via the freeze-pump-thaw technique (>3 cycles), dried and stored under a N_2 atmosphere, if not mentioned otherwise.

Compound	Purity	Comment
2,2'-Azobis(2-methylpropionitrile)	98%	Sigma Aldrich; dried under vacuum and flushed with N_2 (3 times before transferring)

		into the glovebox)
2-Vinyltoluene (or 2-Methylstyrene)	>95%	Sigma Aldrich; 3x FPT
BCl ₃ , Boron trichloride	1.0 M in hexanes	Acros Organics; not degassed
Cyclohexene	99%	inhibitor-free; dried over molecular sieves (3 Å)
Grubbs Catalyst 1 st Generation	97%	Sigma Aldrich; degassed under vacuum for 16 h
Magnesium turnings	Technical, special for Grignard reactions	Fisher Scientific/Acros
<i>n</i> -BuLi, <i>n</i> -buthyllithium	2.5 M in hexanes	Acros Organics, not degassed
<i>N</i> -Methylallylamine	96%	Alfa Aesar; dried over molecular sieves (3 Å)
Pd black, Palladium black	99.9%	ABCR; degassed under vacuum for 16 h
Tetravinylstannane	95%	Acros Organics; dried over molecular sieve (3 Å)
Triethyl amine, Et ₃ N	99%	Grüssing; dried over molecular sieve (3 Å)

Solvents

All solvents were used after purification as described below (Table SI- 1). Dried solvents were regularly tested for water content by Karl Fischer titration. In all syntheses and work-up procedures exclusively dried and degassed solvents were used. SPS = Solvent purification system (PureSolv from INERT TECHNOLOGY).

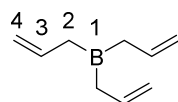
Table SI- 1. Purification of solvents.

Solvent	Drying procedure	Water content
CH ₂ Cl ₂	Directly used from the SPS (columns: 2x aluminium oxide)	< 5 ppm
Et ₂ O	Predried over KOH; dried and distilled over sodium and stored over molecular sieves (3 Å)	< 5 ppm
<i>n</i> -Pentane	Obtained from the SPS (columns: 1x aluminium oxide, 1x copper(I) oxide and degassed 3 times by the freeze-pump-thaw technique)	< 5 ppm
Toluene	Directly used from the SPS (columns: 1x molecular sieve, 1x aluminium oxide)	< 5 ppm

Syntheses

Monomer Synthesis and Characterization

Triallylborane¹



According to Brown and Racherla:¹

A dried two neck flask equipped with a reflux condenser (connected to Schlenk line) and a septum with connection to a syringe pump was placed under a nitrogen atmosphere. This apparatus was filled with dry magnesium turnings (9.73 g, 400 mmol), anhydrous and degassed diethyl ether (300 mL) and BF₃ etherate (12.4 mL, 100 mmol). Dried and degassed allyl bromide (26 mL, 300 mmol) was added via a syringe pump over the course of 3 h. After addition, the mixture was stirred for a further 12 h. Then insoluble magnesium salts were allowed to settle by switching off the stirrer. The clear ether layer was transferred via a PTFE tube into a dried two-neck Schlenk flask, which was connected to a distillation apparatus. The magnesium salts were washed with anhydrous and degassed diethyl ether (2 x 80 mL). The diethyl ether layers were combined. Solvent and potentially remaining starting material were stepwise removed (50-60 °C; atm pressure N₂ until 200 mbar). Finally, a short-path distillation (70 °C; 15 mbar) resulted in triallylborane (8.64 g, 64.5 mmol, 64%).^{a,b} ¹H NMR (500 MHz, C₆D₆) δ 5.81 (3 H, dt, *J* = 21.2, 10.5, 10.5 Hz, 3-H), 4.94 (6 H, m, 4-H), 2.03 (6 H, m, 2-H); ¹³C{¹H} NMR (126 MHz, C₆D₆) δ 135.2 (C-3) 114.9 (C-4), 34.8 (C-2); ¹¹B NMR (161 MHz, C₆D₆) δ 81.1.

^a With our available equipment, IR spectroscopy cannot be performed for air sensitive compounds.

^b High resolution mass spectrometry showed both no mass signal and no identifiable fragment signal.

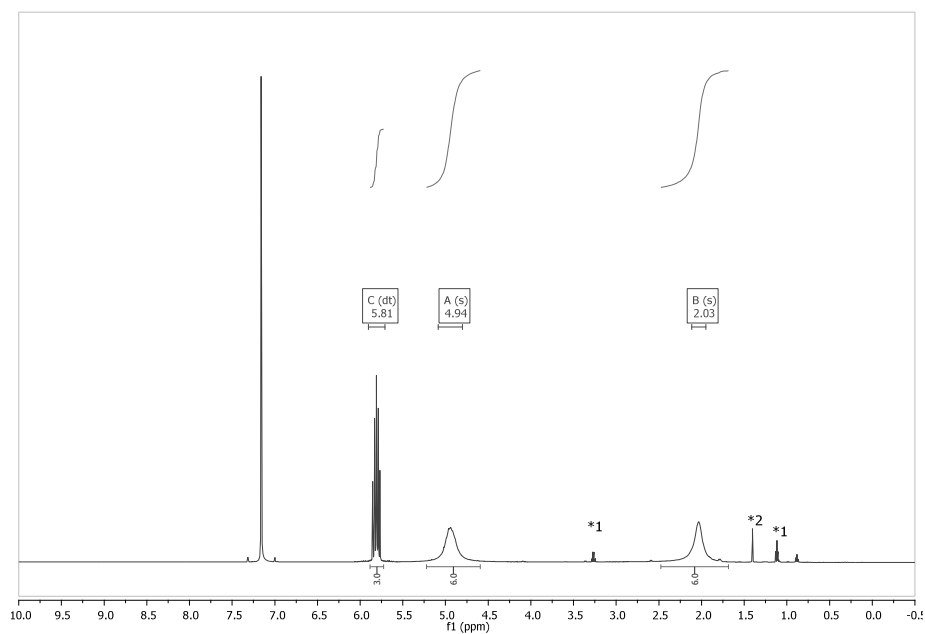


Figure SI- 1. ^1H NMR spectrum of triallylborane in C_6D_6 .^c

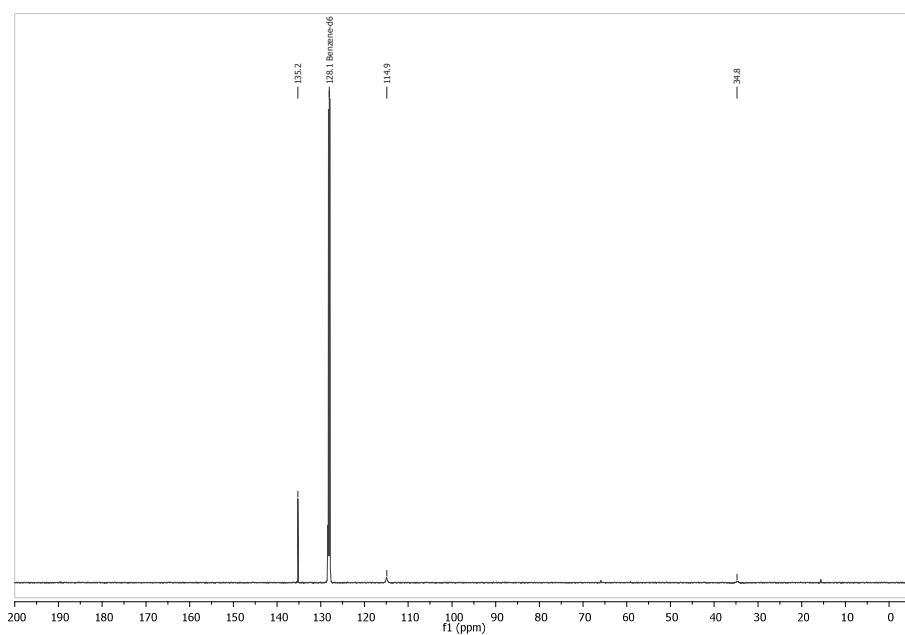


Figure SI- 2. $^{13}\text{C}\{^1\text{H}\}$ NMR spectrum of triallylborane in C_6D_6 .

^c The signals marked with *1 belong to the remaining solvent (diethyl ether) which could not be completely removed after three times fractionated distillation; the signal marked with *2 was attributed to cyclohexane which was an impurity of the NMR solvent batch.

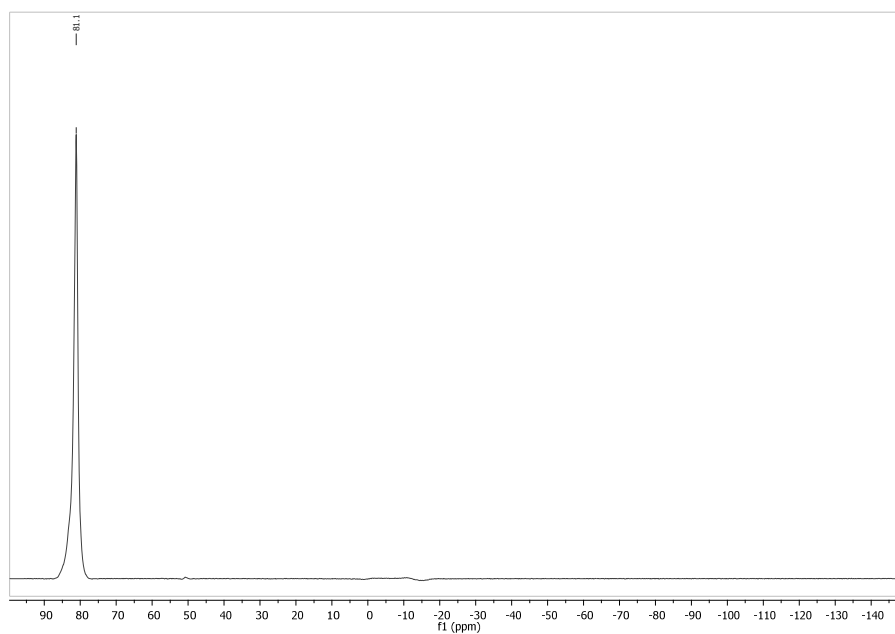
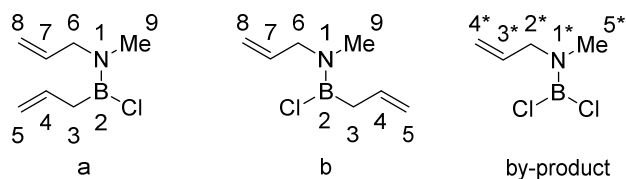


Figure SI- 3. ^{11}B NMR spectrum of triallylborane in C_6D_6 .

1,2-Diallyl-2-chloro-1-methylaminoborane⁴

Similar to the procedure of Lamm *et al.*:²

In a Schlenk flask a solution of BCl_3 (25.8 mL, 25.8 mmol, 1.00 M in hexanes) in *n*-pentane (180 mL) was cooled to $-92\text{ }^\circ\text{C}$ under an atmosphere of nitrogen. Triallylborane (1.73 g, 12.9 mmol) was added dropwise over a course of 1 min. The reaction mixture was stirred at $-92\text{ }^\circ\text{C}$ for 2 h before *N*-methylallylamine³ (2.75 g, 38.6 mmol) and Et_3N (3.91 g, 38.6 mmol) in *n*-pentane (5 mL) were added dropwise using a syringe pump (0.12 mL/min). After addition, the mixture was allowed to warm to $22\text{ }^\circ\text{C}$. After 20 h of stirring, solvent was evaporated under inert conditions until approx. half volume and the mixture was filtrated through an syringe filter. Solvent evaporation (until $35\text{ }^\circ\text{C}$, 100 mbar) and subsequent Kugelrohr distillation ($60\text{ }^\circ\text{C}$, 8 mbar) under inert conditions resulted in 1,2-Diallyl-2-chloro-1-methylaminoborane (2.721 g, 17.28 mmol, 45%) (1:1 mixture of **a** and **b**) which contained not separable by-product (7%). *Kugelrohr distillation led to a considerable amount of polymerized residue. Continuing with the crude mixture (~85-95 % calculated by ¹H NMR spectroscopy) resulted in a significantly higher yield after the next step (overall yield of more than 75 % after synthesis of 2-Chloro-1-methyl-3,6-dihydro-1,2-azaborine).*^d $^1\text{H NMR}$ (500 MHz, C_6D_6) δ 5.99 (2 H, m, 4- $\text{H}_{\text{a,b}}$), 5.50 (1 H, m, 7- $\text{H}_{\text{a,b}}$), 5.33 (1 H, m, 7- $\text{H}_{\text{a,b}}$), 5.02 (4 H, m, 5- $\text{H}_{\text{a,b}}$), 4.89 (4 H, m, 8- $\text{H}_{\text{a,b}}$), 3.58 (2 H, m, 6- $\text{H}_{\text{a,b}}$), 3.22 (2 H, m, 6- $\text{H}_{\text{a,b}}$), 2.58 (3 H, s, 9- $\text{H}_{\text{a,b}}$), 2.29 (3 H, s, 9- $\text{H}_{\text{a,b}}$), 1.92 (4 H, m, 3- $\text{H}_{\text{a,b}}$); By-product: δ 3.36 (m, H-2*), 2.38 (s, H-5*); The other signals are covered by the product signals (confirmed by 2D NMR); $^{13}\text{C}\{^1\text{H}\}$ NMR (126 MHz, C_6D_6) δ 135.3, 135.1 (C-4 $_{\text{a,b}}$), 134.8, 134.8 (C-7 $_{\text{a,b}}$), 116.3, 116.1 (C-8 $_{\text{a,b}}$), 115.0 (C-5 $_{\text{a,b}}$), 54.5, 53.9 (C-6 $_{\text{a,b}}$), 36.9, 36.1 (C-9 $_{\text{a,b}}$);^e By-product: δ 133.6 (C-3*), 116.9 (C-4*); The other signals are covered by the product signals (confirmed by 2D NMR); $^{11}\text{B NMR}$ (161 MHz, C_6D_6) δ 38.1; HRMS- EI^+ (m/z): $[\text{M} + \text{H} - (\text{ClBAl})]^+$ calcd for $\text{C}_4\text{H}_9\text{N}$, 71.0735; found, 71.0736.

^d With our available equipment IR spectroscopy cannot be performed for this air sensitive compound.

^e The signal for the carbon (C-3) adjacent to boron was not visible in the ^{13}C NMR spectrum.

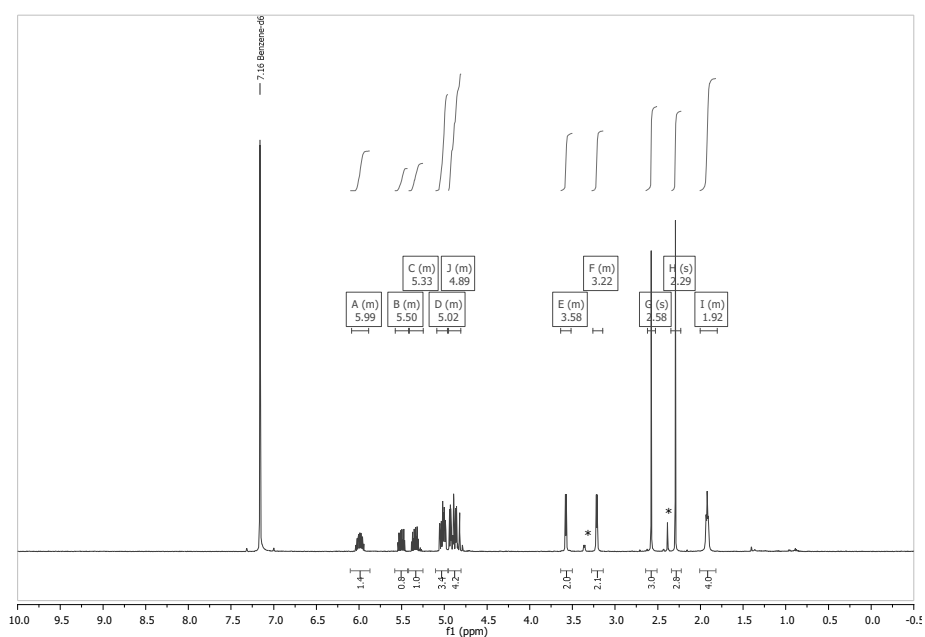


Figure SI- 4. ^1H NMR spectrum of 1,2-diallyl-2-chloro-1-methylaminoborane in C_6D_6 .^f

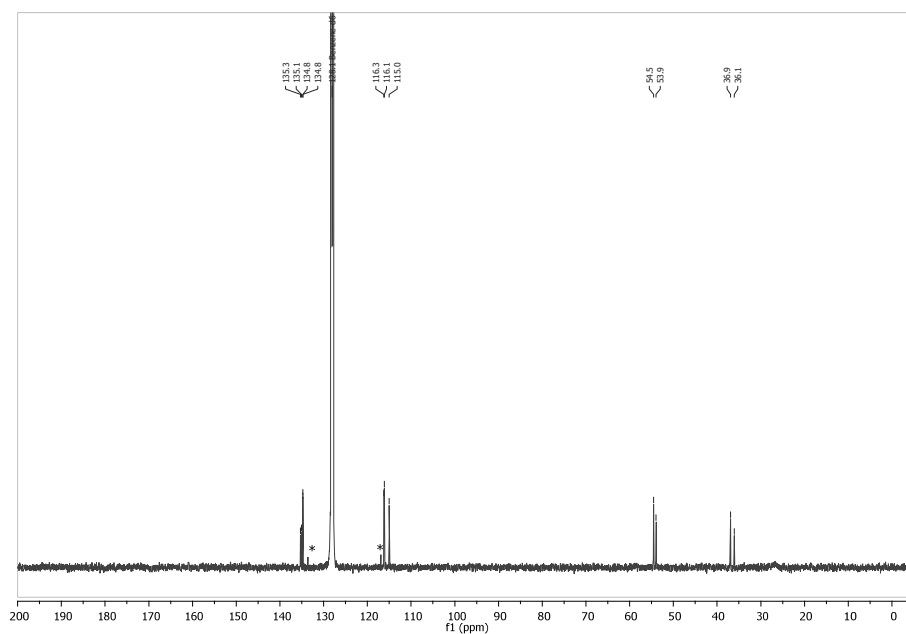


Figure SI- 5. $^{13}\text{C}\{^1\text{H}\}$ NMR spectrum of 1,2-diallyl-2-chloro-1-methylaminoborane in C_6D_6 .^f

^f The signals marked with * are attributed to a by-product with two chlorides on boron which could not be separated.

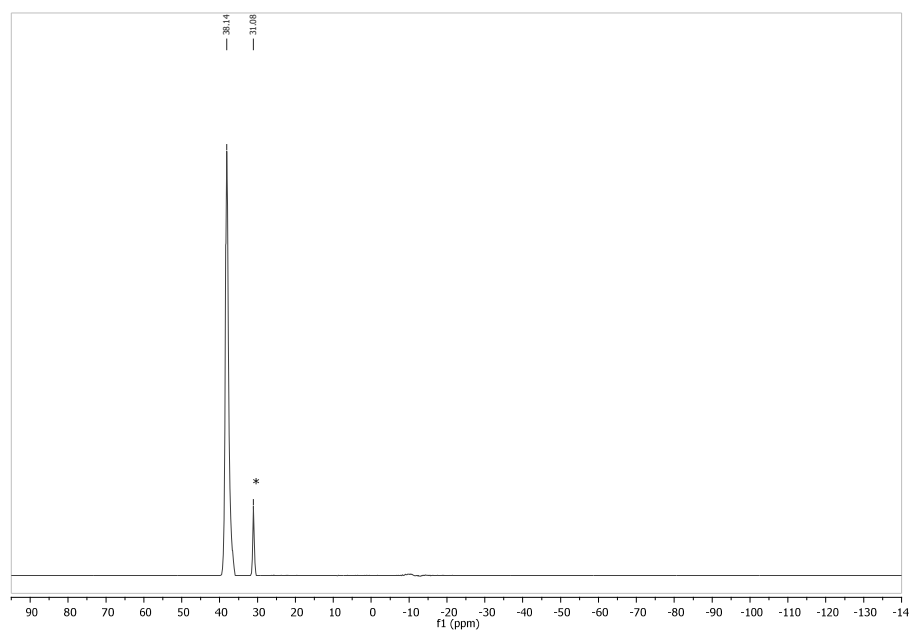
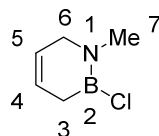


Figure SI- 6. ^{11}B NMR spectrum of 1,2-diallyl-2-chloro-1-methylaminoborane in $\text{C}_6\text{D}_6.f$

2-Chloro-1-methyl-3,6-dihydro-1,2-azaborine⁴

The procedure was adapted similar to Chrostowska et al.⁴

In a glovebox, a 150 mL Schlenk flask was charged with Grubbs Cat. 1st Gen. (481 mg; 584 μ mol; 1 mol%) and CH_2Cl_2 (110 mL). A solution of 1,2-diallyl-2-chloro-1-methylaminoborane (9.20 g; 58.4 mmol) in CH_2Cl_2 (24 mL) was added dropwise over the course of 2 min. to the catalyst solution. The mixture was stirred for 16 h at 21 $^\circ\text{C}$ before the solvent was removed under reduced pressure (40 $^\circ\text{C}$, 200 mbar). Purification by Kugelrohr distillation under inert conditions (50 $^\circ\text{C}$, 20 mbar) led to 2-Chloro-1-methyl-3,6-dihydro-1,2-azaborine (5.44 g, 42.0 mmol, 72%).[§] ^1H NMR (600 MHz, CD_2Cl_2) δ 5.72 (1 H, bs, 4-H), 5.58 (1 H, m, 5-H), 3.64 (2 H, m, 6-H), 2.89 (3 H, s, 7- $\text{H}_{a/b}$), 1.66 (2 H, bs, 3-H); $^{13}\text{C}\{^1\text{H}\}$ NMR (151 MHz, CD_2Cl_2) δ 125.4 (C-4), 124.5 (C-5), 52.6 (C-6), 38.1 (C-3), 18.8 (C-7). ^{11}B NMR (161 MHz, CD_2Cl_2) δ 37.5; HRMS-EI⁺ (m/z): $[\text{M}-\text{O}-\text{M}]^{++}$ calcd for $\text{C}_{10}\text{H}_{17}\text{B}_2\text{N}_2\text{O}$, 203.1527; found, 203.1524.^h

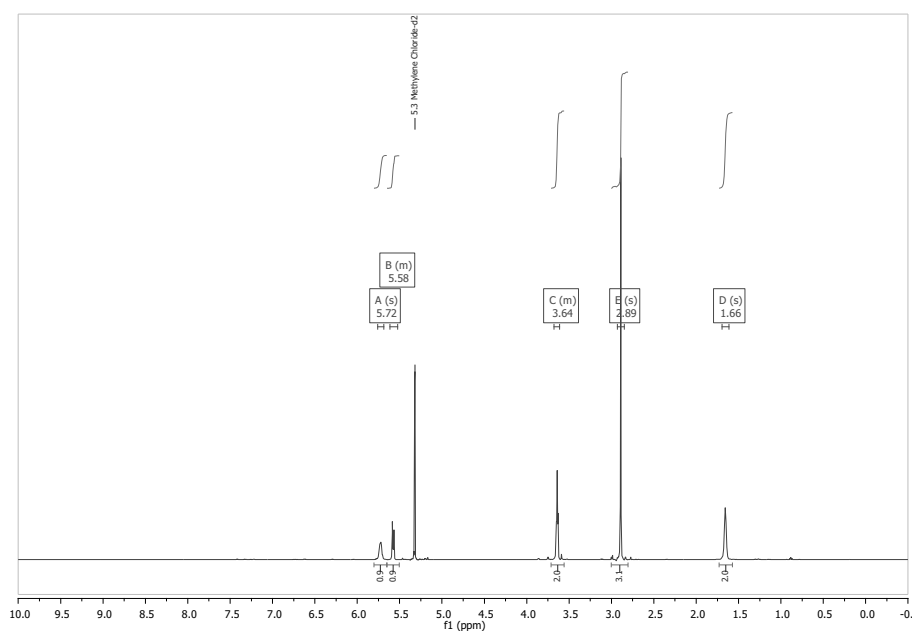


Figure SI- 7. ^1H NMR spectrum of 2-chloro-1-methyl-3,6-dihydro-1,2-azaborine in CD_2Cl_2 .

[§] With our available equipment, high resolution mass spectrometry and IR spectroscopy cannot be performed for air sensitive compounds.

^h Obviously, the compound formed the corresponding anhydride species due to hydrolysis.

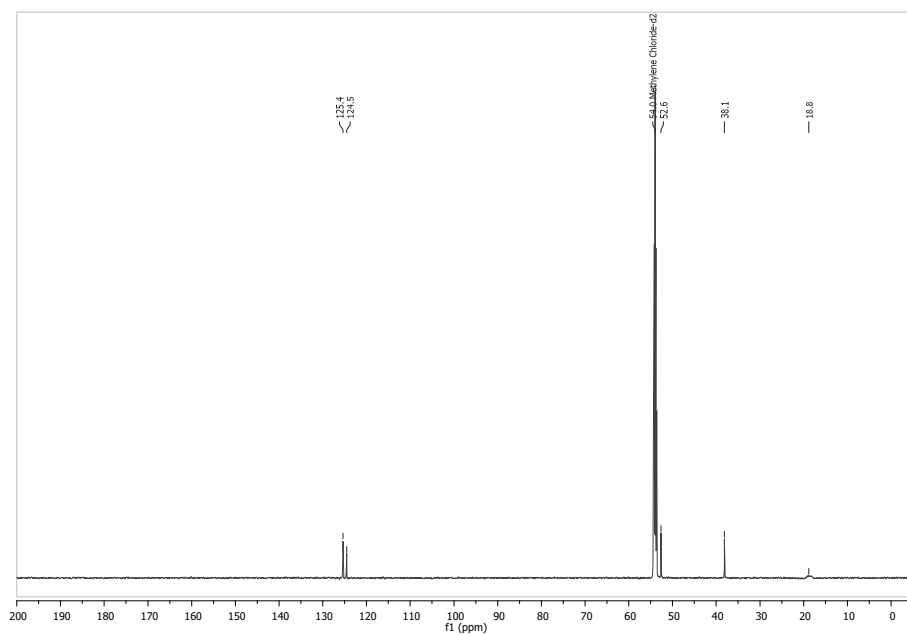


Figure SI- 8. $^{13}\text{C}\{^1\text{H}\}$ NMR spectrum of 2-chloro-1-methyl-3,6-dihydro-1,2-azaborine in CD_2Cl_2 .

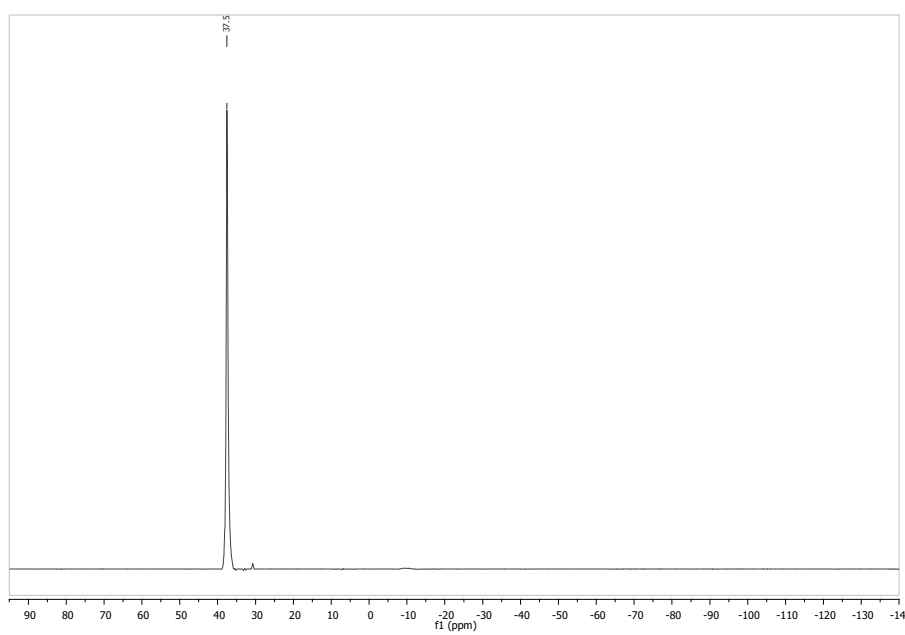
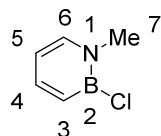


Figure SI- 9. ^{11}B NMR spectrum of 2-chloro-1-methyl-3,6-dihydro-1,2-azaborine in CD_2Cl_2 .

2-Chloro-1-methyl-1,2-azaborine (1)⁴

The procedure was adapted similar to Chrostowska et al.⁴

In a glovebox, a dry microwave vial was charged with Pd black (164 mg; 1.55 mmol), cyclohexene (20 mL) and 2-chloro-1-methyl-3,6-dihydro-1,2-azaborine (1.50 g; 11.6 mmol) was added. The flask was sealed with a microwave cap. The mixture was stirred and heated for 6 h at 120 °C in the microwave. Subsequently, the reaction mixture was filtered through a PTFE syringe filter (pore size = 0.45 μm), the solvent was removed under reduced pressure and Kugelrohr distillation under inert conditions (65 °C, 20 mbar) resulted in azaborine 1 (985 mg, 7.73 mmol, 67%).ⁱ ¹H NMR (500 MHz, CD₂Cl₂) δ 7.56 (1 H, bs, 4-H), 7.22 (1 H, m, 6-H), 6.62 (1 H, m, 3-H), 6.30 (1 H, m, 5-H), 3.59 (3 H, s, 7-H); ¹³C{¹H} NMR (126 MHz, CD₂Cl₂) δ 145.2 (C-4), 140.6 (C-6), 127.7 (C-3), 111.0 (C-5), 41.3 (C-7);^j ¹¹B NMR (161 MHz, CD₂Cl₂) δ 32.8; HRMS-EI⁺ (*m/z*): [M-O-M]⁺⁺ calcd for C₁₀H₁₃B₂N₂O, 199.1214; found, 199.1207.^k

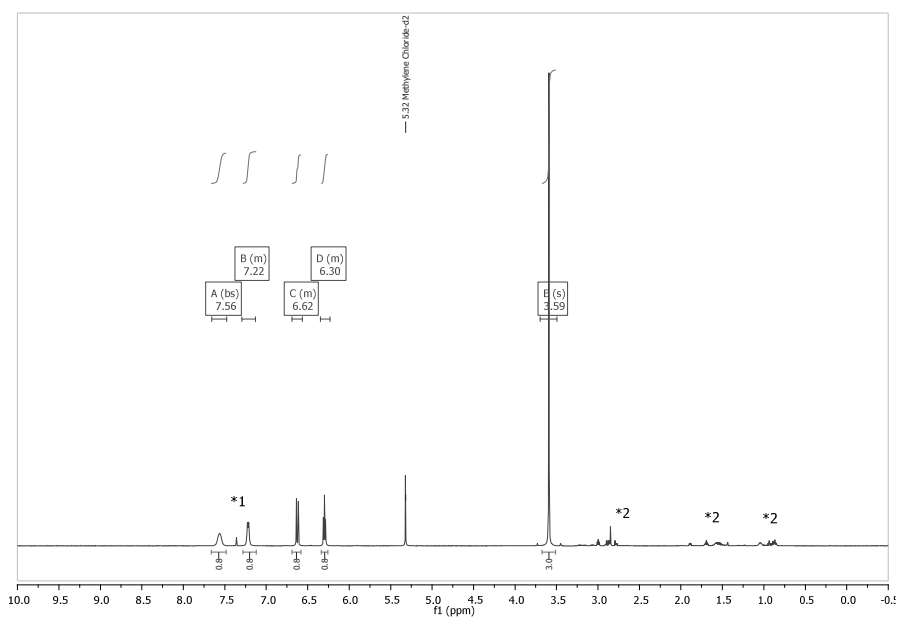


Figure SI- 10. ¹H NMR spectrum of 2-chloro-1-methyl-1,2-azaborine (**1**) in CD₂Cl₂; *1 = traces benzene (by-product); *2 = not separable traces of undefined by-products.

ⁱ With our available equipment, IR spectroscopy cannot be performed for this air sensitive compound.

^j The signal intensity for the carbon atom next to the boron atom (C-3) in the ¹³C NMR spectrum was very low.

^k Obviously, the compound formed the corresponding anhydride species due to hydrolysis.

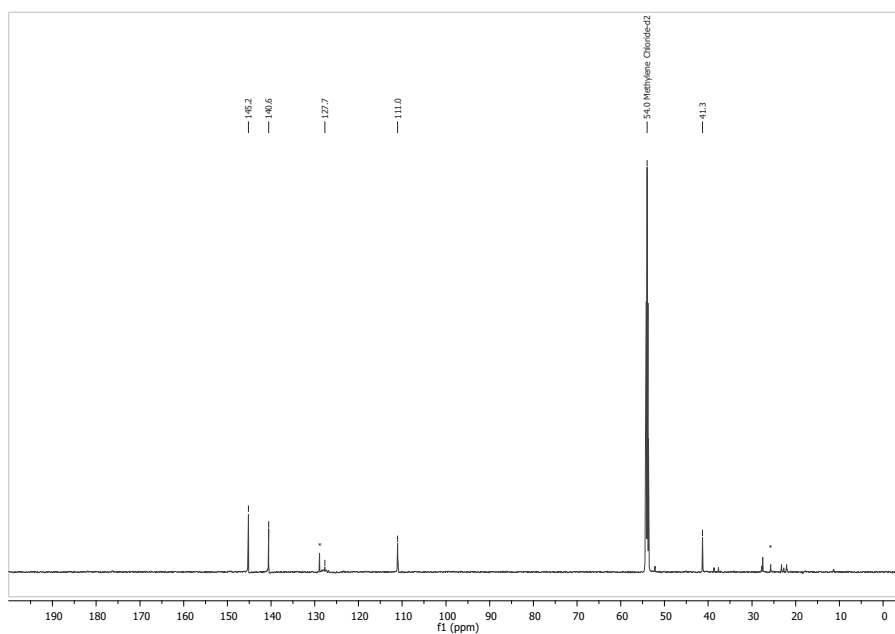


Figure SI- 11. $^{13}\text{C}\{^1\text{H}\}$ NMR spectrum of 2-chloro-1-methyl-1,2-azaborine (**1**) in CD_2Cl_2 .¹

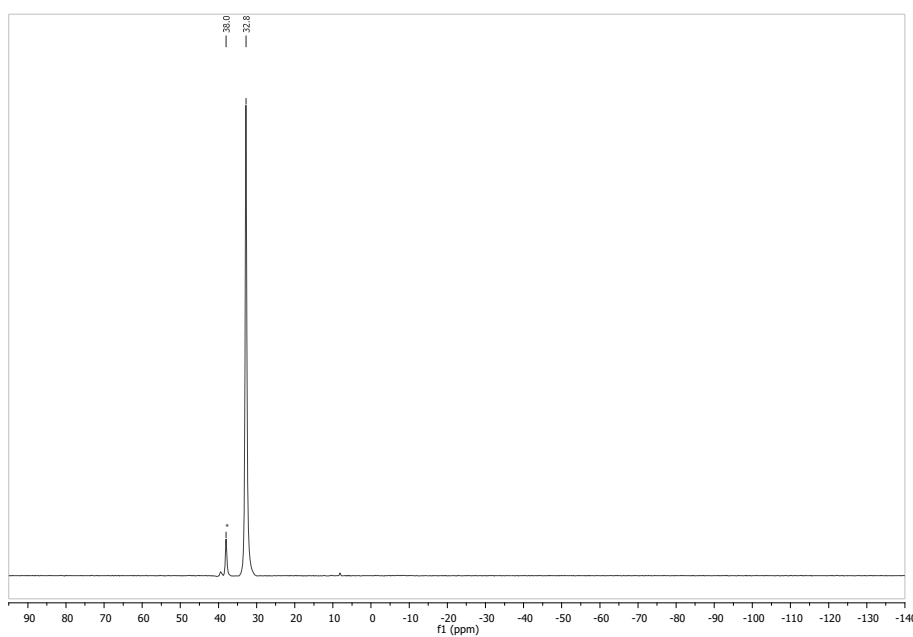
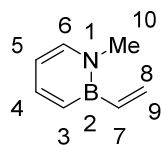


Figure SI- 12. ^{11}B NMR spectrum of 2-chloro-1-methyl-1,2-azaborine (**1**) in CD_2Cl_2 .^m

¹ The signals marked with * were attributed to benzene and cyclohexane (+ undefined) residues from the reaction which was not absolutely separable after several Kugelrohr distillations.

^m The signals marked with * were attributed to the hydrolyzed by-product, which was not separable.

1-Methyl-2-vinyl-1,2-azaborine (2)Preparation of vinyl lithium (according to Seyferth et al.)⁵:

In a Schlenk tube under an N₂ atmosphere, *n*-butyllithium (8.0 mL, 20 mmol; 2.5 M in hexanes) was added dropwise to tetravinyl stannane (2.39 g, 10.00 mmol) over the course of 3 min. A precipitate was formed. After letting it settle, the solvent was removed via syringe and the solid was washed 4 times with *n*-pentane (4 mL). Finally, vinyl lithium was dissolved in diethylether (10 mL). Concentration (0.59 M; 59 % yield) was determined by titration (menthol/2,2-bipyridyl).⁶

Vinylation procedure adapted according to the procedure of Marwitz et al. for another compound:⁷

Under a N₂ atmosphere, a 100 mL Schlenk flask was filled with **1** (1.15 g, 9.00 mmol) and degassed Et₂O (80 mL). The solution was cooled down to -92 °C (N₂/acetone bath) before vinyl lithium (10.8 mL, 10.8 mmol, 1 M in Et₂O) was added dropwise using a syringe pump (0.5 mL/min). After addition, the solution was stirred for further 2 h at -92 °C before it was allowed to warm up to 22 °C by removing the cooling bath. The mixture was concentrated to ca. 30 mL before it was filtered through a syringe filter. Removing of solvent (40 °C, 150 mbar) and Kugelrohr distillation (65 °C, 20 mbar) gave azaborine **2** (765 mg, 6.43 mmol, 71%). ¹H NMR (500 MHz, CD₂Cl₂) δ 7.53 (1 H, dd, *J* = 11.0, 6.6 Hz, 4-H), 7.15 (1 H, d, *J* = 6.6 Hz, 6-H), 6.89 (1 H, dd, *J* = 11.0, 1.5 Hz, 3-H), 6.63 (1 H, dd, *J* = 19.5, 13.6 Hz, 7-H), 6.25 (1 H, ddd, *J* = 6.6, 6.6, 1.5 Hz, 5-H), 6.06 (1 H, dd, *J* = 19.5, 3.9 Hz, 8-H), 5.92 (1 H, dd, *J* = 13.6, 3.9 Hz, 9-H), 3.59 (1 H, s, 10-H); ¹³C{¹H} NMR (126 MHz, CD₂Cl₂) δ 143.0 (C-4), 140.3 (C-6), 137.9 (C-7), 130.9 (C-8,9), 128.0 (C-3), 111.1 (C-5), 42.0 (C-10); ¹¹B NMR (161 MHz, CD₂Cl₂) δ 33.4; HRMS^a.

^a With our available equipment, high resolution mass spectrometry and IR spectroscopy cannot be performed for this air sensitive compound.

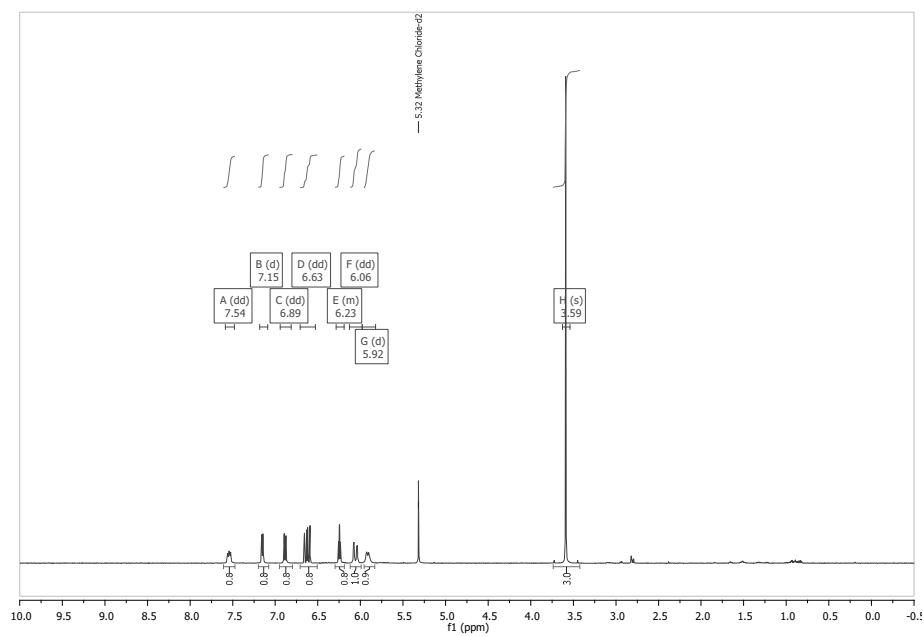


Figure SI-13. ^1H NMR spectrum of 1-methyl-2-vinyl-1,2-azaborine (**2**) in CD_2Cl_2 .

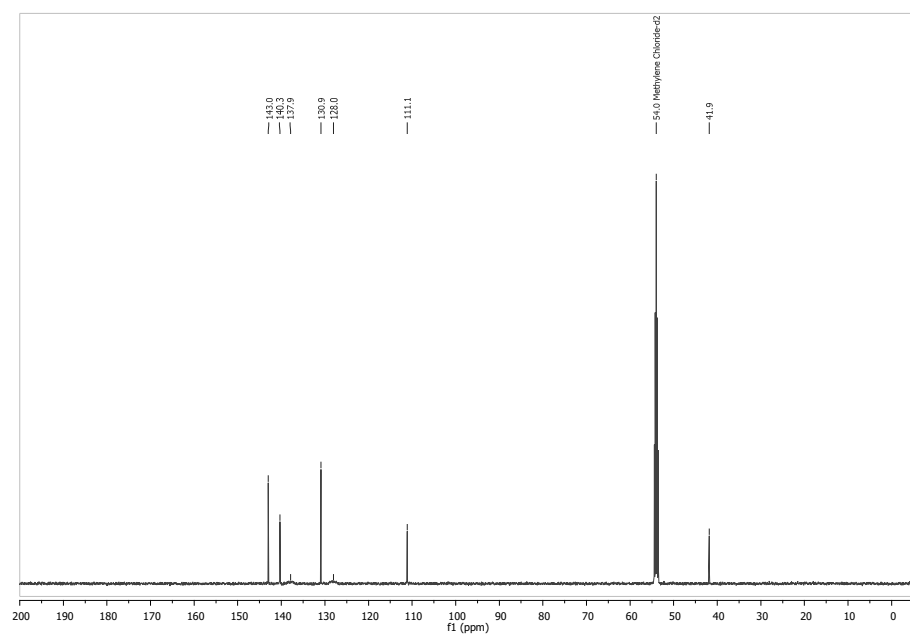


Figure SI-14. $^{13}\text{C}\{^1\text{H}\}$ NMR spectrum of 1-methyl-2-vinyl-1,2-azaborine (**2**) in CD_2Cl_2 .

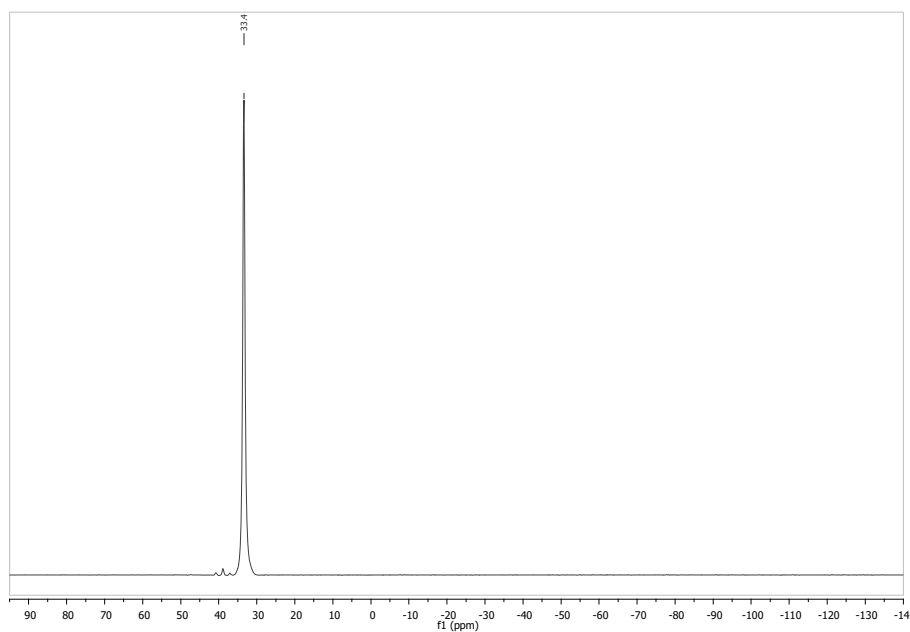
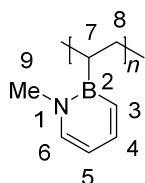


Figure SI- 15. ^{11}B NMR spectrum of 1-methyl-2-vinyl-1,2-azaborine (**2**) in CD_2Cl_2 .

Polymerizations and Characterizations

Poly(1-methyl-2-vinylazaborine) (3)



Under a nitrogen atmosphere, 1-methyl-2-vinylazaborine (303 mg, 2.55 mmol) and AIBN (4 mg, 25 μmol , 1 mol%) were placed into a dried J Young's tube. The mixture was transferred into a preheated oil bath (85 $^{\circ}\text{C}$) and heated for 72 h until the mixture became highly viscous. The polymer was then dissolved in toluene (2 mL) and precipitated into methanol (6 mL). The polymer was dried under reduced pressure (4×10^{-2} mbar, 40 $^{\circ}\text{C}$ oil bath) to yield in poly(1-methyl-2-vinylazaborine) (3) (153 mg, 51%). [For redissolving and transferring into a storage bottle dichloromethane was used due to low solubility in toluene]. ^1H NMR (600 MHz, C_6D_6) δ 7.52 (1 H, bm, 4-H), 6.98 (1 H, bm, 6-H), 6.64 (1 H, bm, 3-H), 6.15 (1 H, bm, 5-H), 2.92 (3 H, bm, 9-H), 1.50 (3 H, bm, 7-H,8-H); $^{13}\text{C}\{^1\text{H}\}$ NMR (151 MHz, C_6D_6) δ 141.4 (C-4), 139.2 (C-6), 129.9 (C-3), 109.4 (C-5), 40.8 (C-9), 39.8 (C-7), 28.0 (C-8); ^{11}B NMR (161 MHz, C_6D_6) δ 44; ^1H NMR (600 MHz, CD_2Cl_2) δ 7.21 (1 H, bm, 4-H), 6.89 (1 H, bm, 6-H), 6.43 (1 H, bm, 3-H), 6.02 (1 H, bm, 5-H), 3.20 (3 H, bm, 9-H), 1.14 (3 H, bm, 7-H,8-H); $^{13}\text{C}\{^1\text{H}\}$ NMR (151 MHz, CD_2Cl_2) δ 141.5 (C-4), 139.6 (C-6), 129.5 (C-3), 109.5 (C-5), 41.1 (C-9), 39.3 (C-7), 27.7 (C-8); IR (ATR) $\nu_{\text{max}}/\text{cm}^{-1}$ 3067, 3000, 2895, 2836, 1612, 1514, 1463, 1416, 1397, 1311, 1225, 732, 697; MS° ; $M_w = 24900$ g/mol (eluent: THF, elution at 1 mL/min, 35 $^{\circ}\text{C}$, universal calibration); PDI = 1.51.

^o The polymer could not be analysed by mass spectrometry (MALDI, ESI).

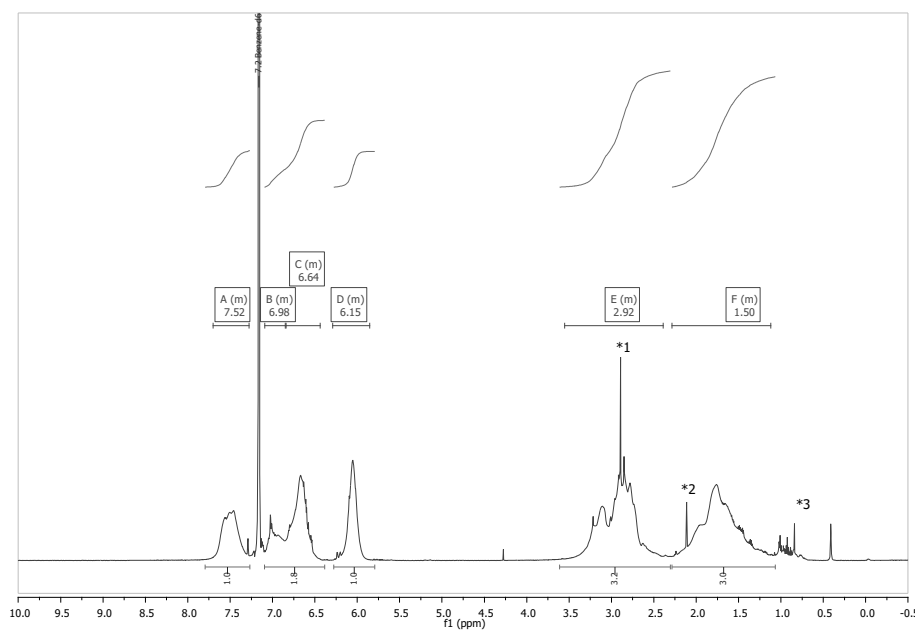


Figure SI- 16. ^1H NMR spectrum of poly(1-methyl-2-vinylazaborine) (**3**) in C_6D_6 ; *1 = starting material; *2 = toluene; *3 = undefined signals.

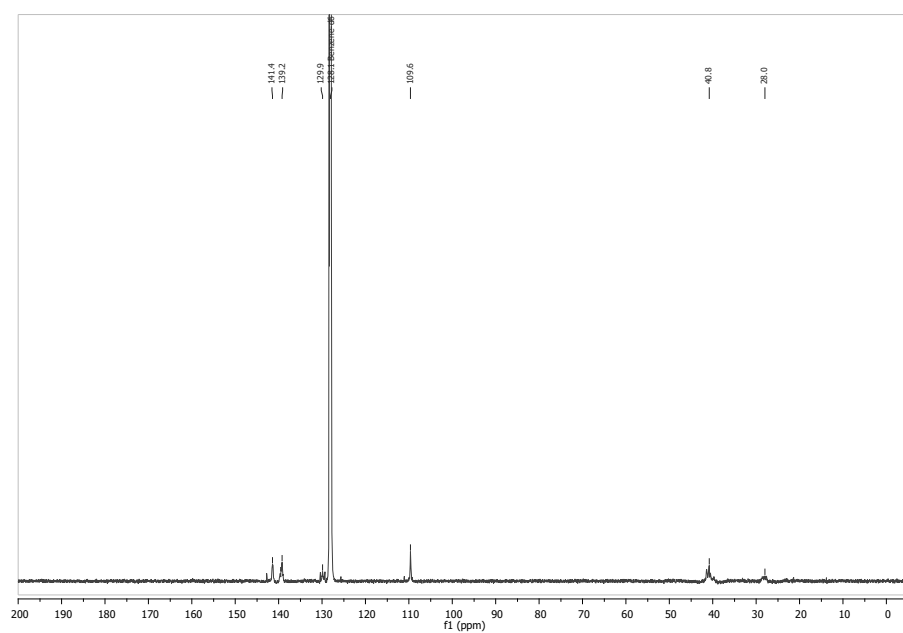


Figure SI- 17. $^{13}\text{C}\{^1\text{H}\}$ NMR spectrum of poly(1-methyl-2-vinylazaborine) (**3**) in C_6D_6 .

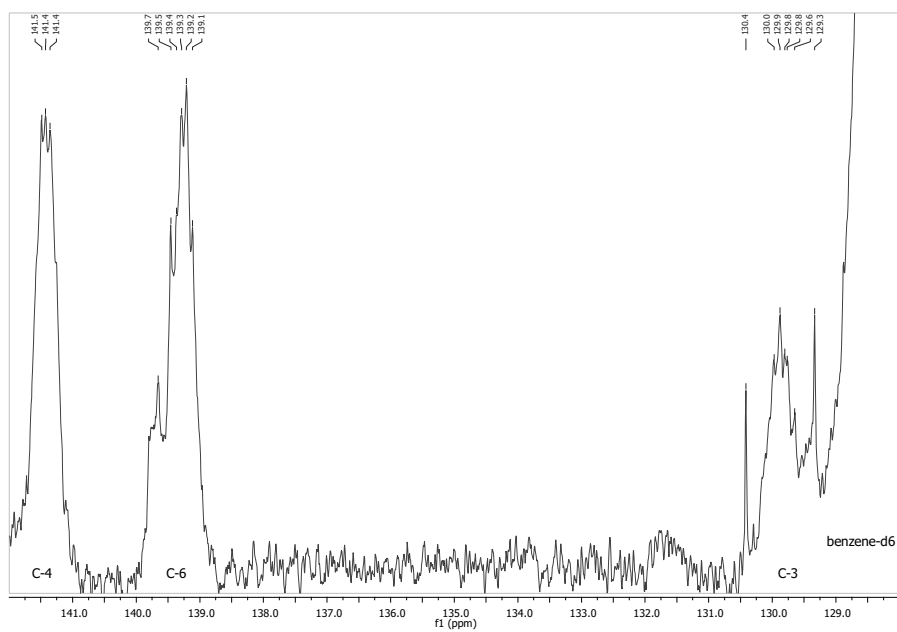


Figure SI- 18. Section of the $^{13}\text{C}\{^1\text{H}\}$ NMR spectrum of poly(1-methyl-2-vinylazaborine) (**3**) in C_6D_6 .

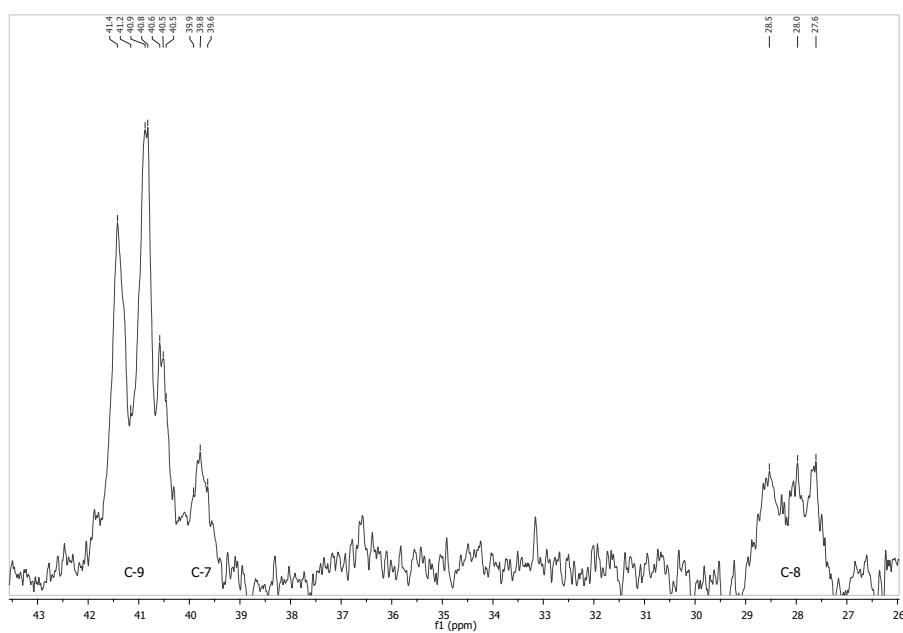


Figure SI- 19. Section of the $^{13}\text{C}\{^1\text{H}\}$ NMR spectrum of poly(1-methyl-2-vinylazaborine) (**3**) in C_6D_6 .

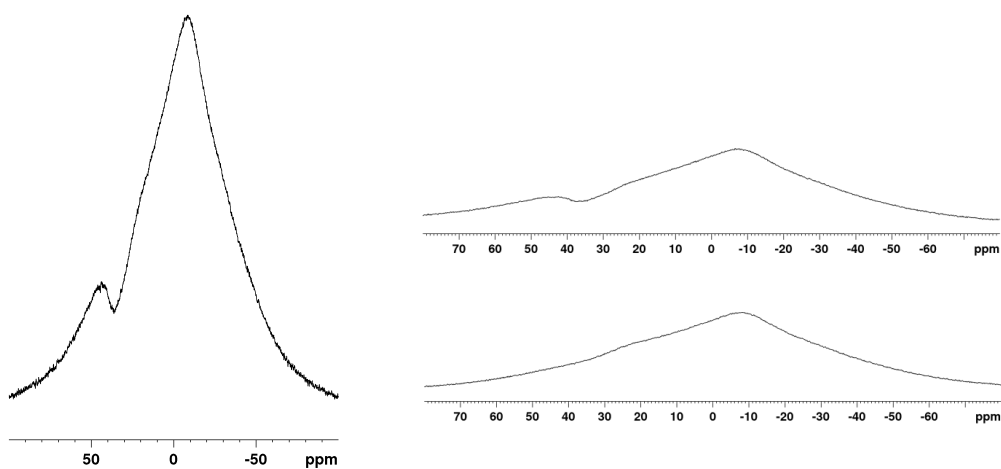


Figure SI- 20. Left: ^{11}B NMR spectrum of poly(1-methyl-2-vinylazaborine) (**3**) in C_6D_6 ; Right top: ^{11}B NMR spectrum of poly(1-methyl-2-vinylazaborine) (**3**) in C_6D_6 in a quartz NMR tube compared to an ^{11}B NMR spectrum of pure C_6D_6 solvent (bottom) for comparison. The broad signal centred at ca. -8 ppm originates from boron-containing materials in the probe head, with the broad boron-signal arising from compound **3** at ~-44 ppm.

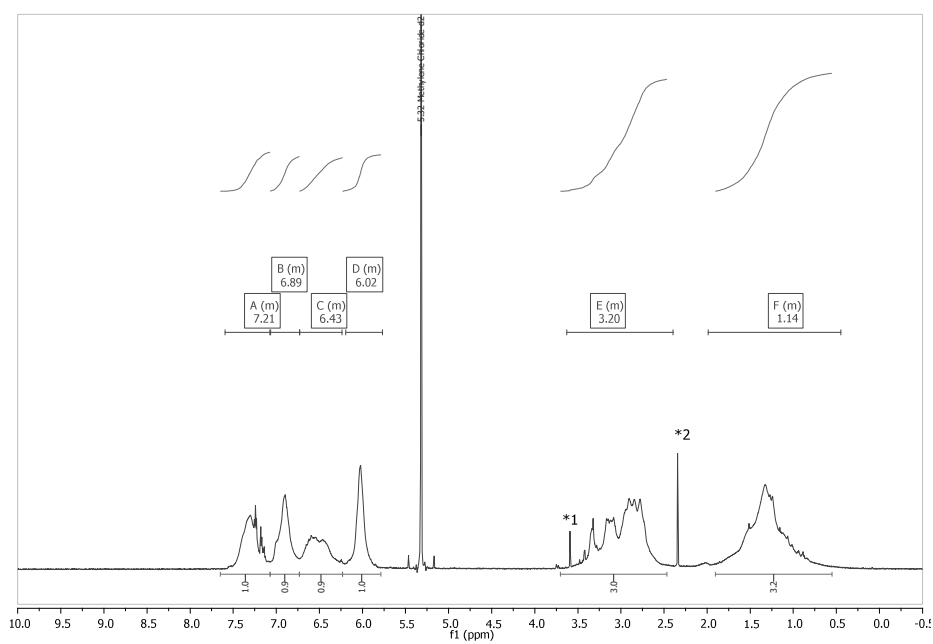


Figure SI- 21. ^1H NMR spectrum of poly(1-methyl-2-vinylazaborine) (**3**) in CD_2Cl_2 ; *1 = starting material; *2 = toluene.

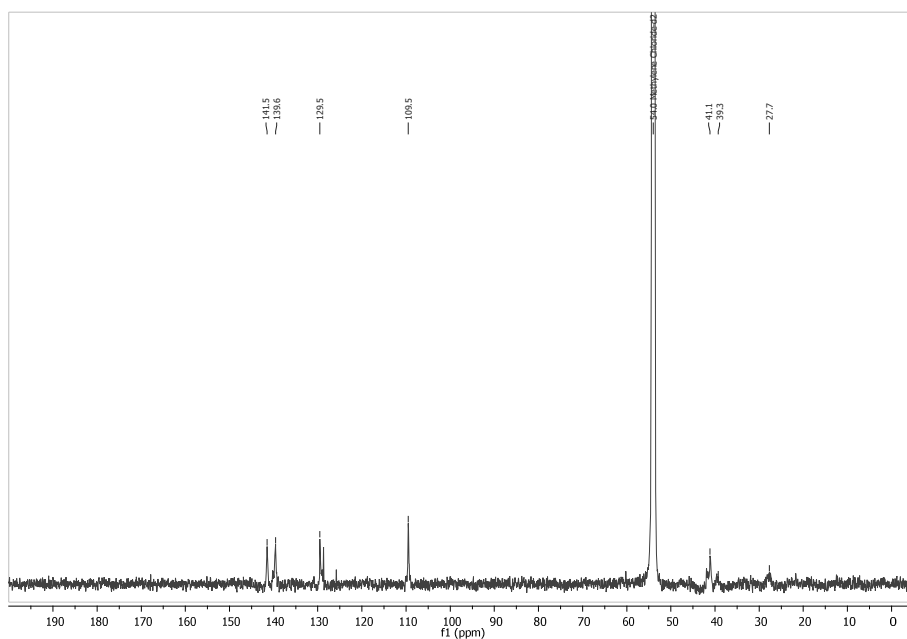


Figure SI- 22. $^{13}\text{C}\{^1\text{H}\}$ NMR spectrum of poly(1-methyl-2-vinylazaborine) (**3**) in CD_2Cl_2 .

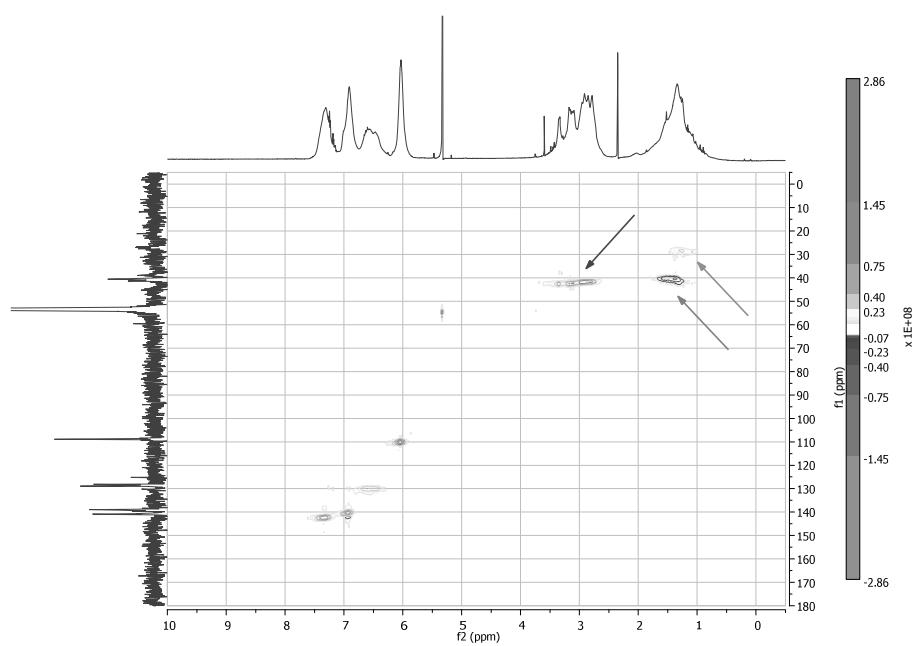


Figure SI- 23. HSQC-DEPT experiment in CD_2Cl_2 for assigning the ^1H and ^{13}C signals of **3**. The signal for the *N*-methyl groups are clearly visible (blue arrow); In the signal for the olefinic backbone, there is a signal for a methylene group (red arrow) and a further signal for the CH-group (purple arrow). There is no evidence that the *N*-methyl group has reacted during the radical polymerization.

SI 22

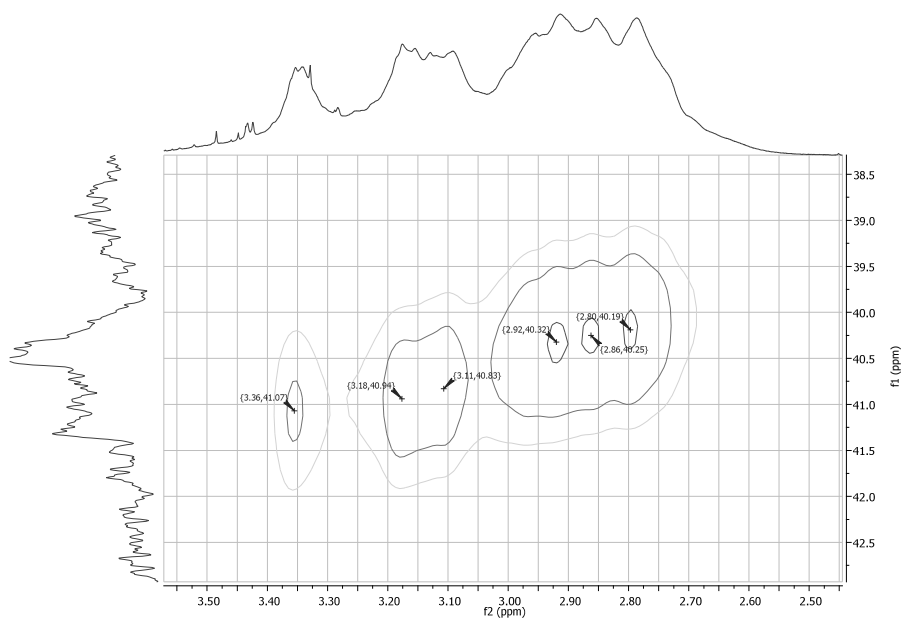


Figure SI- 24. Section of the HSQC NMR spectrum of poly(1-methyl-2-vinylazaborine) (**3**) in CD_2Cl_2 .

Table SI- 2. GPC results of poly(1-methyl-2-vinylazaborine) (**3**) measured in THF; Conventional calibration was performed with polystyrene standards (narrow distribution) and a refractive index detector; Universal calibration was performed with additional on-line viscometer detection.

	Conventional Calibration	Universal Calibration
<i>Mn</i> (g/mol)	6470	16500
<i>Mw</i> (g/mol)	10300	24900
<i>PDI</i>	1.59	1.51

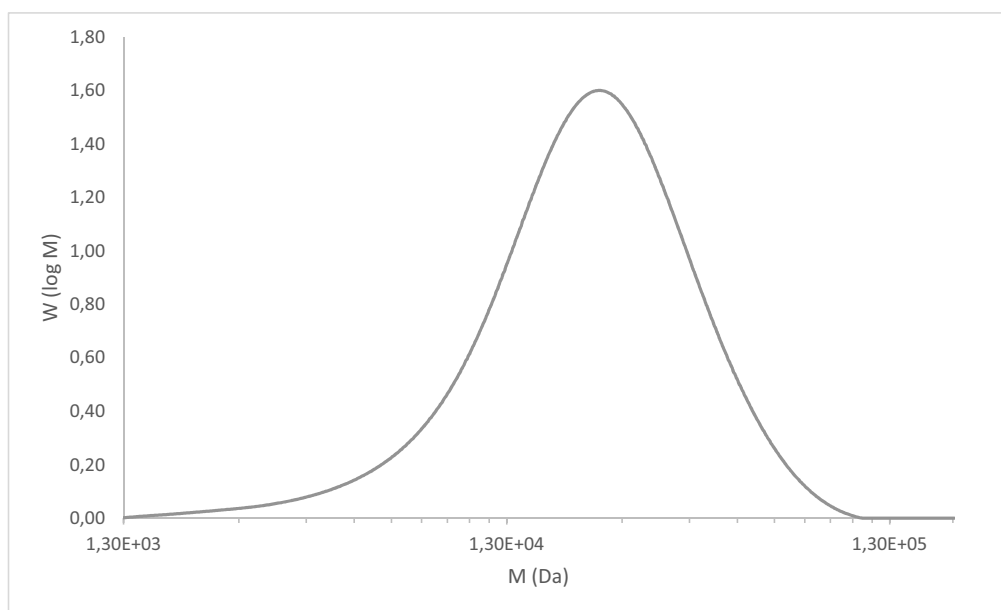


Figure SI- 25. Mass distribution diagram of poly(1-methyl-2-vinylazaborine) (**3**) measured in THF.

DSC

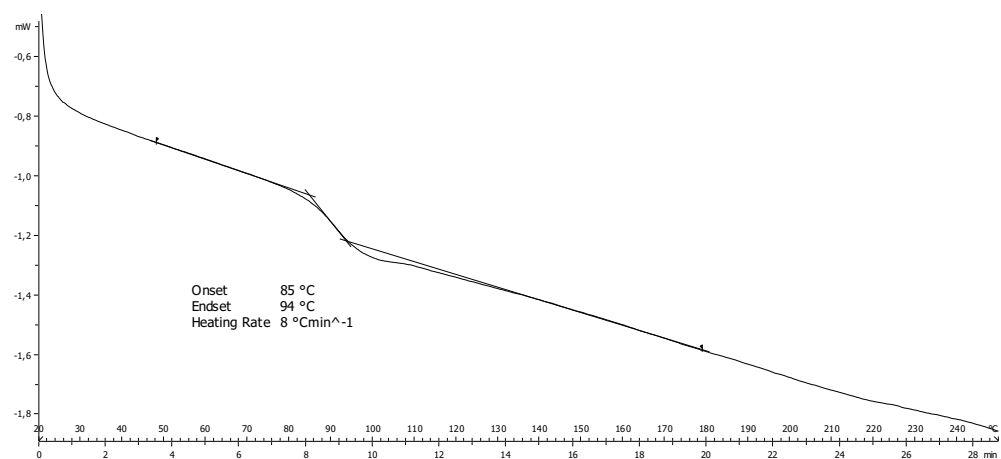


Figure SI- 26. Differential scanning calorimetry of poly(*N*-methyl-2-vinylazaborine) (**3**) under a nitrogen atmosphere; sample weight: 4.4292 mg; heating rate: 8.00 K/min; crucible: 40 μ L aluminium; T_g: 85 °C (onset); exo up.

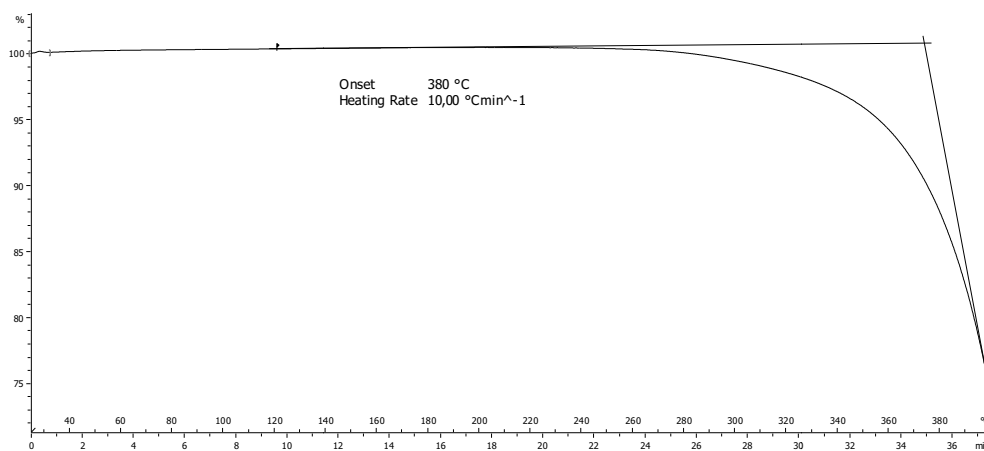
TGA

Figure SI- 27. Thermogravimetric analysis curve of poly(*N*-methyl-2-vinylazaborine) (**3**) under a nitrogen atmosphere; sample weight : 7.1430 mg; heating rate: 10.00 K/min; crucible: 40 μ L aluminium; T_d : 380 °C (onset); exo up.

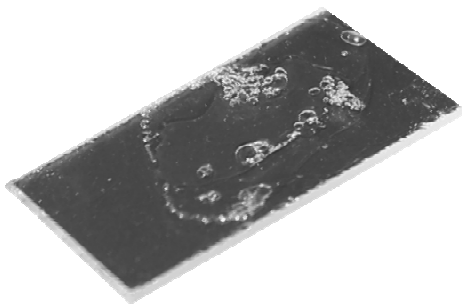
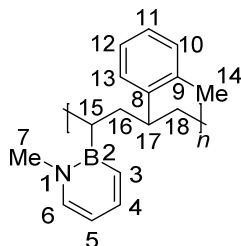
Photo

Figure SI- 28. Transparent film of poly(*N*-methyl-2-vinylazaborine) (**3**) on a glass plate after removing the solvent from the dichloromethane solution on a heating plate at 40 °C under inert conditions.

Poly(1-methyl-2-vinylazaborine-2'-methylstyrene) (6)

Under a nitrogen atmosphere, **2** (149 mg, 1.25 mmol), 2-vinyltoluene (148 mg, 1.25 mmol) and AIBN (4 mg, 25 μ mol, 1 mol%) were placed into a dried J. Young's tube. The mixture was transferred into a preheated oil bath (85 °C) and stirred for 6 h until it solidified. The polymer was dissolved in a mixture of toluene (2 mL) and diethyl ether (0.5 mL)^p and precipitated into methanol (6 mL). The polymer was dried under reduced pressure (4×10^{-2} mbar, 40 °C oil bath) to yield poly(1-methyl-2-vinylazaborine-2'-methylstyrene) (**6**) (255 mg, 86%).^q ¹H NMR (600 MHz, C₆D₆) δ 7.82-6.28 (bm, 3/4/5/10/11/12/13-H), 6.29-5.77 (bm, 5-H), 3.35-2.32 (bm, 7/17-H), 2.32-0.51 (bm, 14/15/16/18-H); ¹H NMR (600 MHz, CD₂Cl₂) δ 7.66-6.23 (bm, 3/4/5/10/11/12/13-H), 6.23-5.83 (bm, 5-H), 3.32-2.12 (bm, 7/17-H), 2.12-0.39 (bm, 14/15/16/18-H); ¹³C{¹H} NMR (151 MHz, C₆D₆) δ 145.0-144.3 (C-8), 142.2 (C-4), 139.5 (C-6), 136.4 (C-9), 130.6, 129.3, 128.8, 126.4, 125.7 (C-3/10/11/12/13), 110.1 (C-5), 40.5 (C-7), 37.4 (C-15), 35.4 (C-17), 25.9, 24.0 (C-16/18), 19.1 (C-14); ¹³C{¹H} NMR (151 MHz, CD₂Cl₂) δ 145.2-144.5 (C-8), 142.3 (C-4), 139.8 (C-6), 136.6 (C-9), 130.5, 129.6, 128.7, 126.4, 125.8 (C-3/10/11/12/13), 109.9 (C-5), 40.9 (C-7), 36.8 (C-15), 35.0 (C-17), 25.3, 23.9 (C-16/18), 19.0 (C-14); ¹¹B NMR (96 MHz, C₆D₆) δ 35.6, 31.2, 26.7; IR (ATR) ν_{max} /cm⁻¹ 3067, 3016, 2946, 2914, 2852, 1612, 1514, 1491, 1459, 1401, 1307, 759, 728, 692, 458; M_w = 36900 g/mol (eluent: THF, elution at 1 mL/min, 35 °C, universal calibration); PDI = 1.68.

^p Diethyl ether was necessary because the polymer was hardly soluble in pure toluene.

^q The polymer could not be analysed by mass spectrometry (MALDI, ESI).

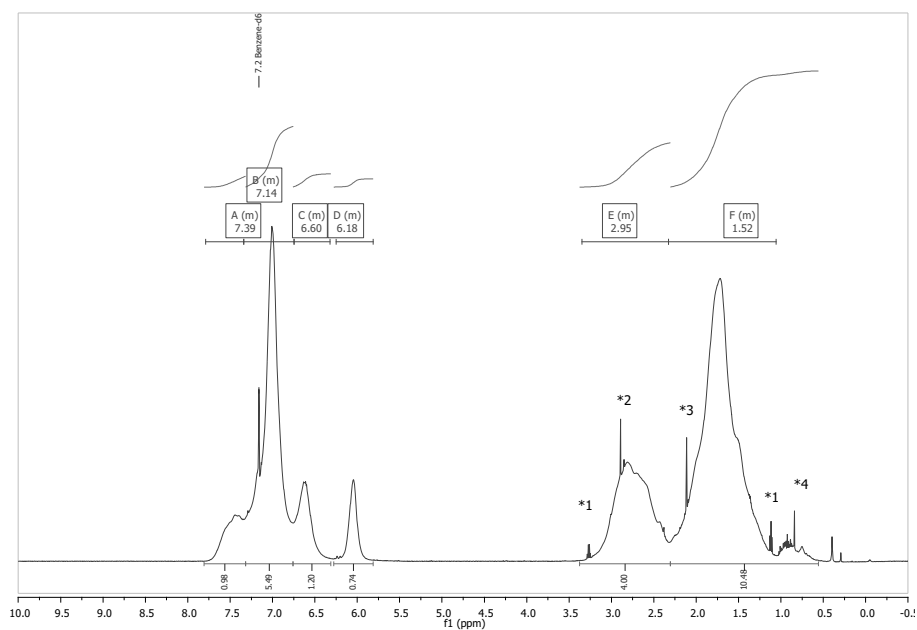


Figure SI- 29. ^1H NMR spectrum of the copolymer **6** in C_6D_6 ; traces from precipitation process: *1 = diethyl ether, *2 = methanol, *3 = toluene.

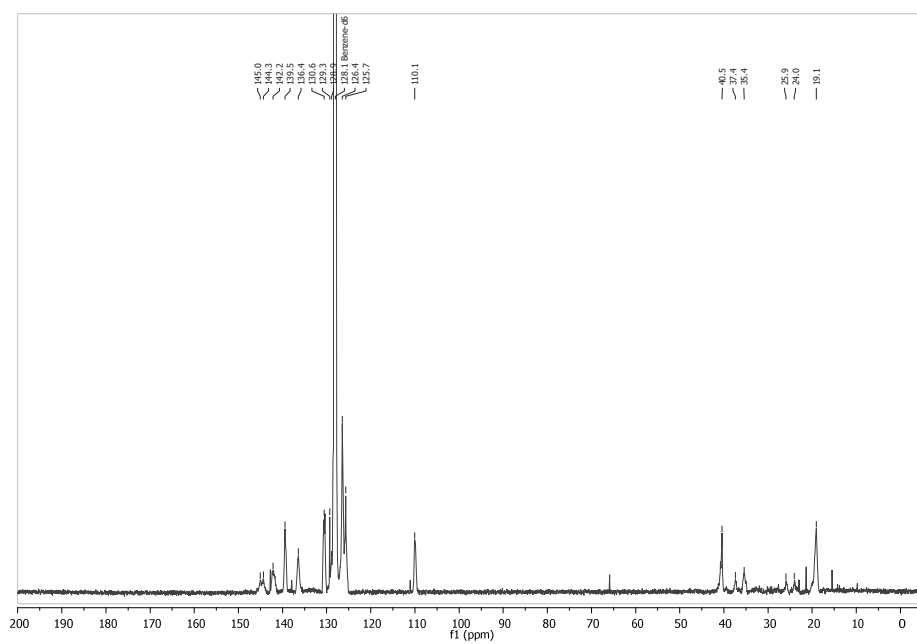


Figure SI- 30. $^{13}\text{C}\{^1\text{H}\}$ NMR spectrum of copolymer **6** in C_6D_6 .

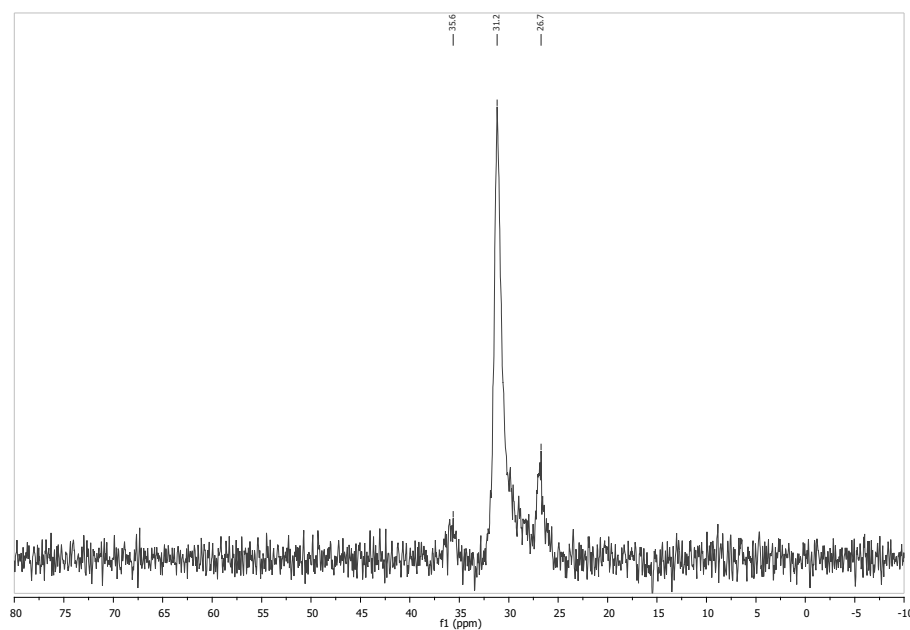


Figure SI- 31. ^{11}B NMR spectrum of copolymer 6 in C_6D_6 .

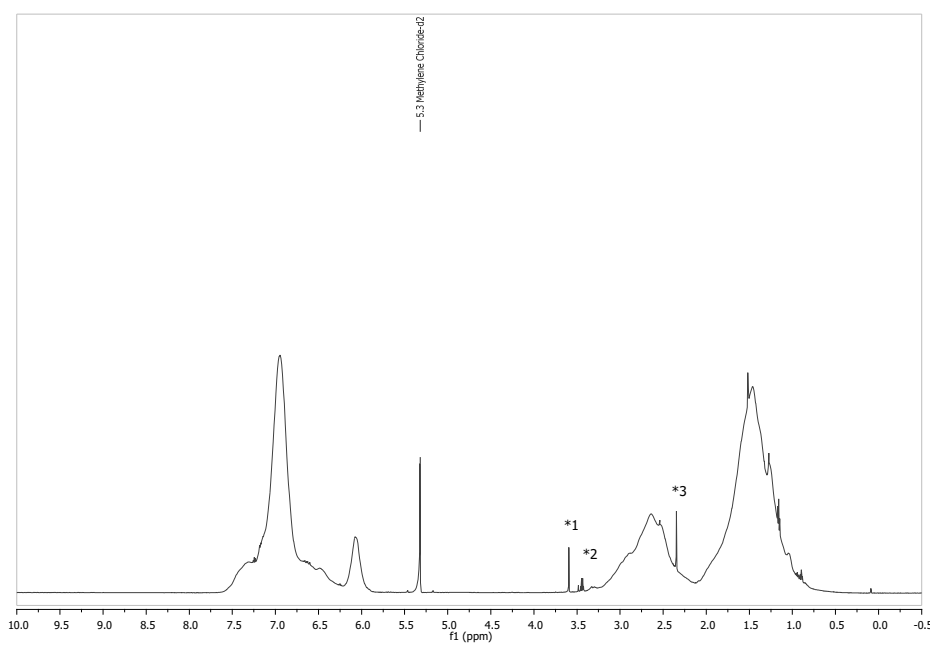


Figure SI- 32. ^1H NMR spectrum of copolymer 6 in CD_2Cl_2 ; traces from precipitation process: *1 = monomer, *2 = diethyl ether, *3 = monomer/toluene.

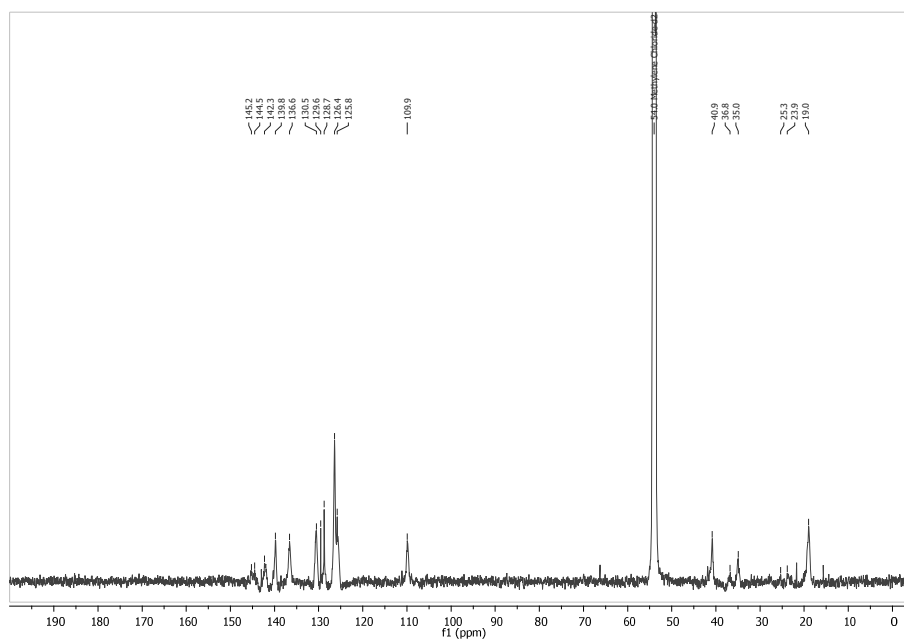


Figure SI- 33. $^{13}\text{C}\{^1\text{H}\}$ NMR spectrum of copolymer **6** in CD_2Cl_2 .

Table SI- 3. GPC results for the copolymer **6** measured in THF; Conventional calibration was performed with polystyrene standards (narrow distribution) and a refractive index detector; Universal calibration was performed with additional on-line viscometer detection.

	Conventional Calibration	Universal Calibration
<i>Mn</i> (g/mol)	12100	21900
<i>Mw</i> (g/mol)	22800	36900
<i>PDI</i>	1.88	1.68

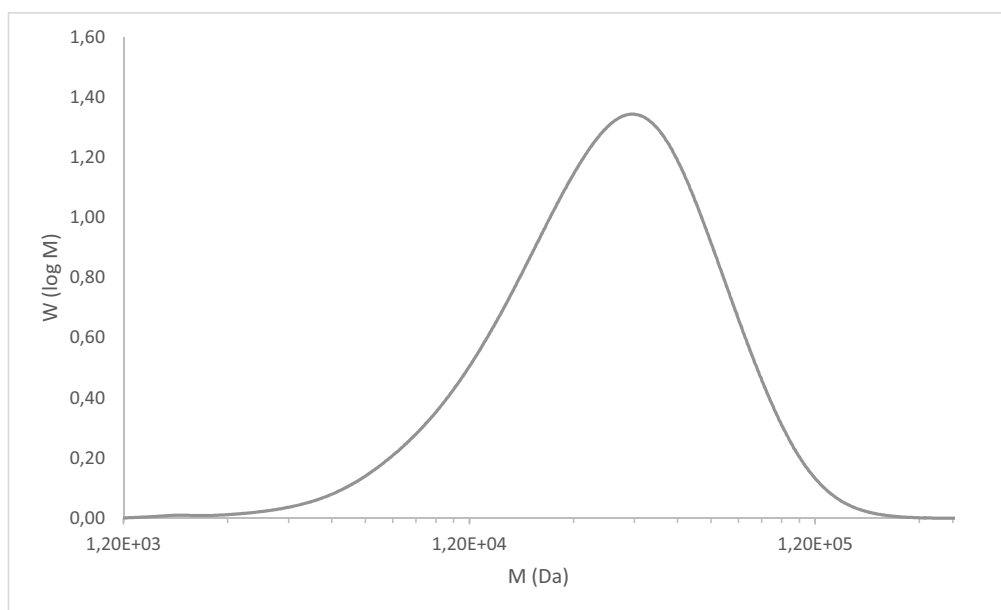


Figure SI- 34. Mass distribution curve of copolymer **6** (universal calibration) measured in THF.

DSC

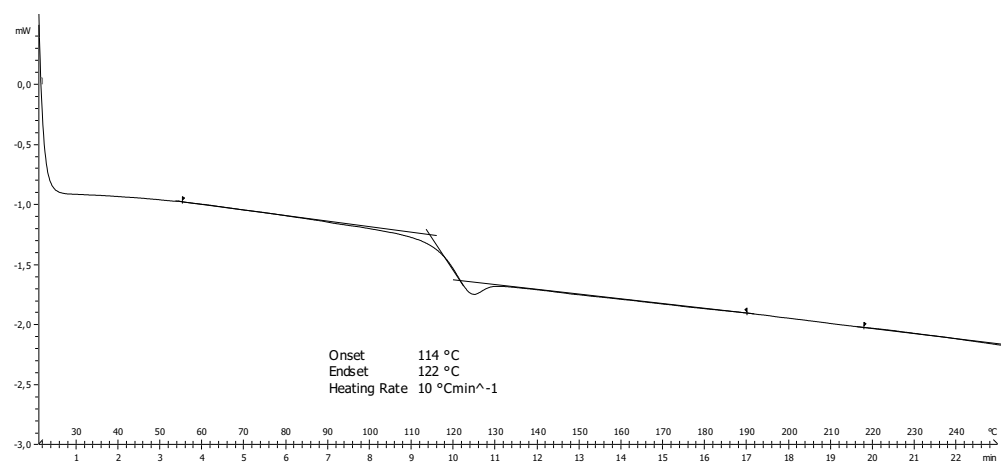


Figure SI- 35. Differential scanning calorimetry curve of copolymer **6** under a nitrogen atmosphere; sample weight: 8.4226 mg; heating rate: 10 K/min; crucible: 40 μ L aluminium; T_g : 114 °C (onset); exo up.

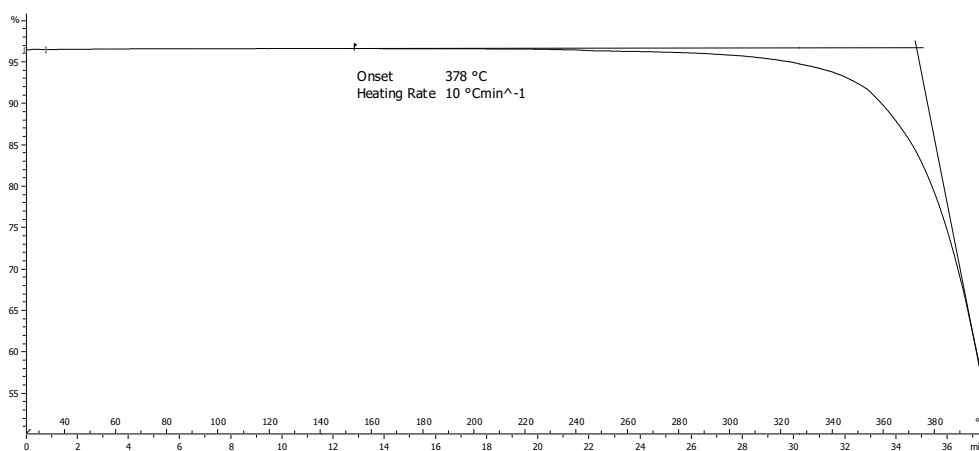
TGA

Figure SI- 36. Thermogravimetric analysis curve of copolymer **6** under nitrogen atmosphere; sample weight: 11.5770 mg; heating rate: 10 K/min; crucible: 40 μ L aluminium; T_d : 378 °C (onset).

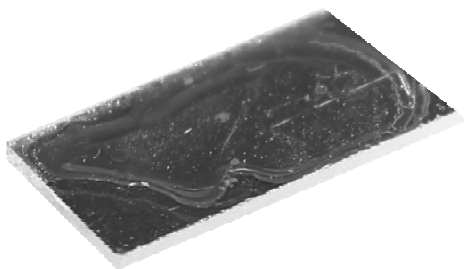
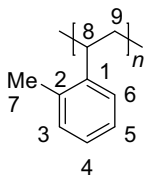
Photo

Figure SI- 37. Transparent film of copolymer **6** on a glass plate after removing the solvent from the dichloromethane solution at 40 °C under inert conditions.

Poly(2-methylstyrene) (**4**)

Under a nitrogen atmosphere, 2-vinyltoluene (306 mg, 2.5 mmol) and AIBN (4 mg, 25 μ mol, 1 mol%) were placed into a dried J. Young's tube. The mixture was transferred into a preheated oil bath (85 °C). After 4 h of heating, the mixture solidified. The solid polymer was purified by precipitation: it was dissolved in a mixture of toluene (2 mL) and ethyl acetate (0.5 mL)^f and afterwards precipitated into methanol (6 mL). The polymer was dried under reduced pressure (4×10^{-2} mbar, 40 °C oil bath) to yield poly(2-methylstyrene) (**4**) (265 mg, 87%)^g ¹H NMR (600 MHz, C₆D₆) δ 7.5-6.4 (4 H, bm, 3,4,5,6-H), 2.9-2.3 (1 H, bm, 8-H), 2.2-1.1 (5 H, bm, 7,9-H); ¹H NMR (500 MHz, CD₂Cl₂) δ 7.4-6.25 (4 H, bm, 3,4,5,6-H), 2.8-2.1 (1 H, bm, 8-H), 2.1-0.9 (5 H, bm, 7,9-H); ¹³C{¹H} NMR (151 MHz, C₆D₆) δ 144.1 (C-1), 136.6 (C-2), 130.8, 126.5, 126.0, 125.7 (C-3/4/5/6), 46.2-40.8 (C-8)^h, 35.1 (C-9), 19.1 (C-7); ¹³C{¹H} NMR (126 MHz, CD₂Cl₂) δ 143.7 (C-1), 136.6 (C-2), 130.6, 126.3, 125.8, 125.6 (C-3/4/5/6), 47.5-41.6 (C-8)^h, 34.7 (C-9), 28.8 (C-7); IR (ATR) $\nu_{\max}/\text{cm}^{-1}$ 3067, 3020, 2950, 2910, 2856, 1487, 1455, 755, 728, 452; M_w = 86000 g/mol (eluent: THF, elution at 1 mL/min, 35 °C, universal calibration); PDI = 1.84.

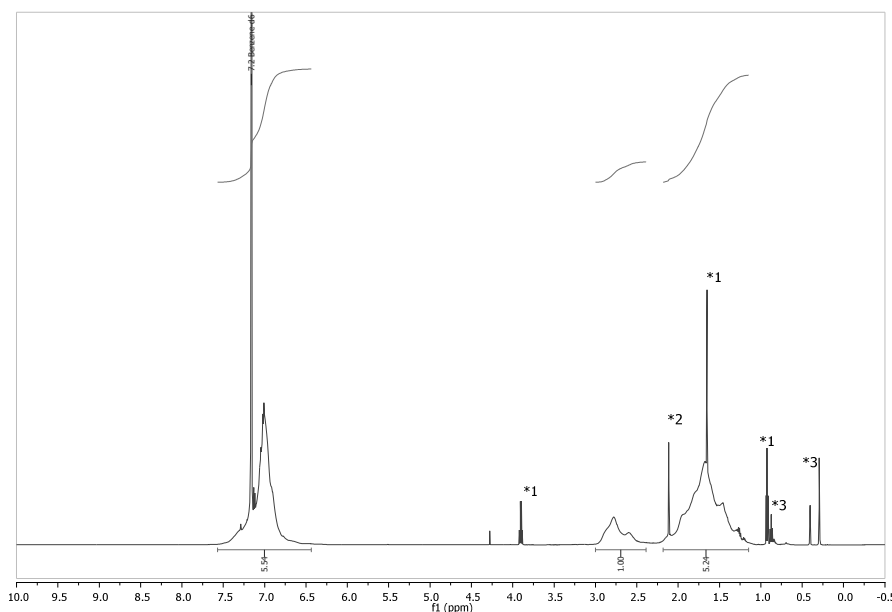


Figure SI- 38. ¹H NMR spectrum of polymer **4** in C₆D₆; trace impurities from the work-up process: *1 = ethyl acetate, *2 = toluene, *3 = unidentified signal.

^f Ethyl acetate was necessary because the polymer was poorly soluble in pure toluene.

^g The polymer could not be analysed by mass spectrometry (MALDI, ESI).

^h The signal is only visible in the HSQC spectrum (possibly too broad).

^h The signal is only visible in the HSQC spectrum (possibly too broad).

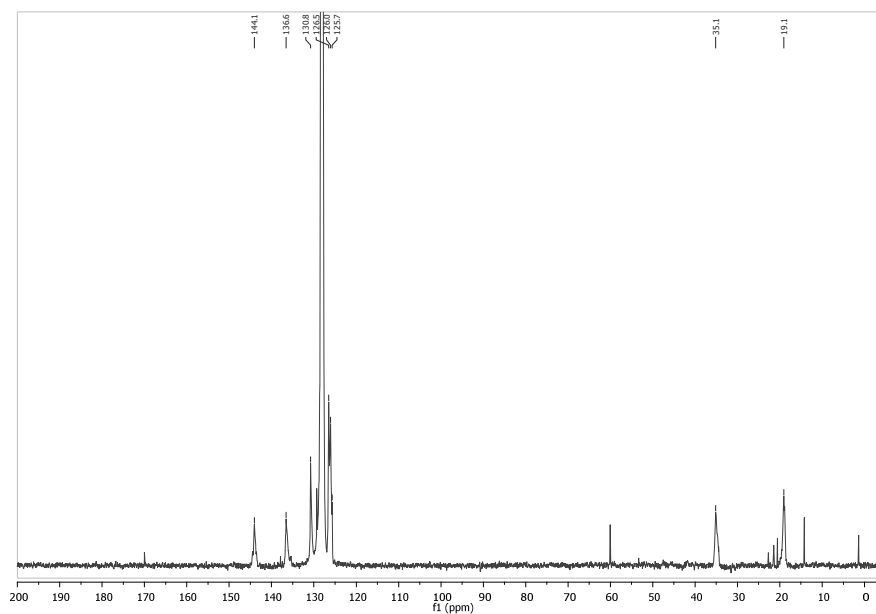


Figure SI- 39. $^{13}\text{C}\{^1\text{H}\}$ NMR spectrum of polymer 4 in C_6D_6 .

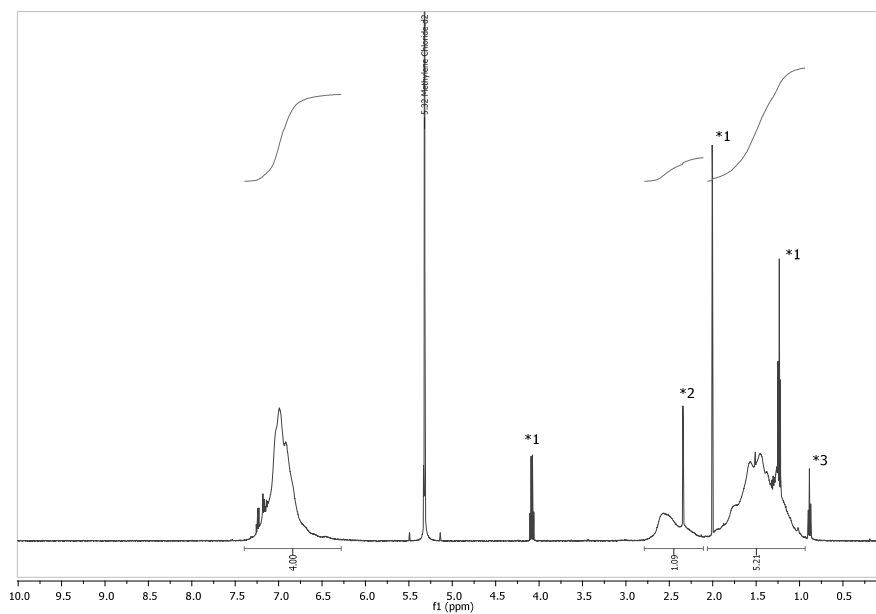


Figure SI- 40. ^1H NMR spectrum of polymer 4 in CD_2Cl_2 ; traces from precipitation process: *1 = ethyl acetate, *2 = methanol, *3 = toluene.

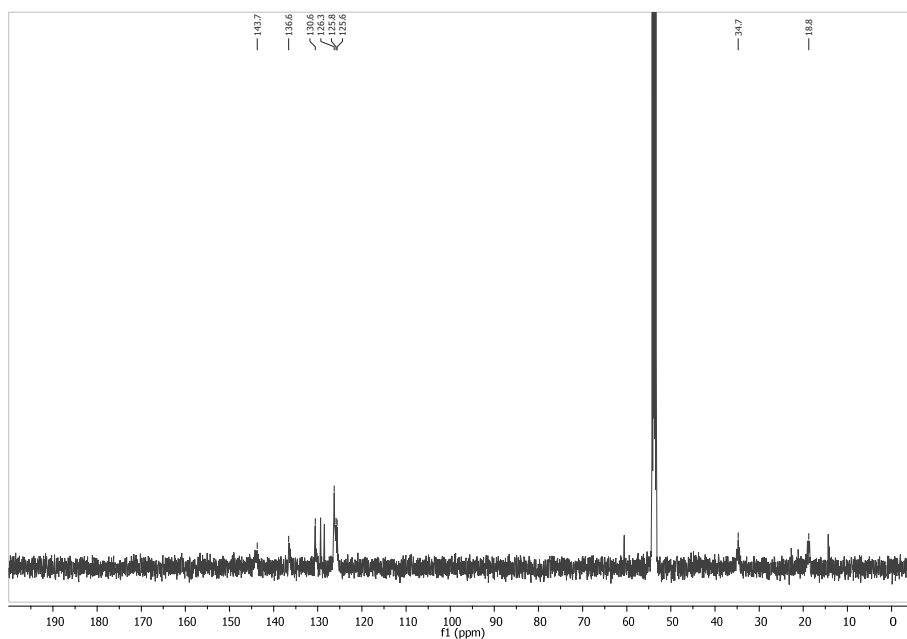


Figure SI- 41. $^{13}\text{C}\{^1\text{H}\}$ NMR spectrum of polymer **4** in CD_2Cl_2 .

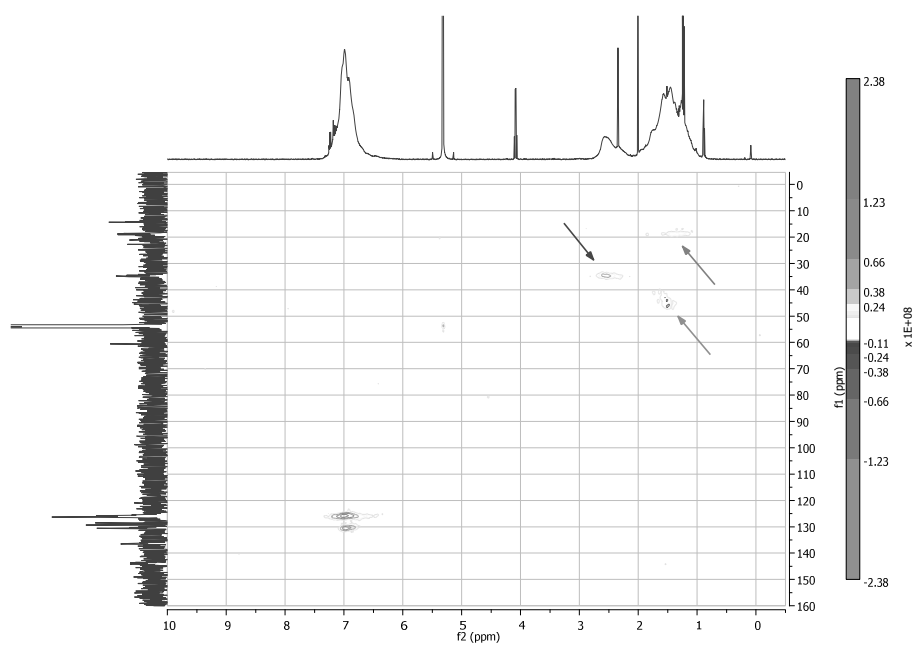


Figure SI- 42. HSQC-DEPT experiment in CD_2Cl_2 for assigning the ^1H and ^{13}C signals of polymer **4**. The signal for the *N*-methyl groups are clearly visible (red arrow); In the signal for the olefinic backbone, there is a signal for a methylene group (purple arrow) and a further signal for the CH-group (blue arrow). There is no evidence that the *N*-methyl group has reacted during the radical polymerization.

Table SI- 4. GPC results of poly(2-methylstyrene) (**4**) measured in THF; Conventional calibration was performed with polystyrene standards (narrow distribution) and a refractive index detector; Universal calibration was performed with additional on-line viscometer detection.

	Conventional Calibration	Universal Calibration
<i>M_n</i> (g/mol)	25900	46700
<i>M_w</i> (g/mol)	59800	86000
<i>PDI</i>	2.31	1.84

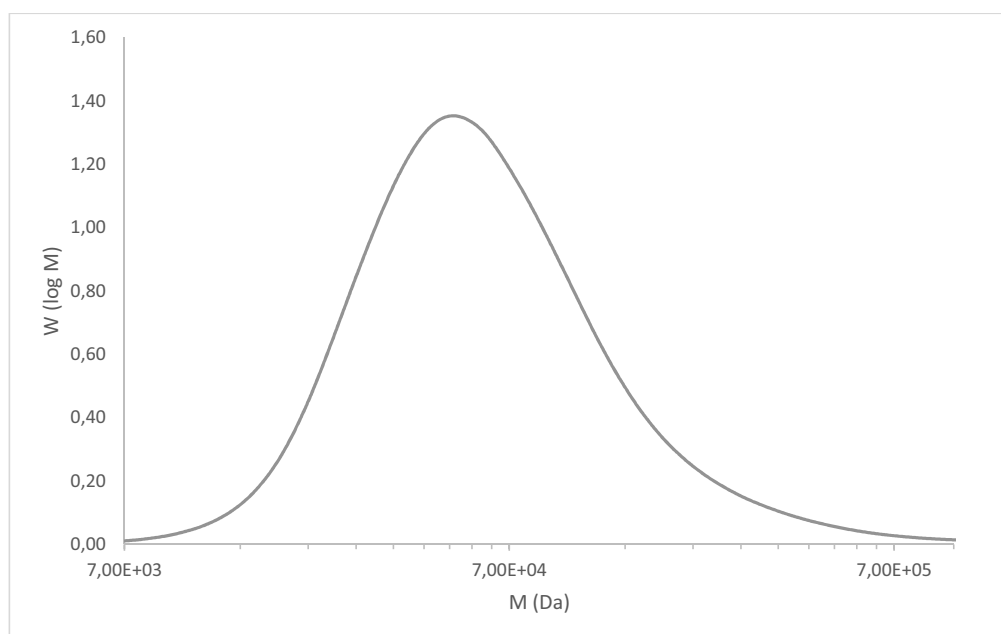


Figure SI- 43. Mass distribution curve of poly(2-methylstyrene) (**4**) (universal calibration) measured in THF.

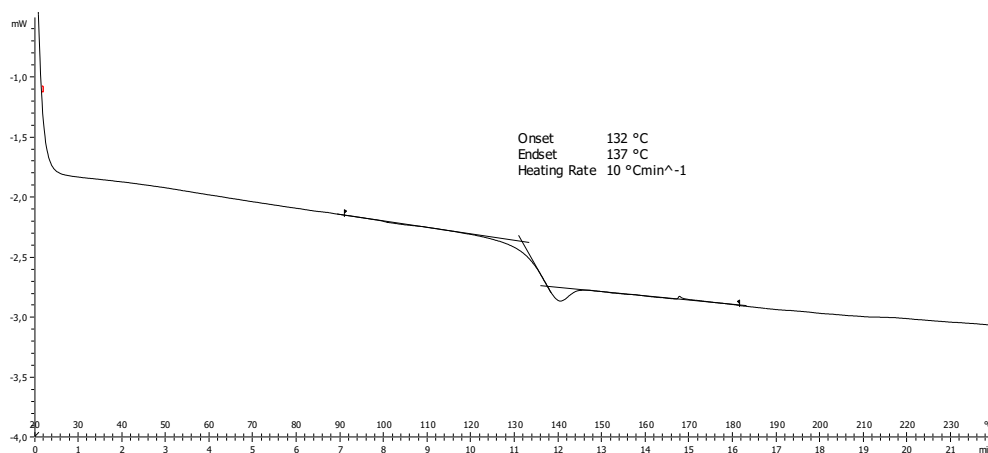
DSC

Figure SI- 44. Differential scanning calorimetry curve of poly(2-methylstyrene) (**4**) under a nitrogen atmosphere; sample weight: 8.2736 mg; heating rate: 10 K/min; crucible: 40 μ L aluminium; T_g : 132 °C (onset); exo up.

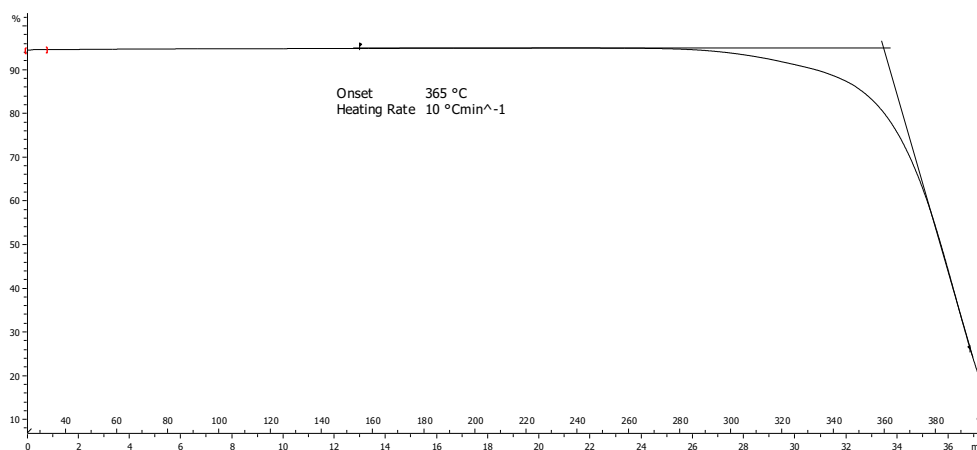
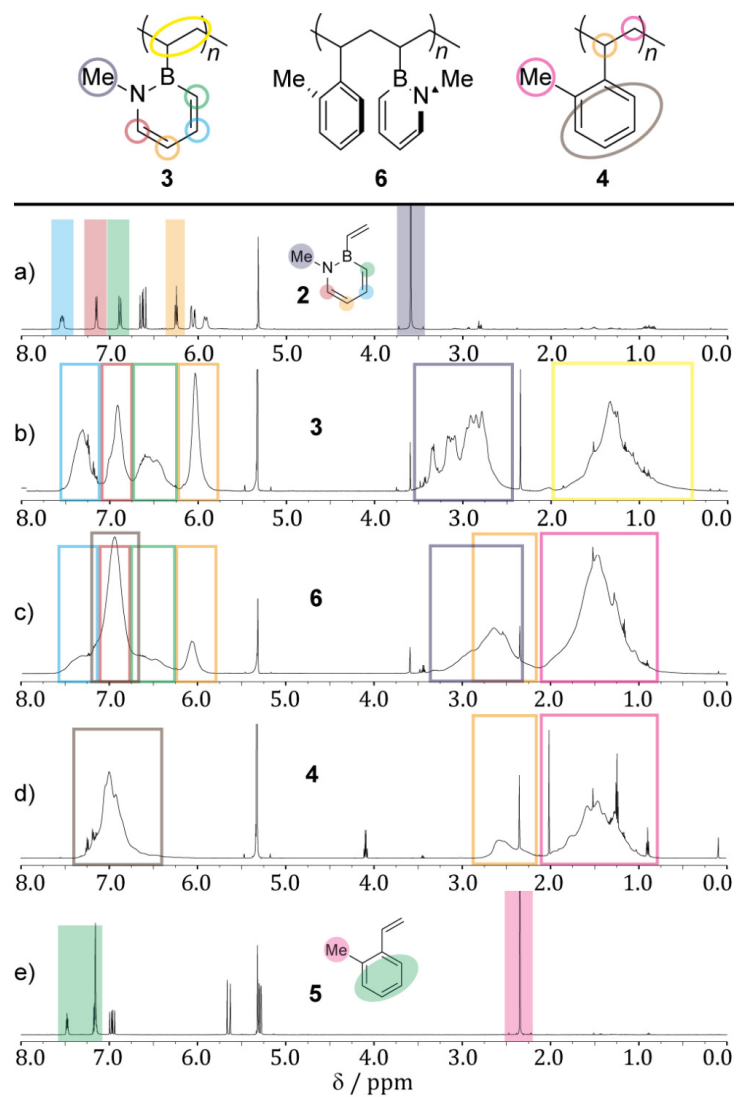
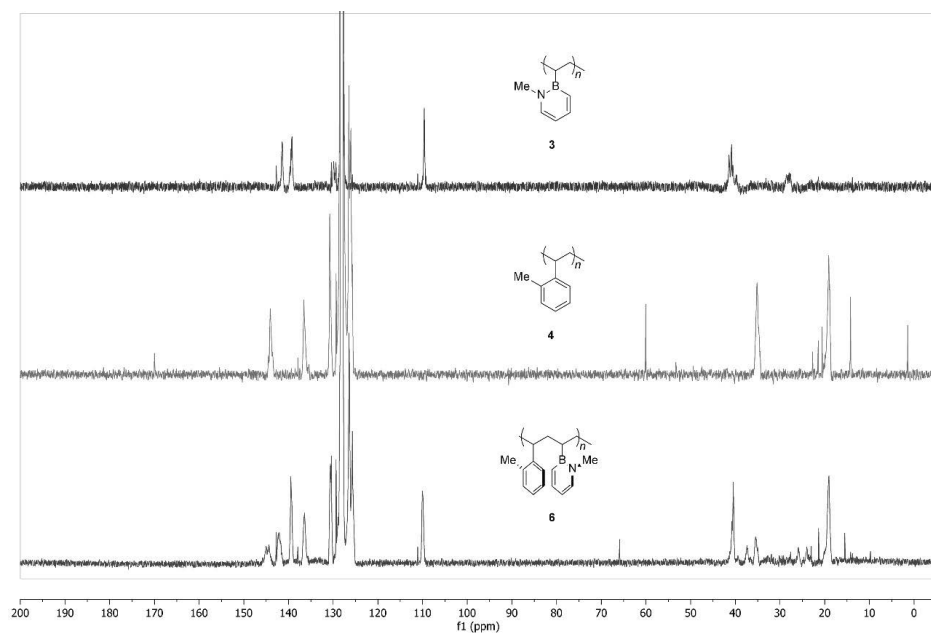
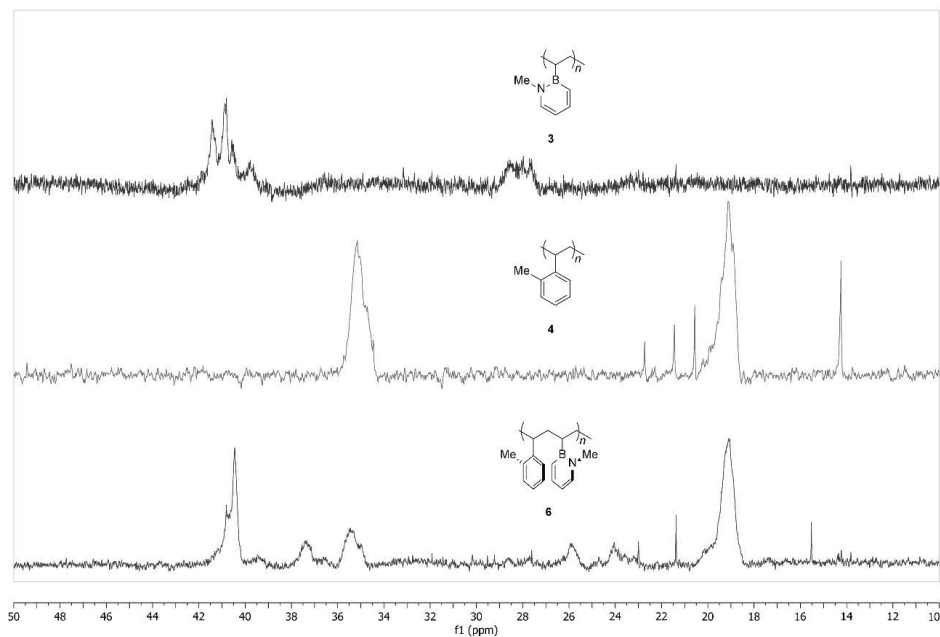
TGA

Figure SI- 45. Thermogravimetric analysis curve of poly(2-methylstyrene) (**4**) under a nitrogen atmosphere; sample weight: 7.1067 mg; heating rate: 10 K/min; crucible: 40 μ L aluminium; T_d : 365 °C (onset).

Additional Comparisons

¹H NMR comparisonFigure SI- 46. ¹H NMR comparison with signal assignment of all polymers.

$^{13}\text{C}\{^1\text{H}\}$ NMR comparison**Figure SI- 47.** Stacked $^{13}\text{C}\{^1\text{H}\}$ NMR spectra of all three synthesized polymers in C_6D_6 .**Figure SI- 48.** Section of the aliphatic range of the stacked $^{13}\text{C}\{^1\text{H}\}$ NMR of all three synthesized polymers in C_6D_6 .

IR comparison

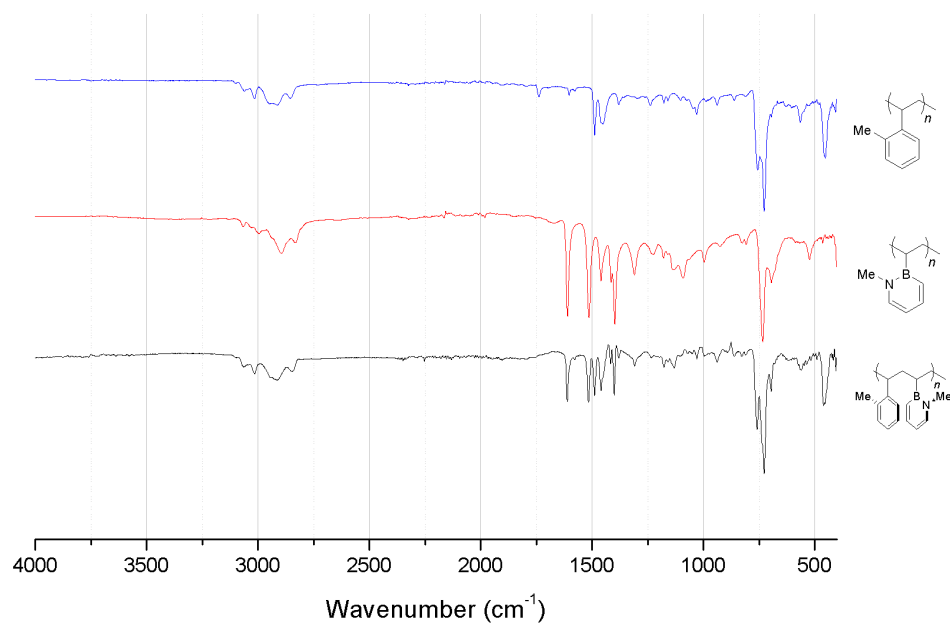


Figure SI- 49. Stacked IR spectra of the homopolymers 3, 4 and copolymer 6.

UV-vis comparison

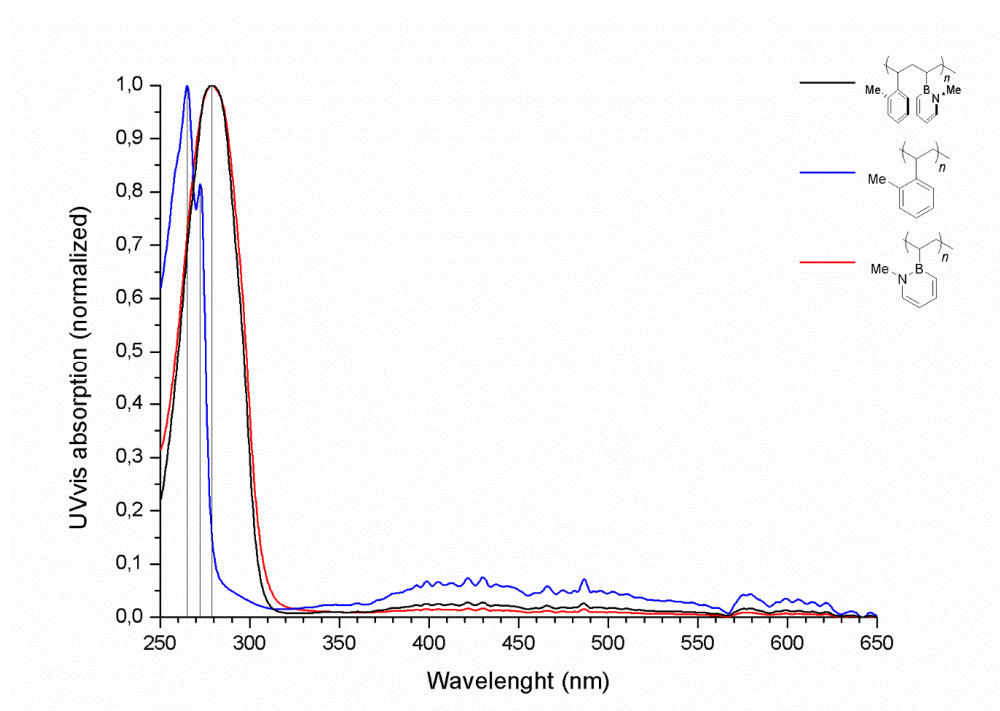


Figure SI- 50. UV-vis spectrum of all three polymers directly from GPC measurements in THF. Maxima: 279 (6, black); 265, 273 (4, blue); 279 (3, red) nm.

SI 39

SI 40



Kinetic measurements (monomer conversion control by ^1H NMR)

Monomer conversions were calculated using proton integrals of both separated monomer and polymer signals.

The reactions were set up as described for the synthesis for isolation with same scale in a glovebox (see above).

Then, at regular intervals, samples were obtained by taking a drop of the mixture with a pipette and diluted it

with CD_2Cl_2 into a J. Young's NMR tube, before ^1H NMR spectra were measured.

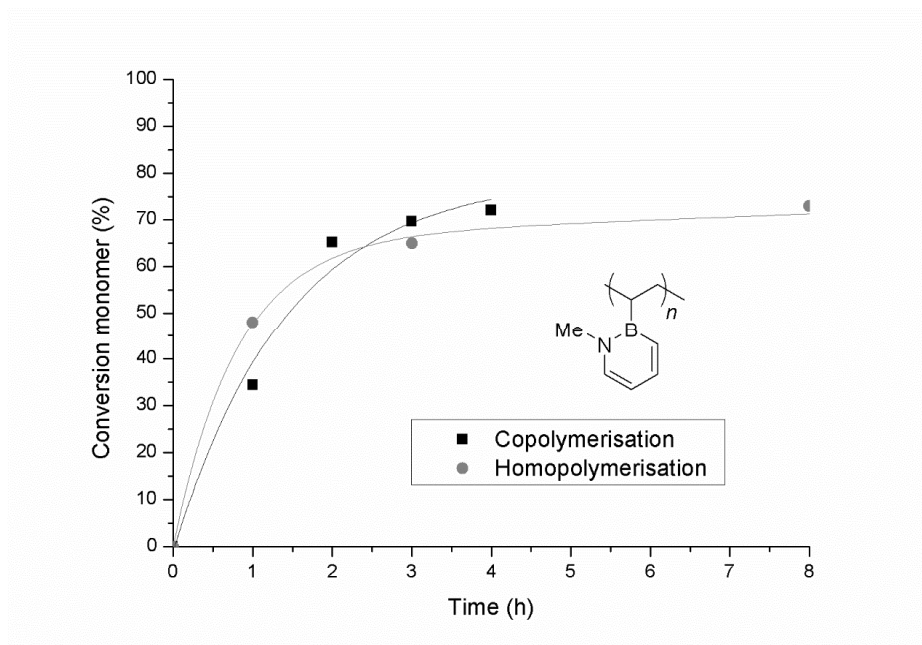


Figure SI- 51. Monomer conversion of polymerizing *N*-methyl-2-vinylazaborine (2).

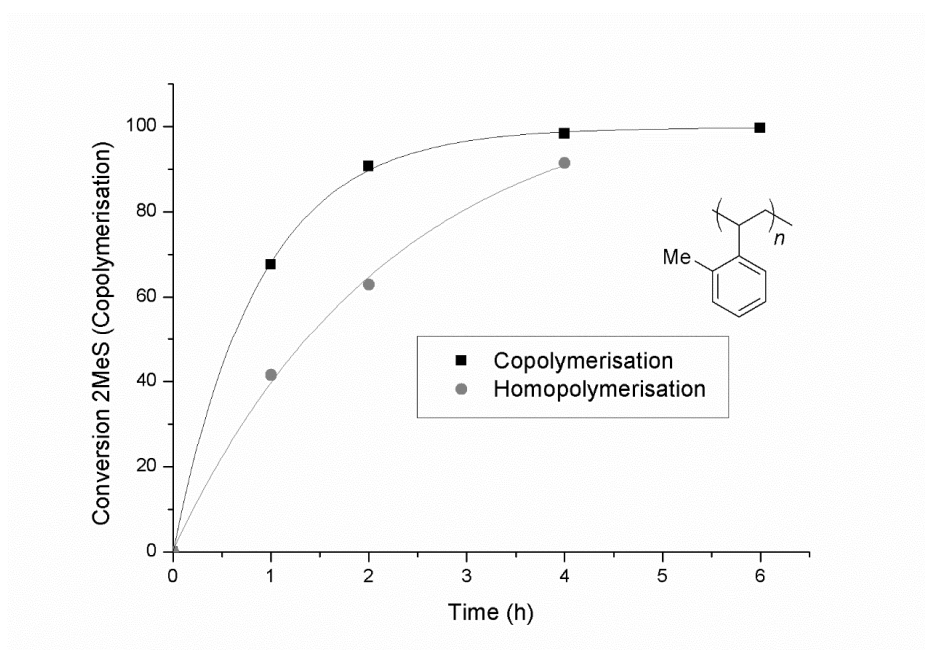


Figure SI- 52. Monomer conversion of polymerizing 2-methylstyrene (5).

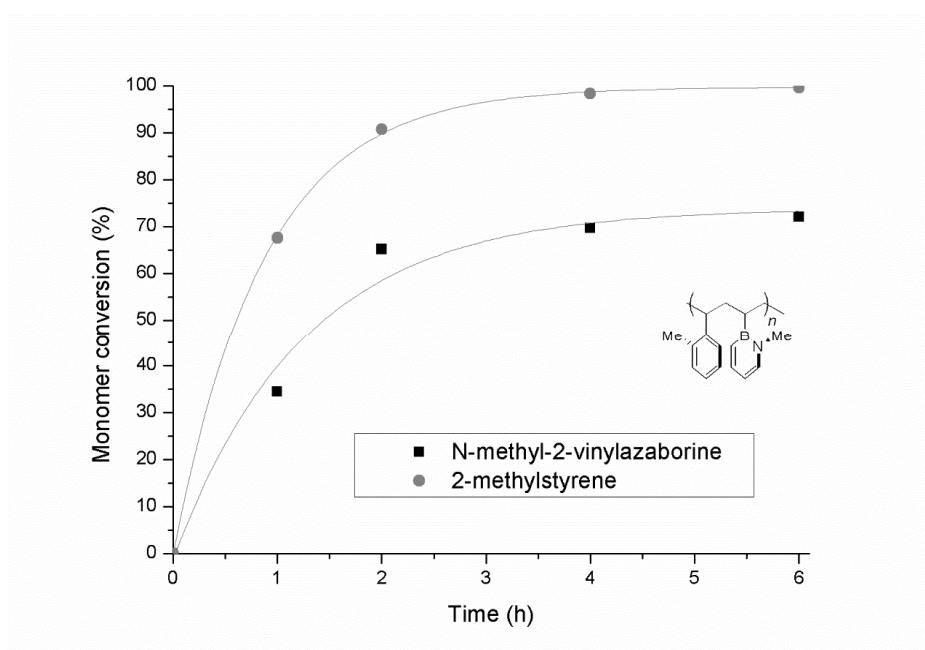
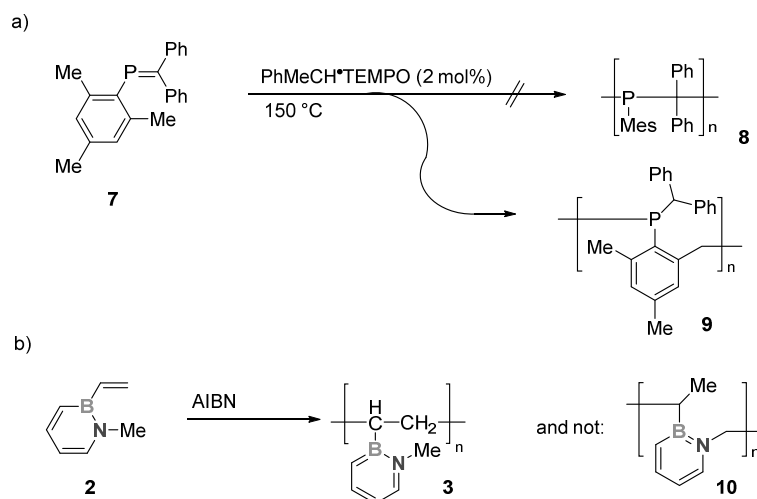


Figure SI- 53. Monomer conversions of N-methyl-2-vinylazaborine (2) and 2-methylstyrene (5) while copolymerization to polymer 6.

Discussion of a Possible Involvement of the *N*-Methyl Group in the Polymerization

Recent work by Gates and co-workers is concerned with a phosphorus analog of alkenes that could be polymerized under radical conditions.⁸⁻¹¹ A detailed analysis of the structure of the product revealed an intriguing structure of the polymer prepared by radical polymerization (**Scheme SI-1**).¹² Rather than observing a polymer chain obtained by a normal addition polymerisation (**8**), the authors found that the methyl group in *ortho* position of the mesityl group on the phosphorus was not innocent. Instead an isomerization polymerization was observed, leading to polymer **9**.



Scheme SI-1. a) Isomerization polymerization of the phosphoalkene $\text{MesP}=\text{CPh}_2$. b) Comparison with the polymerization of the azaborine **2** to give the polymer **10** was not observed.

Although the *N*-methyl group for the *N*-methylazaborine **2** is topologically in the same position, we found no evidence of the occurrence of **10**. Firstly, the methyl group in **10** should be quite distinctive from that in **3** by an upfield shift as it is no longer under the shielding influence of the nitrogen. This is not the case; the methyl groups appear between ca. 2.5 to 3.5 ppm (in CD_2Cl_2). In this region of the spectrum, we would then expect a methylene group for **10**. The HSQC-DEPT experiment however (**Figure SI-23**) shows no such signal whatsoever.

The integrations of the peaks are naturally imprecise due to their broadness and also due to remaining trace impurities. However, all other NMR experiments that were performed uniformly support the hypothesis that **3** was formed.

Polymer **9** remains a unique phenomenon.

Abbreviations

FPT	Freeze, Pump & Thaw
Et₃N	Triethylamine
CH₂Cl₂	Dichloromethane
CD₂Cl₂	Deuterated dichloromethane
C₆D₆	Deuterated benzene
Et₂O	Diethyl ether
IR	Infrared spectroscopy
NMR	Nuclear magnetic resonance spectroscopy
Pd	Palladium
T_g	Glass transition temperature
T_d	Decomposition temperature

Literature

- (1) Brown, H. C.; Racherla, U. S. *J. Org. Chem.* **1986**, *51*, 427.
- (2) Lamm, A. N.; Garner, E. B.; Dixon, D. A.; Liu, S. Y. *Angew. Chem. Int. Ed.* **2011**, *50*, 8157.
- (3) We recently published a procedure for the preparation of allylamines: Thiedemann, B.; Schmitz, C. L. M.; Staubitz, A. *J. Org. Chem.* **2014**, *79*, 10284. However, for *N*-methylallylamine, this procedure cannot be used because of fragmentation of the product.
- (4) Chrostowska, A.; Xu, S.; Lamm, A. N.; Mazière, A.; Weber, C. D.; Dargelos, A.; Baylère, P.; Graciaa, A.; Liu, S.-Y. *J. Am. Chem. Soc.* **2012**, *134*, 10279.
- (5) Seyferth, D.; Weiner, M. A. *J. Am. Chem. Soc.* **1961**, *83*, 3583.
- (6) Lin, H. S.; Paquette, L. A. *Synth. Commun.* **1994**, *24*, 2503.
- (7) Marwitz, A. J. V.; Abbey, E. R.; Jenkins, J. T.; Zakharov, L. N.; Liu, S. Y. *Org. Lett.* **2007**, *9*, 4905.
- (8) Bates, J. I.; Dugal-Tessier, J.; Gates, D. P. *Dalton Trans.* **2010**, *39*, 3151.
- (9) Tsang, C. W.; Baharloo, B.; Riendl, D.; Yam, M.; Gates, D. P. *Angew. Chem. Int. Ed.* **2004**, *43*, 5682.
- (10) Tsang, C.-W.; Baharloo, B.; Riendl, D.; Yam, M.; Gates, D. P. *Angew. Chem.* **2004**, *116*, 5800.
- (11) Tsang, C. W.; Yam, M.; Gates, D. P. *J. Am. Chem. Soc.* **2003**, *125*, 1480.
- (12) Siu, P. W.; Serin, S. C.; Kruppenacher, I.; Hey, T. W.; Gates, D. P. *Angew. Chem. Int. Ed.* **2013**, *52*, 6967.

5.4 Supporting Information on Chapter 3.4

5.4.1 Supporting Information for *Eur. J. Org. Chem.* 2015, 2498.

Eur. J. Org. Chem. 2015 · ISSN 1099–0690

SUPPORTING INFORMATION

DOI: 10.1002/ejoc.201500138

Title: Nucleophile-Selective Cross-Coupling Reactions with Vinyl and Alkynyl Bromides on a Dinucleophilic Aromatic Substrate

Author(s): Lu-Ying He, Mathias Schulz-Senft, Birk Thiedemann, Julian Linshoef, Paul J. Gates, Anne Staubitz*

Table of Contents

Abbreviations	2
General Methods and Materials.....	3
GC Optimization Reactions.....	6
Syntheses	10
NMR Spectra.....	31
References.....	73

Abbreviations

A	area
anhyd.	anhydrous
Ar	aryl
ATR	attenuated total reflectance
calcd.	calculated
CI	chemical ionization
COSY	correlated spectroscopy
d	doublet (NMR)
DEPT	distortionless enhancement by polarization transfer
DMF	<i>N,N</i> -dimethylformamide
dppe	1,2- <i>bis</i> (diphenylphosphino)ethane
dppf	1,1'- <i>bis</i> (diphenylphosphino)ferrocene
EI	electron ionization
GC	gas chromatography
GC-MS	gas chromatography-mass spectrometry
HSQC	heteronuclear single quantum coherence
HPLC	high-performance liquid chromatography
IR	infrared
m	medium (concerning the intensity) (IR)
m	multiplet (NMR)
M.p.	melting point
MS	mass spectrometry
MW	microwave
n	amount of substance
NBS	<i>N</i> -bromosuccinimide
NMR	nuclear magnetic resonance
Pin	pinacol
RF	response factor
R _f	retardation factor
s	strong (concerning the intensity) (IR)
s	singlet (NMR)
SPhos	2-dicyclohexylphosphino-2',6'-dimethoxybiphenyl
t	triplet (NMR)
THF	tetrahydrofuran
TMEDA	<i>N,N,N,N</i> -tetramethylethylenediamine
TMS	tetramethylsilane
w	weak (concerning the intensity) (IR)

General Methods and Materials

All syntheses were carried out using standard Schlenk techniques or in glovebox under a dry and inert nitrogen atmosphere unless stated otherwise. Glassware and NMR-tubes were dried in an oven at 200 °C for at least 2 h prior to use. Reaction vessels were heated under vacuum and purged with nitrogen three times before adding reagents.

Analyses

¹H NMR, ¹³C NMR, ¹¹B NMR and ¹¹⁹Sn NMR spectra were recorded at 300 K. ¹H NMR spectra were recorded on a Bruker DRX500 (500 MHz) spectrometer or Bruker Avance 600 (600 MHz) spectrometer. ¹³C NMR spectra were recorded on a Bruker DRX 500 (125 MHz) spectrometer or Bruker Avance 600 (150 MHz) spectrometer. ¹¹B NMR and ¹¹⁹Sn NMR spectra were recorded on a Bruker DRX 500 (160 MHz) spectrometer. All ¹H NMR and ¹³C NMR spectra were referenced against the residual solvent peak. ¹¹B NMR spectra were referenced against BF₃·OEt₂ in CDCl₃, the reference of the ¹¹⁹Sn NMR spectra was calculated based on the ¹H NMR signal of TMS. ²⁹Si NMR spectra were recorded on a Bruker DRX 500 (99 MHz) spectrometer and the reference was calculated based on the ¹H NMR signals of CHCl₃.

The exact assignment of the peaks was proven by ¹H, ¹³C DEPT and two-dimensional NMR spectroscopy such as ¹H COSY, ¹H/¹³C HSQC or ¹H/¹³C HMBC when possible.

IR spectra were recorded on a Perkin Elmer Paragon 1000 FT-IR spectrometer with a A531-G Golden-Gate-ATR-unit. Ultra High resolution ESI mass spectra were recorded on a Bruker Daltonics Apex IV Fourier transform Ion Cyclotron resonance mass spectrometer. The high resolution EI mass spectra were run on a VG Analytical Autospec apparatus.

All melting points were recorded on a LG1586 Electrothermal® IA6304 capillary melting point and are uncorrected.

GC-MS analysis was performed on a Hewlett Packard 5890A gas chromatograph, equipped with a Hewlett Packard 5972A mass selective detector (EI at 70 eV) and an Agilent Technologies dimethylpolysiloxane column (19091S-931E, nominal length 15 m, 0.25 mm diameter, 0.25 µm grain size). Helium was used as the carrier gas.

GC analysis was performed on an Agilent Technologies 6890N gas chromatograph, equipped with an Agilent Technologies 7683 Series Injector, an Agilent Technologies (5 %-phenyl)-methylpolysiloxane column (19091J-413, nominal length 30 m, 0.32 mm diameter, 0.25 µm grain size) and a flame ionization detector (FID). Nitrogen was used as the carrier gas.

Reactions under microwave irradiation were carried out using a Biotage® Initiator + SP Wave synthesis system, with continuous irradiation power from 0 to 400 W (Organic Synthesis Mode). The temperature was measured with an external IR sensor during microwave heating. All reactions were carried out in 2 mL oven-dried Biotage microwave vials sealed with an aluminum/Teflon® crimp top, which can be exposed to a maximum of 250 °C and 20 bar internal pressure.

Chemicals

All reagents were used without further purification unless noted otherwise.

Compound	Supplier	Purity	Comment
(Bromomethyl)triphenylphosphonium bromide	Sigma-Aldrich Inc.	98%	
(<i>E</i>)-3-(3-Pyridyl)acrylic acid	Alfa Aesar Inc.	98%	
(<i>E</i>)-4-Nitrocinnamic acid	Alfa Aesar Inc.	98%	
[Pd(dppe)Cl ₂]	Strem Chemicals Inc.	98%	
[Pd(dppf)Cl ₂]	Sigma-Aldrich Inc.	>98%	
[Pd(OAc) ₂]	Strem Chemicals Inc.	>98%	
[Pd(PPh ₃) ₄]	ABCR Inc.	99%	
[Pd(PtBu ₃) ₂]	Strem Chemicals Inc.	>98%	
1,3,5-Triisopropylbenzene	Alfa Aesar Inc.	96%	distilled
1-Bromo-4-iodobenzene	Fluka Inc	≥ 97%	
2,5-Dibromothiophene	Alfa Aesar Inc.	95%	
3-(2-Thienyl)acrylic acid	Alfa Aesar Inc.	99%	
3,4-(Methylenedioxy)cinnamic acid	Alfa Aesar Inc.	98%	

5 Experimental Section

3-Pyridinecarboxaldehyde	Sigma-Aldrich Inc.	97% (GC)	
4-Cyanobenzaldehyde	Alfa Aesar Inc.	97%	
4-Dimethylaminobenzaldehyde	Alfa Aesar Inc.	98%	
4-Methoxycinnamic acid	ABCR Inc.	98%	
4-Methyl-2-pentenoic acid	Alfa Aesar Inc.	98+%	
4-Methylcinnamic acid	ABCR Inc.	99%	
AgNO ₃	Merck Inc.	99.9%	
Ammonium chloride	Grüssing Inc.	99.5%	
Benzyl bromide	TCI Inc.	98% (GC)	
Bromine	Acros Inc.	99.99%	
β-Bromostyrene	Alfa Aesar Inc.	96%	distilled
n-Butyllithium	Acros Inc.	2.5 M in nhexane	
n-Butylmagnesium chloride	Fischer Scientific Inc.	20 wt% in THF/Toluene	
Cyclohexanecarboxaldehyde	Alfa Aesar Inc.	99%	
Ethynyltrimethylsilane	Sigma-Aldrich Inc.	98%	
Iodosobenzene diacetate	Alfa Aesar Inc.	98%	
Isopropylmagnesium chloride	Sigma-Aldrich Inc.	2.0 M in THF	
Magnesium sulfate	Grüssing Inc.	99%	
Malonic acid	Alfa Aesar Inc.	98%	
α-Methylcinnamic acid	Alfa Aesar Inc.	97%	
Methylolithium	Acros Inc.	1.6 M in diethyl ether	
NBS	Sigma-Aldrich Inc.	99%	
Octyne	Fluka Inc.	>98%	
α-Phenylcinnamic acid	Alfa Aesar Inc.	98%	
Pinacol	ABCR Inc.	99%	
Potassium carbonate	AppliChem GmbH	Pure Ph. Eur., USP	
Potassium t-butoxide	Acros Inc.	97%	
Propargyl alcohol	Alfa Aesar Inc.	99%	
Propargyl benzoate	VWR Inc.	98%	
Sodium	Merck Inc.	≥ 99%	
Sodium chloride	Grüssing Inc.	99.5%	
Sodium hydrid	Merck Inc.	60% in mineral oil	
Sodium sulfate	Grüssing Inc.	99%	
SPhos	Strem Chemicals Inc.	>98%	
Tetraethylammonium bromide	Alfa Aesar Inc.	99%	
Thiophene	VWR Inc.	99%	distilled
TMEDA	Acros Inc.	99.5%	
Triethylamine	Acros Inc.	99%	distilled from CaH ₂
Triisopropyl borate	Strem Chemicals Inc.	>98%	
Trimethyltin chloride	Acros Inc.	99%	

Solvents

All solvents for reactions were used freshly distilled after refluxing for several hours over the specified drying agent under nitrogen and were stored in a J. Young's tube. If no drying agent is noted, the solvents were used for chromatography only and distilled for purification purposes.

Solvent	Supplier or grade before distillation, drying procedure if applicable
Acetone	BCD, technical grade, not distilled
Acetonitrile	Sigma Aldrich, HPLC-grade; Degassed by three freeze-pump-thaw cycles, stored over 3 Å

	molecular sieves
Cyclohexane	BCD, technical grade
DCM	BCD, technical grade, Dried over phosphorus pentoxide, stored over 3 Å molecular sieves
Diethyl ether	BCD, technical grade
Dioxane	Grüssing; Dried over sodium with benzophenone as an indicator; Degassed by three freeze-pump-thaw cycles, stored over 3 Å molecular sieves
DMF	ABCR, anhydrous, amine free; 99.9%; contained molecular sieves
Ethyl acetate	BCD, technical grade
<i>n</i> hexane	WALTER CMP, technical grade; Dried over sodium with benzophenone as an indicator; stored over 3 Å molecular sieves
<i>n</i> pentane	WALTER CMP, technical grade
Pyridine	Sigma Aldrich; Dried over calcium hydride; Degassed by three freeze-pump-thaw cycles, stored over 3 Å molecular sieves
THF	Sigma Aldrich; Dried over LiAlH ₄ with benzophenone as an indicator; Degassed by three freeze-pump-thaw cycles, stored over 3 Å molecular sieves
Toluene	Sigma Aldrich, anhydrous, 99.9 %

Chromatography

For chromatographic purifications, silica gel (Macherey-Nagel Inc., grain size 0.040 - 0.063 mm) was used. Thin layer chromatography was performed using pre-coated plates from Macherey-Nagel Inc., ALUGRAM®Xtra SIL G/UV254. Chromatographic purification for compounds (**2a-2d**, **2f**, **2i-2k**, **3a-3c**, **3i**, **3j**, **6e**, **6f**, **7d**, **7e**, **8a**, **8b**, **8c**, **8d**) were carried out using an InterchimPuriflash 430 system, in which cartridges by Interchim (silica HC, grain size 50 µm, 40 g, 80 g or 120 g) were used.

GC Optimization Reactions

The yields for the optimization reactions were determined by GC by a multiple point internal standard method, using 1,3,5-triisopropylbenzene as a standard. The following equation was used for the calculation of the yields for substance **3a**, **4** and **5**.

$$n(\text{analyte}) = \frac{A(\text{analyte})}{A(\text{standard})} \times \frac{n(\text{standard})}{RF}$$

Where n is the amount of substance, A is the integrated area and RF is a system specific response factor. For the calibration curve, known amounts of the analyte and 1,3,5-triisopropylbenzene were used. The response factor RF was obtained from the slope of the resulting calibration curve (Figures SI 1, SI 3 and SI 4).

For substance **3a'**, the yield for the optimization reactions was determined by GC and NMR because it could not be isolated. The GC and NMR were measured at the same time. First, the amount of substance **3a** was calculated from the known RF and then the amount of substance **3a'** was calculated based on the ratio of **3a'** and **3a** which was obtained from the NMR measurement. The following equation was used for the calculation of the amount of substance **3a'**. The yields for substance **3a'** were calculated by the last equation like substance **3a**, **4** and **5**. The response factor RF was obtained from the slope of the resulting calibration curve (Figure SI 2).

$$n(3b) = r \times \frac{A(3a)}{A(\text{standard})} \times \frac{n(\text{standard})}{1.1291}$$

Where r is the ratio between the amount of substance **3a'** and **3a**.

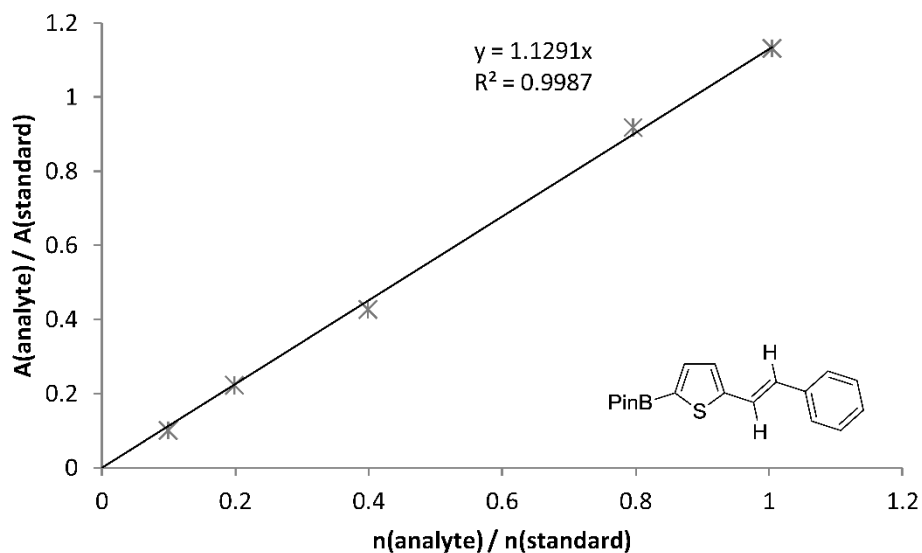


Figure SI 1. Calibration curve for (*E*)-4,4,5,5-tetramethyl-2-(5-styryl)thiophene-2-yl)-1,3,2-dioxaborolane **3a**, using 1,3,5-triisopropylbenzene as an internal standard.

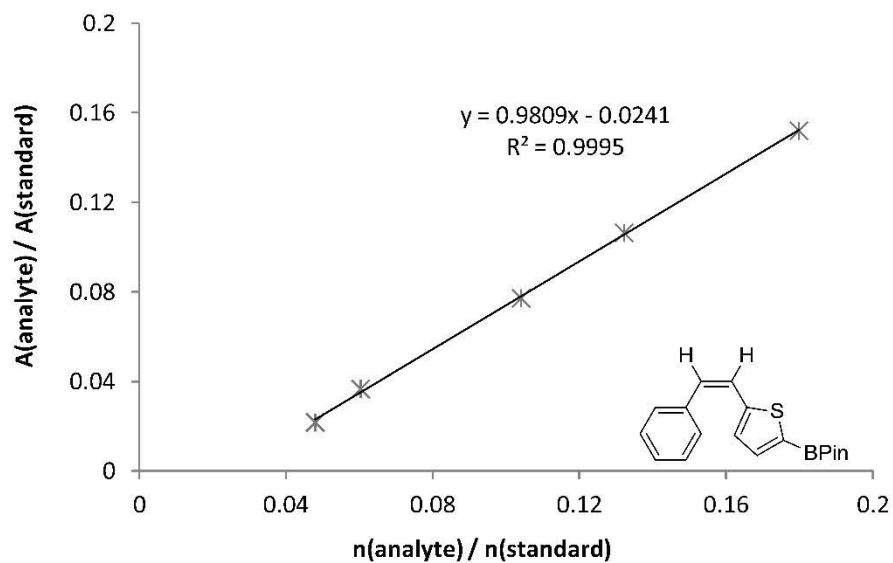


Figure SI 2. Calibration curve for Z-4,4,5,5-tetramethyl-2-(5-styryl)thiophene-2-yl)-1,3,2-dioxaborolane **3a'**, using 1,3,5-triisopropylbenzene as an internal standard.¹

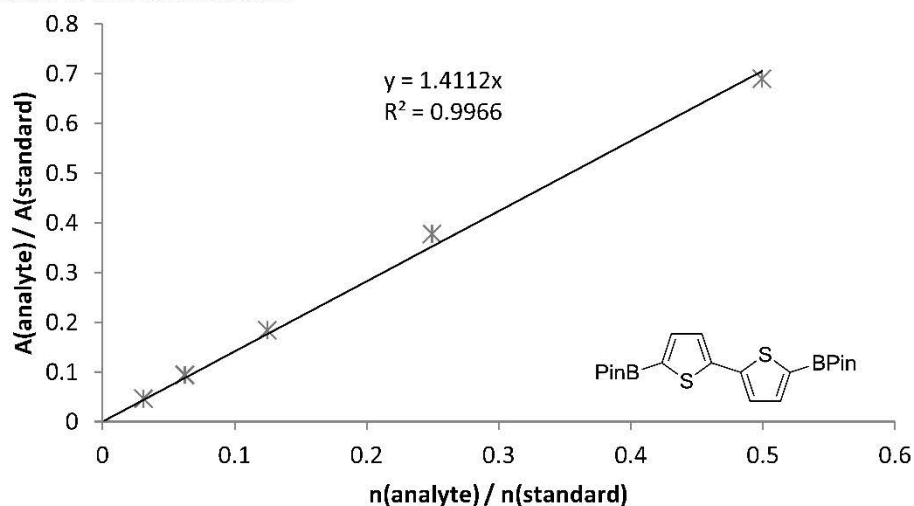


Figure SI 3. Calibration curve for 5,5'-bis(4,4,5,5-tetramethyl-1,3,2-dioxaborolan-2-yl)-2,2'-bithiophene **4** using 1,3,5-triisopropylbenzene as an internal standard.

¹The standard line does not go through 0: because of the indirect determination of the Z product, the errors for each individual measurement are higher than for the other compounds (**3a**, **4** and **5**), which were calibrated directly.

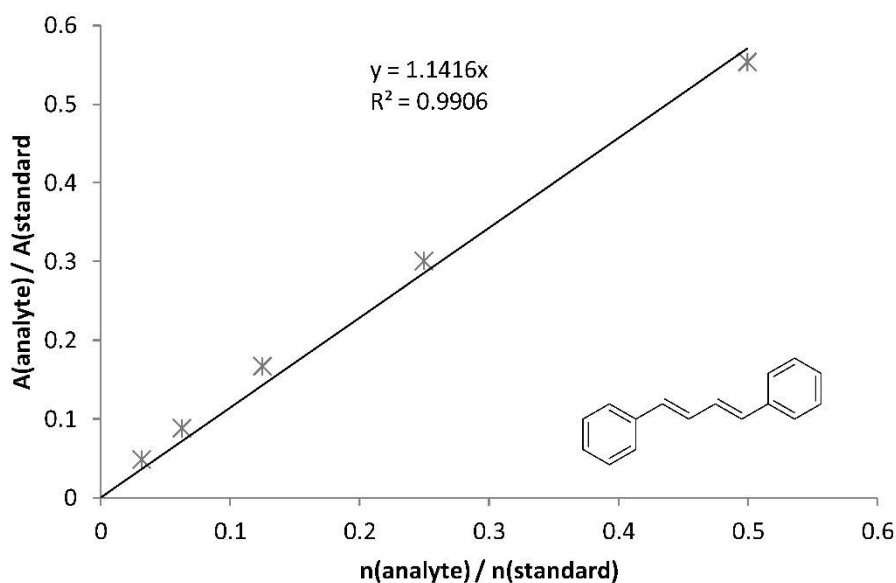


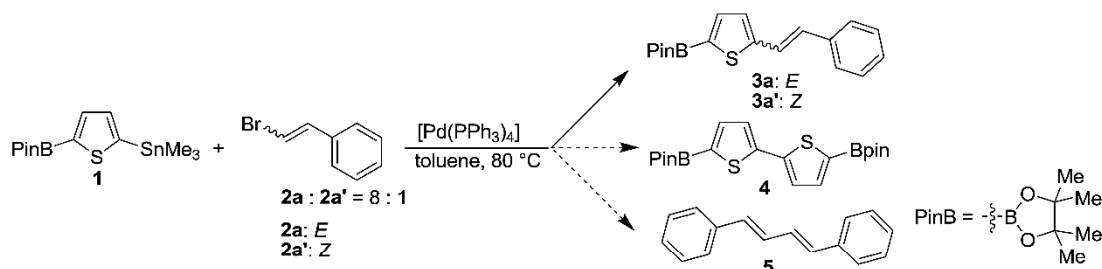
Figure SI 4. Calibration curve for 1,4-diphenylbuta-1,3-diene **5** using 1,3,5-triisopropylbenzene as an internal standard.

General procedure for the optimization reactions:

A solution of **1** (205 mg, 0.550 mmol), β -bromostyrene ($E/Z = 8/1$) (91 mg, 0.50 mmol), the catalyst (1-10 mol%) and the internal standard 1,3,5-triisopropylbenzene (100 μ L, 84.5 mg, 414 μ mol) was heated to the required temperature for the specified time, in the specified solvents (1-4 mL) (Table SI 1). After certain time intervals, a sample (0.2 mL) was taken from each reaction vessel and diluted with of CHCl_3 (10 mL). About 2 mL was filtered through a short plug of silica (5 x 3 mm) using a syringe filter and then used for GC analysis.

For all specific reaction conditions, the parameters are shown in Table SI 1.

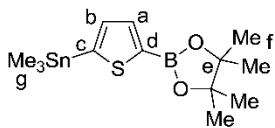
Table SI 1. Optimization reactions for the synthesis of **3a** and **3a'**.



entry	solvent / mL	catalyst	loading [mol%]	T [°C]	t [h]	conversion [%]	yield [%]
							3a : 3a' : 4 : 5
1	Dioxane / 4	[Pd(PPh ₃) ₄]	5	60	17	83	51:5:3:0
2	DMF / 4	[Pd(PPh ₃) ₄]	5	60	17	100	83:12:2:0
3	Toluene / 4	[Pd(PPh ₃) ₄]	5	60	17	91	59:7:9:6
4	THF / 4	[Pd(PPh ₃) ₄]	5	60	17	94	73:8:6:3
5	Pyridine / 4	[Pd(PPh ₃) ₄]	5	60	17	93	37:3:16:14
6	Acetonitrile / 4	[Pd(PPh ₃) ₄]	5	60	17	100	43:10:22:14
7	Dioxane / 4	[Pd(PPh ₃) ₄]	5	65	17	91	67:1:3:0
8	Dioxane / 4	[Pd(PPh ₃) ₄]	5	65	26	95	72:3:3:0
9	Toluene / 4	[Pd(PPh ₃) ₄]	5	65	17	96	54:5:8:5
10	Toluene / 4	[Pd(PPh ₃) ₄]	5	65	26	100	57:9:8:6
11	THF / 4	[Pd(PPh ₃) ₄]	5	65	17	100	62:7:5:3

12	THF / 4	[Pd(PPh ₃) ₄]	5	65	26	100	65:10:5:4
13	DMF / 4	[Pd(dppe)Cl ₂]	5	60	16	100	23:2:16:8
14	DMF / 4	[Pd(OAc) ₂]/ SPhos	5 10	60	16	100	23:7:26:13
15	DMF / 4	[Pd(dppf)Cl ₂]	5	60	16	100	43:3:9:4
16	DMF / 4	[Pd(PtBu ₃) ₂]	5	60	16	100	35:4:4:1
17	DMF / 4	[Pd(PPh ₃) ₄]	2.5	60	16	100	81:12:2:0
18	DMF / 4	[Pd(PPh ₃) ₄]	1	60	17	100	86:11:2:0
19	DMF / 4	[Pd(PPh ₃) ₄]	1	60	6	100	78:9:2:0
20	DMF / 4	[Pd(PPh ₃) ₄]	5	40	17	97	87:5:1:0
21	DMF / 4	[Pd(PPh ₃) ₄]	5	40	22	98	78:6:1:0
22	DMF / 2	[Pd(PPh ₃) ₄]	5	40	17	97	80:5:1:0
23	DMF / 2	[Pd(PPh ₃) ₄]	5	40	22	98	83:6:1:0
24	DMF / 1	[Pd(PPh ₃) ₄]	5	40	17	97	87:6:1:0
25	DMF / 1	[Pd(PPh ₃) ₄]	5	40	22	97	78:7:1:0
26	DMF / 4	[Pd(PPh ₃) ₄]	2	40	17	95	86:5:1:0
27	DMF / 4	[Pd(PPh ₃) ₄]	2	40	20	97	92:5:1:0
28	DMF / 4	[Pd(PPh ₃) ₄]	2	40	26	98	87:6:1:0
29	DMF / 4	[Pd(PPh ₃) ₄]	2	40	41	>99	92:9:1:0
30	DMF / 2	[Pd(PPh ₃) ₄]	1	40	17	96	86:4:1:0
31	DMF / 2	[Pd(PPh ₃) ₄]	1	40	20	96	88:5:1:0
32	DMF / 2	[Pd(PPh ₃) ₄]	1	40	26	97	90:7:1:0
33	DMF / 2	[Pd(PPh ₃) ₄]	1	40	41	>99	93:9:1:0
34	DMF / 2	[Pd(PPh ₃) ₄]	5	20	17	40	12:0:1:0
35	DMF / 2	[Pd(PPh ₃) ₄]	5	20	41	93	77:1:2:0
36	DMF / 2	[Pd(PPh ₃) ₄]	5	20	65	93	70:1:4:0
37	DMF / 2	[Pd(PPh ₃) ₄]	10	20	17	38	7:0:0:0
38	DMF / 2	[Pd(PPh ₃) ₄]	10	20	41	50	18:0:1:0
39	DMF / 2	[Pd(PPh ₃) ₄]	10	20	65	92	64:1:2:0
40	THF / 4	[Pd(OAc) ₂]/ SPhos	5 10	60	16	100	10:4:37:35
41	THF / 4	[Pd(PtBu ₃) ₂]	5	60	16	100	25:1:21:24
42	Dioxane / 4	[Pd(OAc) ₂]/ SPhos	5 10	60	16	100	10:5:39:35
43	Dioxane / 4	[Pd(PtBu ₃) ₂]	5	60	16	100	34:2:15:19
44	Toluene / 4	[Pd(PtBu ₃) ₂]	5	60	16	100	24:1:22:28

Syntheses

4,4,5,5-Tetramethyl-2-(5-(trimethylstannyl)thiophen-2-yl)-1,3,2-dioxaborolane (**1**)^[1]

Methylolithium (625 μL , 1.00 mmol, 1.60 M in diethyl ether) was added within 10 min to a suspension of 2,5-*bis*-(trimethylstannyl)thiophene (410 mg, 1.00 mmol) in THF (6 mL) at $-100\text{ }^\circ\text{C}$. The slightly yellow solution was stirred for 2 h at $-78\text{ }^\circ\text{C}$. 2-*iso*Propoxyloxy-4,4,5,5-tetramethyl-1,3,2-dioxaborolane **8** (186 mg, 1.00 mmol) was slowly added at this temperature and stirred for 1 h. Then the reaction mixture was warmed to $20\text{ }^\circ\text{C}$ within 12 h without removing the cooling bath and was then quenched with water (50 mL). The aqueous layer was washed with diethyl ether (3 x 20 mL). The combined organic layers were washed with brine (1 x 20 mL) and dried over MgSO_4 . The solvent was removed *in vacuo* and the crude product was purified by sublimation² ($30\text{ }^\circ\text{C}$, 2×10^{-2} mbar) to afford the product (205 mg, 55%; Lit: 55%) as a colorless solid.

Note: the compound was unstable to silica gel chromatography.

¹H NMR (500 MHz, CDCl_3): δ = 7.79 (d, 1 H, 3J = 3.2 Hz, H-a/b), 7.33 (d, 1 H, 3J = 3.2 Hz, H-a/b), 1.37 (s, 12 H, H-f), 0.40 (s, 9 H, H-g) ppm.

¹³C NMR (126 MHz, CDCl_3): δ = 146.5 (C-c), 137.8 (C-a/b), 136.3 (C-a/b), 84.1 (C-e), 24.9 (C-f), -8.1 (C-g) ppm.³

¹¹⁹Sn NMR (187 MHz, CDCl_3): δ = -26.8 ppm.

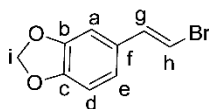
¹¹B NMR (160 MHz, CDCl_3): δ = 28.8 ppm.

HRMS (ESI-FTMS) *m/z*: $[\text{M} + \text{Na}]^+$ Calcd for $[\text{C}_{13}\text{H}_{23}\text{BO}_2\text{SSn} + \text{Na}]^+$ 397.0426; Found 397.0432.

IR (ATR): $\tilde{\nu}$ = 2978 (m), 2920 (w), 1510 (s), 1418 (s), 1331 (s), 1254 (m), 1138 (s), 1064 (s), 1021 (m), 957 (m), 928 (m), 853 (m), 820 (m), 770 (s), 665 (s), 533 (s) cm^{-1} .

M. p.: $84\text{ }^\circ\text{C}$.

The NMR data are in agreement with our previous work.^[1]

(E)-5-(2-Bromovinyl)benzo[d][1,3]dioxole (2b)

Tetraethylammonium bromide (2.30 g, 11.0 mmol) was added to a stirred suspension of iodosobenzene diacetate (3.54 g, 11.0 mmol) in anhydrous DCM (35 mL). The reaction mixture was stirred at $25\text{ }^\circ\text{C}$ for 5 min and then (*E*)-3,4-(methylenedioxy)cinnamic acid (1.92 g, 10.0 mmol) was added in one portion and stirred for 15 h at $25\text{ }^\circ\text{C}$. The reaction mixture was diluted with DCM (80 mL) and washed successively with aqueous NaHSO_3 (10%, 3 x 50 mL), aqueous NaHCO_3 (10% 3 x 50 mL), H_2O (2 x 50 mL) and brine (1 x 50 mL). The organic layer was dried over MgSO_4 and concentrated *in vacuo*. The residue obtained was purified by column chromatography over silica gel (*n*hexane, R_f = 0.28) and recrystallized in *n*hexane at $-30\text{ }^\circ\text{C}$ to afford the product (1.97 g, 87%) as a colorless solid.

¹H NMR (500 MHz, CDCl_3): δ = 7.00 (d, 3J = 13.9 Hz, 1 H, H-g), 6.81 (s, 1 H, H-a), 6.76 (m, 2 H, H-e,d), 6.59 (d, 3J = 13.9 Hz, 1 H, H-h), 5.96 (s, 1 H, H-i) ppm.

¹³C NMR (126 MHz, CDCl_3): δ = 148.3 (C-b/c), 147.9 (C-b/c), 136.8 (C-g), 130.4 (C-f), 121.0 (C-e), 108.6 (C-d), 105.6 (C-a), 104.7 (C-h), 101.4 (C-i) ppm.

²The starting material, as well as the monostannylated and monoboronated species were sublimed first ($25\text{ }^\circ\text{C}$, 2×10^{-2} mbar).

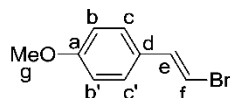
³The carbon atom bound to boron was not visible due to the high quadrupole moment of the boron nucleus, the same as other similar compounds.

HRMS (EI-sector) m/z : $[M]^+$ Calcd for $[C_9H_7BrO_2]^+$ 225.9629; Found 225.9631.

IR (ATR): $\tilde{\nu}$ = 3087 (m), 3008 (w), 2910 (m), 2778 (w), 1608 (w), 1500 (m), 1485 (m), 1433 (m), 1349 (m), 1242 (s), 1186 (s), 1103 (m), 1031 (s), 923 (s), 820 (m), 765 (s), 605 (m), 508 (s), 459 (m) cm^{-1} .

M.p.: 55 °C.

(E)-1-(2-Bromovinyl)-4-methoxybenzene (2c)



(E)-1-(2-Bromovinyl)-4-methoxybenzene was prepared similarly to a method described by Jaya Prakash Das et al.^[3] and was modified as follows:

Triethylamine (70.0 μ L, 0.50 mmol) was added to a stirred solution of (E)-4-methoxycinnamic acid (1.78 g, 10.0 mmol) in DCM (50 mL). After stirring the reaction mixture for 5 min at 23 °C, N-bromosuccinimide (1.96 g, 11.0 mmol) was added in one portion. The reaction mixture was stirred for another 2.5 h and quenched with saturated aqueous solution of $NaHCO_3$ (20 mL). The organic phase was washed with water (2 x 20 mL), brine (1 x 20 mL), and dried over $MgSO_4$. The solvent was removed *in vacuo* and the crude product was purified by column chromatography over silica gel (*n*hexane, R_f = 0.28) to afford the product (1.89 g, 89%, Lit.^[3]: 90%) as a colorless solid.

1H NMR (500 MHz, $CDCl_3$): δ = 7.23 (d, 3J = 9.8 Hz, 2 H, H-c, c'), 7.04 (d, 3J = 14.0 Hz, 1 H, H-e), 6.85 (d, 3J = 9.8 Hz, 2 H, H-b, b'), 6.61 (d, 3J = 14.0 Hz, 1 H, H-f), 3.81 (s, 3 H, H-g) ppm.

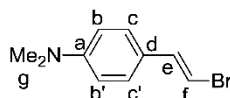
^{13}C NMR (126 MHz, $CDCl_3$): δ = 159.7 (C-a), 136.6 (C-e), 128.8 (C-d), 127.4 (C-c, c'), 114.2 (C-b, b'), 104.0 (C-f), 55.3 (C-g) ppm.

HRMS (EI-sector) m/z : $[M]^+$ Calcd for $[C_9H_9BrO]^+$ 211.9837; Found 211.9841.

IR (ATR): $\tilde{\nu}$ = 3067 (m), 3020 (w), 2957 (w), 2932 (w), 2837 (m), 1601 (m), 1507 (m), 1457 (m), 1303 (m), 1253 (m), 1173 (m), 1026 (m), 949 (s), 835 (s), 774 (s), 710 (m), 524 (s), 467 (m) cm^{-1} .

M.p.: 52 °C.

(E)-4-(2-Bromovinyl)-N,N-dimethylaniline (2d)



(E)-4-(2-Bromovinyl)-N,N-dimethylaniline was prepared similarly to a method described by Fursule et al.^[2] and was modified as follows:

Iodosobenzene diacetate (3.54 g, 11.0 mmol) was added to a stirred suspension of tetraethylammonium bromide (2.30 g, 11.0 mmol) in anhydrous DCM (100 mL). The reaction mixture was stirred at 23 °C for 5 min and then (E)-3-(4-(Dimethylamino)phenyl)acrylic acid (1.91 g, 10.0 mmol) was added in one portion and stirred at 23 °C for 19 h. The reaction mixture was diluted with DCM (100 mL) and washed successively with aqueous $NaHSO_3$ (10%, 3 x 80 mL), aqueous $NaHCO_3$ (10%, 3 x 80 mL), H_2O (2 x 80 mL) and brine (1x 100 mL). The organic layer was dried over $MgSO_4$ and concentrated *in vacuo*. The residue obtained was purified by column chromatography over silica gel (*n*hexane / ethyl acetate: 9 / 1, R_f = 0.35) to afford the product (1.16 g, 51%, Lit.^[2]: 91%) as a colorless solid.

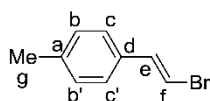
1H NMR (600 MHz, $CDCl_3$): δ = 7.18 (d, 3J = 8.7 Hz, 2 H, H-c, c'), 7.00 (d, 3J = 13.9 Hz, 1 H, H-e), 6.66 (s, 2 H, br, H-b, b'), 6.51 (d, 3J = 13.9 Hz, 1 H, H-f), 2.97 (s, 6 H, H-g) ppm.

^{13}C NMR (151 MHz, $CDCl_3$): δ = 150.4 (C-a), 136.9 (C-e), 127.1 (C-c, c'), 124.3 (C-d), 112.3 (C-b, b'), 101.5 (C-f), 40.4 (C-g) ppm.

HRMS (EI-sector) m/z : $[M]^+$ Calcd for $[C_{10}H_{12}NBr]^+$ 225.0153; Found 225.0154.

IR (ATR): $\tilde{\nu}$ = 3069 (m), 2892 (w), 2805 (w), 1599 (m), 1513 (m), 1439 (m), 1330 (m), 1276 (m), 1232 (m), 1183 (m), 1064 (m), 947 (s), 926 (m), 817 (s), 766 (9s), 750 (s), 518 (s) cm^{-1} .

M.p.: 105 °C.

(E)-1-(2-Bromovinyl)-4-methylbenzene (2e)

(E)-1-(2-Bromovinyl)-4-methylbenzene was prepared similarly to a method described by Fursule et al.^[2] and was modified as follows:

Tetraethylammonium bromide (920 mg, 4.40 mmol) was added to a stirred suspension of iodosobenzene diacetate (1.42 g, 4.40 mmol) in anhydrous DCM (50 mL). The reaction mixture was stirred at 25 °C for 5 min and then (E)-4-methylcinnamic acid (650 mg, 4.00 mmol) was added and stirred at 25 °C for 15 h in one portion. The reaction mixture was diluted with DCM (100 mL) and washed successively with aqueous NaHSO₃ (10%, 3 x 50 mL), aqueous NaHCO₃ (10%, 3 x 50 mL), H₂O (2 x 50 mL) and brine (1 x 50 mL). The organic layer was dried over MgSO₄ and concentrated *in vacuo*. The residue obtained was purified by column chromatography over silica gel (*n*hexane, R_f = 0.64) and recrystallized in *n*hexane at -30 °C to afford the product (315 mg, 40%, Lit.^[2]: 92%) as a colorless solid.

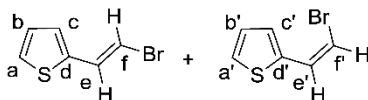
¹H NMR (500 MHz, CDCl₃): δ = 7.19 (d, ³J = 8.1 Hz, 2 H, H-c, c'), 7.13 (d, ³J = 8.1 Hz, 2 H, H-b, b'), 7.06 (d, ³J = 14.0 Hz, 1 H, H-e), 6.71 (d, ³J = 14.0 Hz, 1 H, H-f), 2.33 (s, 3 H, H-g) ppm.

¹³C NMR (126 MHz, CDCl₃): δ = 138.2 (C-a), 137.0 (C-e), 133.2 (C-d), 129.5 (C-b, b'), 126.0 (C-c, c'), 105.4 (C-f), 21.2 (C-g) ppm.

HRMS (EI-sector) *m/z*: [M]⁺ Calcd for [C₉H₉Br]⁺ 195.9888; Found 195.9884.

IR (ATR): $\tilde{\nu}$ = 3069 (m), 3025 (w), 2913 (m), 2854 (w), 1601 (m), 1508 (m), 1446 (w), 1225 (m), 1194 (m), 949 (s), 936 (s), 825 (s), 768 (s), 723 (m), 501 (s) cm⁻¹.

M.p.: 40 °C.

(E)-2-(2-Bromovinyl)thiophene and (Z)-2-(2-bromovinyl)thiophene (2f)

2-(2-Bromovinyl)thiophene was prepared similarly to a method described by Jaya Prakash Das et al.^[3] and was modified as follows:

Triethylamine (28.0 μL, 200 μmol) was added to a stirred solution of (E)-3-(2-thienyl) acrylic acid (616 mg, 4.00 mmol) in DCM (20 mL). After being stirred for 5 min at 23 °C, *N*-bromosuccinimide (748 mg, 4.20 mmol) was added in one portion. The reaction mixture was stirred for another 4 h and quenched with saturated aqueous solution of NaHCO₃ (10 mL). The organic phase was washed with water (2 x 7 mL) and brine (1 x 10 mL), and dried over MgSO₄. The solvent was removed under reduced pressure and the crude product was purified by column chromatography over silica gel (*n*hexane, R_f = 0.51) to afford the product (430 mg, 57%, Lit.^[3]: 80%) as light yellow oil. The product contained the *E* and *Z* isomers in 5 / 1 *E* / *Z* ratio.

Note: The product decomposed under air atmosphere, which may be caused by oxygen or light.

For (E)-2-(2-Bromovinyl)thiophene

¹H NMR (500 MHz, CDCl₃): δ = 7.22–7.20 (m, 1 H, H-a), 7.19 (d, ³J = 14.0 Hz, 1 H, H-e/f), 6.99–6.94 (m, 2 H, H-b,c), 6.63 (d, ³J = 14.0 Hz, 1 H, H-e/f) ppm.

¹³C NMR (126 MHz, CDCl₃): δ = 139.9 (C-d), 130.2 (C-e/f), 127.4 (C-b/c), 126.0 (C-b/c), 125.1 (C-a), 105.2 (C-e/f) ppm.

HRMS (EI-sector) *m/z*: [M]⁺ Calcd for [C₈H₅BrS]⁺ 187.9295; Found 187.9293.

For (Z)-2-(2-bromovinyl)thiophene:

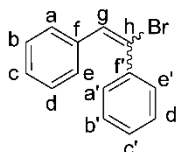
¹H NMR (500 MHz, CDCl₃): δ = 7.39 (d, ³J = 5.1 Hz 1 H, H-a'), 7.33–7.29 (m, 2 H, H-c', e'/f'), 7.07 (dd, ³J = 5.1, 3.6 Hz, 1 H, H-b'), 6.32 (d, ³J = 7.9 Hz, 1 H, H-e'/f') ppm.

¹³C NMR (126 MHz, CDCl₃): δ = 138.0 (C-d'), 130.1 (C-e'/f'), 126.9 (C-a'), 126.3 (C-b', c'), 104.1 (C-e'/f') ppm.

For the mixture:

IR (ATR): $\tilde{\nu}$ = 3105 (w), 3060 (m), 1601 (w), 1421(w), 1238 (s), 1211 (m), 1041 (w), 925 (s), 854 (m), 828 (m), 764 (s), 733 (m), 692 (s), 586 (m), 507 (m), 489 (m) cm^{-1} .

1-Bromoethene-1,2-diylidibenzene (2g)



Tetraethylammonium bromide (2.30 g, 11.0 mmol) was added to a stirred suspension of iodosobenzene diacetate (3.54 g, 11.0 mmol) in anhydrous DCM (35 mL). The reaction mixture was stirred at 25 °C for 5 min and then *o*-phenylcinnamic acid (2.24 g, 10.0 mmol) was added in one portion and stirred for 15 h at 25 °C. The reaction mixture was diluted with DCM (80 mL) and washed successively with aqueous NaHSO_3 (10%, 3 x 50 mL), aqueous NaHCO_3 (10%, 3 x 50 mL), H_2O (2 x 50 mL) and brine (1 x 50 mL). The organic layer was dried over MgSO_4 and concentrated *in vacuo*. The residue obtained was purified by Kugelrohr distillation (100 °C, 2.6 mbar) to afford the product (1.20 g, 53%) as yellow oil. The product contained the *E* and *Z* isomer in a 3 / 2 or 2 / 3 ratio, but it could not be determined which the major isomer was.

E or *Z* isomer:

$^1\text{H NMR}$ (500 MHz, CD_2Cl_2): δ = 7.74–7.70 (m, 2 H), 7.68–7.64 (m, 2 H), 7.44–7.31 (m, 6 H), 7.26 (s, 1 H, H-g) ppm.

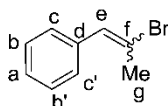
$^1\text{H NMR}$ (500 MHz, CD_2Cl_2): δ = 7.44–7.31 (m, 5 H), 7.26 (s, 1 H, H-g), 7.16–7.11 (m, 3 H), 7.00–6.95 (m, 2 H) ppm.⁴

$^{13}\text{C NMR}$ (126 MHz, CD_2Cl_2): δ = 141.4, 140.0 (C-f/h/f'), 136.7, 136.4 (C-f/h/f'), 133.5, 130.4 (C-g), 129.6, 129.5, 129.2, 129.1, 129.0, 128.7, 128.6, 128.5, 128.1, 127.9 (C-a-e, C-a'-e'), 124.3, 123.6 (C-f/h/f') ppm.⁵

HRMS (EI-sector) *m/z*: $[\text{M}]^+$ Calcd for $[\text{C}_{14}\text{H}_{11}\text{Br}]^+$ 258.0044; Found 258.0040.

IR (ATR): $\tilde{\nu}$ = 3080 (w), 3055 (m), 3024 (m), 1598 (w), 1494 (m), 1444 (m), 1165 (w), 1074 (m), 1029 (m), 926 (m), 887 (m), 755 (s), 688 (s), 564 (m), 537(m), 504 (m) cm^{-1} .

(2-Bromoprop-1-en-1-yl)benzene (2h)



Tetraethylammonium bromide (2.30 g, 11.0 mmol) was added to a stirred suspension of iodosobenzene diacetate (3.54 g, 11.0 mmol) in anhydrous DCM (35 mL). The reaction mixture was stirred at 25 °C for 5 min and then *o*-methylcinnamic acid (1.92 g, 10.0 mmol) was added in one portion and stirred for 15 h at 25 °C. The reaction mixture was diluted with DCM (80 mL) and washed successively with aqueous NaHSO_3 (10%, 3 x 50 mL), aqueous NaHCO_3 (10%, 3 x 50 mL), H_2O (2 x 50 mL) and brine (1 x 50 mL). The organic layer was dried over MgSO_4 and concentrated *in vacuo*. The residue obtained was purified by Kugelrohr distillation (65 °C, 3 mbar) to afford the product (1.10 g, 56%) as light yellow oil. The product contained *E* and *Z* isomer in 2 / 1 or 1 / 2 ratio, but it could not be determined which the major isomer was.

$^1\text{H NMR}$ (500 MHz, CD_2Cl_2): δ = 7.57–7.52 (m, 2 H), 7.38–7.33 (m, 6 H), 7.30–7.25 (m, 3 H), 7.25–7.22 (m, 4 H), 6.98 (s, 2 H, H-e), 6.76 (s, 1 H, H-e), 2.49 (d, 3J = 1.4 Hz, 3 H, H-g), 2.46 (d, 3J = 1.4 Hz, 6 H, H-g) ppm.⁶

⁴ The peaks of *Z*- and *E*-isomer could not be analyzed because of the overlap of signals.

⁵ The peaks belong to both *E*- and *Z*- isomer; The peaks of *Z*- and *E*-isomer could not be analyzed because of the overlap of signals.

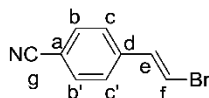
5 Experimental Section

¹³C NMR (126 MHz, CD₂Cl₂): δ = 136.9 (C-d), 136.7 (C-d), 132.6, 129.1, 128.8, 128.7, 128.4, 128.3, 127.9, 127.6, 124.1 (C-f), 122.4 (C-f), 30.8 (C-g), 25.2 (C-g) ppm.⁷

HRMS (EI-sector) *m/z*: [M]⁺ Calcd for [C₉H₉Br]⁺ 195.9888; Found 195.9888.

IR (ATR): $\tilde{\nu}$ = 3081 (w), 3057 (w), 3024 (m), 2952 (w), 2916 (m), 1632 (w), 1494 (m), 1435 (m), 1276 (m), 1066 (s), 916 (m), 847 (m), 749 (s), 695 (s), 553 (s), 501 (s), 433 (m) cm⁻¹.

(E)-4-(2-Bromovinyl)benzonitrile (2i)



Iodosobenzene diacetate (5.50 g, 17.0 mmol) was added to a stirred suspension of tetraethylammonium bromide (3.55 g, 17.0 mmol) in anhydrous DCM (100 mL). The reaction mixture was stirred at 25 °C for 5 min and then (E)-3-(4-cyanophenyl) acrylic acid (2.60 g, 15.0 mmol) was added in one portion and refluxed for 26 h. The reaction mixture was diluted with DCM (150 mL) and washed successively with aqueous NaHSO₃ (10%, 3 x 100 mL), aqueous NaHCO₃ (10%, 3 x 100 mL), H₂O (2 x 100 mL) and brine (1x 100 mL). The organic layer was dried over MgSO₄ and concentrated *in vacuo*. The residue obtained was purified by column chromatography over silica gel (n-hexane / ethyl acetate: 9 / 1, R_f = 0.25) to afford the product (890 mg, 29%) as a colorless solid.

¹H NMR (500 MHz, CDCl₃): δ = 7.77 (d, ³J = 8.5 Hz, 2 H, H-c, c'), 7.66 (d, ³J = 8.5 Hz, 2 H, H-b, b'), 7.10 (d, ³J = 8.3 Hz, 1 H, H-e), 6.63 (d, ³J = 8.3 Hz, 1 H, H-f) ppm.

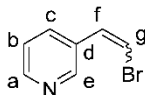
¹³C NMR (126 MHz, CDCl₃): δ = 139.4 (C-d), 132.0 (C-b, b'), 130.9 (C-e), 129.5 (C-c, c'), 118.7 (C-g), 112.7 (C-a), 110.1 (C-f) ppm.

HRMS (EI-sector) *m/z*: [M]⁺ Calcd for [C₉H₈NBr]⁺ 206.9684; Found 206.9682.

IR (ATR): $\tilde{\nu}$ = 3075 (m), 3011 (m), 2916 (w), 2227 (m), 1604 (m), 1501 (m), 1405 (m), 1325 (s), 1288 (m), 1178 (m), 1113 (m), 1021 (m), 918 (m), 858 (s), 824 (s), 752 (s), 732 (s), 685 (s), 567 (s), 548 (s), 484 (m) cm⁻¹.

M.p.: 47 °C.

3-(2-Bromovinyl)pyridine (2j)



3-(2-Bromovinyl)pyridine was prepared similarly to a method described by Hayford et al.^[4] and was modified as follows: A mixture of bromomethyltriphenylphosphonium bromide (2.62 g, 6.00 mmol) and potassium *t*butoxide (673 mg, 6.00 mmol) in THF (40 mL) was cooled to -78 °C and stirred at the indicated temperature for 1 h. A solution of 3-pyridine carboxaldehyde (500 μL, 5.30 mmol) in THF (5 mL) was then added via a syringe in 5 minutes. The reaction mixture was stirred another 5 h at -78 °C. Then the mixture was diluted with 50 mL of petroleum ether, and filtered under vacuum. The solvent was removed *in vacuo* and the crud product was purified by column chromatography over silica gel (n-hexane / ethyl acetate: 5:1, R_f = 0.35) to afford the product (455 mg, 49%, Lit.^[4]: 91%) as light yellow oil. The product contained *Z* and *E* isomer in 100 / 7 *Z* / *E* ratio.

¹H NMR (*Z* isomer)(500 MHz, CDCl₃): δ = 8.77(d, ³J = 2.1 Hz, 1 H, H-e), 8.55 (dd, ³J = 4.8 Hz, ⁴J = 1.5 Hz, 1 H, H-a), 8.15 (dt, ³J = 8.0 Hz, ⁴J = 1.8 Hz, 1 H, H-c), 7.32 (d, ³J = 8.0 Hz, ³J = 4.8 Hz, 1 H, H-b), 7.07 (d, ³J = 8.2 Hz, 1 H, H-f), 6.59 (d, ³J = 8.2 Hz, 1 H, H-g) ppm.

⁶ The peaks belong to both *E*- and *Z*-isomer; The ¹H NMR spectrum of these isomers cannot be analysed because of the overlap.

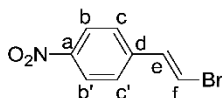
⁷ It was not possible to analyse the peaks because of the overlap of the peaks of *Z*- and *E*-isomer.

^{13}C NMR (Z isomer)(126 MHz, CDCl_3): δ = 150.4 (C-e), 149.2 (C-a), 135.5 (C-c), 131.0 (C-d), 129.2 (C-f), 123.0 (C-b), 109.2 (C-g) ppm.

HRMS (EI-sector) m/z : $[\text{M}]^+$ Calcd for $[\text{C}_7\text{H}_5\text{BrN}]^+$ 182.9684; Found 182.9683.

IR (ATR): $\tilde{\nu}$ = 3078 (n), 1616 (w), 1567 (m), 1472 (m), 1409 (s), 1324 (s), 1185 (m), 1124 (m), 1024 (s), 954 (m), 954 (s), 835 (m), 807 (s), 697 (vs), 625 (vs), 574 (s), 516 (m) cm^{-1} .

(E)-1-(2-Bromovinyl)-4-nitrobenzene (2k)



(E)-1-(2-Bromovinyl)-4-nitrobenzene was prepared similarly to a method described by Fursule et al.^[2] and was modified as follows:

Iodosobenzene diacetate (6.44 g, 20.0 mmol) was added to a stirred suspension of tetraethylammonium bromide (4.18 g, 20.0 mmol) in anhydrous DCM (50 mL). The reaction mixture was stirred at 23 °C for 5 min and then (E)-4-nitrocinnamic acid (2.89 g, 15.0 mmol) was added in one portion and refluxed for 46 h. The reaction mixture was diluted with DCM (100 mL) and washed successively with aqueous NaHSO_3 (10%, 3 x 50 mL), aqueous NaHCO_3 (10%, 3 x 50 mL), H_2O (2 x 50 mL) and brine (1 x 100 mL). The organic layer was dried over MgSO_4 and concentrated *in vacuo*. The residue obtained was purified by column chromatography over silica gel (n-hexane / ethyl acetate: 9 / 1, R_f = 0.35) to afford the product (1.16 g, 31%, Lit.^[2]: 89%) as a colorless solid.

^1H NMR (500 MHz, CDCl_3): δ = 8.24 (d, 3J = 8.8 Hz, 2 H, H-b, b'), 7.83 (d, 3J = 8.8 Hz, 2 H, H-c, c'), 7.16 (d, 3J = 8.3 Hz, 1 H, H-e), 6.68 (d, 3J = 8.3 Hz, 1 H, H-f) ppm.

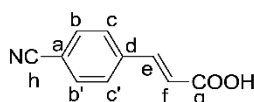
^{13}C NMR (126 MHz, CDCl_3): δ = 147.2 (C-a), 141.3 (C-d), 130.7 (C-e), 129.7 (C-c, c'), 123.5 (C-b, b'), 110.7 (C-f) ppm.

HRMS (EI-sector) m/z : $[\text{M}]^+$ Calcd for $[\text{C}_8\text{H}_5\text{BrNO}_2]^+$ 226.9582; Found 226.9581.

IR (ATR): $\tilde{\nu}$ = 3080 (m), 1607 (m), 1592 (m), 1508 (m), 1407 (m), 1333 (s), 1315 (m), 1276 (m), 1221 (m), 1106 (m), 1011 (w), 936 (w), 854 (s), 811 (m), 765 (s), 708 (m), 677 (s), 574 (m), 509 (s) cm^{-1} .

M.p.: 46 °C.

(E)-3-(4-Cyanophenyl)acrylic acid (2l)



(E)-3-(4-Cyanophenyl)acrylic acid was prepared similarly to a method described by Legoabe et al.^[5] and was modified as follows:

To a stirred solution of 4-formylbenzointrile (2.62 g, 20.0 mmol) and malonic acid (2.29 g, 22.0 mmol) in pyridine (10 mL), piperidine (0.2 mL, 2.0 mmol) was added at 23 °C. The reaction mixture was heated to 80 °C for 18 h. After cooling down to 23 °C, the reaction mixture was poured into ice-cooled aqueous hydrochloric acid (100 mL, 1 N) and a colorless solid precipitated. This precipitate was filtered and washed with cooled water. Recrystallisation from aqueous ethanol (1:2) at 30 °C afforded the product (2.84 g, 82%) as a colorless solid.

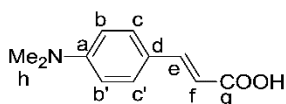
^1H NMR (500 MHz, $\text{DMSO}-d_6$): δ = 7.90–7.83 (m, 4 H, H-c, b, c', b'), 7.63 (d, 3J = 16.1 Hz, 1 H, H-e), 6.69 (d, 3J = 16.1 Hz, 1 H, H-f) ppm.

^{13}C NMR (126 MHz, $\text{DMSO}-d_6$): δ = 167.2 (C-g), 141.9 (C-e), 138.8 (C-d), 132.7 (C-b, b'), 128.9 (C-c, c'), 122.9 (C-f), 118.6 (C-a/h), 112.1 (C-a/h) ppm.

HRMS (ESI-FTMS) m/z : $[\text{M} - \text{H}]^+$ Calcd for $[\text{C}_{10}\text{H}_6\text{NO}_2]^+$ 172.0404; Found 172.0399.

IR (ATR): $\tilde{\nu}$ = 2824 (w), 2559 (w, br), 2225 (m), 1682 (s), 1623 (s), 1561 (m), 1509 (m), 1422 (m), 1308 (s), 1285 (m), 1229 (m), 981 (s), 910 (m), 836 (s), 822 (s), 749 (m), 679 (m), 542 (s), 482 (m), 452 (m) cm^{-1} .

M.p.: 253 °C.

(E)-3-(4-(Dimethylamino)phenyl)acrylic acid (2m)

(E)-3-(4-(Dimethylamino)phenyl)acrylic acid was prepared similarly to a method described by Zhang et. al.^[6] and was modified as follows:

To a stirred solution of 4-dimethylaminobenzaldehyde (2.98 g, 20.0 mmol) and malonic acid (2.29 g, 22.0 mmol) in pyridine (10 mL) was added piperidine (200 μ L, 2.00 mmol) at 23 °C. The reaction mixture was heated to 80 °C for 25 h. After cooling down to 23 °C, the reaction mixture was poured into ice-cooled aqueous hydrochloric acid (50 mL, 1 N) and yellow solid precipitated. The yellow precipitate was filtered and washed with cooled water and acetone to afford the product (2.81 g, 74%) as a yellow solid.

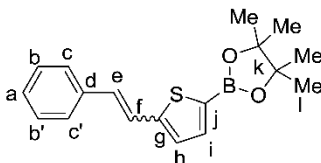
¹H NMR (500 MHz, DMSO-*d*₆): δ = 11.93 (s, 1 H, H-g), 7.45–7.49 (m, 3 H, H-c, c', e), 6.70 (d, 2 H, H-b, b'), 6.20 (d, 1 H, H-f), 2.96 (s, 6 H, H-h) ppm.

¹³C NMR (126 MHz, DMSO-*d*₆): δ = 168.6 (C-g), 152.1 (C-a), 145.1 (C-e), 130.2 (C-c, c'), 122.0 (C-d), 113.4 (C-f), 112.3 (C-b, b'), 40.3 (C-h)⁸ppm.

HRMS (ESI-FTMS) *m/z*: [M - H]⁺ Calcd for [C₁₁H₁₂NO₂]⁺ 190.0874; Found 190.0878.

IR (ATR): $\tilde{\nu}$ = 2805 (w, br), 1667 (m), 1593 (m), 1523 (m), 1434 (m), 1419 (m), 1367 (m), 1308 (m), 1260 (m), 1227 (m), 1186 (m), 987 (m), 941 (m), 813 (s), 748 (m), 675 (m), 530 (s), 480 (m) cm⁻¹.

M.p.: 225 °C.

4,4,5,5-Tetramethyl-2-(5-styrylthiophen-2-yl)-1,3,2-dioxaborolane (3a)

A solution of **1** (373 mg, 1.00 mmol), β -bromostyrene (*E* / *Z* = 8 / 1) (182 mg, 1.00 mmol), [Pd(PPh₃)₄] (11.6 mg, 10.0 μ mol, 1 mol%) in DMF (4 mL) was heated to 60 °C for 17 h. The mixture solution was filtered over a short plug of celite using *n*hexane (500 mL) as solvent. The solvent was removed *in vacuo* and the crude product was purified by Kugelrohr distillation (145 °C, 9.2 x 10⁻² mbar) to yield the product (281 mg, 90%) as a yellow solid. The product contained *E* and *Z* isomer in 20 / 3 *E* / *Z* ratio.

¹H NMR (500 MHz, CDCl₃): δ = 7.56–7.50 (m, 3 H, H-c, c', h/i), 7.42–7.37 (m, 2 H, H-b, b'), 7.35–7.28 (m, 2 H, H-a, f), 7.20 (d, ³*J* = 3.6 Hz, 1 H, H-h/i), 7.08 (d, ³*J* = 16.2 Hz, 1 H, H-e), 1.38 (s, 12 H, H-l) ppm.

¹³C NMR (126 MHz, CDCl₃): δ = 149.7 (C-i), 138.1 (C-h/i), 137.2 (C-d), 130.1 (C-e), 129.1 (C-b, b'), 128.3 (C-a), 127.6 (C-h/i), 126.8 (C-c, c'), 121.8 (C-f), 84.55 (C-k), 25.0 (C-l) ppm.

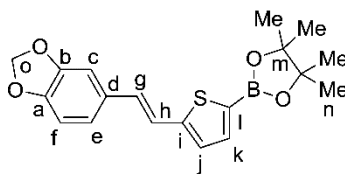
¹¹B NMR (160 MHz, CDCl₃): δ = 28.74 ppm.

HRMS (EI-sector) *m/z*: [M]⁺ Calcd for [C₁₈H₂₁BO₂S]⁺ 312.1355; Found 312.1359.

IR (ATR): $\tilde{\nu}$ = 2978 (m), 1522 (m), 1495 (m), 1458 (m), 1370 (m), 1327 (s), 1266 (m), 1239 (m), 1138 (s), 1061 (s), 1011 (m), 950 (s), 852 (s), 808 (s), 745 (m), 689 (s), 660 (s), 585 (m), 526 (m) cm⁻¹.

M.p.: 77 °C.

⁸The peak of the C-H signal overlapped with the residual H signal of the NMR solvent peak.

(E)-2-(5-(2-(Benzo[d][1,3]dioxol-5-yl)vinyl)thiophen-2-yl)-4,4,5,5-tetramethyl-1,3,2-dioxaborolane (3b)

A solution of **1** (373 mg, 1.00 mmol), (*E*)-5-(2-bromovinyl)benzo[d][1,3]dioxole **2b** (227 mg, 1.00 mmol), [Pd(PPh₃)₄] (11.6 mg, 10.0 μmol, 1 mol%) in DMF (4 mL) was heated to 40 °C for 25 h. The mixture solution was filtered over a short plug of silica gel using diethyl ether (500 mL) as solvent. The solvent was removed *in vacuo* and the crude product was purified by column chromatography on silica gel (*n*pentane / diethyl ether: 85 / 15, R_f = 0.47) to afford the product (274 mg, 77%) as a yellow solid.

¹H NMR (500 MHz, CDCl₃): δ = 7.51 (d, ³J = 3.6 Hz, 1 H, H-j/k), 7.11–7.05 (m, 2 H, H-j/k, h), 7.01 (s, 1 H, H-c), 6.93 (d, ³J = 16.1 Hz, 1 H, H-g), 6.90 (d, ³J = 8.0 Hz, 1 H, H-e), 6.78 (d, ³J = 8.0 Hz, 1 H, H-f), 5.97 (s, 2 H, H-o), 1.35 (s, 12 H, H-n) ppm.

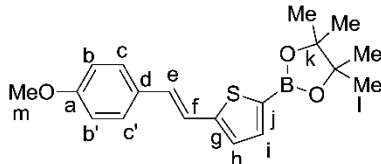
¹³C NMR (126 MHz, CDCl₃): δ = 149.7 (C-i), 148.2 (C-a/b), 147.5 (C-a/b), 137.8 (C-j/k), 131.3 (C-d), 129.6 (C-g), 126.7 (C-j/k), 121.6 (C-e), 119.9 (C-h), 108.5 (C-f), 105.4 (C-c), 101.2 (C-o), 84.1 (C-m), 24.8 (C-n) ppm.

¹¹B NMR (160 MHz, CDCl₃): δ = 28.88 ppm.

HRMS (EI-sector) m/z: [M]⁺ Calcd for [C₁₉H₂₁BO₄S]⁺ 356.1253; Found 356.1250.

IR (ATR): $\tilde{\nu}$ = 2976 (m), 1603 (m), 1525 (m), 1503 (m), 1490 (s), 1447 (s), 1372 (m), 1349 (s), 1310 (m), 1254 (s), 1210 (m), 1138 (s), 1062 (m), 1036 (s), 939 (s), 853 (s), 839 (m), 810 (s), 683 (m), 661 (s), 617 (m), 578 (w), 519 (w), 471 (w), 442 (m) cm⁻¹.

M.p.: 91 °C.

(E)-2-(5-(4-Methoxystyryl)thiophen-2-yl)-4,4,5,5-tetramethyl-1,3,2-dioxaborolane (3c)

A solution of **1** (373 mg, 1.00 mmol), (*E*)-1-(2-bromovinyl)-4-methoxybenzene **2c** (213 mg, 1.00 mmol), [Pd(PPh₃)₄] (11.6 mg, 10.0 μmol, 1 mol%) in DMF (4 mL) was heated to 40 °C for 25 h. The mixture solution was filtered over a short plug of silica gel using diethyl ether (500 mL) as solvent. The solvent was removed *in vacuo* and the crude product was purified by column chromatography on silica gel (*n*pentane / diethyl ether: 92 / 8, R_f = 0.21) to afford the product (260 mg, 76%) as a yellow solid.

¹H NMR (500 MHz, CDCl₃): δ = 7.52 (d, ³J = 3.5 Hz, 1 H, H-h/i), 7.41 (d, ³J = 8.9 Hz, 2 H, H-c, c'), 7.16–7.09 (m, 2 H, H-e/f, h/i), 6.98 (d, ³J = 16.1 Hz, 1 H, H-e/f), 6.89 (d, ³J = 8.9 Hz, 2 H, H-b, b'), 3.85–3.82 (s, 3 H, H-m), 1.36 (s, 12 H, H-l) ppm.

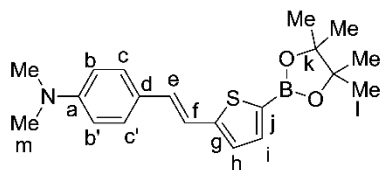
¹³C NMR (126 MHz, CDCl₃): δ = 159.5 (C-a), 150.0 (C-g), 137.8 (C-h/i), 129.6 (C-d), 129.5 (C-e/f), 127.8 (C-b, b'), 126.5 (C-h/i), 119.5 (C-e/f), 114.2 (C-c, c'), 84.1 (C-k), 55.3 (C-m), 24.8 (C-l) ppm.

¹¹B NMR (160 MHz, CDCl₃): δ = 29.02 ppm.

HRMS (EI-sector) m/z: [M]⁺ Calcd for [C₁₉H₂₃BO₃S]⁺ 342.1461; Found 342.1456.

IR (ATR): $\tilde{\nu}$ = 2979 (m), 1602 (m), 1509 (s), 1457 (s), 1377 (m), 1356 (s), 1333 (s), 1295 (s), 1252 (s), 1172 (m), 1134 (s), 1065 (s), 1031 (m), 1016 (m), 952 (s), 850 (s), 815 (s), 745 (m), 683 (m), 660 (s), 587 (m), 531 (m), 471 (m), 443 (m) cm⁻¹.

M.p.: 98 °C.

(E)-N,N-Dimethyl-4-(2-(5-(4,4,5,5-tetramethyl-1,3,2-dioxaborolan-2-yl)thiophen-2-yl)vinyl)aniline (3d)

A solution of **1** (373 mg, 1.00 mmol), (*E*)-4-(2-bromovinyl)-*N,N*-dimethylaniline **2d** (226 mg, 1.00 mmol), [Pd(PPh₃)₄] (11.6 mg, 10.0 μmol, 1 mol%) in DMF (4 mL) was heated to 60 °C for 168 h. The mixture solution was filtered over a short plug of celite using diethyl ether (500 mL) as solvent. The solvent was removed *in vacuo* and the crude product was purified by Kugelrohr distillation (170 °C, 7.9 x 10⁻² mbar) to yield the product (151 mg, 43%) as a yellow solid.

¹H NMR (500 MHz, CDCl₃): δ = 7.50 (d, ³J = 3.5 Hz, 1 H, H-h/i), 7.36 (d, ³J = 8.8 Hz, 2 H, H-c, c'), 7.08–7.02 (m, 2 H, H-f, h/i), 6.96 (d, ³J = 16.1 Hz, 1 H, H-e), 6.70 (d, ³J = 8.8 Hz, 2 H, H-b, b'), 2.99 (s, 6 H, H-m), 1.35 (s, 12 H, H-l) ppm.

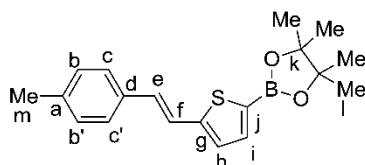
¹³C NMR (126 MHz, CDCl₃): δ = 150.8 (C-g), 150.3 (C-a), 137.8 (C-h/i), 130.3 (C-e), 127.6 (C-c, c'), 125.7 (C-f/h/i), 125.1 (C-d), 117.3 (C-f/h/i), 112.4 (C-b, b'), 84.0 (C-k), 40.4 (C-m), 24.8 (C-l) ppm.

¹¹B NMR (160 MHz, CDCl₃): δ = 28.59 ppm.

HRMS (ESI-FTMS) *m/z*: [M + H]⁺ Calcd for [C₂₀H₂₇BNO₂S]⁺ 356.1854; Found 356.1858; [M + Na]⁺ Calcd for [C₂₀H₂₆BNO₂Na S]⁺ 378.1673; Found 378.1676.

IR (ATR): $\tilde{\nu}$ = 2977 (m), 2911 (w), 1601 (s), 1518 (s), 1455 (s), 1357 (s), 1335 (s), 1302 (s), 1270 (m), 1232 (m), 1183 (m), 1167 (m), 1139 (s), 1065 (s), 1015 (m), 954 (s), 853 (s), 809 (s), 752 (w), 684 (m), 662 (s), 586 (m), 529 (m), 443 (m) cm⁻¹.

M.p.: 155 °C.

(E)-4,4,5,5-Tetramethyl-2-(5-(4-methylstyryl)thiophen-2-yl)-1,3,2-dioxaborolane (3e)

A solution of **1** (373 mg, 1.00 mmol), (*E*)-1-(2-bromovinyl)-4-methylbenzene **2a** (197 mg, 1.00 mmol), [Pd(PPh₃)₄] (11.6 mg, 10.0 μmol, 1 mol%) in DMF (4 mL) was heated to 40 °C for 26 h. The mixture solution was filtered over a short plug of silica gel using diethyl ether (500 mL) as solvent. The solvent was removed *in vacuo* and the crude product was purified by column chromatography on silica gel (*n*-pentane / ether: 95 / 5, R_f = 0.32) to afford the product (241 mg, 74%) as a yellow solid.

¹H NMR (500 MHz, CDCl₃): δ = 7.52 (d, ³J = 3.6 Hz, 1 H, H-i), 7.36 (d, ³J = 8.1 Hz, 2 H, H-c, c'), 7.20 (d, ³J = 16.1 Hz, 1 H, H-f), 7.15 (d, ³J = 8.1 Hz, 2 H, H-b, b'), 7.11 (d, ³J = 3.6 Hz, 1 H, H-h), 7.00 (d, ³J = 16.1 Hz, 1 H, H-e), 2.35 (s, 3 H, H-m), 1.35 (s, 12 H, H-l) ppm.

¹³C NMR (126 MHz, CDCl₃): δ = 149.8 (C-g), 137.8 (C-a), 137.7 (C-i), 134.0 (C-d), 129.9 (C-e), 129.4 (C-b, b'), 126.8 (C-i), 126.4 (C-c, c'), 120.6 (C-f), 84.1 (C-k), 24.8 (C-l), 21.3 (C-m) ppm.

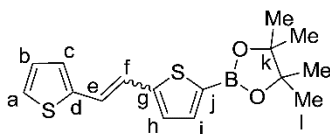
¹¹B NMR (160 MHz, CDCl₃): δ = 28.69 ppm.

HRMS (EI-sector) *m/z*: [M]⁺ Calcd for [C₁₉H₂₃BO₂S]⁺ 326.1512; Found 326.1510.

IR (ATR): $\tilde{\nu}$ = 2976 (m), 1606 (w), 1525 (m), 1511 (s), 1456 (s), 1355 (s), 1327 (s), 1310 (s), 1270 (m), 1137 (s), 1062 (s), 1011 (m), 952 (s), 851 (s), 814 (s), 685 (m), 663 (s), 586 (m), 529 (m), 485 (m), 439 (m) cm⁻¹.

M.p.: 108 °C.

4,4,5,5-Tetramethyl-2-(5-(2-(thiophen-2-yl)vinyl)thiophen-2-yl)-1,3,2-dioxaborolane (3f)



A solution of **1** (373 mg, 1.00 mmol), 2-(2-bromovinyl)thiophene **2f** (*E* / *Z* 5 / 1) (189 mg, 1.00 mmol), [Pd(PPh₃)₄] (11.6 mg, 10.0 μmol, 1 mol%) in DMF (4 mL) was heated to 60 °C for 17 h. The mixture solution was filtered over a short plug of celite using *n*hexane (500 mL) as solvent. The solvent was removed *in vacuo* and the crude product was purified by Kugelrohr distillation (140 °C, 1.2 × 10⁻¹ mbar) to yield the product (286 mg, 90%) as a yellow solid.⁹ The product contained *E* and *Z* isomer in about 25 / 2 *E* / *Z* ratio.

¹H NMR (600 MHz, CDCl₃): δ = 7.51 (d, ³J = 3.6 Hz, 1 H, H-i), 7.20 (d, ³J = 5.0 Hz, 1 H, H-a), 7.13 (d, ³J = 15.9 Hz, 1 H, H-f), 7.10 (d, ³J = 3.6 Hz, 1 H, H-h), 7.07–7.04 (m, 2 H, H-e, c), 7.00–6.98 (dd, ³J = 5.0 Hz, ³J = 3.5 Hz, 1 H, H-b), 1.35 (s, 12 H, H-l) ppm.

¹³C NMR (150 MHz, CDCl₃): δ = 149.0 (C-g), 142.2 (C-d), 137.8 (C-i), 127.7 (C-b), 127.1 (C-h), 126.5 (C-c), 124.7 (C-a), 122.9 (C-f), 121.1 (C-e), 84.1 (C-k), 24.8 (C-l) ppm.

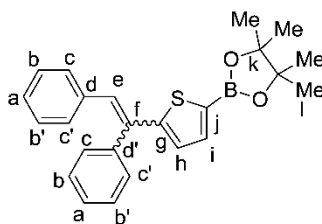
¹¹B NMR (160 MHz, CDCl₃): δ = 28.97 ppm.

HRMS (EI-sector) *m/z*: [M]⁺ Calcd for [C₁₆H₁₉BO₂S₂]⁺ 318.0919; Found 318.0917.

IR (ATR): $\tilde{\nu}$ = 3110 (w), 2978 (m), 1530 (m), 1511 (m), 1458 (m), 1422 (m), 1371 (m), 1345 (s), 1295 (s), 1268 (m), 1213 (m), 1167 (m), 1136 (s), 1061 (s), 1011 (m), 999 (m), 959 (m), 933 (s), 902 (m), 852 (s), 814 (s), 794 (m), 763 (m), 721 (s), 682 (m), 660 (s), 589 (m), 521 (m), 436 (m)cm⁻¹.

M.p.: 87 °C.

2-(5-(1,2-Diphenylvinyl)thiophen-2-yl)-4,4,5,5-tetramethyl-1,3,2-dioxaborolane (3g)



A solution of **1** (373 mg, 1.00 mmol), 1-bromoethene-1,2-diyl)dibenzene **2g** (*E* / *Z* or *Z* / *E* 3 / 2) (259 mg, 1.00 mmol), [Pd(PPh₃)₄] (11.6 mg, 10.0 μmol, 1 mol%) in DMF (4 mL) was heated to 60 °C for 120 h. The mixture solution was filtered over a short plug of celite using *n*hexane (500 mL) as solvent. The solvent was removed *in vacuo* and the crude product was purified by Kugelrohr distillation (170 °C, 5.2 × 10⁻² mbar) to yield the light yellow solid product (334 mg, 86%). The product contained *E* and *Z* isomer in a ratio of about 2 / 1.

¹H NMR (500 MHz, DMSO-*d*₆): δ = 7.54–6.96 (m, 23 H), 1.28, 1.27 (s, 21 H, H-l) ppm.

¹³C NMR (126 MHz, DMSO-*d*₆): δ = 154.7, 148.6, 142.6, 139.5, 138.4, 138.3, 136.9, 136.4, 135.7, 134.3, 131.3, 130.4, 129.8, 129.7, 129.6, 129.5, 128.9, 128.7, 128.6, 128.5, 128.0, 127.8, 127.6, 127.5, 126.9 (C-a-i), 84.6, 84.5 (C-k), 25.1, 25.0 (C-l) ppm.¹⁰

¹¹B NMR (160 MHz, DMSO-*d*₆): δ = 28.80 ppm.

HRMS (ESI-FTMS) *m/z*: [M + H]⁺ Calcd for [C₂₄H₂₆BO₂S]⁺ 389.1745; Found 389.1743; [M + Na]⁺ Calcd for [C₂₄H₂₅BO₂NaS]⁺ 411.1565; Found 411.1557.

⁹ The product decomposed on a silica column.

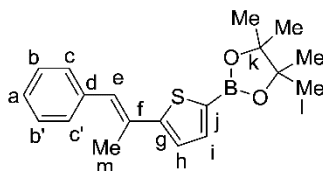
¹⁰ The peaks belong to both *E*- and *Z*-isomer; it was impossible to analyze the peaks of ¹H NMR and ¹³C NMR spectra because the overlap of signals.

5 Experimental Section

IR (ATR): $\tilde{\nu}$ = 2978 (m), 2930 (w), 1598 (w), 1524 (m), 1491 (m), 1445 (s), 1371 (s), 1348 (s), 1326 (s), 1267 (s), 1212 (w), 1140 (s), 1061 (s), 1013 (m), 957 (m), 925 (m), 852 (s), 813 (m), 752 (s), 715 (m), 693 (s), 663 (s), 619 (w), 577 (m), 556 (m), 515 (m), 436 (m) cm^{-1} .

M.p.: 42 °C.

(*E*)-4,4,5,5-Tetramethyl-2-(5-(1-phenylprop-1-en-2-yl)thiophen-2-yl)-1,3,2-dioxaborolane (**3h**)



A solution of **1** (373 mg, 1.00 mmol), (2-bromoprop-1-en-1-yl)benzene **3h** (*E* / *Z* or *Z* / *E* 2 / 1) (197 mg, 1.00 mmol), [Pd(PPh₃)₄] (11.6 mg, 10.0 μmol , 1 mol%) in DMF (4 mL) was heated to 60 °C for 144 h. The mixture solution was filtered over a short plug of celite using *n*hexane (500 mL) as solvent. The solvent was removed *in vacuo* and the crude product was purified by Kugelrohr distillation (130 °C, 7.7×10^{-2} mbar) and recrystallized in *n*hexane at -80 °C to yield the product (202 mg, 62%) as a colorless solid.

¹H NMR (500 MHz, CD₂Cl₂): δ = 7.50 (d, ³*J* = 3.6 Hz, 1 H, H-i), 7.39–7.35 (m, 4 H, H-b, b', c, c'), 7.29–7.24 (m, 1 H, H-a), 7.23 (d, ³*J* = 3.6 Hz, 1 H, H-h), 7.10 (d, ³*J* = 1.3 Hz, 1 H, H-e), 2.31 (d, ³*J* = 1.3 Hz, 3 H, H-m), 1.34 (s, 12 H, H-l) ppm.

¹³C NMR (126 MHz, CD₂Cl₂): δ = 155.1 (C-g), 137.9 (C-i), 137.8 (C-d), 131.4 (C-f), 129.6, 128.6 (C-b, b', c, c'), 127.6 (C-e), 127.2 (C-a), 125.0 (C-h), 84.5 (C-k), 25.0 (C-l), 17.7 (C-m) ppm.

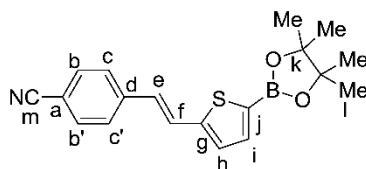
¹¹B NMR (160 MHz, CD₂Cl₂): δ = 28.71 ppm.

HRMS (EI-sector) *m/z*: [M]⁺ Calcd for [C₁₉H₂₃BO₂S]⁺ 326.1512; Found 326.1513.

IR (ATR): $\tilde{\nu}$ = 2979 (m), 1618 (w), 1599 (w), 1525 (s), 1494 (m), 1456 (s), 1383 (s), 1332 (s), 1290 (s), 1271 (s), 1213 (w), 1139 (s), 1071 (s), 1047 (m), 1017 (m), 959 (m), 918 (w), 853 (s), 805 (s), 756 (m), 710 (m), 694 (s), 664 (s), 619 (w), 595 (w), 578 (w), 497 (m), 462 (w), 441 (m) cm^{-1} .

M.p.: 71 °C.

(*E*)-4-(2-(5-(4,4,5,5-Tetramethyl-1,3,2-dioxaborolan-2-yl)thiophen-2-yl)vinyl) benzonitrile (**3i**)



A solution of **1** (373 mg, 1.00 mmol), (*E*)-4-(2-bromovinyl)benzonitrile **2i** (208 mg, 1.00 mmol), Pd(PPh₃)₄ (11.6 mg, 10.0 μmol , 1 mol%) in DMF (4 mL) was heated to 60 °C for 29 h. The mixture solution was filtered over a short plug of silica gel using diethyl ether (500 mL) as solvent. The solvent was removed *in vacuo* and the crude product was purified by column chromatography on silica gel (*n*pentane / diethyl ether: 85 / 15, *R_f* = 0.30) to afford the product (295 mg, 88%) as a light yellow solid.

¹H NMR (600 MHz, CDCl₃): δ = 7.61 (d, ³*J* = 8.3 Hz, 2 H, H-b, b'), 7.46 (d, ³*J* = 8.3 Hz, 2 H, H-a, a'), 7.42 (d, ³*J* = 3.6 Hz, 1 H, H-h/i), 7.00 (d, ³*J* = 3.6 Hz, 1 H, H-h/i), 6.80 (d, ³*J* = 12.2 Hz, 1 H, H-f), 6.55 (d, ³*J* = 12.2 Hz, 1 H, H-e), 1.31 (s, 12 H, H-l) ppm.

¹³C NMR (151 MHz, CDCl₃): δ = 145.3 (C-g), 141.9 (C-d), 137.1 (C-h/i), 132.3 (C-b, b'), 130.0 (C-h/i), 129.5 (C-c, c'), 128.1 (C-e), 125.2 (C-f), 119.0 (C-m), 111.1 (C-a), 84.2 (C-k), 24.7 (C-l) ppm.

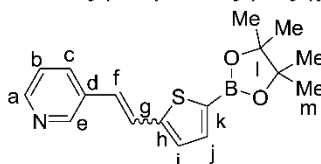
¹¹B NMR (160 MHz, CDCl₃): δ = 28.77 ppm.

HRMS (EI-sector) *m/z*: [M]⁺ Calcd for [C₁₉H₂₀BNO₂S]⁺ 337.1308; Found 337.1310.

IR (ATR): $\tilde{\nu}$ = 2984 (w), 2969 (s), 2227 (m), 1623 (w), 1603 (m), 1518 (m), 1504 (m), 1395 (m), 1371 (m), 1345 (s), 1327 (s), 1265 (m), 1211 (w), 1139 (s), 1065 (s), 1016 (m), 957 (m), 875 (s), 849 (s), 826 (m), 809 (s), 753 (m), 733 (m), 682 (m), 660 (s), 592 (m), 557 (s), 468 (w), 432 (m) cm^{-1} .

M.p.: 117 °C.

3-(2-(5-(4,4,5,5-Tetramethyl-1,3,2-dioxaborolan-2-yl)thiophen-2-yl)vinyl)pyridine (3j)



A solution of **1** (373 mg, 1.00 mmol), 3-(2-bromovinyl)pyridine **2k** (Z / E 100 / 7) (184 mg, 1.00 mmol), $[\text{Pd}(\text{PPh}_3)_4]$ (11.6 mg, 10.0 μmol , 1 mol%) in DMF (4 mL) was heated to 60 °C for 27 h. The mixture solution was filtered over a short plug of celite using *n*hexane (500 mL) as solvent. The solvent was removed *in vacuo* and the crude product was purified by Kugelrohr distillation (120 °C, 5.3×10^{-2} mbar) to get the product (261 mg, 83%) as white solid. The product contained Z and E isomer in 20 / 1 Z / E ratio.

$^1\text{H NMR}$ (500 MHz, CD_2Cl_2): δ = 8.58–8.55 (m, 1 H, H-e), 8.53 (dd, $^3J = 4.8$ Hz, $^4J = 1.7$ Hz, 1 H, H-a), 7.69–7.63 (m, 1 H, H-c), 7.38 (d, $^3J = 3.6$ Hz, 1 H, H-j), 7.31–7.27 (m, 1 H, H-b), 7.03 (d, $^3J = 3.6$ Hz, 1 H, H-i), 6.85 (d, $^3J = 12.0$ Hz, 1 H, H-g), 6.57 (d, $^3J = 12.0$ Hz, 1 H, H-f), 1.29 (s, 12 H, H-m) ppm.

$^{13}\text{C NMR}$ (126 MHz, CD_2Cl_2): δ = 150.2 (C-e), 149.1 (C-a), 146.1 (C-h), 137.2 (C-j), 136.3 (C-c), 133.4 (C-d), 130.5 (C-i), 126.8 (C-f), 125.5 (C-g), 123.7 (C-b), 84.5 (C-l), 24.9 (C-m) ppm.

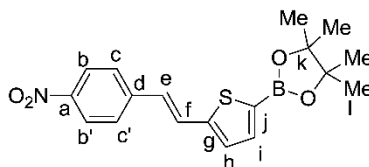
$^{11}\text{B NMR}$ (160 MHz, CD_2Cl_2): δ = 28.63 ppm.

HRMS (EI-sector) m/z : $[\text{M}]^+$ Calcd for $[\text{C}_{17}\text{H}_{20}\text{BNO}_2\text{S}]^+$ 313.1308; Found 313.1310.

IR (ATR): $\tilde{\nu}$ = 2973 (m), 2927 (w), 1522 (m), 1627 (m), 1476 (m), 1423 (m), 1356 (m), 1271 (w), 1206 (m), 1182 (s), 1140 (vs), 1001 (s), 979 (vs), 942 (s), 863 (m), 812 (m), 770 (s), 691 (vs), 653 (vs), 596 (m), 564 (m), 471 (m) cm^{-1} .

M.p.: 59 °C.

(E)-4,4,5,5-Tetramethyl-2-(5-(4-nitrostyryl)thiophen-2-yl)-1,3,2-dioxaborolane (3k)



A solution of **1** (373 mg, 1.00 mmol), (*E*)-1-(2-bromovinyl)-4-nitrobenzene **2j** (228 mg, 1.00 mmol), $[\text{Pd}(\text{PPh}_3)_4]$ (11.6 mg, 10.0 μmol , 1 mol%) in DMF (4 mL) was heated to 60 °C for 27 h. The mixture solution was filtered over a short plug of silica gel using diethyl ether (500 mL) as solvent. The solvent was removed *in vacuo* and the crude product was purified by column chromatography (*n*pentane / diethyl ether: 85 / 15, $R_f = 0.30$) to afford the product (293 mg, 82%) as a red solid.

$^1\text{H NMR}$ (500 MHz, CDCl_3): δ = 8.18 (d, $^3J = 8.5$ Hz, 2 H, H-b, b'), 7.52 (d, $^3J = 8.5$ Hz, 2 H, H-a, a'), 7.43 (d, $^3J = 3.6$ Hz, 1 H, H-i), 7.02 (d, $^3J = 3.6$ Hz, 1 H, H-h), 6.84 (d, $^3J = 12.2$ Hz, 1 H, H-f), 6.58 (d, $^3J = 12.2$ Hz, 1 H, H-e), 1.31 (s, 12 H, H-l) ppm.

$^{13}\text{C NMR}$ (126 MHz, CDCl_3): δ = 147.0 (C-a), 145.2 (C-g), 144.0 (C-d), 137.1 (C-i), 130.3 (C-h), 129.7 (C-c, c'), 127.7 (C-e), 125.7 (C-f), 123.9 (C-b, b'), 84.2 (C-k), 24.7 (C-l) ppm.

$^{11}\text{B NMR}$ (160 MHz, CDCl_3): δ = 28.83 ppm.

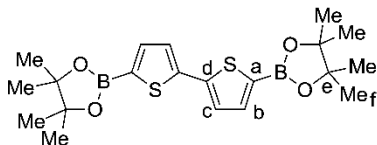
HRMS (ESI-FTMS) m/z : $[\text{M} + \text{Na}]^+$ Calcd for $[\text{C}_{18}\text{H}_{20}\text{BNO}_4\text{NaS}]^+$ 380.1102; Found 380.1105.

IR (ATR): $\tilde{\nu}$ = 2982 (m), 2928 (w), 1618 (w), 1592 (m), 1523 (m), 1508 (s), 1454 (m), 1357 (m), 1338 (s), 1299 (s), 1266 (m), 1208 (w), 1138 (s), 1103 (m), 1065 (m), 1012 (m), 955 (m), 890 (m), 852 (s), 830 (m), 809 (s), 759 (s), 729 (m), 693 (m), 662 (s), 579 (m), 470 (m), 439 (m) cm^{-1} .

5 Experimental Section

M.p.: 112 °C.

5,5'-bis(4,4,5,5-Tetramethyl-1,3,2-dioxaborolan-2-yl)-2,2'-bithiophene (**4**)



1 (373 mg, 1.00 mmol), **9** (336 mg, 1.00 mmol), and [Pd(PPh₃)₄] (57.8 mg, 50.0 μmol) were dissolved in toluene (2 mL). The reaction mixture was heated to 100 °C by microwave irradiation for 4 h and colorless crystals precipitated. Subsequently, the mixture was dissolved in diethyl ether (10 mL) and filtered through a short plug of celite. The solvent was removed *in vacuo* and the crude product was purified by column chromatography (*n*hexane / diethyl ether: 10 / 1, R_f = 0.21) to afford the product (218 mg, 52%) as a colorless solid.

¹H NMR (500 MHz, CDCl₃): δ = 7.49 (d, ³J = 3.6 Hz, 2 H, H-b/c), 7.31 (d, ³J = 3.6 Hz, 2 H, H-b/c), 1.34 (s, 24 H, H-f) ppm.

¹³C NMR (126 MHz, CDCl₃): δ = 144.0 (C-d), 138.3 (C-b/c), 126.0 (C-b/c), 84.7 (C-e), 25.0 (C-f) ppm.

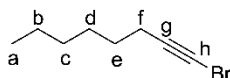
¹¹B NMR (160 MHz, CDCl₃): δ = 28.68 ppm.

HRMS (ESI-FTMS) *m/z*: [M + H]⁺ Calcd for [C₂₀H₂₉B₂O₄S]⁺ 419.1695; Found 419.1695.

IR (ATR): $\tilde{\nu}$ = 2981 (m), 2933 (w), 1515 (m), 1435 (m), 1330 (s), 1251 (m), 1136 (s), 1075 (m), 1020 (m), 958 (m), 850 (s), 807 (s), 750 (s), 661 (s), 578 (w), 429 (m) cm⁻¹.

M.p.: 201 °C.

1-Bromo-1-octyne (**6a**)



This compound was prepared by a literature method.^[7]

To a stirred solution of 1-octyne (1.47 mL, 10.0 mmol) in acetone (263 mL), in a flask which was shielded rigorously from light, solid AgNO₃ (510 mg, 3.00 mmol) and *N*-bromo-succinimide (2.5 g, 14.0 mmol) were added in one portion under an air atmosphere. After stirring for 3 h at 22 °C, the reaction mixture was diluted with water (200 mL) and extracted with *n*hexane (3 x 200 mL). The combined extracts were washed with brine (1 x 300 mL) and dried over MgSO₄. The solvent was removed *in vacuo* and the crude product was purified by column chromatography over silica gel (*n*hexane, R_f = 0.82) to afford the product (1.40 g, 74%, Lit.^[7]: 80%) as colorless oil.¹¹

¹H NMR (500 MHz, CDCl₃): δ = 2.20 (t, ³J = 7.2 Hz, 2 H, H-f), 1.56–1.44 (m, 2 H, H-e), 1.40–1.23 (m, 6 H, H-b,c,d), 0.89 (t, ³J = 6.9 Hz, 3 H, H-a) ppm.

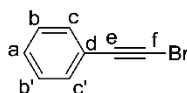
¹³C NMR (126 MHz, CDCl₃): δ = 80.5 (C-g), 37.4 (C-h), 22.5, 28.3, 28.5, 31.3 (C-b,c,d,e), 19.7 (C-f), 14.0 (C-a) ppm.

HRMS (EI-sector) *m/z*: No spectrum could be obtained either by EI or ESI.

IR (ATR): $\tilde{\nu}$ = 2958 (m), 2956 (s), 2929 (m), 1430 (m), 1430 (w), 1378 (w), 1327 (w), 750 (w), 725 (m), 409 (w) cm⁻¹.

The NMR data agree with the literature.^[7]

¹¹ The product was volatile.

(Bromoethynyl)benzene (6b)^[8]

This compound was prepared by a literature method.^[8]

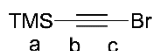
To a stirred solution of ethynylbenzene (1.02 g, 10.0 mmol) in acetone (50 mL), in a flask which was shielded rigorously from light, solid AgNO₃ (84.0 mg, 500 μmol) and *N*-bromosuccinimide (2.53 g, 14.0 mmol) were added in one portion under an air atmosphere. After stirring for 6 h at 22 °C, the solvent was removed *in vacuo* and the crude product was purified by column chromatography over silica gel (*n*hexane, R_f = 0.53) to afford the product (1.70 g, 90%; Lit.: [8]) as yellow oil.

¹H NMR (600 MHz, CDCl₃): δ = 7.47–7.43 (m, 2 H, H-c, c'), 7.36–7.29 (m, 2 H, H-a, b, b') ppm.

¹³C NMR (151 MHz, CDCl₃): δ = 132.0 (C-c, c'), 128.7 (C-a), 128.3 (C-b, b'), 122.7 (C-d), 80.0 (C-e), 49.7 (C-f) ppm.

HRMS (ESI-FTMS) *m/z*: [M]⁺ Calcd for [C₈H₅Br]⁺ 179.9575; Found 179.9574.

IR (ATR): $\tilde{\nu}$ = 3062 (w), 2818 (w), 2199 (m), 1595 (m), 1485 (s), 1442 (m), 1070 (m), 1026 (m), 915 (m), 751 (vs), 687 (vs), 611 (s), 519 (vs) cm⁻¹.

(Bromoethynyl)trimethylsilane (6c)

This compound was prepared by a literature method.^[9]

n-BuMgCl (9.49 mL, 15.0 mmol) was added dropwise over the period of 10 min to the stirred solution of ethynyltrimethylsilane (1.47 g, 15.0 mmol) in THF (45 mL) at 20 °C. The solution stirred for 18 h at 20 °C. Then the solution was cooled to -78 °C and stirred for 1 h before bromine (770 μL, 15.0 mmol) was added dropwise over the period of 10 min. Then the solution warmed up to 20 °C. The reaction mixture was quenched slowly with 2 M of Na₂S₂O₃ aqueous solution (15 mL). The yellow solution became colorless and was stirred for additional 5 min. The organic layer was washed with brine (3 x 50 mL) and dried over MgSO₄. The solvent was removed *in vacuo* and the crude product was purified Kugelrohr distillation (60–80 °C, 100 mbar) to afford (1.41 g, 69%, Lit.^[9]: 56%) of colorless oil.

¹H NMR (500 MHz, CDCl₃): δ = 0.18 (s, 9 H, H-a) ppm.

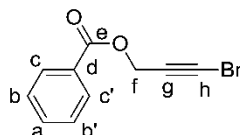
¹³C NMR (125 MHz, CDCl₃): δ = 87.1 (C-b), 61.6 (C-c), 0.1 (C-a) ppm.

²⁹Si NMR (99 MHz, CDCl₃): δ = (-15.50 – -15.85) ppm.¹²

²⁹Si [¹H] DEPT NMR (99 MHz, CDCl₃): δ = 15.67 (s, Si-(CH₃)₃) ppm.

HRMS (EI-sector) *m/z*: [M]⁺ Calcd for [C₅H₉BrSi]⁺ 177.9636; Found 177.9637.

IR (ATR): $\tilde{\nu}$ = 2962 (m), 2125 (s), 1251 (s) cm⁻¹.¹³

3-Bromoprop-2-yn-1-yl benzoate (6d)

To the mixture of propargyl benzoate (2.40 g, 15.0 mmol) and *N*-bromosuccinimide (3.26 g, 12.0 mmol) in 10 mL of acetone, AgNO₃ (127 mg, 750 μmol) was added in one portion and the mixture was stirred at 20 °C for 3 h. After

¹² The expected ²J Si-H coupling constant with 6.6 Hz was observed, but the signal/noise ratio is too low to see the complete multiplet.

¹³ No peak at about 3300 cm⁻¹, corresponding to CC-H valence vibration.

5 Experimental Section

removing the solvent *in vacuo*, the residue was dissolved in a mixture of water (30 mL) and *n*-pentane (30 mL). The aqueous phase was extracted with *n*-pentane (3 x 30 mL). The organic layers were combined and the solvent was removed *in vacuo*. The crude product was purified by column chromatography over silica gel (DCM / *n*-pentane: 1 / 1, $R_f = 0.4$) to afford the product (2.83 g, 79%) as colorless oil.

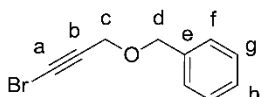
$^1\text{H NMR}$ (500 MHz, CDCl_3): $\delta = 8.09\text{--}8.05$ (m, 2 H, H-c,c'), 7.61–7.56 (m, 1 H, H-a), 7.48–7.43 (m, 2 H, H-b,b'), 4.95 (s, 2 H, H-f) ppm.

$^{13}\text{C NMR}$ (125 MHz, CDCl_3): $\delta = 165.9$ (C-d), 135.5 (C-a), 130.0 (C-c,c'), 129.5 (C-d), 128.6 (C-b,b'), 74.3 (C-g), 53.4 (C-f), 47.4 (C-h) ppm.¹⁴

HRMS (EI-sector) *m/z*: $[\text{M}]^+$ Calcd for $[\text{C}_{10}\text{H}_7\text{BrO}_2]^+$ 239.9609; Found 239.9614.

IR (ATR): $\tilde{\nu} = 3064$ (w), 2946 (w), 2226 (m) cm^{-1} .

Benzylprop-(3-bromo-2-ynyl) ether (6e)



To the mixture of benzylprop-2-ynyl ether (2.19 g, 15.0 mmol), and *N*-bromosuccinimide (3.26 g, 18.0 mmol) in acetone (15 mL), AgNO_3 (127 mg, 750 μmol) was added and the mixture was stirred at 24 °C for 3 h under exclusion of light. After GC-MS indicated the completion the reaction, the solvent was evaporated. The residue was dissolved in a mixture of water (100 mL) and *n*-pentane (100 mL). After phase separation, the aqueous phase was extracted with pentane (100 mL). The organic layers were combined, dried over Na_2SO_4 and the solvent was removed *in vacuo*. The product was purified by column chromatography (silica, eluent: gradient of *n*-pentane to ethyl acetate; $R_f = 0.2$) and was obtained as colorless oil (2.31 g, 68%).

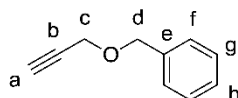
$^1\text{H NMR}$ (500 MHz, CDCl_3): $\delta = 7.45\text{--}7.27$ (m, 5 H, H-f,g,h), 4.60 (s, 2 H, H-d), 4.20 (s, 2 H, H-c) ppm.

$^{13}\text{C NMR}$ (126 MHz, CDCl_3): $\delta = 137.2$ (C-e), 128.5 (C-f/g), 128.1 (C-f/g), 127.9 (C-h), 76.2 (C-a/b), 71.7 (C-d), 58.0 (C-c), 46.1 (C-a/b) ppm.

HRMS (EI-sector) *m/z*: $[\text{M}]^+$ Calcd for $[\text{C}_{10}\text{H}_8\text{BrO}]^+$ 224.9738; Found 224.9740.

IR (ATR): $\tilde{\nu} = 3039$ (w), 2854 (m), 2213 (m), 1087 (s), 1073 (s), 736 (s), 696 (s) cm^{-1} .

Benzylprop-2-ynyl ether (6f)



This compound was prepared by a literature method.^[10]

Propargylic alcohol (2.24 g, 40.0 mmol) in DMF (15 mL) was added in portion over 15 min to a suspension of NaH (60% in mineral oil, 1.62 g, 40.4 mmol) in DMF (35 mL) at 0 °C. After 30 min, benzyl bromide (6.91 g, 40.4 mmol) was added in one portion, the cooling bath removed and the resulting mixture was stirred at 22 °C for 22 h. The mixture was then diluted by ethyl acetate (200 mL) and washed by HCl 1N (200 mL) and dried over Na_2SO_4 . The reaction mixture was then concentrated and purified by a short filter column chromatography (silica: 0.040-0.063 mm, 230-400 mesh; eluent: *n*-pentane; For TLC: *n*-pentane / DCM = 8 / 2, $R_{f \text{ impurity}} = 0.76$; $R_{f \text{ product}} = 0.50$). The product (4.93 g, 84%, Lit.^[10]: 100%)¹⁵ was received as a colorless oil and stored in the fridge at 4 °C.

$^1\text{H NMR}$ (600 MHz, CDCl_3): $\delta = 7.42\text{--}7.28$ (m, 5 H, H-f,g,h), 4.62 (s, 2 H, H-d), 4.18 (d, $^4J = 2.4$ Hz, 2 H, H-c), 2.47 (t, $^4J = 2.4$ Hz, 1 H, H-a) ppm.

$^{13}\text{C NMR}$ (151 MHz, CDCl_3): $\delta = 137.4$ (C-e), 128.6 (C-f/g), 128.3 (C-f/g), 128.1 (C-h), 79.8 (C-b), 74.7 (C-a), 71.7 (C-d), 57.2 (C-c) ppm.

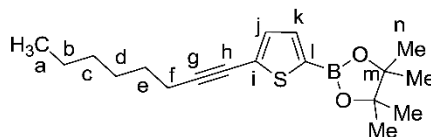
¹⁴ A signal with a negative intensity at 70.8 ppm is due to an artifact which occurred during the measurement.

¹⁵ The product is very volatile and should not be placed under a vacuum of below 10 mbar at 45 °C.

HRMS: No spectrum could be obtained either by EI or ESI.

IR (film): $\tilde{\nu}$ = 3291, 2856, 1073, 696 cm^{-1} .

4,4,5,5-Tetramethyl-2-(5-(oct-1-yn-1-yl)thiophen-2-yl)-1,3,2-dioxaborolane (7a)



A solution of **1** (373 mg, 1.00 mmol), 1-bromo-1-octyne **6a** (189 mg, 1.00 mmol), $[\text{Pd}(\text{PPh}_3)_4]$ (11.6 mg, 10.0 μmol , 1 mol%) in DMF (4 mL) was heated to 40 $^\circ\text{C}$ for 25 h. The mixture solution was filtered over a short plug of celite using *n*hexane (500 mL) as solvent. The solvent was removed *in vacuo* and the crude product was purified by Kugelrohr distillation (125 $^\circ\text{C}$, 5.0×10^{-2} mbar) to yield the product (204 mg, 64%) as a colorless oil.

$^1\text{H NMR}$ (500 MHz, CDCl_3): δ = 7.45 (d, 3J = 3.6 Hz, 1 H, H-j/k), 7.15 (d, 3J = 3.6 Hz, 1 H, H-j/k), 2.43 (t, 3J = 7.1 Hz, 2 H, H-f), 1.64–1.57 (m, 2 H, H-e), 1.47–1.41 (m, 2 H, H-e), 1.36–1.29 (m, 16 H, H-b, c, n), 0.91 (t, 3J = 6.9 Hz, 3 H, H-a) ppm.

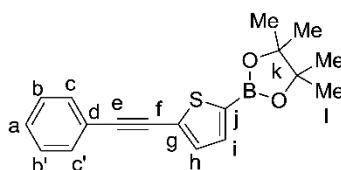
$^{13}\text{C NMR}$ (126 MHz, CDCl_3): δ = 136.8 (C-j/k), 131.9 (C-j/k), 130.9 (C-i), 96.2 (C-g), 84.1 (C-m), 73.8 (C-h), 31.3 (C-c), 28.6 (C-d/e), 28.4 (C-d/e), 24.7 (C-n), 22.5 (C-b), 19.8 (C-f), 14.0 (C-a) ppm.

$^{11}\text{B NMR}$ (160 MHz, CDCl_3): δ = 28.41 ppm.

HRMS (EI-sector) m/z : $[\text{M}]^+$ Calcd for $[\text{C}_{18}\text{H}_{27}\text{BO}_2\text{S}]^+$ 318.1825; Found 318.1823.

IR (ATR): $\tilde{\nu}$ = 7978 (w), 2930 (m), 2858 (w), 2227 (w), 1523 (m), 1456 (s), 1372 (m), 1352 (s), 1289 (s), 1270 (m), 1213 (m), 1140 (s), 1064 (s), 1016 (m), 998 (w), 957 (m), 852 (s), 810 (s), 749 (w), 724 (w), 686 (m), 664 (s), 579 (m), 444 (m) cm^{-1} .

4,4,5,5-Tetramethyl-2-(5-(phenylethynyl)thiophen-2-yl)-1,3,2-dioxaborolane (7b)



A solution of **1** (186 mg, 500 μmol), (bromoethynyl)benzene **6b** (90.5 mg, 500 μmol), $[\text{Pd}(\text{PPh}_3)_4]$ (5.80 mg, 0.50 μmol , 1 mol%) in DMF (2 mL) was heated to 40 $^\circ\text{C}$ for 27 h. The mixture solution was filtered over a short plug of celite using *n*hexane (500 mL) as solvent. The solvent was removed *in vacuo* and the crude product was purified by Kugelrohr distillation (110 $^\circ\text{C}$, 6.2×10^{-2} mbar) to afford the product (130 mg, 84%) as a colorless solid.

$^1\text{H NMR}$ (600 MHz, CDCl_3): δ = 7.54–7.50 (m, 3 H, H-c, c', i), 7.37–7.33 (m, 3 H, H-a, b, b'), 7.31 (d, 3J = 3.6 Hz, 1 H, H-h), 1.35 (s, 12 H, H-l) ppm.

$^{13}\text{C NMR}$ (150 MHz, CDCl_3): δ = 137.0 (C-i), 132.9 (C-h), 131.5 (C-c, c'), 129.8 (C-g), 128.6 (C-a), 128.4 (C-b, b'), 122.8 (C-d), 94.4 (C-e), 84.3 (C-k), 82.7 (C-f), 24.8 (C-l) ppm.

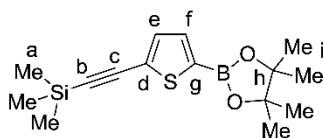
$^{11}\text{B NMR}$ (160 MHz, CDCl_3): δ = 28.70 ppm.

HRMS (EI-sector) m/z : $[\text{M}]^+$ Calcd for $[\text{C}_{18}\text{H}_{19}\text{BO}_2\text{S}]^+$ 310.1198; Found 310.1192.

IR (ATR): $\tilde{\nu}$ = 2977 (m), 1527 (m), 1492 (s), 1453 (s), 1355 (vs), 1337 (vs), 1314 (vs), 1249 (s), 1138 (vs), 1067 (m), 1012 (m), 958 (m), 912 (m), 852 (s), 813 (s), 748 (vs), 684 (s), 660 (s), 580 (m), 517 (m) cm^{-1} .

M.p.: 104 $^\circ\text{C}$.

Trimethyl((5-(4,4,5,5-tetramethyl-1,3,2-dioxaborolan-2-yl)thiophen-2-yl)ethynyl)silane (7c)



A solution of **1** (746 mg, 2.00 mmol), (bromoethynyl)trimethylsilane **6c** (340 mg, 2.00 mmol), [Pd(PPh₃)₄] (23.0 mg, 20.0 μmol, 1 mol%) in DMF (8 mL) was heated to 60 °C for 7 d. The mixture solution was filtered over a short plug of celite using diethyl ether (50 mL) as eluent. The solvent was removed *in vacuo* and the crude product (1.03 g) was purified by Kugelrohr distillation (70 °C, 2 x 10⁻¹ mbar) to afford a mixture (50 / 50) of **1** (starting material) and product (533 mg). A subsequent column chromatography (*n*hexane / ethyl acetate: 97 / 3, R_f = 0.9) led to decomposition. Calculated yield from ¹H NMR after first Kugelrohr distillation: 267 mg, 44% (with 44% of remaining starting material **1**). Other purification attempts using silica or alumina as a stationary phase or preconditioning the column with 5 % NEt₃ failed and it appeared that the product decomposes on the column.

¹H NMR (500 MHz, CDCl₃): δ = 7.44 (d, ³J = 3.6 Hz, 1 H, H-f), 7.25 (d, ³J = 3.6 Hz, 1 H, H-e), 1.33 (s, 12 H, H-i), 0.25 (s, 9 H, H-a) ppm.

¹³C NMR (126 MHz, CDCl₃): δ = 136.8 (C-f), 133.7 (C-e), 129.8 (C-d), 100.4 (C-b) 97.7 (C-c), 84.1 (C-h), 24.9 (C-i), -8.1 (C-a) ppm.¹⁶

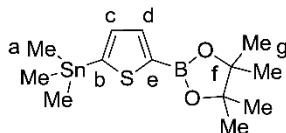
¹¹B NMR (160 MHz, CDCl₃): δ = 28.73 ppm.

HRMS (EI-sector) *m/z*: [M]⁺ Calcd for [C₂₀H₂₁O₄BS]⁺ 368.1254; Found 368.1256.

IR (ATR): Not measured due to a mixture of product and by-products.

M.p.: Not measured due to a mixture of product and by-products.

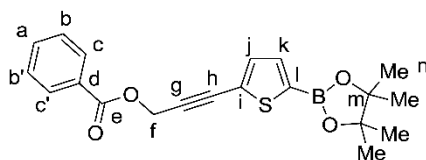
Data from the remaining starting material in the spectrum for comparative purposes:



¹H NMR (500 MHz, CDCl₃): δ = 7.76 (d, ³J = 3.3 Hz, 1 H, H-d), 7.29 (d, ³J = 3.3 Hz, 1 H, H-c), 1.34 (s, 12 H, H-g), 0.37 (s, 9 H, H-a) ppm.

¹³C NMR (126 MHz, CDCl₃): δ = 146.5 (C-b), 137.8 (C-d), 136.3 (C-c), 84.5 (C-f), 24.9 (C-g), -8.2 (C-a) ppm.

3-(5-(4,4,5,5-Tetramethyl-1,3,2-dioxaborolan-2-yl)thiophen-2-yl)prop-2-yn-1-yl benzoate (7d)



A solution of **1** (372.9 mg, 2.000 mmol), 3-bromoprop-2-yn-1-yl benzoate **6d** (239.1 mg, 2.000 mmol), [Pd(PPh₃)₄] (11.60 mg, 10 μmol, 1 mol%) in DMF (8 mL) was heated to 60 °C for 29 h. The mixture was filtered over a short plug of celite using diethyl ether (50 mL) as eluent. The solvent was removed *in vacuo* and ca. half of the crude product (328.0 mg of 871.0 mg) was purified by column chromatography (*n*hexane / ethyl acetate: 4 / 1, R_f = 0.8) to yield the

¹⁶Intensity of quarternary thiophene carbon atom (g) were too low for detection.

product (140.0 mg, 43%) with low amounts of impurities. A subsequent column chromatography (gradient from *n*hexane / ethyl acetate: 98 / 2 to 1 / 1; $R_f = 0.1$ [98 / 2]) led to fewer impurities, but the yield deteriorated (81.00 mg, 11%). Other purification attempts using alumina as a stationary phase or preconditioning the column with 5 % NEt_3 failed and it appeared that the product decomposes on the column.

Yield extrapolated from whole sample: 29%.

$^1\text{H NMR}$ (500 MHz, CDCl_3): $\delta = 8.11\text{--}8.08$ (m, 2 H, H-c), 7.60–7.56 (m, 1 H, H-a), 7.47 (d, $^3J = 3.6$ Hz, 1 H, H-k), 7.46–7.43 (m, 2 H, H-b), 7.29 (d, 1 H, 3.6 Hz, H-j), 5.18 (s, 2 H, H-f), 1.33 (s, 12 H, H-n) ppm.

$^{13}\text{C NMR}$ (126 MHz, CDCl_3): $\delta = 166.0$ (C-e), 137.0 (C-k) 134.0 (C-j), 133.4 (C-a), 130.0 (C-c), 129.7 (C-d), 128.6 (C-b), 128.1 (C-a), 88.5 (C-g), 84.5 (C-m), 80.1 (C-h), 53.5 (C-f), 24.9 (C-n) ppm.

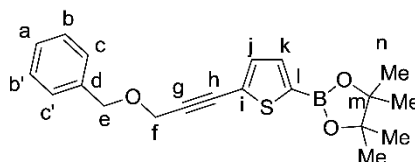
$^{11}\text{B NMR}$ (160 MHz, CDCl_3): $\delta = 28.41$ ppm.

HRMS (EI-sector) m/z : $[\text{M}]^+$ Calcd for $[\text{C}_{20}\text{H}_{21}\text{O}_4\text{BS}]^+$ 368.1254; Found 368.1256.

IR (ATR): Not measured due to a mixture of product and by-products.

M.p.: Not measured due to a mixture of product and by-products.

2-(5-(3-(Benzyloxy)prop-1-yn-1-yl)thiophen-2-yl)-4,4,5,5-tetramethyl-1,3,2-dioxaborolane (7e)



A solution of **1** (746 mg, 2.00 mmol), (3-bromoprop-2-yn-1-yl)oxy)methyl)benzene **6e** (450 mg, 2.00 mmol), $[\text{Pd}(\text{PPh}_3)_4]$ (23.0 mg, 20.0 μmol , 1 mol%) in DMF (8 mL) was heated to 60 °C for 29 h (when the reaction was completed as indicated by NMR). The mixture was filtered over a short plug of celite using diethyl ether (50 mL) as eluent. The solvent was removed *in vacuo* and the ca. half of the crude product (386 mg of 734 mg) was purified by column chromatography (gradient from *n*hexane / ethyl acetate: 98 / 2 to 1 / 1; $R_f = 0.1$ [98:2]) to yield a mixture of the product (80.0 mg, 11%) and low amounts of some other impurities as light green oil. Other purification attempts using alumina as a stationary phase or preconditioning the column with 5% NEt_3 failed and it appeared that the product decomposes on the column.

Yield extrapolated from whole sample: 21%.

$^1\text{H NMR}$ (500 MHz, CDCl_3): $\delta = 7.48$ (d, $^3J = 3.6$ Hz, 1 H, H-k), 7.40–7.34 (m, 5 H, H-a,b,c), 7.26 (d, $^3J = 3.6$ Hz, 1 H, H-j), 4.66 (s, 2 H, H-e), 4.42 (s, 2 H, H-f), 1.34 (s, 12 H, H-n) ppm.

$^{13}\text{C NMR}$ (126 MHz, CDCl_3): $\delta = 137.5$ (C-d), 137.0 (C-k) 133.5 (C-j), 132.6 (C-l), 129.1 (C-i), 128.6 (C-b/c), 128.4 (C-b/c), 128.1 (C-a), 90.6 (C-g), 84.5 (C-m), 80.0 (C-h), 71.9 (C-e), 58.2 (C-f), 24.9 (C-n) ppm.

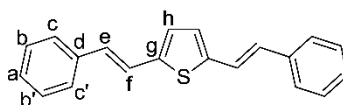
$^{11}\text{B NMR}$ (160 MHz, CDCl_3): $\delta = 28.29$ ppm.

HRMS (EI-sector) m/z : $[\text{M}]^+$ Calcd for $[\text{C}_{20}\text{H}_{23}\text{O}_3\text{BS}]^+$ 354.1461; Found 354.1463.

IR (ATR): Not measured due to a mixture of product and by-products.

M.p.: Not measured due to a mixture of product and by-products.

2,5-Di((*E*)-styryl)thiophene (8a)



A solution of **1** (186 mg, 0.500 mmol), β -bromostyrene (*E* / *Z* 8:1) (91.0 mg, 0.500 mmol), and $[\text{Pd}(\text{PPh}_3)_4]$ (5.78 mg, 5.00 μmol , 1 mol%) in DMF (4 mL) was heated to 60 °C for 17 h. Then, β -bromostyrene (*E* / *Z* = 8 / 1) (91.0 mg, 0.50 mmol) in DMF (4 mL) was added to the solution in one portion, followed by a solution of K_2CO_3 (138 mg, 1.00 mmol)

5 Experimental Section

in degassed water (1 mL) also in one portion. The solution was heated to 100 °C for 6 h. After it cooled down to 20 °C, the solution was diluted with DCM (8 mL) and filtered through a short plug of silica with DCM (250 mL). After removing the volatiles *in vacuo*, the crude product was purified by column chromatography (*n*pentane / DCM: 9 / 1, $R_f = 0.33$) to afford the product (124 mg, 86%) as yellow solid.

$^1\text{H NMR}$ (600 MHz, CD_2Cl_2): $\delta = 7.49$ (d, $^3J = 7.6$ Hz, 4 H, H-c, c'), 7.39–7.34 (m, 4 H, H-b, b'), 7.26 (t, $^3J = 7.4$ Hz, 2 H, H-a), 7.23 (d, $^3J = 16.1$ Hz, 2 H, H-f), 7.00 (s, 2 H, H-h), 6.94 (d, $^3J = 16.1$ Hz, 2 H, H-e) ppm.

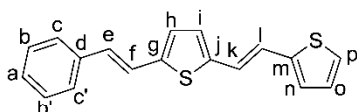
$^{13}\text{C NMR}$ (151 MHz, CD_2Cl_2): $\delta = 142.3$ (C-g), 137.4 (C-d), 129.2 (C-b, b'), 128.8 (C-e), 128.1 (C-a), 127.7 (C-h), 126.7 (C-c, c'), 122.2 (C-f) ppm.

HRMS (EI-sector) *m/z*: $[\text{M}]^+$ Calcd for $[\text{C}_{20}\text{H}_{16}\text{S}]^+$ 288.0973; Found 288.0980.

IR (ATR): $\tilde{\nu} = 3056$ (w), 3018 (w), 1621 (w), 1595 (m), 1488 (w), 1442 (m), 1236 (m), 1073 (w), 1041 (m), 950 (vs), 886 (w), 842 (w), 793 (vs), 745 (s), 689 (vs), 592 (m), 549 (vs), 524 (m), 468 (m) cm^{-1} .

M.p.: 187 °C.

2-((*E*-Styryl)-5-((*E*)-2-(thiophen-2-yl)vinyl)thiophene (8b)



A solution of **1** (186 mg, 0.500 mmol), β -bromostyrene (*E* / *Z* = 8 / 1) (91.0 mg, 0.500 mmol), and $[\text{Pd}(\text{PPh}_3)_4]$ (5.78 mg, 5.00 μmol , 1 mol%) in DMF (4 mL) was heated to 60 °C for 17 h. Then, 2-(2-bromovinyl)thiophene **2f** (*E* / *Z* = 5 / 1) (94.0 mg, 0.500 mmol), in DMF (4 mL) was added to the solution in one portion, followed by a solution of K_2CO_3 (138 mg, 1.00 mmol) in degassed water (1 mL), also in one portion. The solution was heated to 100 °C for 6 h. After the solution cooled down to 20 °C, it was diluted with DCM (8 mL) and filtrated through a short plug of silica with DCM (250 mL). After removing the volatiles *in vacuo*, the crude product was purified by column chromatography (*n*pentane / DCM: 95 / 5, $R_f = 0.30$) to afford the product (125 mg, 85%) as yellow solid.

$^1\text{H NMR}$ (600 MHz, CD_2Cl_2): $\delta = 7.42$ (d, $^3J = 7.3$ Hz, 2 H, H-c, c'), 7.38–7.34 (m, 2 H, H-b, b'), 7.22–7.13 (m, 3 H, H-a, e/f/k/l/h/i/n/o/p), 7.03–7.01 (m, 1 H, H-h/i/n/o/p), 7.01–6.93 (m, 3 H, H-e/f/k/l/h/i/n/o/p), 6.92 (d, $^3J = 3.7$ Hz, 1 H, H-h/i/n/o/p), 6.89 ((d, $^3J = 3.7$ Hz, 1 H, H-h/i/n/o/p), 6.86 (d, $^3J = 16.1$ Hz, 1 H, H-e/f/k/l) ppm.¹⁷

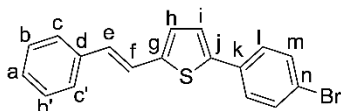
$^{13}\text{C NMR}$ (151 MHz, CD_2Cl_2): $\delta = 142.8$, 142.3, 141.8 (C-g/j/m), 137.3 (C-d), 129.2 (C-b, b'), 128.9, 128.2, 128.1, 127.8, 127.6 (C-a/e/f/k/l/h/i/n/o/p), 126.7 (C-c, c', h/i/n/o/p), 125.0, 122.1, 122.0, 121.8 (C-e/f/k/l/h/i/n/o/p) ppm.

HRMS (EI-sector) *m/z*: $[\text{M}]^+$ Calcd for $[\text{C}_{18}\text{H}_{14}\text{S}_2]^+$ 294.0537; Found 294.0534.

IR (ATR): $\tilde{\nu} = 3064$ (w), 3018 (w), 1787 (w), 1594 (m), 1492 (m), 1446 (m), 1420 (m), 1364 (w), 1282 (w), 1226 (m), 1074 (w), 1040 (m), 941 (vs), 855 (m), 810 (s), 789 (s), 746 (s), 689 (vs), 575 (m), 544 (s), 466 (m) cm^{-1} .

M.p.: 143 °C

(*E*)-2-(4-bromophenyl)-5-styrylthiophene (8c)



A solution of **1** (186 mg, 0.500 mmol), β -bromostyrene (*E* / *Z* = 8 / 1) (91.0 mg, 0.500 mmol), and $[\text{Pd}(\text{PPh}_3)_4]$ (5.78 mg, 5.00 μmol , 1 mol%) in DMF (4 mL) was heated to 60 °C for 17 h. Then, 1-bromo-4-iodobenzene (141 mg, 0.50 mmol) in DMF (4 mL) was added to the solution in one portion, followed by a solution of K_2CO_3 (138 mg, 1.00 mmol) in degassed water (1 mL), also in one portion. The solution was heated to 100 °C for 6 h. After it cooled down to 20 °C, the solution was diluted with DCM (8 mL) and filtrated through a short plug of silica with DCM (250 mL). After removing the volatiles

¹⁷ It was not possible to distinguish all of the peaks because of peak overlap. The same was the case for the $^{13}\text{C NMR}$ spectrum.

in vacuo, the crude product was purified by column chromatography (*n*pentane / DCM: 95 / 5, R_f = 0.41) to afford the product (128 mg, 75%) as yellow solid.

$^1\text{H NMR}$ (600 MHz, CD_2Cl_2): δ = 7.54–7.47 (m, 6 H, H-c, c', l, m), 7.39–7.34 (m, 2 H, H-b, b'), 7.29–7.20 (m, 3 H, H-a, f, h), 7.07 (d, 3J = 3.7 Hz, 1 H, H-i), 6.97 (d, 3J = 16.1 Hz, 1 H, H-e) ppm.

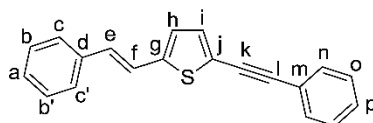
$^{13}\text{C NMR}$ (151 MHz, CD_2Cl_2): δ = 143.2 (C-g), 141.9 (C-k), 137.3 (C-d), 133.6 (C-j), 132.4 (C-l/m), 129.2 (C-b, b'), 129.0 (C-e), 128.2 (C-a), 128.0 (C-i), 127.5 (C-l/m), 126.7 (C-c, c'), 124.6 (C-h), 122.0 (C-f), 121.7 (C-n) ppm.

HRMS (EI-sector) m/z : $[\text{M}]^+$ Calcd for $[\text{C}_{28}\text{H}_{13}\text{BrS}]^+$ 339.9921; Found 339.9926.

IR (ATR): $\tilde{\nu}$ = 3066 (w), 3018 (w), 1593 (w), 1482 (m), 1444 (m), 1399 (m), 1276 (m), 1235 (w), 1116 (m), 1075 (m), 1006 (m), 948 (s), 820 (s), 795 (vs), 747 (vs), 689 (vs), 568 (m), 552 (m), 503 (s), 469 (m) cm^{-1} .

M.p.: 170 °C.

(*E*)-2-(phenylethynyl)-5-styrylthiophene (8d)



A solution of **1** (186 mg, 0.500 mmol), β -bromostyrene (*E* / *Z* = 8 / 1) (91.0 mg, 0.500 mmol), and $[\text{Pd}(\text{PPh}_3)_4]$ (5.78 mg, 5.00 μmol , 1 mol%) in DMF (4 mL) was heated to 60 °C for 17 h. Then, (bromoethynyl)benzene **6b** (90.5 mg, 0.50 mmol), in DMF (4 mL) was added to the solution in one portion, followed by a solution of K_2CO_3 (138 mg, 1.00 mmol) in degassed water (1 mL), also in one portion. The solution was heated to 100 °C for 6 h. After it cooled down to 20 °C, the solution was diluted with DCM (8 mL) and filtrated through a short plug of silica with DCM (250 mL). After removing the volatiles *in vacuo*, the crude product was purified by column chromatography (*n*pentane, R_f = 0.25) to afford the product (51 mg, 37%) as yellow solid.

$^1\text{H NMR}$ (600 MHz, CD_2Cl_2): δ = 7.56–7.51 (m, 2 H, H-n), 7.50 (d, 3J = 7.5 Hz, 2 H, H-c, c'), 7.31–7.35 (m, 5 H, H-b, b', o, p), 7.28 (t, 3J = 7.4 Hz, 1 H, H-a), 7.24–7.18 (m, 2 H, H-f, i), 7.01 (d, 3J = 3.7 Hz, 1 H, H-h), 6.97 (d, 3J = 16.1 Hz, H-e) ppm.

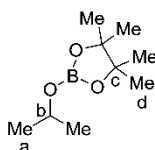
$^{13}\text{C NMR}$ (151 MHz, CD_2Cl_2): δ = 145.0 (C-g), 137.1 (C-d'), 133.2 (C-i), 131.7 (C-n), 129.7 (C-e), 129.2, 129.0, 128.9 (C-b, b', o, p), 128.4 (C-a), 126.8 (C-h, c), 123.2 (C-m), 122.1 (C-i), 121.6 (C-f), 94.5 (C-l), 83.3 (C-k) ppm.

HRMS (EI-sector) m/z : $[\text{M}]^+$ Calcd for $[\text{C}_{20}\text{H}_{14}\text{S}]^+$ 286.0816; Found 286.0814.

IR (ATR): $\tilde{\nu}$ = 3053 (w), 3016 (w), 1592 (m), 1520 (m), 1485 (m), 1442 (m), 1276 (m), 1224 (m), 1189 (m), 1070 (m), 1029 (m), 952 (s), 914 (m), 885 (w), 839 (w), 797 (s), 747 (vs), 688 (vs), 599 (m), 543 (m), 523 (m), 465 (w) cm^{-1} .

M.p.: 152 °C.

2-isoPropyloxy-4,4,5,5-tetramethyl-1,3,2-dioxaborolane (*i*PrO-BPin) (**9**)



For the convenience of the reader, the data are reproduced from the supporting information of work by Linshoef et al.^[1] in our group.

2-isoPropyloxy-4,4,5,5-tetramethyl-1,3,2-dioxaborolane was prepared similarly to a method described by Andersen et al.^[11] and was modified as follows.

Tri-*i*sopropyl borate (31.8 g, 169 mmol) and pinacol (20.0 g, 169 mmol) in *n*hexane (50 mL) were heated to 90 °C (external temperature) and an *i*sopropanol / hexane azeotrope was removed by distillation within 16 h. The residue was distilled (90 °C oil bath, 16 mbar) to afford the product (26.9 g, 86%, Lit.^[11]: 92%) as colorless, air and moisture sensitive oil.

5 Experimental Section

¹H NMR (500 MHz, CDCl₃): δ = 4.29 (septet, ³J = 6.2 Hz, 1 H, H-b), 1.20 (s, 12 H, H-d), 1.15 (d, ³J = 6.2 Hz, 6 H, H-a) ppm.

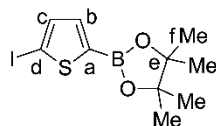
¹³C NMR (126 MHz, CDCl₃): δ = 82.5 (C-c), 67.4 (C-b), 24.6 (C-d), 24.4 (C-a) ppm.

¹¹B NMR (160 MHz, CDCl₃): δ = 21.8 ppm.

HRMS (EI-sector) m/z: [M]⁺ Calcd for [C₉H₁₉BO₃]⁺ 186.1427; Found 186.1420.

IR (ATR): $\tilde{\nu}$ = 2979 (w), 1504 (w), 1473 (w), 1444 (m), 1373 (w), 1345 (w), 1319 (m), 1148 (m), 1121 (m), 958 (w), 905 (s), 852 (m), 727 (s), 672 (m), 648 (m) cm⁻¹.

2-(5-Iodothiophen-2-yl)-4,4,5,5-tetramethyl-1,3,2-dioxaborolane (10)



A solution of diisopropylamine (7.08 g, 70.0 mmol) in THF (200 mL) was cooled to -78 °C and *n*Butyllithium (20.0 mL, 50.0 mmol) was added dropwise over the course of 1 h. The mixture was warmed to 0 °C within 30 min by replacing the dry ice bath with ice bath. Then the reaction mixture was cooled again to -78 °C and stirring was continued for 5 min. 2-Iodothiophene (10.5 g, 50.0 mmol) in THF (20 mL) was added over the course of 25 min and the reaction mixture was stirred for 1 h at -78°C. 2-*isopropoxy*-4,4,5,5-tetramethyl-1,3,2-dioxaborolane (10.2 g, 55.0 mmol) was added dropwise within 30 min to the orange-brown suspension and the reaction mixture was stirred for 19 h while it was allowed to warm to 20 °C without removal of the cooling bath. The reaction was quenched with a saturated solution of ammonium chloride (50 mL) and the aqueous layer was extracted with ethyl acetate (3 x 100 mL). The combined organic layers were dried over MgSO₄. The volatiles were removed *in vacuo* to obtain the product (16.7 g, 99%) of oil that crystallized after 18 h at 5 °C to give a pale yellow solid.

¹H NMR (500 MHz, CDCl₃): δ = 7.29 (d, ³J = 3.6 Hz, 1 H, H-b/c), 7.27 (d, ³J = 3.6 Hz, 1 H, H-b/c), 1.33 (s, 12 H, H-f) ppm.

¹³C NMR (126 MHz, CDCl₃): δ = 138.5 (C-b/c), 138.3 (C-b/c), 84.3 (C-e), 81.5 (C-d), 24.7 (C-f) ppm.

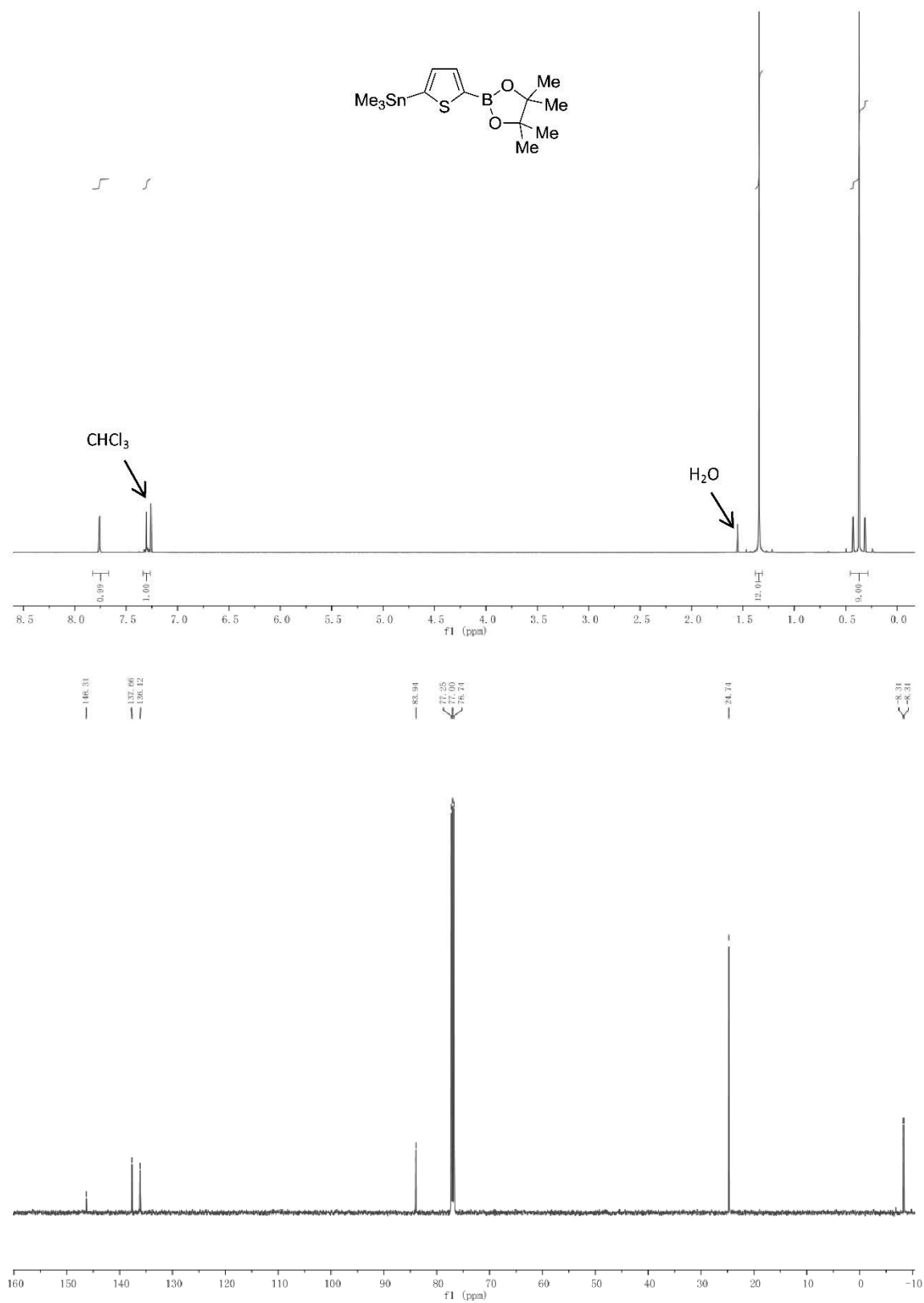
¹¹B-NMR (160 MHz, CDCl₃): δ = 28.2 ppm.

HRMS (EI-sector) m/z: [M]⁺ Calcd for [C₁₀H₁₄O₂BIS]⁺ 335.9852; Found 335.9851.

IR (ATR): $\tilde{\nu}$ = 2978 (m), 2929 (w), 1516 (s), 1414 (s), 1341 (s), 1322 (s), 1266 (m), 1136 (s), 1065 (m), 1019 (m), 849 (s), 815 (m), 798 (m), 661 (s), 430 (s) cm⁻¹.

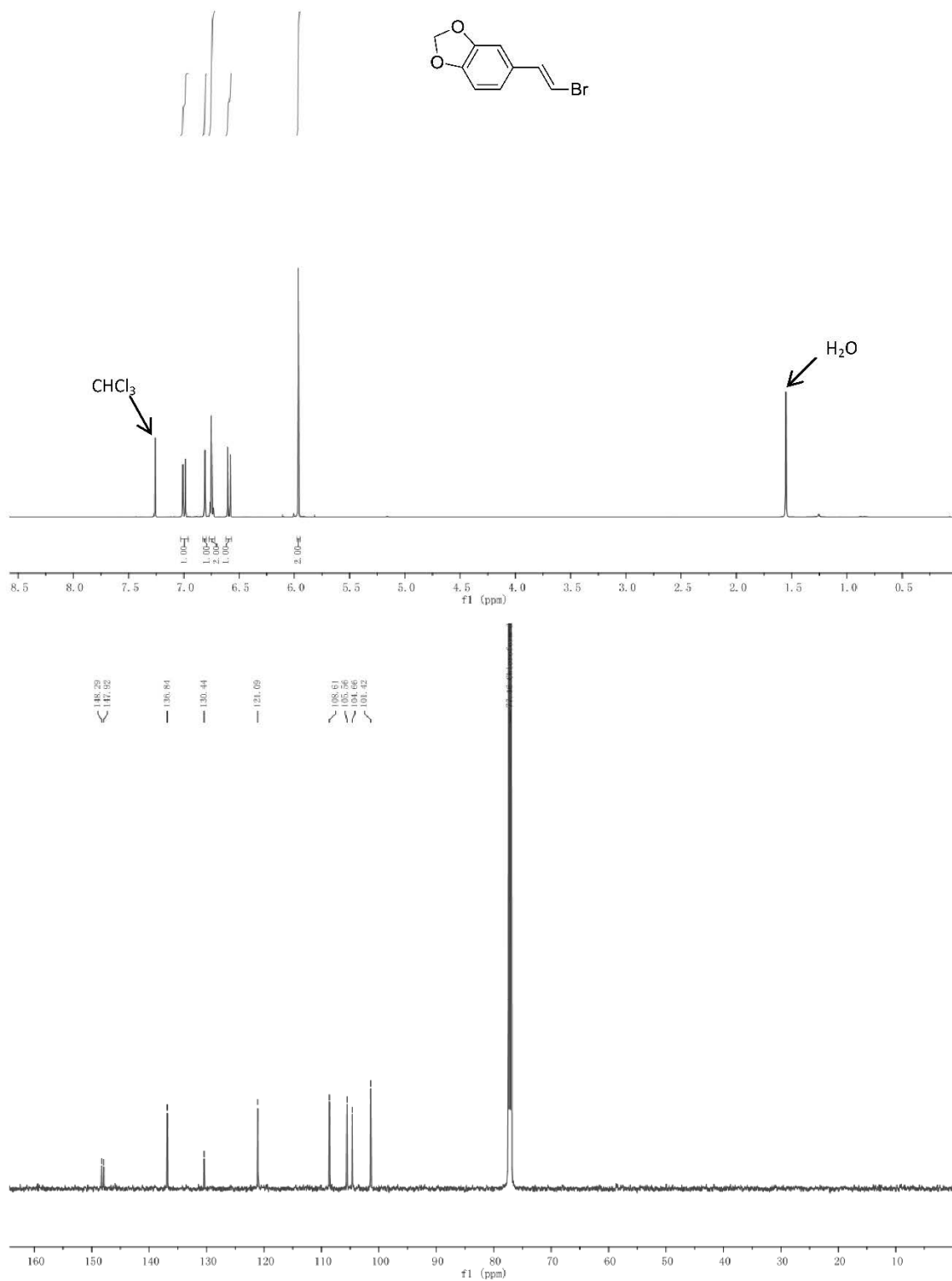
M.p.: 43 °C.

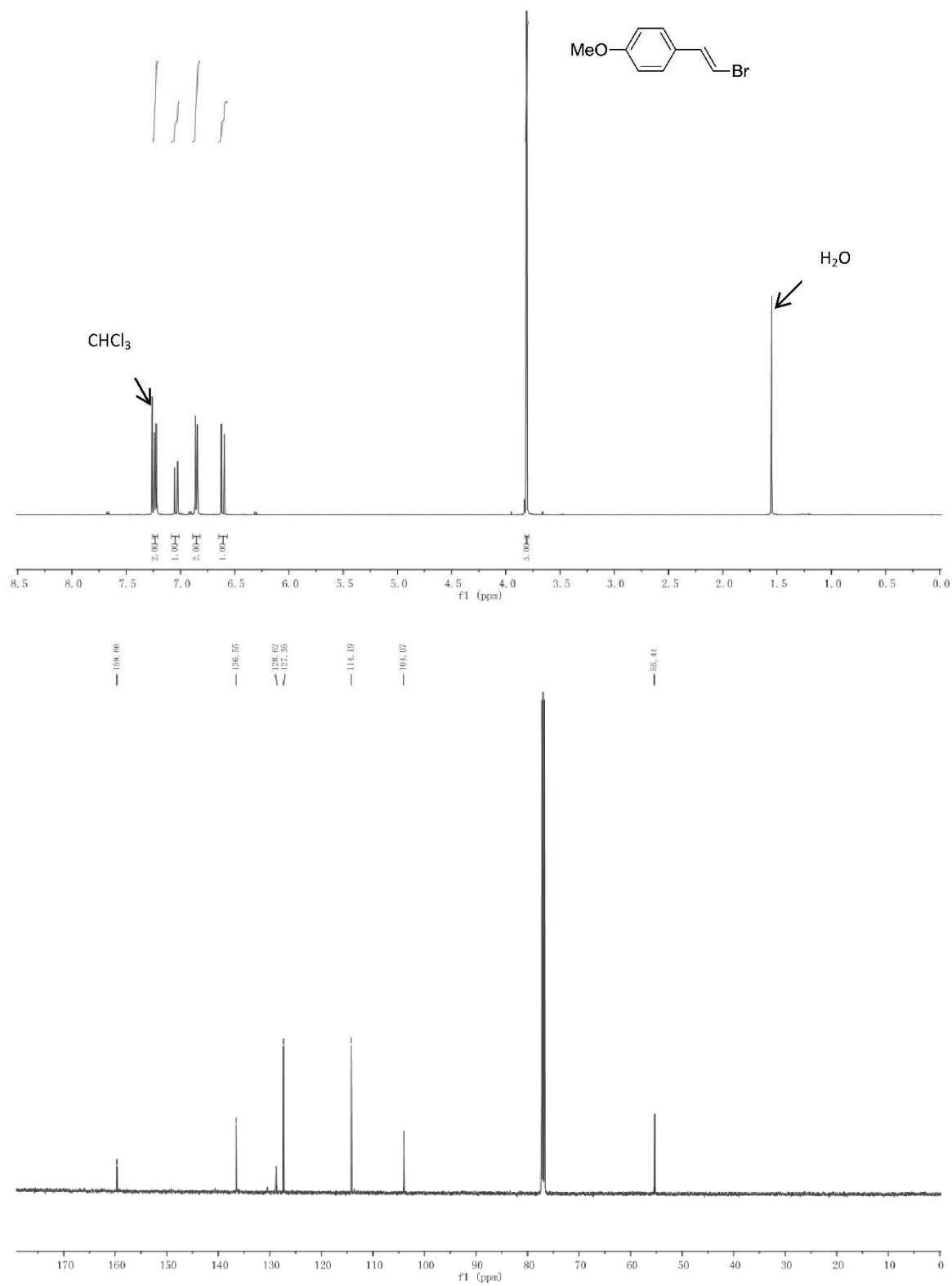
NMR Spectra (^1H NMR spectra followed by ^{13}C $\{^1\text{H}\}$ NMR spectra)
4,4,5,5-Tetramethyl-2-(5-(trimethylstannyl)thiophen-2-yl)-1,3,2-dioxaborolane (1)



5 Experimental Section

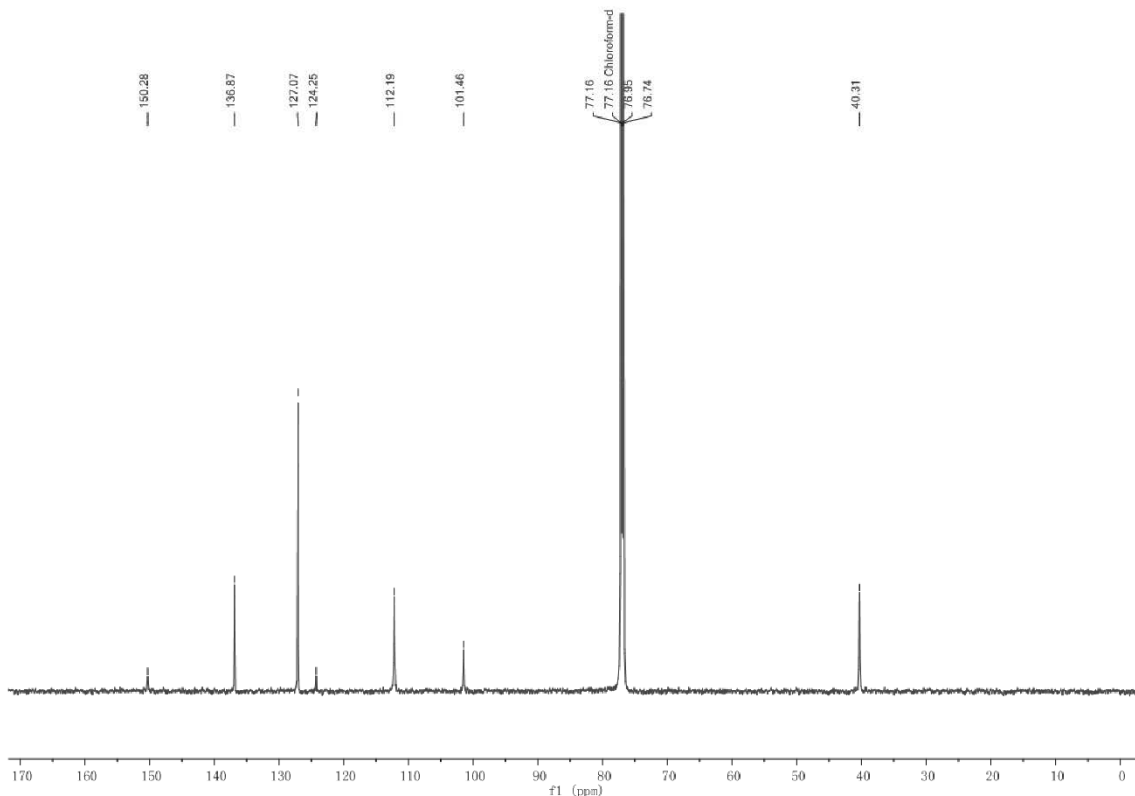
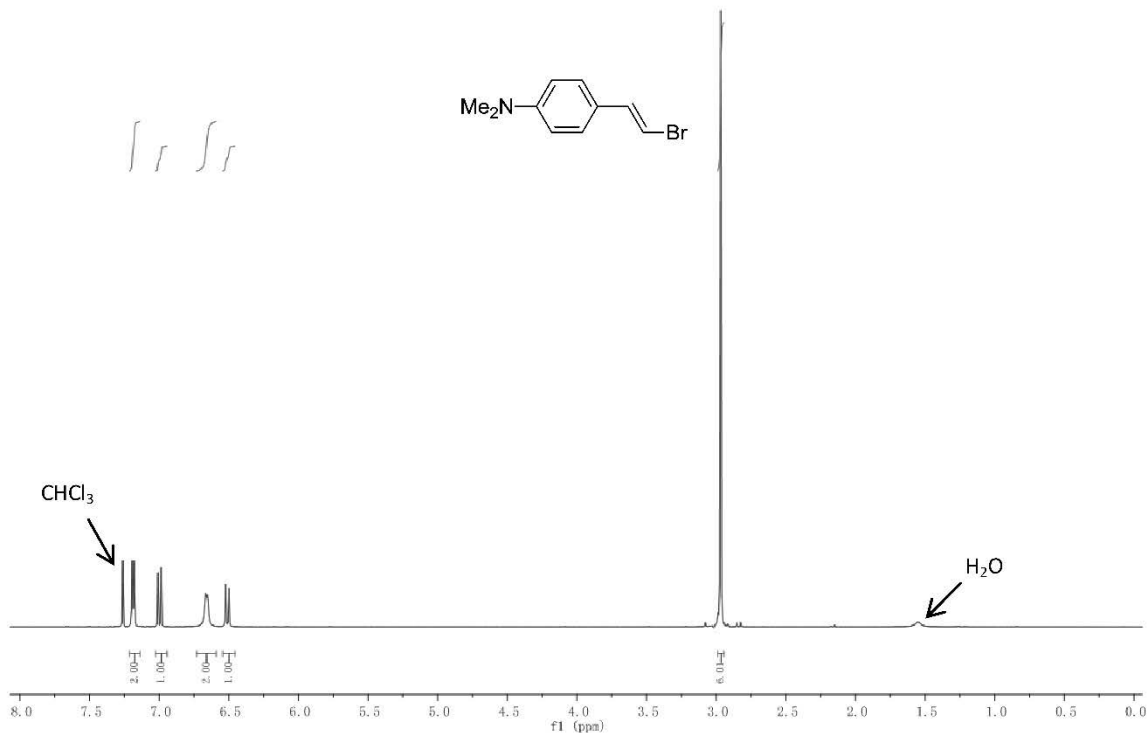
(*E*)-5-(2-Bromovinyl)benzo[d][1,3]dioxole (2b)

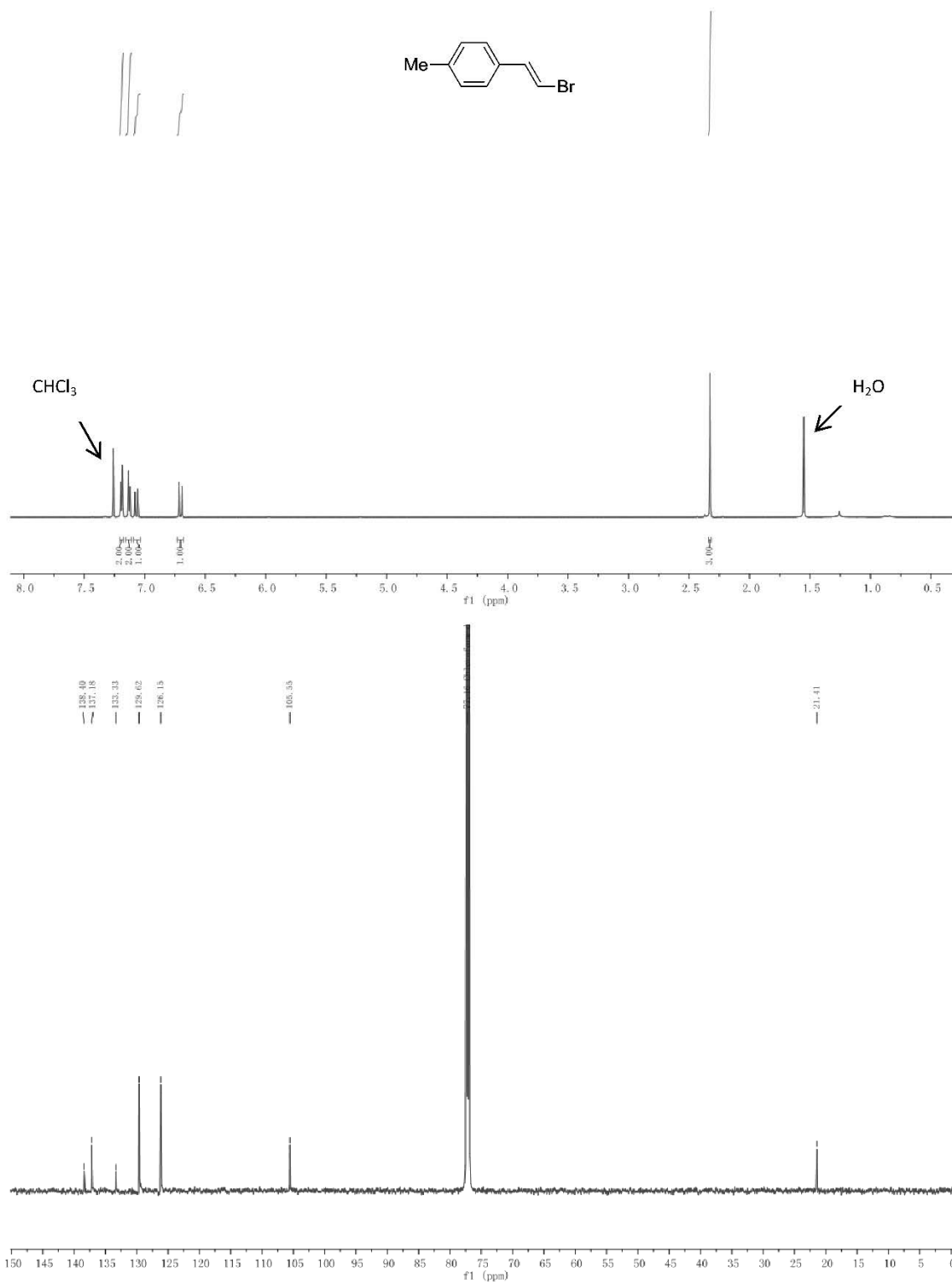


(E)-1-(2-Bromovinyl)-4-methoxybenzene (2c)

5 Experimental Section

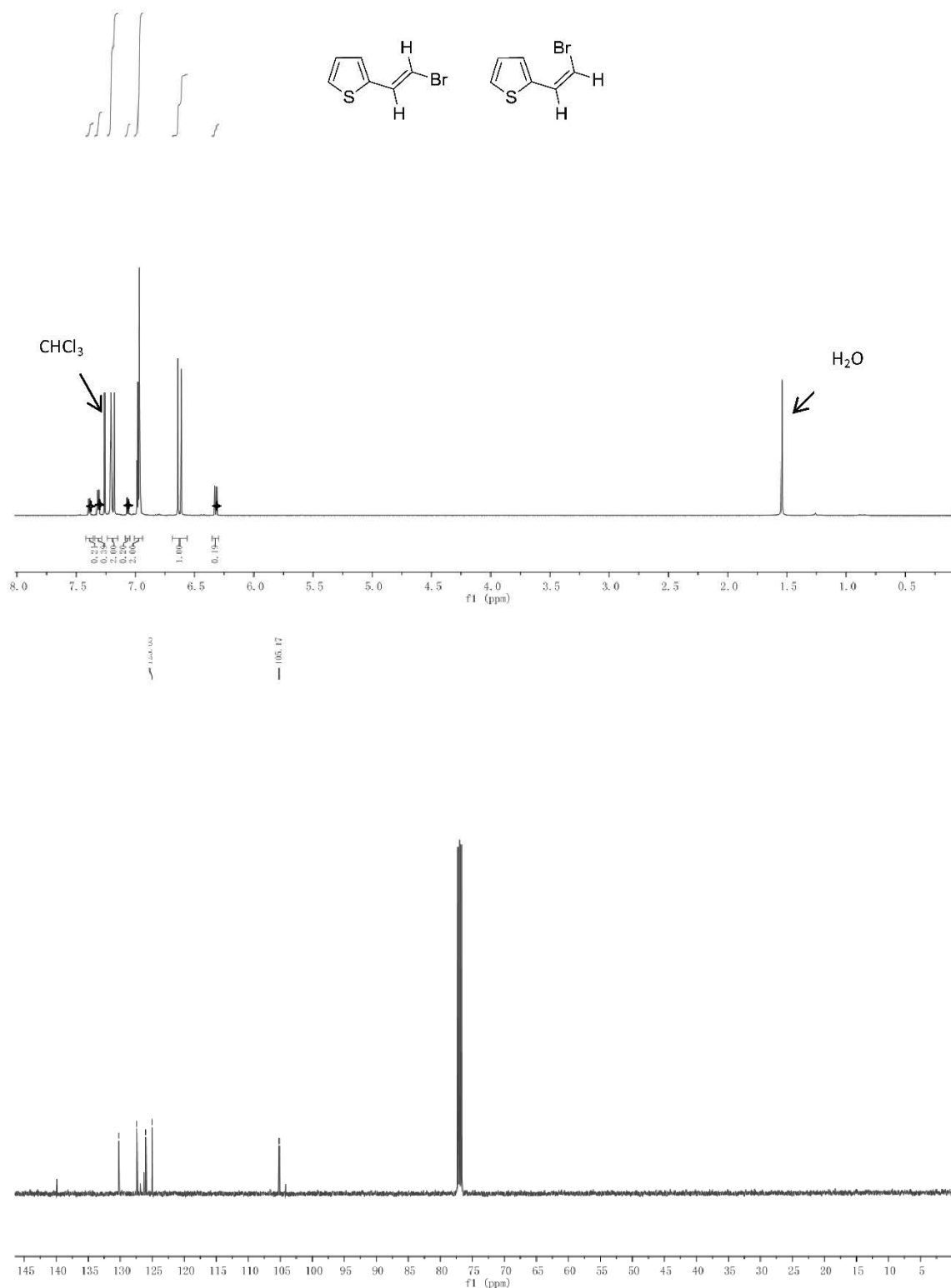
(E)-4-(2-Bromovinyl)-N,N-dimethylaniline (2d)



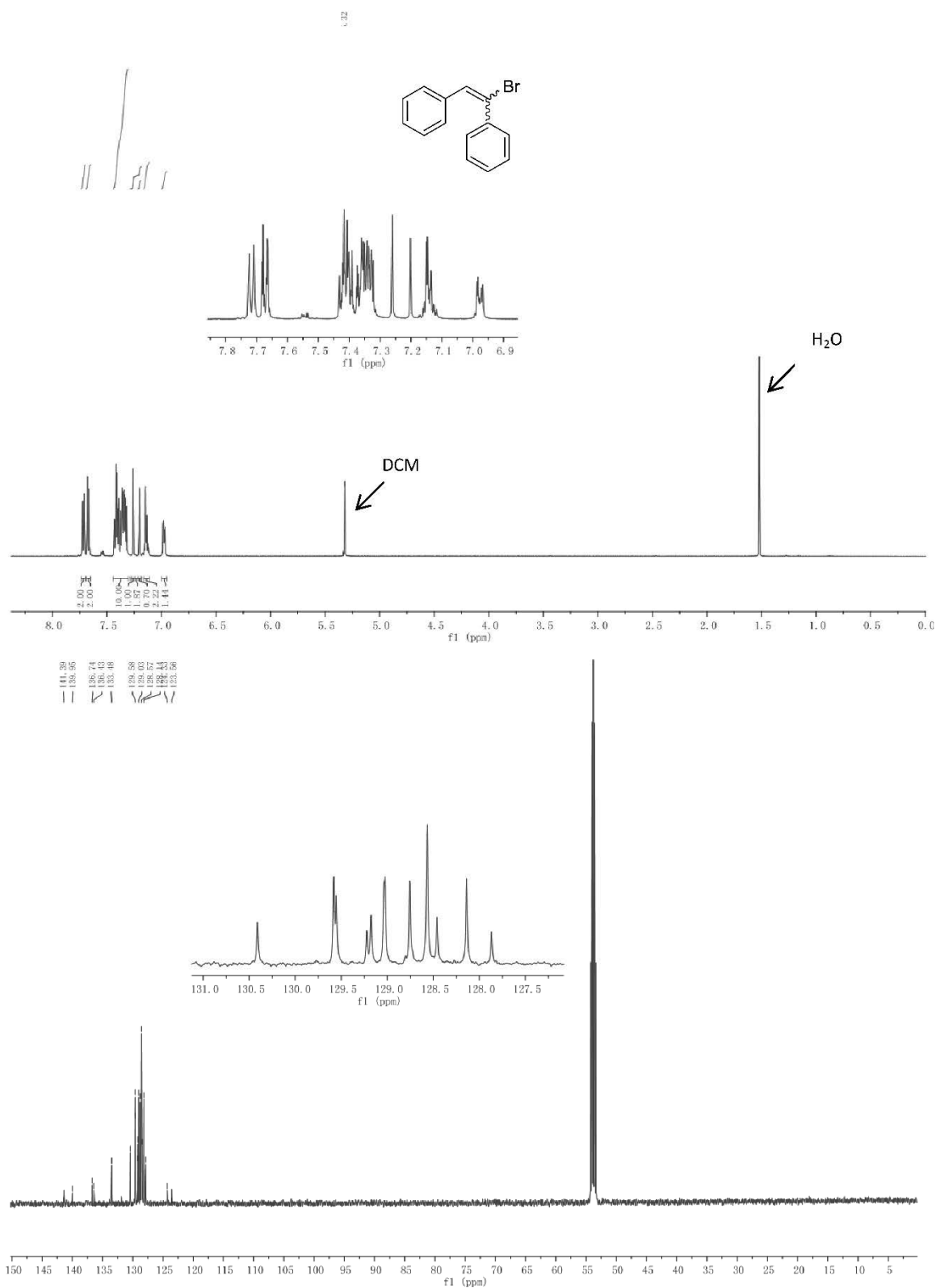
(E)-1-(2-Bromovinyl)-4-methylbenzene (2e)

5 Experimental Section

2-(2-Bromovinyl)thiophene, (*Z*)-2-(2-bromovinyl)thiophene (*) (2f)

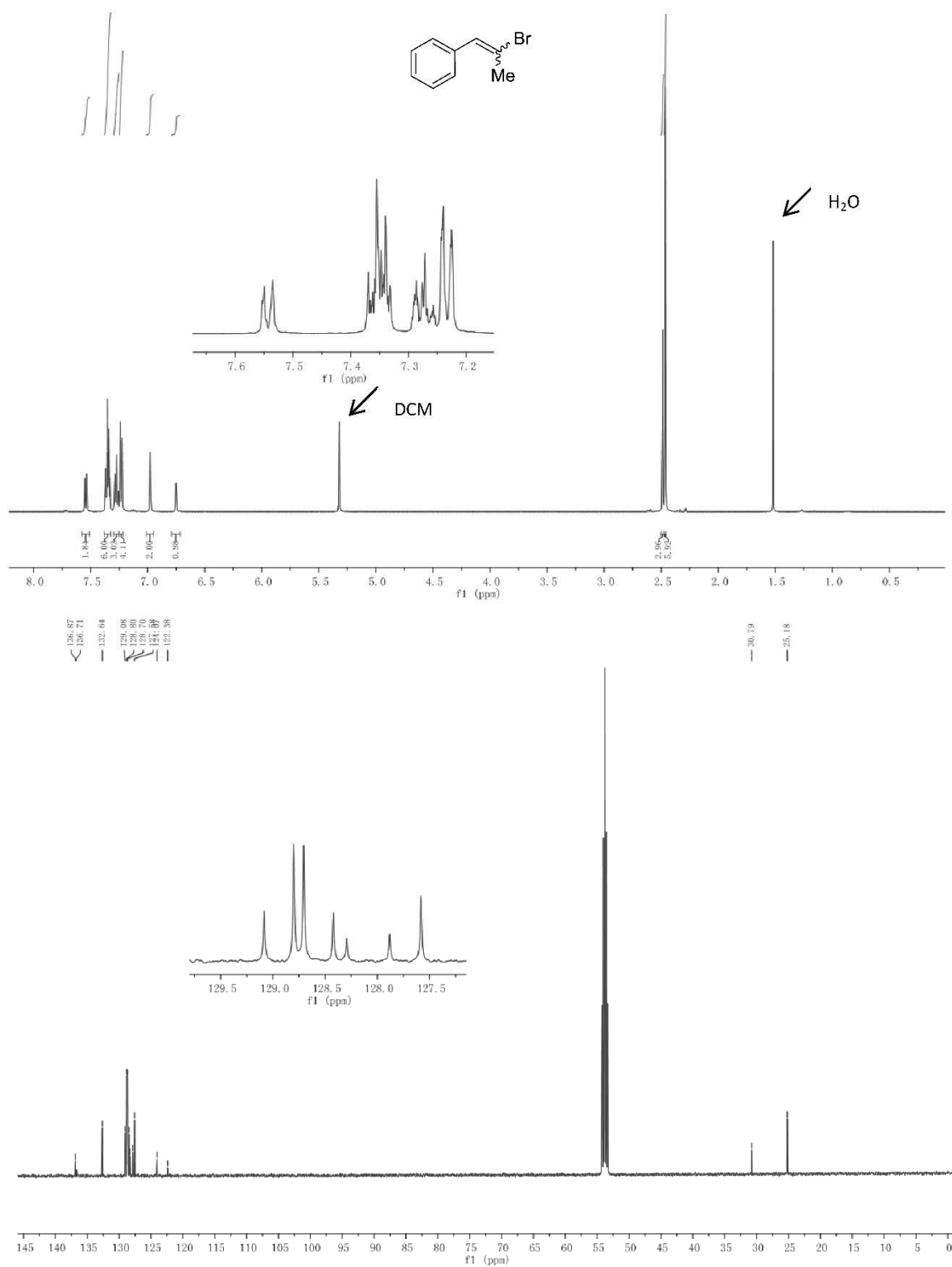


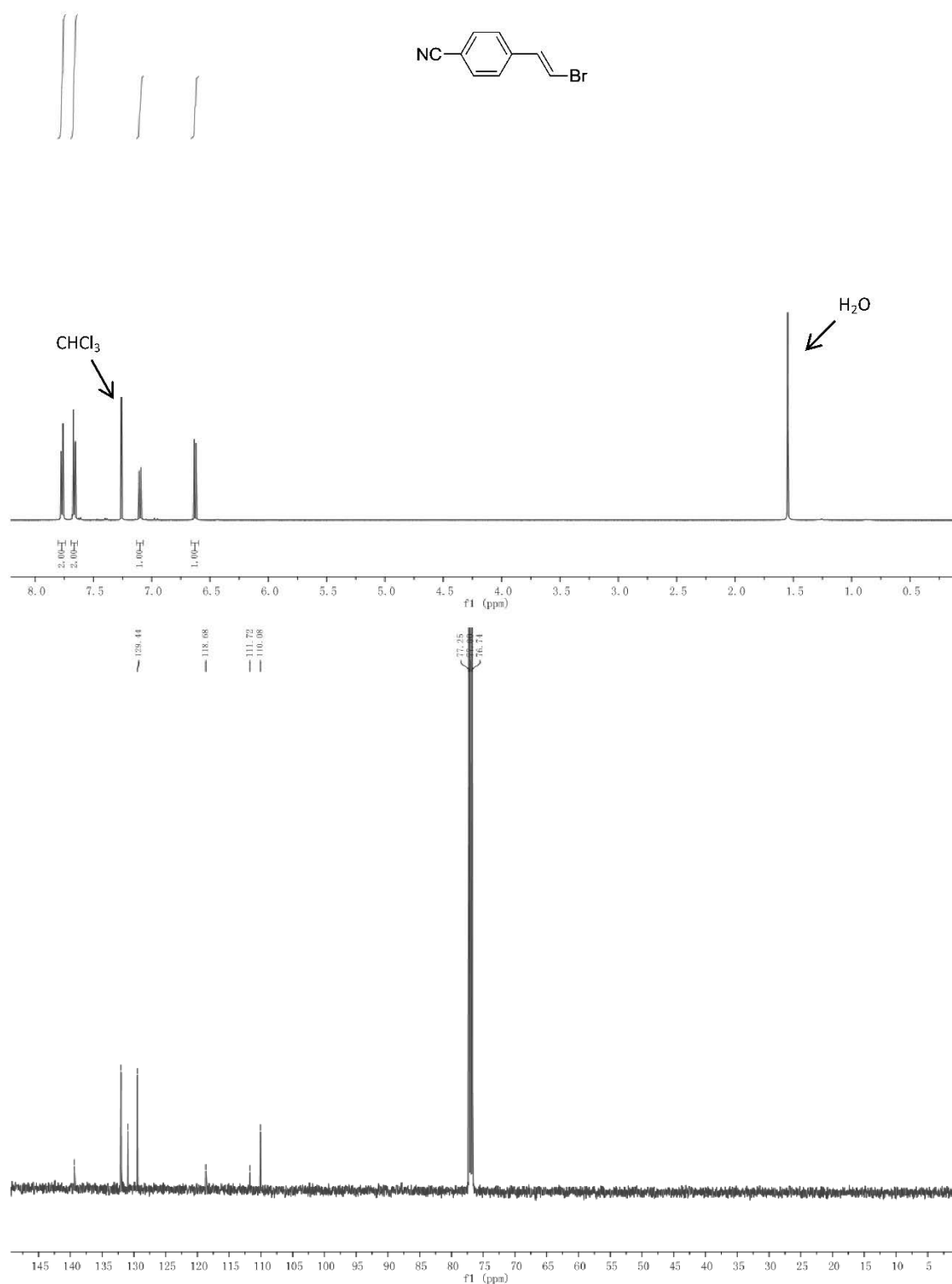
(1-Bromoethene-1,2-diyl)dibenzene (2g)



5 Experimental Section

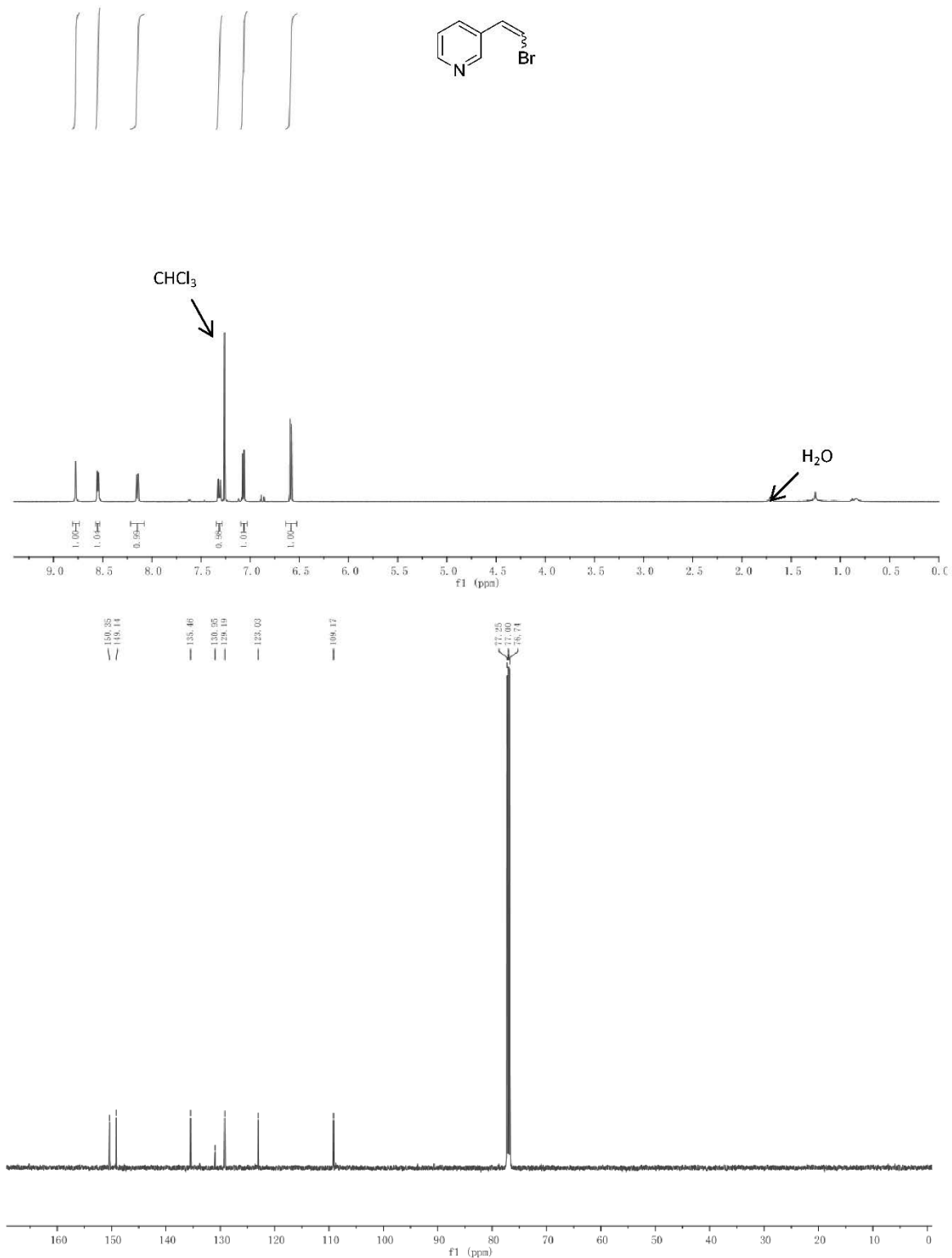
(2-Bromoprop-1-en-1-yl)benzene (2h)

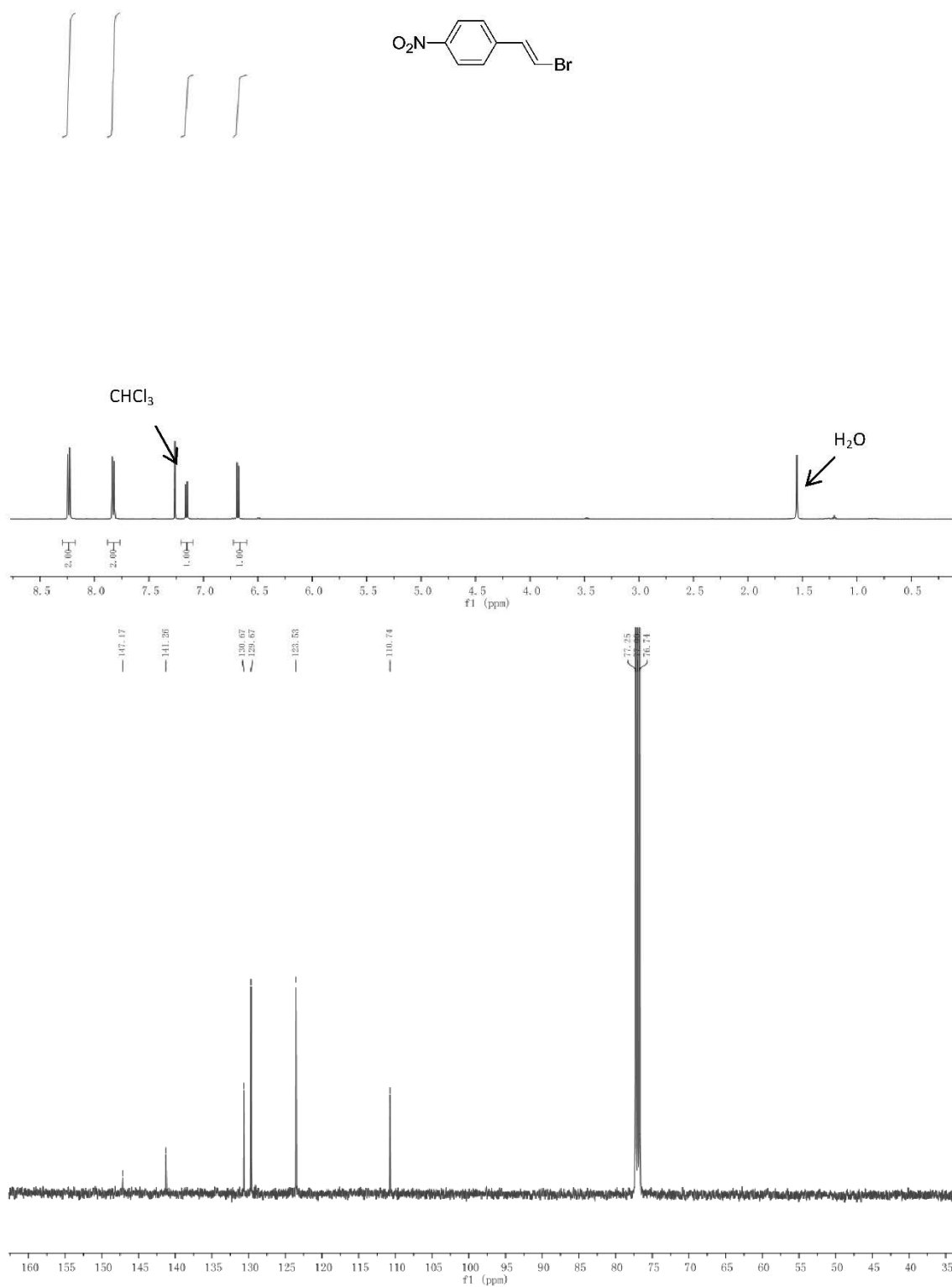


(E)-4-(2-Bromovinyl)benzonitrile (2i)

5 Experimental Section

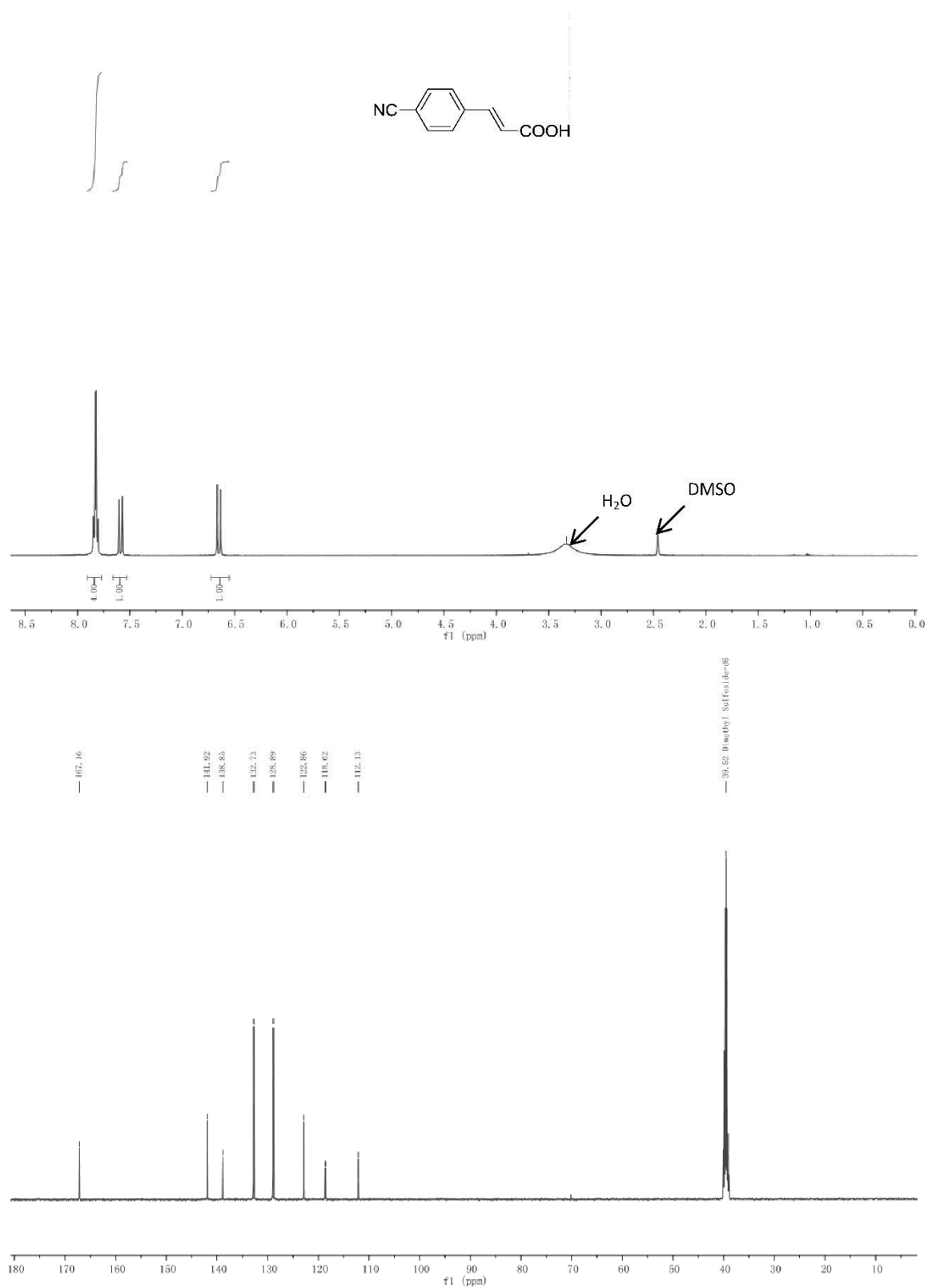
3-(2-Bromovinyl)pyridine (2j)

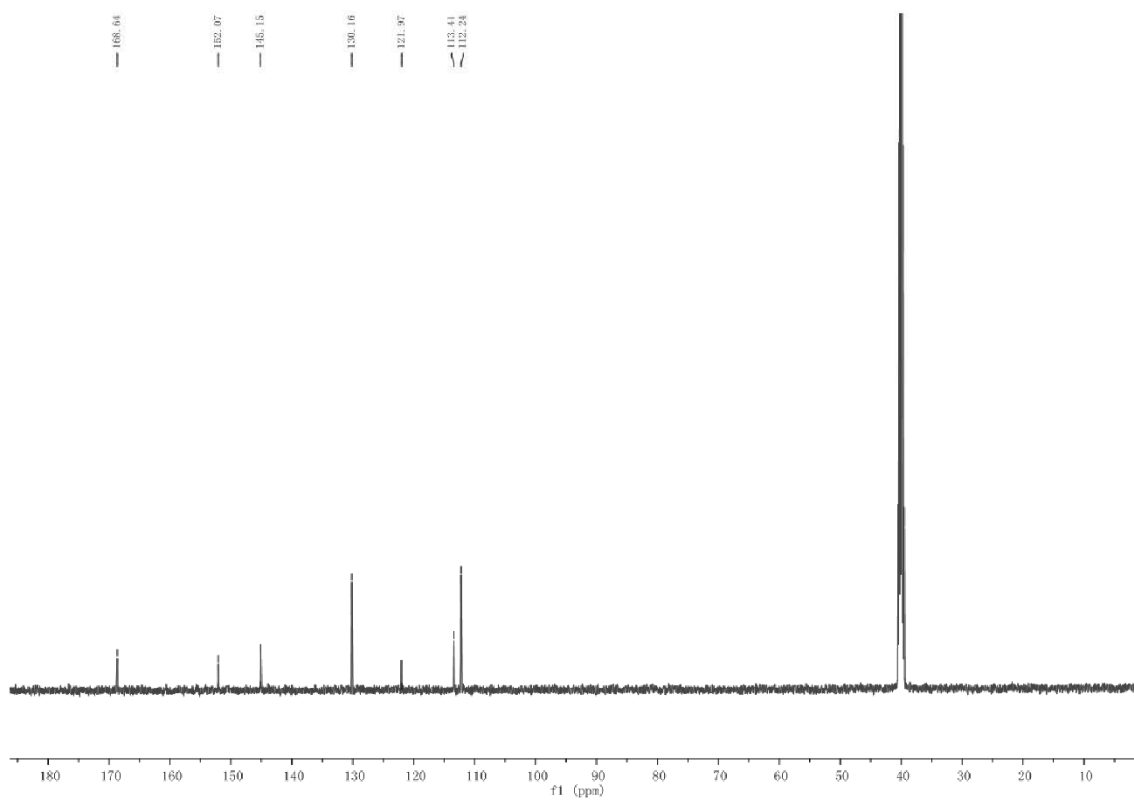
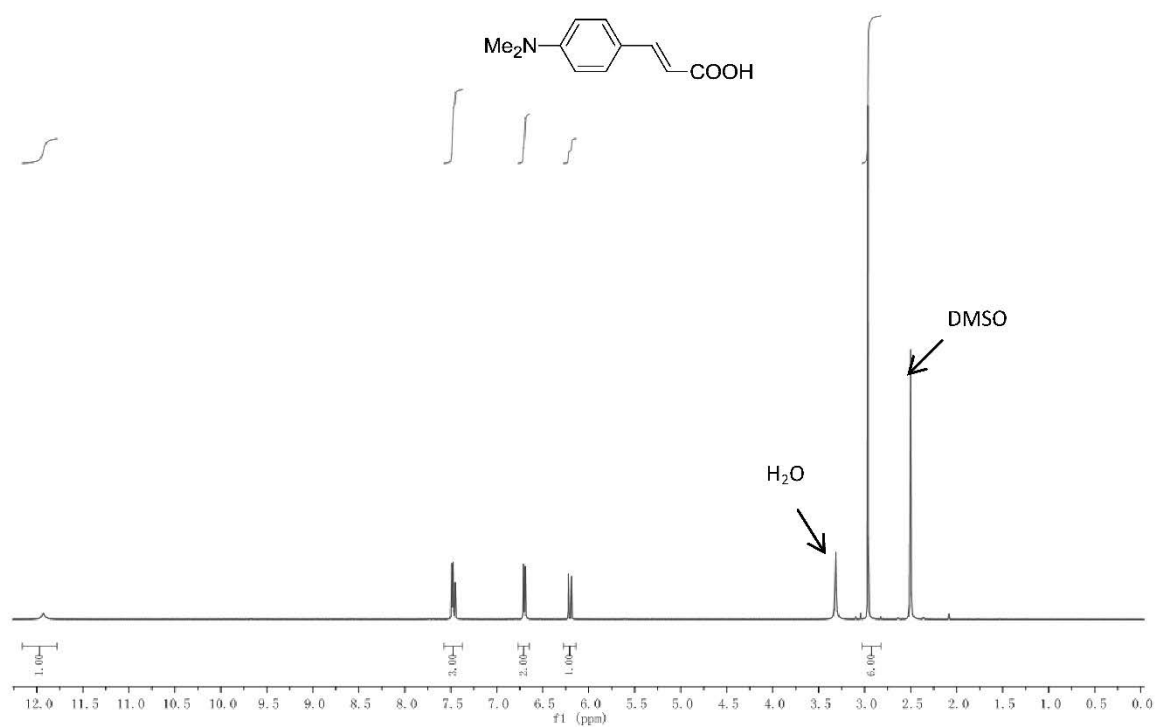


(E)-1-(2-Bromovinyl)-4-nitrobenzene (2k)

5 Experimental Section

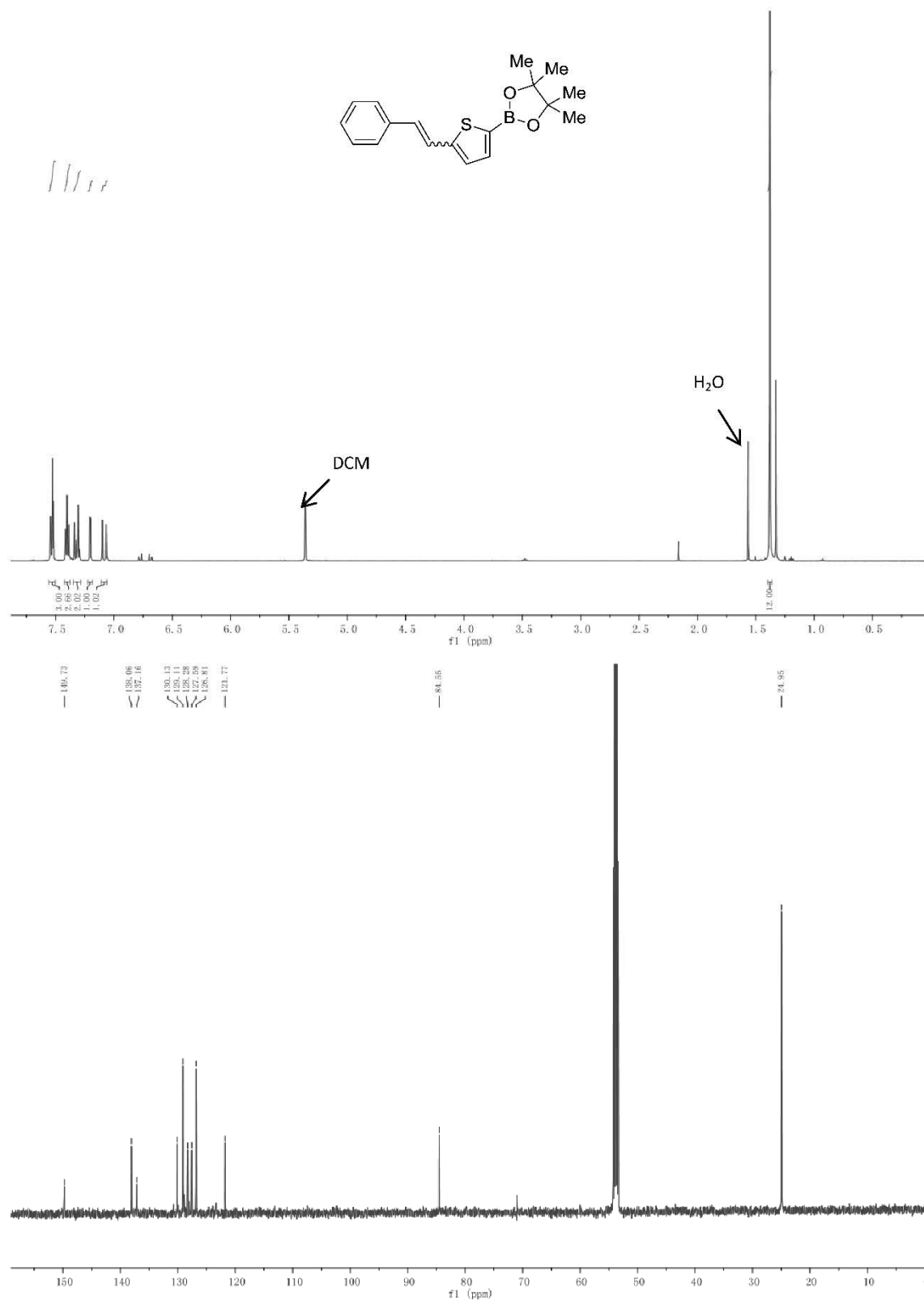
(E)-3-(4-Cyanophenyl)acrylic acid (2l)

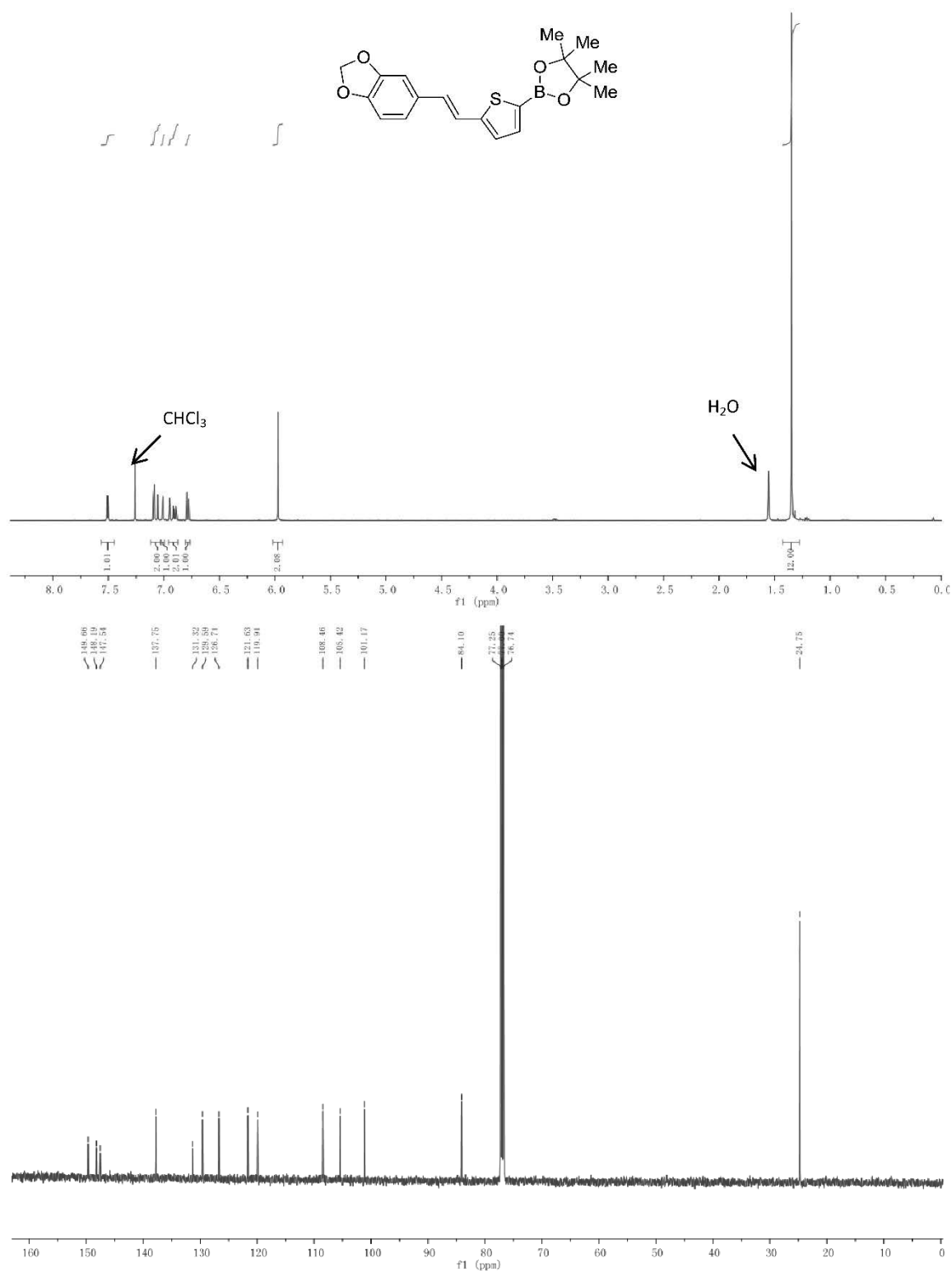


(E)-3-(4-(Dimethylamino)phenyl)acrylic acid (2m)

5 Experimental Section

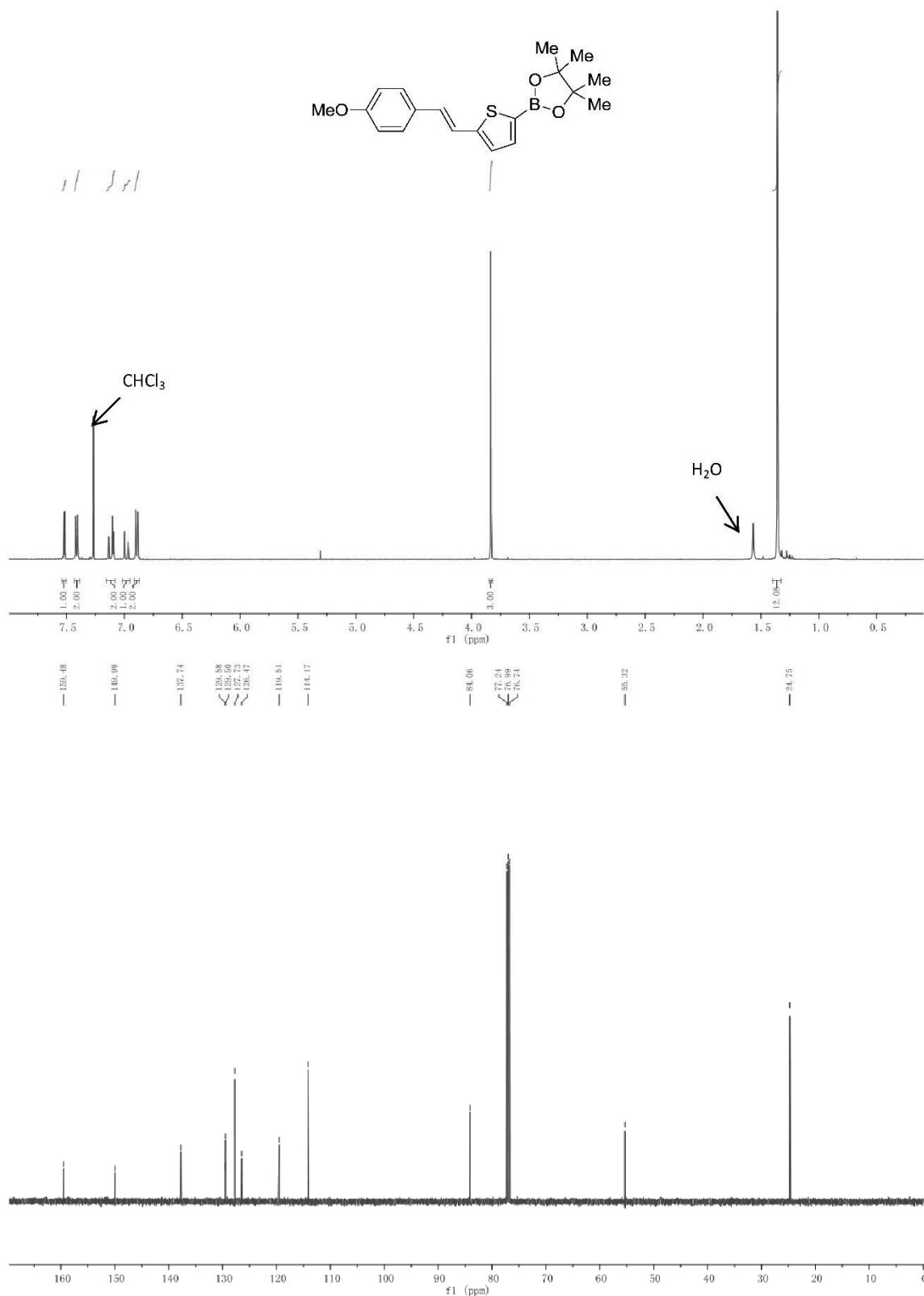
4,4,5,5-Tetramethyl-2-(5-styrylthiophen-2-yl)-1,3,2-dioxaborolane (3a)

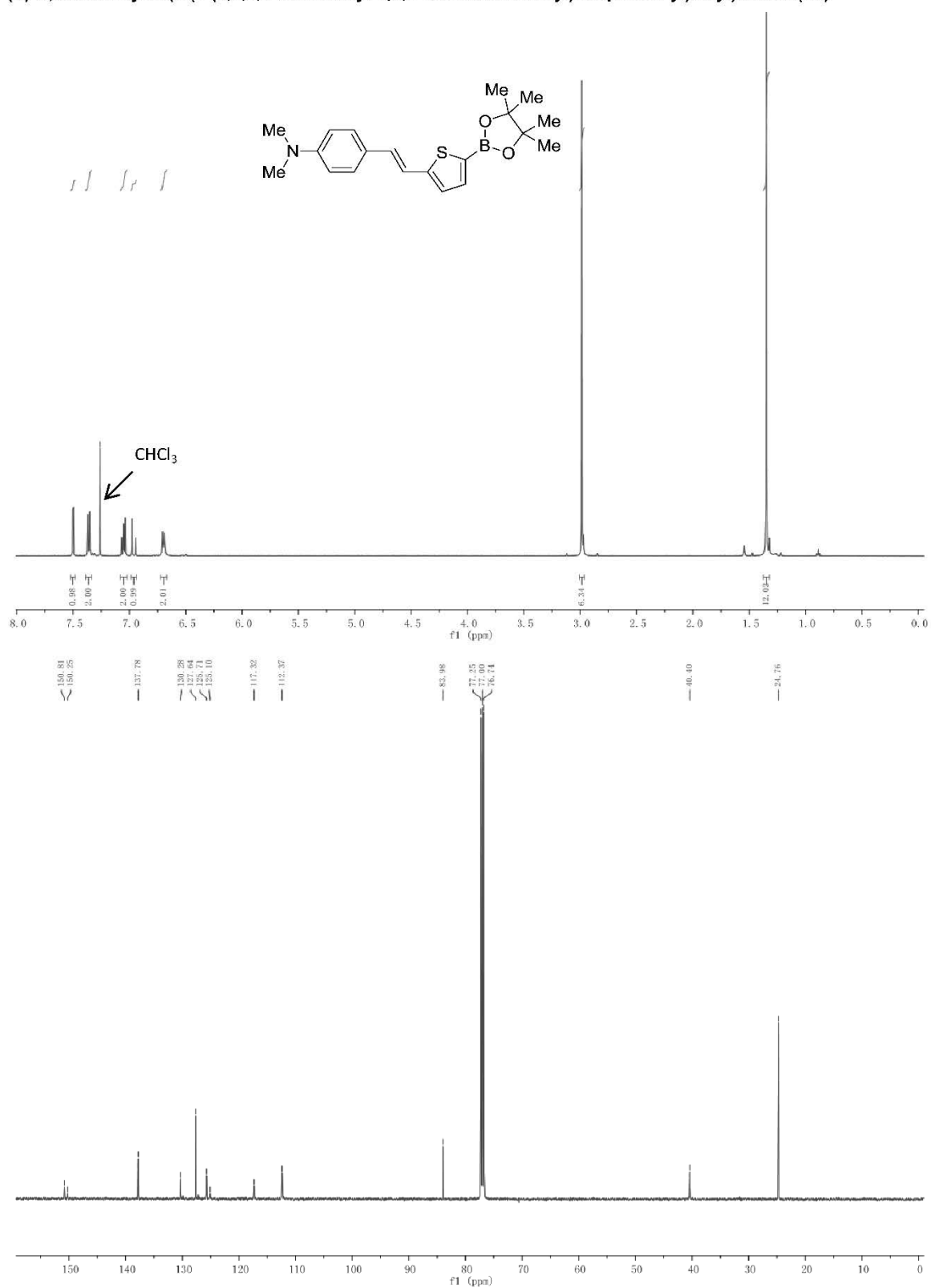


(E)-2-(5-(2-(Benzo[d][1,3]dioxol-5-yl)vinyl)thiophen-2-yl)-4,4,5,5-tetramethyl-1,3,2-dioxaborolane (3b)

5 Experimental Section

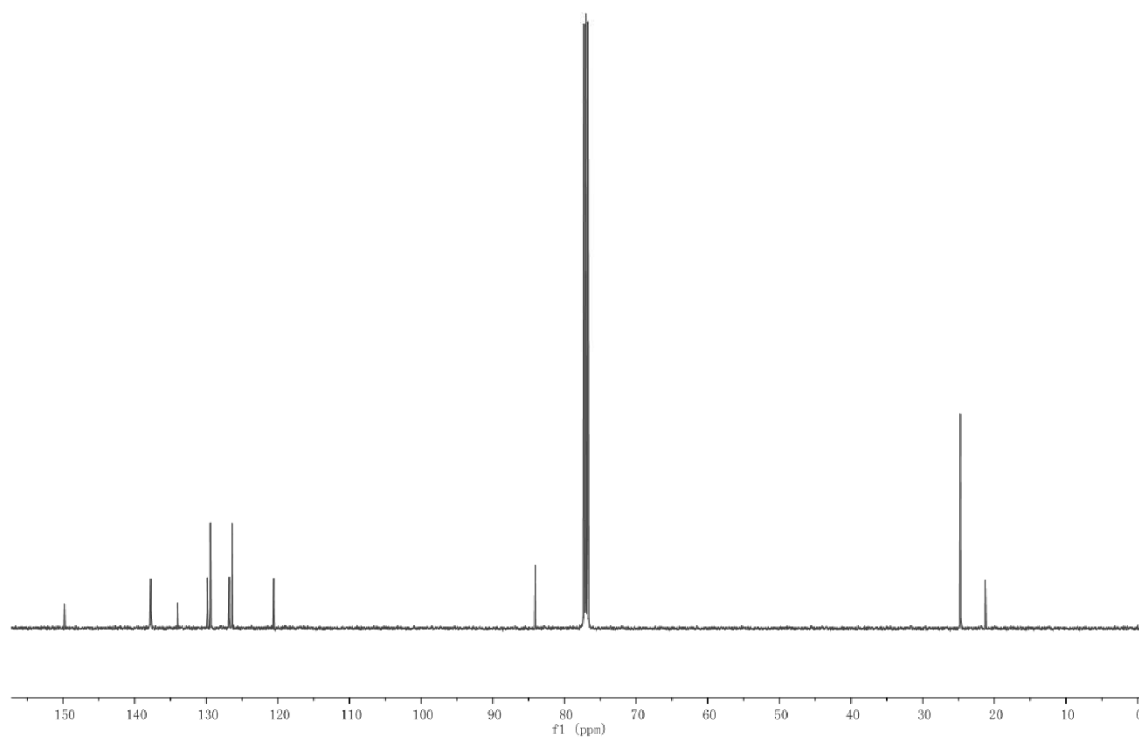
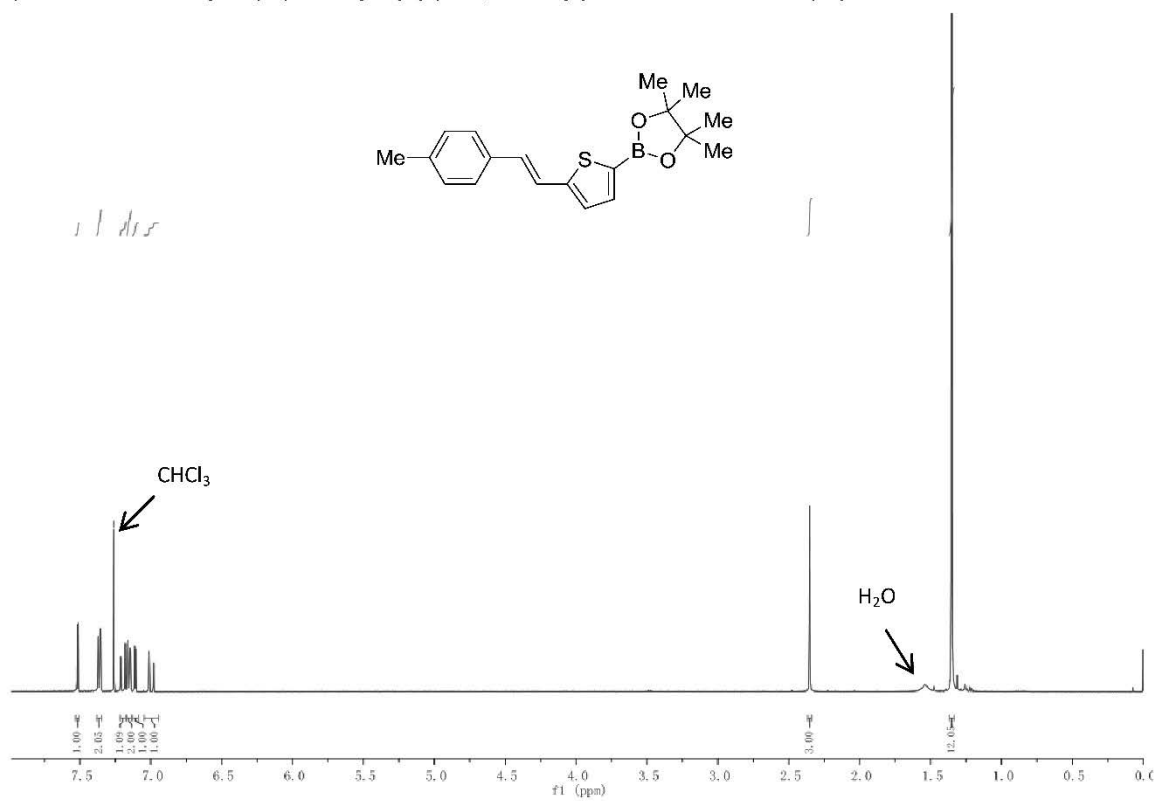
(*E*)-2-(5-(4-Methoxystyryl)thiophen-2-yl)-4,4,5,5-tetramethyl-1,3,2-dioxaborolane (3c)



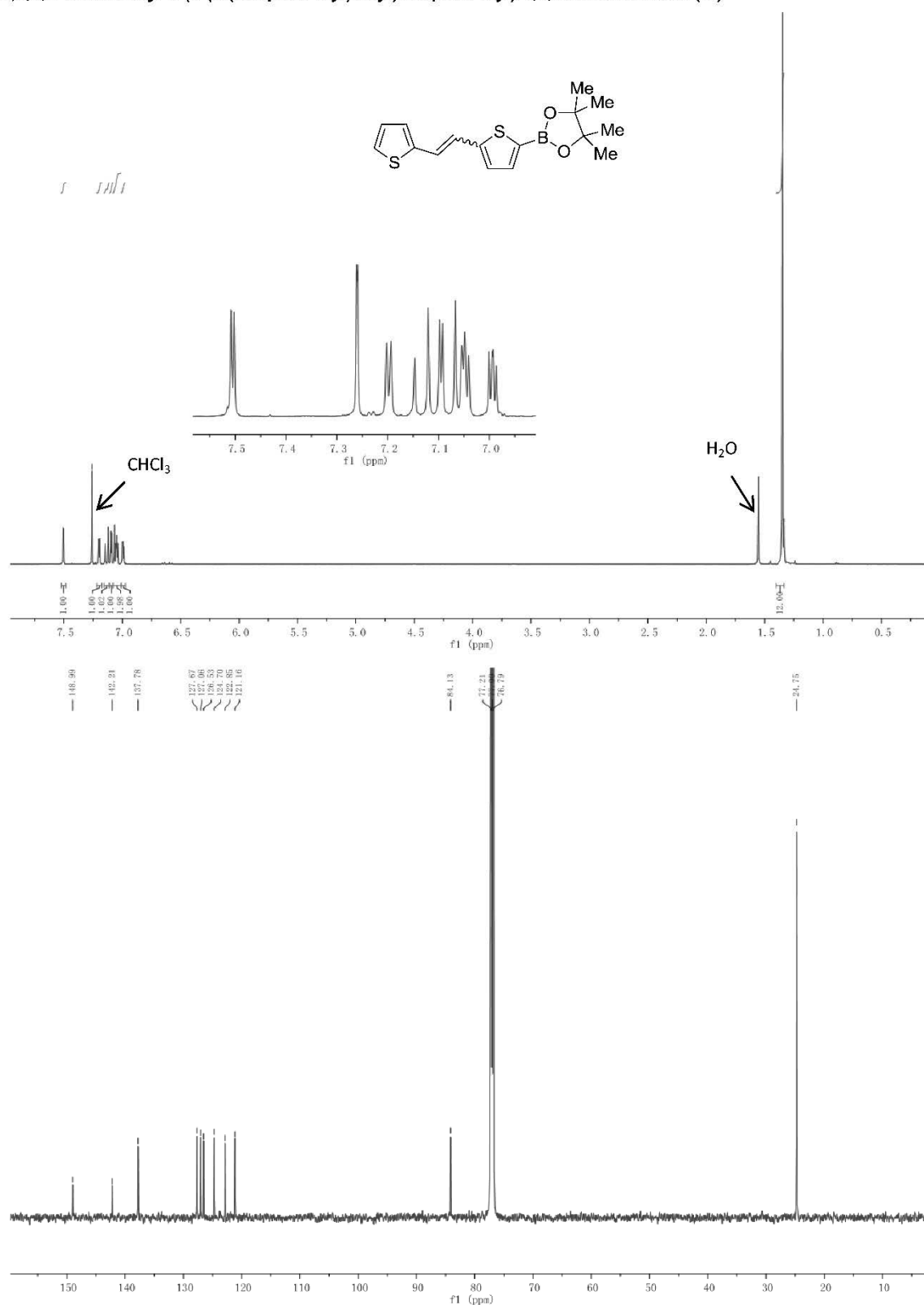
(E)-N,N-Dimethyl-4-(2-(5-(4,4,5,5-tetramethyl-1,3,2-dioxaborolan-2-yl)thiophen-2-yl)vinyl)aniline (3d)

5 Experimental Section

(*E*)-4,4,5,5-Tetramethyl-2-(5-(4-methylstyryl)thiophen-2-yl)-1,3,2-dioxaborolane (**3e**)

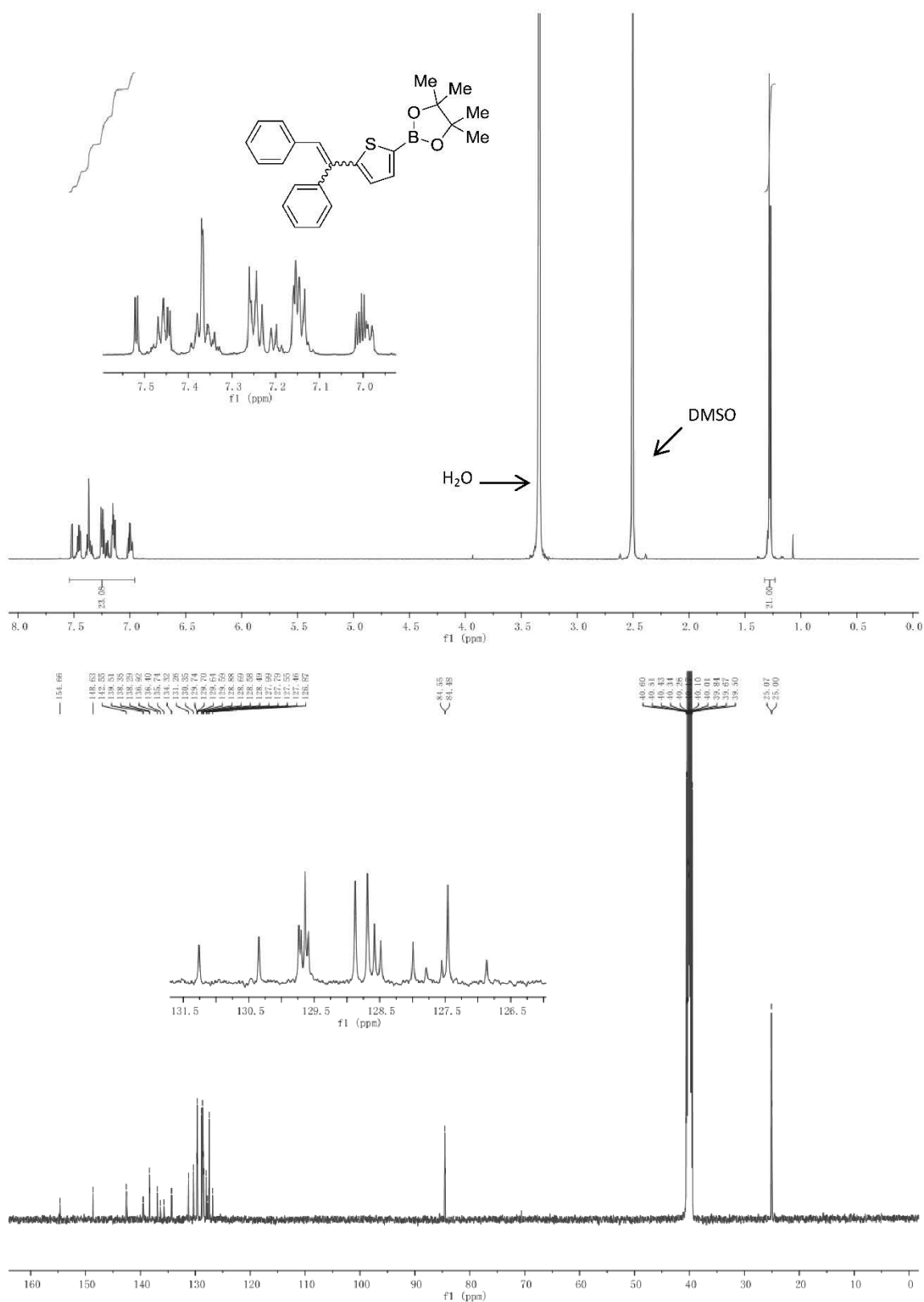


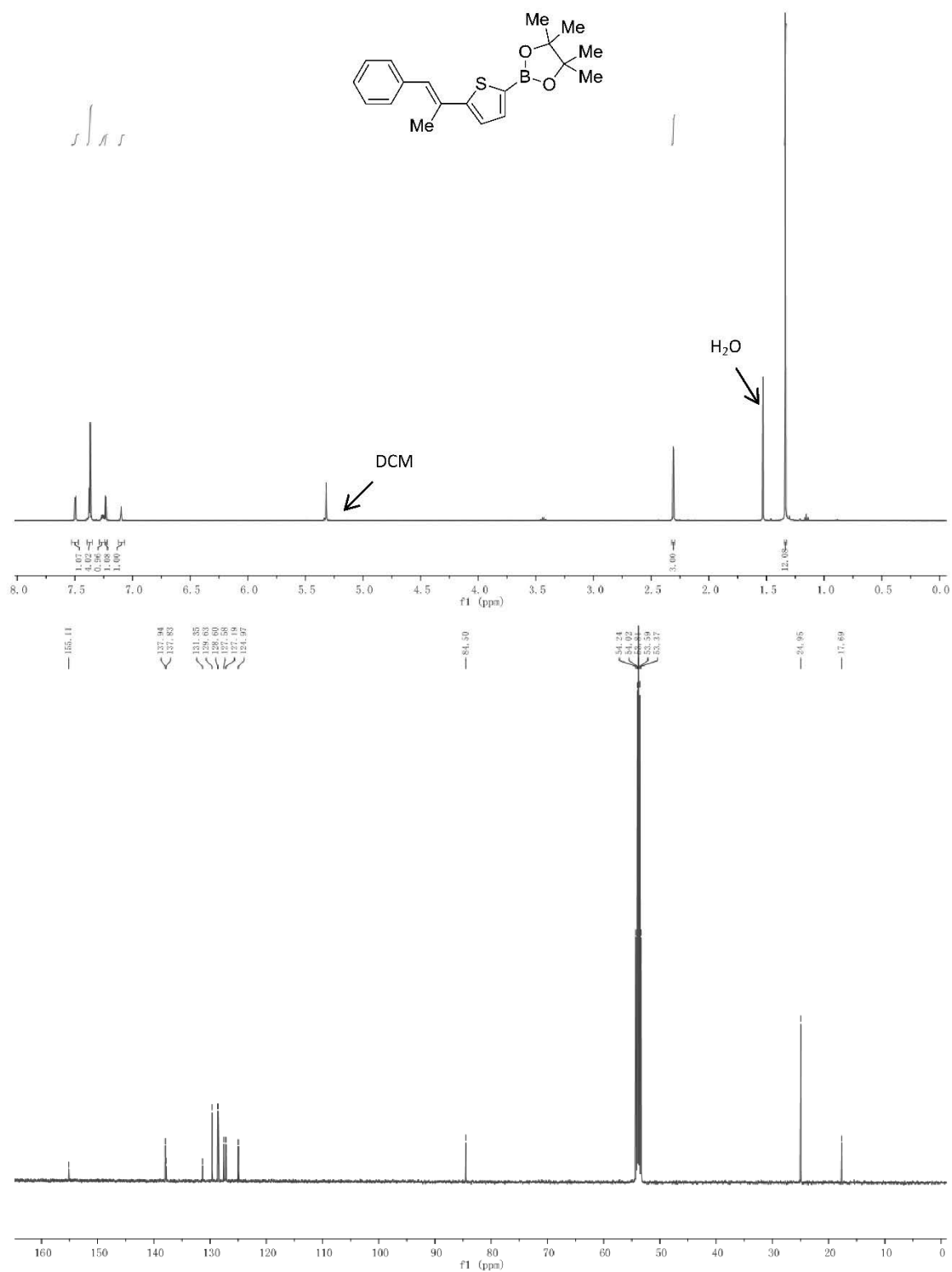
4,4,5,5-Tetramethyl-2-(5-(2-(thiophen-2-yl)vinyl)thiophen-2-yl)-1,3,2-dioxaborolane (3f)



5 Experimental Section

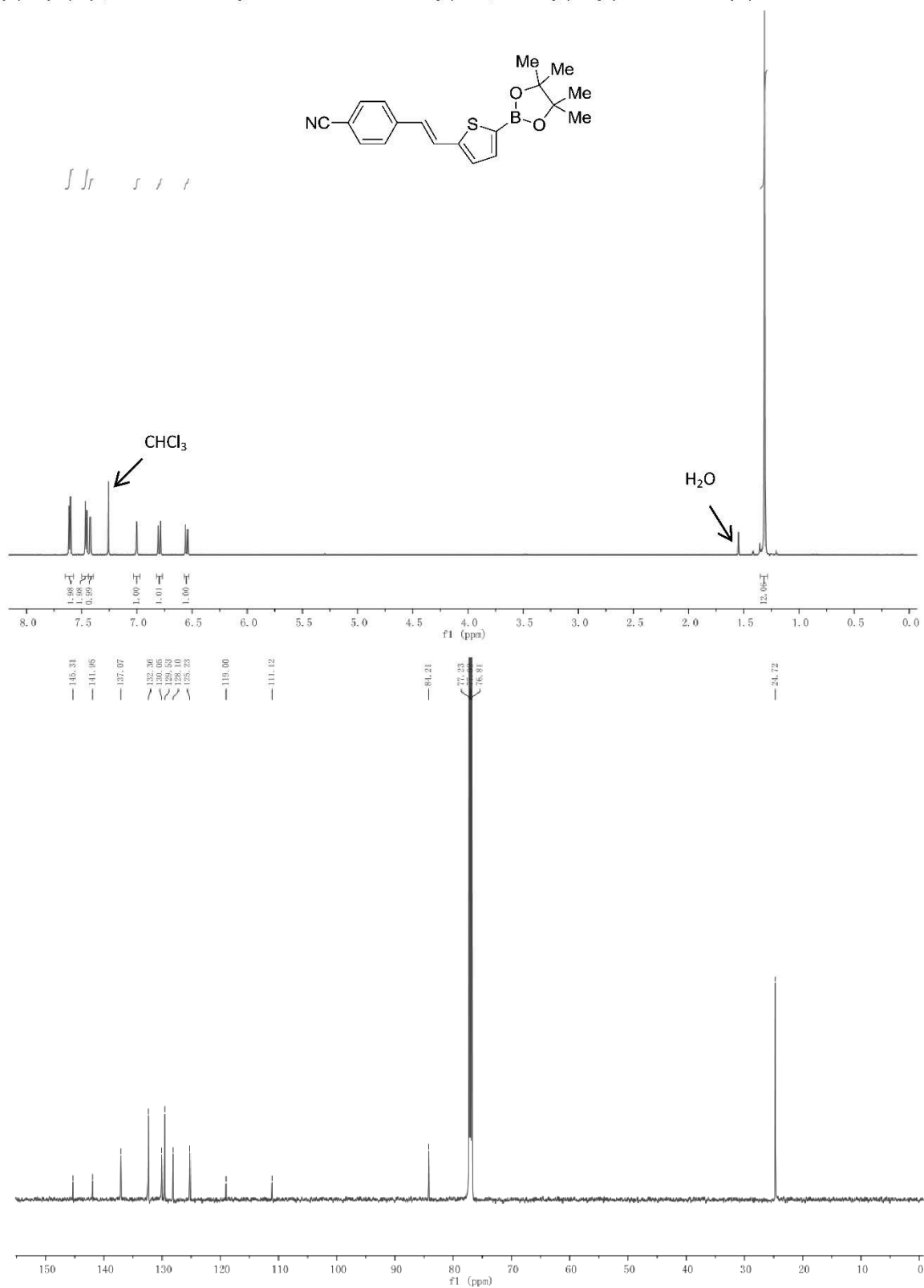
2-(5-(1,2-Diphenylvinyl)thiophen-2-yl)-4,4,5,5-tetramethyl-1,3,2-dioxaborolane (3g)



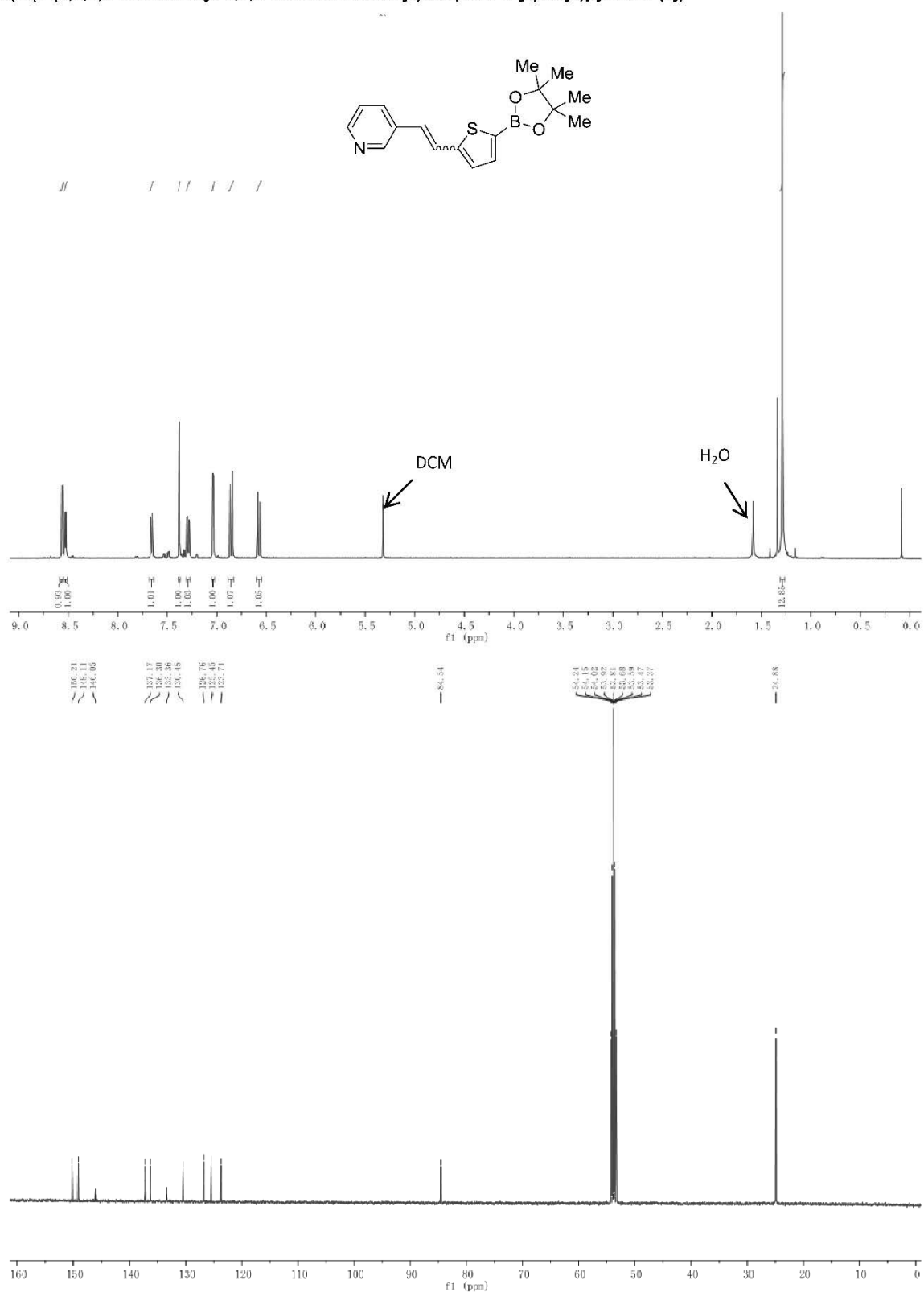
(E)-4,4,5,5-Tetramethyl-2-(5-(1-phenylprop-1-en-2-yl)thiophen-2-yl)-1,3,2-dioxaborolane (3h)

5 Experimental Section

(*E*)-4-(2-(5-(4,4,5,5-Tetramethyl-1,3,2-dioxaborolan-2-yl)thiophen-2-yl)vinyl)benzonitrile (3i)

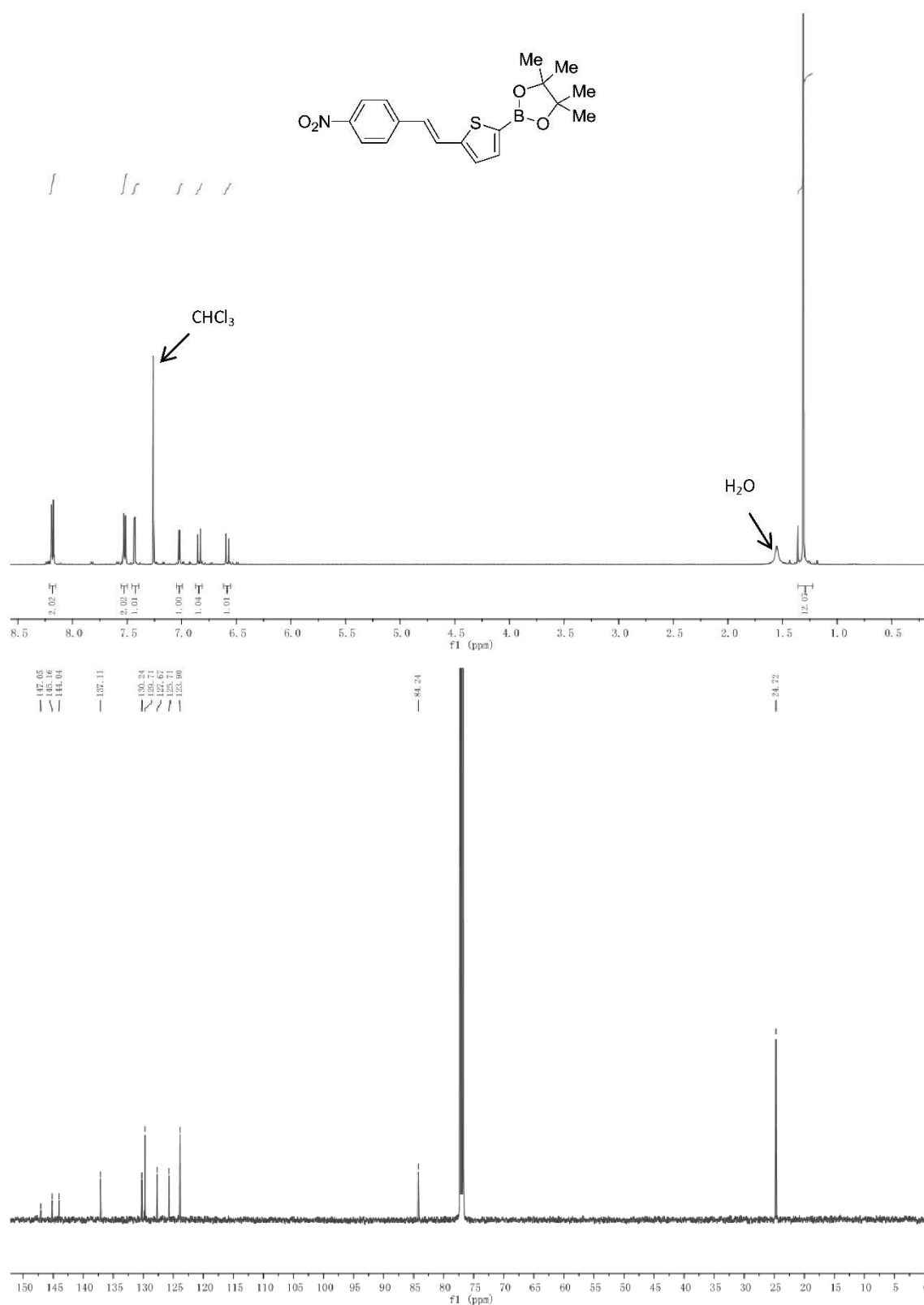


3-(2-(5-(4,4,5,5-Tetramethyl-1,3,2-dioxaborolan-2-yl)thiophen-2-yl)vinyl)pyridine (3j)

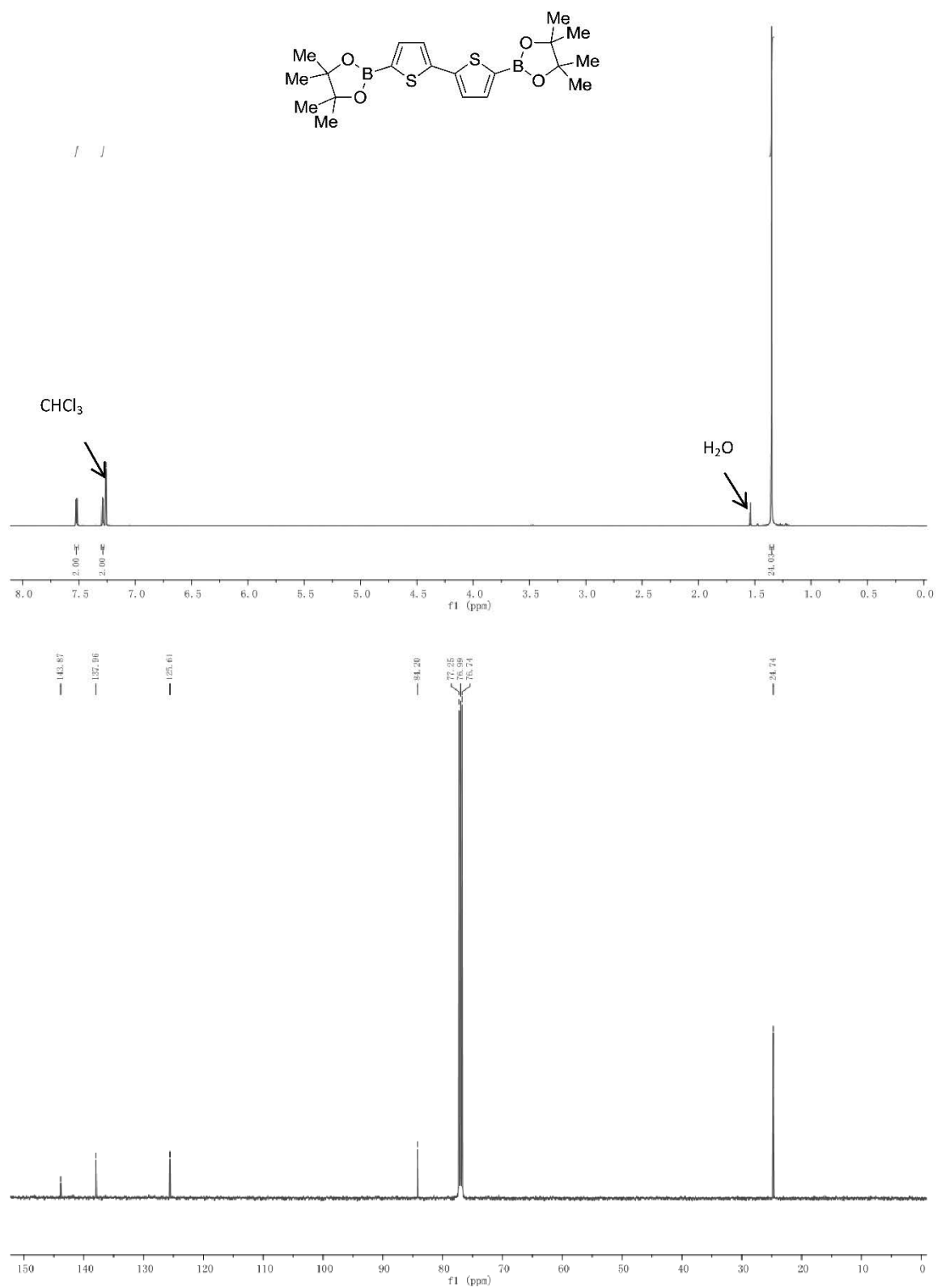


5 Experimental Section

(E)-4,4,5,5-Tetramethyl-2-(5-(4-nitrostyryl)thiophen-2-yl)-1,3,2-dioxaborolane (3k)

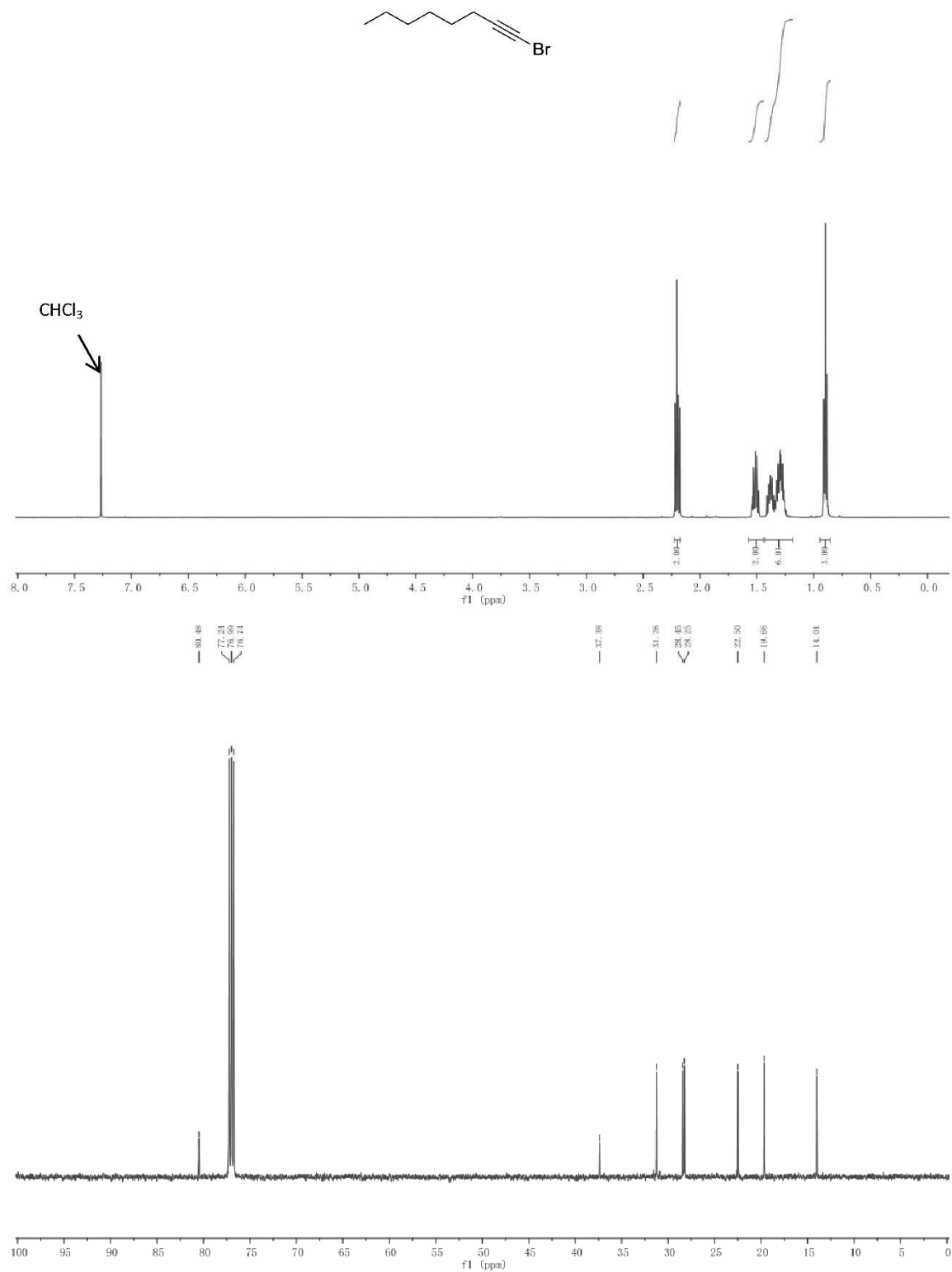


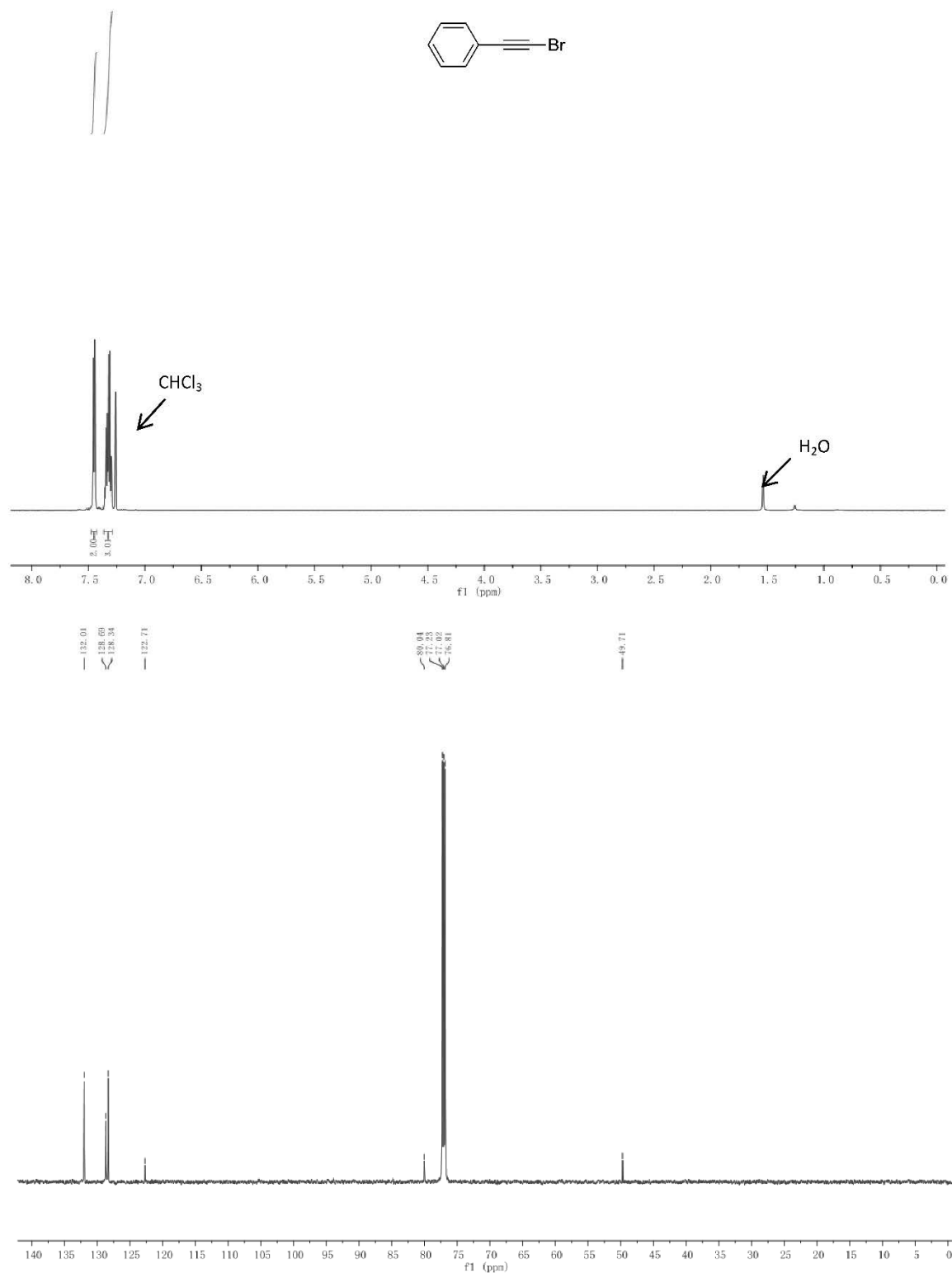
5,5'-bis(4,4,5,5-Tetramethyl-1,3,2-dioxaborolan-2-yl)-2,2'-bithiophene (4)



5 Experimental Section

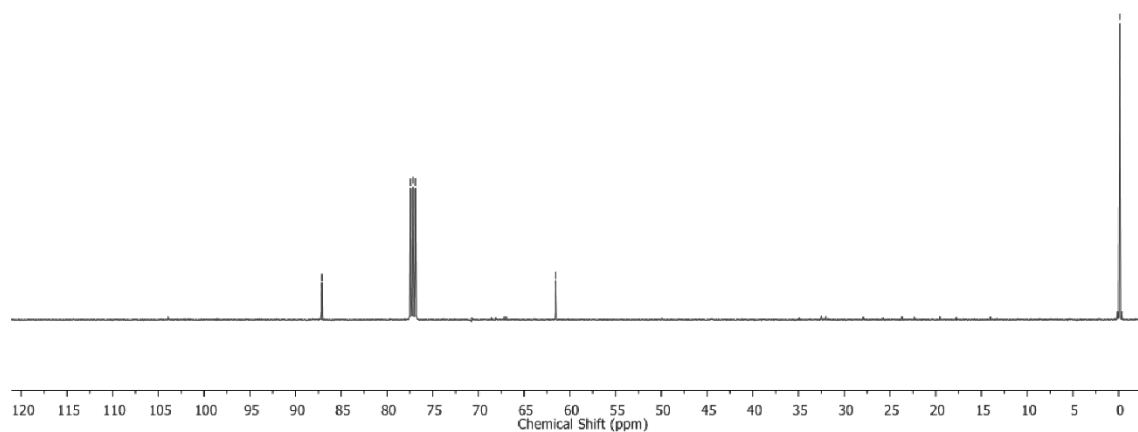
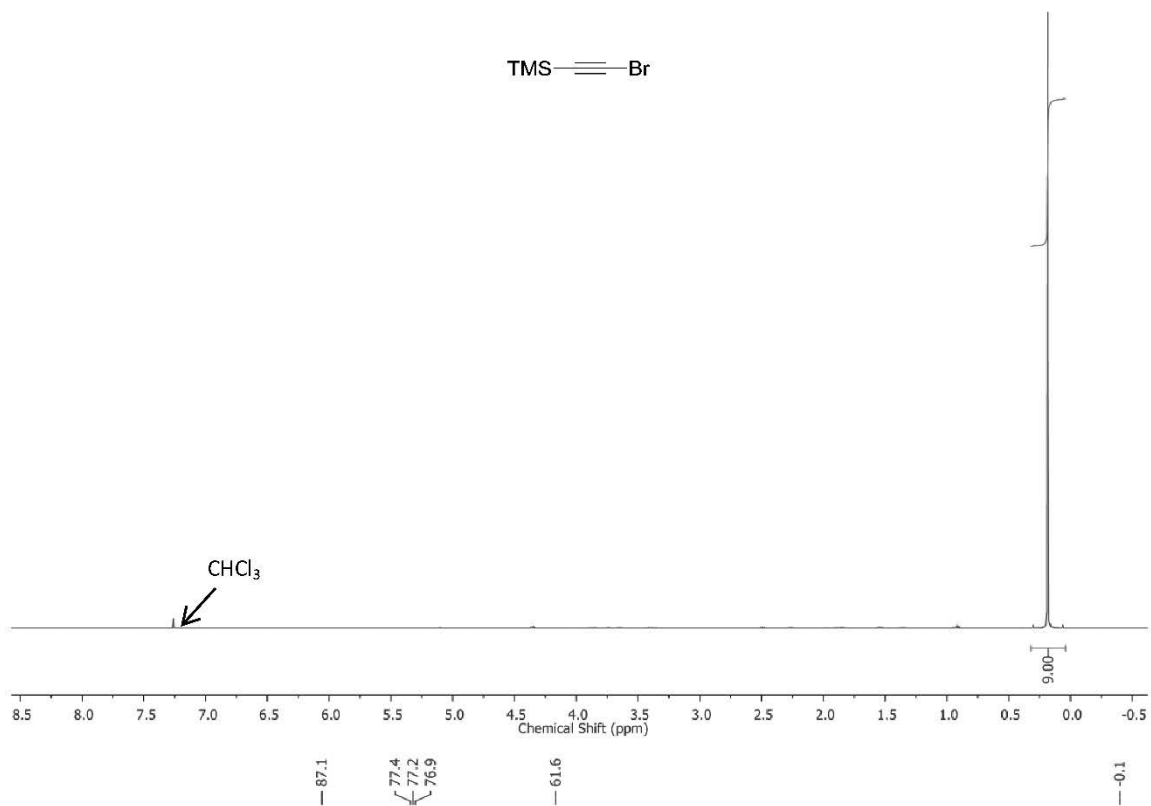
1-Bromo-1-octyne (6a)



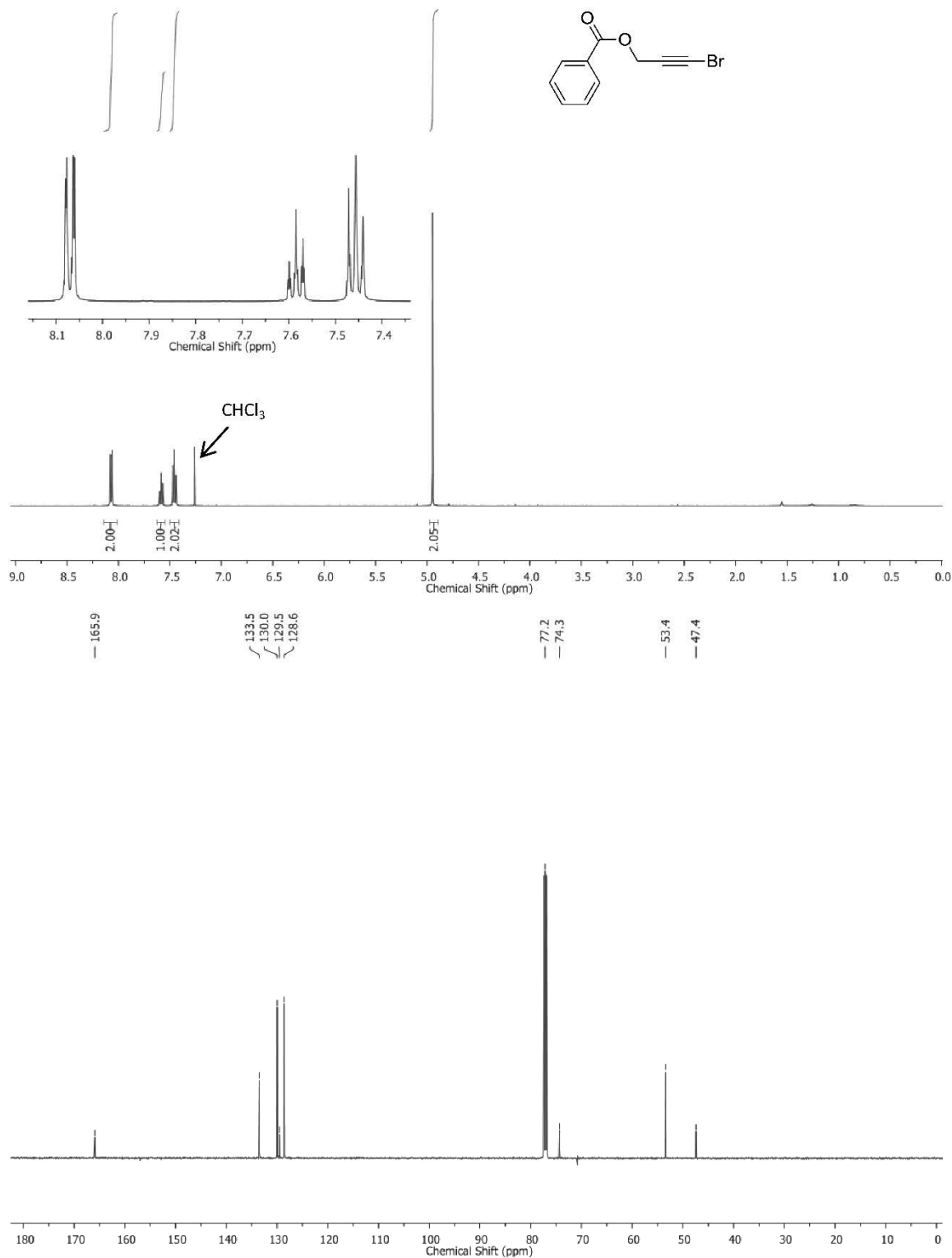
(Bromoethynyl)benzene (6b)

5 Experimental Section

(Bromoethynyl)trimethylsilane (6c)

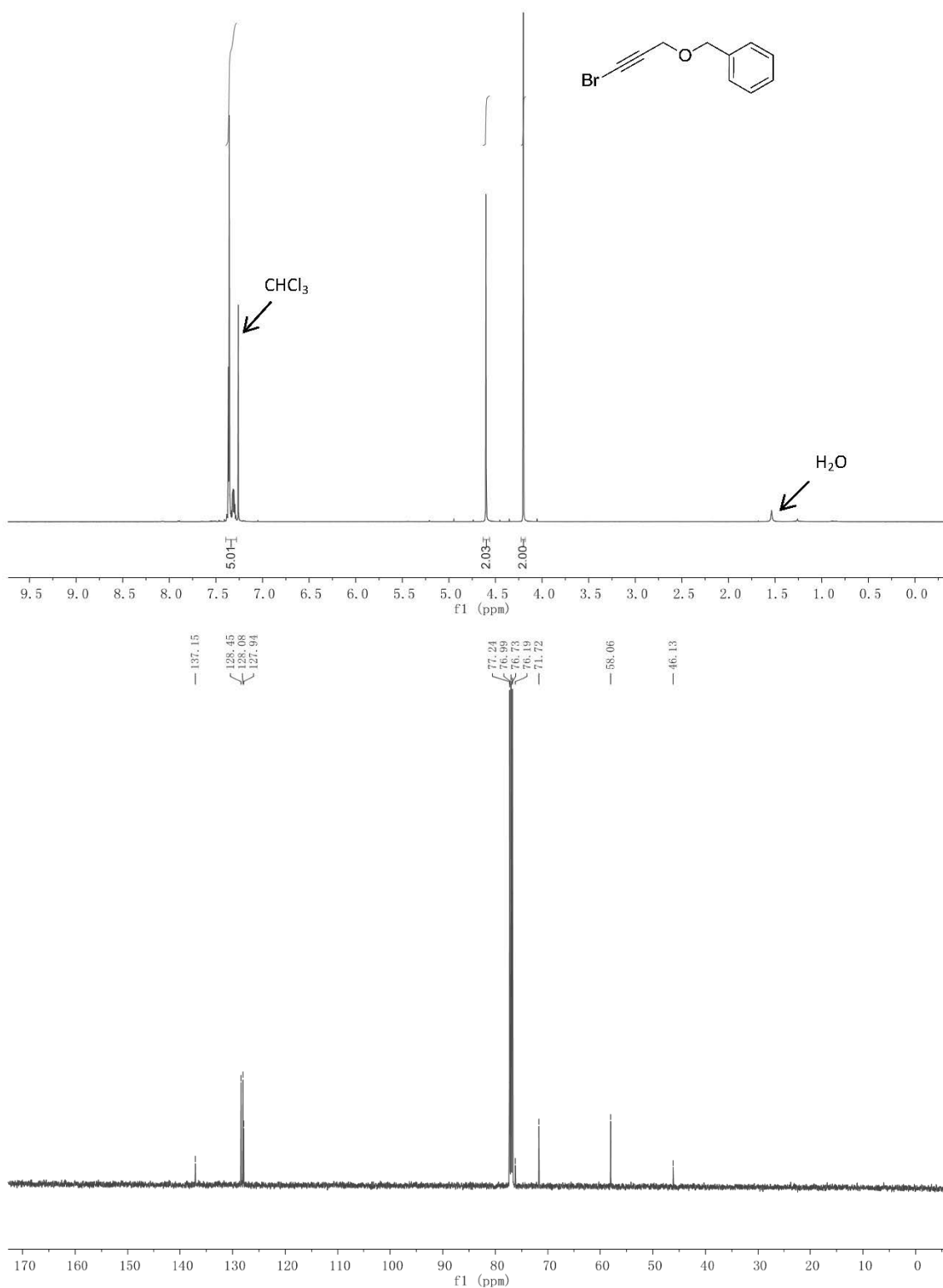


3-Bromoprop-2-yn-1-yl benzoate (6d)

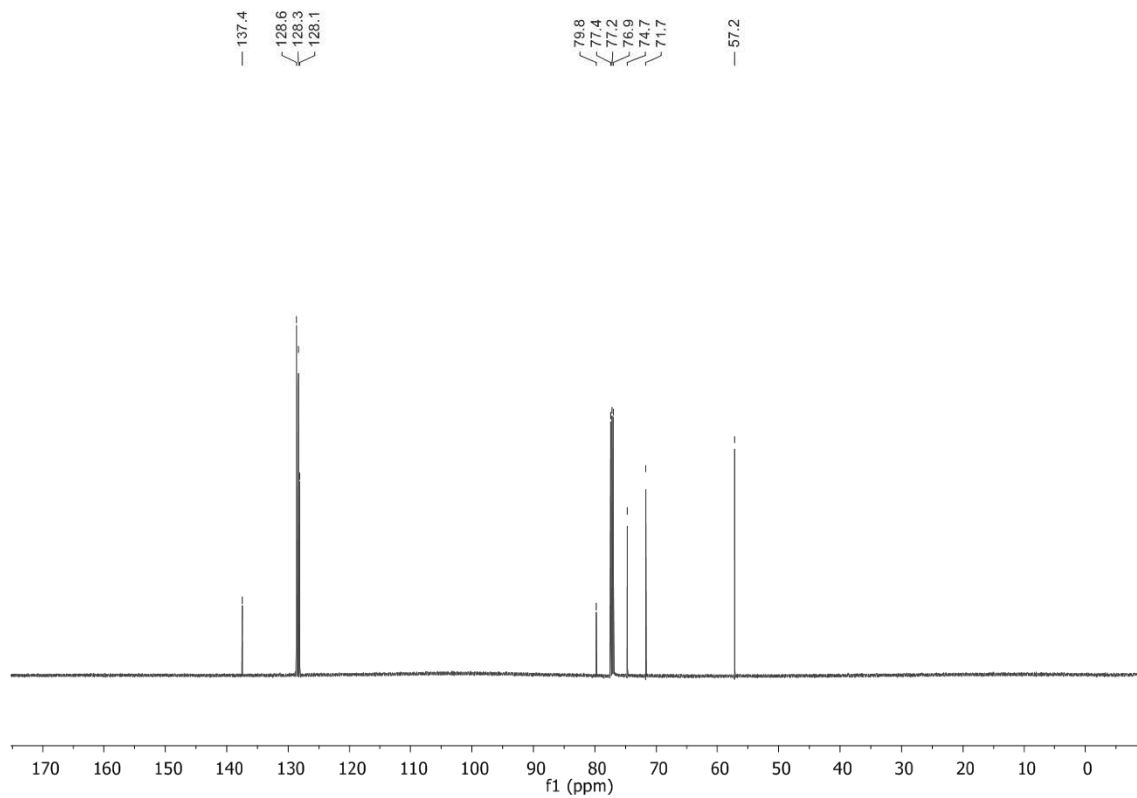
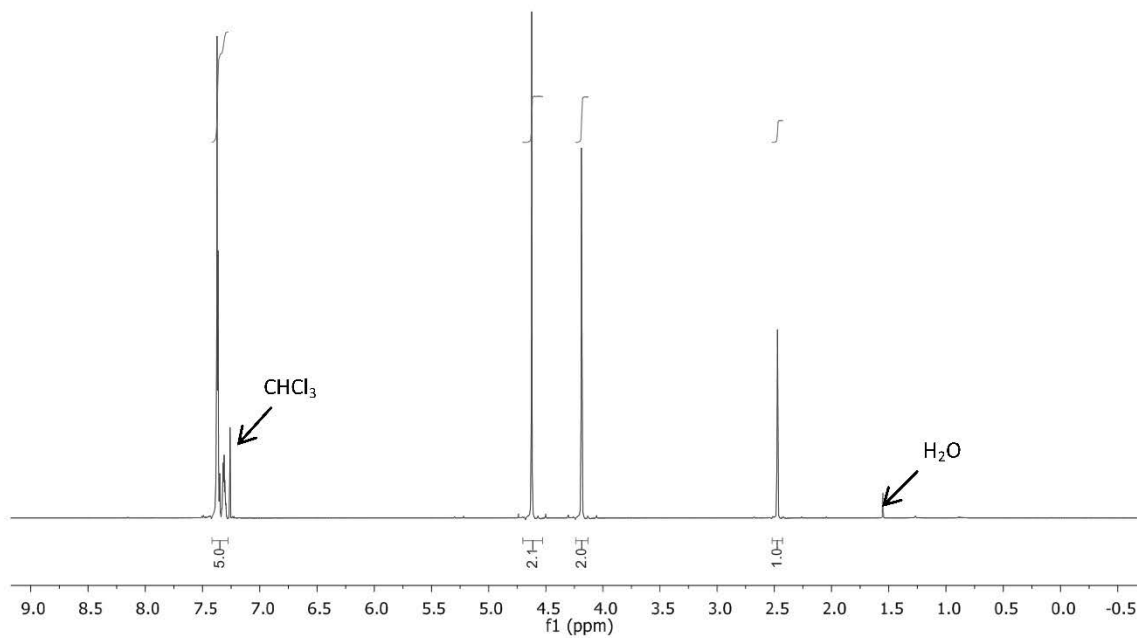
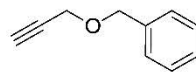


5 Experimental Section

Benzylprop-(3-bromo-2-ynyl) ether (6e)

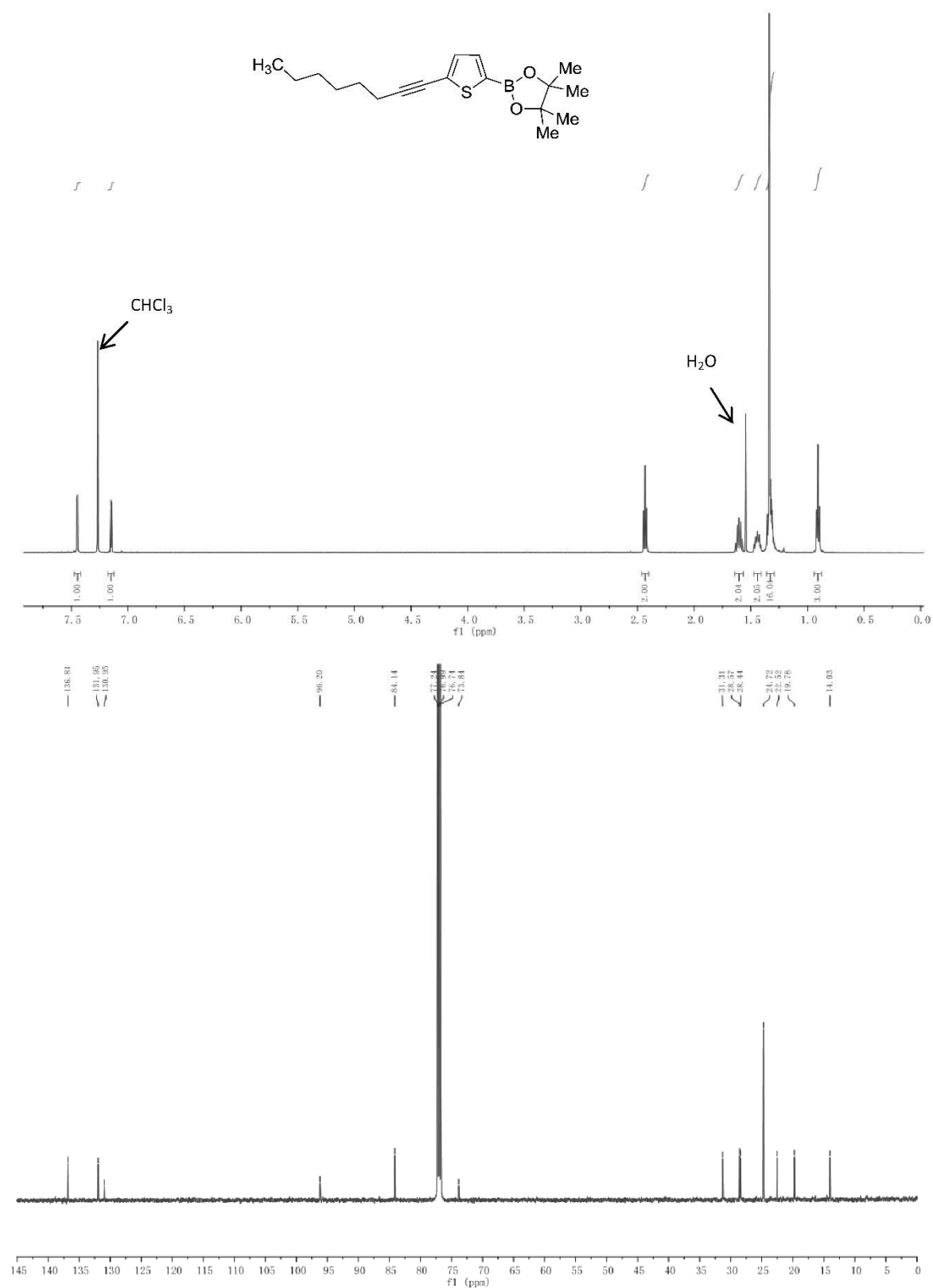


Benzylprop-2-ynyl ether (6f)

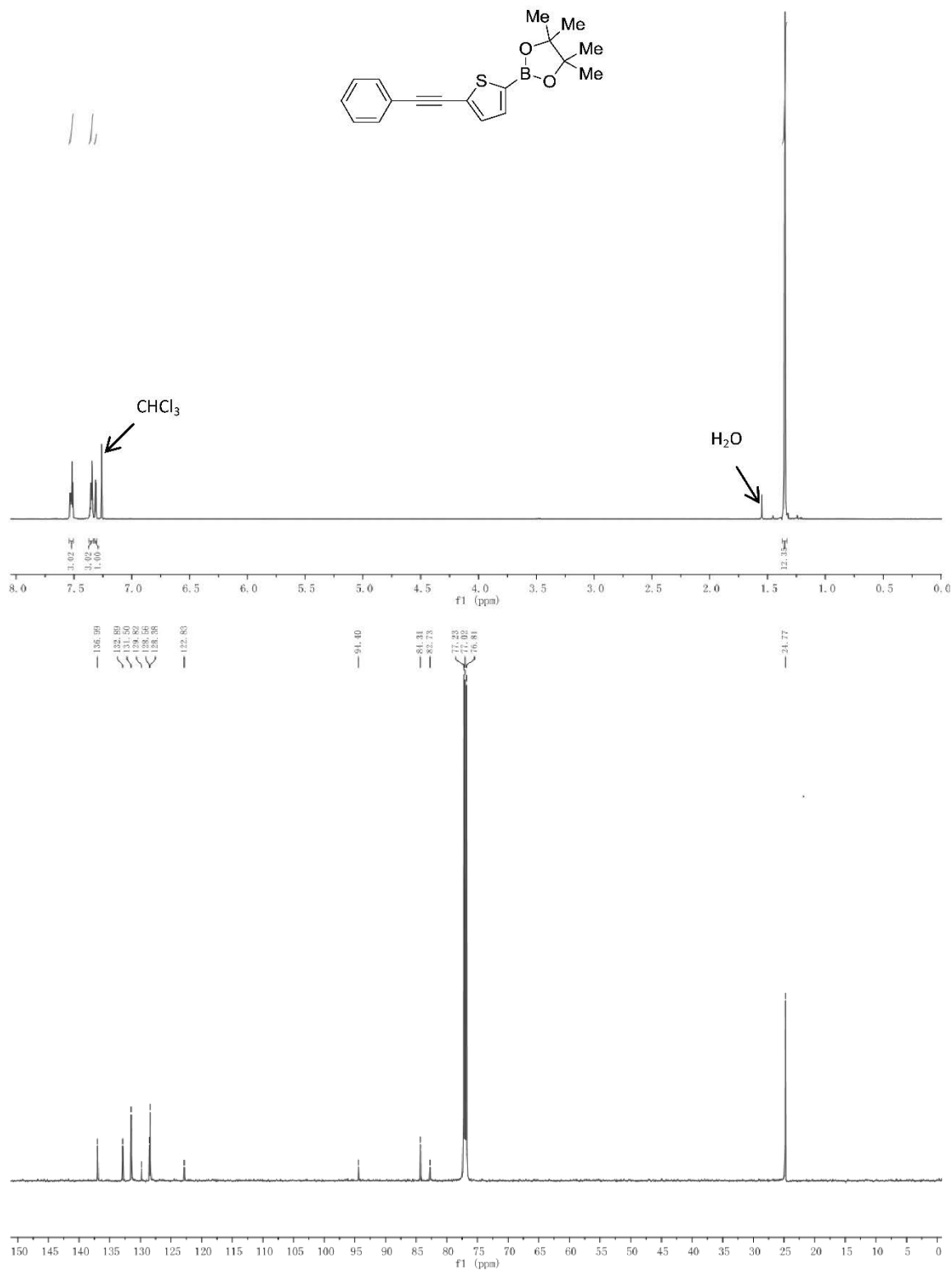


5 Experimental Section

4,4,5,5-Tetramethyl-2-(5-(oct-1-yn-1-yl)thiophen-2-yl)-1,3,2-dioxaborolane (7a)

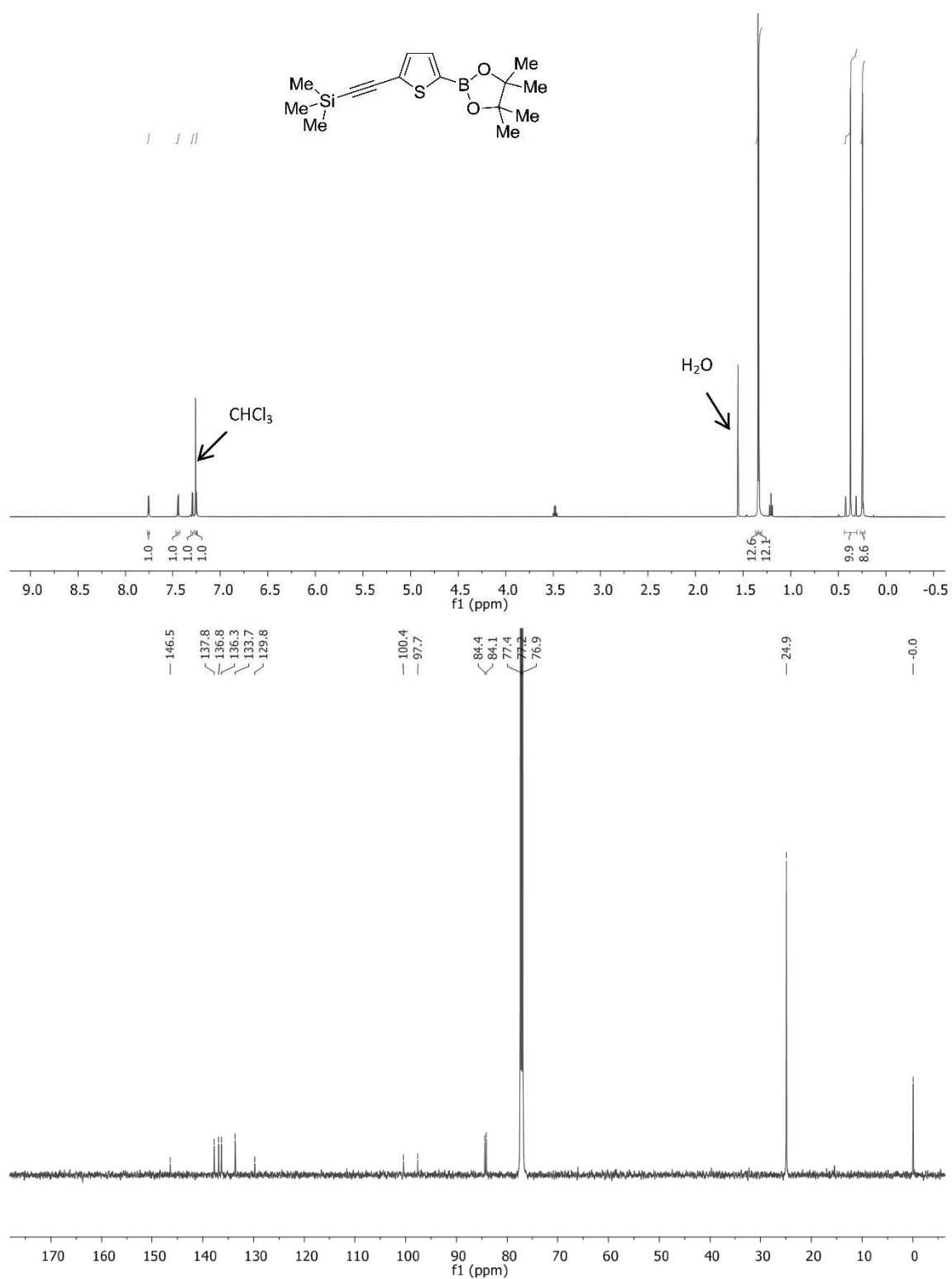


4,4,5,5-Tetramethyl-2-(5-(phenylethynyl)thiophen-2-yl)-1,3,2-dioxaborolane (7b)

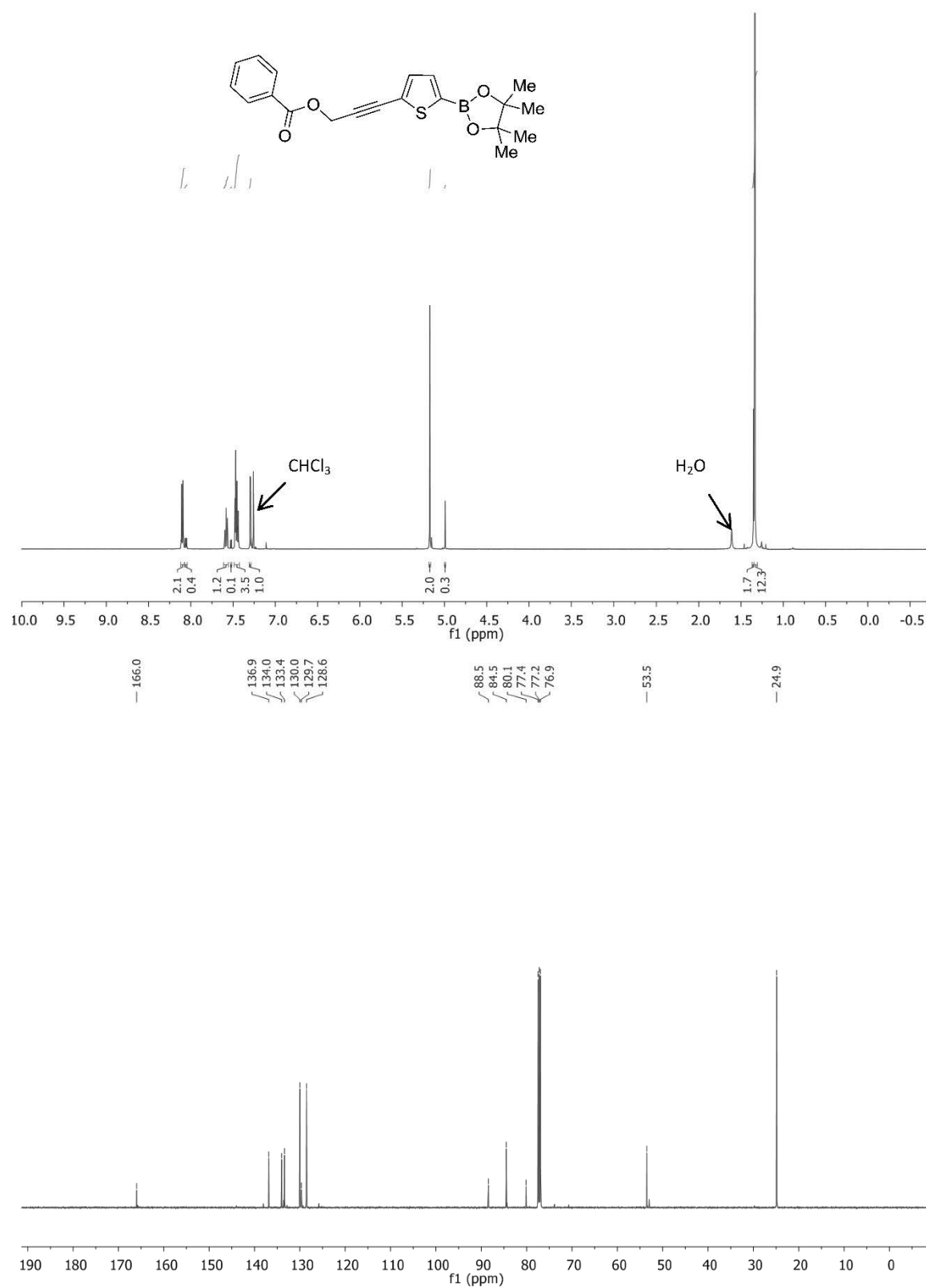


5 Experimental Section

Trimethyl((5-(4,4,5,5-tetramethyl-1,3,2-dioxaborolan-2-yl)thiophen-2-yl)ethynyl)silane (7c)

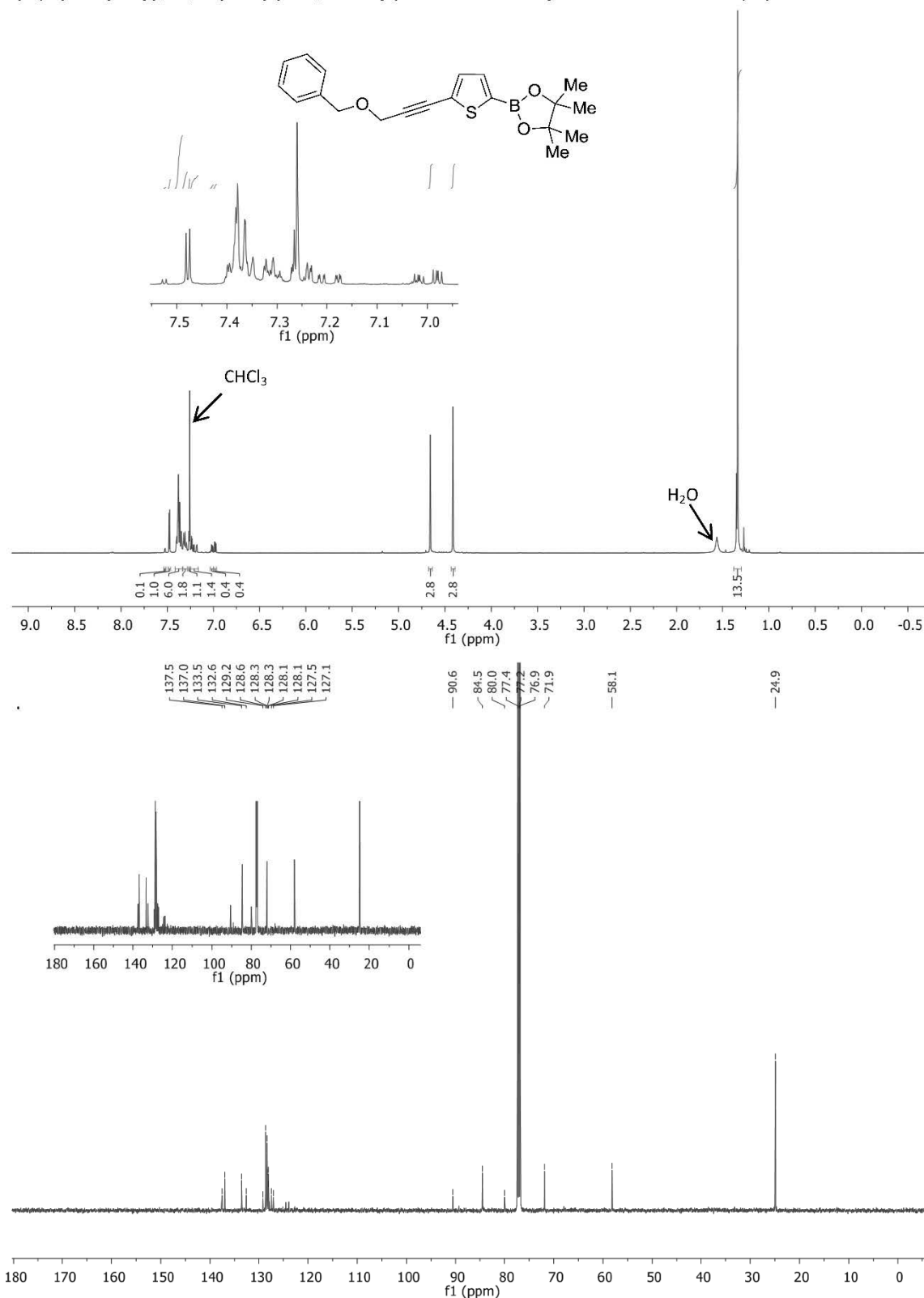


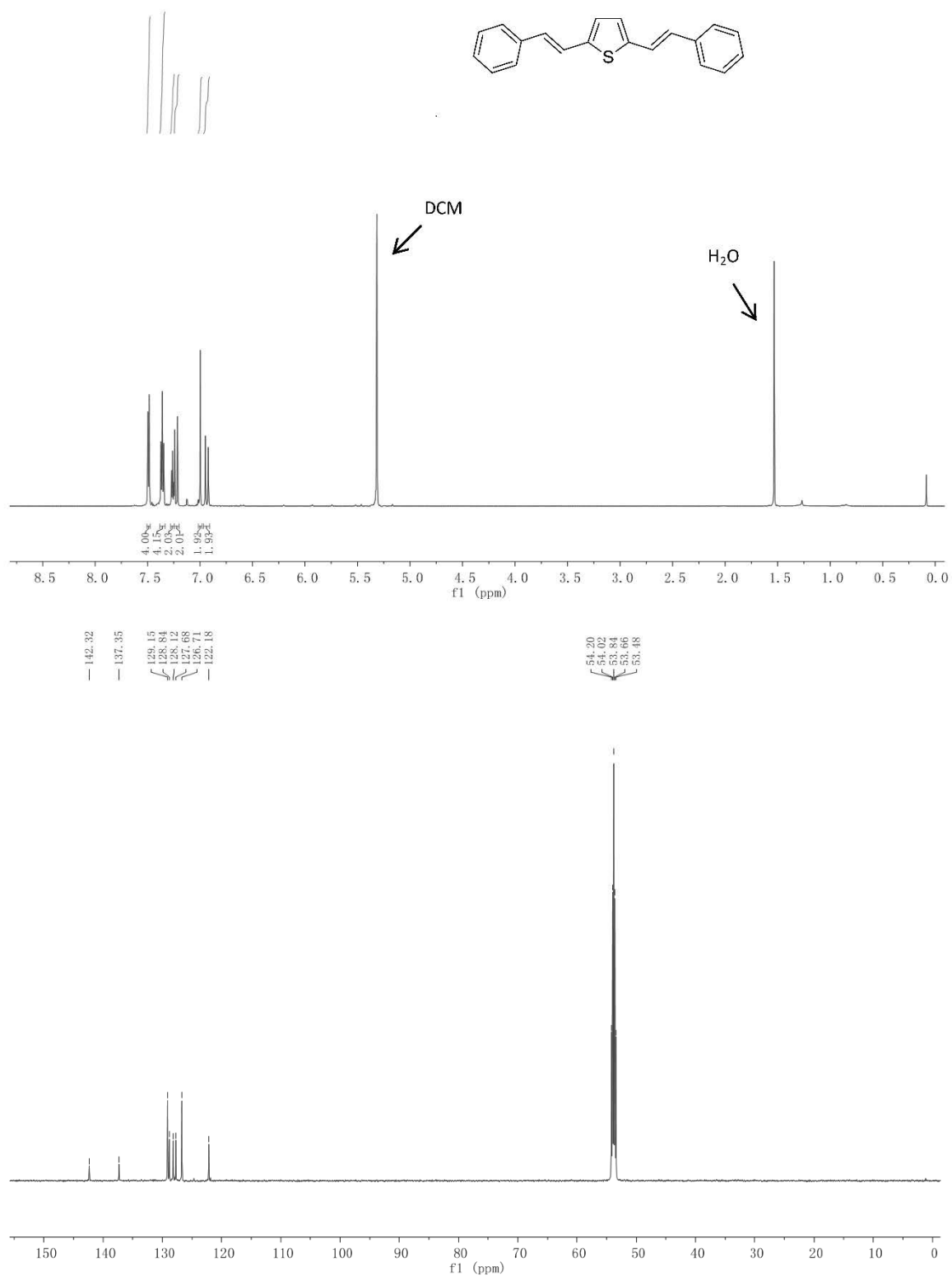
3-(5-(4,4,5,5-Tetramethyl-1,3,2-dioxaborolan-2-yl)thiophen-2-yl)prop-2-yn-1-ylbenzoate (7d)



5 Experimental Section

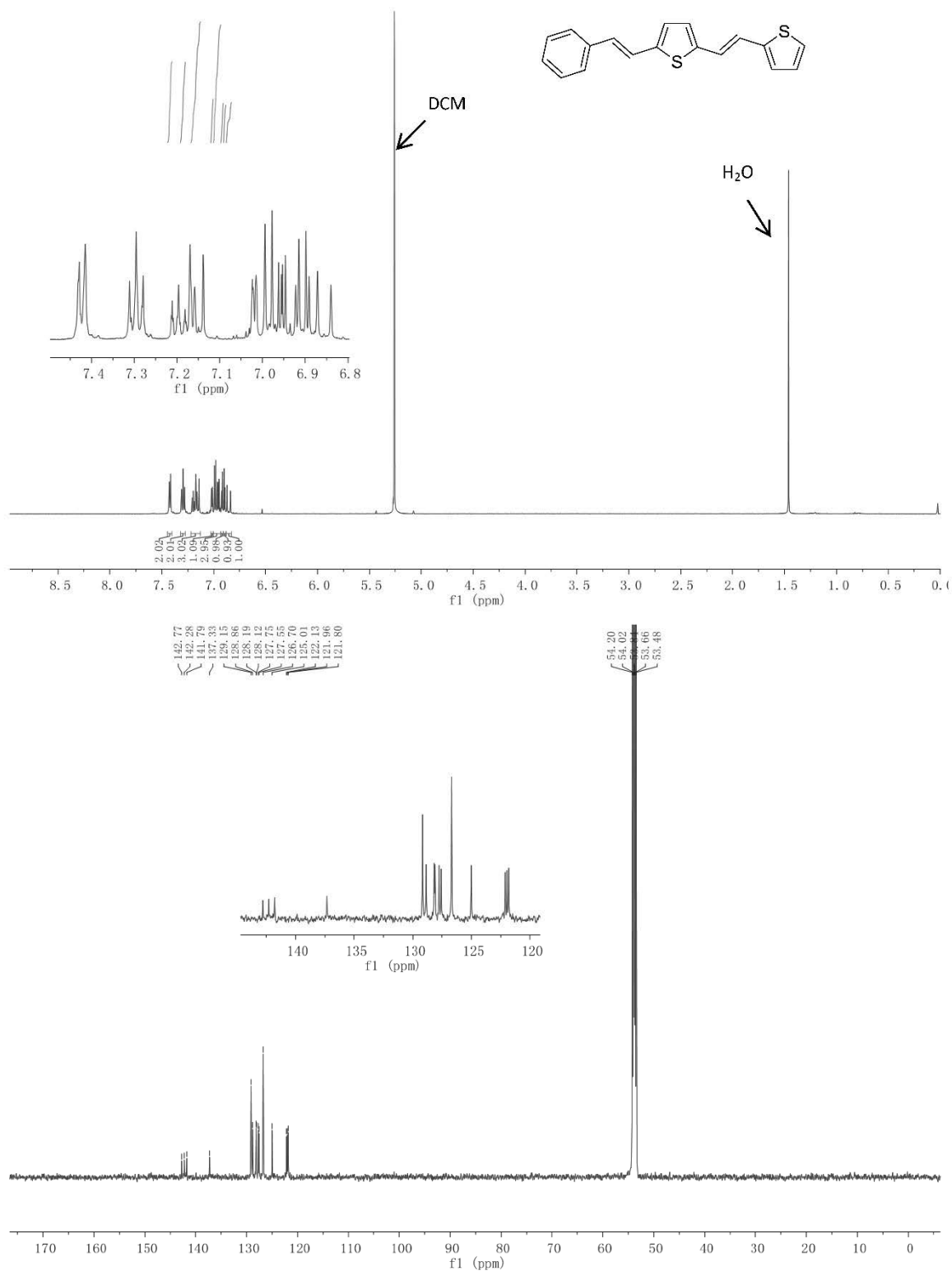
2-(5-(3-(Benzyloxy)prop-1-yn-1-yl)thiophen-2-yl)-4,4,5,5-tetramethyl-1,3,2-dioxaborolane (7e)

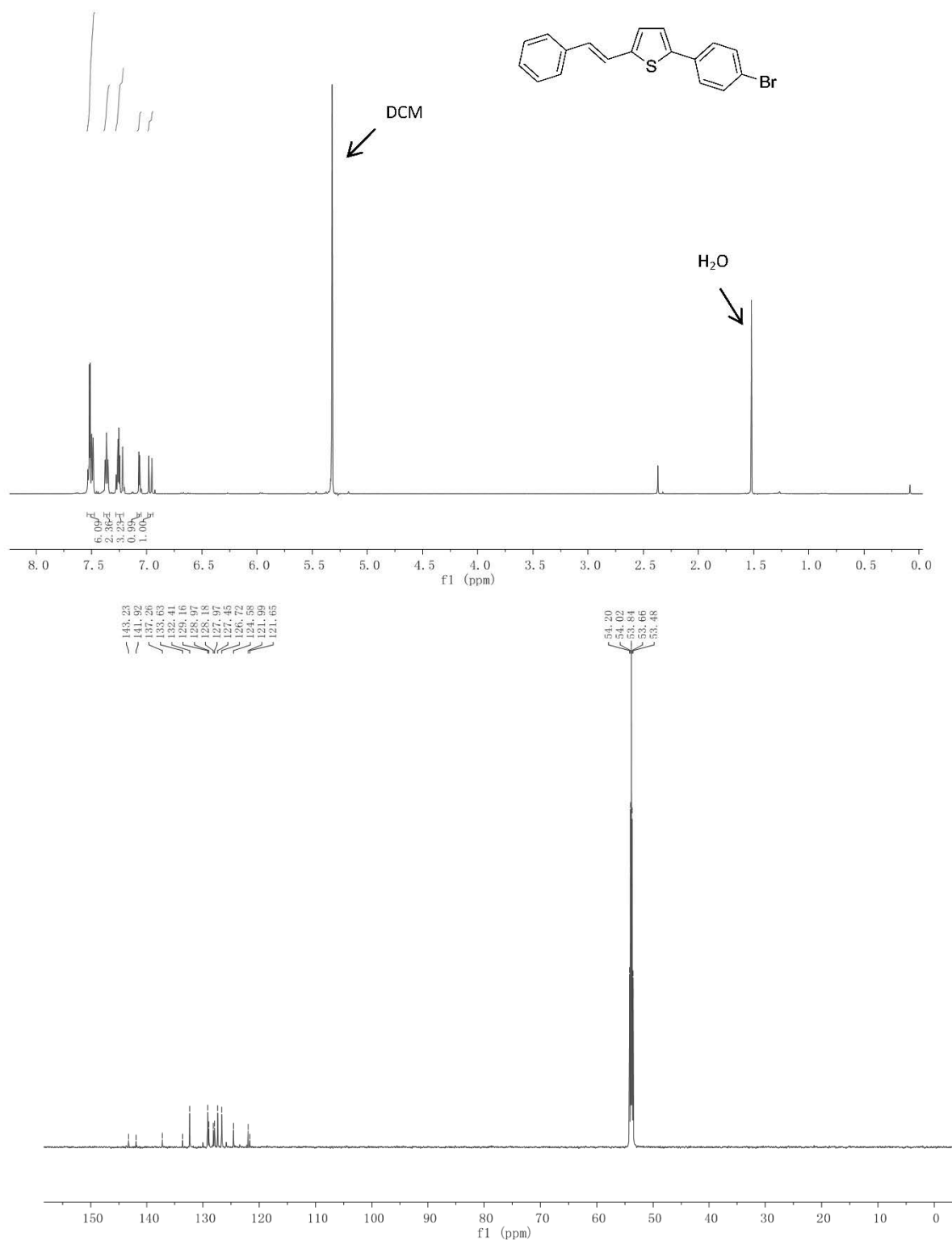


2,5-Di(*E*-styryl)thiophene (8a)

5 Experimental Section

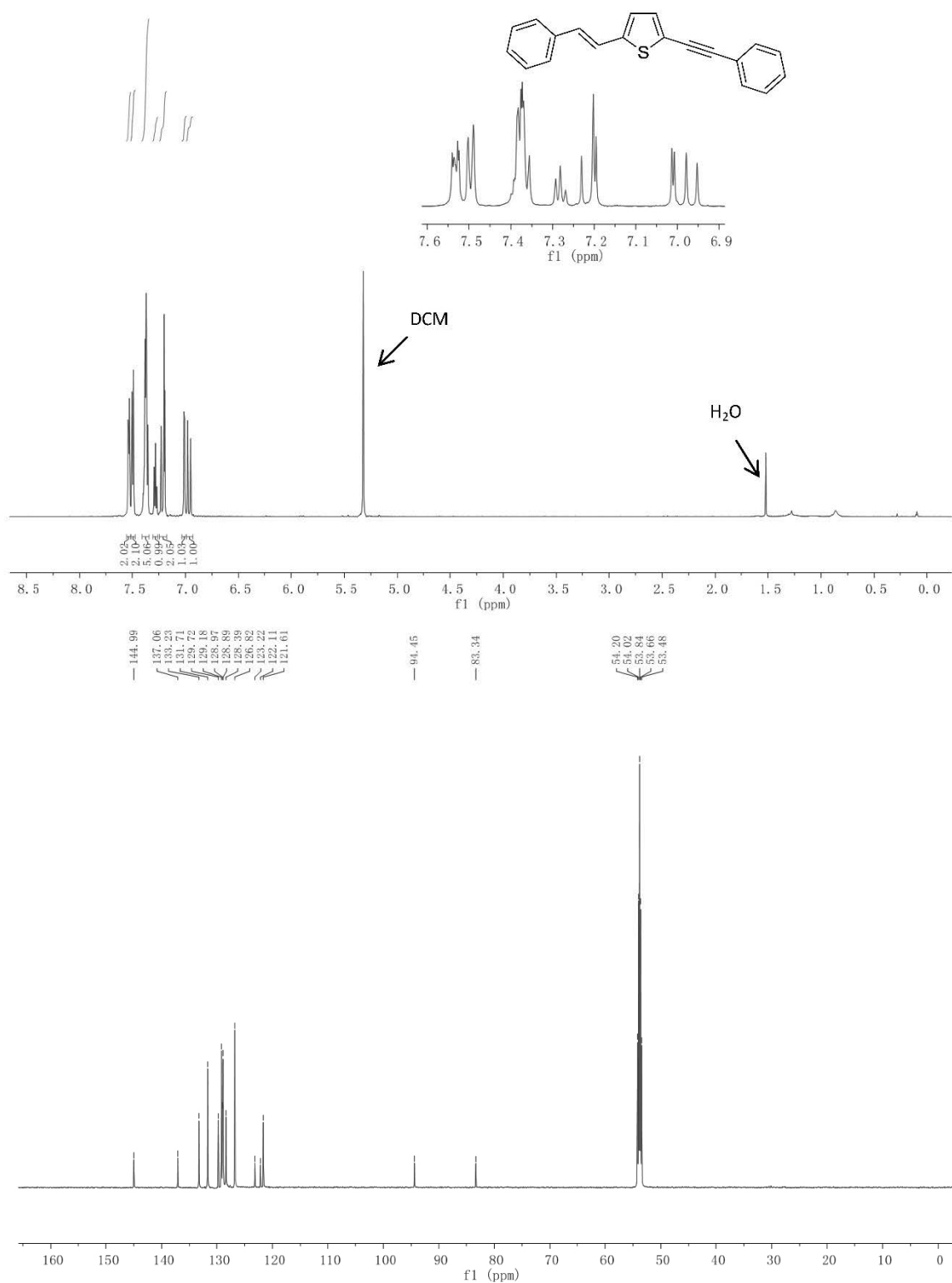
2-((E)-Styryl)-5-((E)-2-(thiophen-2-yl)vinyl)thiophene (8b)

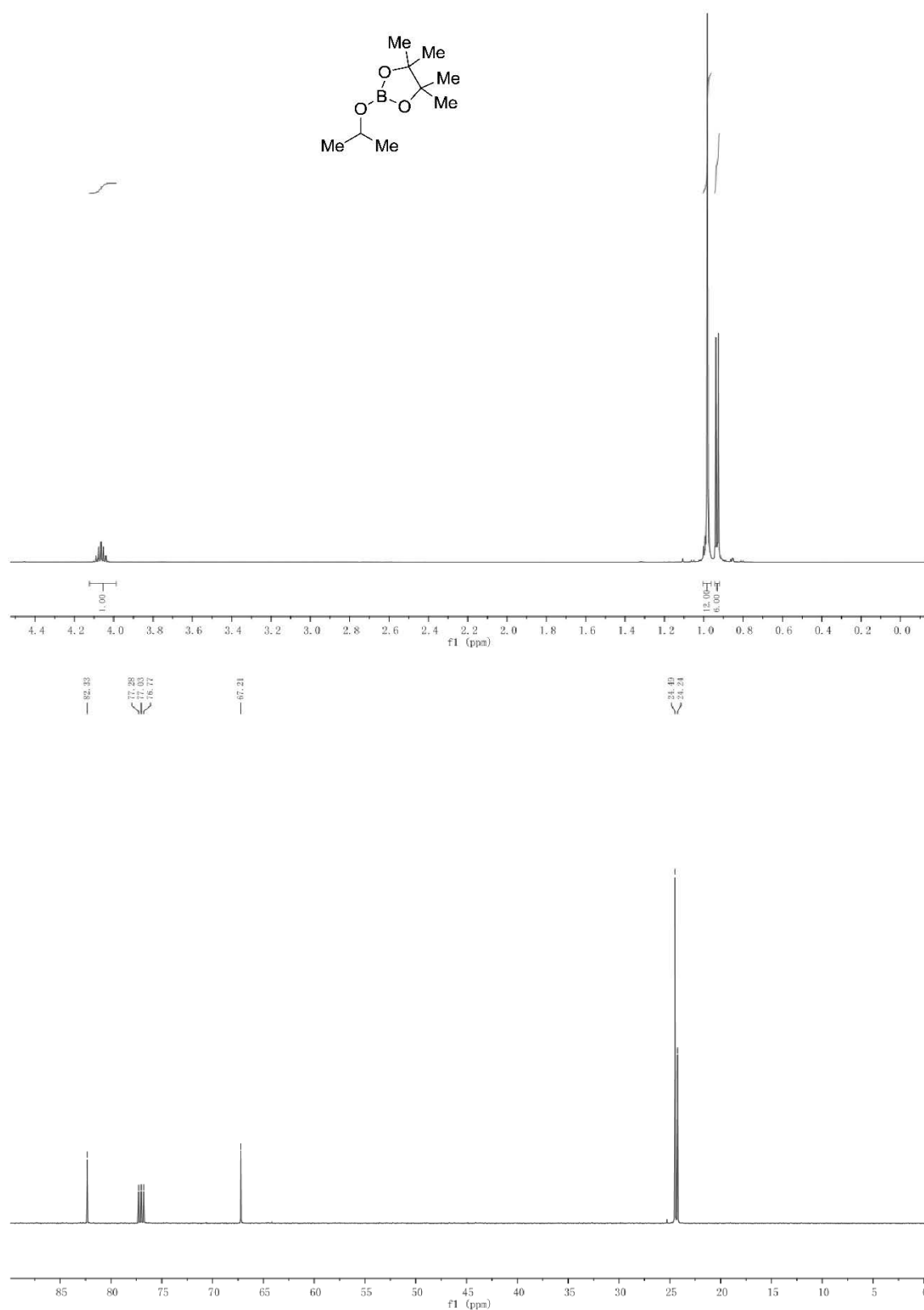


(E)-2-(4-Bromophenyl)-5-styrylthiophene (8c)

5 Experimental Section

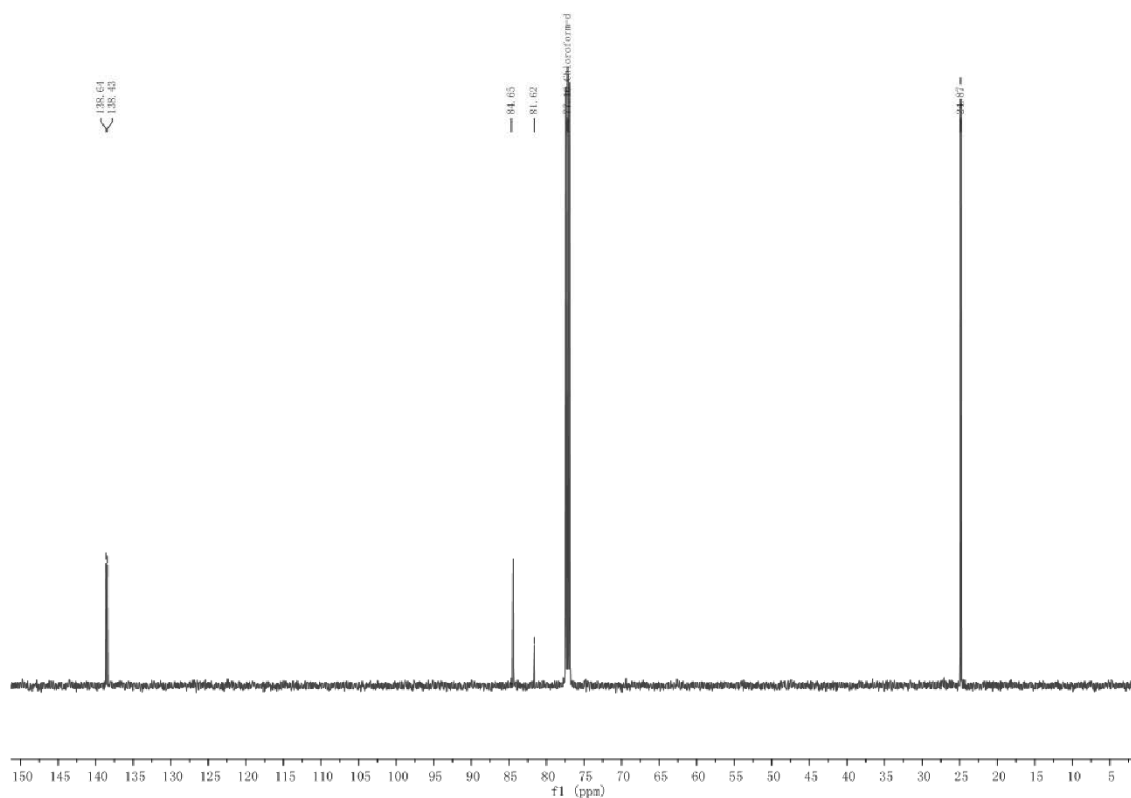
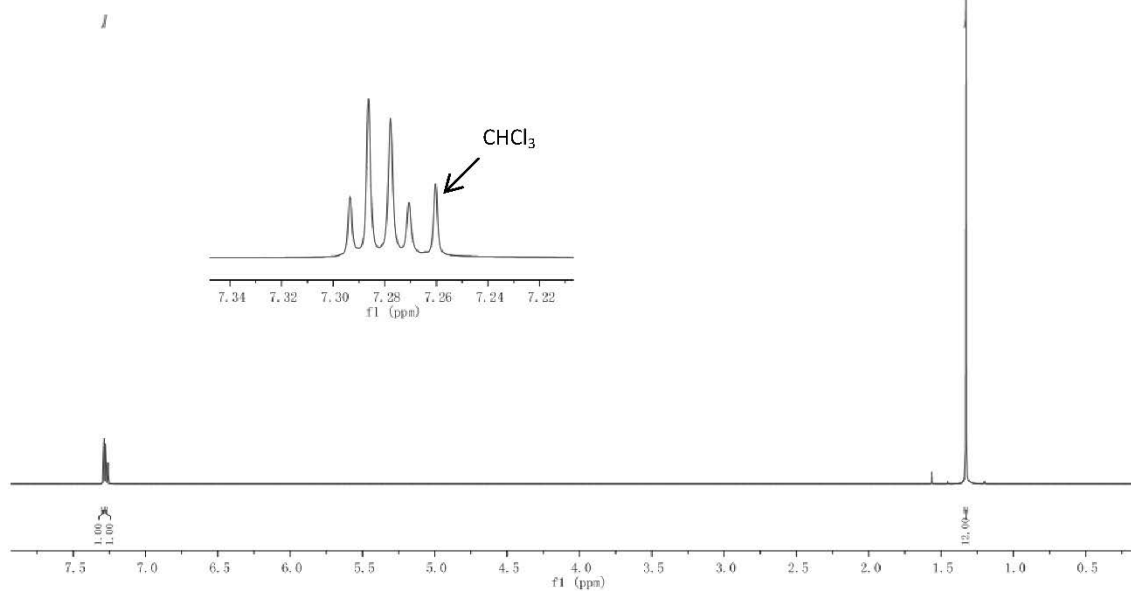
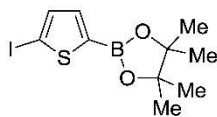
(*E*)-2-(Phenylethynyl)-5-styrylthiophene (8d)



2-Isopropoxy-4,4,5,5-tetramethyl-1,3,2-dioxaborolane (iPrO-BPin) (9)

5 Experimental Section

2-(5-Iodothiophen-2-yl)-4,4,5,5-tetramethyl-1,3,2-dioxaborolane (10)



References

- [1] J. Linshoeff, A. C. J. Heinrich, S. A. W. Segler, P. J. Gates, A. Staubitz, *Org. Lett.* **2012**, *14*, 5644-5647.
- [2] R. A. Fursule, P. O. Patil, B. D. Shewale, S. B. Kosalge, P. K. Deshmukh, D. A. Patil, *Chem. Pharm. Bull.* **2009**, *57*, 1243-1245.
- [3] J. P. Das, S. Roy, *J. Org. Chem.* **2002**, *67*, 7861-7864.
- [4] A. Hayford, J. Kaloko, S. El-Kazaz, G. Bass, C. Harrison, T. Corprew, *Org. Lett.* **2005**, *7*, 2671-2673.
- [5] L. Legoabe, J. Kruger, A. Petzer, J. J. Bergh, J. P. Petzer, *Eur. J. Med. Chem.* **2011**, *46*, 5162-5174.
- [6] H. J. Zhang, D. D. Zhu, Z. L. Li, J. Sun, H. L. Zhu, *Bioorg. Med. Chem.* **2011**, *19*, 4513-4519.
- [7] M. Yamagishi, K. Nishigai, T. Hata, H. Urabe, *Org. Lett.* **2011**, *13*, 4873-4875.
- [8] Z. W. Chen, H. F. Jiang, Y. B. Li, C. R. Qi, *Chem. Commun.* **2010**, *46*, 8049-8051.
- [9] M. A. Fox, A. M. Cameron, P. J. Low, M. A. J. Paterson, A. S. Batsanov, A. E. Goeta, D. W. H. Rankin, H. E. Robertson, J. T. Schirlin, *Dalton. Trans.* **2006**, 3544-3560.
- [10] D. Farran, A. M. Z. Slawin, P. Kirsch, D. O'Hagan, *J. Org. Chem.* **2009**, *74*, 7168-7171.
- [11] M. W. Andersen, B. Hildebrandt, G. Koster, R. W. Hoffmann, *Chem. Ber.* **1989**, *122*, 1777-1782.

6 References

- [1] PlasticsEurope *Plastics - the Facts 2015*, PlasticsEurope, 2015.
- [2] Franssen, N. M. G.; Reek, J. N. H.; de Bruin, B. *Chem. Soc. Rev.* **2013**, *42*, 5809.
- [3] Petreus, O.; Avram, E.; Lisa, G.; Serbezeanu, D. *J. Appl. Polym. Sci.* **2010**, *115*, 2084.
- [4] Kawamura, T.; Uryu, T.; Matsuzaki, K. *Macromol. Chem. Phys.* **1982**, *183*, 125.
- [5] Kawamura, T.; Uryu, T.; Matsuzaki, K. *Macromol. Chem. Phys.* **1982**, *183*, 153.
- [6] Kawamura, T.; Uryu, T.; Matsuzaki, K. *Macromol. Chem. Phys.* **1982**, *183*, 143.
- [7] Kawamura, T.; Uryu, T.; Seki, T.; Matsuzaki, K. *Macromol. Chem. Phys.* **1982**, *183*, 1647.
- [8] Kawamura, T.; Uryu, T.; Seki, T.; Matsuzaki, K. *Polym. J.* **1983**, *15*, 107.
- [9] Dunham, K. R.; Faber, J. W. H.; Vandenberghe, J.; Fowler, W. F. *J. Appl. Polym. Sci.* **1963**, *7*, 897.
- [10] Georg, A. In *Kunststoff-Wissen für Einsteiger*; Carl Hanser Verlag GmbH & Co. KG: 2014, p 111.
- [11] plastics.americanchemistry.com. <https://plastics.americanchemistry.com/Polystyrene-Packaging-Safe-Affordable-and-Environmentally-Responsible/> (Oct 17, 2016).
- [12] ww.epi-global.com. <http://www.epi-global.com/files/brochures/1258579000PSAP01091118EPI.pdf> (Oct 17, 2016).
- [13] ChemicalSafetyFacts.org. www.chemicalsafetyfacts.org/wp-content/uploads/2014/05/082514_ChemSafety_Print-Polystyrene.pdf (Oct 17, 2016).
- [14] Severin. <http://www.severin.de/grillen-geniessen/kuehlboxen/elektrische-kuehlbox-kb-2922> (Sep 6, 2016).
- [15] [http://www.styroporboxen24.de/out/pictures/master/product/1/dsc06433\(3\).jpg](http://www.styroporboxen24.de/out/pictures/master/product/1/dsc06433(3).jpg) (Sep 26, 2016).
- [16] DirectIndustry. <http://www.directindustry.de/prod/revoluplast/product-27558-1648387.html> (Sep 6, 2016).
- [17] Papersmart. <https://www.papersmart.de/system/images/articles/helit-briefablage-economy-49ae268aca4fe459e43471d383f4fd21-740x740.jpg> (Sep 26, 2016).
- [18] Kayser, F.; Lauer, W.; Zimmer, R. J. "Pneumatic tire having a rubber component containing high impact polystyrene." U.S. Patent No. 7,022,757, Apr 4, 2006.
- [19] Corradini, P.; Ganis, P. *J. Polym. Sci.* **1960**, *43*, 311.
- [20] Natta, G.; Corradini, P.; Bassi, I. *Il Nuovo Cimento (1955-1965)* **1960**, *15*, 68.
- [21] Pietsch, T.; Metwalli, E.; Roth, S. V.; Gebhardt, R.; Gindy, N.; Muller-Buschbaum, P.; Fahmi, A. *Macromol. Chem. Phys.* **2009**, *210*, 864.
- [22] Gohy, J. F. *Block Copolymers li* **2005**, *190*, 65.
- [23] Brahm, M. *Polymerchemie kompakt: Grundlagen - Struktur der Makromoleküle - technisch wichtige Polymere und Reaktivsysteme ; mit 17 Tabellen*; Hirzel, 2005.
- [24] De Rosa, C.; Guerra, G.; Petraccone, V.; Corradini, P. *Polym. J.* **1991**, *23*, 1435.

- [25] Noether, H. D. *J. Polym. Sci., C Polym. Symp.* **1967**, 725.
- [26] Ellis, B.; Smith, R. *Polymers: A Property Database, Second Edition*; CRC Press, 2008.
- [27] Danusso, F.; Polizzotti, G. *Makromol. Chem.* **1963**, 61, 157.
- [28] Claudy, P.; Letoffe, J. M.; Camberlain, Y.; Pascault, J. P. *Polym. Bull.* **1983**, 9, 208.
- [29] Ellison, C. J.; Mundra, M. K.; Torkelson, J. M. *Macromolecules* **2005**, 38, 1767.
- [30] Odian, G. In *Principles of Polymerization*; John Wiley & Sons, Inc.: 2004, p 372.
- [31] Odian, G. In *Principles of Polymerization*; John Wiley & Sons, Inc.: 2004, p 198.
- [32] Wan, W.-M.; Baggett, A. W.; Cheng, F.; Lin, H.; Liu, S.-Y.; Jäkle, F. *Chem. Commun.* **2016**.
- [33] "The Nobel Prize in Chemistry 1976". *Nobelprize.org*. Nobel Media AB 2014. Sep 27, 2016. <http://www.nobelprize.org/nobel_prizes/chemistry/laureates/1976/>
- [34] "The Nobel Prize in Chemistry 1979". *Nobelprize.org*. Nobel Media AB 2014. Sep 27, 2016. <http://www.nobelprize.org/nobel_prizes/chemistry/laureates/1979/>
- [35] "The Nobel Prize in Chemistry 2010". *Nobelprize.org*. Nobel Media AB 2014. Sep 27, 2016. <http://www.nobelprize.org/nobel_prizes/chemistry/laureates/2010/>
- [36] Campbell, P. G.; Zakharov, L. N.; Grant, D. J.; Dixon, D. A.; Liu, S.-Y. *J. Am. Chem. Soc.* **2010**, 132, 3289.
- [37] Huang, Z. G.; Autrey, T. *Energy Environ. Sci.* **2012**, 5, 9257.
- [38] Hugle, T.; Kuhnel, M. F.; Lentz, D. *J. Am. Chem. Soc.* **2009**, 131, 7444.
- [39] Staubitz, A.; Robertson, A. P. M.; Manners, I. *Chem. Rev.* **2010**, 110, 4079.
- [40] Baker, S. J.; Tomsho, J. W.; Benkovic, S. J. *Chem. Soc. Rev.* **2011**, 40, 4279.
- [41] Kwong, R. "Boron-nitrogen polyaromatic compounds and their use in OLEDs." US20140027734A1, 2014.
- [42] Li, G.; Zhao, Y.; Li, J.; Cao, J.; Zhu, J.; Sun, X. W.; Zhang, Q. *J. Org. Chem.* **2015**, 80, 196.
- [43] Wang, X. Y.; Narita, A.; Feng, X. L.; Mullen, K. *J. Am. Chem. Soc.* **2015**, 137, 7668.
- [44] Wang, X. Y.; Lin, H. R.; Lei, T.; Yang, D. C.; Zhuang, F. D.; Wang, J. Y.; Yuan, S. C.; Pei, J. *Angew. Chem. Int. Ed.* **2013**, 52, 3117; *Angew. Chem.* **2013**, 125, 3199.
- [45] Wang, X.-Y.; Wang, J.-Y.; Pei, J. *Chem. Eur. J.* **2015**, 21, 3528.
- [46] Thorne, L. R.; Suenram, R. D.; Lovas, F. J. *J. Chem. Phys.* **1983**, 78, 167.
- [47] Sugie, M.; Takeo, H.; Matsumura, C. *Chem. Phys. Lett.* **1979**, 64, 573.
- [48] Campbell, P. G.; Marwitz, A. J. V.; Liu, S. Y. *Angew. Chem. Int. Ed.* **2012**, 51, 6074; *Angew. Chem.* **2012**, 124, 6178.
- [49] Srivastava, A. K.; Misra, N. *Chem. Phys. Lett.* **2015**, 625, 5.
- [50] Srivastava, A. K.; Pandey, S. K.; Misra, N. *Mol. Phys.* **2016**, 114, 1763.
- [51] Baranac-Stojanovic, M. *Chem. Eur. J.* **2014**, 20, 16558.
- [52] Lamm, A. N.; Liu, S. Y. *Mol. Biosyst.* **2009**, 5, 1303.
- [53] Marwitz, A. J. V.; Matus, M. H.; Zakharov, L. N.; Dixon, D. A.; Liu, S. Y. *Angew. Chem. Int. Ed.* **2009**, 48, 973; *Angew. Chem.* **2009**, 121, 991.

- [54] Chrostowska, A.; Xu, S.; Lamm, A. N.; Mazière, A.; Weber, C. D.; Dargelos, A.; Baylère, P.; Graciaa, A.; Liu, S.-Y. *J. Am. Chem. Soc.* **2012**, *134*, 10279.
- [55] Baggett, A. W.; Guo, F.; Li, B.; Liu, S. Y.; Jäkle, F. *Angew. Chem. Int. Ed.* **2015**, *54*, 11191.
- [56] Baggett, A. W.; Guo, F.; Li, B.; Liu, S.-Y.; Jäkle, F. *Angew. Chem.* **2015**, *127*, 11343.
- [57] Su, K.; Remsen, E. E.; Thompson, H. M.; Sneddon, L. G. *Macromolecules* **1991**, *24*, 3760.
- [58] Blanchard, L. P.; Hesse, J.; Malhotra, S. L. *Can. J. Chem.* **1974**, *52*, 3170.
- [59] Dewar, M. J. S.; Marr, P. A. *J. Am. Chem. Soc.* **1962**, *84*, 3782.
- [60] White, D. G. *J. Am. Chem. Soc.* **1963**, *85*, 3634.
- [61] Wille, H.; Goubeau, J. *Chem. Ber.* **1974**, *107*, 110.
- [62] Ashe, A. J.; Fang, X. D. *Org. Lett.* **2000**, *2*, 2089.
- [63] Ashe, A. J.; Fang, X. D.; Fang, X. G.; Kampf, J. W. *Organometallics* **2001**, *20*, 5413.
- [64] Marwitz, A. J. V.; Abbey, E. R.; Jenkins, J. T.; Zakharov, L. N.; Liu, S. Y. *Org. Lett.* **2007**, *9*, 4905.
- [65] Abbey, E. R.; Lamm, A. N.; Baggett, A. W.; Zakharov, L. N.; Liu, S. Y. *J. Am. Chem. Soc.* **2013**, *135*, 12908.
- [66] Falbe, J.; Schulze-Steinen, H.-J.; Korte, F. *Chem. Ber.* **1965**, *98*, 1923.
- [67] Barluenga, J.; Rodriguez, F.; Alvarez-Rodrigo, L.; Zapico, J. M.; Fananas, F. J. *Chem. Eur. J.* **2004**, *10*, 109.
- [68] Guerin, C.; Bellosta, V.; Guillamot, G.; Cossy, J. *Org. Lett.* **2011**, *13*, 3534.
- [69] D'hooghe, M.; De Kimpe, N. *Arkivoc* **2007**, 365.
- [70] Blackburn, L.; Taylor, R. J. K. *Org. Lett.* **2001**, *3*, 1637.
- [71] Panayides, J. L.; Pathak, R.; de Koning, C. B.; van Otterlo, W. A. L. *Eur. J. Org. Chem.* **2007**, 4953.
- [72] Thiedemann, B.; Schmitz, C. M. L.; Staubitz, A. *J. Org. Chem.* **2014**, *79*, 10284.
- [73] Dölger, L. Bachelor's Thesis, University of Kiel, 2015.
- [74] Lamm, A. N.; Garner, E. B.; Dixon, D. A.; Liu, S. Y. *Angew. Chem. Int. Ed.* **2011**, *50*, 8157; *Angew. Chem.* **2011**, *123*, 8307.
- [75] Ashe, A. J.; Yang, H.; Fang, X.; Kampf, J. W. *Organometallics* **2002**, *21*, 4578.
- [76] Fang, X.; Yang, H.; Kampf, J. W.; Banaszak Holl, M. M.; Ashe, A. J. *Organometallics* **2005**, *25*, 513.
- [77] Tanjaroon, C.; Daly, A.; Marwitz, A. J. V.; Liu, S. Y.; Kukolich, S. *J. Chem. Phys.* **2009**, *131*.
- [78] Abbey, E. R.; Lamm, A. N.; Baggett, A. W.; Zakharov, L. N.; Liu, S.-Y. *J. Am. Chem. Soc.* **2013**, *135*, 12908.
- [79] Clark, T.; Hennemann, M.; Murray, J. S.; Politzer, P. *J. Mol. Model.* **2007**, *13*, 291.
- [80] Brammer, L.; Espallargas, G. M.; Adams, H. *CrystEngComm* **2003**, *5*, 343.
- [81] Kovács, A.; Varga, Z. *Coord. Chem. Rev.* **2006**, *250*, 710.
- [82] Fourmigué, M. *Curr. Opin. Solid State Mater. Sci.* **2009**, *13*, 36.

- [83] Kępiński, L. *Catal. Today* **1999**, *50*, 237.
- [84] Albers, P.; Pietsch, J.; Parker, S. F. *J. Mol. Catal. A: Chem.* **2001**, *173*, 275.
- [85] Mitchell, E. A.; Jessop, P. G.; Baird, M. C. *Organometallics* **2009**, *28*, 6732.
- [86] Iosub, A. V.; Stahl, S. S. *J. Am. Chem. Soc.* **2015**, *137*, 3454.
- [87] Littke, A. F.; Fu, G. C. *Angew. Chem. Int. Ed.* **2002**, *41*, 4176; *Angew. Chem.* **2002**, *114*, 4350.
- [88] de Vries, A. H. M.; Mulders, J. M. C. A.; Mommers, J. H. M.; Henderickx, H. J. W.; de Vries, J. G. *Org. Lett.* **2003**, *5*, 3285.
- [89] Nowrouzi, N.; Tarokh, D. *J. Iran. Chem. Soc.* **2015**, *12*, 1623.
- [90] Hitachi High-Tech Application Brief: *DSC Measurements of Polystyrene - The Effects of Molecular Weight on Glass Transition -*; TA No. 68; Hitachi High-Tech Science Corporation.
- [91] Nicholas, K. M. *J. Am. Chem. Soc.* **1975**, *97*, 3254.
- [92] Gliese, P. Master's Thesis, University of Kiel, 2016.
- [93] Ahuja, R.; Punji, B.; Findlater, M.; Supplee, C.; Schinski, W.; Brookhart, M.; Goldman, A. S. *Nat Chem* **2011**, *3*, 167.
- [94] Ken-ichi, F.; Takehisa, U.; Ryohei, Y. *Chem. Lett.* **2013**, *42*, 1496.
- [95] Zanella, R.; Canziani, F.; Ros, R.; Graziani, M. *J. Organomet. Chem.* **1974**, *67*, 449.
- [96] Imamura, H.; Noda, Y.; Sakata, Y.; Tsuchiya, S. *J. Alloys Compd.* **2001**, *323–324*, 601.
- [97] Tlili, A.; Monnier, F.; Taillefer, M. *Chem. Commun.* **2012**, *48*, 6408.
- [98] Pan, J.; Kampf, J. W.; Ashe, A. J. *Org. Lett.* **2007**, *9*, 679.
- [99] Brown, A. N.; Li, B.; Liu, S.-Y. *J. Am. Chem. Soc.* **2015**, *137*, 8932.
- [100] Baggett, A. W.; Vasiliu, M.; Li, B.; Dixon, D. A.; Liu, S.-Y. *J. Am. Chem. Soc.* **2015**, *137*, 5536.
- [101] Heinrich, A. C. J.; Thiedemann, B.; Gates, P. J.; Staubitz, A. *Org. Lett.* **2013**, *15*, 4666.
- [102] Linshoeft, J.; Heinrich, A. C. J.; Segler, S. A. W.; Gates, P. J.; Staubitz, A. *Org. Lett.* **2012**, *14*, 5644.
- [103] Otley, K. D.; Ellman, J. A. *Org. Lett.* **2015**, *17*, 1332.
- [104] Gøgsig, T. M.; Søbberg, L. S.; Lindhardt, A. T.; Jensen, K. L.; Skrydstrup, T. *J. Org. Chem.* **2008**, *73*, 3404.
- [105] Lennox, A. J. J.; Lloyd-Jones, G. C. *Chem. Soc. Rev.* **2014**, *43*, 412.
- [106] Lei, A.; Zhang, X. *Tetrahedron Lett.* **2002**, *43*, 2525.
- [107] Adamo, C.; Amatore, C.; Ciofini, I.; Jutand, A.; Lakmini, H. *J. Am. Chem. Soc.* **2006**, *128*, 6829.
- [108] Pan, J.; Kampf, J. W.; Ashe, A. J. *Organometallics* **2009**, *28*, 506.
- [109] Pan, J.; Kampf, J. W.; Ashe, A. J. *J. Organomet. Chem.* **2009**, *694*, 1036.
- [110] Pan, J.; Kampf, J. W.; Ashe, A. J. *Organometallics* **2006**, *25*, 197.

6 References

[111] Moon, N. G.; Harned, A. M. *Tetrahedron Lett.* **2013**, *54*, 2960.

[112] Shapiro, S. L.; Parrino, V. A.; Freedman, L. J. *Am. Chem. Soc.* **1959**, *81*, 3728.

Appendix

Permissions and licenses for reprinted content of publications follow:

**JOHN WILEY AND SONS LICENSE
TERMS AND CONDITIONS**

Nov 02, 2016

This Agreement between Birk Thiedemann ("You") and John Wiley and Sons ("John Wiley and Sons") consists of your license details and the terms and conditions provided by John Wiley and Sons and Copyright Clearance Center.

License Number	3980770380735
License date	Nov 02, 2016
Licensed Content Publisher	John Wiley and Sons
Licensed Content Publication	Angewandte Chemie International Edition
Licensed Content Title	A Hybrid Organic/Inorganic Benzene
Licensed Content Author	Adam J. V. Marwitz, Myrna H. Matus, Lev N. Zakharov, David A. Dixon, Shih-Yuan Liu
Licensed Content Date	Dec 22, 2008
Licensed Content Pages	5
Type of use	Dissertation/Thesis
Requestor type	University/Academic
Format	Print and electronic
Portion	Figure/table
Number of figures/tables	1
Original Wiley figure/table number(s)	Figure 2
Will you be translating?	No
Title of your thesis / dissertation	Syntheses of Azaborine Polymers and Optimisation of Precursor Syntheses
Expected completion date	Nov 2016
Expected size (number of pages)	300
Requestor Location	Birk Thiedemann Otto-Hahn-Platz 4 Kiel, 24098 Germany Attn: Birk Thiedemann
Publisher Tax ID	EU826007151
Billing Type	Invoice
Billing Address	Birk Thiedemann Otto-Hahn-Platz 4 Kiel, Germany 24098 Attn: Birk Thiedemann
Total	0.00 EUR
Terms and Conditions	

TERMS AND CONDITIONS

This copyrighted material is owned by or exclusively licensed to John Wiley & Sons, Inc. or one of its group companies (each a "Wiley Company") or handled on behalf of a society with

which a Wiley Company has exclusive publishing rights in relation to a particular work (collectively "WILEY"). By clicking "accept" in connection with completing this licensing transaction, you agree that the following terms and conditions apply to this transaction (along with the billing and payment terms and conditions established by the Copyright Clearance Center Inc., ("CCC's Billing and Payment terms and conditions"), at the time that you opened your RightsLink account (these are available at any time at <http://myaccount.copyright.com>).

Terms and Conditions

- The materials you have requested permission to reproduce or reuse (the "Wiley Materials") are protected by copyright.
- You are hereby granted a personal, non-exclusive, non-sub licensable (on a stand-alone basis), non-transferable, worldwide, limited license to reproduce the Wiley Materials for the purpose specified in the licensing process. This license, **and any CONTENT (PDF or image file) purchased as part of your order**, is for a one-time use only and limited to any maximum distribution number specified in the license. The first instance of republication or reuse granted by this license must be completed within two years of the date of the grant of this license (although copies prepared before the end date may be distributed thereafter). The Wiley Materials shall not be used in any other manner or for any other purpose, beyond what is granted in the license. Permission is granted subject to an appropriate acknowledgement given to the author, title of the material/book/journal and the publisher. You shall also duplicate the copyright notice that appears in the Wiley publication in your use of the Wiley Material. Permission is also granted on the understanding that nowhere in the text is a previously published source acknowledged for all or part of this Wiley Material. Any third party content is expressly excluded from this permission.
- With respect to the Wiley Materials, all rights are reserved. Except as expressly granted by the terms of the license, no part of the Wiley Materials may be copied, modified, adapted (except for minor reformatting required by the new Publication), translated, reproduced, transferred or distributed, in any form or by any means, and no derivative works may be made based on the Wiley Materials without the prior permission of the respective copyright owner. **For STM Signatory Publishers clearing permission under the terms of the STM Permissions Guidelines only, the terms of the license are extended to include subsequent editions and for editions in other languages, provided such editions are for the work as a whole in situ and does not involve the separate exploitation of the permitted figures or extracts**, You may not alter, remove or suppress in any manner any copyright, trademark or other notices displayed by the Wiley Materials. You may not license, rent, sell, loan, lease, pledge, offer as security, transfer or assign the Wiley Materials on a stand-alone basis, or any of the rights granted to you hereunder to any other person.
- The Wiley Materials and all of the intellectual property rights therein shall at all times remain the exclusive property of John Wiley & Sons Inc, the Wiley Companies, or their respective licensors, and your interest therein is only that of having possession of and the right to reproduce the Wiley Materials pursuant to Section 2 herein during the continuance of this Agreement. You agree that you own no right, title or interest in or to the Wiley Materials or any of the intellectual property rights therein. You shall have no rights hereunder other than the license as provided for above in Section 2. No right, license or interest to any trademark, trade name, service mark or other branding ("Marks") of WILEY or its licensors is granted hereunder, and you agree that you shall not assert any such right, license or interest with respect thereto
- NEITHER WILEY NOR ITS LICENSORS MAKES ANY WARRANTY OR REPRESENTATION OF ANY KIND TO YOU OR ANY THIRD PARTY, EXPRESS, IMPLIED OR STATUTORY, WITH RESPECT TO THE MATERIALS

OR THE ACCURACY OF ANY INFORMATION CONTAINED IN THE MATERIALS, INCLUDING, WITHOUT LIMITATION, ANY IMPLIED WARRANTY OF MERCHANTABILITY, ACCURACY, SATISFACTORY QUALITY, FITNESS FOR A PARTICULAR PURPOSE, USABILITY, INTEGRATION OR NON-INFRINGEMENT AND ALL SUCH WARRANTIES ARE HEREBY EXCLUDED BY WILEY AND ITS LICENSORS AND WAIVED BY YOU.

- WILEY shall have the right to terminate this Agreement immediately upon breach of this Agreement by you.
- You shall indemnify, defend and hold harmless WILEY, its Licensors and their respective directors, officers, agents and employees, from and against any actual or threatened claims, demands, causes of action or proceedings arising from any breach of this Agreement by you.
- IN NO EVENT SHALL WILEY OR ITS LICENSORS BE LIABLE TO YOU OR ANY OTHER PARTY OR ANY OTHER PERSON OR ENTITY FOR ANY SPECIAL, CONSEQUENTIAL, INCIDENTAL, INDIRECT, EXEMPLARY OR PUNITIVE DAMAGES, HOWEVER CAUSED, ARISING OUT OF OR IN CONNECTION WITH THE DOWNLOADING, PROVISIONING, VIEWING OR USE OF THE MATERIALS REGARDLESS OF THE FORM OF ACTION, WHETHER FOR BREACH OF CONTRACT, BREACH OF WARRANTY, TORT, NEGLIGENCE, INFRINGEMENT OR OTHERWISE (INCLUDING, WITHOUT LIMITATION, DAMAGES BASED ON LOSS OF PROFITS, DATA, FILES, USE, BUSINESS OPPORTUNITY OR CLAIMS OF THIRD PARTIES), AND WHETHER OR NOT THE PARTY HAS BEEN ADVISED OF THE POSSIBILITY OF SUCH DAMAGES. THIS LIMITATION SHALL APPLY NOTWITHSTANDING ANY FAILURE OF ESSENTIAL PURPOSE OF ANY LIMITED REMEDY PROVIDED HEREIN.
- Should any provision of this Agreement be held by a court of competent jurisdiction to be illegal, invalid, or unenforceable, that provision shall be deemed amended to achieve as nearly as possible the same economic effect as the original provision, and the legality, validity and enforceability of the remaining provisions of this Agreement shall not be affected or impaired thereby.
- The failure of either party to enforce any term or condition of this Agreement shall not constitute a waiver of either party's right to enforce each and every term and condition of this Agreement. No breach under this agreement shall be deemed waived or excused by either party unless such waiver or consent is in writing signed by the party granting such waiver or consent. The waiver by or consent of a party to a breach of any provision of this Agreement shall not operate or be construed as a waiver of or consent to any other or subsequent breach by such other party.
- This Agreement may not be assigned (including by operation of law or otherwise) by you without WILEY's prior written consent.
- Any fee required for this permission shall be non-refundable after thirty (30) days from receipt by the CCC.
- These terms and conditions together with CCC's Billing and Payment terms and conditions (which are incorporated herein) form the entire agreement between you and WILEY concerning this licensing transaction and (in the absence of fraud) supersedes all prior agreements and representations of the parties, oral or written. This Agreement may not be amended except in writing signed by both parties. This Agreement shall be binding upon and inure to the benefit of the parties' successors, legal representatives,

and authorized assigns.

- In the event of any conflict between your obligations established by these terms and conditions and those established by CCC's Billing and Payment terms and conditions, these terms and conditions shall prevail.
- WILEY expressly reserves all rights not specifically granted in the combination of (i) the license details provided by you and accepted in the course of this licensing transaction, (ii) these terms and conditions and (iii) CCC's Billing and Payment terms and conditions.
- This Agreement will be void if the Type of Use, Format, Circulation, or Requestor Type was misrepresented during the licensing process.
- This Agreement shall be governed by and construed in accordance with the laws of the State of New York, USA, without regards to such state's conflict of law rules. Any legal action, suit or proceeding arising out of or relating to these Terms and Conditions or the breach thereof shall be instituted in a court of competent jurisdiction in New York County in the State of New York in the United States of America and each party hereby consents and submits to the personal jurisdiction of such court, waives any objection to venue in such court and consents to service of process by registered or certified mail, return receipt requested, at the last known address of such party.

WILEY OPEN ACCESS TERMS AND CONDITIONS

Wiley Publishes Open Access Articles in fully Open Access Journals and in Subscription journals offering Online Open. Although most of the fully Open Access journals publish open access articles under the terms of the Creative Commons Attribution (CC BY) License only, the subscription journals and a few of the Open Access Journals offer a choice of Creative Commons Licenses. The license type is clearly identified on the article.

The Creative Commons Attribution License

The Creative Commons Attribution License (CC-BY) allows users to copy, distribute and transmit an article, adapt the article and make commercial use of the article. The CC-BY license permits commercial and non-

Creative Commons Attribution Non-Commercial License

The Creative Commons Attribution Non-Commercial (CC-BY-NC) License permits use, distribution and reproduction in any medium, provided the original work is properly cited and is not used for commercial purposes.(see below)

Creative Commons Attribution-Non-Commercial-NoDerivs License

The Creative Commons Attribution Non-Commercial-NoDerivs License (CC-BY-NC-ND) permits use, distribution and reproduction in any medium, provided the original work is properly cited, is not used for commercial purposes and no modifications or adaptations are made. (see below)

Use by commercial "for-profit" organizations

Use of Wiley Open Access articles for commercial, promotional, or marketing purposes requires further explicit permission from Wiley and will be subject to a fee.

Further details can be found on Wiley Online Library

<http://olabout.wiley.com/WileyCDA/Section/id-410895.html>

Other Terms and Conditions:

v1.10 Last updated September 2015

Questions? customercare@copyright.com or +1-855-239-3415 (toll free in the US) or +1-978-646-2777.



Title: Reduction of N-Allylamides by LiAlH₄: Unexpected Attack of the Double Bond with Mechanistic Studies of Product and Byproduct Formation

Author: Birk Thiedemann, Christin M. L. Schmitz, Anne Staubitz

Publication: The Journal of Organic Chemistry

Publisher: American Chemical Society

Date: Nov 1, 2014

Copyright © 2014, American Chemical Society

LOGIN

If you're a **copyright.com** user, you can login to RightsLink using your copyright.com credentials. Already a **RightsLink user** or want to learn more?

PERMISSION/LICENSE IS GRANTED FOR YOUR ORDER AT NO CHARGE

This type of permission/license, instead of the standard Terms & Conditions, is sent to you because no fee is being charged for your order. Please note the following:

- Permission is granted for your request in both print and electronic formats, and translations.
- If figures and/or tables were requested, they may be adapted or used in part.
- Please print this page for your records and send a copy of it to your publisher/graduate school.
- Appropriate credit for the requested material should be given as follows: "Reprinted (adapted) with permission from (COMPLETE REFERENCE CITATION). Copyright (YEAR) American Chemical Society." Insert appropriate information in place of the capitalized words.
- One-time permission is granted only for the use specified in your request. No additional uses are granted (such as derivative works or other editions). For any other uses, please submit a new request.

BACK

CLOSE WINDOW

**JOHN WILEY AND SONS LICENSE
TERMS AND CONDITIONS**

Nov 02, 2016

This Agreement between Birk Thiedemann ("You") and John Wiley and Sons ("John Wiley and Sons") consists of your license details and the terms and conditions provided by John Wiley and Sons and Copyright Clearance Center.

License Number	3980750148112
License date	Nov 02, 2016
Licensed Content Publisher	John Wiley and Sons
Licensed Content Publication	European Journal of Organic Chemistry
Licensed Content Title	Nucleophile-Selective Cross-Coupling Reactions with Vinyl and Alkynyl Bromides on a Dinucleophilic Aromatic Substrate
Licensed Content Author	Lu-Ying He, Mathias Schulz-Senft, Birk Thiedemann, Julian Linshoef, Paul J. Gates, Anne Staubitz
Licensed Content Date	Feb 27, 2015
Licensed Content Pages	5
Type of use	Dissertation/Thesis
Requestor type	Author of this Wiley article
Format	Print and electronic
Portion	Full article
Will you be translating?	No
Title of your thesis / dissertation	Syntheses of Azaborine Polymers and Optimisation of Precursor Syntheses
Expected completion date	Nov 2016
Expected size (number of pages)	300
Requestor Location	Birk Thiedemann Otto-Hahn-Platz 4 Kiel, 24098 Germany Attn: Birk Thiedemann
Publisher Tax ID	EU826007151
Billing Type	Invoice
Billing Address	Birk Thiedemann Otto-Hahn-Platz 4 Kiel, Germany 24098 Attn: Birk Thiedemann
Total	0.00 EUR
Terms and Conditions	

TERMS AND CONDITIONS

This copyrighted material is owned by or exclusively licensed to John Wiley & Sons, Inc. or one of its group companies (each a "Wiley Company") or handled on behalf of a society with which a Wiley Company has exclusive publishing rights in relation to a particular work (collectively "WILEY"). By clicking "accept" in connection with completing this licensing transaction, you agree that the following terms and conditions apply to this transaction

(along with the billing and payment terms and conditions established by the Copyright Clearance Center Inc., ("CCC's Billing and Payment terms and conditions"), at the time that you opened your RightsLink account (these are available at any time at <http://myaccount.copyright.com>).

Terms and Conditions

- The materials you have requested permission to reproduce or reuse (the "Wiley Materials") are protected by copyright.
- You are hereby granted a personal, non-exclusive, non-sub licensable (on a stand-alone basis), non-transferable, worldwide, limited license to reproduce the Wiley Materials for the purpose specified in the licensing process. This license, **and any CONTENT (PDF or image file) purchased as part of your order**, is for a one-time use only and limited to any maximum distribution number specified in the license. The first instance of republication or reuse granted by this license must be completed within two years of the date of the grant of this license (although copies prepared before the end date may be distributed thereafter). The Wiley Materials shall not be used in any other manner or for any other purpose, beyond what is granted in the license. Permission is granted subject to an appropriate acknowledgement given to the author, title of the material/book/journal and the publisher. You shall also duplicate the copyright notice that appears in the Wiley publication in your use of the Wiley Material. Permission is also granted on the understanding that nowhere in the text is a previously published source acknowledged for all or part of this Wiley Material. Any third party content is expressly excluded from this permission.
- With respect to the Wiley Materials, all rights are reserved. Except as expressly granted by the terms of the license, no part of the Wiley Materials may be copied, modified, adapted (except for minor reformatting required by the new Publication), translated, reproduced, transferred or distributed, in any form or by any means, and no derivative works may be made based on the Wiley Materials without the prior permission of the respective copyright owner. **For STM Signatory Publishers clearing permission under the terms of the STM Permissions Guidelines only, the terms of the license are extended to include subsequent editions and for editions in other languages, provided such editions are for the work as a whole in situ and does not involve the separate exploitation of the permitted figures or extracts**, You may not alter, remove or suppress in any manner any copyright, trademark or other notices displayed by the Wiley Materials. You may not license, rent, sell, loan, lease, pledge, offer as security, transfer or assign the Wiley Materials on a stand-alone basis, or any of the rights granted to you hereunder to any other person.
- The Wiley Materials and all of the intellectual property rights therein shall at all times remain the exclusive property of John Wiley & Sons Inc, the Wiley Companies, or their respective licensors, and your interest therein is only that of having possession of and the right to reproduce the Wiley Materials pursuant to Section 2 herein during the continuance of this Agreement. You agree that you own no right, title or interest in or to the Wiley Materials or any of the intellectual property rights therein. You shall have no rights hereunder other than the license as provided for above in Section 2. No right, license or interest to any trademark, trade name, service mark or other branding ("Marks") of WILEY or its licensors is granted hereunder, and you agree that you shall not assert any such right, license or interest with respect thereto
- NEITHER WILEY NOR ITS LICENSORS MAKES ANY WARRANTY OR REPRESENTATION OF ANY KIND TO YOU OR ANY THIRD PARTY, EXPRESS, IMPLIED OR STATUTORY, WITH RESPECT TO THE MATERIALS OR THE ACCURACY OF ANY INFORMATION CONTAINED IN THE MATERIALS, INCLUDING, WITHOUT LIMITATION, ANY IMPLIED WARRANTY OF MERCHANTABILITY, ACCURACY, SATISFACTORY

QUALITY, FITNESS FOR A PARTICULAR PURPOSE, USABILITY, INTEGRATION OR NON-INFRINGEMENT AND ALL SUCH WARRANTIES ARE HEREBY EXCLUDED BY WILEY AND ITS LICENSORS AND WAIVED BY YOU.

- WILEY shall have the right to terminate this Agreement immediately upon breach of this Agreement by you.
- You shall indemnify, defend and hold harmless WILEY, its Licensors and their respective directors, officers, agents and employees, from and against any actual or threatened claims, demands, causes of action or proceedings arising from any breach of this Agreement by you.
- IN NO EVENT SHALL WILEY OR ITS LICENSORS BE LIABLE TO YOU OR ANY OTHER PARTY OR ANY OTHER PERSON OR ENTITY FOR ANY SPECIAL, CONSEQUENTIAL, INCIDENTAL, INDIRECT, EXEMPLARY OR PUNITIVE DAMAGES, HOWEVER CAUSED, ARISING OUT OF OR IN CONNECTION WITH THE DOWNLOADING, PROVISIONING, VIEWING OR USE OF THE MATERIALS REGARDLESS OF THE FORM OF ACTION, WHETHER FOR BREACH OF CONTRACT, BREACH OF WARRANTY, TORT, NEGLIGENCE, INFRINGEMENT OR OTHERWISE (INCLUDING, WITHOUT LIMITATION, DAMAGES BASED ON LOSS OF PROFITS, DATA, FILES, USE, BUSINESS OPPORTUNITY OR CLAIMS OF THIRD PARTIES), AND WHETHER OR NOT THE PARTY HAS BEEN ADVISED OF THE POSSIBILITY OF SUCH DAMAGES. THIS LIMITATION SHALL APPLY NOTWITHSTANDING ANY FAILURE OF ESSENTIAL PURPOSE OF ANY LIMITED REMEDY PROVIDED HEREIN.
- Should any provision of this Agreement be held by a court of competent jurisdiction to be illegal, invalid, or unenforceable, that provision shall be deemed amended to achieve as nearly as possible the same economic effect as the original provision, and the legality, validity and enforceability of the remaining provisions of this Agreement shall not be affected or impaired thereby.
- The failure of either party to enforce any term or condition of this Agreement shall not constitute a waiver of either party's right to enforce each and every term and condition of this Agreement. No breach under this agreement shall be deemed waived or excused by either party unless such waiver or consent is in writing signed by the party granting such waiver or consent. The waiver by or consent of a party to a breach of any provision of this Agreement shall not operate or be construed as a waiver of or consent to any other or subsequent breach by such other party.
- This Agreement may not be assigned (including by operation of law or otherwise) by you without WILEY's prior written consent.
- Any fee required for this permission shall be non-refundable after thirty (30) days from receipt by the CCC.
- These terms and conditions together with CCC's Billing and Payment terms and conditions (which are incorporated herein) form the entire agreement between you and WILEY concerning this licensing transaction and (in the absence of fraud) supersedes all prior agreements and representations of the parties, oral or written. This Agreement may not be amended except in writing signed by both parties. This Agreement shall be binding upon and inure to the benefit of the parties' successors, legal representatives, and authorized assigns.
- In the event of any conflict between your obligations established by these terms and conditions and those established by CCC's Billing and Payment terms and conditions,

these terms and conditions shall prevail.

- WILEY expressly reserves all rights not specifically granted in the combination of (i) the license details provided by you and accepted in the course of this licensing transaction, (ii) these terms and conditions and (iii) CCC's Billing and Payment terms and conditions.
- This Agreement will be void if the Type of Use, Format, Circulation, or Requestor Type was misrepresented during the licensing process.
- This Agreement shall be governed by and construed in accordance with the laws of the State of New York, USA, without regards to such state's conflict of law rules. Any legal action, suit or proceeding arising out of or relating to these Terms and Conditions or the breach thereof shall be instituted in a court of competent jurisdiction in New York County in the State of New York in the United States of America and each party hereby consents and submits to the personal jurisdiction of such court, waives any objection to venue in such court and consents to service of process by registered or certified mail, return receipt requested, at the last known address of such party.

WILEY OPEN ACCESS TERMS AND CONDITIONS

Wiley Publishes Open Access Articles in fully Open Access Journals and in Subscription journals offering Online Open. Although most of the fully Open Access journals publish open access articles under the terms of the Creative Commons Attribution (CC BY) License only, the subscription journals and a few of the Open Access Journals offer a choice of Creative Commons Licenses. The license type is clearly identified on the article.

The Creative Commons Attribution License

The Creative Commons Attribution License (CC-BY) allows users to copy, distribute and transmit an article, adapt the article and make commercial use of the article. The CC-BY license permits commercial and non-

Creative Commons Attribution Non-Commercial License

The Creative Commons Attribution Non-Commercial (CC-BY-NC) License permits use, distribution and reproduction in any medium, provided the original work is properly cited and is not used for commercial purposes.(see below)

Creative Commons Attribution-Non-Commercial-NoDerivs License

The Creative Commons Attribution Non-Commercial-NoDerivs License (CC-BY-NC-ND) permits use, distribution and reproduction in any medium, provided the original work is properly cited, is not used for commercial purposes and no modifications or adaptations are made. (see below)

Use by commercial "for-profit" organizations

Use of Wiley Open Access articles for commercial, promotional, or marketing purposes requires further explicit permission from Wiley and will be subject to a fee.

Further details can be found on Wiley Online Library

<http://olabout.wiley.com/WileyCDA/Section/id-410895.html>

Other Terms and Conditions:

v1.10 Last updated September 2015

Questions? customercare@copyright.com or +1-855-239-3415 (toll free in the US) or +1-978-646-2777.
