

Shallow water fouling assemblages  
exposed to abiotic disturbance & stress:  
the structuring role of emersion and UV-radiation



by

Markus Molis

Kiel June 2002

Shallow water fouling assemblages  
exposed to abiotic disturbance & stress:  
the structuring role of emersion and UV-radiation

Dissertation  
zur Erlangung des Doktorgrades  
der Mathematisch Naturwissenschaftlichen Fakultät  
der Christian-Albrechts-Universität  
zu Kiel

vorgelegt von

Markus Molis

Kiel Juni 2002

Referent: .....Prof. Dr. Wahl

Korreferent: .....Prof. Dr. Spindler

Tag der mündlichen Prüfung: .....10.07.02

Zum Druck genehmigt: .....10.07.02

Der Dekan: ..... Prof. Dr. Deppmeier

<b>SUMMARY</b> .....	<b>1</b>
<b>ZUSAMMENFASSUNG</b> .....	<b>3</b>
<b>1. GENERAL INTRODUCTION</b> .....	<b>7</b>
<b>2. STUDY SITES</b> .....	<b>13</b>
2.1. BALTIC SEA (EMERSION & UV) .....	14
2.2. SE ATLANTIC (UV ONLY) .....	16
<b>3. AMBIENT IRRADIANCE REGIMES</b> .....	<b>19</b>
3.1 BALTIC SEA .....	19
3.2 SE ATLANTIC .....	20
<b>4. BENTHIC DIVERSITY ALONG A EMERSION GRADIENT: AN EXPERIMENTAL TEST OF THE INTERMEDIATE DISTURBANCE HYPOTHESIS (IDH)</b> .....	<b>23</b>
4.1 INTRODUCTION .....	23
4.2 MATERIAL AND METHODS .....	23
4.3 RESULTS .....	28
<i>Larval supply</i> .....	28
<i>Emersion treatments</i> .....	29
4.4 DISCUSSION .....	38
<i>Larval supply</i> .....	38
<i>Emersion treatments</i> .....	39
<b>5. BENTHIC DIVERSITY ALONG AN UV GRADIENT: AN EXPERIMENTAL TEST OF THE INTERMEDIATE DISTURBANCE HYPOTHESIS (IDH)</b> .....	<b>45</b>
5.1 INTRODUCTION .....	45
5.2 MATERIAL AND METHODS .....	46
5.3 RESULTS .....	49
5.4 DISCUSSION .....	53

<b>6. A COMPARISON OF UV EFFECTS ON MACROBENTHIC FOULING ASSEMBLAGE STRUCTURE BETWEEN A BALTIC SEA AND SE ATLANTIC SITE.....</b>	<b>59</b>
6.1 INTRODUCTION.....	59
6.2 MATERIAL AND METHODS.....	59
6.3 RESULTS.....	64
6.4 DISCUSSION.....	69
<b>7. COMPARING RADIATION-CONSUMER INTERACTIONS BETWEEN BENTHIC ASSEMBLAGES FROM THE BALTIC SEA AND SE ATLANTIC.....</b>	<b>73</b>
7.1 INTRODUCTION.....	73
7.2 MATERIAL AND METHODS.....	73
7.3 RESULTS.....	75
7.4 DISCUSSION.....	76
<b>8. GENERAL DISCUSSION.....</b>	<b>79</b>
THE INTERMEDIATE DISTURBANCE HYPOTHESIS (IDH).....	79
ECOLOGICAL RELEVANCE OF ULTRAVIOLET RADIATION (UV).....	85
OUTLOOK.....	88
<b>9. GLOSSARY.....</b>	<b>89</b>
<b>10. APPENDIX.....</b>	<b>91</b>
TABLES.....	91
FIGURES.....	92
<b>11. REFERENCES.....</b>	<b>93</b>
<b>12. ACKNOWLEDGEMENTS.....</b>	<b>105</b>

## PHOTOGRAPHS

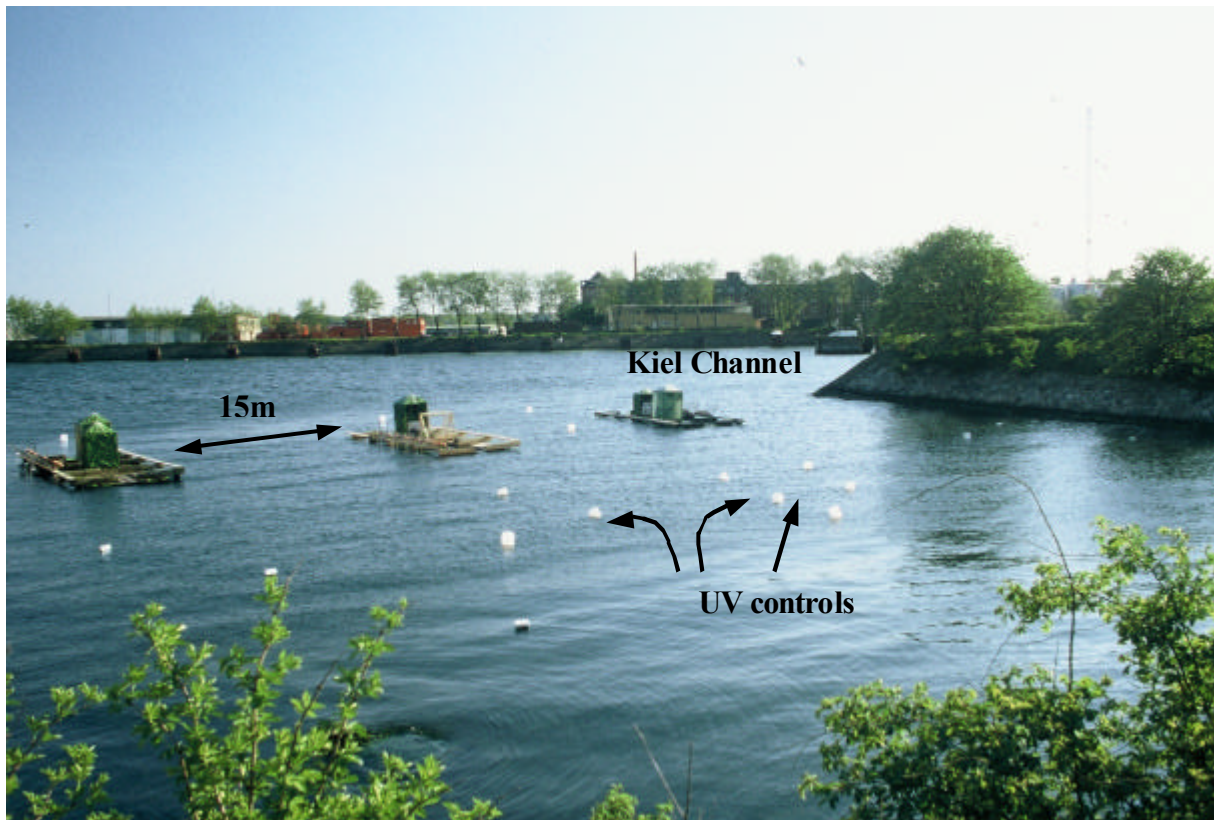

PHOTO 1: Baltic Sea site, used for experiments from 1998 - 2001. Relative position of blocks for emersion and UV treatments used in the IDH experiments at the experimental site of the Schleuseninsel Kiel Holtenau.

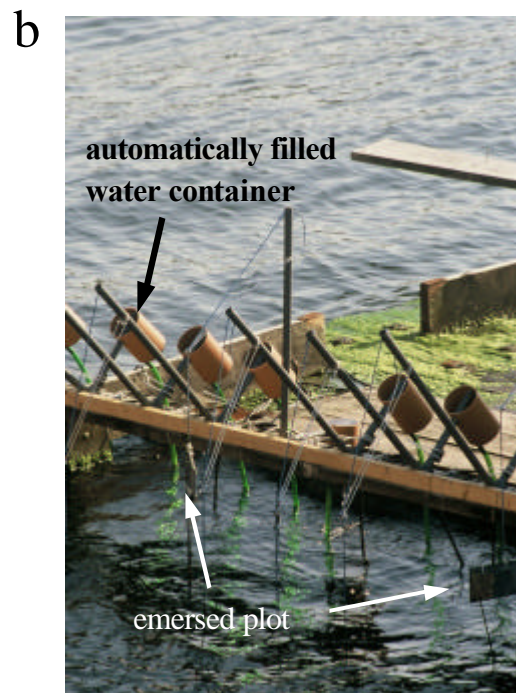
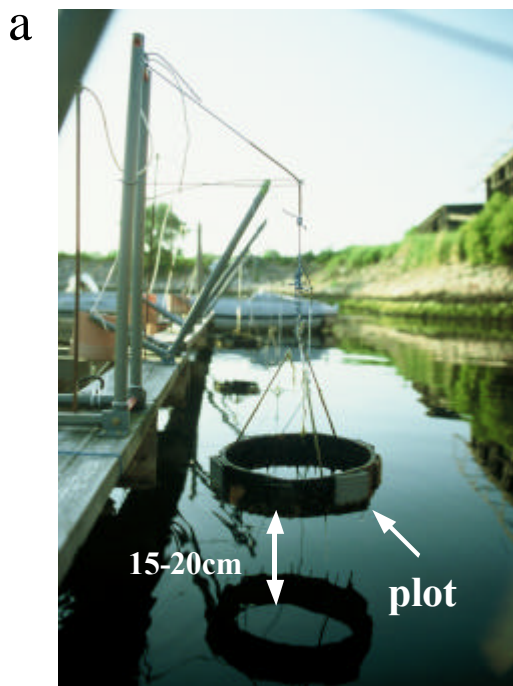

PHOTO 2: Seesaw system to generate emersion treatments showing both alternate states of emersion and submerision in (a) 1998, using rings with 4 plots and in (b) 2000, using separate seesaws for each plot.

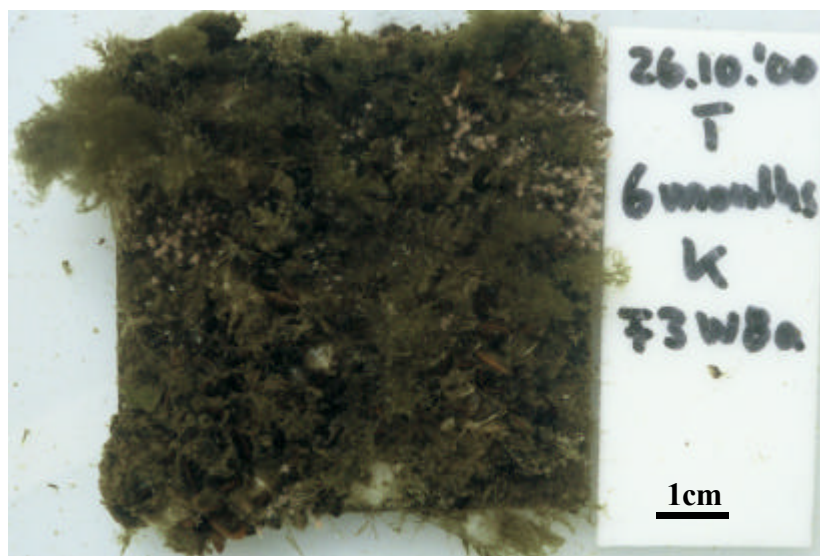

PHOTO 3: Baltic Sea site, emersion IDH experiment in 2000.

Fouling assemblage after 6 months without emersion. *Clava multicornis*, *Polydora ciliata*, mussels, barnacles and diatoms covered the plot.

PHOTO 4: Baltic Sea site, emersion IDH experiment in 2000.

Fouling assemblage after 6 months of daily 12h emersion time. *Chaetomorpha aerea*, *Enteromorpha intestinalis* and diatoms covered the plot almost exclusively.

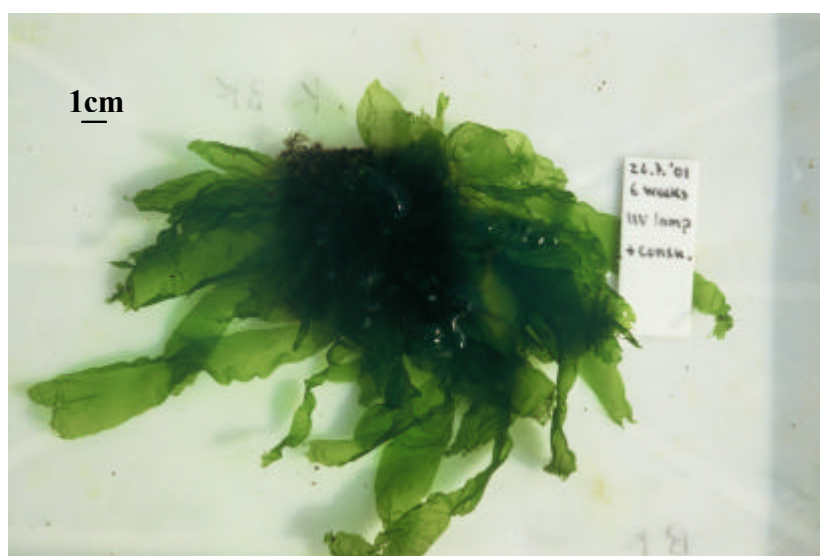
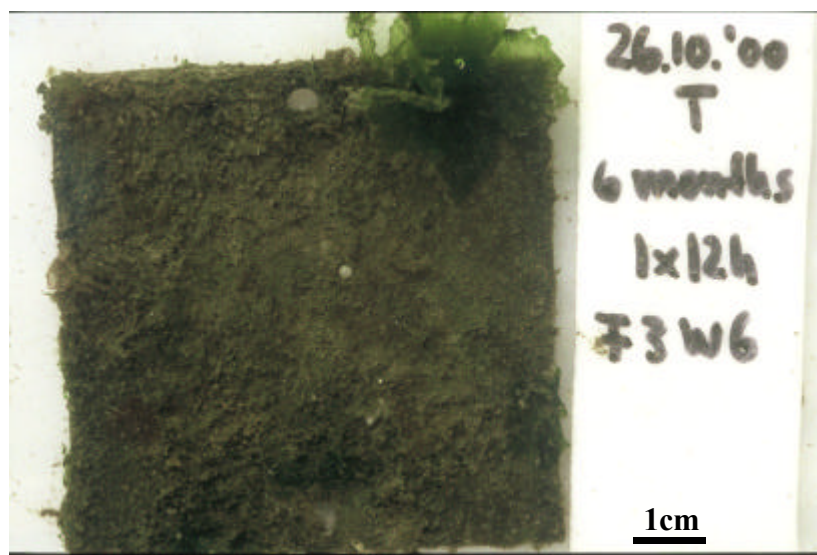

PHOTO 5: Baltic Sea site, UV-stress experiment in 2001.

Fouling assemblage after 6 weeks of daily 8h exposure to enhanced UVB radiation. Despite the presence of consumers, the green algae *Enteromorpha intestinalis* reached massive stands on the plots.

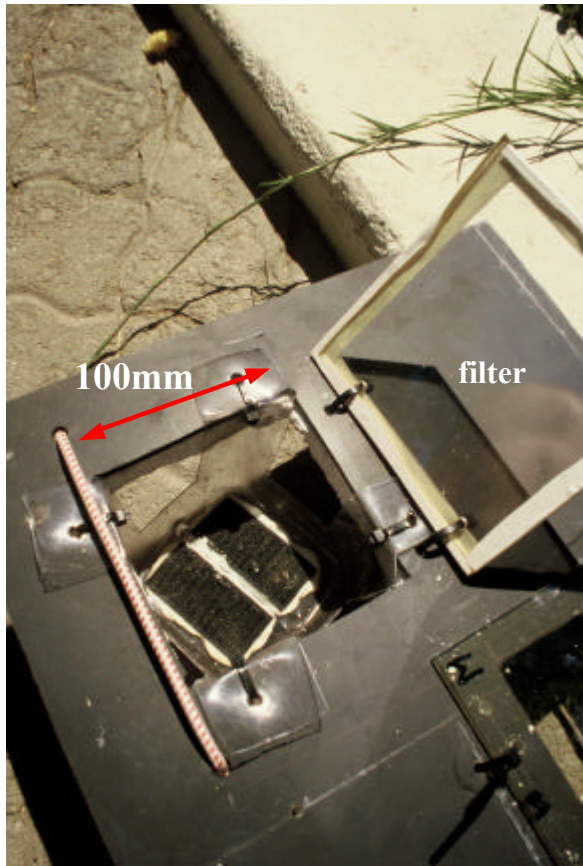

PHOTO 6: Baltic Sea & SE Atlantic site, UV radiation stress experiment in 2000/01.

Experimental unit on a test raft, seen from above. Velcro (2 black stripes) on the bottom of container to fix settlement panel (= plot) which was excluded for clearness. Red-white rubber band was used to fix filter reversibly over the settlement panel.

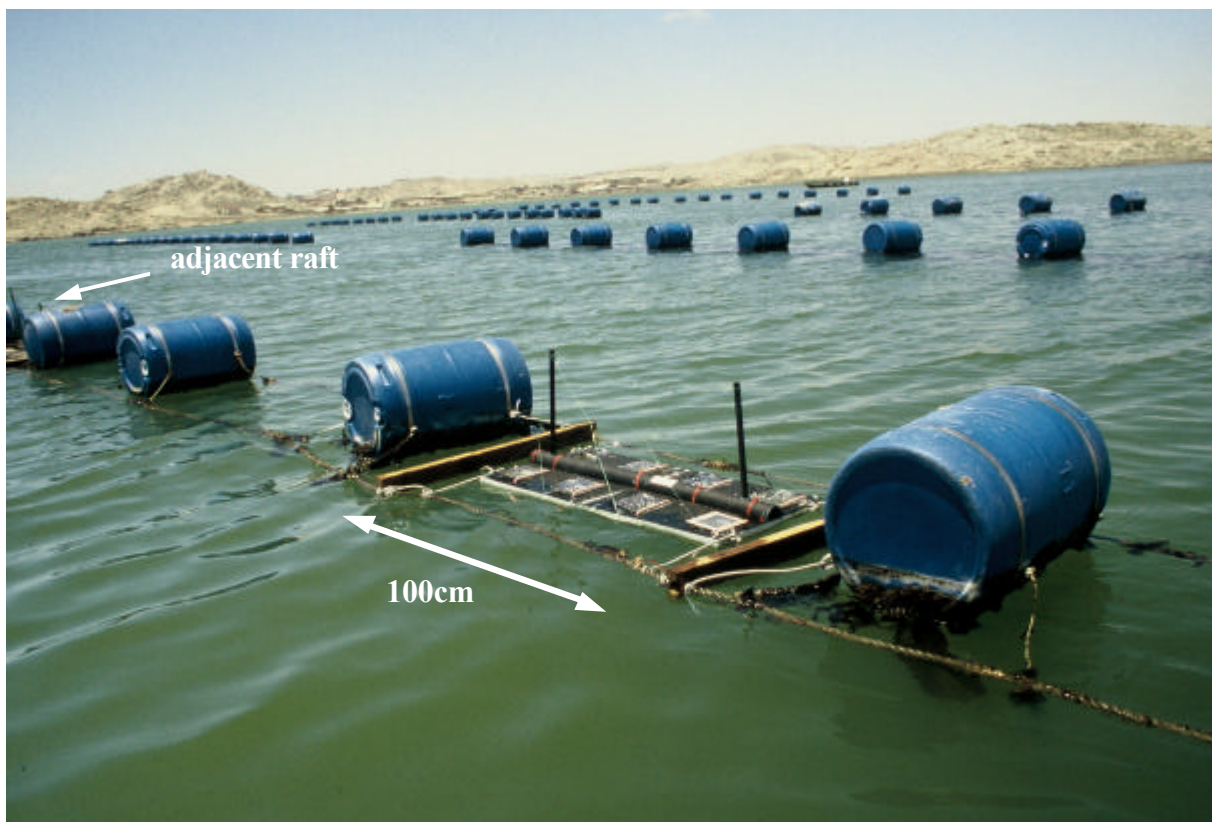

PHOTO 7: SE Atlantic site, UV radiation stress experiment in 2000/01. Raft containing 8 experimental units. Blue tons and parallel ropes were part of the mooring system used by the oyster farm at Radford Bay, Lüderitz, Namibia.



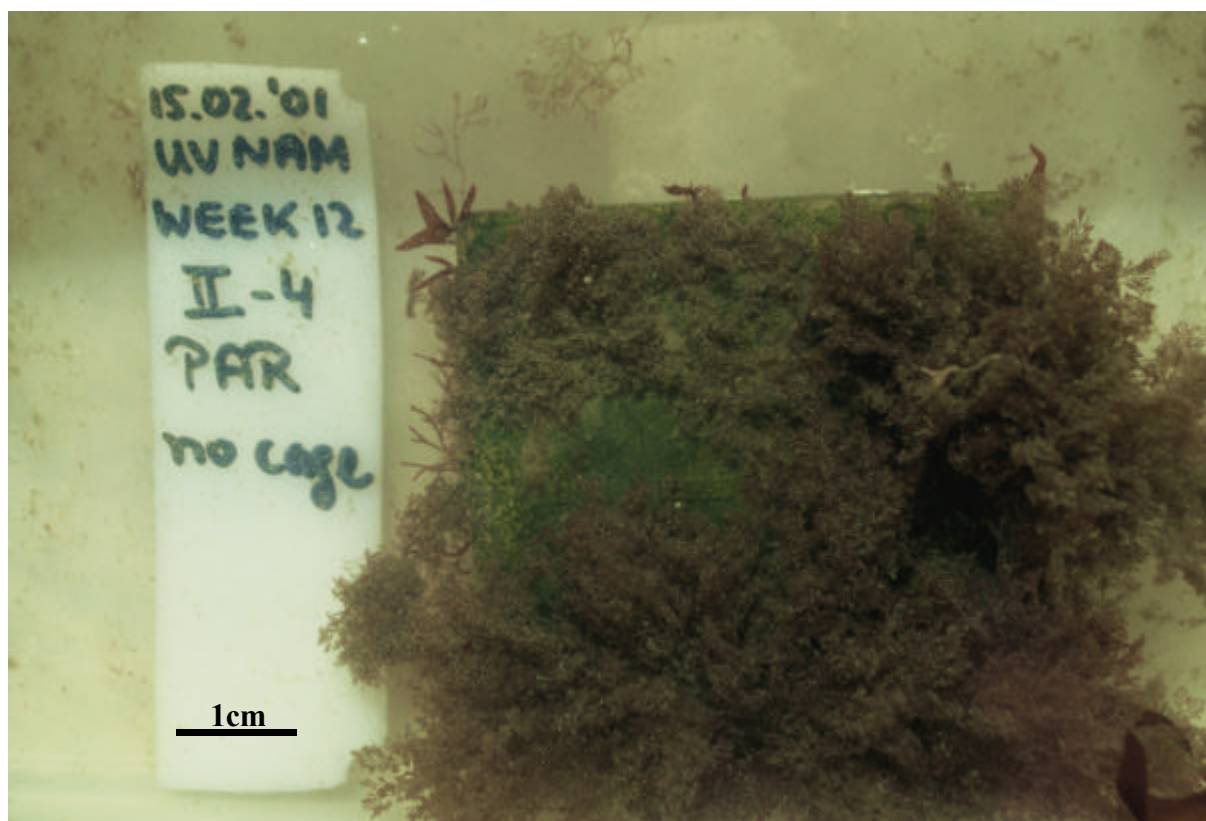

PHOTO 8: SE Atlantic site, UV stress experiment in 2000/01. Fouling assemblage under PAR treatment after 12 weeks. *Ceramium diaphanum*, *Codium fragile*, unidentified bryozoan and green alga film covered the plot.

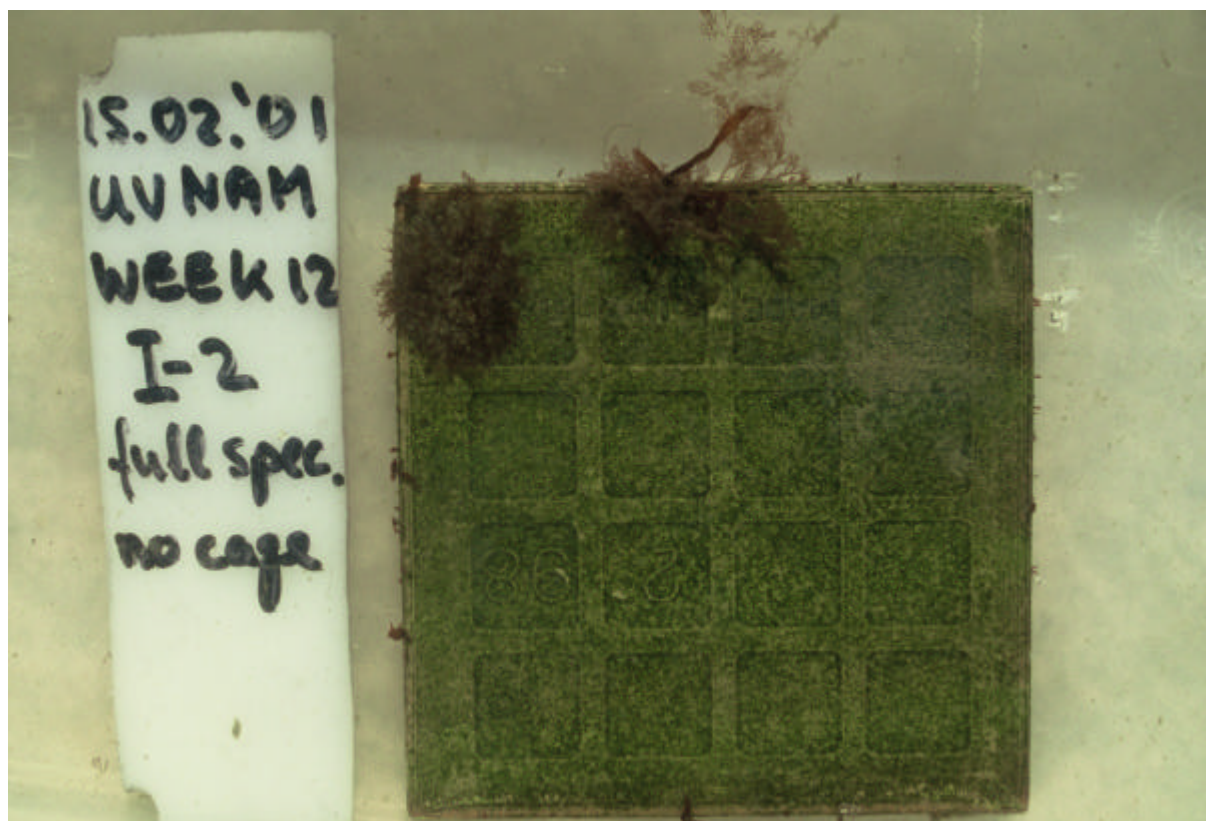

PHOTO 9: SE Atlantic site, UV stress experiment in 2000/01. Fouling assemblage under PAR+UVA+UVB treatment after 12 weeks. An unidentified green alga film covered almost exclusively the plot, together with the red alga *Ceramium diaphanum*.

## SUMMARY

To clarify the applicability of the “Intermediate Disturbance Hypothesis” (IDH) three questions were addressed - (1) Can unimodal patterns for a diversity response be generated along a disturbance gradient for fouling assemblages at the Kiel Fjord? Are responses reproducible (2) between years?, and (3) for different disturbance agents (emersion and enhanced ultraviolet B radiation)? Further, the ecological relevance of ultraviolet radiation (UV) was investigated by asking whether the structure of fouling assemblages from two sites with different ambient irradiance regimes is affected by (4) differential UV effects, and if yes (5) whether the structuring mechanisms of UV are comparable between both sites.

In recent years it became obvious that the conservation of diversity is of superior importance for the maintenance of the biosphere and hence of human society, too. To preserve diversity, more knowledge about its driving forces and processes that support diversity is necessary. The IDH may be helpful in that respect, because it postulates under which disturbance conditions diversity is maintained at high levels. However, past work on the IDH mainly from correlative, and observational studies which do not, in contrast to manipulative experiments, allow to relate cause and effect. The study of UV effects at the assemblage level was stressed in my thesis, first because of its global influence, which was and still is predicted to increase, for as long as stratospheric ozone levels will continue to decrease and second because of the discrepancy between a multitude of known detrimental UV effects at the organismal level, and the simultaneously limited number of UV studies at the assemblage level.

In a series of factorial field experiments on fouling assemblages I tested on one hand the assumptions of the IDH, using emersion and artificially enhanced UVB radiation as disturbance qualities, and on the other hand the impact of UV stress. Fouling assemblages seem to be useful study targets for manipulative experiments in the context of the IDH as well as UV stress, due to (i) the immobility of constituent species, (ii) constant availability of readily colonizing dispersal stages when resources are released, and (iii) strong competition for space as perhaps *the* limiting resource.

In my experiments, diversity  $H'$  showed a unimodal response for both disturbance qualities, but for evenness and species richness only along the emersion and enhanced UVB gradient, respectively. Response patterns along the emersion gradient were inconsistent, due to the inter-annual variability in growth and/or recruitment of the superior competitors, i.e. the blue mussel (*Mytilus edulis*) and barnacles (*Balanus* spp.). Within one year, the unimodal diversity pattern was for both disturbance qualities non-persistent, appearing only once at an early successional stage (70 days). In accordance to the original IDH concept, dominance of

competitive superior species reduced diversity left to its peak, i.e. benign conditions. By extending Connell's IDH model, I conclude that the reduction in diversity of emersion treatments right to its peak, i.e. harsh conditions, results from a shift in dominance to a second species group, i.e. algae, which seemed well adapted to that disturbance quality. As a result of this shift and the establishment of a new dominating group, evenness instead of the originally by the model suggested species number was reduced under harsh disturbance conditions. Enhanced UVB radiation generated a unimodal response for diversity at a time when emersion did not, suggesting different mechanisms between both disturbance qualities in producing the same pattern. The possible role of a green alga, the Green sea intestines (*Enteromorpha intestinalis*) was discussed in that respect. This pattern disappeared within the next three weeks for both disturbance qualities, as a result of a relatively stronger increase in species richness and evenness under the benign compared to the moderate emersion regime.

Ambient UV irradiance as a stress was of minor ecological impact, both at the SE Atlantic and Baltic Sea study site, irrespective of site-dependent differences in the intensity of solar irradiance levels. UVA radiation alone was without effect on fouling assemblage structure at both sites. Moreover, UV effects from both sites were non-persistent and restricted to the first two months of succession. Indirect UV effects on diversity parameters were found at both sites. Already ambient UV radiation lowered diversity  $H'$ , but not evenness and species richness, at the site of high natural irradiance levels (SE Atlantic), while enhanced UVB reduced diversity  $H'$ , species richness and evenness at the site of low natural irradiance. At the Baltic Sea study site, additional UVB enhanced indirectly the recruitment of the superior competitor *M. edulis*, resulting in a relative faster reduction of diversity on plots exposed to surplus UVB than plots exposed to ambient irradiance. In contrast, recruitment at the SE Atlantic site was more reduced on UV exposed than UV shielded plots, causing significantly lower diversity on PAR+UVA+UVB irradiated plots. During the subsequent three weeks, these differences in diversity between UV treatments disappeared, due an increase in canopy cover of a UV resistant *Ceramium* species and the protective shading underneath this canopy. Interactive effects between UV radiation and consumers were almost absent at both study sites and in addition, non-persistent for the rare occasions when they occurred.

My results suggest the applicability of the IDH, but the unimodal response for diversity was (i) modified by inter-annual variability in recruitment and/or growth of dominant species, (ii) non-persistent in succession, (iii) dependent on the chosen disturbance quality and (iv) diversity parameter. A non-persistent ecological relevance of UV stress was shown for two distinct fouling assemblages, grown under different natural irradiance regimes.

## ZUSAMMENFASSUNG

Zur Klärung für die Anwendbarkeit der „Intermediate Disturbance Hypothese“ (IDH) wurden drei Fragen gestellt – (1) Können unimodale Muster der Reaktion von Diversität entlang eines Störungsgradienten bei Aufwuchsgemeinschaften der Kieler Förde erzeugt werden? Ist dieser Kurvenverlauf (2) reproduzierbar zwischen Jahren? und (3) zwischen verschiedenen Störungsqualitäten (Trockenfallen und künstlich erhöhte Ultraviolet-B-Strahlung)? Weiterhin wurde die ökologische Bedeutung von ultravioletter Strahlung (UV) untersucht, indem gefragt wurde, ob (4) die Struktur von Aufwuchsgemeinschaften zweier Orte mit unterschiedlicher natürlicher UV-Strahlung durch unterschiedliche UV-Wirkungen beeinflusst wird und wenn ja, (5) ob die strukturierenden Mechanismen von UV-Strahlung zwischen den beiden Orten vergleichbar sind.

In der Vergangenheit wurde offensichtlich, dass der Erhalt von Diversität von entscheidender Bedeutung für den Fortbestand der Biosphäre wie auch der menschlichen Gesellschaft ist. Zum Erhalt von Diversität ist mehr Wissen notwendig, um diversitäts-förderliche Kräfte und Prozesse zu erfassen. Die IDH kann in diesem Zusammenhang hilfreich sein, da sie postuliert, unter welchen Bedingungen Störungen die Diversität auf hohem Niveau halten

n. Jedoch waren in der Vergangenheit durchgeführte Studien meist korrelativ und von beschreibender Art, wodurch, im Gegensatz zu manipulierenden Experimenten, keine Verbindung zwischen Ursache und Wirkung hergestellt werden konnte. Untersuchungen zur Wirkung von UV-Strahlung auf dem Niveau von Gemeinschaften wurden in dieser Arbeit betont, erstens wegen ihres globalen Einflusses, dessen Zunahme vorhergesagt wurde und noch immer wird, solange der Ozongehalt in der Stratosphäre weiter abnimmt und zweitens wegen der Diskrepanz zwischen einer Vielzahl an bekannten nachteiligen UV-Wirkungen auf der Ebene von Organismen und der gleichzeitig begrenzten Anzahl von UV-Studien auf Gemeinschaftsniveau.

In einer Reihe von Freilandexperimenten an Aufwuchsgemeinschaften untersuchte ich einerseits die Annahmen der IDH, wobei Trockenfallen und verstärkte UVB-Strahlung als Störungsqualitäten verwendet wurden, und andererseits die Einwirkung von UV-Stress. Aufwuchsgemeinschaften erscheinen als nützliche Studienobjekte im Zusammenhang mit manipulierenden Experimenten zur IDH wie auch bei UV-Stress, aufgrund (i) der Unbeweglichkeit ihrer Arten, (ii) der ständigen Verfügbarkeit siedlungsbereiter Verbreitungsstadien bei Ressourcenfreisetzung und (iii) einem starken Konkurrenzkampf um Raum, als *die* begrenzende Ressource.

In meinen Versuchen zeigte die Diversität  $H'$  eine unimodale Reaktion bei beiden Störungsqualitäten, jedoch für Evenness und Artenzahl entsprechend nur entlang des Trockenfall- und erhöhten UVB-Gradienten. Die Reaktionsmuster entlang des Trockenfallgradienten waren aufgrund von zwischenjähriger Variabilität in der Rekrutierung und/oder Wachstumsrate der überlegenen Wettbewerber, d.h. der Miesmuschel (*Mytilus edulis*) und Seepocken (*Balanus* spp.) uneinheitlich. Innerhalb eines Jahres blieb das unimodale Diversitätsmuster für beide Störungsqualitäten nicht dauerhaft und stellte sich lediglich zu einem Sukzessionsstadium (70 Tage) ein. Im Einklang mit dem ursprünglichen IDH-Konzept, reduzierte die Dominanz der überlegenen Wettbewerber die Diversität links von ihrem Spitzenwert, d.h. für erträgliche Bedingungen. Das IDH Modell von Connell erweiternd, erklärte ich die abnehmende Diversität rechts von ihrem Spitzenwert, d.h. für unwirtliche Bedingungen, durch eine Verschiebung in der Dominanz auf eine zweite Artengruppe, d.h. Algen, die als gut an die Störungsqualität angepasst erschienen. Als Folge der Verschiebung und Gründung einer neuen dominierenden Gruppe wurde die Evenness anstelle der wie ursprünglich im IDH Modell vermuteten Artenzahl unter harschen Störungsbedingungen reduziert. Erhöhte UVB Strahlung erzeugte eine unimodale Reaktion der Diversität zu einem Zeitpunkt, zu dem Trockenfallen dies nicht tat, was unterschiedliche Mechanismen bei beiden Störungsqualitäten für die Erzeugung des gleichen Musters vermuten lässt. Die mögliche Bedeutung einer Grünalge, dem Darmtang (*Enteromorpha intestinalis*) wurde diesbezüglich diskutiert. Das unimodale Muster verschwand innerhalb der nächsten drei Wochen bei beiden Störungsqualitäten r-keren Anstiegs in Artenzahl und Evenness im Vergleich zum mittleren Trockenfallregime.

Umgebungs-UV-Strahlung als Stress war sowohl am Versuchsort im SO Atlantik wie auch in der Ostsee von geringer ökologischer Einwirkung, unabhängig von den ortsabhängigen Unterschieden in der Intensität der Sonnenstrahlungsregime. UVA Strahlung alleine war ohne Wirkung auf die Struktur der Aufwuchsgemeinschaft an beiden Orten. Des Weiteren war die UV-Wirkung an beiden Orten nicht dauerhaft und beschränkt auf die ersten beiden Monate der Sukzession. Indirekte UV-Effekte auf die Diversität fanden sich an beiden Orten. Bereits Umgebungs-UV-Strahlung am Ort mit hoher natürlicher Einstrahlung (SO Atlantik) erniedrigte die Diversität  $H'$ , aber nicht Evenness und Artenzahl, während erhöhte UVB Strahlung am Ort mit geringer natürlicher Einstrahlung (Ostsee) eine Abnahme von Diversität  $H'$ , Evenness und Artenzahl verursachte. Am Versuchsort in der Ostsee verstärkte die zusätzliche UVB Strahlung indirekt die Rekrutierung von Miesmuscheln, der wettbewerbsstärksten Art. Daraus resultierte eine relativ schnellere Abnahme der Diversität auf den mit zusätzlicher UVB Strahlung exponierten Versuchsfächen im Vergleich zu Versuchsfächen, die der um-

gebenden Bestrahlung ausgesetzt waren. Im Gegensatz dazu war die Reduktion in der Rekrutierung bei Arten am Versuchsort im SO Atlantik auf jenen Versuchsfächen stärker, die einer UV-Strahlung ausgesetzt waren als auf UV-geschützten Flächen. Eine signifikante Abnahme in der Diversität auf PAR+UVA+UVB bestrahlten Versuchsfächen war die Folge. In den nachfolgenden drei Wochen verschwanden am Versuchsort im SO Atlantik die Diversitätsunterschiede zwischen den UV-Behandlungen als Folge der zunehmenden prozentualen Bedeckung einer UV-resistenten *Ceramium*-Art, die durch ihr Algengeflecht eine UV-schützende Wirkung auf das darunter befindliche Substrat hatte. Interaktionen zwischen Bestrahlung und Konsumenten fehlten fast gänzlich, und waren zusätzlich dort, wo sie vorkamen, nicht dauerhaft.

Meine Ergebnisse lassen die Anwendbarkeit der IDH im untersuchten System vermuten. Jedoch wurde die unimodale Reaktion der Diversität modifiziert durch (i) die Variabilität zwischen einzelnen Jahren bei der Rekrutierung und/oder den Wuchsraten dominanter Arten, (ii) den Zeitpunkt der Sukzession, (iii) die gewählte Störungsqualität und (iv) den gewählten Diversitätsparameter. Für UV-Stress wurde eine nicht dauerhafte ökologische Relevanz für die beiden Aufwuchsgemeinschaften gezeigt, die in verschiedenen natürlichen Bestrahlungsregimen aufwuchsen.



## 1. GENERAL INTRODUCTION

The Rio Convention on biological diversity represents, at least in principle, an international attempt for the conservation and sustainable use of nature, based on the concept of biological diversity (Boyle 1996). It was motivated by the apparent decline in biodiversity over the past decades. Recent extinction rates are 100 –1000 times faster than pre-human rates extrapolated from fossil records (Pimm 1995, Edwards & Abivardi 1998). For instance, tropical rain forests loose 2 – 5 species hourly due to the destruction and fragmentation of habitat (Hughes et al. 1997). Nevertheless, factors other than habitat loss can result in declining diversity of particular taxa, e.g. ultraviolet-B radiation (UVB) strongly affects amphibians (Kiesecker et al. 2001). One of the major challenges for ecologists will be to find out whether species loss affects the viability of ecosystems and alter their services, e.g. the supply of resources.

Four major hypotheses on the functional role of species diversity in ecosystems were developed. First, the *diversity-stability hypothesis* (McArthur 1955), predicts that ecological assemblages will increase in productivity and the ability to recover from disturbance as the number of species increases. Thus all species are important for ecosystem performance. Second, the *rivet hypothesis* (Ehrlich & Ehrlich 1991) assumes a non-linear relationship between species richness and ecosystem function. Because some species are redundant, a limited number of extinctions will go unnoticed in terms of system performance, before ecosystem function will be impaired. Third, the *insurance* or *redundancy hypothesis* (Walker 1992) expands the rivet hypothesis by the segregation of species into functional groups. Loss by one of several species affiliated to the same functional group is of little consequence for ecosystem performance relative to a lost species without functional analogs. Thus, the insurance hypothesis is a refinement of the rivet hypothesis, confining which rivets are likely to be expendable. Fourth, the *idiosyncratic hypothesis* (Lawton 1994) proposes the importance of all species for ecosystem processes. Here not species richness per se matters, rather species quality, with some species being more important than others.

Of the four concepts, the insurance hypothesis is strongly supported by the model of Yachi & Loreau (1999) who found two major insurance effects of species richness on ecosystem productivity; first, a buffering effect reducing temporal variance of productivity, and second, a performance-enhancing effect increasing the temporal mean of productivity with species richness. The existence of asynchronicity of species responses against a fluctuating environment, the degree of asynchronicity and the detailed forms of species responses will determine the strength of the two insurance effects.



Furthermore, experimental evidence, coming mainly from terrestrial systems, suggests a gradually slower increase in productivity (Naeem et al. 1994, Tilman et al. 1996), reliability (Naeem & Li 1997) and stability (Tilman & Downing 1994) of plant assemblages with increasing species richness. In marine environments, a strong decrease in variability of ecosystem processes occurred when more than ~ 8 species were present in artificial, multi-trophic assemblages of bacteria and protists (McGrady-Steed et al. 1997). Yet there is also evidence for rejecting the view that improvement of ecosystem processes depends on higher species richness (Wardle et al. 1997, McGrady-Steed & Morin 2000). Thus, biodiversity has the potential to improve persistence and services of at least certain ecosystems (sensu Ehrlich & Wilson 1991, Soulé 1991) and survival of society (Edwards & Abivardi 1998). Understanding influential processes on diversity is obviously of theoretical and applied relevance.

Past explanations for diversity patterns were based on intrinsic assemblage interactions, and competitive exclusion (Huston 1979). Species succession was sought to follow a rigid sequence, in which, as a first step, early colonizers facilitate, tolerate or inhibit recruitment of later arrivals (Connell & Slatyer 1977). Subsequently competitive exclusion would drive assemblages to an endpoint. At this climax state an equilibrium with no further change in competitive rates adjusts. The theoretical background of the climax theory is given by Lotka-Volterra models, regarding the competitive outcome between two species competing for the same resource under different resource conditions (Lotka 1925, Volterra 1926). In laboratory experiments Gause (1935) confirmed the predictions of the Lotka-Volterra equations. Competition for the same resource drove the competitive inferior *Paramecium* species to extinction, whilst coexistence occurred if resource overlap was avoided. According to the “*niche diversification hypothesis*”, diversity under equilibrium conditions will be determined by (a) the number of exploitable resources and (b) the realized degree of specialization to which species differentiate along the various niche axes (Connell 1978). At least two further concepts postulated the maintenance of diversity under equilibrium conditions – in the “*circular networks hypotheses*”, mutual influences between species restrict any species to be the superior competitor and the “*compensatory mortality hypothesis*” predicts that highest mortality through predation or disturbance falls on the most abundant species (Connell 1978). Nevertheless, Hutchinson (1961) observed a far greater number of plankton species than could be expected from equilibrium models – the “Paradox of the Plankton”. This paradox could be explained by the variability of resources in either space or time or both (Richerson et al. 1970). The “*gradual change hypothesis*”

(Hutchinson 1961) advocated that such environmental changes alter the ranking of competitive dominants due to changes in system properties. The “*environmental heterogeneity hypothesis*” was an additional concept stressing non-equilibrium conditions. However, habitat heterogeneity may occasionally depend on species which create spatial heterogeneity, e.g. trees or limestone skeletons of corals. Habitat heterogeneity may explain some diversity patterns, but because it is an intrinsic part of diversity, it will not help to explain diversity patterns of entire ecosystems (Huston 1979). Paine (1966) introduced the “*predation hypothesis*” as an alternative explanation of the maintenance of diversity for a non-equilibrium situation. Instead of a variable abiotic environment, predation on competitive dominant species could inhibit monopolization of limiting resources. The “*dynamic equilibrium model*” (Huston 1979) represents a synthesis of several hypothesis, assuming that competition, predation and productivity of a system control for its diversity by keeping assemblages away from an equilibrium state. In his model, Huston (1979) predicts that low productivity may prolong the period before competitive exclusion occurs, reducing the frequency of population reduction.

Perhaps the most widespread concept of diversity maintenance under non-equilibrium conditions is the “*Intermediate disturbance hypothesis*” (IDH). Though Connell (1978) was the first to use this name for a unimodal pattern of diversity along a disturbance gradient, hump-backed curves had been postulated earlier, e.g. for species density along a disturbance gradient (Grime 1973a).

The conceptual ideas behind the IDH are quite straightforward. Under harsh conditions the number of tolerant species is supposed to decline, whereas in benign environments, competition will exclude the competitively subdominant species over time and become the most important process to control for coexistence of species. Species richness is expected to peak at moderate levels of disturbance.

Work during the past 25 years has reshaped the original IDH concept. First, several amendments to the IDH were suggested with regard to heterogeneity (Levin & Paine 1974), productivity (Huston 1979, Kondoh 2001), recruitment (Menge & Sutherland 1987) and multitrophicity (Wootton 1998). Accordingly, any response pattern of assemblage diversity to increasing disturbance between a monotonous in- and decline is possible depending on superimposed gradients of e.g. productivity. Second, a proper definition of disturbance from the jungle of existing terms is crucial (see White & Pickett 1985). Confusion about the definitions of disturbance and stress is widespread. One of the clearest discriminations was given by Grime (1977), defining stress as an external limitation of production rates, e.g. light for autotrophs, and disturbance as destruction of biomass following e.g. consumption. In a broader sense, Pickett et al. (1989) developed an ecological con-

cept of disturbance, which I adopt in this thesis. According to their framework, ecological levels, i.e. individuals, assemblages or ecosystems, are built up of entities, i.e. units of ecological interest. The interaction of entities represents a minimal structure which allows persistence of the ecologically higher level they constitute. Any external factor that changes this minimal structure will result in a disturbance at the higher level. For instance, heat  $>42^{\circ}\text{C}$  is known to destroy most enzymes (= entity) affecting growth of an individual (the next higher ecological level) and thus represents a disturbance at that level. If e.g. the competitive abilities of the individual (now treated as an entity) were altered due to the effects on growth, heat will also be a disturbance at the next higher level (= assemblage).

Anthropogenic changes in biotic and abiotic factors during the last three decades (Ehrlich & Wilson 1991, Soulé 1991, Ehrlich & Ehrlich 1992) may affect species survival directly or indirectly if these factors can act as disturbance agents, i.e. in an IDH model. The effects on benthic assemblage structure and diversity of two presumptive disturbance qualities, UV radiation and desiccation, will be considered in this thesis. As detailed below, UV radiation increases due to ozone loss, emersion will become more common in shallow water habitats of the Baltic Sea due to an increasingly storm climate (seiches). Coastal ecosystems are of particular interest because of their ecological and economical importance, e.g. as recreational areas and fish nurseries. For instance, Costanza et al. (1997) rank their monetary value highest compared to other biomes.

UV radiation is a potential lethal component of ambient irradiance and thus unavoidable by primary producers. At present, solar UVB at the earth's surface ( $<320\text{nm}$ ) increased yearly between by 1.5% (at 300nm) and 0.8% (at 305nm), while UVA remained unchanged (WMO 1998). During the past decade, a negative correlation between stratospheric ozone concentration and UVB has been confirmed by numerous ground-based measurements (Blumthaler & Ambach 1990, Seckmeyer & McKenzie 1992, Kerr & McElroy 1993). Current evidence suggests that it will take at least until 2010 before a reduction of UVB trends will become measurable (WMO 1998, Shindell et al. 1998, Claude & Köhler 1999). To date, the UVB regime outside the tropics is high compared to pre-1970 levels and its rate of further increase might be too fast to allow organisms to adapt.

Changes in the UVB regime will not affect terrestrial organisms alone. Jerlov (1950) reported of attenuation coefficients for UVA and UVB in the East Mediterranean Sea of 0.05 and 0.15, respectively, allowing UV to penetrate as far down as 20m. The principle factor affecting the UV regime in coastal and freshwater ecosystems is the concentration of dissolved organic carbon (DOC) (Häder et al. 1998, Williamson et al. 1999). For instance, UV penetration in the shallow lagoons of

the Bodden Sea (Baltic Sea) varied by up to two orders of magnitude, with changing concentration of gelbstoff (Piazena & Häder 1994). Lowered DOC levels were linked to climate warming and acid deposition, increasing the depth of the 1% UVB isopleth by >400%, affecting exposure of aquatic organisms to UVB substantially more than stratospheric ozone depletion (Schindler et al. 1996). Thus, biological harmful UVB exposure may continue to be a global challenge beyond the year 2010, at least for many shallow-water organisms.

An increasingly stormy climate will enhance mechanical damage on shallow water systems, e.g. coral reefs (Bythell et al. 2000, Acosta et al. 2001) and presumably render wind driven events more frequent or more intense. A multitude of intertidal ecology studies gives a detailed picture about the overall detrimental effects of, and adaptations to, emersion for aquatic sessile organisms (e.g. Raffaelli & Hawkins 1996, Ellington & McMahon 1998).

In consideration of the generally harmful effects of the expected global climate change on ecosystems (Häder et al. 1998, contributions in Lozãn et al. 1998), the IDH is of particular interest, because of its predicted enhancing effect of moderate disturbance on species diversity. The fouling assemblage from my study site at the Western Baltic Sea represents an ideal system for testing the effects of UV radiation and wind-induced water level change in that context, because (1) ozone related increases in UV radiation will be higher in mid- and high-latitudes than in the tropics (Wängberg et al. 1996) and (2) wind-driven seiches are typically for enclosed seas like the Baltic Sea (Dietrich et al. 1975).

Despite the many models trying to explain the IDH, a limited number tested it under natural conditions (e.g. Flöder & Sommer 1999, McCabe & Gotelli 2000). Most field work were correlative, observational studies (for details see review by Mackey & Currie 2001). A mere correlation between diversity and disturbance may be caused by other covarying factors. Results from more powerful manipulative experiments are few and come mainly from lotic systems (e.g. Reice 1985, Doeg et al. 1989, Lake et al. 1989) and mesocosm experiments (e.g. Gaedeke & Sommer 1986, Sommer 1995). Less than 15% of reviewed studies, reported a peaked relationship between diversity and disturbance, suggesting that hunchbacked curves are the exception and not the rule in real assemblages (Mackey & Currie 2001).

To date, marine fouling assemblages were not used to test the IDH in manipulative field experiments, though they offer a great potential to do so, because sessile constituents – common in marine benthos - can not escape a disturbance. Indeed, fouling assemblages possess all prerequisites

to appropriately test the IDH, as summarized by Fuentes & Jaksic (1988): (1) propagules from a large species pool and (2) strong interspecific competition.

Further wanting are repetitive studies to test whether assemblage responses vary in time and studies testing more than one disturbance agent simultaneously. To fill this gap two field experiments were conducted to answer the following questions:

(1) Does the fouling assemblage of Kiel Bight, Western Baltic Sea, show a unimodal response for diversity along a disturbance gradient, i.e. emersion?

If yes, is this response reproducible

(2) in different years?

(3) for different disturbance agents (emersion vs. enhanced UVB)?

Experiments assessing UV effects on assemblage structure are scarce in spite of proposed strong effects for terrestrial (Caldwell et al. 1989) and aquatic systems (Häder 1989, Cullen & Neale 1994). To relate the results from the IDH experiment using enhanced UVB as a disturbance agent to the effects of ambient UV stress on assemblage structure and diversity, an additional experiment was conducted. Finally, the effects of enhanced UVB irradiance on assemblage structure from the naturally low UV environment of Kiel Bight were compared to similar high, but ambient UVB levels from the naturally high UV environment in Namibia (Southern Africa). The intention of both additional experiments was to elicit whether

(4) enhanced UVB or ambient UV effects affect assemblage structure and diversity in a low UV environment.

And in case UV effects are detected, whether

(5) the structuring mechanisms of UV are comparable between assemblages from a low and a high UV environment.

## 2. STUDY SITES

To test the separate effects of emersion and UV radiation (UV) as different disturbance qualities on fouling assemblages, I conducted a series of field experiments at the Baltic Sea. As a result of tides, a narrow strip of benthos is daily exposed to the air. Here exist presumably favourable conditions for species which can cope with the consequences of emersion, e.g. the green alga *Enteromorpha intestinalis*, which was observed highest on the rocky shore at the study site. Moreover, wind-induced changes in water level (= seiches) expand irregularly emersion periods to a broader extend, i.e. up to 12h (Dietrich et al. 1975). Thus benthic assemblages experience a wide range of emersion periods.

UV was chosen as a second disturbance agent (Baltic Sea) as well as a stress factor (Baltic Sea and SE Atlantic), because of the demonstrated UV sensitivity of many fouling taxa at both sites, e.g. diatoms (Rader & Belish 1997), the green alga *E. intestinalis* (Cordi et al. 2001, for review on alga Franklin & Forster 1997) and mussel veligers (Chalker-Scott et al. 1994). Both sites were comparable in most factors (water temperature, water transparency for PAR, productivity, species

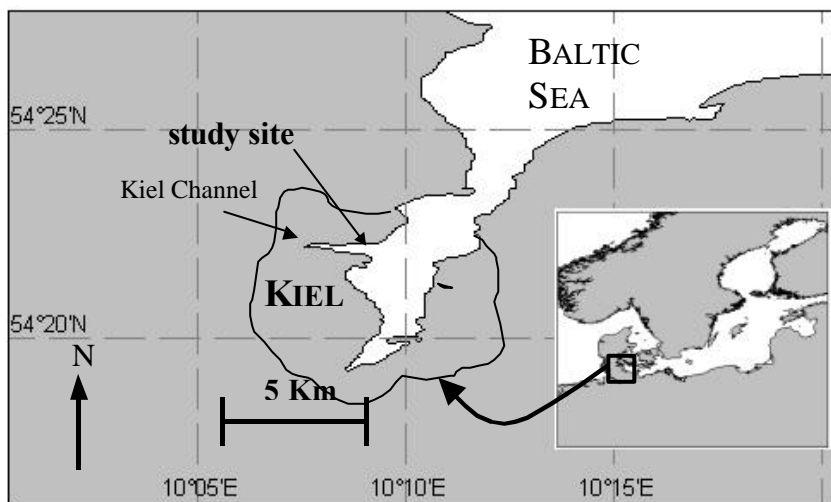

Fig. 2-1: Inlet shows geographic location of the Baltic Sea and Germany. The enlarged area is an image of the Kiel Fjord.

richness), but a marked difference in their UV regime both, above and below the water surface. According to the predictions of a numeric model (Mann & Lazier 1991, pp83) shallow parts of the ocean (<10m) are permanently well mixed, guaranteeing spores and larvae from deeper, UV free zones (>1m at both sites) to have an equal chance to

reach experimental plots, compared to species from UV exposed zones (<1m). Thus recruits advected to the plots stem from UV exposed and UV sheltered sites and can not automatically be regarded as UV adapted.

## 2.1. BALTIC SEA (EMERSION & UV)

Overall, 4 experiments were performed, split into one pair of emersion experiments a) from 07.08. - 07.11.98, b) from 28.04. - 29.10.00, and one pair of UV-experiments c) from 29.05. - 06.10.00 d) from 12.06. - 04.10.01.

The Baltic Sea study site (Fig. 2-1), representing the low UV regime, was located in a small

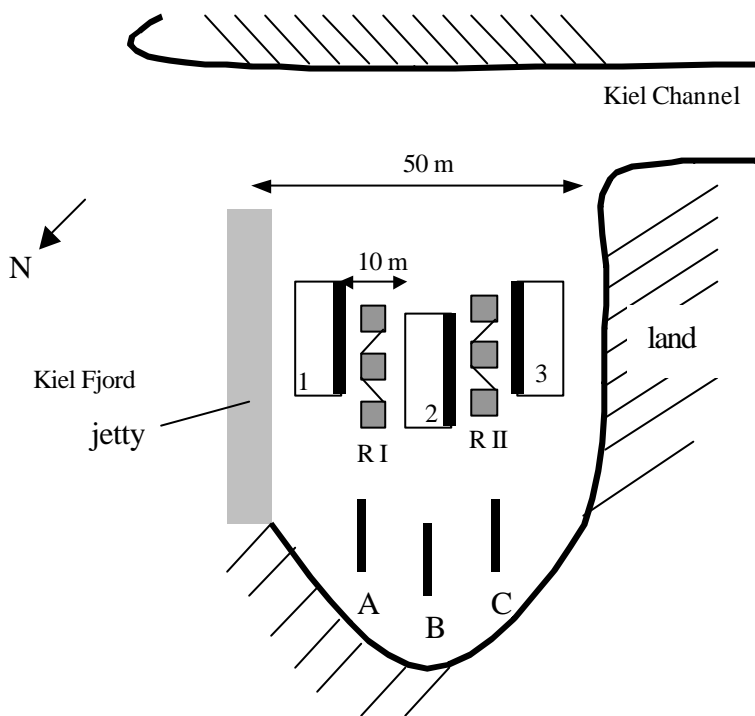

Fig. 2-2: Schematic outline of spatial arrangements of experiments at the Schleuseninsel Bay. Black bars along the side of wooden platforms (=1-3) indicate position of lamp blocks in 2000 and 2001. Opposite sides were used for emersion blocks. A, B, and C mark location of control blocks in 2000. Grey quadrates symbolise single blocks of UV experiments in 2001, arranged in two rows (RI and RII).

(WSA Lübeck).

bay (250m<sup>2</sup>) of the Schleuseninsel at the mouth of the Kiel Channel, Kiel Fjord, Germany (54°23'N; 10°09'E). Average precipitation, humidity, water salinity, air and water temperature for the duration of the experiments are compiled in Table 2-1 and illustrated in Fig. 2-3. Average water depth in the bay is 5m. Experiments were positioned throughout most of the bay (Fig. 2-2, Photo 1). Tidal range at the study site was small (<10cm). However wind-driven, oscillating changes in water level (= seiches) were observed once in 1998 and twice in 2000 and 2001, reaching a maximum amplitude of 1.8m with 12h frequency for 2-3 days

The bottom of the bay is composed of muddy sands. Small (0.1m<sup>3</sup>) boulders, fringing the shallow parts (<1m) of the bay, were colonized at their tops by the perennial bladder wrack (*Fucus vesiculosus*) and the annual green alga *E. intestinalis*. Blue mussels (*Mytilus edulis*, hereafter “mussels”) dominated this benthic assemblage in abundance and biomass, followed by barnacles (almost

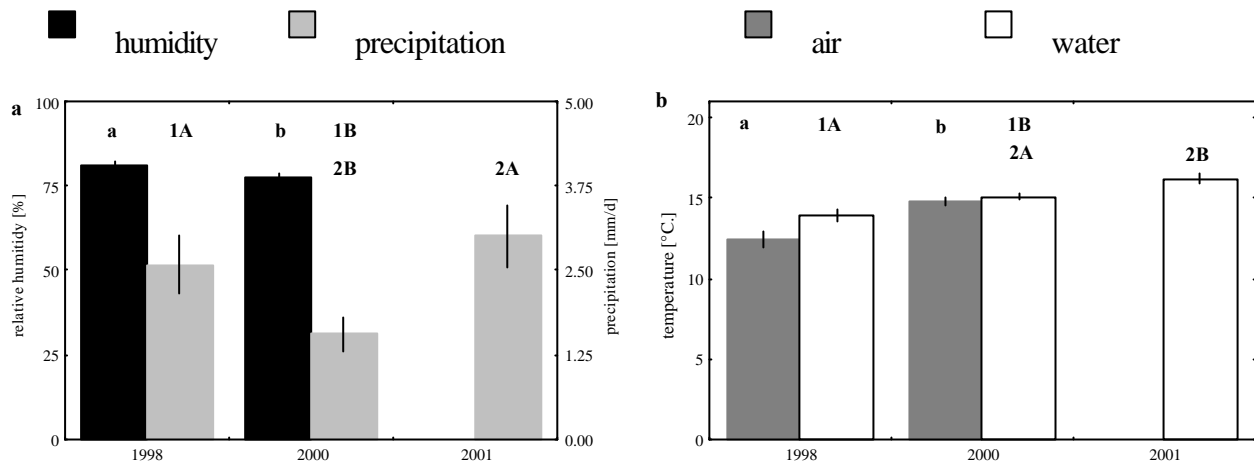

Fig. 2-3: Abiotic conditions from the Baltic Sea site between years for (a) mean  $\pm$ SE precipitation and relative humidity and (b) mean  $\pm$ SE air and water temperature. Number, capital and lower case letters at top of graphs indicate differences between years: years sharing a letter are not significantly different. Numbers before the letter group compared pairs, because precipitation and water temperature in 2000 were used in two separate t-tests.

exclusively *Balanus improvisus*). Closed mussel beds with individuals larger 5cm, i.e. beyond the prey spectrum of major benthic mussel consumers (Enderlein 2000), extended from the shoreline to a depth of approx. 2m. Below that depth, mussel patches of an estimated average area of 1m<sup>2</sup> were found. Mussel spat fall shows generally a strong seasonal peak from late June to the end of August (Dürr 1998). Barnacles were found preferably on top of boulders and in a band near the water surface. Fouling species recruiting with a minimum average cover of >1% during the experiments on

Table 2-1: Daily mean  $\pm$ SD precipitation [mm/d], relative humidity [%], salinity, water temperature [°C] and air temperature [°C] at the Baltic Sea study site for the space of time when experiments were conducted and results of t-tests between these periods. Degrees of freedom as subscript in t-value column.

source	1998	1998 vs. 2000		2000	2000 vs. 2001		2001
		t <sub>146</sub>	p		t <sub>146</sub>	p	
precipitation	2.6 ( $\pm$ 4.6)	0.75	<0.05	1.6 ( $\pm$ 3.3)	2.01	<0.01	3.1 ( $\pm$ 5.4)
humidity	81.2 ( $\pm$ 9.0)	2.20	<0.05	77.7 ( $\pm$ 9.4)	2.50	<0.05	81.2 ( $\pm$ 8.8)
salinity	no data			16.4 ( $\pm$ 1.0)	0.98	n.s.	16.2 ( $\pm$ 0.9)
water temp.	14.0 ( $\pm$ 2.9)	2.99	<0.01	15.1 ( $\pm$ 1.8)	3.33	<0.01	16.2 ( $\pm$ 2.3)
air temp.	12.4 ( $\pm$ 4.1)	4.17	<0.01	14.8 ( $\pm$ 2.9)	0.99	n.s.	15.3 ( $\pm$ 3.2)

plots are listed in the “Results”- section of the respective chapter. At the study site, but not on the plots, the shore crab (*Carcinus maenas*) and the common sea star (*Asterias rubens*) are the major benthic consumers, preying preferably on mussels. Outside the experimental plots, abundance of snails of the genus *Littorina* was ca. 20 individuals/m<sup>2</sup>. On the plots, the isopod *Idotea baltica* (>2



individuals/plot), two snail species *Hydrobia ulvae* and *Facelina auriculata* (<1 individual/plot) and amphipods (approx. 50 individuals/plot) were found. Gohse (1999) identified 4 gammarid species at the study site, *Gammarus zaddachi*, *G. salinus*, *G. duebeni* and *G. locusta*, which I lumped into one group (=gammarids) (see chapter 7). Two fish species, sticklebacks (*Gasterosteus aculeatus* L.) and the two-spot gobys (*Coryphopterus flavescens* Fabricius) together with rats were occasionally seen in the bay, but I observed no sign of predation on the plots. Sea gulls, though present at the site in high numbers, hardly effected assemblages, as a net over entire blocks in both emersion and UV experiments prevented seagull predation effectively without reducing irradiance levels (per. measurements).

## 2.2. SE ATLANTIC (UV ONLY)

The SE Atlantic study site (Fig. 2-4), representing the high UV regime, was located in the naturally sheltered Radford Bay (ca. 10ha) inside Lüderitz Harbour, Namibia ( $26^{\circ} 40' S$ ;  $15^{\circ} 09' E$ ). I choose this site because (1) it was the only inlet along the notoriously exposed Namibian coast, (2) Lüderitz has a long record of oceanographic and meteorological observations and (3) a mooring system from an oyster farm could be used to anchor the experiment securely.

Water temperature averaged for the period of experiments at  $13.9^{\circ} C (\pm 0.9)$  (K. Noli, Ministry of Fisheries, Namibia, per. com.). No salinity data exist. The maximum water depth in the bay is 2m at low tide (Molloy 1992). Tides are semi-diurnal and never exceeded 1.5m during the experi-

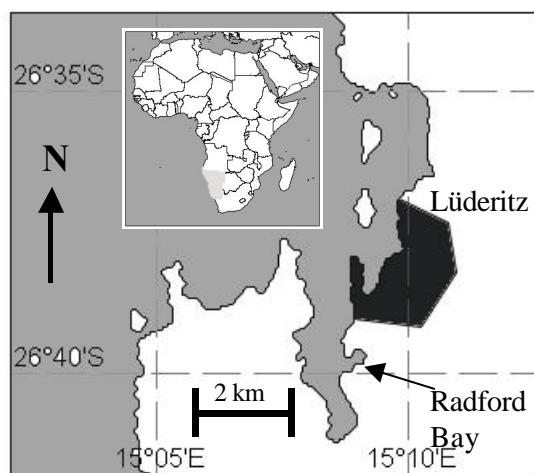

Fig. 2-4: Geographic location of study site Radford Bay. Namibia is highlighted in grey colour on the Africa map.

ment (South African Tide Tables. Hydrographer, South African Navy, Tokai, Cape Town). Strong south-westerly winds (mean  $219^{\circ}$ ) prevailed during the experiment with a mean daily wind velocity of  $8.23\text{ms}^{-1} (\pm 4.22\text{ms}^{-1} \text{SD})$  (K. Noli, Ministry of Fisheries, Namibia, per. com.), resulting in strong upwelling for the time of the experiment (23.11.00 - 16.02.01). Upwelling ensured high levels of productivity, making Lüderitz in this respect relatively comparable to the Baltic Sea site. Moreover, upwelling caused turbid waters, with effects on UV attenuation (Fig 3-3b).

The entire sea floor in the bay is covered by fine sediment ( $<106\mu\text{m}$ ). For thorough description of Lüderitz Harbour benthos see Molloy (1992). Colonization pressure, especially by algae seems to be intense, covering new substratum within a few weeks (D. Harvey, per. com.). The abundance and distribution of the benthic subtidal flora was mapped once, reporting approx. 15 species for Radford Bay (Molloy 1992). According to this survey, the dominant species at Radford Bay is the red alga *Gracilaria gracilis*. However, it did not recruit on plots, because it reproduces vegetatively. Substantially lower in abundance and biomass than *G. gracilis* is the red alga *Ceramium* spp., followed by the green algae *Ulva capensis* (F. Molloy, per. com.). The subtidal sessile fauna features few species ( $<25$ ) but high biomass (B. Currie, NatMIRC Swakopmund per. com. and per. observation). Two species of epibenthic Isopods were encountered: *Paridotea rubra* (up to 55mm in length) and *Idotea metallica* (up to 30mm in length). *P. rubra* was more abundant at the beginning of the experiment ( $<63\text{d}$ ). In contrast, no variation in the density of *I. metallica* was observed during the experiment.

The only human activity in the bay was an oyster farm. Without extra feeding, oysters grow within 7 months to marketable size (D. Harvey, per. com.), an effect of the exceptionally rich phytoplankton.



### 3. AMBIENT IRRADIANCE REGIMES

#### 3.1 BALTIC SEA

Measurements were performed in 2000 and 2001. A calibration with irradiance data from Westerland/Sylt, Germany, a site of comparable latitude, ensured data quality in 2001 (see “*Material and methods, Chapter 6*” for details). Ambient PAR, UVA and UVB levels were consistently, but not significantly different between 2000 and 2001 (Table A-1, appendix), neither for single months (Fig. 3-1a-c, Table A-2, appendix), nor for the entire study period (Fig. 3-3a).

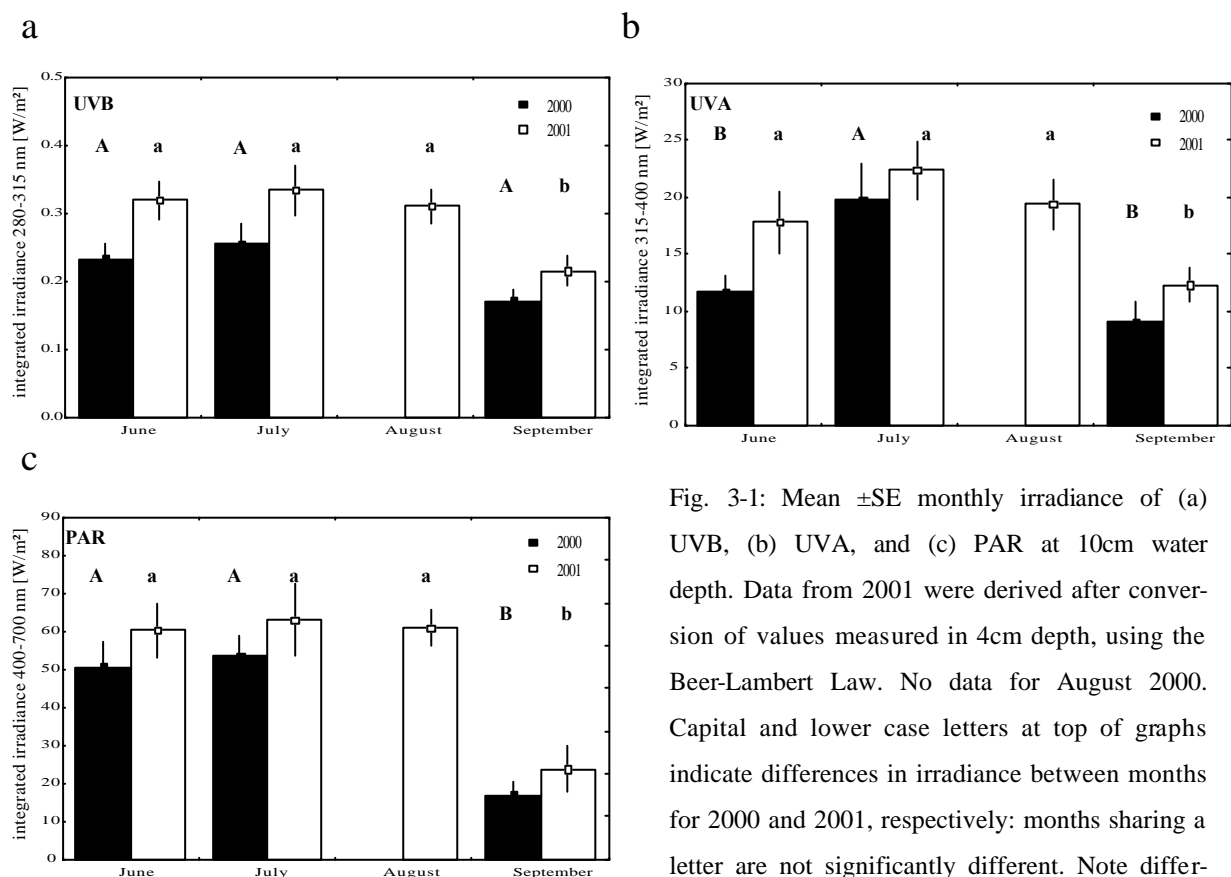

Fig. 3-1: Mean  $\pm$ SE monthly irradiance of (a) UVB, (b) UVA, and (c) PAR at 10cm water depth. Data from 2001 were derived after conversion of values measured in 4cm depth, using the Beer-Lambert Law. No data for August 2000. Capital and lower case letters at top of graphs indicate differences in irradiance between months for 2000 and 2001, respectively: months sharing a letter are not significantly different. Note differently scaling.

The vertical attenuation coefficient ( $K_d$ ) was determined according to the procedure outlined in “*Material and Methods, chapter 6*”. Low values correspond to high water transparency. Water transparency was lowest for UVB and highest for PAR at the Baltic Sea site in 2001 (1-ANOVA,  $F_{2,287} = 658.9$   $p < 0.01$ ). When averaged over the entire study period, the  $K_d$  value for UVB was 1.6 and 5.4 times higher compared to UVA and PAR, respectively. The average  $K_d$  value for UVA was 3.4 times higher compared to PAR (Fig. 3-3b).  $K_d$  values showed a significant seasonality for UVB and PAR, but not for UVA (Table A3, appendix).

Compared to June,  $K_d$  values for UVB were higher in July, August and September.  $K_d$  values for PAR peaked in August (Fig. 3-2).

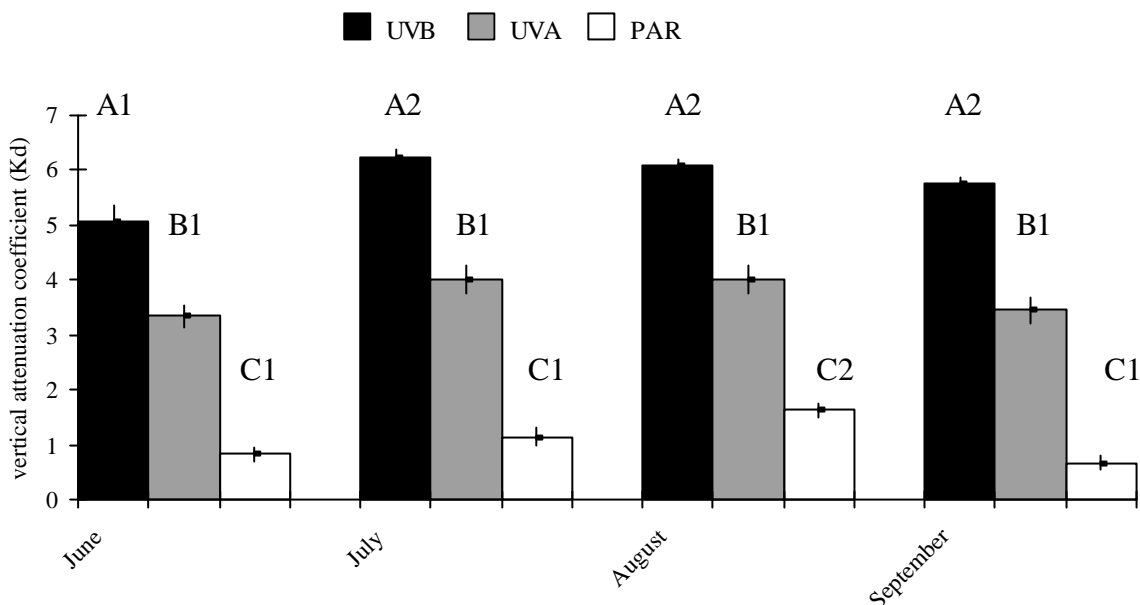

Fig. 32: Mean  $\pm$ SE vertical attenuation coefficient ( $K_d$ ) for the UVB, UVA and PAR wavebands in 2001 for single months during the experimental period. Letter-number combination at top of graphs indicate differences in  $K_d$ -values among months, where letters code the wavebands: months sharing a number are not significantly different.

### 3.2 SE ATLANTIC

Due to logistical and technical problems, very few measurements ( $n = 8$ ; approx. 10% of study period) were obtained to characterize the irradiance regime at Radford Bay. However, blue skies prevailed for more than 98% throughout the experiment (K. Noli, per. com.), suggesting that the limited number of measurements was still representative for the entire study period, concerning the above surface irradiance regime. Clouds and fog banks reduced UVA and PAR equally strong by 19% (per. measurement), and were considered of negligible overall influence. Moreover, TOMS satellite data confirmed for erythemal weighted UVB ([http://toms.gsfc.nasa.gov/ery\\_uv/euv.html](http://toms.gsfc.nasa.gov/ery_uv/euv.html)) constantly highest irradiance levels in the range of 7.2 – 8.4 KJ/m<sup>2</sup>, i.e. the utmost recorded TOMS category, over Namibia throughout the time of the experiment.

Compared to the Baltic Sea, the SE Atlantic site shows significant higher overall UVB levels (1-ANOVA,  $F_{2,99} = 12.43$   $p < 0.01$ ), but similar UVA and PAR regimes. (Fig. 3-3a). On average, water transparency was twice as high at the SE Atlantic site compared to the Baltic Sea (Fig. 3-3b). This difference was significant for UVB (t-test,  $t_{57} = 3.92$   $p < 0.01$ ) and UVA (t-test,  $t_{59} = 4.70$   $p < 0.01$ ), but not for PAR.

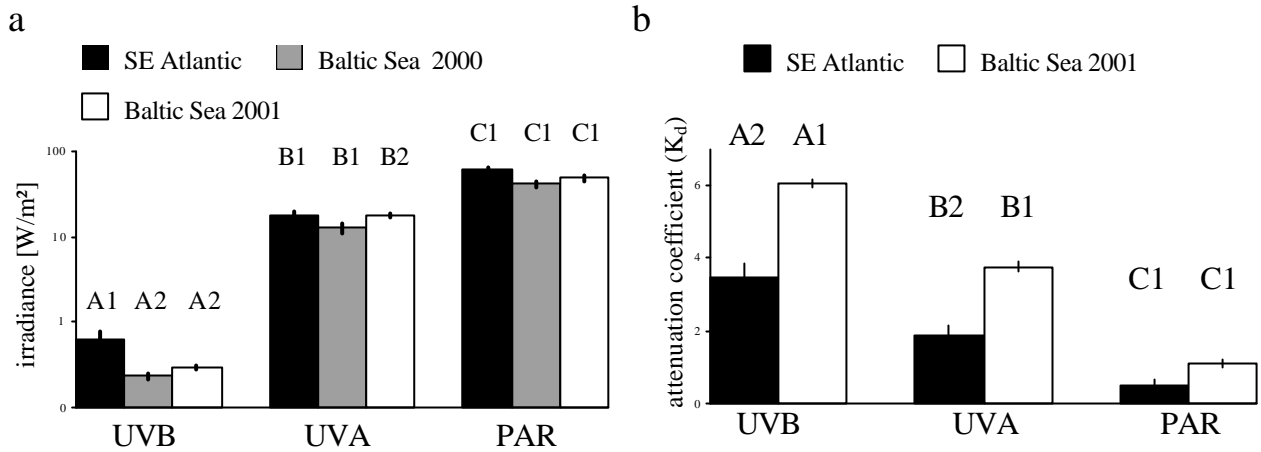

Fig. 33: (a) Mean  $\pm$ SE integrated irradiance of UVB (280-315nm), UVA (315-400nm) and PAR (400-700nm) in 10cm depth at SE Atlantic in 2001, and Baltic Sea in 2000 and 2001 for the entire study period. Data for SE Atlantic and Baltic Sea in 2001 were derived after conversion of values measured in 4cm depth, using the Beer-Lambert Law. (b) mean  $\pm$ SE vertical attenuation coefficient in 2001. Letter-number combination at top of graphs indicate differences in irradiance and  $K_d$ -values between site-time combinations, where letters code the waveband: site-time combinations sharing a number are not significantly different. Note differently scaling and exponential scale in (a).



## **4. BENTHIC DIVERSITY ALONG AN EMERSION GRADIENT: AN EXPERIMENTAL TEST OF THE INTERMEDIATE DISTURBANCE HYPOTHESIS (IDH)**

### **4.1 INTRODUCTION**

Anthropogenic changes might enhance diversity, if two prerequisites of the Intermediate Disturbance Hypothesis (IDH) are fulfilled. First, changes have to generate moderate disturbance regimes and secondly, must affect the dominant species disproportionately more than competitive inferior species (Connell 1978, Huston 1979). Dominance of mussels in the fouling assemblage in the Kiel Fjord has been previously shown (Dürr 1998), indicating their role as competitive superior species.

Harmful effects from aerial exposure on mussels (Kennedy 1976) despite their high thermal tolerance (Wallis 1975) were reported. Yet other species from the rocky intertidal are known to live higher on the shore and thus may be able to endure longer emersion periods, e.g. barnacles (Connell 1961, Krebs 2001). Thus the assemblage at my study site is composed of species with different survivorships for the same emersion event, making it suitable to study the IDH along an emersion gradient.

The existence of a moderate, diversity enhancing emersion regime for fouling assemblages at Kiel Fjord needs still to be tested. According to Connell (1978) and White & Pickett (1985), disturbance may have two appearances. An equally severe disturbance results from either one intense or multiple less intense disturbance events. To consider this facet of the IDH as well, emersion of the fouling assemblage was modified in frequency and intensity treatments.

Specifically I asked (1) Does aerial exposure generate a unimodal diversity pattern along an emersion gradient? (2) Do frequency and intensity generate the same response for diversity? (3) Are there interacting effects between the frequency and intensity treatments of identical cumulative daily emersion times? (4) Do all diversity parameters tested generate the same pattern? (5) Are effects dependent on successional age or season? and (6) Are effects reproducible between years?

### **4.2 MATERIAL AND METHODS**

Both, in 1998 and 2000, a two-factorial field experiment was performed at the Baltic Sea (see chapter 2 for detailed site description) to test for the effects of both, disturbance frequency and intensity, on fouling assemblage diversity and species composition, using emersion as a disturbance quality. A frequency modulated disturbance regime (= frequency treatments) was generated by multiple daily emersion events of settlement panels, each of 15min duration. In frequency treatments,



emersion events were spaced evenly over a day, e.g. a 6h cycle for a frequency of 4x15min/d. An intensity modulated disturbance regime (= intensity treatments) was defined as a single daily emersion event, centred around (1) local noon, i.e. the supposedly desiccation and heat intense period and (2) midnight, i.e. the respective antipode, altered weekly between both modes. Cumulative daily emersion time between frequency and intensity treatments was identical at each treatment level. For instance level (b) (see below) was 4x15min/d and 1h/d in both regimes, respectively. Controls (= no emersion) were regarded as the lowest level along the emersion gradient.

*Experimental set-up* – In both years, plots were arranged in a randomised blocks design. Single plots were represented by vertically suspended quadratic, grey PVC panels (70x70x3mm) roughened with emery paper (grain type 60). The arrangement of plots within treatment levels and the number of treatment levels itself varied among years (Fig. 4-1).

frequency (F)					F & I		intensity (I)				
48x15	24x15	16x15	8x15	4x15	control	1x15	1h	2h	4h	6h	12h
					two procedural controls						

Fig. 4-1: Experimental design of a 2-factorial field experiment, testing for interaction among emersion periods of identical cumulative daily emersion time between frequency and intensity regimes. Controls, i.e. always submerged plots, and 1x15min treatments were equally used for 1-ANOVA testing for effects within any one emersion regime. Treatments in the 1998 experiment are indicated as white and light grey, in the 2000 experiment as white and dark grey. Procedural controls tested for an overall artefact of the experimental set-up at each sampling date separately for each response variable.

In 1998, 4 plots 15cm apart from each other, experiencing the same treatment, were fixed around each of 2 PVC rings, using Velcro (see photo 2a). To avoid pseudoreplication, only the data means of the 4 plots on each ring were analysed, reducing replication to  $n = 2$  (but with reduced variance). The effect of emersion was tested for 5 intensities (a) 0 min/d (= controls), (b) 15min/d, (c) 1h/d, (d) 4h/d, (e) 12h/d, and 5 frequencies (a) 0 min/d (= controls), (b) 1x15min/d, (c) 4x15min/d, (d) 16x15min/d, (e) 48x15min/d.

In 2000, the same panels as in 1998, were individually fixed on grey PVC carrier panels (250x100x3mm), using plastic cable ties. Thus treatments were applied to single plots separately (see photo 2b). The number of treatment levels was increased to 6 intensities (a) 0 min/d (= controls), (b) 15min/d, (c) 1h/d, (d) 2h/d, (e) 6h/d, (f) 12h/d, 6 frequencies (a) 0 min/d (= controls), (b) 1x15min/d, (c) 4x15min/d, (d) 8x15min/d, (e) 24x15min/d, (f) 48x15min/d (all  $n = 6$ ).

Furthermore, a procedural control ( $n = 6$ ) tested for effects on lifting panels in and out of the water, e.g. the exertion of drag and shear forces. Procedural controls were fixed like other panels, but emersed manually 10x/d for approx. 30 sec representing an emersion treatment without heat and desiccation effects. A second set of procedural controls ( $n = 6$ ) was left permanently submersed on moorings scattered over the bay, to test for any effects of float bodies on assemblage succession, due to e.g. altered currents.

To lift panels out of the water, a submersible pump filled a water container with seawater (Fig. 4-2), causing a seesaw to flip from position (b) to (a), simultaneously lifting the settlement panel 20cm above the water surface, a sufficient distance, to keep panels effectively away from waves and

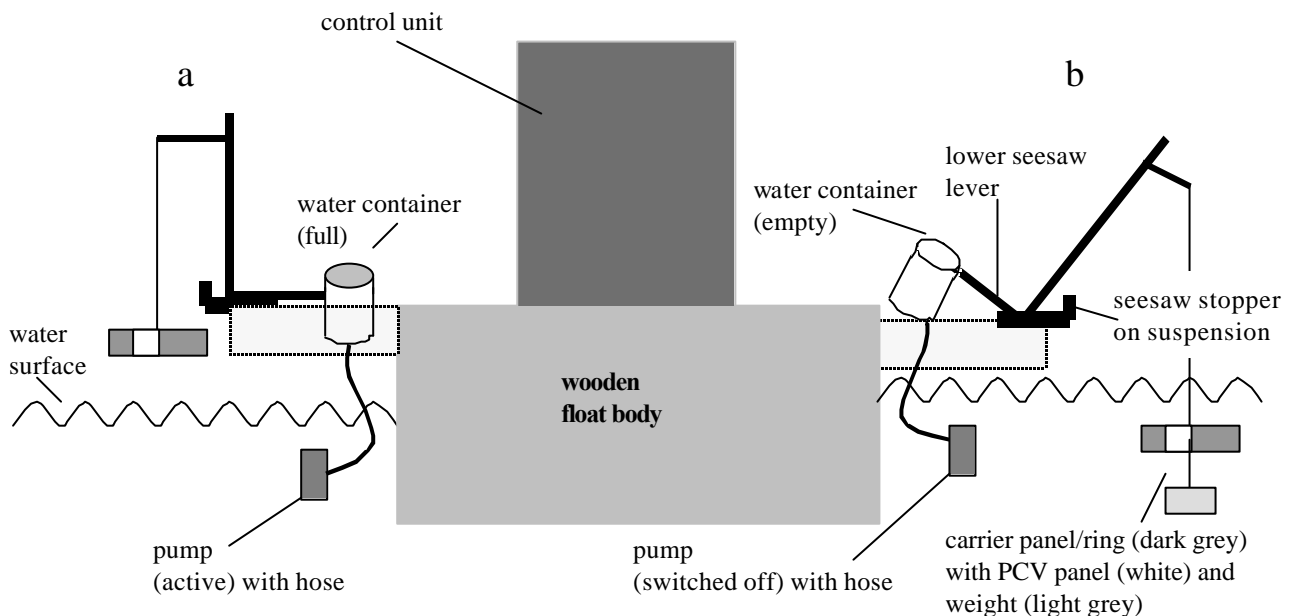

Fig. 4-2: Schematic of experimental set-up, showing two seesaws in alternate position (a) emersion and (b) submersion status. For clearness, electrical cords and reed contacts are not shown (see text “*experimental set-up*” for details). Stippled structure indicate suspension carriers which were punctually mounted, leaving a gap between suspension and float body in which water containers could swing without obstruction.

to ensure complete emersion (see photo 2a;b). Electrical timers, located in the water-sealed housing of the control unit, switched pumps on and off in a pre-set cycle determined by the different treatment levels. After the pump ceased working, water drained from the container through the pump and reversed seesaw position to (b), i.e. 10cm below the water surface. To control for possible power-failures, jammed pumps or seesaws; sealed reed contacts were fixed on the suspension, next to location of lower seesaw lever in position (a) and magnets were mounted on the lower seesaw lever at each seesaw. Within a 5cm range, the magnet triggered the reed contact and the resulting

Table 4-1: Mean  $\pm$ SD of generated emersion times [min/d] in both years and results of 1-ANOVA comparing all daily emersion readings of seesaws of identical treatments as well as between intensity and frequency seesaws of identical accumulated daily emersion time.

	1998		2000	
frequency (x15min)				
	emersion time	p	emersion time	p
1	14.36 ( $\pm$ 2.61)	n.s.	14.82 ( $\pm$ 4.48)	<0.01
4	57.81 ( $\pm$ 19.86)	n.s.	60.71 ( $\pm$ 17.43)	<0.05
8			117.82 ( $\pm$ 43.70)	<0.05
16	243.43 ( $\pm$ 17.79)	n.s.		
24			365.73 ( $\pm$ 96.39)	<0.05
48	685.28 ( $\pm$ 72.91)	n.s.	724.31 ( $\pm$ 109.38)	n.s.
intensity				
1h	60.58 ( $\pm$ 3.70)	n.s.	58.99 ( $\pm$ 17.69)	<0.01
2h			119.27 ( $\pm$ 35.48)	n.s.
4h	241.13 ( $\pm$ 24.26)	n.s.		
6h			366.99 ( $\pm$ 82.46)	n.s.
12h	703.04 ( $\pm$ 77.26)	n.s.	717.61 (96.63)	n.s.
frequency vs. intensity				
4x vs. 1h	96.13 ( $\pm$ 33.08)	n.s.	101.34 ( $\pm$ 26.58)	n.s.
8x vs. 2h			97.60 ( $\pm$ 29.32)	n.s.
16x vs. 4h	95.35 ( $\pm$ 7.47)	n.s.		
24x vs. 6h			98.72 ( $\pm$ 30.31)	n.s.
48x vs. 12h	95.98 ( $\pm$ 10.23)	n.s.	103.60 ( $\pm$ 24.36)	n.s.

current was registered by an electrical counter. Thus duration of seesaws in position (b) was recorded individually for each replicate. Counters were read at least 5x/wk. Despite some rare failures, all treatments differed significantly from each other in both years (1-ANOVA, **1998** *frequency*:  $F_{3,284} = 1965$   $p < 0.01$ ; *intensity*:  $F_{3,297} = 4539$   $p < 0.01$ ; **2000** *frequency*  $F_{4,4832} = 17972$   $p < 0.01$ ; *intensity*:  $F_{4,4847} = 22136$   $p < 0.01$ ). In both years, frequency and intensity treatments of identical cumulated daily emersion time did not differ (Table 4-1). Only in 2000, replicates differed by <5% overall emersion time, mainly due to a high variability in frequency treatments (Table 4-1).

Using sand filled polycarbonate containers as weights below panels (Fig. 4-2), weight adjustments were possible as they became necessary during the course of succession due to increased biomass on panels.

*Larval supply* - Emersion effects on assemblages could be confounded with simultaneous treatment effects on recruitment, because temporal availability of substrate for propagule settlement was not even among treatments of different emersion times. To examine the effects of reduced exposure time to colonization, two additional sets of settlement panels (each  $n = 6$ ) were vertically positioned on individual moorings in the bay. One set was left as controls throughout the study period at the moorings. The second set was transferred in a 12h cycle between bay water and separate, randomly allocated aerated aquaria (11 volume). Aquaria water was changed daily, using unfiltered bay water. A third set ( $n = 6$ ) of settlement panels (= procedural controls) was left permanently in separate aquaria, in which water was exchanged simultaneously with aquaria containing transferred panels. In this way, the potential colonization from dispersal stages originating from unfiltered exchange water could be assessed. Besides an approx. <1mm thin diatom film, no further recruits were found on procedural controls. Thus unfiltered bay water did not confound colonization on transferred panels, indicating that filtration of exchange water was indeed not necessary.

*Assemblage sampling* – To avoid edge effects, no data were taken from a 10mm wide band around the margin of panels. Three fields of vision (total area  $\approx 7\text{cm}^2$ ) were randomly selected. Using a stereo microscope with max. 25x magnification, I estimated percent cover of each species present in each field of vision in 10% increments. Between 0 – 10% an extra 5% increment was added. Species below 5% were recorded with 1% coverage, i.e. present. The arithmetic mean of species coverage per plot was used to compute Shannon-Index  $H'$  and evenness. Plotwise, the cumulative number of species present in the fields of vision was recorded. Individual mussels were counted in the same fields of vision and their mean abundance calculated as number individuals/ $\text{cm}^2$ .

*Larval supply*” experiment mussel individuals were grouped into five size classes, defined by the length of the longest axis and normalized to ind./ $\text{cm}^2$ . Pre-determined average biovolume of mean sized mussel individuals per size class were used to calculate plot-wise mussel biovolume/ $\text{cm}^2$ .

*Statistical analysis* - Data were tested for homogeneity of variances (Cochran) and square-root transformed when necessary. If still heterogeneous after transformation, ANOVA was done, but only allowing clear interpretation for non-significant results (Underwood 1997), while significant data were reanalysed using Kruskal-Wallis test. Using t-tests, I compared response variables from (1) the “*Larval supply*” experiment, and (2) procedural controls vs. controls. Percent cover data entering analysis directly were arcsine transformed prior to the analysis (Sokal & Rohlf 1995). 1-ANOVA compared counter readings. 1- and 2-ANOVAs compared response variables for the

factors frequency and intensity (1998: 5 levels, fixed; 2000: 6 levels, fixed). The level of significance was corrected, using the Bonferoni method (Sokal & Rohlf 1995). Throughout the thesis, the significance level  $\alpha$  was adjusted by multiplication of obtained p-values with the number of comparisons to keep the significance level consistently at 0.05. Where ANOVAs showed significant differences among main factors or interactions, Tukey honest significant difference (HSD) followed as a posteriori test. For correlation analysis the Spearman-rank test was performed. All calculations and graphics for t-tests, correlation analysis and ANOVA were performed with the Statistica™ software package. Species composition was analysed with 1-way analysis of similarity (1-ANOSIM). Using PRIMER™ 5.0, a triangular matrix of Bray-Curtis similarity indices was calculated between pairs of samples based on multispecies percent cover data. Differences between rank orders of similarity measurements among replicates between samples and within samples give the test statistic R. Its magnitude is proportional to the magnitude of differences between treatments (Chapman & Underwood 1999). All post-hoc pair-wise comparisons were adjusted for the level of significance corresponding to the number of comparisons made, using the Bonferroni method. Species mainly responsible for significant differences between assemblages were identified using SIMPER.

### 4.3 RESULTS

In total, diatoms as a cumulative taxa and 10 (1998) or 12 (2000) species were found on panels, including 3 green algae (*Enteromorpha intestinalis* Link, *Ulvopsis grevillei* Thuret, *Chaetomorpha aerea* Kütz. 1849), 1 brown alga (only 2000: *Pilayella littoralis* Kjellm.), 2 red algae (*Ceramium strictum* Harvey, *Porphyra leucosticta* Thuret), and 6 invertebrates (*Mytilus edulis* L., *Balanus* spp., *Laomedea flexuosa* Adler, *Clava multicornis* Forskal, *Polydora ciliata* Johnston, only in 2000 *Membranipora* spp.).

According to Stresemann (1976) local barnacle species are undistinguishable in the field; consequently, all barnacles were scored as “*Balanus* spp.”.

#### LARVAL SUPPLY

Diversity was significantly lower in assemblages left permanently in natural conditions (= control, Fig. 4-3) as compared to assemblages transferred in a 12h cycle between natural conditions and aerated aquaria (= half day) (t-test,  $t_{10} = -3.77$   $p < 0.01$ ). Species richness was not significantly different between half and full day treatments (t-test,  $t_{10} = -1.75$   $p > 0.5$ ), but evenness was (t-test,  $t_{10}$

= -2.43  $p < 0.05$ ). Of the two dominant species, *Balanus* and *Mytilus*, the latter alone was significantly affected. Fig. 4-3 illustrates the significant reduction of mussel volume/cm<sup>2</sup> (t-test,  $t_{10} = 11.16$   $p < 0.01$ ) and percent cover (t-test,  $t_{10} = 4.06$   $p < 0.01$ ) in half day treatments, but no effect on mussel abundance (t-test<sub>10</sub> = -0.45  $p > 0.05$ ).

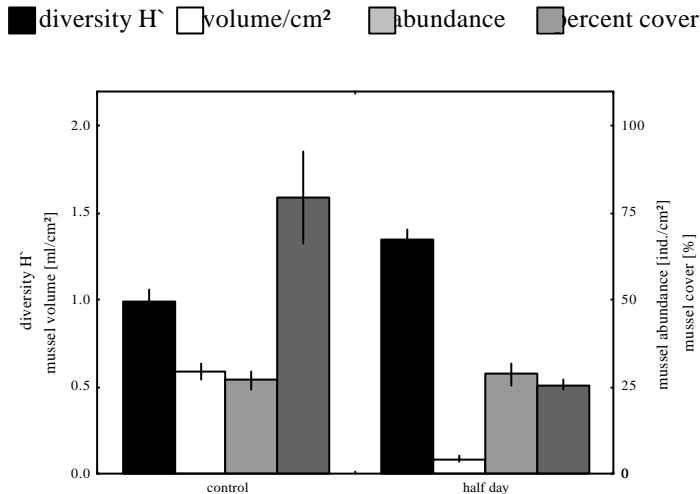

Fig. 4-3: Mean  $\pm$ SE diversity  $H'$ , mussel volume/cm<sup>2</sup>, abundance [ind./cm<sup>2</sup>] and percent cover for assemblages developed permanently in natural bay water (controls) and those transferred in a 12h cycle between bay water and aerated aquaria.

#### EMERSION TREATMENTS

*Procedural controls* – Not any response variable taken into consideration for further analysis was affected from simply moving panels in and out of the water (t-test, all  $p > 0.05$ ). Consequently emersion effects were not confounded by the process of sub- and emersing panels.

*Diversity  $H'$*  – Diversity ranged between 0.00 - 1.63 and 0.00 - 1.61 in 1998 and 2000, respectively, indicating a generally low diversity system (Fig. 4-4). Diversity was in both years higher in frequency as compared to intensity treatments, this difference however only apparent after 90 days (2-ANOVA, 1998:  $F_{1,6} = 23.84$   $p < 0.01$ ; 2000:  $F_{1,40} = 17.78$   $p < 0.01$ ). Significant interactions at that sampling date indicate that the effects of a given cumulated daily aerial exposure depended on how this treatment was applied. Diversity in the intensity treatments was more strongly reduced at longest emersion duration than in frequency treatments.

Diversity patterns were different between years. In 1998, a unimodal curve was found repeatedly. After day 70 (Fig. 4-4a), diversity was significantly lower in controls as well as the highest frequency (48x15min) and intensity (12h) treatment, compared to 1h emersed assemblages (1-ANOVA, *frequency*:  $F_{4,5} = 15.77$   $p < 0.01$ ; *intensity*:  $F_{4,5} = 17.78$   $p < 0.01$ ). After day 90 (Fig. 4-4b), diversity in controls and the highest frequency treatment increased, while in the 4x15min treatment it was almost the same as on day 70. Though the unimodal

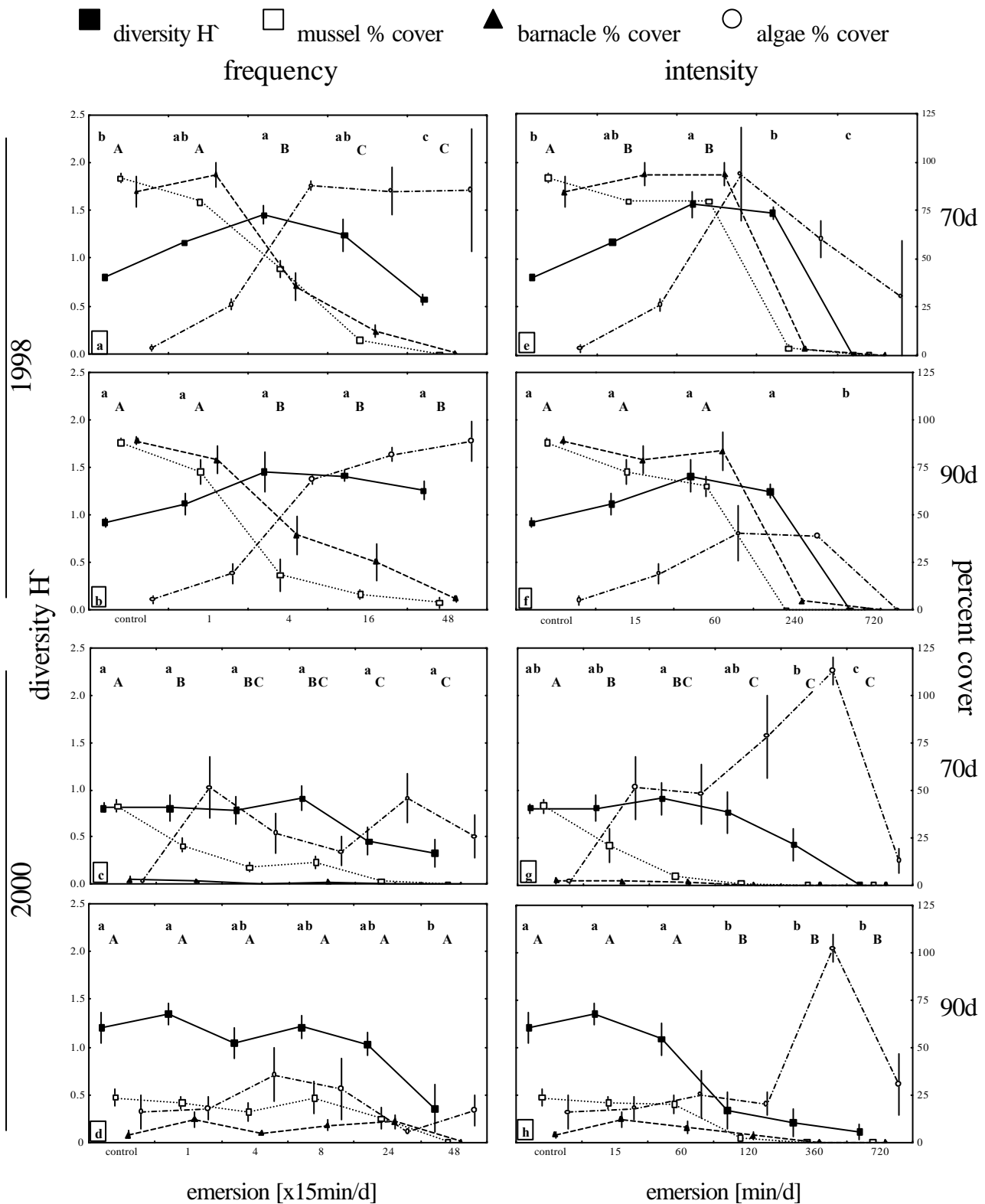

Fig. 44: Mean  $\pm$ SE diversity H', mussel, barnacle, and algae cover in frequency (a – d) and intensity (e – h) modulated emersion regimes 70 and 90d after experiment initiation in 1998 (5 emersion treatments) and 2000 (6 emersion treatments). Lower and capital case letters at top of graphs indicate treatment differences among diversity and mussel cover, respectively: treatments sharing a letter are not significantly distinct. Missing letters indicate data omitted from analysis, due to failure of ANOVA assumptions. Connecting lines do not represent trends, but were added for clearness.

curve was still present, differences between treatments were no longer significant. Diversity was also significantly affected by different intensity treatments (1-ANOVA,  $F_{4,5} = 22.53$   $p < 0.01$ ). Diversity was significantly lower in controls and the longest emersion treatment (12h) than at the intermediate levels, producing a unimodal pattern after 70 days (Fig. 4-4e). After 90 days, diversity was more similar between treatments, only longest emersion produced significantly lower diversity (1-ANOVA,  $F_{4,5} = 31.49$   $p < 0.01$ ; Fig. 4-4f). In 2000, no unimodal diversity pattern occurred at any time and emersion regime, rather diversity steadily declined with increasing emersion. This pattern

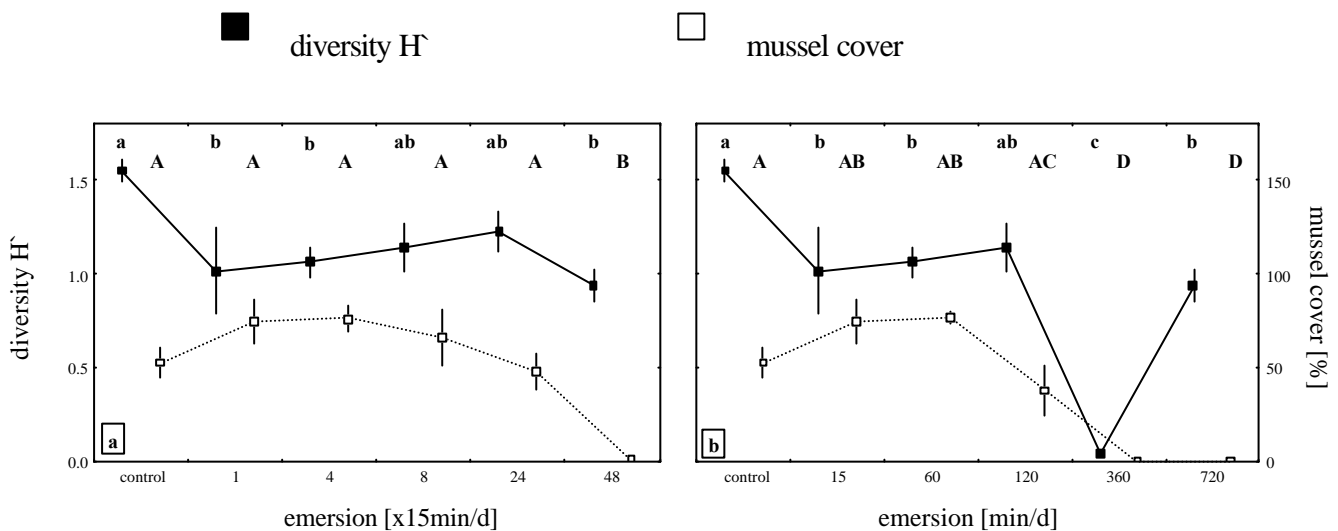

Fig. 4-5: Mean  $\pm$ SE diversity and mussel percent cover after 153d in 2000 for (a) frequency and (b) intensity treatments. Symbols and their interpretation as in Fig. 4-4.

was less conspicuous in frequency treatments, and significant differences were only found twice. First after 90 days (2-ANOVA,  $F_{5,18} = 4.43$   $p < 0.01$ ), when diversity was lower in the 48x15min treatment compared to controls, 1x and 8x15min (Fig. 4-4d) and again after 153 days (2-ANOVA,  $F_{5,18} = 4.35$   $p < 0.01$ ), when diversity was higher in controls as compared to 1x, 4x and 48x15min emersion (Fig. 4-5a). In the intensity modulated emersion gradient, significant differences were found after day 70 (2-ANOVA,  $F_{5,18} = 15.32$   $p < 0.01$ , Fig. 4-4g), when diversity was lower in the 12h treatment compared to all other treatments, as well as in the 6h treatment compared to the 1h treatment. After 90 days (Fig. 4-4h), diversity was significantly reduced in the 2h, 4h and 12h treatment compared to controls, the 15min and 1h treatments (2-ANOVA,  $F_{5,18} = 21.60$   $p < 0.01$ ). Finally, after 153 days (Fig. 4-5b), diversity was significantly affected in intensity treatments (2-ANOVA,  $F_{5,18} = 24.04$   $p < 0.01$ ). Diversity was higher in controls than the 15min, 1h, 6h, and 12h treatments, and lowest on plots from the 6h treatment.



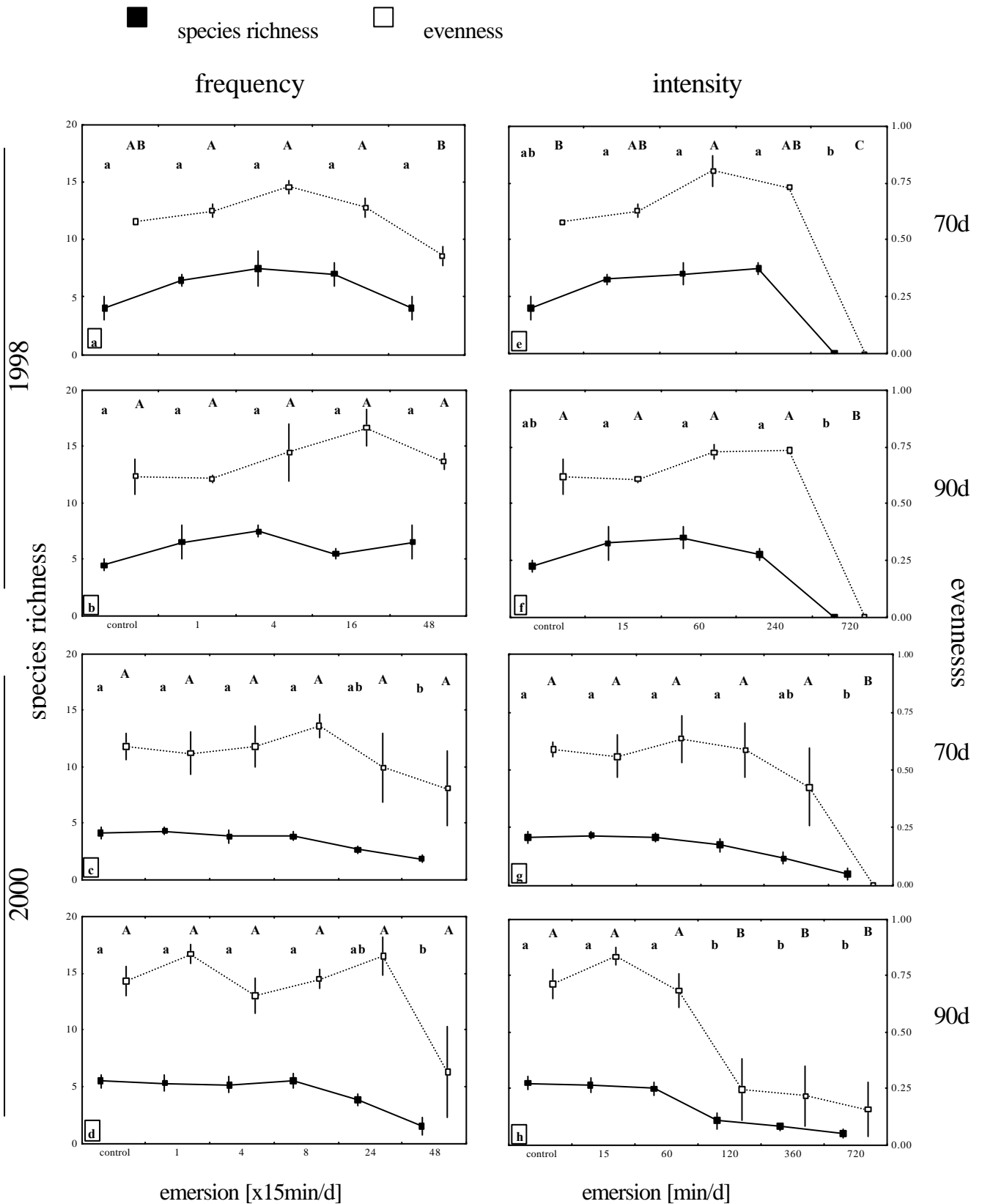

Fig. 4-6: Mean  $\pm$ SE species richness and evenness in frequency (a – d) and intensity (e – h) modulated emersion regimes 70 and 90d after experiment initiation in 1998 (5 emersion treatments) and 2000 (6 emersion treatments). Lower and capital case letters indicate treatment differences for species richness and evenness, respectively. Arrangement of graphs, and interpretation as in Fig. 4.4. Connecting lines do not represent trends, but were added for clearness.

*Species richness* – Species richness ranged between 0 - 6 and 0 – 7 in 1998 and 2000, respectively. Frequency and intensity treatments were not significantly different, except in 1998 after 90 days, when more species recruited in frequency than intensity treatments of identical cumulative daily emersion time (2-ANOVA,  $F_{1,6} = 12.25$   $p < 0.05$ ).

When analysed for frequency and intensity treatments separately, species richness did not differ among frequency treatments in 1998 (Fig. 4-6a,b), but was significantly reduced by the highest intensity treatment at both sampling dates (1-ANOVA, 70 days:  $F_{4,6} = 19.25$   $p < 0.01$ ; day 90:  $F_{1,6} = 10.43$   $p < 0.05$ ) (Fig. 4-6e,f). Controls tended to exhibit low species numbers. In 2000, significant differences were found for frequency (2-ANOVA, day 70:  $F_{5,18} = 4.95$   $p < 0.01$ ; day 90:  $F_{5,18} = 5.28$   $p < 0.01$ ) and intensity treatments (2-ANOVA, day 70:  $F_{5,18} = 6.93$   $p < 0.01$ ; day 90:  $F_{5,18} = 14.62$   $p < 0.01$ ). As a general pattern, species richness in 2000 declined with increasing emersion time. Significantly more species were found on control, 15min, and 1h treated panels as compared to 2h, 6h and 12h treated panels in intensity treatments after 90 days (Fig. 4-6h). In all other cases significantly less species recruited on panels of longest emersion time compared to controls, and panels of cumulative daily emersion time of 15min, 1h, and 2h (Fig. 4-6c,d,g,h).

*Evenness* - Evenness ranged between 0.00 – 0.95 and 0.00 – 1.00 in 1998 and 2000, respectively, and mean evenness was on average higher in frequency than in intensity treatments (Fig. 4-6a-h), mainly due to a stronger decline in evenness in the 12h compared to the 48x15min treatment. Observed differences were significant after day 90 in both years (2-ANOVA, 1998:  $F_{1,6} = 24.40$   $p < 0.01$ ; 2000:  $F_{1,40} = 13.16$   $p < 0.01$ ). In 1998, but not 2000, an interaction between frequency and intensity treatments of the same cumulative daily emersion time was found for evenness, which declined more rapidly in intensity than in frequency treatments between 4h and 12h of cumulative emersion duration at both sampling dates.

Comparing treatments separately for frequency and intensity treatments, evenness was only once, after day 70 in 1998 (Fig. 4-6a), significantly different among frequency treatments (1-ANOVA,  $F_{4,5} = 12.73$   $p < 0.01$ ). Assemblages on panels emersed 48x/15min had a lower evenness compared to assemblages emersed 1x, 4x, and 16x/15min. Evenness was more often affected in intensity treatments. After day 70 in 1998 (Fig. 4-6e), a significant unimodal pattern occurred (1-ANOVA,  $F_{4,5} = 93.79$   $p < 0.01$ ) as evenness was low on control and 12h treatment plots. The unimodal pattern did not persist until the next sampling date (Fig. 4-6f), due to an increase in evenness on control panels and a simultaneous decline on panels of the 1h treatment. Still evenness was significantly different between intensity treatments of that sampling date

(1-ANOVA,  $F_{4,5} = 64.81$   $p < 0.01$ ) because of extremely low values of 12h treated assemblages. In 2000, evenness was significantly different between intensity treatments at both sampling dates (2-ANOVA, 70 days:  $F_{5,18} = 19.69$   $p < 0.01$ ; 90 days:  $F_{5,18} = 12.43$   $p < 0.01$ ). After day 70 (Fig. 4-6g), evenness was lowest in assemblages subjected to 12h emersions, yet a significant block effect was found, too. After 90 days (Fig. 4-6h), evenness was lower in 2h, 6h, and 12h treatments compared to assemblages subjected to shorter emersions. The same overall picture was found after 153d (photo 4).

*Mussel cover* – Averaged per emersion treatment, mussel cover ranged between 0 – 93 and 0 – 75% in 1998 and 2000, respectively (Fig. 4-4 and 4-5). Photo 3 gives an impression of the relatively reduced mussel cover in 2000 compared to 1998, covering on average 50% substratum on control plots in 2000. In 1998, mussel cover was significantly lower in frequency than in intensity treatments at both sampling dates (2-ANOVA, 70 days:  $F_{1,6} = 43.91$   $p < 0.01$ ; 90 days:  $F_{1,6} = 11.11$   $p < 0.05$ ). Nevertheless, a significant interaction indicated that percent mussel cover was different between frequency and intensity treatments (2-ANOVA, 70 days:  $F_{1,6} = 62.26$   $p < 0.01$ ; 90 days:  $F_{1,6} = 25.08$   $p < 0.01$ ). Posteriori tests suggest higher percent mussel cover in intensity treatments =1h, but lower mussel cover for emersion >1h as compared to the frequency treatments of comparable daily emersion. In 2000, a different pattern was found. Mussel cover was significantly higher in the frequency treatments at all sampling dates (2-ANOVA, 70 days:  $F_{1,30} = 17.19$   $p < 0.01$ ; 90 days:  $F_{1,30} = 5.58$   $p < 0.05$ ; 153 days:  $F_{1,24} = 11.49$   $p < 0.01$ ). Once, after 153 days, a significant interaction was found, when mussel cover declined more rapidly in intensity treatments >1h daily emersion as compared to frequency treatments.

When analysed separately for frequency and intensity treatments, mussel cover declined significantly in the frequency gradient towards longer emersion times at both sampling dates in 1998 (1-ANOVA, 70 days:  $F_{4,5} = 332.92$   $p < 0.01$ ; 90 days:  $F_{4,5} = 56.86$   $p < 0.01$ ; Fig. 4-4a,b). Mussel cover was significantly higher in controls and 1x15min emersion as compared to all treatments of longer emersion. Intensity treatments were significantly different in mussel cover at both sampling dates in 1998 (Kruskal Wallis, 70 days:  $H_5 = 11.99$   $p < 0.05$ ; Fig. 4-4e; 90 days:  $H_5 = 9.71$   $p < 0.05$ ; Fig. 4-4f). Controls were significantly more covered with mussels as plots of longer emersion after 70 days. In 2000, mussel cover was significantly different between frequency treatments after day 70 (2-ANOVA,  $F_{5,18} = 30.61$   $p < 0.01$ ; Fig. 4-4c), but not after day 90 (Fig. 4-4d). After 70 days, control plots were covered with more mussels than any emersed plot. Further, 1x15min emersed plots hosted more percent mussel cover than 24x, and 48x15min emersed ones. After 153 days,

mussel cover was again significantly different (2-ANOVA,  $F_{5,18} = 7.39$   $p < 0.01$ ) as 48x15min emersed plots had significantly less mussel cover compared to plots from any other frequency treatment (Fig. 4-5a). In the same year, mussel cover was significantly different between intensity treatments after day 70 (2-ANOVA,  $F_{5,18} = 17.26$   $p < 0.01$ ; Fig. 4-4g). Besides a significant decline in mussel cover on emersed compared to control plots, 1x15min emersed plots had higher mussel cover than plots of 8x, 24x, and 48x15min emersion. Mussel cover declined significantly for >1h intensity treatments at day 90 (2-ANOVA,  $F_{5,18} = 10.59$   $p < 0.01$ ; Fig. 4-4h). At the final sampling date, after 153 days, mussel cover was still significantly affected (2-ANOVA,  $F_{5,18} = 30.86$   $p < 0.01$ ; Fig. 4-5b). Panels of 6h and 12h daily emersion were significantly less covered with mussels than all other intensity emersion plots. Moreover, mussel cover was higher on plots of 15min and 1h than 2h emersion.

*Mussel abundance* – Overall, mussel abundance (Fig. 4-7) was only after 70 days significantly different between years (2-ANOVA,  $F_{1,12} = 19.63$   $p > 0.01$ ), as well as between frequency and intensity treatments (2-ANOVA,  $F_{1,12} = 37.61$   $p > 0.01$ ).

Mussel abundance was not different between years at both sampling dates when permanently submersed plots (controls) were compared (1-ANOVA, *day 70*:  $F_{1,6} = 0.02$   $p > 0.05$ ; *day 90*:  $F_{1,6} = 0.28$   $p > 0.05$ ; Fig. 4-7). The identical result was obtained for assemblages experiencing 15min

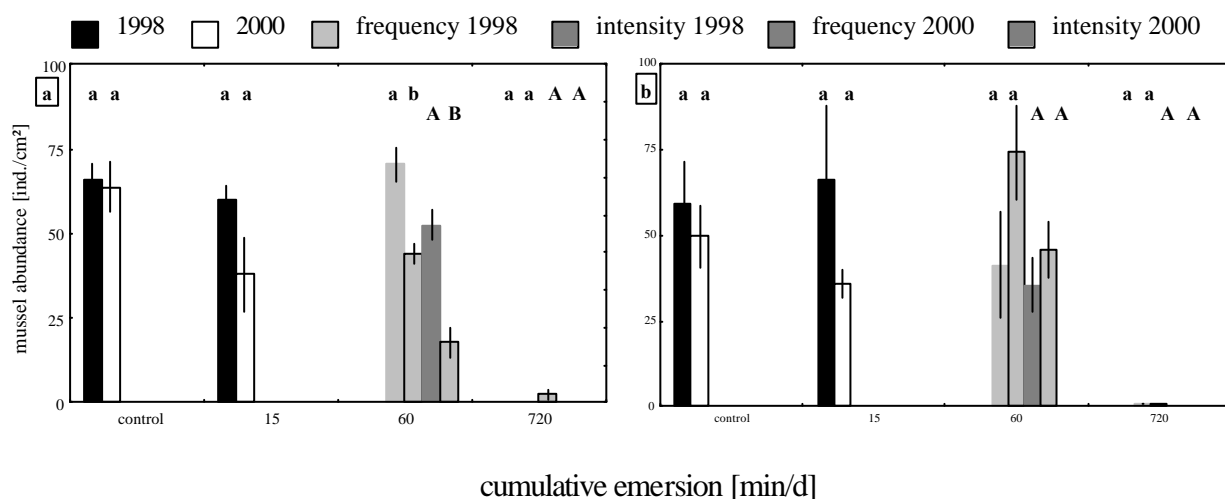

Fig. 4-7: Mean  $\pm$ SE mussel abundance after (a) 70d and (b) 90d of identical cumulative emersion from frequency and intensity treatments. 60min and 720min treatments were the only treatments of comparable emersion time in both years. Lower and capital case letters indicate treatment differences between frequency and intensity treatments, respectively. Controls, and 1x15min treatments have no respective frequency and intensity treatments. Interpretation of symbols as Fig. 4-4.

emersion, however, after 90 days, differences were marginally significant (1-ANOVA, *day 70*:  $F_{1,6} = 1.15$   $p > 0.05$ ; *day 90*:  $F_{1,6} = 5.73$   $p = 0.054$ ). Comparing mussel abundance for assemblages of 1h cumulative daily emersion, differences between years were found after 70 days in both, frequency (1-ANOVA,  $F_{1,6} = 21.13$   $p > 0.01$ ) and intensity treatments (1-ANOVA,  $F_{1,6} = 18.12$   $p > 0.01$ ), while effects perished after 90 days in frequency (1-ANOVA,  $F_{1,6} = 0.13$   $p > 0.05$ ) as well as intensity treatments (1-ANOVA,  $F_{1,6} = 2.95$   $p > 0.05$ ). For the longest emersion treatment, no differences in mussel abundance were detectable.

*Balanus cover* – Averaged per treatment, barnacle cover ranged between 0 – 100 and 0 – 12% in 1998 and 2000, respectively (Fig. 4-4). In 1998, barnacle cover was significantly lower in frequency than intensity treatments of equivalent daily emersion times after 70 days, but not after 90 days (2-ANOVA,  $F_{1,6} = 23.49$   $p < 0.01$ ). A significant interaction for barnacle cover at that date was found, too (2-ANOVA,  $F_{1,6} = 39.78$   $p < 0.01$ ). Barnacles from intensity treatments covered on average 40% more substrate for <1h emersion and 5% less in treatments of longer emersion than frequency treatments. In 2000, a significant interaction between frequency and intensity treatments occurred once, after 90 days (2-ANOVA,  $F_{1,40} = 3.80$   $p < 0.05$ ). Posteriori tests indicate a steady increase in barnacle cover in the frequency treatments of 24x15min emersion, and in intensity treatments a monotonously decrease for increasing emersion times. Barnacles were completely absent from >4h treatments.

Separate analysis for intensity and frequency treatments revealed significant differences among frequency treatments at both sampling dates in 1998 (1-ANOVA, *70 days*:  $F_{4,5} = 54.05$   $p < 0.01$ ; *90 days*:  $F_{4,5} = 25.90$   $p < 0.05$ ; Fig. 4-4a,b). Barnacles covered significantly more substrate on control and 1x15min plots at both sampling dates and in addition, more barnacles were found on 4x15min than 48x15min treated plots after day 70. A very similar pattern occurred for intensity treated plots (Fig. 4-4e,f). At both sampling dates barnacle cover was significantly different between treatments (1-ANOVA, *70 days*:  $F_{4,5} = 84.97$   $p < 0.01$ ; *90 days*:  $F_{4,5} = 64.02$   $p < 0.01$ ), due to higher cover on control, 15min, and 1h emersed plots as compared to plots of 16x15min, and 48x15min emersion. In 2000, barnacle cover was in both emersion regimes only significantly affected after day 90 (2-ANOVA, *frequency*:  $F_{5,18} = 4.18$   $p < 0.05$ ; *intensity*:  $F_{5,18} = 5.87$   $p < 0.01$ ; Fig. 4-4g,h). In both instances, barnacles covered significantly less substrate in treatments of equivalent daily emersion times of 12h than 15min, and 6h.

*Algal cover* – Fig. 4-4a,b illustrates in frequency treatments a mirror image between mussel and barnacle cover on the one side and total algal cover (<90% diatoms) on the other side. In 1998,

Table 4-2: Results from Spearman rank correlation, comparing percent cover of *Mytilus edulis* and total algal cover as well as *Balanus* spp. and algal cover for each sampling date separately. R = Spearman rank correlation coefficient.

		<i>Mytilus edulis</i>		<i>Balanus</i> spp.	
		R	p	R	p
<b>1998</b>					
frequency	date [d]				
	70	-0.78	<0.01	-0.72	<0.05
	90	-0.88	<0.01	-0.90	<0.01
intensity	70	-0.20	n.s.	0.15	n.s.
	90	-0.12	n.s.	0.18	n.s.
<b>2000</b>					
frequency	70	-0.30	n.s.	-0.05	n.s.
	90	0.08	n.s.	-0.26	n.s.
intensity	70	-0.46	<0.05	0.03	n.s.
	90	-0.38	<0.05	-0.14	n.s.

this negative correlation was exclusively significant for mussel and barnacle cover at both sampling dates in frequency treatments (Table 4-2). In 2000, the opposite was found. Negative correlations were only found between mussel and algal cover in intensity treatments (Table 4-2).

*Species composition* – Significant emersion effects on species composition were found for both emersion regimes in both years (Table 4-3). Despite significant results in global tests, pairwise

Table 4-3: Results of 1-ANOSIM comparing assemblage structure among frequency and intensity treatments at the final sampling date of both years.

	1998		2000	
	R	p	R	p
<i>global tests</i>				
source				
frequency	0.840	p<0.01	0.361	p<0.01
intensity	0.771	p<0.05	0.772	p<0.01

comparisons were not able to detect which treatments were responsible for the overall effect in 1998. Very likely, using two replicates reduced test power too much to detect any significant differences. In 2000, assemblages emersed 24x15min were significantly dissimilar from controls and those of 1x15min emersion (Fig. 4-8a). In both cases the hydroid *Laomedea flexuosa* contributed

most to dissimilarity, i.e. 51% and 37% for controls vs. 24x and 1x vs. 24x15min, respectively. For intensity treatments (Fig. 4-8b), species composition of 6h emersed assemblages differed from to all other treatments, except 12h emersion. In all cases, diatoms were the most discriminating taxon, contributing 40; 49; 49; and 46% between 6h vs. controls, 15min, 1h, and 2h emersed assemblages, respectively. Furthermore, *L. flexuosa* contributed 35% to dissimilarity between controls and assemblages of 2h emersion and *Balanus* spp. contributed 26, and 28% to dissimilarity between 15min vs. 2h and 1h vs. 2h emersed assemblages, respectively.

A comparison between assemblages on control panels from both years was significant ( $R = 1.0$   $p < 0.05$ ). The hydroid *L. flexuosa* contributed 42% to the observed dissimilarity.

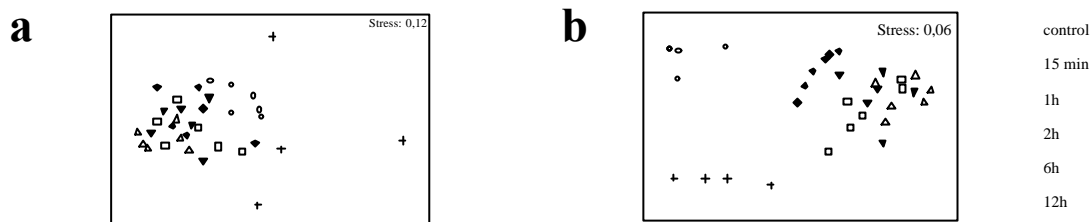

Fig. 4-8: MDS plot for (a) frequency and (b) intensity treated emersion gradients. Stress indicates the goodness-of-fit for regression performed among the ranked physical distances of points given by the similarity matrix.

## 4.4 DISCUSSION

### LARVAL SUPPLY

A limitation of 12h access to bay water affected diversity, evenness, mussel cover and growth, but was without effect on species richness, barnacle cover and mussel abundance when compared to controls. Therefore, differences in evenness accounted mainly for differences in diversity. The dominance of mussels on control plots indicates that this competitive bivalve was the major assemblage component causing evenness differences and lower diversity in controls. A limitation in mussel growth, but not recruitment caused an increase in mussel cover on control plots. Reducing exposure time to bay water to half, was without effect on the abundance of both dominant species, mussels and barnacles, indicating a surplus in propagules. Moreover, this finding suggests that effects from emersion experiments will hardly be confounded by time differences in substrate availability between treatments of different emersion. Finally, 12h daily emersion represented the most severe treatment. Shorter emersion periods may mitigate negative effects on mussel growth, though this was not tested.

*EMERSION TREATMENTS*

Generally, the generation of unimodal patterns along an emersion gradient was possible, but depended on treatment quality (frequency vs. intensity), successional stage of assemblages, year of the experiment, and the diversity parameter used.

Emersion generated a unimodal diversity  $H'$  pattern along a gradient of frequency and intensity treatments for assemblages at an early successional stage (70d) in 1998. This can be explained as follows. Diversity was low under benign conditions, i.e. <1h cumulative daily emersion, due to high abundance (>90%) of the two dominant species, mussels and barnacles. However, competitive exclusion was incomplete, since species richness was not reduced throughout the experiment. This stands in opposition to the IDH (Grime 1973a, Connell 1978) which was postulated for species richness only, thus predicting loss of species as a result of competitive exclusion in the mild part of a disturbance gradient. Besides species richness, evenness contributes to diversity too, suggesting a stronger influence of evenness on diversity in my experiments as compared to species richness. This was confirmed for intensity treatments, where evenness was significantly lower on controls than on moderately disturbed plots, i.e. 1h emersion, just like diversity, while species richness was not. Nevertheless, in frequency treatments, neither species richness, nor evenness was significantly lower under benign conditions, making an interpretation of the relative share of the two towards diversity more awkward. Although evenness inclined more strongly as compared to species richness between emersion treatments for which significant differences in diversity were found. A general enhancement of evenness in the presence of physical disturbance has been shown for lotic systems (McAuliffe 1984). Here overturning of stones prevented the formation of competitive monopolies by the sessile caddisfly larva *Leuotrichia pictipes*, in favour of higher abundance of other benthic insects. Highest evenness in phytoplankton assemblages was found at an intermediate disturbance level, where diversity peaked, too, while species number remained essentially unchanged (Flöder & Sommer 1999). Lengthening emersion to 1h in my experiment was without effect on species richness, but augmented diversity and - in intensity treatments alone - evenness too. Reduced survival of dominant species as harshness of the disturbance regime increases is a necessary prerequisite for the applicability of the IDH (Connell 1978). Indeed, maximal diversity was found at 4x15min and 4h of the frequency and intensity modulated emersion gradient, respectively. These were also the treatments where mussels and barnacles experienced the strongest reduction when compared with the adjacent benign emersion treatment, i.e. 1x15min and 1h for frequency and intensity gradient, respectively (Fig. 4-4a;e). The large time difference between



intensity and frequency treatments affecting mussel and barnacle cover is puzzling. The procedure of lifting panels in and out of the water neither affected assemblages in general, nor mussels and barnacles in particular compared to permanently submersed panels. Thus moving panels more often through the water will not explain the same effect size, e.g. in the response for diversity, between frequency treated plots of lower daily emersion doses compared to intensity treated plots.

Other studies showed that a 1h emersion interval was sufficient to lower settlement success in serpulid larvae (Hamer et al. 2001) and reducing photosynthetic capacity of two macrophytes (Adams & Bate 1994). Mussels and barnacles, however, seem to be tolerant to emersion effects beyond 1h. *Mytilus edulis* is known to withstand aerial exposure better than other mussel species (Kennedy 1976), making them the most successful intertidal colonizers at many sites (Suchanek 1978). Therefore, it is even more surprising that I observed a strong decline in mussel and barnacle abundance beyond 4h emersion. Air temperature was always below the reported lethal temperature of 28.5°C for mussel (Wallis 1975). Thus total emersion time may not be the only factor affecting mussel and barnacle performance, the number of repeated emersion events should be considered as well.

The results suggest a switch in dominance along the disturbance gradient. Percent cover of mussels and barnacles was highest under benign condition, while algal cover was highest in the harsh emersion environment (photo 4). Diatoms in particular performed better than any other species under harsh conditions, dominating in emersion treatments >1h.

In accordance with the predictions of the IDH, declining diversity was observed to the right of the diversity peak (frequency: >1h; intensity: >4h). Yet the mechanisms which cause this decline in my experiment seem to be quite different from earlier postulated mechanisms (Grime 1973a, Connell & Slatyer 1977). Traditionally, physical constrains under severe disturbance eliminate the more sensitive species leading to a decline in species richness. I found diversity and evenness significantly lower at the harsh end of the frequency and intensity gradients, but species richness declined significantly along the intensity gradient alone, although a unimodal trend was also apparent along the frequency gradient. Thus significantly lower diversity in frequency treatments resulted more from reduced evenness, due to the dominance of diatoms at the harsh end of the disturbance gradient. Contrasting traditional IDH postulates, a decline in species number alone was not sufficient to explain declining diversity under a high disturbance frequency in my experiment. A change in dominance from mussels to algae between the respective benign and harsh conditions along the emersion gradient was simultaneously acting to reduce diversity under harsh environmental conditions.

*Frequency vs. intensity modulation* - Emersion effects were dependent on the disturbance modulation. This was most obvious under harsh conditions, where diversity parameters declined stronger in intensity than frequency treatments for the same daily emersion dosis. Yet interactions were rarely found. Very few studies tested effects of disturbance intensity and frequency and their interaction simultaneously under natural conditions and for several diversity parameters. McCabe & Gotelli (2000) were unable to demonstrate an interaction between frequency and intensity treatments after brushing plots with a wire brush, to disturb lotic macrobenthic assemblages. Nor was disturbance found to generate unimodal diversity patterns in either disturbance regime. Lotic systems seldom corroborate the predictions of the IDH (Mackey & Currie 2001). Motility of assemblage members (McCabe & Gotelli 2000) and the existence of a hyporheic zone (Dole-Olivier et al. 1997) are presumed immigration sources compensating for species loss due to experimental disturbance, usually brushing and racking of plots. In freshwater plankton assemblages both frequency and intensity generated highest diversity at intermediated levels of nutrient pulses, the applied disturbance (Flöder & Sommer 1999). Species richness on the other hand followed the predictions of the IDH only under frequency treatments. No interaction was tested in their experiment. These results confirm that there is no uniform response pattern across diversity parameters along disturbance gradients (Mackey & Currie 2000, this study).

*Successional stage* - The observed unimodal diversity patterns were non-persistent. Despite similar patterns in mussel, barnacle and algal abundance between sampling dates in 1998, diversity increased in controls as well as in the most frequent disturbance treatment as succession progressed, and diversity gradually reached similar levels over the entire disturbance gradient. This was slightly different along the intensity gradient, because longest emersion periods persistently reduced diversity. Despite marginal differences between frequency and intensity patterns, loss of the unimodal pattern in both regimes suggests two things. First, competitive exclusion was not always achieved in the investigated assemblage. Mussels were not able to completely eliminate other species on undisturbed plots (photo 3). This contradicts the assumptions of Huston's dynamic equilibrium hypothesis (1979) which predicts in high productivity systems lower diversity when disturbance is infrequent due to increased growth rates of competitors. Perhaps the study period was too short or water temperatures below 11° C during the last third of the experiment were already too cold to allow mussel growth rates necessary to overgrow other species. Second, longer emersion intervals did indeed strongly reduce mussels and barnacles, but were not severe enough to eliminate the even more resistant algal species. Consequently, diversity did not decrease as expected even under harsh emersion conditions.

*Choice of diversity parameter* – Choice of diversity parameters influenced patterns observed along emersion gradients. Species richness was least sensitive to disturbance in frequency and intensity treatments of my experiment. Likewise, Flöder & Sommer (1999) were not able to detect a unimodal response pattern for species richness along an intensity gradient in their experiment. Unimodal patterns seem to emerge more readily when switching from species richness as a simple sum parameters to diversity  $H'$  as a more complex parameter. However, similarity analysis still detected structural differences in assemblages for sampling dates, when the Shannon-index  $H'$  was already unable to distinguish between them. This suggests more dynamical processes within assemblages although they would not be reflected in sum diversity parameters and thus will not influence diversity patterns along disturbance gradients.

*Inter-annual variation* - In contrast to the significant unimodal diversity pattern at the first sampling date in 1998, there was only a non-significant trend at the second sampling date of that year. In 2000, diversity declined steadily along the emersion gradient. The most striking difference between both years was the lower mussel and even more reduced barnacle cover in 2000 for emersion intervals <1h and the resultant higher evenness values. Thus diversity was not reduced under benign conditions, as it was in 1998 because of a reduced relative abundance of the dominant competitors. The conditions at the opposite end of the emersion gradient were also contrarily to 1998, as species were lost in 2000 under harsh conditions. Significantly higher air temperature and lower precipitation and humidity in 2000 indicate a generally more severe emersion regime than in 1998 (see Chapter 2). Yet non-significant differences of mussel abundance between 1998 and 2000 suggest whatever differences existed in the two years, they were not mediated into mussel recruitment.

Species composition was markedly different between both years after 90 days, possibly because experiments started in different seasons and founder effects produced differently sensitive assemblages. Initiation of experiments in 1998 coincided with peak mussel spat falls, while in 2000 mussel spat falls occurred after 90 days of previous succession. Mussel abundance in 2000 never reached similar values as in 1998 even after succession was allowed to proceed for twice as long and well beyond mussel spat fall was accomplished.

In conclusion, emersion may generate unimodal diversity patterns as predicted from IDH models. The vulnerability of the dominant species – in this case mussels and barnacles - to emersion effects, i.e. the applied disturbance agent, was stronger than to some other species, mainly diatoms. Thus in the chosen system, a necessary requirement of the IDH for the generation of unimodal

patterns along disturbance gradients was accomplished. In opposition to the original IDH concept, a switch in dominance besides a loss in species under harsh environmental conditions, was proposed as a mechanism to reduce diversity for the establishment of a unimodal pattern. Choice of diversity parameter, seasonality, inter-annual variability in abiotic and biotic factors, successional stage, and quality of the disturbance regime all contributed to the variability of the assemblage response, making a unimodal response for diversity along a emersion gradient more an exception, than the rule. Yet, other disturbance qualities, e.g. UV radiation, might accomplish more predictably the assumptions of the IDH model.



## 5. BENTHIC DIVERSITY ALONG AN UV GRADIENT: AN EXPERIMENTAL TEST OF THE INTERMEDIATE DISTURBANCE HYPOTHESIS (IDH)

### 5.1 INTRODUCTION

The effect of emersion on the response for diversity of fouling assemblages at the Baltic Sea study site depended on a multitude of factors, which only temporarily produced the predicted unimodal diversity-disturbance relationship (see *Chapter 4*). Although the IDH was construed for species rich systems, its principle applicability for species poor systems can only be accepted or rejected after testing various disturbance agents.

Several properties make ultraviolet B radiation (UVB) a suitable disturbance factor for testing the assumptions of the IDH at the Baltic Sea study site. First, UVB is detrimental to key molecules, e.g. enzymes for the inactivation of Rubisco (Franklin & Forster 1997, and references therein), photopigments (Wängberg et al. 1996, and references therein), and DNA (Caldwell et al. 1989). Second, molecular UVB effects may impair species performance at the aut-ecological level, e.g. reduced photosynthetic rate (Smith et al. 1992), motility (Häder et al. 1998) or lower survival of dispersal stages (Damkaer et al. 1981, Damkaer & Dey 1983), but see Epel et al. (1999) for opposite. Third, detrimental UVB effects were reported for adults and dispersal stages of which some species are known to exist at the Baltic Sea study site, e.g. diatoms of the genera *Licmophora*, *Nitzschia* and *Amphora* (Santas et al. 1997, 1998b), the filamentous algae *Enteromorpha prolifera* (Santas et al. 1998a) and *E. intestinalis* (Cordi et al. 2001) and the blue mussel *Mytilus edulis* (Fairbrother 1994). Finally, global UVB levels are higher than ever, suggesting a great damaging potential (WMO 1998). However, species specific mechanisms to reduce UVB impacts at the organism level exist, e.g. avoidance (Rhode et al. 2001), photorepair (Häder et al. 1998, and references therein) and synthesis of photoprotective compounds (Wängberg et al. 1996, and references therein). If species exhibit different UV sensitivities as shown among arctic macroalgae (Karsten et al. 2001), changes in species composition with rising UVB levels are possible and hypothesised for terrestrial (Caldwell et al. 1989) and aquatic ecosystems (Häder et al. 1995). Experimental evidence is still missing.

To test for an ecological relevance of UVB in the context of the IDH, I followed diversity in the succession of benthic assemblages along a gradient of enhanced UVB. By asking (1) whether a unimodal relationship is apparent between diversity, species richness and/or evenness and UV radiation, and (2) whether this pattern is persistent during succession.

## 5.2 MATERIAL AND METHODS

In 2000 only, a 1-factorial field experiment was performed from the 29.05. - 06.10.00, testing the effects of enhanced UVB on diversity and species composition of a fouling assemblage along a gradient of different intensities, i.e. different daily exposure times.

*Experimental design & set-up* – In a randomised blocks design, I tested radiation effects between (a) control, (b) procedural control, and 5 treatments (see below: c–g) supplementing ambient UVB irradiance using lamps (UVB-313, Q-panel, USA) as artificial UV sources. Lamps were switched on daily, centred around local noon for (c)  $\pm 15$  min, (d)  $\pm 30$  min, (e) min and (g)  $\pm 240$  min (all  $n = 6$ ). Control plots were arranged in three separate blocks in the bay without lamps (Photo 1; Fig. 2-2). In contrast to UVB treated plots, lamps above procedural controls were not switched on, to tested for possible artefacts of the experimental set-up, e.g. shading by the lamp suspension. Like UVB treated plots, procedural controls were randomly allocated in duplicate to blocks along side three wooden platforms (10,000 x 2,500 x 600mm) indicated as numbers 1-3 in Fig. 2-2. Grey PVC panels (70 x 70 x 3mm) representing plots, were fixed horizontally to submersed wooden bars in 0.1m water depth using Velcro (Fig. 5-1).

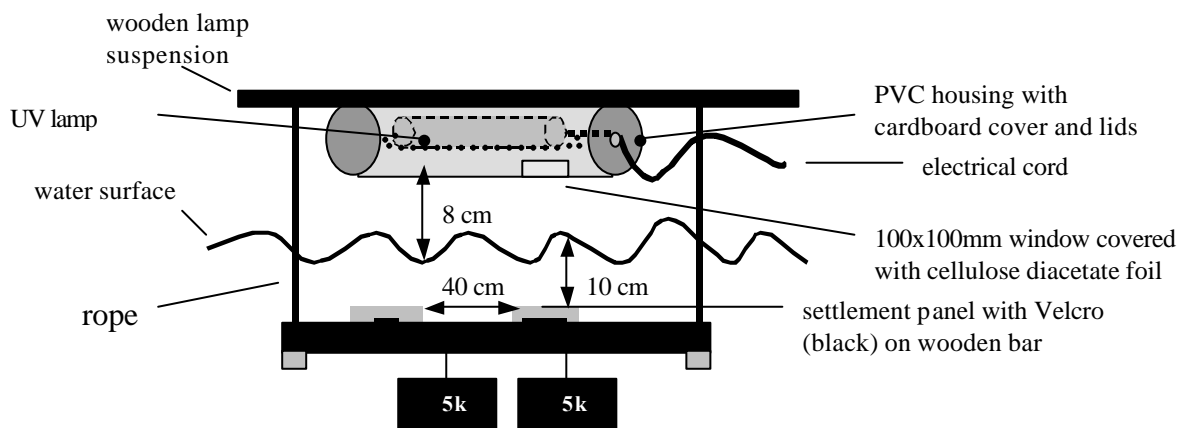

Fig. 5-1: Scheme of two experimental units (for clearness only one bar shown). UVB lamps were suspended pairwise 8 cm above the water surface (for clearness only one lamp shown). The wooden suspension was fixed with transoms ca. 50 cm distant from wooden platforms, indicated as the black area in Fig. 22. Electrical cords connected lamps with timer (see text for details).

Two plots, separated by a minimum distance of 40cm rested on single bars. Each panel was irradiated by a separate UVB lamp. Sealed, UVB-transparent Perspex housing (1500mm long, 3mm thick, Ø 80mm, GS 2648, Röhm, Germany), contained the lamps. To avoid irradiation of adjacent plots, I wrapped lamps into non-transparent cardboard (per. measurements), except for a 100 x 100mm window, positioned directly over the plot. Irradiance in between adjacent plots on the same

bar was identical to ambient levels (per. measurements). Thus experimentally controlled surplus UVB irradiance affected plots only where directly positioned under individual lamps. Cellulose diacetate foil, blocking wavelengths  $<288\text{nm}$  (per. measurements), was fixed over windows to absorb all UVC and most of the UVB radiation  $<293\text{nm}$  that are emitted by the lamps, but do not contribute to solar irradiance at the earth's surface. Monthly replacement of foils minimized aging effects of their transmission properties. Reductions in transparency of cellulose diacetate foil after daily penetration of 8h with radiation from lamps was less than 5% after a one month period, but increased to more than 15% after the second month (unpublished data Molis, Sandmann & Stick). Thus monthly replacement of cellulose diacetate foil seemed to be a good trade-off between treatment persistence and labour. The window area of each Perspex housing was rinsed every other day with freshwater to prevent accumulation of salt spray.

Each lamp was individually wired to a master-slave switch (Conrad Electronics, Germany) and its respective counter to control lamp function. Due to the operational mode of the master-slave switch, the electrically driven counter will only record time increments during the burning period of lamps. An electronic timer switched lamps on and off. Counter readings and position of windows were checked at least every second day and corrected when necessary. In spite of occasional mal-

Table 5-1: Mean  $\pm$ SD of generated burning times [min/d] and results from 1-ANOVA comparing among the six UVB lamps of intended identical burning duration (30 to 480 min) over the entire recording period of 134 days. Using 1-ANOVA, pooled data of all lamps with identical irradiance duration were analysed for differences between irradiance treatments over the 134 days period.

source	generated burning time mean ( $\pm$ SD)	ratio of generated to intended burning time [%]	n	df	MS	F	p
30 min.	29.16 ( $\pm$ 4.30)	97.2	134	5	4.26	0.23	n.s.
				806	18.60		
60 min.	58.08 ( $\pm$ 8.92)	96.8	134	5	87.99	1.11	n.s.
				806	79.50		
120 min.	116.53 ( $\pm$ 22.08)	97.1	134	5	843.21	1.74	n.s.
				806	485.27		
240 min.	230.27 ( $\pm$ 36.88)	96.0	134	5	2085.37	1.95	n.s.
				806	1072.32		
480 min.	458.28 ( $\pm$ 84.26)	95.5	134	5	5453.16	0.77	n.s.
				806	7110.62		
between treatments			134	4	24707400	14070.77	<0.01
				4037	1755.94		



function of individual lamps, burning times among lamps of identical treatments did not differ significantly, but were significantly different from other treatment levels (Table 5-1). Occasional electrical failures reduced the absolute amount of intended surplus irradiance by < 5% when averaged over the entire study period (Table 5-1).

*Ambient UVB measurements* – In three campaigns I first determined the depth where plots should be positioned. Therefore I measured ambient and ambient + enhanced irradiance to calculate

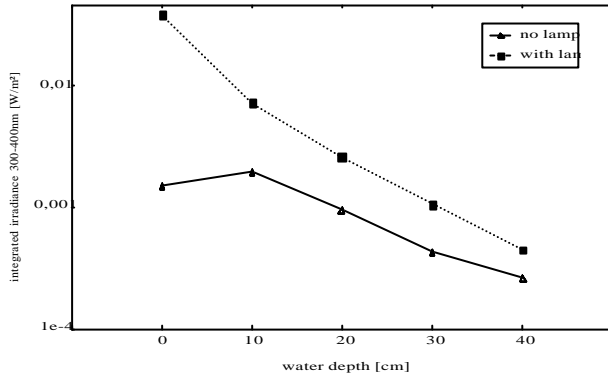

Fig. 5-2: Irradiance integrated from 300–400nm of ambient and ambient + enhanced UVB under lamp suspension, i.e. position of plots, along a depth gradient. Note exponential scaling of the ordinate.

DNA-weighted spectra, using Setlow weighting function. Using a spectroradiometer (LiCor UW-1800), spectral irradiance was measured with 2nm resolution on 30.06.00 at local noon. Fig. 5-2 illustrates the spectral energy integrated between 300-400nm along a depth gradient. Based on this graph, I chose 0.1m as the depth to position the plots. The DNA weighted UVB radiation at that depth was determined to be quite high, i.e. ca. 370% of ambient UVB levels.

Yet measurements were done on the day of strongest overcast making simulated increases in UVB less strong during sunny days (Fig. 5-3). Sec-

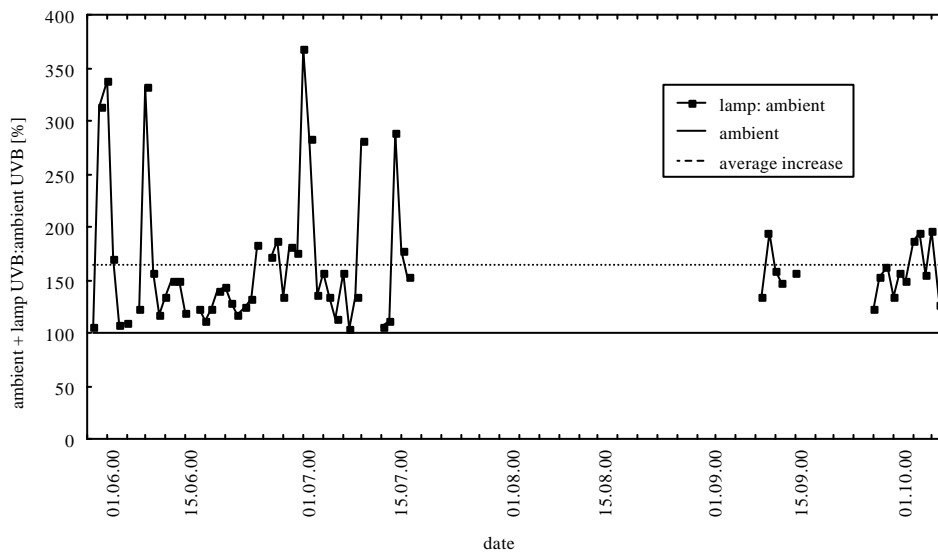

Fig. 5-3: Daily relation between ambient and ambient + enhanced UVB during the study period. Gaps indicate periods of sensor malfunction. Ambient level is set at 100% (solid line). Average increase of ambient + enhanced UVB vs. ambient UVB levels (interrupted line). High values indicate days of strong overcast.

ond, UVB was continuously measured in 0.1m water depth within 30m range of all plots, using the RM-21 UV-meter and a UVB broadband sensor (280-315nm) (Gröbel, Germany). The sensor was adjusted for a submersion effect by a factor determined prior to radiation measurements at local noon on a cloudless day from readings above water and submersed in 1mm distilled water. Daily a laptop logged incoming data, measured by the sensor in 6min intervals within  $\pm 15$ min of local noon. Due to technical problems, no measurements were done between 17.07. and 08.09.00 and from 15.09. until 25.09.00. Third, lamp output was recorded at 0.1m at night to assess lamp irradiance alone. Lamp irradiance was on average 163.76% ( $\pm 61.59$ ) of ambient irradiance during the study period (Fig. 5-3).

*Assemblage sampling* – For a detailed outline of the procedure refer to chapter 4. Mussel abundance data for separate size classes were recorded in this experiment.

*Statistical analysis* – I dealt with heterogeneous variances as described in “*Material and methods Chapter 4*”. Using repeated-measures 2-ANOVA (RM 2-ANOVA), I examined radiation effects on change in dependent variables for the complete duration of the experiment. In the context of this analysis, the expression “averaged for each treatment over all sampling dates” was used to indicate that the analysis grouped replicates over time and compared them among treatments. 1-ANOVA compared surplus UVB as main factor (6 levels, fixed) on assemblage responses for separate sampling dates. Due to multiple sampling, the level of significance was corrected, using the Bonferroni method (Sokal & Rohlf 1995). Significant ANOVAs were followed by a Tukey honest significant difference (HSD) posteriori test. For correlation analysis the Spearman-rank test was performed. Graphs, ANOVAs, and correlation analysis were all performed using the Statistica™ software package. Differences in similarity among treatments were evaluated with the PRIMER™ 5.0 program, using 1-ANOSIM (see *Chapter 4*). Where the analysis produced significant results, SIMPER identified the relative contribution of each species to dissimilarity.

### 5.3 RESULTS

Altogether 9 taxa recruited on the plots: 1 green alga (*Enteromorpha intestinalis* Link), 1 brown alga (*Pilayella littoralis*, Kjellm), 2 red alga (*Callithamnion corymbosum* Lyngb., *Ceramium strictum* Harvey), 4 invertebrates (*Mytilus edulis* L., *Balanus* spp., *Laomedea flexuosa* Adler, *Polydora ciliata* Johnston), and diatoms as a cumulative taxa.

*Assemblage succession on control plots* - Algae dominated assemblage succession throughout most of the study period and contributed  $83 \pm 13\%$  (SD),  $58 \pm 19\%$ ,  $72 \pm 11\%$ ,  $62 \pm 14\%$  and  $40 \pm 8\%$  to total assemblage cover after day 28, 56, 84, 122 and 140, respectively (Fig. 5-4 top row).

I observed three successional patterns for single species. 1) initially strong increase in percent cover followed by its rapid decline, (*P. litorlis*, *E. intestinalis*, *L. flexuosa*, *M. edulis* and diatoms), 2) steady increase in coverage during succession, (*C. strictum*, *P. ciliata* and *Balanus* spp.), and 3) persistently low cover, i.e. >5% , (*C. corymbosum*) (Fig. 5-4).

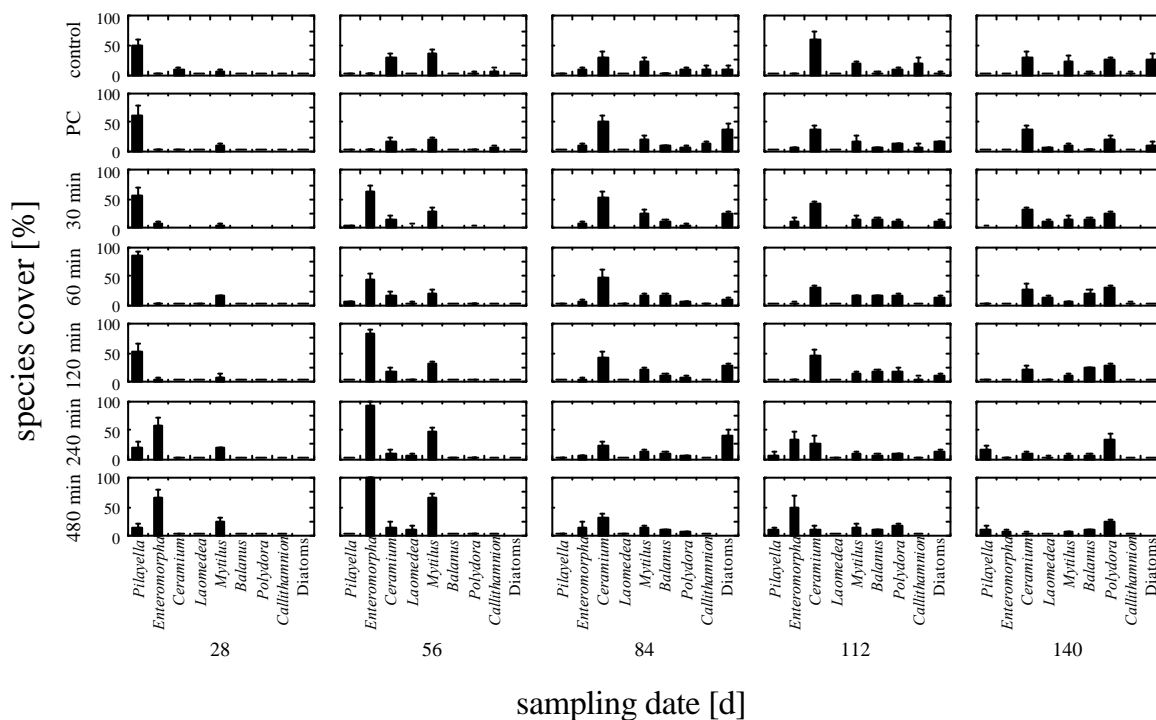

Fig. 5-4: Mean  $\pm$  SE percent cover of all species, at all sampling dates, and for all treatments. control = ambient irradiance, PC = procedural control, 30 min, 60 min, 120 min, 240 min, and 480 min = exposure times of surplus UVB.

*Diversity H'*: Averaged per sampling date, diversity increased steadily until day 112 to 1.70 ( $\pm 0.18$ ), and declined at the final sampling date 1.39 ( $\pm 0.27$  SD) (Fig. 5-5). Comparison of diversity averaged for each treatment over all sampling dates was not significantly different among treatments (RM 2-ANOVA,  $F_{5,18} = 1.24$   $p > 0.05$ ). When analysing single sampling dates, diversity was significantly different after 56 days (2-ANOVA,  $F_{5,18} = 9.70$   $p < 0.01$ ), being highest under the 60min treatment (Fig. 5-5a). One month later this pattern had disappeared (Fig. 5-5b) and did not reappear for the rest of the experiment (Fig. 5-5c).

*Species richness* - When averaged per sampling date, species richness increased continuously until day 112 to  $7.8 (\pm 1.1)$  and dropped at the final sampling date to  $5.6 (\pm 1.2)$  species. Averaging species richness per treatment over all sampling dates, no significant difference among treatments was found (RM 2-ANOVA,  $F_{5,18} = 0.74$   $p > 0.05$ ).

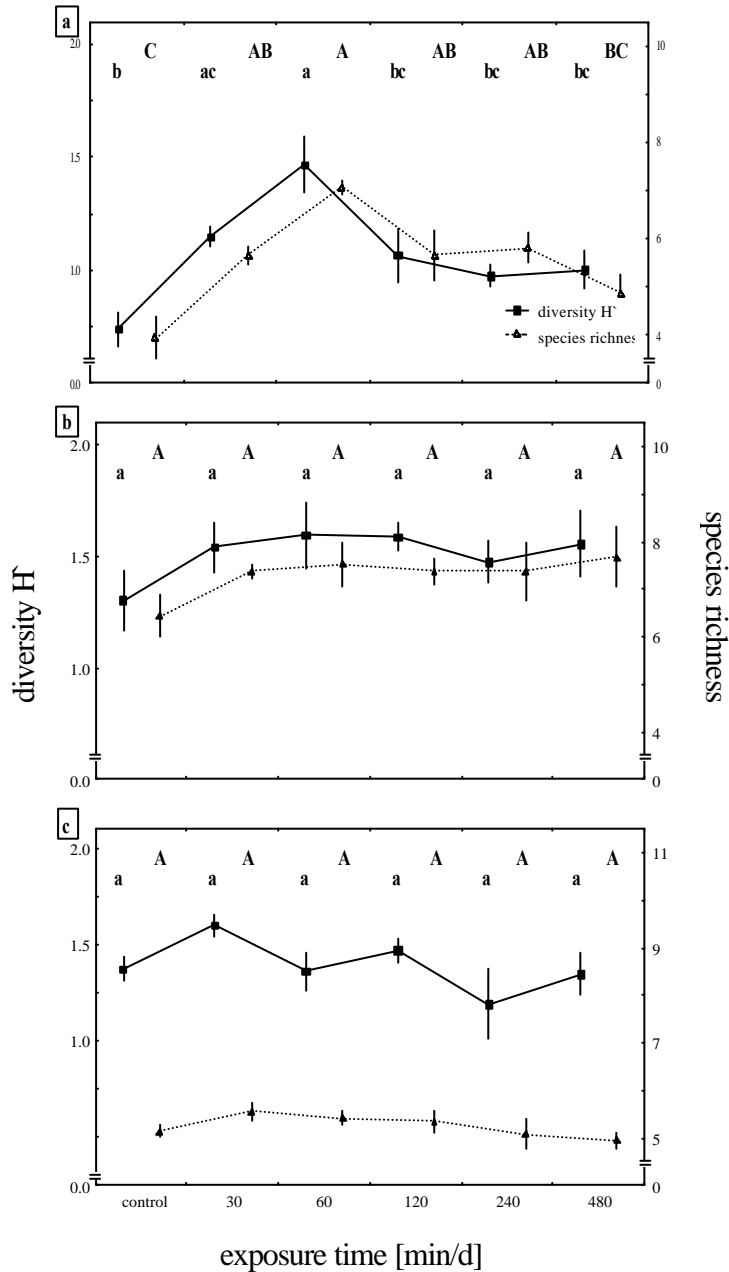

Fig. 5-5a-c: Mean  $\pm$ SE diversity and species richness after (a) 56, (b) 84, and (c) 140 days. Note interrupted scaling for diversity (a-c), and change of scaling for species richness in (c). Lower and capital case letters at the top of graphs indicate differences among treatments for diversity and species richness respectively: treatments sharing a letter are not significantly different.

treatments was found (RM 2-ANOVA,  $F_{5,18} = 0.74$   $p > 0.05$ ). When analysed separately for sampling dates, species richness was significantly different among treatments after day 56 (2-ANOVA,  $F_{5,18} = 6.32$   $p < 0.01$ ), when controls and the 480min treatment had fewest species. Species richness in the 60min treatment was significantly higher than in the 480min treatment. No more significant differences were found.

*Evenness* - Evenness increased monotonously over the study period. Evenness was not affected by treatments, neither for the entire study period (RM 2-ANOVA,  $F_{5,18} = 0.72$   $p > 0.05$ ), nor at individual sampling dates.

*Species abundance* - Two general trends were observed for species performance along the UV gradient. Species of the first group, *E. intestinalis* and mussels, covered significantly more substratum with increasing

enhanced UVB exposure time. Spearman-rank correlation detected a significant positive correlation between percent cover of *E. intestinalis* and mussels at day 56 ( $R = 0.986$ ,  $p < 0.01$ ).

During succession *Enteromorpha* cover peaked on day 56 at  $59 \pm 39\%$  (SD) and declined within the next month to  $9 \pm 10\%$ . Significant differences in coverage of this green alga were found after 28 days (2-way ANOVA,  $F_{5,18} = 81.94$   $p < 0.01$ ) and 56 days (Kruskal-Wallis ANOVA,  $H_5 = 15.92$   $p < 0.05$ ). After day 28, *Enteromorpha* cover was significantly higher under the 240 and 480min treatments compared to all other treatments (Fig. 5-4 first column). Photo 5 features comparable *Enteromorpha* cover for 480min daily surplus UVB exposure in 2001. After day 56, percent cover of *Enteromorpha* was significantly higher in the 240 and 480min treatments than on control plots and more *Enteromorpha* covered 480min than 60min treatments. On day 56, mussel cover was significantly higher in the 480min treatment compared to all but the 240min treatment (2-ANOVA,  $F_{5,18} = 5.78$   $p < 0.05$ ; Fig. 5-4). In the second group, composed of *Pilayella* and *Ceramium*, the opposite trend was observed. Percent cover declined significantly with increasing surplus UVB exposure time. *Pilayella* covered significantly more substratum on control plots and under the 60min treatment compared to both the 240min and the 480min treatments after 28 days (2-ANOVA,  $F_{5,18} = 8.19$   $p < 0.01$ ). *Ceramium* covered significantly less substrate in the 480min treatment compared to controls, the 60min and 120min treatments after day 112 (2-ANOVA,  $F_{5,18} = 5.36$   $p < 0.05$ ; Fig. 5-4). At the final sampling date, *Ceramium* cover was lower in the 480min treatment compared to all but the 240 min treatment (2-ANOVA,  $F_{5,18} = 13.44$   $p < 0.05$ ; Fig. 5-4).

*Mussels* – Averaged for each treatment over all sampling dates, mussel abundance was significantly different among treatments (RM 2-way ANOVA,  $F_{5,18} = 12.90$   $p < 0.01$ ). Mussel abundance was significantly higher for longer, i.e.  $\geq 240$ min, than shorter surplus UVB exposure times. When analysed for single sampling dates, mussel abundance was significantly different among treatments within the first two months (2-way ANOVA, *day 28*:  $F_{5,18} = 14.53$ ,  $p < 0.01$ ; *day 56*:  $F_{5,18} = 5.74$   $p < 0.05$ ). During this period, on average 2.5 times more mussels recruited under the 480min treatment compared to all treatments exposed to  $\geq 120$ min surplus UVB radiation (Fig. 5-6). Hereafter, mussel abundance crashed without subsequent recovery. Besides abundance, mussel cover declined from day 56 to 84 differently among treatments by  $41 \pm 32\%$  (SD),  $85 \pm 56\%$ ,  $41 \pm 42\%$ , and on controls, and plots exposed to 120min, 240min, and 480min surplus UVB radiation, respectively. Simultaneously mussel cover increased by  $118 \pm 96\%$ , and  $215 \pm 242\%$  under the 30min and 60min treatments, respectively.

*Species composition* - Assemblages were significantly dissimilar between treatments at the final sampling date (1-ANOSIM,  $R = 0.297$   $p < 0.01$ ). Pairwise post-hoc tests showed an average

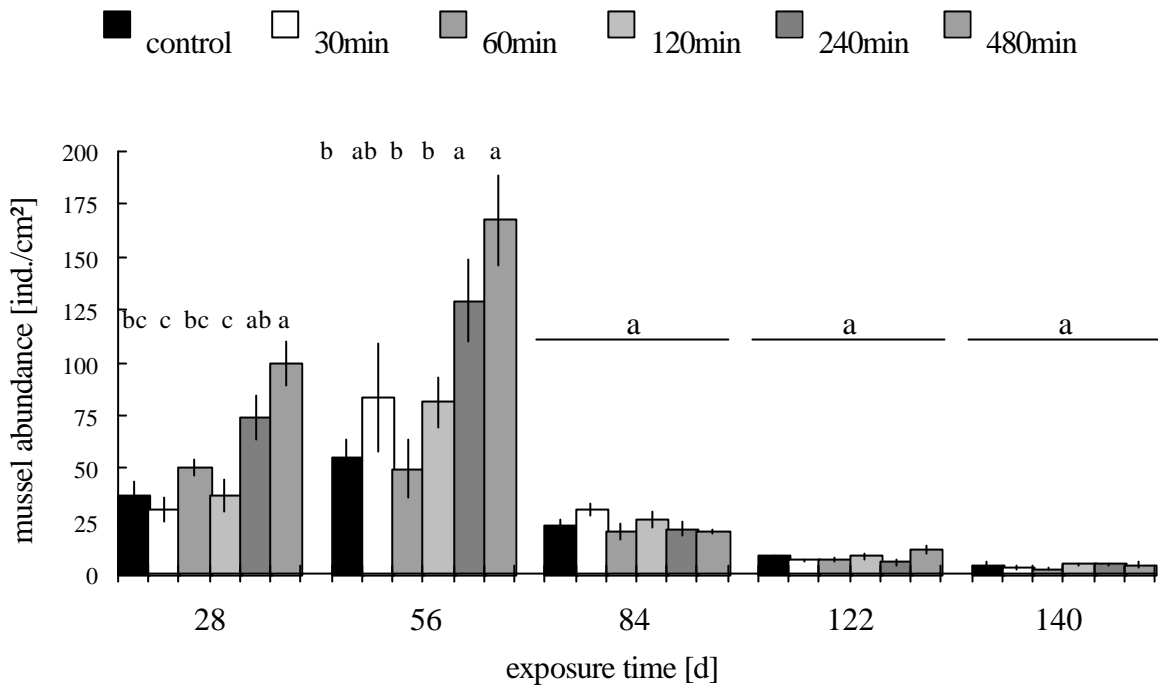

Fig.5-6: Effect of different times of surplus UVB exposure on mean  $\pm$ SE mussel abundance at 5 sampling dates. Letters indicate differences among treatments: treatments sharing a letter or roofed by a bar are not significantly different.

dissimilarity of 55% between the 480min and 30min treatments. *Ceramium* contributed 26% to dissimilarity. Moreover, the 480min treatment was on average 53% dissimilar from the 60min treatment. *Ceramium* contributed 25% to the detected dissimilarity.

## 5.4 DISCUSSION

Analysed over the entire study period, different exposure times of enhanced UVB did not affect fouling assemblage diversity. As a general pattern, responses of all tested variables were divided between an early (<56d) and a late successional phase, with restriction of treatment effects to the early phase. Initial recruitment of the green alga *Enteromorpha intestinalis* and subsequent mussel recruitment were crucial for the dynamics in assemblage structure at that period. Unimodal curves were observed for species richness and diversity, while percent cover of most species followed the gradient of enhanced UVB in a monotonous in- or decrease. My results suggest that surplus UVB disturbs initial successional assemblage stages, but effects were overridden by (an)other factor(s) during later times.

Surplus UVB was an effective disturbance agent (*sensu* Pickett et al. 1989), because species were either completely absent from treated plots (*Callithamnion corymbosum*) or at least absent under the longest daily enhanced UVB exposure (diatoms). Rader & Belish (1997) reported diatoms as particularly susceptible to enhanced UVB radiation. Effects of ambient UVB radiation were shown as non-persistent on species composition, diversity and biomass accrual of diatom assemblages (Bothwell et al. 1993, Santas et al. 1997). Differential susceptibility between diatoms and the more UVB sensitive sympatric consumers, e.g. chironomids, was suggested to promote diatom biomass accrual, explaining non-persistent UV effects (Bothwell et al. 1994, Kelly et al. 2001). Maybe in my experiment factors besides consumption, e.g. reduced PAR levels under dense canopies of the UVB resistant green alga *E. intestinalis* (photo 5) influenced diatom distribution, at least during some time in succession, too. The opposing patterns of the red alga *Ceramium strictum* and *Enteromorpha* support the assumption of lower irradiance levels on *Enteromorpha* dominated plots. Otherwise *Ceramium* cover should have been higher on all plots exposed to enhanced UVB, since this alga was resistant to irradiance effects, indicated by its high cover on control and  $\leq 120$ min treated plots. Thus enhanced UVB may be of indirect negative impact to some algal species, i.e. diatoms and *Ceramium*.

Initially, *Enteromorpha* and *Pilayella littoralis* coverage increased and decreased, respectively, with increasing exposure time of enhanced UVB. Highest *Enteromorpha* cover under exposure times  $\geq 240$ min contrasts other studies. For instance, increased UVB levels, simulating a 30% ozone depletion, lowered germination success and growth rate of reproductive *Enteromorpha* cells irreversibly (Cordi et al. 2001). High UV sensitivity has also been reported for spores of other macroalgae, e.g. the brown seaweed *Ectocarpus rhodochondroides* (Santas et al. 1998a). However, it could be speculated that UV sensitive spores might find suitable settlement sites, e.g. UV shielded areas, generated by UV resistant species. This speculation is corroborated by the existence of protective self-shading of meristematic thallus regions by older canopy in some kelp species (Franklin & Forster 1997). Perhaps this was also the case with *Pilayella* and more obvious with *Enteromorpha* in my experiment. There are conflicting results about the UV sensitivity of *P. littoralis*. Its germination was shown to be UV sensitive from Nova Scotia (Lotze et al. 2002). However, *Pilayella* cover dominated late spring assemblages at the Western Baltic comparable to my experiment (Worm 2000). Perhaps, site dependent UVB effects on spores will cause persistence of the same species in one place and its absence at another site. In late June, *Pilayella* was least abundant on plots with long ( $\geq 240$ min) exposure time to enhanced UVB, while *Enteromorpha* cover was highest on these

plots, suggesting that increasing UVB exposure was more detrimental for *Pilayella* than *Enteromorpha*. Though *Enteromorpha* spores might find refuge from UVB in limited *Pilayella* stands under high UVB exposure, high abundance of the latter under benign UVB conditions seemed to reduce abundance in *Enteromorpha* maybe as a result of reduced PAR levels or competition for nutrients.

During the second month of succession, *Enteromorpha* cover increased on plots under enhanced UVB exposure alone, demonstrating that mature thalli can cope with experimental UVB, but not with ambient irradiance levels. This confirms results of a 6-fold lower UVB sensitivity in mature vs. reproductive cells of *E. intestinalis* (Cordi et al. 2001). Moreover, kelp settlement stages are known to “light harden” as they mature (Franklin & Forster 1997) and species-specific acclimatisation potentials were reported from transplantation experiments with arctic algae (Karsten et al. 2001).

By the end of the second month, both *Enteromorpha* and mussels covered in like manner more substrate as plots were increasingly exposed to enhanced UVB levels. A significant positive correlation between *Enteromorpha* and mussel cover, together with personal observations of aggregates of small mussels (<1mm) around *Enteromorpha* holdfasts suggest (1) facilitation of mussel recruitment, and (2) protective shading by *Enteromorpha*. Enhancement of mussel settlement by filamentous structures, e.g. byssal threads, (Dayton 1971), alga (Hunt & Scheibling 1996) and hydroids (Pulfrich 1996) is well known. Higher occurrence of mussel recruits around holdfasts compared to other algal parts indicates that the *Enteromorpha* canopy acted as an irradiance shield, as already suggested. Thus the *Enteromorpha* canopy generated a protective shield that increased in efficiency simultaneously with enhanced UVB exposure, possibly reversing in this way the UVB gradient. As a result, multiple mussel layers pre-empted the substratum or covered earlier recruits of other species completely on plots exposed daily to  $\geq 120$ min enhanced UVB by the end of the second month. Consequently, dominance of mussels and *Enteromorpha* lowered diversity and species richness significantly in the intense UVB treatments. Towards shorter exposure times, i.e. 60min, species richness and diversity increased significantly, but decreased on 30min treated plots and was lowest under ambient irradiance. Thus, a unimodal diversity pattern as predicted by the IDH was confirmed for species richness and diversity after two months of succession along the UVB gradient (Fig. 5-5a). Nevertheless, ample open space on control plots conflicts with the assumption of the IDH that reduced species richness in the absence of disturbance results from competitive exclusion. Indeed, cover and abundance of blue mussels - the competitive superior species in the system - were significantly lower on controls compared to plots under longest enhanced UVB radiation, suggesting



processes other than competition, e.g. differential recruitment success or UV sensitivity to already ambient irradiance levels caused lower diversity on controls. Complete absence of barnacles and the hydroid *Laomedea flexuosa* on controls, but their appearance on treated plots further indicates that lack in a shading or recruitment enhancing structure e.g. *Enteromorpha* lowered diversity. Thus in the absence of disturbance, the proposed mechanisms of the IDH model were not confirmed by this experiment, though a unimodal pattern was generated. Higher diversity at moderate disturbance levels, i.e. 60min in this experiment, may be best explained by the intermediate extent in *Enteromorpha* cover, which allowed on the one hand UV sensitive species to recruit under the shielding *Enteromorpha* canopy, and on the other hand allowed algae below the canopy to perceive sufficient PAR for survival. The *Enteromorpha* shield did not allow dominance by mussels, which recruited significantly less on 60min treated plots, further enhancing diversity levels.

A 2 to 8-fold decrease in mussel abundance by the end of August, i.e. one month after the unimodal pattern was observed, suggested self-thinning which has been reported for mussels as the result of high growth rates (Petraitis 1995), but subsequently persistent low percent cover data did not confirm this assumption. Simultaneously *Enteromorpha* cover declined drastically, too. Neither *Enteromorpha*, nor mussels recovered to dominate assemblages as before. At the same time (day 84) more species recruited on control and 480min treated plots and the unimodal diversity pattern disappeared. For instance, tube dwelling species, e.g. *Polydora ciliata*, can avoid high irradiance and were consequently able to settle across the full gradient of surplus UVB. Moreover, algae, e.g. diatoms, experienced higher PAR levels after the decline in *Enteromorpha* cover and were found under almost every treatment. As a result, the unimodal pattern perished permanently. Still, differences among UVB treatments were found with regard to species composition. Thus, as for emersion treatments, sum parameters for diversity estimates, like for instance species richness or diversity  $H'$ , will not detect real changes in assemblages due to a condensation of information.

The sudden loss of *Enteromorpha* and mussels can not be explained from available data. Reduced water transparency may explain the decline in *Enteromorpha* cover. Though no measurements exist for 2000 to test this hypothesis, lack of seasonal changes in attenuation coefficient for the identical season in 2001 make this hypothesis quite unlikely. Loss of *Enteromorpha* and mussels was obvious on both, treatment and control plots, indicating a more general successional feature. Perhaps herbivores consumed *Enteromorpha*. Mesoherbivores have a strong direct impact on algal assemblage structure, either in favour of macroalgae (Brawley 1992) or by consumption of certain macroalgal groups, e.g. brown algae (Duffy & Hay 2000). Recently, an almost 20-fold increase in

*Gammarus* spp. abundance has been shown to coincide with a persistent 3-fold decline in *Enteromorpha* cover under high nutrient conditions for the remaining time of the season (Worm 2000). However, consumer abundance was not assessed, making thorough assumptions impossible.

In conclusion, UVB generated an unimodal pattern in both diversity and species richness along an intensity gradient of enhanced UVB radiation. Patterns were non-persistent, disappearing after the second month in succession. A simultaneous increase in protective shading by the *Enteromorpha* canopy with longer exposure times of enhanced UVB radiation possibly reversed the intended UVB gradient by the end of the second month. Mussel dominance was observed under longest enhanced UVB exposure, but not on control plots. At first glance this contrasts the assumptions of the IDH model, which predicts dominance of the competitive superior species under benign environmental conditions. However, the observation of missing mussel dominance on control plots together with mussel dominance under the most intense disturbance treatments is complete in line with the IDH concept after accounting for a reversal in the disturbance gradient.



## 6. A COMPARISON OF UV EFFECTS ON MACROBENTHIC FOULING ASSEMBLAGE STRUCTURE BETWEEN A BALTIC SEA AND SE ATLANTIC SITE

### 6.1 INTRODUCTION

UVB and UVA amount to as little as 1.5% and 6.3%, respectively, of the total solar irradiance prior to the attenuation by the earth's atmosphere (Frederick et al. 1989). The key question for research on UV effects on biological systems is whether changes in this relative small portion of the irradiance waveband can cause significant effects to organisms and assemblages. Studies testing this question experimentally at the assemblage level are scant. Previous experiments (*Chapter 5*) suggest ambient UVB levels may sufficiently reduce diversity, thus detrimental UVB effects on fouling assemblage structure might be generated under the present UVB regime. Yet a rather inconsistent picture about UV effects exists, even for ecologically similar assemblages, e.g. periphyton. Some authors report a reduction for instance in biomass (Bothwell et al. 1993) or diversity (Worrest et al. 1978), others found no adverse UV impacts (DeNicola & Hoagland 1996, Hill et al. 1997). Somehow intermediate, it was documented that initially harmful UV effects on, e.g. diversity, diminished later in time (Bothwell et al. 1993, Santas et al. 1998b).

Past research efforts on the ecological relevance of UV lack comparability, making it impossible to find a general pattern of effects at the assemblage level, let alone processes behind the patterns. The intention of this chapter was, to design comparable experiments at two sites, different in UV regimes, but similar in other abiotic factors. By doing so at the Baltic Sea and the SE Atlantic, I expected a more general pattern to emerge, not obscured by the large number of possible site specific ecological forces. Specifically I addressed the following questions: (1) Are ambient UV levels sufficient to affect assemblages at both sites? (2) Are radiation effects restricted to the UVB component or the entire solar UV range? (3) Are observed effects persistent? (4) If patterns emerge at both sites, is there a common mechanism to explain them?

### 6.2 MATERIAL AND METHODS

*Experimental set-up* – Using cut-off filters, effects of ambient radiation between 3 irradiance levels were investigated in a 1-factorial complete randomised blocks design at both, the Baltic Sea and the SE Atlantic. Unfiltered plots were used as procedural controls to test for filter artefacts, e.g. reflections or obscuration of material collected on filters. As an additional treatment at the Baltic Sea only, supplement UVB was included (for all treatment levels  $n = 6$ ). Lamps and filter materials

had the following optical properties: (a) UVB lamps (313, Q-panel USA) enhancing ambient solar UVB levels by 100% (PAR+UVA+200%UVB = HUVB); (b) 3mm Perspex filters (GS 2648 Röhm, Germany), transmitting on average 90%, 99% and 100% UVB, UVA and PAR, respectively (=PAR+UVA+UVB); (c) 3mm Perspex covered by 0.1mm clear polyester copy paper (LTF NashuaCopy), transmitting on average 4%, 83% and 94% UVB, UVA and PAR, respectively (=PAR+UVA); (d) 4mm Makrolon (long life plus 293, Röhm, Germany), transmitting on average 0%, 0% and 91% UVB, UVA and PAR, respectively (= PAR)( Fig. 6-1). Spectral resolution of filter materials and lamps is documented in Fig. A-1, appendix).

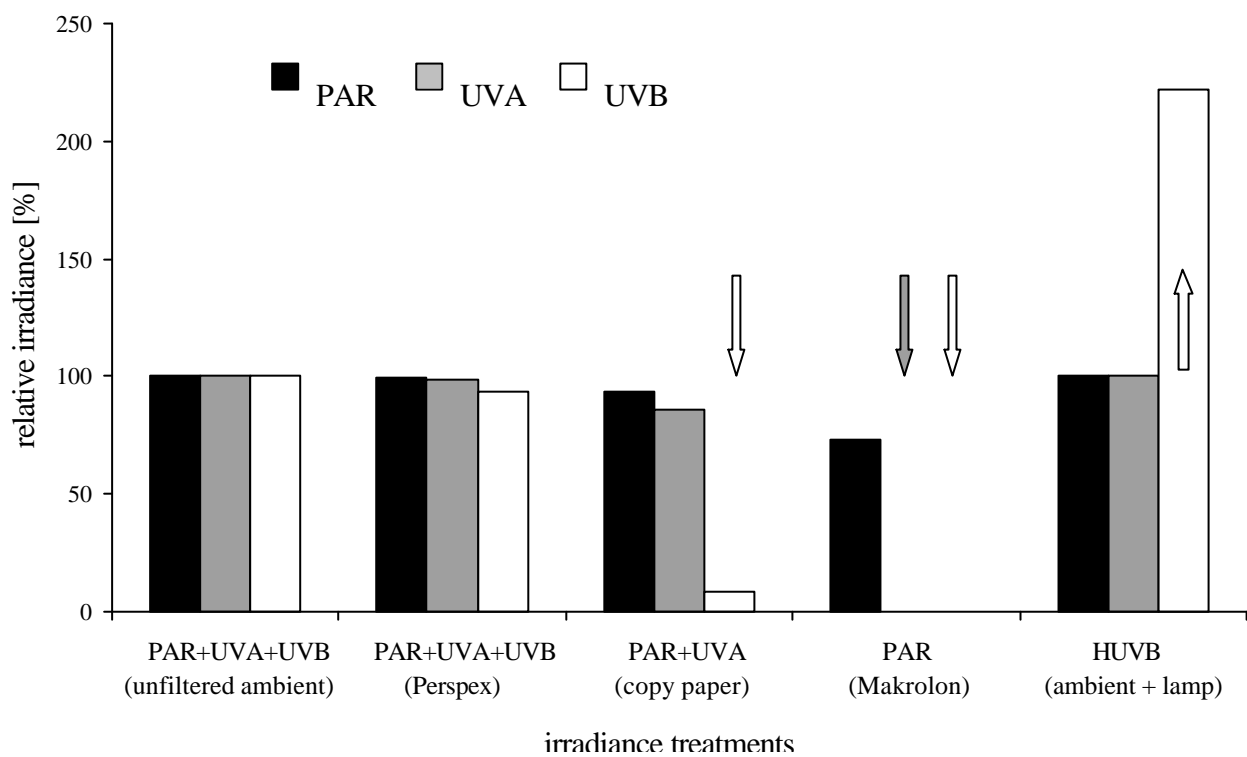

Fig. 6-1: Effectiveness of filters and UVB lamps as relative irradiance, separated in the UVB, UVA, and PAR wavebands. Arrows indicate position and sign of affected waveband.

At both sites 6 mat black coloured rafts (1000x50x5mm) were moored in north-southerly direction (see photo 7 for the arrangement at the SE Atlantic site). Spacing between rafts (= blocks) was set to a minimum distance of 2.5m. 8 openings (100x100cm<sup>2</sup>) were cut equidistantly apart by 200mm into each raft. 4 of them were randomly chosen for the experiment described in this thesis, the remaining openings were used for consumer exclusion treatments described in *Chapter 7*.

3 of the 4 openings were covered with cut-off filters (125x125mm<sup>2</sup>), producing the respective PAR+UVA+UVB, PAR+UVA and PAR treatments. To avoid fouling of filters, raft tops were lifted 1cm above water level, using a 20mm thick Styrofoam sheets, glued with silicon to rafts underside. Transparent polycarbonate containers (100x100x100mm) were fixed into openings carrying

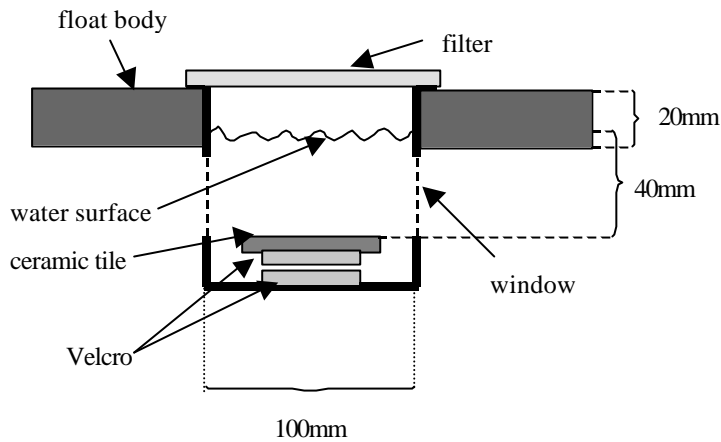

Fig. 6-2: Cross-section of experimental unit.

horizontally ceramic tiles (75x75mm<sup>2</sup> plots) with the unglazed side upwards 50mm below cut-off filters in the centre of openings (Fig. 6-2; photo 6). An 80x80mm section was cut out of each container side wall to allow water exchange on plots. Velcro straps ensured reversible fixing of tiles to the container bottom. HUUVB plots were located separately from the other radiation plots (Fig. 2-2, black areas 1-3) along side 3 wooden platforms (10,000x2,500x600mm). HUUVB treatments were arranged in duplicate at each platform, in north-southerly direction. Mat black coloured PVC rafts (250x250mm<sup>2</sup>) with a central 100x100mm<sup>2</sup> opening were mounted directly under cardboard windows of UVB lamps, using the same set-up described in chapter 5 (see Fig. 5-1 and corresponding text for details). Due to shading of lamp suspension, average radiant energy of PAR and UVA was 4% and 6% lower on HUUVB plots in comparison to procedural controls. Differences were non-significant (1-ANOVA, *UVA*:  $F_{1,30} = 1.64$   $p > 0.05$ ; *PAR*:  $F_{1,30} = 1.29$   $p > 0.05$ ).

The same wiring used in 2000 controlled lamp function in this experiment. Daily lamps were switched on between 9:30-17:30, using an electronic timer. Counter readings and position of windows were checked at least every second day and corrected when necessary. Twice, an electrical failure switched lamps for <24h off and 2 lamps were exchanged within 24h due to malfunction. Statistical analysis of counter readings showed no significant differences between lamps of different plots over time (1-ANOVA,  $F_{5,672} = 0.632$   $p > 0.05$ ).

The polyester film in the PAR+UVA treatment was exchanged at monthly intervals to maintain constant blocking quality. All filter materials were measured before and after the experiment to test for any changes with respect to their filtering abilities (Fig. A-2, appendix). Transparency of used filter materials was significantly reduced, but never exceeded 5% and were similar among treatments.

This indicates constant and conservative treatment conditions. All optical measurements were done with a spectroradiometer (DM 150 double monochromator in Czerny-Turner arrangement, Bentham Instruments Ltd., England), using a Bentham DH3 as the selective photo-multiplier. As light source, a 1000W, 8amp quartz-halogen lamp (General Electrics, United States) was used.

A net (10mm mesh) effectively prevented birds to land on rafts. Nets were spread in a tent-like construction ca. 30cm above the centre line of individual rafts. Irradiance levels were not impaired by nets (per. measurements). In addition, filters were cleaned every second day, to prevent reduction in irradiance as a result of, e.g. salt spray.

*Radiation measurements* – Results are compiled in chapter 3. At both study sites I measured three wavebands close to 30m of all plots, using the RM-21 UV-meter and broadband sensors (Gröbel, Germany) for UVB (280-315nm), UVA (315-400nm) and a Vis-L (max. at 550nm for measuring a PAR proxy in lux). Vis-L readings were converted into  $W/m^2$  according to Lüning (1981). Sensors were adjusted for a submersion effect according to the procedure outlined in *Chapter 5*.

Technical problems restricted irradiance measurements at the SE Atlantic site, to the first two days of the experiment (23. and 24.11.00) and seven days between the 29.01. and 10.02.01. For both November readings two broadband-sensor types (Gröbel, Germany) were available: UV-B (280-315nm) and UV-A (315-400nm). The remaining measurements were undertaken with the UV-A and the Vis-L sensor (Gröbel, Germany) only. All readings lasted for 5min and were taken simultaneously around noon (a) above the water surface, (b) at 0.04m (= depth 1), and (c) 1m (= depth 2).

At the Baltic Sea site, no UVB and PAR measurements were done after 02.08.01 and between 06.-30.07.01, respectively. Missing data were extrapolated from regression analysis using UVA measurements. Irradiance was measured above the water and in 0.04m (= depth 1) for all three wavebands, at 0.25m (= depth  $z_{UVB}$ ) and at 0.5m (= depth  $z_{PAR,UVA}$ ). Readings were taken simultaneously at each depth for 2min, completing daily campaigns within  $\pm 15$ min of local noon. To ensure data quality, UV readings from the Baltic Sea site were calibrated with surface measurements (Bentham DTM 300, GB) from Westerland/Sylt, Germany ( $54^{\circ} 55' N$ ;  $08^{\circ} 19' E$ ) taken simultaneously at 14 cloudless days between 05.07.-22.08.01 (meas. C Stick & H Sandmann, Dept. of Med. Climatology, Kiel University, Germany). Diffuse vertical attenuation coefficients of downward irradiance ( $K_d$ ) were determined for each waveband according to Valiela (1995):

$$I_{z2} = I_{z1} e^{-K_d \cdot z_{2-1}}$$

where  $K_d$  is the diffuse vertical attenuation coefficient of downward irradiance between depth 1 and depth 2 with  $1 < 2$ ,  $I$  is the energy of irradiance reaching depth 1 and 2 and  $z_{1;2}$  is the depth where irradiance measurements are done.

*Assemblage sampling* – Mean species cover, mussel abundance, and biovolume were estimated and diversity parameters obtained according to the procedures and assumptions described in *Chapter 4 & 5*. In addition, growth rates were determined as the increment of biovolume/cm<sup>2</sup> between dates. Assemblages were monitored after 21, 42, 63, 77, 84d (SE Atlantic) and 14, 28, 42, 56, 70, 91, 122d (Baltic Sea). At each sampling date, wet weight of assemblages was measured after tiles rested vertically for 1min to allow water to drain. After the experiment, biomass was completely scraped off settlement panels, dried at 60° to constant weight (= DW), weighted, ashed in a or 3h (=AFDW) and reweighted. To avoid anoxic condition under the *Enteromorpha intestinalis* canopy, it was necessary at the Baltic Sea site to trim this green alga down to 1cm above the holdfast in 75% of all plots after days 42, 56, and 70 past sampling. Cut material was stored at –20° C and added to final biomass measurements.

*Statistical analysis* - Homogeneity of variances, transformations, posteriori tests, and Bonferroni corrections were performed as outlined in chapter 4 & 5. T-test was used to test for filter artefacts between unfiltered and PAR+UVA+UVB plots covered with a Perspex filter. To keep the design balanced, procedural controls were omitted from further analysis when non-significant from controls. Using repeated-measures 1-ANOVA (RM 1-ANOVA), I examined radiation effects on change in dependent variables for the complete duration of the experiment. In the context of this analysis, the expression “averaged for each treatment over all sampling dates” was used to indicate that the analysis grouped replicates over time and compared them among treatments. For blocks having no within-block replication, an crude estimate of block effects can be obtained, using mixed model 1-ANOVA in which block was treated as a random factor for which sums of squares were calculated, but not variance ratios (Chapman & Chapman 1999). Radiation was regarded as the independent factor (3 levels, fixed effect). This analysis was used for both the Baltic Sea and SE Atlantic experiment. At the Baltic Sea only, a HUVB treatment was additionally performed. This was differently tested because HUVB plots were pair-wise replicated within blocks. To test for block effects between HUVB blocks 2-ANOVA was used, where block and independent variables were both treated as fixed factors. Under the assumption that no block effects were found independently



for HUVB and remaining treatments, data were analysed together for single sampling dates with 1-ANOVA. All calculations and graphics for ANOVA were performed with the Statistica™ software package.

Similarity of assemblages was analysed at each sampling date using 1-ANOSIM (see *Chapter 4* for details). Subsequently SIMPER tested for the relative contribution of species where significant dissimilarities were found.

### 6.3 RESULTS

*The fouling assemblage* – Table 6-1 lists species by their chronological appearance on plots and with respect to manipulated irradiance regimes. Altogether, 11 and 10 distinct taxa were found at the Baltic Sea and SE Atlantic site, respectively.

At the Baltic Sea, initial recruitment in untreated controls was dominated by algae. Mean algal cover was 134 ±36% (±SD, n = 66) with a relative share of 1:3:12 for *Pilayella*, diatoms and

Table 6-1: List of all species found on plots at both study sites in their chronological appearance. Numbers in parenthesis behind species give week of first appearance. Species without number were encountered at the same week as the species in the adjacent row above. Horizontal bars indicate rows where identical or closely related species were found at both sites. Numbers represent treatments: 1 = HUVB, 2 = control, 3 = PAR+UVA+UVB, 4 = PAR+UVA, 5 = PAR. = species present, = species absent. Species were regarded as present, when mean plot cover >1%.

Baltic Sea						SE Atlantic				
species name	1	2	3	4	5	species name	2	3	4	5
<i>Enteromorpha intestinalis</i> (2)						<i>Enteromorpha intestinalis</i> (3)				
diatoms						<i>Codium fragile</i>				
<i>Pilayella littoralis</i>						unidentified green alga				
<i>Mytilus edulis</i>						<i>Chylocladia capensis</i> (6)				
<i>Ceramium strictum</i>						<i>Ceramium diaphanum</i>				
<i>Balanus spp.</i> (4)						<i>Notomegabalanus algicola</i>				
<i>Ulothrix flacca</i>						<i>Cladophora flagelliformis</i>				
<i>Laomedea flexuosa</i> (6)						<i>Grateloupia filicina</i> (11)				
<i>Polydora ciliata</i> (8)						unidentified bryozoan				
<i>Clava multicornis</i>						<i>Centroceras clavulatum</i> (12)				
<i>Callithamnion corymbosum</i>										

*Enteromorpha*, all decreasing steadily to <10% of total cover in subsequent weeks. For mussels I observed the opposite pattern. At the first two sampling dates they contributed on average 6 ±3%

and  $54 \pm 38\%$  to total cover, respectively. Already one month later, mussel cover was 100%, dominating the substratum throughout the remaining period of the experiment. A third successional pattern was observed for most other invertebrates, especially *Balanus*. Species were rare during the first month ( $<5\%$ ), peaked in the next month (e.g. *Balanus*  $28 \pm 13\%$ ) and were absent at the final sampling date.

Algae dominated the assemblage at the SE Atlantic throughout the study. Again three major successional patterns for individual species were apparent. Initially high abundance of the green algae *Enteromorpha* ( $7 \pm 4\%$ ) and *Codium* ( $50 \pm 40\%$ ) declined steadily to zero until the final sampling date. Contrarily, percent cover of the red alga *Ceramium* steadily increase with time, reaching  $54 \pm 40\%$  at the final sampling date. As an intermediate pattern, the red alga *Chylocladia* occupied plots after its first appearance constantly throughout subsequent succession with  $4 \pm 2\%$ .

**Biomass** – At the Baltic Sea, plots under HUVB accumulated lowest biomass. At the two last sampling dates wet weight was significantly lower under HUVB compared to all treatments (1-ANOVA, *day 91*:  $F_{3,20} = 27.61$   $p < 0.01$ ; *day 122*:  $F_{3,20} = 33.57$   $p < 0.01$ ). Biomass accrual ranged from 16.0g to 36.6g dry weight and was significantly lower on plots under HUVB than ambient ir-

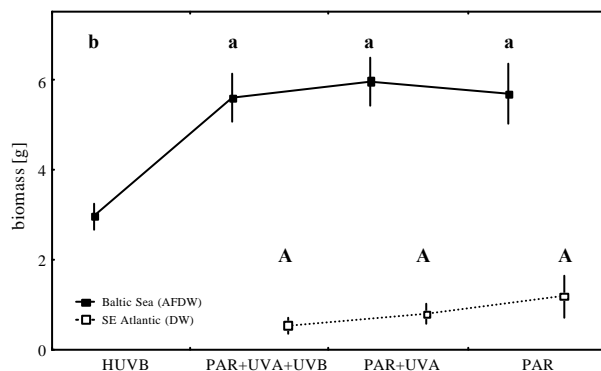

Fig. 6-3: Mean  $\pm$ SE biomass from Baltic Sea (ash free dry weight = AFDW) and SE Atlantic (dry weight = DW) at the end of experiments. Note, plots from both sites had different exposure times (Baltic Sea: 122d, SE Atlantic 84d). Capital and lower case letters at top of graphs indicate treatment differences among final DW and AFDW, respectively. Treatments sharing a letter are not significantly different. No HUVB plots at SE Atlantic.

radiance (1-ANOVA,  $F_{3,20} = 11.25$   $p < 0.01$ ). On average dry weight of HUVB treated plots was 53%, 49%, and 52% of that on PAR+UVA+UVB, PAR+UVA, and PAR plots, respectively. In addition, average AFDW ranged between 2.97g and 5.97g (Fig. 6-3) and was again significantly lower on HUVB plots (1-ANOVA,  $F_{3,20} = 16.97$   $p < 0.01$ ). The relative differences between HUVB and PAR+UVA+UVB, PAR+UVA, and PAR plots were 46%, 43%, and 48%, respectively (Fig. 6-3). At the SE Atlantic site, dry weigh was much lower than at the Baltic Sea ranging between 0.5g and 1.2g. Dry weight was on PAR+UVA+UVB plots 67%, and 45% compared to that on PAR+UVA and PAR plots, respectively. Yet both, dry and wet weight were not significantly different among treatments.

*Diversity H'* - At the Baltic Sea, diversity reached maximum values after 6 weeks and continuously decreased afterwards (Fig. 6-4). Diversity was neither significantly different among treatments when averaged for each treatment over all sampling dates (RM 2-ANOVA,  $F_{3,20} = 1.89$   $p > 0.05$ ), nor was there a significant time x radiation interaction (RM 2-ANOVA,  $F_{18,120} = 1.53$   $p > 0.05$ ). When analysed separately for sampling dates, diversity was twice, after 28 and 42 days significantly lower on HUVB plots compared to plots under the influence of ambient irradiance (1-ANOVA, 28d:  $F_{3,20} = 5.84$   $p < 0.01$ ; 42d:  $F_{3,20} = 16.34$   $p < 0.01$ ). In comparison to the Baltic Sea, diversity was relatively lower at the SE Atlantic. Here initially high diversity first decreased, but increased again during later stages in succession. Thus, diversity followed opposite trends at both sites as succession progressed.

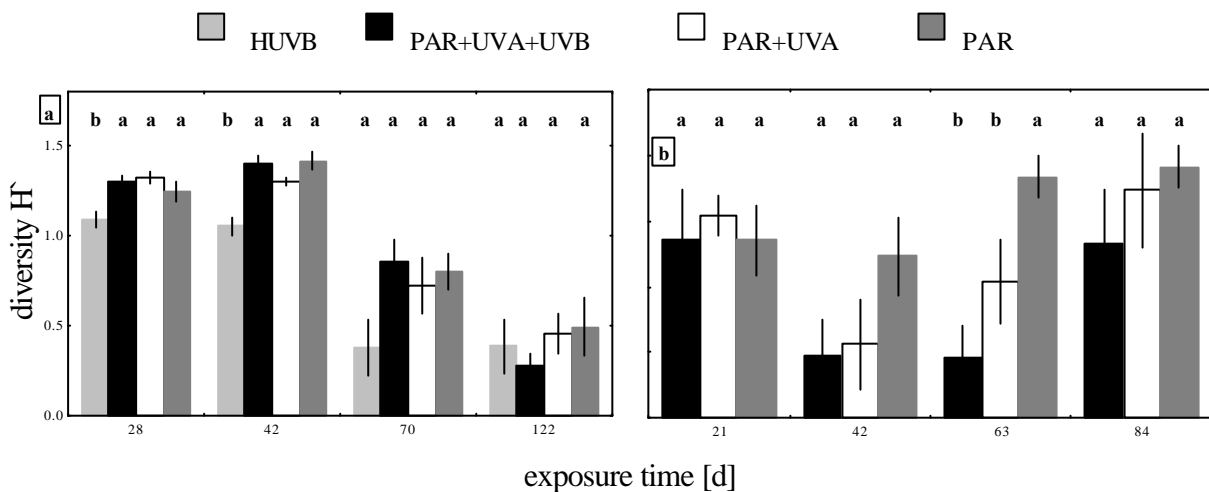

Fig. 6-4: Mean  $\pm$ SE diversity  $H'$  for different sampling dates at (a) Baltic Sea and (b) SE Atlantic. Letters at top of graphs indicate treatment differences among diversity at single sampling dates. Treatments sharing a letter are not significantly distinct.

Just like at the Baltic Sea, diversity at the SE Atlantic was neither significantly different among treatments when averaged for each treatment over all sampling dates (RM 2-ANOVA,  $F_{2,15} = 3.02$   $p > 0.05$ ), nor was a significant time x radiation interaction detected (RM 2-ANOVA,  $F_{6,45} = 1.36$   $p > 0.05$ ). Further analysis of diversity at single sampling dates detected once, after 63d significantly higher diversity on PAR as compared to PAR+UVA+UVB plots (1-ANOVA,  $F_{2,15} = 7.68$   $p < 0.05$ ). While diversity was unchanged on PAR plots for the subsequent 21d, it increased on the other plots, making diversity statistically indistinguishable among treatments, but see also Photos 8 and 9 for extreme differences between PAR+UVA+UVB and PAR treated plots at the final sampling date.

*Evenness* – At the Baltic Sea, a significant and steady decline in evenness during succession, indicated the growing dominance by one or several species (RM 2-ANOVA,  $F_{6,120} = 25.82$   $p < 0.01$ ). Yet, when averaged for each treatment over all sampling dates, evenness was not significantly different among irradiance regimes (RM 2-ANOVA,  $F_{3,20} = 1.44$   $p > 0.05$ ), nor was the time x radiation interaction (RM 2-ANOVA,  $F_{18,120} = 1.37$   $p > 0.05$ ). Analysis of single sampling dates suggest after 42 days significantly lower evenness on plots under HUVB than PAR+UVA+UVB and PAR (1-ANOVA,  $F_{2,15} = 7.68$   $p < 0.01$ ). No further significant differences in evenness among treatments were found.

At the SE Atlantic site initially high evenness dropped to lowest levels before it continuously increased until the end of the experiment. No significant differences among treatments were found.

*Species richness* - At the Baltic Sea, species richness and diversity had a very similar pattern during succession. Species richness increased during the first month and declined significantly afterwards until the end of the experiment (RM 2-ANOVA,  $F_{6,120} = 49.59$   $p < 0.01$ ). When averaged for each treatment over all sampling dates, species richness was not affected by radiation (RM 2-ANOVA,  $F_{3,20} = 1.65$   $p > 0.05$ ), nor the interaction of time x radiation (RM 2-ANOVA,  $F_{18,120} = 1.51$   $p < 0.05$ ). Comparison of species richness at single sampling dates indicated once, after 28 days, significantly fewer species on HUVB than PAR+UVA and PAR plots (1-ANOVA,  $F_{3,20} = 5.36$   $p < 0.01$ ).

At the SE Atlantic, species richness was not significantly different among treatments.

*Percent mussel cover* – Mussels recruited exclusively on plots at the Baltic Sea. When averaged for each treatment separately over all sampling dates, mussel cover was highest on HUVB ( $85 \pm 3\%$ ) and lowest on PAR+UVA+UVB plots ( $66 \pm 6\%$ ). Intermediate mussel cover was found on PAR ( $80 \pm 4\%$ ) and PAR+UVA ( $79 \pm 4\%$ ) plots. Significantly lower mussel cover was found among HUVB plots as compared to PAR+UVA+UVB and PAR+UVA plots (RM 2-ANOVA,  $F_{3,20} = 4.85$   $p < 0.05$ ). Yet, when comparing single sampling dates, mussel cover was not significantly distinct. Lack of significant differences for single sampling dates while an overall radiation effect on mussel cover was detected suggests a trend. Indeed, differences were most pronounced during the first 6 weeks, but after 2 months almost all plots were covered by 100% with mussels.

*Mussel abundance* – Overall mussel abundance (ind./cm<sup>2</sup>) was 47%, 46%, and 48% higher under HUVB than PAR+UVA+UVB, PAR+UVA and PAR, respectively, Fig. 6-5 illustrates strong temporal differences in mussel abundance (RM 2-ANOVA,  $F_{6,120} = 96.41$   $p < 0.01$ ) which were also dependent on radiation regime (RM 2-ANOVA,  $F_{18,120} = 6.31$   $p < 0.01$ ). Initially mussel abundance

did not differ among treatments, ranging between  $65.6 \pm 33.0$  on HUVB and  $56.3 \pm 12.6$  on PAR+UVA+UVB plots. As little as a fortnight later (day 28), mussel abundance was significantly different among treatments, reaching highest values on HUVB plots (1-ANOVA,  $F_{3,20} = 8.41$   $p < 0.01$ ). Average mussel abundance was almost 2.5 times higher on HUVB ( $846.6 \pm 336.8$  ind./cm<sup>2</sup>, maximum 1153) than on PAR+UVA+UVB plots ( $340.1 \pm 136.1$  ind./cm<sup>2</sup>). Mussel density declined monotonously throughout the remaining study period. Differences among treatments were significant until the end of the second month (1-ANOVA, *day 42*:  $F_{3,20} = 6.79$   $p < 0.01$ ; *day 56*:  $F_{3,20}$

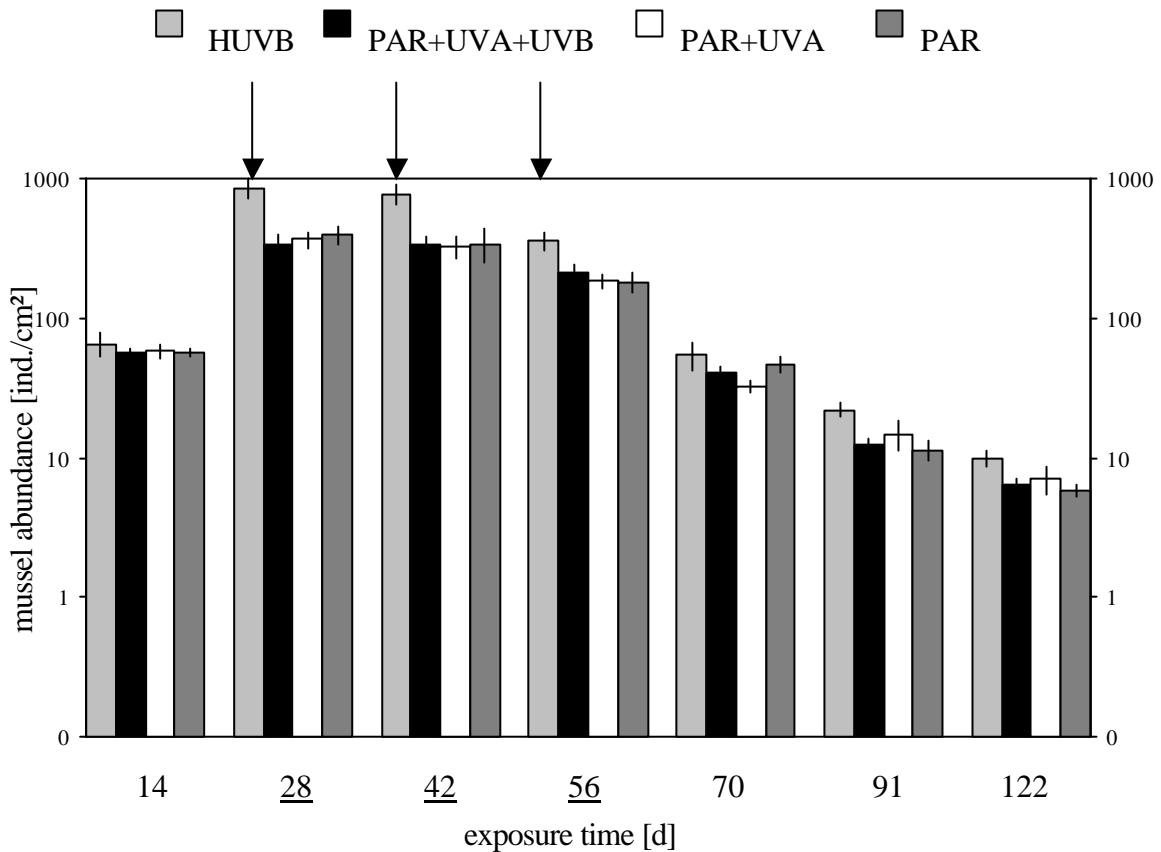

Fig. 6-5: Mean  $\pm$ SE mussel abundance at 7 sampling dates from the Baltic Sea site. Underlined numbers indicate sampling dates and arrows treatments with significant radiation effects. Note logarithmic scale.

= 5.44  $p < 0.01$ ). After day 42, mussels were significantly more abundant under HUVB than all other treatments as well as between HUVB and PAR treated plots after 56 days. Hereafter, no significant differences were found, although e.g. at the final sampling date (day 122), mussel abundance was on PAR treated plots ( $5.8 \pm 1.4$  ind./cm<sup>2</sup>) only 59% compared to HUVB plots ( $9.9 \pm 3.4$  ind.

*Mussel growth* – Growth rates were determined between sampling dates during the first two months. For later sampling dates no data were obtained, due to the difficulties in estimating length of individual mussels without destroying the mussel matrix. Growth rates progressively increased during succession, with the strongest growth increment between days 42 and 56 in all treatments (Fig. 6-6).

For any given sampling date, no significant differences in growth rates were found among treatments. Nevertheless, there was a tendency of highest growth increments on HUVB plots at each sampling date.

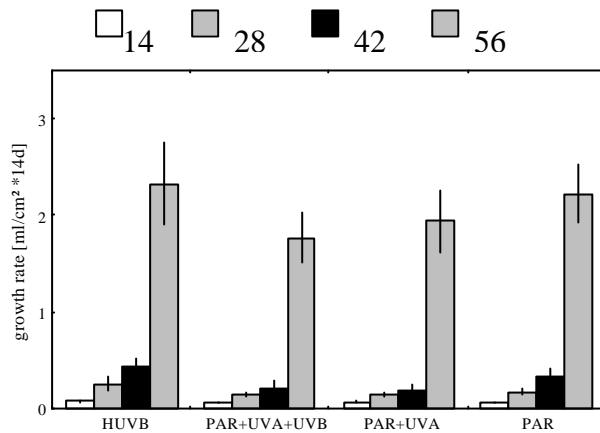

Fig. 6-6: Mean  $\pm$ SE mussel growth rates grouped by treatments to compare progress during succession. Numbers in legend refer to days since initiation of experiment. Only sampling dates from the first 2 months were chosen, due to increasing complexity of mussel matrix for reliable estimation of mussel length.

*Mytilus* vs. *Enteromorpha* cover – After 28 days, *Enteromorpha* coverage was significantly higher on HUVB than PAR plots (1-ANOVA,  $F_{3,20} = 6.42$   $p < 0.01$ ). In addition, a trend for higher *Enteromorpha* cover on PAR+UVA+UVB and PAR+UVA compared to PAR plots was apparent (HSD  $p < 0.07$ ). Mussel and *Enteromorpha* cover followed a similar trend, for which a significant positive correlation was detected at day 42 (Spearman-rank,  $R = +0.48$   $p < 0.05$ ).

*Species composition* - Radiation significantly affected species composition at the Baltic Sea after day 28 (1-ANOSIM,  $R = 0.261$   $p < 0.05$ ) and 42 (1-ANOSIM,  $R = 0.256$   $p < 0.05$ ). Posteriori pairwise comparison revealed that assemblages on HUVB and PAR+UVA plots were significantly different in species composition after day 28, while HUVB and PAR+UVA+UVB plots were significantly dissimilar after 42 days. Highest contribution to dissimilarity could be assigned at day 28 to the annual algae *Pilayella* (48% for HUVB vs. PAR+UVA). Two weeks later, at day 42, diatoms contributed 40% to dissimilarity between assemblages on PAR+UVA+UVB and HUVB plots. Afterwards, no significant dissimilarities were found between assemblages under different radiation regimes. At the SE Atlantic, species composition was not different among treatments.

## 6.4 DISCUSSION

At both sites, UV lowered diversity during early stages of succession. While ambient UV was sufficient for an adverse impact on the fouling assemblage at the SE Atlantic, enhanced UVB was required at the Baltic Sea. Observed radiation effects were non-persistent, diminishing within the first two months of succession. Opposite temporal patterns in diversity developed at both sites, sug-

gesting different successional patterns or distinct mechanisms for radiation effects on assemblage structure.

Results from the Baltic Sea indicate that ambient UV does not necessarily represent a biologically harmful agent. Support comes from several workers who failed to detect effects of ambient UV on lotic periphyton assemblages (Hill et al. 1997, DeNicola & Hoagland 1996). However, assemblages used in the experiment of Hill et al. (1997) might have been preconditioned as naturally grown 1y old assemblages were used. Indeed, UV protective responses that mitigated harmful UV effects were demonstrated in periphyton assemblages. UV blocking species served on the outer sheets as sunscreens for the entire assemblage below (Karsten et al. 1998). Moreover vertical migration of UV sensitive species down into the matrix was experimentally shown as a response to ambient UV levels (Sundbäck et al. 1996). Missing UV effects were brought in relation with high levels of dissolved organic carbon (DOC) (Kiffney 1997). Yet experimental evidence exists that periphyton biomass accrual is enhanced when DOC levels are low (Bothwell et al. 1994, Kelly et al. 2001), due to indirect grazer effects. Thus UV per se will not adversely affect assemblages, in spite of detrimental UV effects on individual species in isolation.

Ambient UVA alone did not affected diversity at the SE Atlantic site, while diversity at the Baltic Sea was only reduced under enhanced UVB conditions. Thus further reductions in ozone levels may represent a threat for the assemblages from both sites, as ozone selectively absorbs UVB (Caldwell et al. 1989). Although UVA was not harmful to assemblage structure in my experiments, evidence about detrimental UVA effects comes from e.g. primary productivity studies on phytoplankton (Bühlmann et al. 1987) and altered consumer-prey interactions in microbial food webs (Ochs & Eddy 1998). On the other hand, UVA is known to reduce detrimental UVB effects, e.g. by stimulation of DNA repair mechanisms in alga (Williams 1979, Franklin & Forster 1997) and zooplankton (Zagarese & Williamson 2000), suggesting this may be a reason why UVA alone could have been without effect in my experiments.

UV effects were non-persistent in assemblages from the Baltic Sea and from the SE Atlantic, indicating some sort of compensatory mechanism or adaptation. Lack of long-term UV effects were also reported for periphyton (Bothwell et al. 1993, Santas et al. 1998b) and marine fouling assemblages (Binding 1999, Langer 2001). Changes in species composition from UV sensitive to UV resistant species may explain such temporal patterns. Indeed, Rader & Belish (1997) observed a shift in UV exposed periphyton assemblages from species without mucopolysaccharides on their outside to species producing such coatings. The authors assumed, but did not explicitly tested, that this coat-

ing shielded diatoms from detrimental UV radiation. Alternatively, the production of UV screening substances, e.g. mycosporine-like amino acids (MAA's) has been shown to counteract damaging UV effects in e.g. planula larvae (*Agaricia agaricites*) (Gleason & Wellington 1995) or macroalgae from all regions (Wängberg et al. 1996, and references therein).

Alternatively to changes in species composition or adaptations, radiation dependent recruitment rates may explain non-persistence of significant differences in diversity among radiation treatments in my experiment at the Baltic Sea. One month (28d) after initiation of the experiment, i.e. mid-July, mussel abundance was disproportionately higher on HUVB treated plots, reducing here diversity significantly. Presumably an recruitment enhancing effect of the green alga *Enteromorpha* drove this pattern. *Enteromorpha* had its highest cover on HUVB plots, coinciding with its appearance in very shallow water at the study site (per. observation). Like in the experiment from 2000, concentrations of multi-layered clumps of small (<1mm) mussels were observed next to algal holdfasts. Further a positive correlation between *Enteromorpha* and mussel cover confirmed the previously observed pattern (*chapter 5*). My result corroborate the assumptions of the facilitation model, (Connell & Slatyer 1977) in which a sequence was identified how resident species modify a site to support settlement and growth of other species. Differences in diversity disappeared by the end of the second month, coinciding with strong increases in mussel growth rates. Self-thinning quickly lowered overall mussel abundance and diminished its differences among treatments. As a result, mussels covered all plots irrespective of radiation regime to 100% within 56 days after initiation of the experiment, opposing results from the previous year when mussel cover was low. Thus mussel dominance was strong enough to equalize assemblage structure and species composition across radiation regimes to a degree that no further significant differences could be found. Besides differential recruitment rates, significantly less species recruited on HUVB plots after 28 days. This difference did not persist, because mussels excluded other species beginning with day 56.

At the SE Atlantic, lower species richness on PAR+UVA+UVB plots due to adverse UV impacts produced a simultaneous pattern of significantly lower diversity as compared to plots without UV influence within the first two months of succession. However, differences in diversity among radiation treatments were no longer apparent later in succession. A shading role by the red alga *Ceramium diaphanum* is suggested to mitigate damaging UV levels on the respective plots. Abundance of this red alga inclined constantly across all treatments, indicating its UV resistance. In addition, progressively more substrate was sheltered from UV as assemblages aged, increasing suitable settlement area for UV sensitive species. Indeed, two species, *Cladophora flagelliformis* and *Cen-*



*troceras clavulatum*, recruited three weeks earlier on PAR as compared to PAR+UVA+UVB and PAR+UVA plots. At the time when both species settled on UV exposed plots, *Ceramium* covered on average 40% of the respective substrata. Yet species e.g. the unidentified bryozoan were still restricted to recruit on UV sheltered plots, suggesting *Ceramium* cover was still too little to enable the more UV sensitive species to recruit on UV exposed plots. The role of canopy forming species to facilitate settlement and recruitment of UV sensitive species by shading substratum is corroborated from other studies on both macro- (Santas et al. 1998b, Langer 2001) and microalgae (Karsten et al. 1998).

Despite different processes at both sites, the ecological relevance of UV was transient in both systems. Past emphasis on UV as an ecological factor was probably overestimated since many studies, primarily on phytoplankton productivity were based on short term experiments (Smith et al. 1992, Holm-Hansen et al. 1993) or used non-replicated experiments (Jokiel 1980). Detrimental UV effects known for single species are clearly not transferable to more complex ecological structures, i.e. assemblages. As long as one or several species can cope with damaging UV, assemblages seem to be protected. Results from both sites demonstrate that indirect effects can mediate such buffering mechanisms. Moreover, it seems reasonable to preserve species diversity, since this will increase the chances for assemblages to contain at least one species which can withstand stressful agents. Thus the results from my experiments support the insurance hypothesis (Lawton & Brown 1993, Lawton 2000).

However, the puzzling discrepancy in assemblage succession between 2000 and 2001 at the Baltic Sea remains an open question, in spite of comparable initial recruitment patterns for *Enteromorpha* and mussels. The experiment in the next chapter was intended to test for the impact of grazers in that context.

In conclusion, diversity and species composition were adversely impaired under the influence of UV. Ambient radiation of the entire UV range was sufficient to do so in the SE Atlantic experiment, but enhanced UVB was needed at the Baltic Sea experiment. Detrimental UV effects were non-persistent and the mechanisms which adjusted early successional effects at a later point in time were not the same at both sites.

## 7. COMPARING RADIATION-CONSUMER INTERACTIONS BETWEEN BENTHIC ASSEMBLAGES FROM THE BALTIC SEA AND SE ATLANTIC

### 7.1 INTRODUCTION

Mesograzers, e.g. gammarids, are generally able to structure benthic assemblages (Brawley & Adey 1981, Duffy & Hay 2000). This has also been documented in the vicinity of my study site at the Baltic Sea. Experiments showed a close trophic link between the abundance of the green alga *Enteromorpha intestinalis* and gammarids (Worm 2000), as well as a structuring effect due to a strong consumer preference for this alga over the brown alga *Pilayella littoralis* (Lotze & Worm 2000).

An interaction between consumer and radiation effects on benthic assemblage structure seems plausible for two reasons. First, UV may affect consumer impact (Ochs 1997, Ochs & Eddy 1998, Williamson et al. 1999), if benthic invertebrates are susceptible to UVB. Depending on the consumers present, UV effects on consumption will vary (Williamson et al. 1999). For instance, protective casings shelter snails to a greater extent from damaging UVB as “naked” mayfly nymphs or midge larvae (McNamara & Hill 1999). Secondly, as food quality may change following UV exposure, palatability of algae increases (Pavia 1997) or decreases (Cronin & Hay 1996, van Donk 1997, Hessen et al. 1997).

To date, experimental evidence about interactions between radiation and consumers is almost completely missing for marine benthic assemblages. Potentially UV sensitive algae and consumers, e.g. diatoms, chironomids, and the isopod *Idotea baltica*, were encountered at one or both sites of this study. Algae from both sites hold an important shading and recruitment enhancing role, causing distinct diversity patterns between UV treatments during early (<70d) successional stages (see *Chapter 6*). If these or other algae were part of the grazers diet, altered UV effects on assemblages in the absence of consumers could be the consequence. In comparative field experiments I tested for the interactive effects of radiation and consumers on the recruitment and succession of fouling assemblages at two study sites.

### 7.2 MATERIAL AND METHODS

*Experimental set-up* – In a 2-factorial complete randomised blocks design I examined the effects of irradiance and consumers on the structure of a fouling assemblage at the Baltic Sea and SE

Atlantic (Fig. 7-1). Using cut-off filters, ambient UV was either blocked (= -UV) or could pass filters unchanged (= +UV). Only at the Baltic Sea, as a third treatment, UVB lamps were used to double ambient UVB levels (= HUVB) (for all treatment levels n = 6). Filter artefacts were already analysed (*Chapter 6*) by comparison of unfiltered plots and plots covered with filters transmitting the entire solar spectrum. For detailed description of optical properties of used filter materials and lamps see “*Material and methods chapter 6*”. For set-up of lamps and control of proper function refer to “*Material and methods Chapter 5*”.

Consumers were excluded from plots (= cage treatment) or allowed access to plots (= open treatment and partially open as treatment control). The same kind of transparent polycarbonate container (100x100x100mm) used for open plots in chapter 6 was used here. At the Baltic Sea, polyethylene mesh (1mm) was fixed over 3 or 4 side walls to obtain partial or complete cages, respectively. At the SE Atlantic, as many holes (Ø4mm) as possible were drilled in 3 (= partially open) or 4 side walls (= cage). The fourth wall of partially open plots was completely cut out to allow consumer access. Partially open and caged plots of the +UV and -UV radiation regimes were located in the four remaining openings on rafts (see “*Material and methods Chapter 6*”. In addition to open plots, partially open and caged plots of the HUVB regime were randomly positioned in duplicate along platforms at the Baltic Sea site.

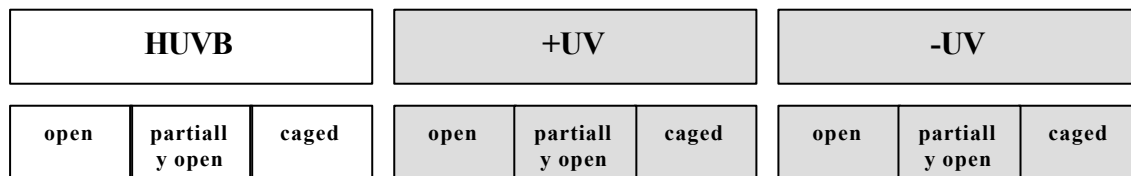

Fig. 7-1: Balanced experimental design (n = 6). Open and partially open plots were compared to test for cage artefacts. Three radiation levels were produced (1) enhanced UVB (=HUVB), (2) +UV (= PAR+UVA+UVB) and (3) -UV (= PAR). Treatments highlighted in light grey were performed at the SE Atlantic site only.

*Assemblage sampling* – Identical procedures, like those described in chapter 6, were employed for all plots of this experiment. In addition, I determined chironomid abundance (ind./cm<sup>2</sup>). Only tubes inhabiting alive chironomids were recorded. Remaining consumers were almost exclusively motile crustaceans, which could not be quantified. However, their abundance was estimated to be approx. 25-50 ind./cm<sup>2</sup>, depending on the season, with higher abundances during the first half of the experiment.

*Statistical analysis* – Procedures testing for homogeneity of variances, block and filter artefacts were identical to those outlined in chapter 7. 2-ANOVA examined the effects of

manipulating radiation (SE Atlantic 2 and Baltic Sea 3 levels, fixed), consumers (3 levels fixed) and radiation x consumption interactions (SE Atlantic 6 and Baltic Sea 9 levels, fixed) on change in dependent variables for each inventory separately. The level of significance was corrected according to Bonferoni method (see ‘*Statistical analysis Chapter 6*’). Where significant differences were found, Tukey honest significant difference test (HSD) tested for differences within groups.

### 7.3 RESULTS

Radiation effects were identical to those obtained from 1-ANOVA (*Chapter 6*), although the PAR+UVA treatment was missing in the 2-ANOVA and the employed sample size per treatment level was higher.

*The fouling assemblage* – Generally, caging did not alter number or identity of species. Only at the SE Atlantic site, one species, the red alga *Chylocladia capensis*, was found on caged +UV plots whereas it was absent on open +UV plots.

*Biomass* – When averaged over all +UV and –UV treatments, biomass accrual was 5.75 times higher at the Baltic Sea than the SE Atlantic site (t-test,  $t_{1,46} = 12.13$   $p < 0.01$ ; Fig. 7-2). Wet weight on caged plots was  $73.1\% \pm 30.5$  compared to consumer accessible plots, but differences at single sampling dates were not significant before day 91 (2-ANOVA, *day 91*:  $F_{2,45} = 26.65$   $p < 0.01$ , *day 122*:  $F_{2,45} = 87.62$   $p < 0.01$ ; Fig. 7-2). Patterns from wet weight data were consistent

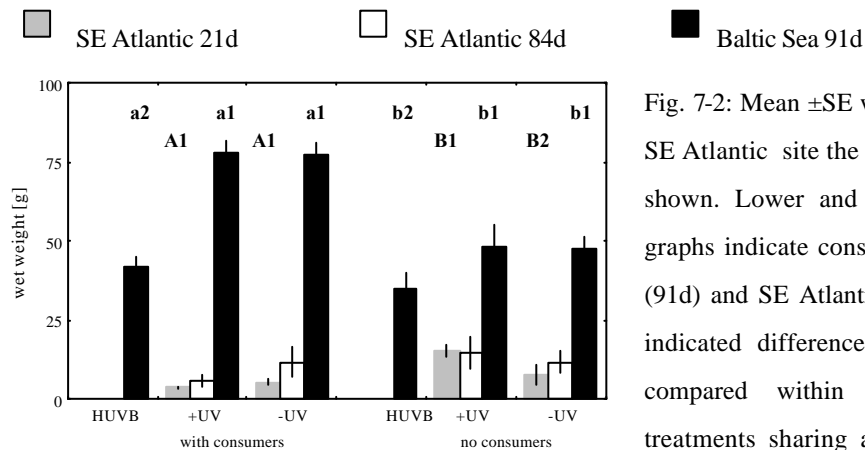

Fig. 7-2: Mean  $\pm$ SE wet weight at both sites. For the SE Atlantic site the first and last sampling dates are shown. Lower and capital case letters at top of graphs indicate consumer effects among Baltic Sea (91d) and SE Atlantic (21d), respectively. Numbers indicated differences among radiation treatments, compared within the same consumer level: treatments sharing a symbol were non-significant. For clearness, letter code for treatments at SE Atlantic 84d was omitted (all n.s.). HUVB = enhanced UVB, +UVB = PAR+UVA+UVB, -UV = PAR.

with those from dry weight (DW) and ash free dry weight (AFDW) as the final biomass measures. Biomass accrual was enhanced in the presence of consumers (2-ANOVA, *DW*:  $F_{2,45} = 20.40$   $p < 0.01$ ; *AFDW*:  $F_{2,45} = 21.00$   $p < 0.01$ ). The data did not confirm a dependency of radiation effects

on consumer levels for AFDW (2-ANOVA,  $F_{2,45} = 2.39$   $p > 0.05$ ). At the SE Atlantic, consumer effects on biomass were negligible. Only during early successional stages (Fig. 7-2), consumers significantly reduced wet weight (2-ANOVA,  $F_{2,25} = 14.77$   $p < 0.01$ ) by 63%. This consumer effect was significantly enhanced by UV radiation (2-ANOVA,  $F_{2,25} = 72.53$   $p < 0.01$ ).

*Diversity parameters* – At one instance, after 42 days, radiation and consumers interacted. Diversity on uncaged plots was significantly lower under HUVB than under other radiation regimes and opposite for caged plots (2-ANOVA,  $F_{4,45} = 7.87$   $p > 0.01$ ). At the SE Atlantic, no interaction between radiation and consumers was detected.

*Chironomid abundance* (Baltic Sea site only) - Chironomids were  $4.7 \pm 3.6$  and  $4.3 \pm 3.0$  times more abundant under HUVB compared to PAR+UVA+UVB and PAR, respectively (2-way ANOVA,  $F_{2,45} = 66.17$   $p < 0.01$ ). The abundance of chironomids was non-significant between open and caged plots (Fig. 7-3a), indicating insufficient exclusion. A significant radiation x consumer interaction (2-way ANOVA,  $F_{4,45} = 3.71$   $p < 0.01$ ) revealed higher chironomid abundance on open compared to caged -UV plots, but the opposite on HUVB plots (Fig. 7-3b).

## 7.4 DISCUSSION

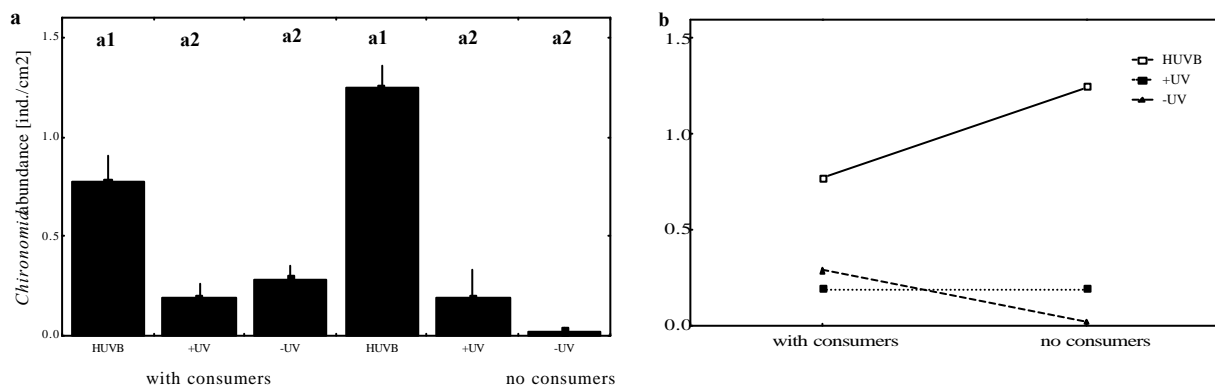

Fig. 7-3: (a) mean  $\pm$ SE chironomid abundance after 28 days radiation exposure. Letters and numbers above columns indicate consumer and radiation effects of 2-ANOVA, respectively: treatments sharing a symbol are not significantly distinct. (b) plot of means. Interpretation of radiation treatments as in Fig. 7-2.

Generally, consumer effects were few and of minimal effect at the Baltic Sea site, and completely missing from the SE Atlantic. Interactions between consumers and radiation were rarely found at both sites. My results from the Baltic Sea suggest an enhancing effect of HUVB for abundance of midge larvae (Chironomidae).

Assessing the UV sensitivity of consumers is important for the interpretation of radiation x consumer interactions. Midge larvae (Chironomidae) were the only consumer species for which UV

sensitivity could be assessed in my experiments. Their average abundance was comparable to other studies, reporting ranges between 0.05 – 2 ind./cm<sup>2</sup> (Tatrai 1988, Drake & Arias 1995). Higher chironomid larvae abundance on HUVB plots as reported in this study, is opposite to laboratory and mesocosm findings from previous studies (Bothwell et al. 1994, McNamara & Hill 1999). Yet my results are corroborated by the work of Rader & Belish (1997). They identified cryptic daily behaviour in response to predators and case building as potential mechanisms for reducing detrimental UV impacts. Perhaps, species specific susceptibility of midge larvae, or differences in the blocking efficiency of chironomid tubes can explain differences between the experiment of Bothwell et al. (1994) on the one hand and Rader & Belish (1997) or this study on the other hand.

*Radiation x consumer interactions* – There were generally few radiation x consumer interactions at both sites. Diversity on open plots from the Baltic Sea site was after 42 days lower under HUVB than +UV and –UV regimes, but the opposite pattern was found on caged plots. To my knowledge only one other study tested for interacting effects between radiation and consumers on marine fouling assemblages (Lotze et al. 2002). Like in my experiments, radiation x consumer interactions were almost completely missing in their study, however, Lotze et al. (2002) were able to detect radiation-consumer interactions during later times in succession, i.e. after 3 months, whereas in my experiment the effects were restricted to the first 6 weeks. Dominance of mussels at the Baltic Sea site appeared to be the major cause for muting interactive effects between radiation and consumers. Moreover UV seemed to be without effect on the abundance of most consumer species, although chironomid larvae were significantly more abundant on HUVB plots after the first month of succession. Nevertheless, neither diatom, nor macroalgae cover was significantly different between radiation treatments, indicating no net effect of this grazer species on assemblage structure, despite significant differences in grazer abundance among radiation treatments.

At the SE Atlantic site, biomass, i.e. wet weight, was affected by a significant radiation x consumer interaction. UV radiation was without effect on wet weight in the presence of consumers, but without consumers, UV enhanced biomass accrual. This stands in opposition to other findings (Bothwell et al. 1994, Kelly et al. 2001). In their freshwater flume experiments, diatoms biomass was significantly lower on plots with consumer access when UV radiation was blocked compared to UV exposed plots. In both studies it was suggested that the high UVB sensitivity of consumers (chironomid larvae) reduced grazing pressure on the diatom biomass relatively stronger than UVB reduced biomass directly. Such a compensatory effect was absent in the assemblages from the SE Atlantic site, presumably because consumers were not adversely affected by UV radiation. In

laboratory experiments, McNamara & Hill (1999) showed species-specific susceptibility to UVB among consumers. Indeed, in their study chironomids were more strongly damaged by UVB than other consumer species. Though never tested, the carapace of crustaceans should be a very effective UV protection, what could explain the different assemblage responses for the interacting effects between radiation and consumers of this and previous studies.

In conclusion, interactive effects between radiation and consumers were rarely detected at both study sites and non-persistent, disappearing within the first 6 weeks of succession. The data suggest first that fouling species seem to be well adapted to given irradiance and consumption regimes. Secondly, consumers may not be adversely affected from ambient and enhanced UVB (Baltic Sea site only) levels.

## 8. GENERAL DISCUSSION

This study was intended to test by manipulative field experiments the ecological relevance of emersion and ultraviolet radiation (UV) attaching importance to the “Intermediate Disturbance Hypothesis” (IDH) for shallow water fouling assemblages. In this final chapter, I discuss (1) my experimental set-up, and (2) the results between the different IDH experiments. Further I (3) develop an overall model and (4) incorporate the model into existing concepts. This sequence will be repeatedly used, first in the context of the IDH and secondly of the ecological relevance of UV radiation. Finally, I propose an integrated approach to increase the relevance, reliability, and forecasting value of results from ecological studies.

### THE INTERMEDIATE DISTURBANCE HYPOTHESIS (IDH)

At first glance, my experiment deviated twofold from the definition of disturbance, offering space for criticism. First, disturbance may not explicitly applied through the destruction of biomass (*sensu* Grime 1977). In a supporting experiment (“Larval supply”, chapter 4) I clearly demonstrated for emersion treatments that indeed biomass was destroyed as a consequence of the applied disturbance. The absence of mussels and lower species number in the longest emersion treatment (12h) could not be attributed to a reduction in recruitment, but to disturbance. In like manner, the loss of species in HUVB treatments can be regarded as a loss of biomass. Second, disturbance regimes were not stochastically, probably allowing species to adapt to the periodic exogenic force. This notion may be for three reasons of minor relevance because (1) species from the investigated assemblage have very different biological traits, e.g. generation times. An emersion event of 2h is relatively short when compared for the live span of e.g. mussels, but rather long for other species e.g. bacteria. In contrast, results from phytoplankton assemblages support the importance between generation time and the duration or frequency of disturbance in the context of the IDH (Gaedeke & Sommer 1986, Flöder & Sommer 1999). Generation times of e.g. diatoms vary greatly, even within the same species (e.g. Armstrong et al. 2000), but may be for a given disturbance regime of relatively narrow range when compared to the variability of generation times among species that constitute a fouling assemblage of the kind which I studies in this thesis. (2) the effects of disturbance are usually not restricted to act in one dimension on an organism. For instance, emersion can affect individuals in many harmful ways, e.g. heat, desiccation, reduced feeding time for suspension feeders, lowered salinity on rainy days and higher irradiance levels, to name a few. It seems very unlikely that species



can adapt simultaneously to multiple periodic forces. Finally the experiment probably did not last long enough to let any adaptations become effective.

Partly my results support the original IDH assumptions. At least five variability sources, discussed below, were identified which may alter assemblage responses along a disturbance gradient.

(1) *annual variability* (1998 vs. 2000) - I observed distinct diversity patterns along comparable emersion gradients between two years. While a unimodal diversity pattern was apparent in the emersion regimes in 1998, diversity declined steadily in 2000. In both years, harsh conditions reduced diversity, corroborating the model of Kondoh (2001). His model predicts a consistent shift of the diversity peak towards more benign disturbance conditions as productivity levels fall, without a change in the unimodal pattern, except at the utmost lowest or highest productivity levels. In 2000, the productivity level of the system at the Baltic Sea site can be assumed as relatively low, since mussels, barnacles and algae abundance was about 1/10 and 1/3 that of 1998. Thus, the situation between years could represent different productivity states of the Kondoh-model. In 2000, a monotonous decline in diversity was apparent along the emersion gradient, as suggested by the Kondoh-model, for very low productivity levels. Further, the missing reduction of diversity through competitive exclusion under benign conditions in 2000 lies well in line with the original IDH model (Connell 1978), because the colonization rate of the dominant competitor – the blue mussel - and the second best competitor – barnacles - was severely reduced, slowing down monopolization of the substrate by one or a few species.

Experiments were initiated at different seasons with respect to mussel spat falls. In 1998 the experiment was initiated at the beginning of August, when veliger larvae were still available for settlement. In 2000 the experiment started at the end of April, several weeks before mussel spat fall. A comparison of assemblage structure after successional periods of equal time between both years, i.e. 70 and 90 days after initiation of the experiment, should result inevitably in different assemblages with respect to mussel dominance. Yet in 2000, the diversity pattern never approached a humpbacked curve, even when the duration of the experiment was extended to the same season as in 1998, i.e. until the end of October. Thus 2000 has to be assumed a year of lower productivity levels, unless fouling assemblages were founder controlled, what seems unrealistic due to the strong competitive abilities of mussels. Variable intensity of recruitment seems to be the determinant for the contrasting outcome of the diversity response between both years. Variability in recruitment of important species has been suggested to severely impair prediction of assemblage structure (Gaines & Roughgarden 1985, Underwood & Fairweather 1989). Differ-

ences in transport of larvae, i.e. flushing times of bays, was described as one source of variability in recruitment (Gaines & Bertness 1992). Accordingly, higher precipitation in 1998 than 2000, should enhance recruitment due to less strong flushing events. Yet the opposite was found, suggesting that precipitation was without significant effect on flushing events and hence recruitment. None of the remaining abiotic factors which were recorded in both years, humidity, water and air temperature was likely to account for low mussel abundance on control panels, because differences between years were statistically significant but small in absolute terms (see chapter 2, Fig. 2-3). Other, perhaps more impacting sources for variation in recruitment between both years may be (1) availability of food for larvae, (2) altered activity levels of pelagic predators, and (3) changes in mismatch between consumers and prey.

(2) *disturbance modulation* – The IDH was postulated to function in both, intensity and frequency modulated disturbance regimes. In 1998, both frequency and intensity treatments produced a unimodal diversity response along the emersion gradient. Diversity declined stronger in the harsh part of the intensity modulated gradient compared to frequency treatments of the same cumulative daily dose. Although the diversity response was dependent on the type of application, the unimodal diversity pattern was apparent along intensity and frequency treated emersion gradients. This finding is corroborated by experiments of McCabe & Cotelli (2000) who were unable to show a significant interaction among disturbance factors, despite significant intensity effects on the investigated stream macroinvertebrate assemblage. While the analysis of Flöder & Sommer (1999) did not allow to test for an interaction term, it strongly suggests that the way disturbance is applied will have an effect on the response pattern.

(3) *variation with disturbance quality* (emersion vs. UV radiation) – A synoptical comparison between different disturbance qualities represents a novel aspect in testing the IDH. In 2000, the only year when both disturbance agents were simultaneously applied, a unimodal diversity response was found along the UVB disturbance gradient, but not for emersion. Changes in the diversity response of the assemblage between emersion and UV treatments, suggest different mechanisms producing such patterns. Ambient UV was found to be detrimental to most species investigated (reviewed in Wängberg et al. 1996, Häder et al. 1998), yet in this study it indirectly favoured recruitment for dominating mussels via a vigorously expanding algal canopy. This canopy, produced by the green alga *Enteromorpha intestinalis*, increased steadily from controls to the longest exposure time of enhanced UVB. Though no UVB measurements were performed under the canopy, I assume that UVB regimes could differ between treatments in that way that

UVB conditions on controls and plots of longest daily enhanced UVB exposure ( $8h^{d-1}$ ) were most severe and benign, respectively. Thus it could be further speculated that in my experiments, UV and emersion impacts were of opposite sign along the disturbance gradient with regard to the competitive dominant species – the blue mussel. Therefore it seems difficult to relate the measure of an imposed force on the system, i.e. enhanced UVB or emersion in this study, to the sign, let alone extent of its impact. This reveals one of the principle weaknesses of the IDH concept, concerning the recognition of disturbance as it was discussed previously (Reynolds et al. 1993, Sommer et al. 1993).

- (4) *persistence of effects* – Irrespective of the disturbance quality, effects were non-persistent. Temporally limited occurrence of unimodal diversity responses further complicate the predictability of disturbance effects along a gradient. Yet differences were obvious between both disturbance qualities. Diversity under harsh conditions and controls gradually approached that on moderately disturbed plots, as a result of increasing species richness and evenness.
- (5) *diversity parameter* – The choice of diversity parameter was of major importance for the confirmation or rejection of the IDH. Other than diversity, neither species richness, nor evenness ever followed a unimodal pattern in my experiments. Likewise, Flöder & Sommer (1999) confirmed a unimodal response for phytoplankton diversity under a frequency and intensity modulated nutrient enhancement gradient, but for species richness this pattern was produced only in frequency treatments. In the review of Mackey & Currie (2001), studies using diversity confirmed a peaked disturbance-diversity relation most and evenness least often.

The results of this study suggest two things. First, an assemblage response along a disturbance gradient will not inevitably result in a unimodal pattern although the system was indeed shown earlier to respond that way. Two factors causing variability in diversity responses, (1) annual variability, and (2) disturbance modulation, were modelled to predict response patterns along the emersion gradient. The bold line in Fig. 8-1 represents conditions for IDH to generate a unimodal diversity response, e.g. after 70 days in 1998. At that year, productivity levels of the system, e.g. supply of dispersal stages, were high enough to allow mussel dominance at a low emersion gradient, while harsh environmental conditions at the other end of the disturbance gradient caused lower diversity. Inter-annual variability (1) acted more on the diversity response left to the peak due to impacts on recruitment. The stippled line features the diversity response in 2000, when productivity levels were lower than in 1998. At that year, diversity did not decline under more benign conditions because

mussels were unable to dominate the substratum as a result of reduced recruitment. To the right of the peak, i.e. towards harsh environmental conditions, the diversity response of the assemblage was strongly influenced by the disturbance modulation (2). Environmental conditions were harder under intensity than frequency treatments of comparable cumulative daily emersion, resulting in a stronger decline in diversity for intensity treatments. The total range of diversity responses influenced by disturbance modulation was smaller than that caused by interannual variability, because diversity was always reduced under harsh conditions, but not under benign conditions in low productivity years. The pattern outlined in Fig. 8-1 represents the response range of assemblage diversity for an early successional assemblage. Non-persistence of this pattern for later times in succession indicates that further processes, e.g. competition will alter the diversity response along the disturbance gradient.

Secondly, my results extend the mechanisms which Connell (1978) predicted for the genera-

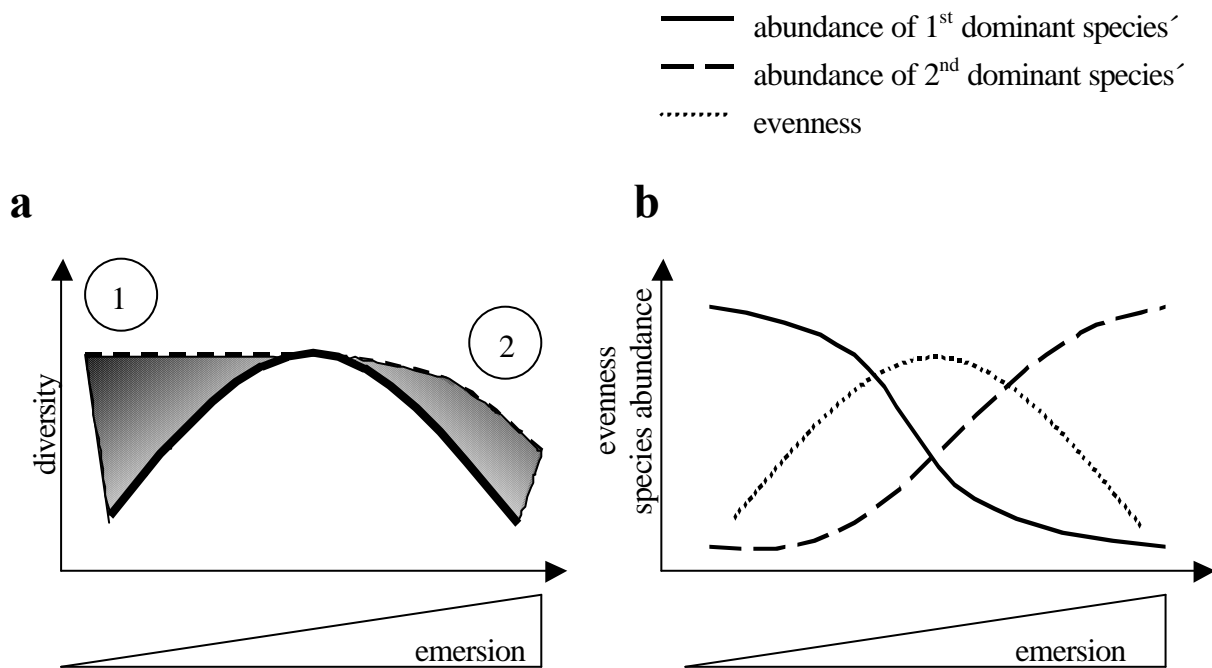

Fig. 8-1: (a) Schematic to illustrate extent and sign of effects from (1) inter-annual variability (1998 vs. 2000), and (2) disturbance modulation (intensity vs. frequency) on diversity along a disturbance gradient at an early successional stage, e.g. after 70 days of emersion. The greyish area between the bold humpbacked line (=1998) and the stippled line (=2000) indicates the range of possible diversity responses, between both years. The more dark the area, the greater the deviation from the unimodal response. See text for details. (b) Process by which a unimodal evenness response was generated along the emersion gradient. Changes in dominance between two species groups named 1<sup>st</sup> dominant = blue mussel and barnacles and 2<sup>nd</sup> dominant = algae. Both groups have highest abundance at opposite extremes of the disturbance gradient. See text for details. Triangles below graphs indicate the emersion gradient.

tion of a unimodal pattern. Whichever disturbance one considers, it can not be expected to affect each assemblage constituent in the same manner. For instance, species richness was constant along the disturbance gradient, because algae (e.g. diatoms, *Chaetomorpha aerea*, *Enteromorpha intestinalis*) were not adversely affected when emersed for times up to 12h, i.e. the most intense disturbance applied. Instead, algae (= 2<sup>nd</sup> dominant) could occupy space which was made available by the decline of mussels (= 1<sup>st</sup> dominant). Thus a change in dominance and its concomitant decline in evenness rather than harshness of the environment was responsible for lowered evenness for longest emersion (Fig. 8-1b). Because species richness was unaffected by emersion treatments, the diversity response of the assemblage will match the evenness response along the emersion gradient closely.

My models indicate for some factors how in a given system disturbance can strengthen or reject the predictions of the IDH and that there seems to be more than the processes postulated by Connell to achieve unimodal patterns. This finding has strong impact on the great number of studies rejecting the IDH. To date a limited number of studies tested the IDH thoroughly. Either investigations were correlative (e.g. Rojo & Cobelas 1993, Acs & Kiss 1993, Descy 1993, Aronson & Precht 1995), non-manipulative experiments (e.g. Sousa 1979, Tanner et al. 1994) or performed in unnatural environments (Gaedeke & Sommer 1986, Sommer 1995). In a recently developed model Mackey & Currie (2000) predicted unimodal patterns between disturbance and diversity to be exceptional. A review of the same authors, compiling experimental and observational information about the IDH since 1980, confirmed their model (Mackey & Currie 2001). Yet the original IDH concept has been reshaped already soon after its postulation. According to these models, diversity of the very same assemblage will respond in a steady in- or decline or any degree of skewed humpback shaped curve in between both monotonous extremes, depending on the superimposed level of recruitment (Menge & Sutherland 1987) or productivity (Huston 1979, Kondoh 2001). Thus disturbance may not inevitably cause a unimodal diversity pattern. Indeed, I showed in this study, that a lack of a unimodal pattern will not necessarily result in rejection of the applicability of the IDH for the studied system. It seems that the plasticity of a system in its disturbance response is higher than demonstrated so far. What was a disturbance in one year might not be one in the next year or will have weaker or stronger impacts.

To better understand the processes behind the patterns, future experiments should consider two aspects. First, a disturbance gradient should be produced for multiple productivity levels, thus running parallel disturbance gradient each at a different productivity level. Second, where unimodal patterns appear, plots with maximum diversity should be transferred to both extremes, i.e. no distur-

bance and the utmost intensity/frequency treatment, following the succession of transferred plots, to see whether the assemblage structure on transferred plots will become progressively more similar to assemblages left continuously under both extremes.

In conclusion, a unimodal diversity response along a disturbance gradient was found for both disturbance qualities, emersion and enhanced UVB radiation. Yet this response was inconsistent when compared between years, and intensity vs. frequency modulated disturbance gradients. Within one year, the unimodal pattern was for both disturbance qualities non-persistent, appearing only at early successional stages, i.e. within the first two months of colonization. Confirming the original IDH model, competition of few competitive superior species (i.e. *Mytilus edulis*, and barnacles) reduced diversity left of the peak. Extending Connell's (1978) model, reduced diversity right of the peak can result from a change in dominance to a second group (i.e. algae) which is well adapted to the disturbance, reducing evenness instead of species number.

#### ECOLOGICAL RELEVANCE OF ULTRAVIOLET RADIATION (UV)

Ambient UV levels were sought to not only have detrimental effects at the organismal level, shown in a multitude of studies (reviewed in Wängberg et al. 1996, Häder et al. 1998), but also to affect species composition of complete assemblages (Caldwell et al. 1989, Häder et al. 1998). For the latter assumption no experimental evidence exists. In 2000, comparably lower diversity under ambient and enhanced UVB (chapter 6) confirmed the assumption that UV is indeed of ecological relevance, at least during early succession (<2 months) from my site at the Baltic Sea. In 2000, a follow-up experiment at the same site did not confirm this previous finding. Assemblages on controls were undistinguishable from those exposed to ambient UV, while enhanced UVB (=HUVB) adversely affected diversity for the first two months of the study. In a comparable experiment at the SE Atlantic, ambient UV was sufficient in reducing diversity significantly, but again this effect was restricted to an early successional stage (<3 months) and disappeared afterwards.

The interregional comparison between both sites in my experiments demonstrates different processes for the same result which I incorporated into a model (Fig. 8-2b). At the SE Atlantic, shading of the UV resistant red alga *Ceramium* allowed recruitment of two UV sensitive species, i.e. *Cladophora flagelliformis* and *Centroceras clavulatum* on UV exposed plots. At the Baltic Sea, mussel recruitment was facilitated in HUVB conditions as a result of higher abundance of the UV resistant green alga *Enteromorpha intestinalis*. In this way, extremely high abundance of small mussels produced high mussel abundance on HUVB exposed plots with simultaneously low diversity.

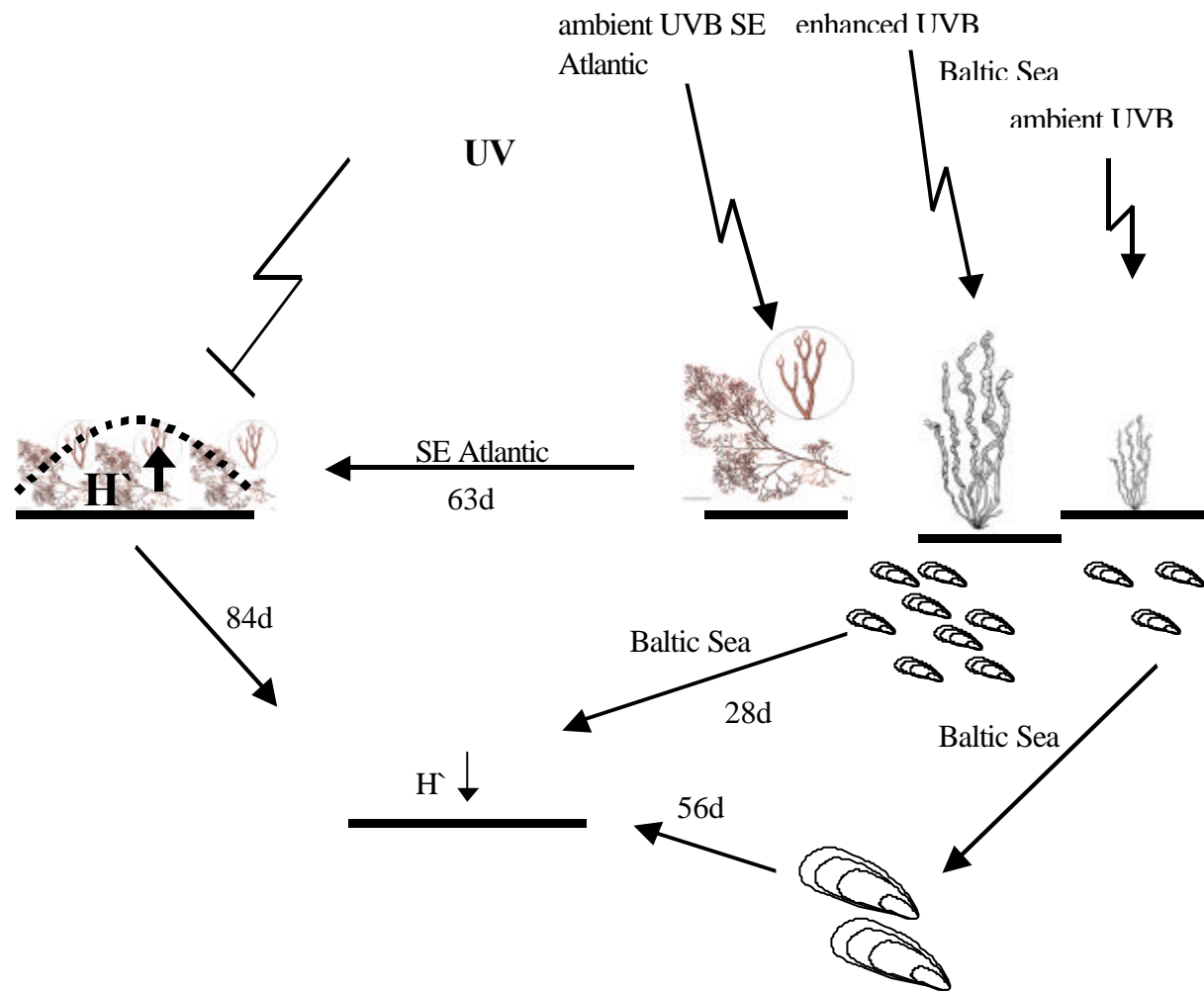

Fig. 8-2: Model to explain different processes at Baltic Sea and SE Atlantic causing first a difference and subsequently similar diversity among treatments with and without HUVB and UVB, respectively. Shading effect of algal canopy at SE Atlantic (= *Ceramium*) allows increase in diversity to comparable levels from PAR treatments. At Baltic Sea, the extend of algal cover (= *Enteromorpha intestinalis*) depends on the amount of HUVB. Higher recruitment under HUVB lowers diversity faster than under ambient irradiance levels. For the latter treatment, mussel growth reduces subsequently diversity to similar levels in all treatments. Number letter combinations above arrows indicate timing, and arrows direction of processes. Size of blitz-arrows indicate intensity of irradiance, size of algae symbolizes differences in cover.

Mussel dominance on plots under ambient irradiance exposure took longer until strong growth rates compensated initially relatively lower abundance. Thus UV exposure generated at both sites opposite starting positions from which both assemblages converged to equivalent diversity levels. However, this meant an overall de- or increase in diversity at the Baltic Sea and SE Atlantic, respectively.

Ambient UVB alone was without effect on assemblage structure at both sites, as well as from a study in Nova Scotia using the identical design (Lotze et al. 2002). Thus present changes in stratospheric ozone concentration might be without strong influence for shallow water hard bottom assemblages. McMinn et al. (1994) corroborate in their study this point of view. They could not distinguish compositional changes in the diatom component of Antarctic phytoplankton over the past 20y from long-term natural variability derived from fossil records. Studies on amphibians show strong direct (Blaustein et al. 1994) and indirect (Kiesecker & Blaustein 1995) implications on egg mortality and a resulting diversity decline in this vertebrate group. But, UV penetration depth in mountain lakes was sometimes higher in the past 200y than it is presently (Leavitt et al. 1997). Concluding, present UVB levels seem to severely effect individuals of many species, but were of little effect at the assemblage level. My results from the Baltic Sea suggest that even further increases in UVB may not necessarily have an effect on the diversity and species composition of the local benthic assemblages. A similar conclusion was drawn from mesocosm experiments using artificially enhance UVB on plankton assemblages (Laurion 1998) and simulated multitrophic ecosystems (de Lange et al. 1999). In addition, UVB induced alterations at the base of a food chain were without effect on higher elements of a trophic web (Keller et al. 1997). High DOC levels (de Lange et al. 1999, Kiffney 1997) or protective compounds shielding diatoms in periphyton assemblages (Karsten et al. 1998) were given as possible explanations for missing UV effects at the assemblage level.

Previous studies suggest that radiation-consumer interactions are possible (Cronin & Hay 1996, Pavia 1997, van Donk 1997) and detectable (Bothwell et al. 1994). Regrettably, consumer exclusion at both sites seemed to be incomplete, especially at the Baltic Sea, making generalisations difficult.

In conclusion, UVA radiation alone was without effect on fouling assemblage structure at both sites. While ambient UV radiation was sufficient to reduce diversity at the site of high natural irradiance levels (SE Atlantic), only a surplus of twice the ambient levels of UVB radiation lowered diversity at the site of naturally low irradiance levels (Baltic Sea). At both sites, UV effects were non-persistent and restricted to the first two months of succession. UV effects on diversity were at both sites indirect. At the Baltic Sea, diversity was faster reduced on surplus UVB exposed plots by an



enhanced mussel recruitment due to UVB stimulated *Enteromorpha* abundance. At the SE Atlantic, protective shading of a UV resistant *Ceramium* species allowed recruitment of UV sensitive species, increasing diversity on UV exposed plots with some time lag to comparable levels of UV free plots. Interactive effects between UV radiation and consumers were almost absent and non-persistent.

## OUTLOOK

My experiments did show it is risky to extrapolate from the species (sensitive to UV) to the assemblage level (insensitive to UV), from one year to another or from one disturbance quality to another. It is therefore not surprising to find very few, generally accepted paradigms in ecology (Lawton 1999).

To improve these weaknesses in ecology, meta analysis compare results from isolated studies and thus offer an opportunity to elicit causal connections on a broader spatial or temporal scale. However, their great disadvantages are (1) usually low number of usable studies, (2) inflexibility of the analysis, as usable locations were pre-fixed, and (3) methodological non-uniformity. Macroecology, i.e. widespread observations using identical methods, are a second approach to gain more generality into ecology (Lawton 1999, Wieters 2001). Yet, they are correlative, making desirable causal connections impossible (Peters et al. 1991).

Using the advantageous aspects from both approaches, i.e. methodological uniformity, active choice of study sites and field experiments that allow the analysis of pattern and process, is regarded in our study group as the most promising trial to set ecological paradigms on a more solid foundation. The emergence of more profound patterns was indeed demonstrated in my thesis as UV effects from different sites were compared. Therefore a global network was “knitted”, in which identical questions will be yearly tested in identical experiments at 8 different sites. The appearance of similar patterns from systems that differ in their species composition, abiotic and other biotic factors will allow a more thoroughly perception about the validity of ecological paradigms.

## 9. GLOSSARY

1-ANOVA	1-way analysis of variance	
df	degrees of freedom	sample size-1
DOC	dissolved organic carbon	
F	F-ratio	quotient between variance among and within samples
HUVB	enhanced UVB	radiation treatment using lamps as addition irradiance source
MS	mean squares	sums of squares divided by degrees of freedom
n	sample size	product of all replicates and factors (only balanced designs)
p	significance level	likelihood of real differences, arbitrarily set by convention at 5%
PAR	photosynthetic active radiation	400 – 700 nm
SD	standard deviation	square root of sample variance
SE	standard error	square root of the quotient of variance and sample size
RM 2-ANOVA	repeated-measures 2-way analysis of variance	
UVA	ultraviolet A radiation	315 – 400 nm
UVB	ultraviolet B radiation	280 – 315 nm



## 10. APPENDIX

### TABLES

Table A-1: T-test results for UVB, UVA, and PAR levels at the Baltic Sea site in 10 cm water depth comparing between 2000 and 2001, both for the entire study period (“total”) and single months. No data were available for August 2000. Data from 2001 were derived after conversion from measurement at 4 cm depth, using the Beer-Lambert Law.

<i>source</i>	UVB			UVA			PAR		
	df	t-value	p	df	t-value	p	df	t-value	p
<i>total</i>	80	- 1.73	0.088	55	-1.64	0.106	55	-0.21	0.837
<i>June</i>	23	-1.62	0.118	10	-1.78	0.105	16	-0.62	0.542
<i>July</i>	34	-1.58	0.124	19	-0.48	0.640	16	-0.94	0.361
<i>September</i>	19	-1.19	0.250	22	-1.13	0.273	19	-1.03	0.318

Table A-2: I-ANOVA results for UVB, UVA, and PAR levels at the Baltic Sea site in 10 cm water depth in 2000 and 2001, comparing between months within years to determine yearly seasonal patterns in the three wavebands separately for years.

<i>source</i>	df	MS	F	p	<i>source</i>	df	MS	F	p
<b>2000</b>					<b>2001</b>				
UVB	2	0.013	1.11	0.339	UVB	3	0.045	3.22	<b>0.030</b>
Residual	41	0.012			Residual	52	0.014		
UVA	2	140.45	6.30	<b>0.014</b>	UVA	3	311.83	4.11	<b>0.010</b>
Residual	12	22.31			Residual	56	75.88		
PAR	2	4703.8	11.43	<b>0.000</b>	PAR	3	3200.0	8.99	<b>0.000</b>
Residual	34	411.52			Residual	26	355.95		

Table A-3: I-ANOVA results comparing vertical attenuation coefficients ( $K_d$ ) separately for UVB, UVA, and PAR at the Baltic Sea site between months of 2001.

<i>source</i>	df	MS	F	p
<i>K<sub>d</sub> UVB</i>	3	1.25	3.54	<b>0.021</b>
<i>Residual</i>	51	0.35		
<i>K<sub>d</sub> UVA</i>	3	1.67	1.64	0.190
<i>Residual</i>	55	1.01		
<i>K<sub>d</sub> PAR</i>	3	1.63	9.90	<b>0.000</b>
<i>Residual</i>	26	0.16		

## FIGURES

Fig. A-1: Spectral irradiance of optical properties of filter materials and lamps used in chapters 5 and 6. A surface spectrum is additionally given as a reference for water attenuation effects

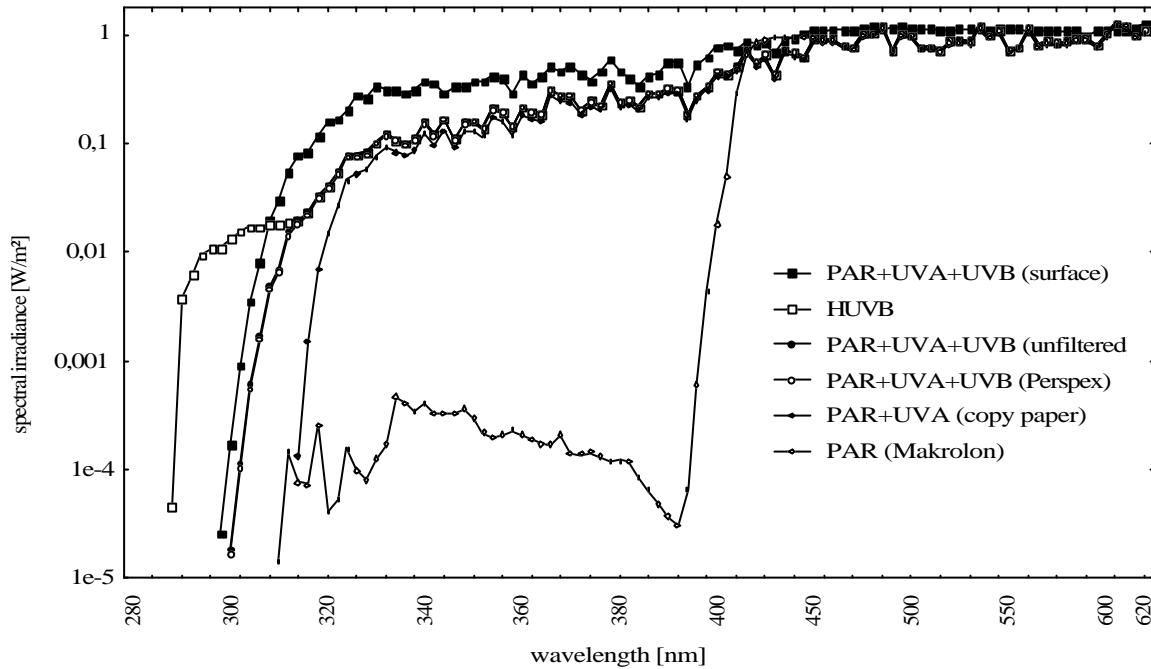
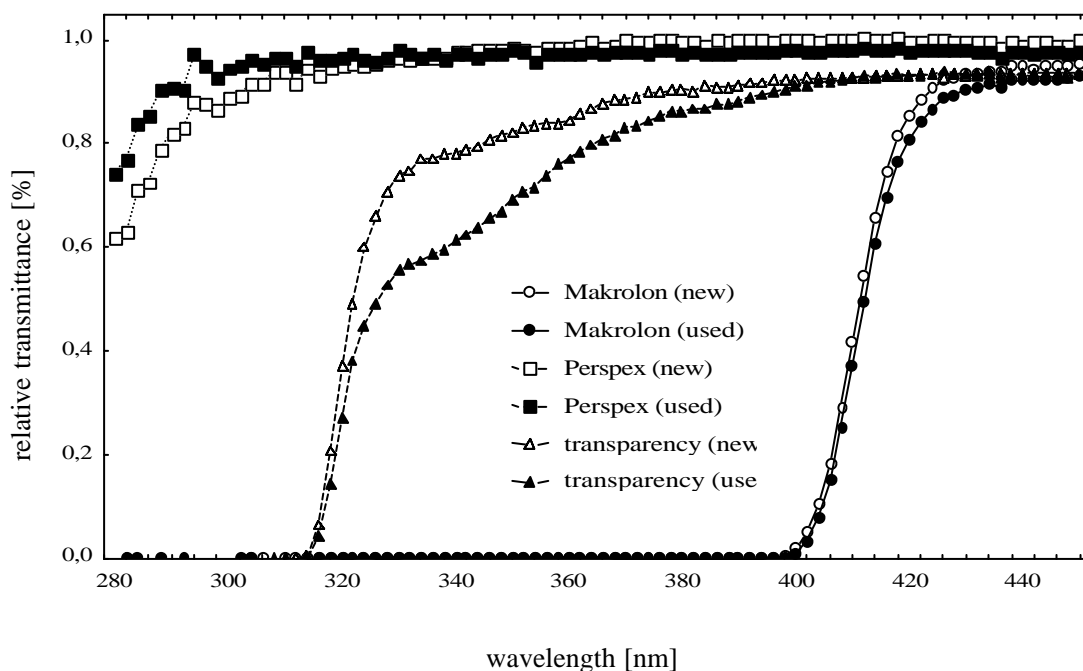

Fig. A-2: Percent transmittance of three kinds of new and used filter materials in relation to the transmittance of quartz glass quartz glass (type Herasil-1, Heraeus, Germany, 100% transparent for all wavelengths of the solar spectrum) from an artificial radiation source (see text for details). Makrolon blocks irradiance  $<400\text{nm}$  (= PAR treatment), transparencies block irradiance  $<320\text{nm}$  (= PAR+UVA treatment) and Perspex is virtually opaque ( $<3\%$ ) to solar radiation (= PAR+UVA+UVB treatment). No data beyond 450nm are presented since relative transmittance of all tested filter materials were constantly 90% or higher.



## 11. REFERENCES

- Acosta A, Sammarco P, Duarte L (2001) Asexual reproduction in a zoanthid by fragmentation: The role of exogenous factors. *Bull. Mar. Sci.* 68(3):363-381.
- Acs E, Kiss K (1993) Effects of the water discharge on periphyton abundance and diversity in a large river (River Danube, Hungary). *Hydrobiologia* 249(1-3):125-133.
- Adams J, Bate G (1994) The tolerance to desiccation of submerged macrophytes *Ruppia cirrhosa* (Petagna) Grande and *Zostera capensis* Setchell. *J. Exp. Mar. Biol. Ecol.* 183:53-62.
- Aronson R, Precht W (1995) Landscape patterns of reef coral diversity: A test of the intermediate disturbance hypothesis. *J. Exp. Mar. Biol.* 192:1-14.
- Binding BA (1999) Einfluss verschiedener Spektralbereiche der natürlichen Sonnenstrahlung auf die Entstehung und Struktur einer marinen Hartbodengemeinschaft. Zoological Institute CAU, Christian-Albrechts-University Kiel 82pp
- Blaustein A, Hoffman P, Hokit D, Kiesecker J, Walls S, Hays J (1994) UV repair and resistance to solar UV-B in amphibian eggs: A link to population declines? *Proc. Natl. Acad. Sci. USA* 91:1791-1795.
- Blumthaler M, Ambach W (1990) Indication of increasing ultraviolet-B radiation flux in Alpine regions. *Science* 248:206-208.
- Bothwell M, Sherbot D, Roberge A, Daley R (1993) Influence of natural ultraviolet radiation on lotic periphytic diatom community growth, biomass accrual, and species composition: short-term versus long-term effects. *J. Phycol.* 29:24-35.
- Bothwell M, Sherbot D, Pollock C (1994) Ecosystem response to solar UVB-radiation: influence of trophic-level interactions. *Science* 265:97-100.
- Boyle A (1996) The Rio convention on biological diversity. In: Redgwell C, Bowman M (eds) *International law and the conservation of biological diversity*. Kluwer Law International, London - The Hague - Boston, pp33-49
- Brawley S (1992) Mesoherbivores. In: John S, Hawkins S, Price J (eds) *Plant-Animal Interactions in the Marine Benthos*. Clarendon Press, Oxford, pp235-263
- Brawley S, Adey W (1981) The effect of micrograzers on algal community structure in a coral microcosm. *Mar. Biol.* 61:167-177.

- Bühlmann B, Bossard P, Uehlinger U (1987) The influence of longwave ultraviolet radiation (u.v.-A) on the photosynthetic activity ( $^{14}\text{C}$ -assimilation) of phytoplankton. *J. Plankt. Res.* 9(5):935-943.
- Bythell J, Hillis-Starr Z, Rogers C (2000) Local variability but landscape stability in coral reef communities following repeated hurricane impacts. *Mar. Ecol. Prog. Ser.* 204:93-100.
- Caldwell M, Teramura A, Tevini M (1989) The changing solar ultraviolet climate and the ecological consequences for higher plants. *TREE* 4(12):363-367.
- Chalker-Scott L, Scott J, Titus J (1994) Brief exposure to ultraviolet radiation inhibits locomotion of veligers and juvenile *D. polymorpha*. In: (ed) 37. Conference of the International Association of Great Lakes Research and Estuarine Research Federation. IAGLR, Buffalo, NY, USA, Windsor, ON, Canada, p166
- Chapman A, Chapman A (1999) Effects of cordgrass on saltmarsh fucoids: Reduced desiccation and light availability, but no changes in biomass. *J. Exp. Mar. Biol. Ecol.* 238:66-91.
- Chapman M, Underwood A (1999) Ecological patterns in multivariate assemblages: information and interpretation of negative values in ANOSIM tests. *Mar. Ecol. Prog. Ser.* 180:257-265.
- Claude H, Köhler U (1999) Erholt sich die Ozonschicht? *Ozonbulletin des Deutschen Wetterdienstes, Arbeitsergebnisse Nr. 55*
- Connell JH (1961) The influence of interspecific competition and other factors on the distribution of the barnacle *Chthamalus stellatus*. *Ecology* 42(4):710-723.
- Connell JH (1978) Diversity in tropical rain forests and coral reefs. *Science* 199:1302-1310.
- Connell JH, Slatyer R (1977) Mechanisms of succession in natural communities and their role in community stability and organisation. *Am Nat* 3:1119-1144.
- Cordi B, Donkin M, Peloquin J, Price D, Depledge M (2001) The influence of UV-B radiation on the reproductive cells of the intertidal macroalga, *Enteromorpha intestinalis*. *Aquat. Toxicol.* 56(1):1-11.
- Costanza R, d'Arge R, de Groot R, Farber S, Grasso M, Hannon B, Limburg K, Naeem S, O'Neill R, Paruelo J, Raskin R, Sutton P, van den Belt M (1997) The value of the world's ecosystem services and natural capital. *Nature* 387:253-260.
- Cronin G, Hay M (1996) Susceptibility to herbivores depends on recent history of both the plant and the animal. *Ecology* 77(5):1531-1543.

- Cullen J, Neale P (1994) UVR, ozone depletion, and marine photosynthesis. *Photosyn. Res.* 39:303-320.
- Damkaer D, Dey D (1983) UV damage and photoreactivation potentials of larval shrimp, *Pandalus platyceros*, and adult euphausiids, *Thysanoessa raschii*. *Oecologia* 60:169-175.
- Damkaer D, Dey D, Heron G (1981) Dose/dose-rate responses of shrimp larvae to UV-B radiation. *Oecologia* 48:178-182.
- Dayton P (1971) Competition, disturbance, and community organization: The provision and subsequent utilisation of space in a rocky intertidal community. *Ecol. Monogr.* 41(4):351-389.
- de Lange H, Verschoor A, Gylstra R, Cuppen J, van Donk E (1999) Effects of artificial ultraviolet-B radiation on experimental aquatic microcosms. *Freshwater Biol.* 42:545-560.
- DeNicola D, Hoagland K (1996) Effects of solar spectral irradiance (visible to UV) on a prairie stream epilithic community. *J. N. Am. Benthol. Soc.* 15(2):155-169.
- Descy DJ-P (1993) Ecology of the phytoplankton of the River Moselle: effects of disturbance on community structure and diversity. *Hydrobiologia* 249(1-3):111-116.
- Dietrich G, Kalle K, Krauss W, Siedler G (1975) *Allgemeine Meereskunde*. Gebrüder Borntraeger, Berlin, Stuttgart 593pp
- Doeg T, Lake P, Marchant R (1989) Colonization of experimentally disturbed patches by stream macroinvertebrates in the Acheron River, Victoria. *Aust. J. Ecol.* 14:207-220.
- Dole-Olivier M-J, Marmonier P, Befly J-L (1997) Response of invertebrates to lotic disturbance: is the hyporheic zone a patchy refugium? *Freshwater Biol.* 37:257-276.
- Drake P, Arias A (1995) Distribution and production of *Chironomus salinarius* (Diptera: Chironomidae) in a shallow coastal lagoon in the Bay of Cadiz. *Hydrobiologia* 299(3):195-206.
- Duffy J, Hay M (2000) Strong impacts of grazing amphipods on the organisation of a benthic community. *Ecol. Monogr.* 70(2):237-263.
- Dürr DS (1998) Zum Einfluss der Konkurrenz auf die Besiedlungsdynamik und die Zusammensetzung von Hartbodengemeinschaften. MS Zoological Institute CAU, Christian-Albrechts-University, Kiel 109pp
- Edwards P, Abivardi C (1998) The value of biodiversity: where ecology and economy blend. *Biol. Conserv.* 83(3):239-246.



- Ehrlich P, Ehrlich A (1991) *Extinction. Causes and consequences of the disappearance of species*. Random House, New York
- Ehrlich PR, Wilson EO (1991) Biodiversity studies: Science and policy. *Science* 253:758-762.
- Ehrlich PR, Ehrlich AH (1992) The value of biodiversity. *Ambio* 21(3):219-226.
- Ellington W, McMahon B (1998) Introduction to the symposium: Mechanisms of physiological compensation in intertidal animals. *Amer. Zool.* 28:37-38.
- Enderlein P (2000) Direkte und indirekte Wechselwirkungen zwischen Konsumenten, Beute und deren Aufwuchs in *Mytilus*-Gemeinschaften der westlichen Ostsee. PhD Zoological Institute, Christian-Albrechts-University Kiel, Kiel 101pp
- Epel D, Hemela K, Shick M, Patton C (1999) Development in the floating world: Defences of eggs and embryos against damage from UV radiation. *Amer. Zool.* 39:271-278.
- Fairbrother J (1994) Viable gynogenetic diploid *Mytilus edulis* (L.) larvae produced by ultraviolet light irradiation and cytochalasin B shock. *Aquaculture* 127(1-2):25-34.
- Flöder S, Sommer U (1999) Diversity in planktonic communities: An experimental test of the intermediate hypothesis. *Limnol. Oceanogr.* 44(4):1114-1119.
- Franklin L, Forster R (1997) The changing irradiance environment: consequences for marine macrophyte physiology, productivity and ecology. *Eur. J. Phycol.* 32:207-232.
- Frederick J, Snell H, Haywood E (1989) Solar UVR at the earth's surface. *Photochem. Photobiol.* 50(8):443-450.
- Fuentes E, Jaksic F (1988) The hump-backed species diversity curve: Why has it not been found among land animals? *Oikos* 53(1):139-143.
- Gaedeke A, Sommer U (1986) The influence of the frequency of periodic disturbances on the maintenance of phytoplankton diversity. *Oecologia* 71:25-28.
- Gaines S, Bertness M (1992) Dispersal of juveniles and variable recruitment in sessile marine species. *Nature* 360:579-580.
- Gaines S, Roughgarden J (1985) Larval settlement rate: A leading determinant of structure in an ecological community of the marine intertidal zone. *Proc. Natl. Acad. Sci. USA* 82:3707-3711.
- Gause G (1935) Experimental demonstration of Volterra's periodic oscillation in the number of animals. *J. Exp. Biol.* 12:44-48.

- Gleason D, Wellington F (1995) Variation in UVB sensitivity of planula larvae of the coral *Agaricia agaricites* along a depth gradient. *Mar. Biol.* 123:693-703.
- Gohse S (1999) Interaktionen zwischen filamentösen Strukturen und Amphipoden (Crustacea). MS Zoological Institute, Christian-Albrechts-University, Kiel 64pp
- Grime J (1973a) Competitive exclusion in herbaceous vegetation. *Nature* 242:344-347.
- Grime J (1977) Evidence for the existence of three primary strategies in plants and its relevance to ecological and evolutionary theory. *Am Nat* 111:1169-1194.
- Häder D-P (1989) Effects of stratospheric ozone depletion on marine organisms. *Environmental Conservation* 16(3):261-263.
- Häder D-P, Worrest RC, Kumar HD, Smith RC (1995) Effects of increased solar UVR on aquatic ecosystems. *Ambio* 24(3):174-180.
- Häder D-P, Kumar H, Smith R, Worrest R (1998) *Effects on aquatic ecosystems*. United Nations Environment Programme Nairobi 193pp
- Hamer J, Walker G, Latchford J (2001) Settlement of *Pomatoceros lamarkii* (Serpulidae) larvae on biofilmed surfaces and the effect of aerial drying. *J. Exp. Mar. Biol. Ecol.* 260:113-131.
- Hessen D, de Lange H, van Donk E (1997) UV-induced changes in phytoplankton cells and its effects on grazers. *Freshwater Biol.* 38:513-524.
- Hill W, Dimick S, McNamara A, Branson C (1997) No effects of ambient UV radiation detected in periphyton and grazers. *Limnol. Oceanogr.* 42(4):769-774.
- Holm-Hansen O, Helbling E, Lubin L (1993) UVR in Antarctica: inhibition of primary production. *Photochem. Photobiol.* 58(4):567-570.
- Hughes J, Daily G, Ehrlich P (1997) Population Diversity: Its extent and extinction. *Science* 278:689-692.
- Hunt H, Scheibling R (1996) Physical and biological factors influencing mussel (*Mytilus trossulus*, *Mytilus edulis*) settlement on a wave-exposed rocky shore. *Mar. Ecol. Prog. Ser.* 142:135-145.
- Huston M (1979) A general hypothesis of species diversity. *Am. Nat.* 113(1):81-101.
- Hutchinson G (1961) The paradox of the plankton. *Am. Nat.* 95:137.
- Jerlov NG (1950) Ultra-violet radiation in the sea. *Nature* 166:111-112.
- Jokiel P (1980) Solar UVR and coral reef epifauna. *Science* 207:1069-1071.

- Karsten U, Maier J, Garcia-Pichel F (1998) Seasonality in UV-absorbing compounds of cyanobacterial mat communities from an intertidal mangrove flat. *Aquat. Microb. Ecol.* 16:37-44.
- Karsten U, Bischof K, Wiencke C (2001) Photosynthetic performance of Arctic macroalgae after transplantation from deep to shallow waters. *Oecologia* 127(1):11-20.
- Keller A, Hargraves P, Jeon H, Klein-MacPhee G, Klos E, Oviatt C, Zhang J (1997) Effects of ultraviolet-B enhancement on marine trophic levels in a stratified coastal system. *Mar. Biol.* 130:277-287.
- Kelly D, Clare J, Bothwell M (2001) Attenuation of solar ultraviolet radiation by dissolved organic matter alters benthic colonization patterns in streams. *J. N. Am. Benthol. Soc.* 20(1):96-108.
- Kennedy V (1976) Desiccation, higher temperatures and upper intertidal limits of three species of sea mussels (Mollusca: Bivalvia) in New Zealand. *Mar. Biol.* 35:127-137.
- Kerr JB, McElroy CT (1993) Evidence for large upward trends of Ultraviolet-B radiation linked to ozone depletion. *Science* 262:1032-1034.
- Kiesecker J, Blaustein A (1995) Synergism between UV-B radiation and a pathogen magnifies amphibian embryo mortality in nature. *Proc. Natl. Acad. Sci. USA* 92(24):11049-11052.
- Kiesecker J, Blaustein A, Belden L (2001) Complex causes of amphibian population declines. *Nature* 410:681-684.
- Kiffney PM, Clements WH, Cady TA (1997) Influence of UVR on the colonization dynamics of a Rocky Mountain stream benthic community. *J. N. Am. Benthol. Soc.* 18(3):520-530.
- Kondoh M (2001) Unifying the relationships of species richness to productivity and disturbance. *Proc. R. Soc. Lond.* 268:269-271.
- Krebs C (2001) *Ecology: The experimental analysis of distribution and abundance*. Addison Wesley Longman, Inc., San Francisco 695pp
- Lake P, Doeg T, Marchant R (1989) Effects of multiple disturbance on macroinvertebrate communities in the Acheron River, Victoria. *Aust. J. Ecol.* 14:507-514.
- Langer M (2001) Einfluss natürlicher UV-Strahlung auf marine Benthosgemeinschaften der nordchilenischen Pazifikküste bei Coquimbo, Chile. MS Zoological Institute, Christian-Albrechts-University, Kiel 75pp

- Laurion I, Lean DRS, Vincent WF (1998) UVB effects on a plankton community: results from a large-scale enclosure assay. *Aquat. Microb. Ecol.* 16:189-198.
- Lawton J (1994) What do species do in ecosystems? *Oikos* 71:367-374.
- Lawton J (1999) Are there general laws in ecology? *Oikos* 84:177-192.
- Lawton J (2000) Community ecology in a changing world. In: Kinne O (ed) *Excellence in ecology*. 11 Oldendorf/Luhe 237pp
- Lawton J, Brown V (1993) Redundancy in ecosystems. In: Schulze E-D, Mooney H (eds) *Biodiversity and ecosystem function*. Springer-Verlag, Berlin, pp255-270
- Levin S, Paine R (1974) Disturbance, patch formation, and community structure. *Proc. Natl. Acad. Sci. USA* 71(7):2744-2747.
- Lotka A (1925) *Elements of Physical Biology*. Williams and Wilkins. Reprinted by Dover 1956
- Lotze H, Worm B (2000) Variable and complementary effects of herbivores on different life stages of bloom-forming macroalgae. *Mar. Ecol. Prog. Ser.* 200:167-175.
- Lotze H, Worm B, Moils M, Wahl M (2002) Interactive effects of UV radiation and consumers on recruitment and succession of a marine macrobenthic community. (*submitted to Mar. Ecol. Prog. Ser.*) .
- Lozã J, Graßl H, Hupfer P (1998) Ozonrückgang in der Stratosphäre. In: Lozã J, Graßl H, Hupfer P (eds) *Warnsignal Klima*. Eurodruck, Hamburg, pp182-189
- Lüning K (1981) Light. In: Lobban C, Wynne M (eds) *The biology of seaweeds*. University of California Press, Berkeley & Los Angeles, 786pp
- Mackey R, Currie D (2000) A re-examination of the expected effects of disturbance on diversity. *Oikos* 88(3):483-493.
- Mackey R, Currie D (2001) The diversity-disturbance relationship: is it generally strong and peaked? *Ecology* 82(12):3479-3492.
- Mann K, Lazier J (1991) *Dynamics of marine ecosystems. Biological-physical interactions in the ocean*. Blackwell Scientific Publications, Boston 466pp
- McArthur R (1955) Fluctuations of animal populations, and a measure of community stability. *Ecology* 36(3):533-536.
- McAuliffe J (1984) Competition for space, disturbance, and the structure of a benthic stream community. *Ecology* 65(3):894-908.

- McCabe D, Gotelli N (2000) Effects of disturbance frequency, intensity, and area on assemblages of stream macroinvertebrates. *Oecologia* 124:270-279.
- McGrady-Steed J, Morin P (2000) Biodiversity, density compensation, and the dynamics of populations and functional groups. *Ecology* 81(2):361-373.
- McGrady-Steed J, Harris P, Morin P (1997) Biodiversity regulates ecosystem predictability. *Nature* 390:162-165.
- McMinn A, Heijnis H, Hodgson D (1994) Minimal effects of UVB radiation on Antarctic diatoms over the past 20 years. *Nature* 370:547-549.
- McNamara A, Hill W (1999) Effects of UV-B dose and irradiance: comparison among grazers. *J. N. Am. Benthol. Soc.* 18(3):370-380.
- Menge B, Sutherland J (1987) Community regulation: Variation in disturbance, competition, and predation in relation to environmental stress and recruitment. *Am. Nat.* 130(5):730-757.
- Molloy F (1992) Studies on the ecology and production of seaweeds of economic and potential economic importance on the Namibian coast. PhD Botany Department, University of Cape Town 260pp
- Naeem S, Li S (1997) Biodiversity enhances ecosystem reliability. *Nature* 390:507-509.
- Naeem S, Thompson L, Lawler S, Lawton J, Woodfin R (1994) Declining biodiversity can alter the performance of ecosystems. *Nature* 368:734-737.
- Ochs C (1997) Effects of UVR on grazing by two marine heterotrophic nanoflagellates on autotrophic picoplankton. *J. Plankt. Res.* 19(10):1517-1536.
- Ochs C, Eddy L (1998) Effects of UV-A (320 to 399 nm) on grazing pressure of a marine heterotrophic nanoflagellate on strains of the unicellular cyanobacteria *Synechococcus spp.* *Appl. Envir. Microb.* 64(1):287-293.
- Paine R (1966) Food web complexity and species diversity. *Am. Nat.* 100:65-75.
- Pavia H, Cervin G, Lindgren A, Aberg P (1997) Effects on UV-B radiation and simulated herbivory on phlorotannins in the brown alga *Ascophyllum nodosum*. *Mar. Ecol. Prog. Ser.* 157:139-146.
- Peters R, Armesto J, Boeken B, Cole J, Driscoll C, Durate C, Frost T, Grime J, Koasa J, Prepas E, Sprules W (1991) On the relevance of comparative ecology to the larger field of ecology. In: Cole J, Lovett G, Findley S (eds) *Comparative analyses of ecosystems*. Springer Verlag, New York.

- Petraitis P (1995) The role of growth in maintaining spatial dominance by mussels (*Mytilus edulis*). *Ecology* 76(4):1337-1346.
- Piazena H, Häder D-P (1994) Penetration of solar UV irradiation in coastal lagoons of the southern Baltic Sea and its effect on phytoplankton communities. *Photochem. Photobiol.* 60:463-469.
- Pickett S, Kolasa J, Armesto J, Collins S (1989) The ecological concept of disturbance and its expression at various hierarchical levels. *Oikos* 54:129-136.
- Pimm S, Russell GJ, Gittleman JL, TM Brooks (1995) The future of biodiversity. *Science* 269:347-350.
- Pulfrich A (1996) Attachment and settlement of post-larval mussels (*Mytilus edulis* L.) in the Schleswig-Holstein wadden sea. *J. Sea Res.* 36(3-4):239-250.
- Rader R, Belish T (1997) Effects of ambient and enhanced UV-B radiation on periphyton in a mountain stream. *J. Freshwater Ecol.* 12(4):615-628.
- Raffaelli D, Hawkins S (1996) *Intertidal ecology*. Chapman & Hall, London 356pp
- Reice S (1985) Experimental disturbance and the maintenance of species diversity in a stream community. *Oecologia* 67:90-97.
- Reynolds C, Padisak J, Sommer U (1993) Intermediate disturbance in the ecology of phytoplankton and the maintenance of species diversity: A synthesis. *Hydrobiologia* 249(1-3):183-188.
- Rhode S, Pawlowski M, Tollrian R (2001) The impact of ultraviolet radiation on the vertical distribution of zooplankton of the genus *Daphnia*. *Nature* 412:69-72.
- Richerson P, Armstrong R, Goldman C (1970) Contemporaneous disequilibrium, a new hypothesis to explain the "Paradox of the Plankton". *Proc. Natl. Acad. Sci. USA* 67(4):1710-1714.
- Rojo L, Cobelas A (1993) Hypertrophic phytoplankton and the intermediate disturbance hypothesis. *Hydrobiologia* 249:43-57.
- Santas R, Lianou C, Danielidis D (1997) UVB radiation and depth interaction during primary succession of marine diatom assemblages of Greece. *Limnol. Oceanogr.* 42(5):986-991.
- Santas R, Korda A, Lianou C, Santas P (1998a) Community responses to UV radiation. I. Enhanced UVB effects on biomass and community structure of filamentous algal assemblages growing in a coral reef mesocosm. *Mar. Biol.* 131:153-162.

- Santas R, Santas P, C L, Korda A (1998b) Community responses to UVR: effects of solar UVB on field-grown diatom assemblages of the Caribbean. *Mar. Biol.* 131:163-171.
- Schindler D, Curtis P, Parker B, Stainton M (1996) Consequences of climate warming and lake acidification for UV-B penetration in North American boreal lakes. *Nature* 379:705-708.
- Seckmeyer G, McKenzie RL (1992) Increased ultraviolet radiation in New Zealand (45°S) relative to Germany (48°N). *Nature* 359:135-137.
- Shindell D, Rind D, Lonergan P (1998) Increased polar stratospheric ozone losses and delayed eventual recovery owing to increasing greenhouse-gas concentrations. *Nature* 392:589-592.
- Smith R, Prezelin B, Baker K, Bidigare R, Boucher N, Coley T, Karentz D, MacIntyre S, Matlick H, Menzies D, Ondrusek M, Wan Z, Waters K (1992) Ozone depletion: UVR and phytoplankton biology in Antarctic waters. *Science* 255:952-959.
- Sokal RR, Rohlf FJ (1995) *Biometry. The principles and practice of statistics in biological research*. WH Freeman and company, New York 887pp
- Sommer U (1995) An experimental test of the intermediate disturbance hypothesis using cultures of marine phytoplankton. *Limnol.Oceanogr.* 40(7):1271-1277.
- Sommer U, Padisak, J, Reynolds C, Juhasz-Nagy P (1993) Hutchinson's heritage: the diversity-disturbance relationship in phytoplankton. *Hydrobiologia* 249(1-3):1-7.
- Soulé ME (1991) Conservation: Tactics for a constant crisis. *Science* 253:744-750.
- Sousa WP (1979) Disturbance in marine intertidal boulder fields: The nonequilibrium maintenance of species diversity. *Ecology* 60(6):1225-1239.
- Stresemann E (1976) *Exkursionsfauna - Wirbellose I* Volk und Wissen Volkseigener Verlag, Berlin 494pp
- Suchanek T (1978) The ecology of *Mytilus edulis* L. in exposed rocky intertidal communities. *J. Exp. Mar. Biol. Ecol.* 31:105-120.
- Sundbäck K, Nilsson C, Odmark S, Wulff A (1996) Does ambient UV-B radiation influence marine diatom-dominated microbial mats? A case study. *Aquat. Microb. Ecol.* 11:151-159.
- Tanner J, Hughes T, Connell J (1994) Species coexistence, keystone species, and succession: A sensitivity analysis. *Ecology* 75(8):2204-2219.

- Tatrai I (1988) Experiments on nitrogen and phosphorus release by *Chironomus ex. gr. plumosus* from the sediments of Lake Balaton, Hungary. *Int. Rev. Gesamt. Hydrobiol.* 73(6):627-640.
- Tilman D, Downing J (1994) Biodiversity and stability in grasslands. *Nature* 367:363-365.
- Tilman D, Wedin D, Knops J (1996) Productivity and sustainability influenced by biodiversity in grassland ecosystems. *Nature* 379:718-720.
- Underwood A (1997) *Experiments in ecology: their logical design and interpretation using analysis of variance*. Cambridge Univ. Press, Cambridge 504pp
- Underwood A, Fairweather P (1989) Supply-side ecology and benthic marine assemblages. *TREE* 4(1):16-20.
- Valiela I (1995) *Marine ecological processes*. Springer, New York 686pp
- van Donk E (1997) Defenses in phytoplankton against grazing induced by nutrient limitation, UV-B stress and infochemicals. *Aquat. Ecol.* 31:53-58.
- Volterra V (1926) Variazioni e fluttuazione del numero d'individui in specie animali conviventi. *Mem. Acad. Lincei Roma* 2:31-113.
- Walker B (1992) Biodiversity and ecological redundancy. *Conserv. Biol.* 6:18-23.
- Wallis R (1975) Thermal tolerance of *Mytilus edulis* of Eastern Australia. *Mar. Biol.* 30:183-191.
- Wängberg S, Selmer J, Ekelund N, Gustavson K (1996) *UV-B Effects on Nordic Marine Ecosystems: a literature review*. Nordic Council of Ministers. Copenhagen. pp1-45. Nordic Council of Ministers 1996: 515pp
- Wardle DA, Bonner KI, Nicholson KS (1997) Biodiversity and plant litter: Experimental evidence which does not support the view that enhanced species richness improves ecosystem function. *Oikos* 79(2):247-258.
- White P, Pickett S (1985) Natural disturbance and patch dynamics: An introduction. In: White P, Pickett S (eds) *The Ecology of Natural Disturbance and Patch Dynamics*. pp3-13
- Wieters E (2001) Marine Macroecology. *TREE* 16(2):67-68.
- Williams E (1979) Evidence for dark repair of far UV light damage in the blue-green alga *Gloeocapsa alpicola*. *Photochem. Photobiol.* 29:543-547.
- Williamson C, Hargreaves B, Orr P, Lovera P (1999) Does UV play a role in changes in predation and zooplankton community structure in acidified lakes? *Limnol. Oceanogr.* 44(3):774-783.



- WMO (1998) *Scientific assessment of ozone depletion*. World Meteorological Organisation #44. 41pp
- Wootton J (1998) Effects of disturbance on species diversity: A multitrophic perspective. *Am. Nat.* 152(6):803-825.
- Worm B (2000) Consumer versus resource control in rocky shore food webs: Baltic Sea and Northwest Atlantic Ocean. PhD. Institute for Marine Science, Christian-Albrechts-University, Kiel 147pp
- Worrest R, van Dyke H, Thomson B (1978) Impact of enhanced simulated solar ultraviolet radiation upon a marine community. *Photochem. Photobiol.* 27:471-478.
- Yachi S, Loreau M (1999) Biodiversity and ecosystem productivity in a fluctuating environment: the insurance hypothesis. *Proc. Nat. Am. Sci.* 96:1463-1468.
- Zagarese H, Williamson C (2000) Impact of solar UV radiation on zooplankton and fish. In: de Mora SJ, SDM V (eds) *The effects of UV radiation in the marine environment*. Cambridge University Press, Cambridge, 324pp.

## 12. ACKNOWLEDGEMENTS

The below mentioned people and organisations represent an incomplete list. Certainly, there were many helpful people contributing to some parts in this project. I am grateful to all of them. Still, I would like to thank some of them more thoroughly.

Above all, I sincerely want to thank my mentor and friend Martin Wahl for supervision, different point of views, new perspectives and, together with his family, for their generous support at Namibia.

My wife, Maria, for her understanding and interest in my occupation, as well as an open ear for my smaller and large problems that accompanied the project.

Johannes Freitag, Jürgen Sachau, Thomas Winter and Thomas Walter (all workshop members from the bio-centre Kiel University) and Michael Bachmann (janitor of the bio-centre Kiel University) for advice and labour to construct the experimental set-up at Kiel.

Henner Sandmann and Prof. Dr. Stick (Inst. of Med. Climatology, Univ. Kiel) and Dr. Steinmetz (Federal Office for Radiation Protection, Munich) provided instruments and knowledge for calibration of UVB lamps and assessment of optical properties of used filter and blocking materials.

WAS Kiel for admittance to the Schleuseninsel and logistical support.

WSA and Meteorology Department of the Institute of Marine Science Kiel (IfM) kindly transmitted water level and meteorological records, respectively..

The company Pausch for kind supply of UV lamps free of charge.

The University of Namibia, represented by Josephine Msungi, for academically hosting and supply of work space.

Fergus Molloy (University of Namibia), for identification of algae from Radford Bay.

The UNAM students Gabriel Shekutamba and Felix Shimoli for their conscientious maintenance of the experiment at Lüderitz and their insight into the Namibian self-esteem.

The Lüderitz Marine Research Ministry of Fisheries and Marine Resources for logistical support. Very kindly I want to thank Jean-Paul Roux, Jessica Kemper and Kathie Noli for their unselfish help to get me organized and an unforgettably nice atmosphere.

Josefin Johansson and Matthias Langer for improving raft constructions and one long week to rig them up.

The oyster farm manager, Dan Harvey ,and his employees for permission and help to set up the experiment on this area, usage of a boat and facilities.

Monika Broschwitz and Stephan Ried for proof-reading.

This work was granted by the Deutsche Forschungsgemeinschaft (WA 708/ 6-1+2) to M Wahl and for the experiments at Namibia the HSP III title of Deutsche Akademische Auslandsamt D00/31457 to M Molis.