

Institut für Theoretische Physik und Astrophysik
Christian-Albrechts-Universität zu Kiel
und
Centre de Physique Théorique
CNRS, Marseille

Noncommutative Geometry and the Standard Model of Particle Physics

Dissertation

zur Erlangung des Doktorgrades

der Mathematisch-Naturwissenschaftlichen Fakultät

der Christian-Albrechts-Universität

zu Kiel

vorgelegt von

Christoph Alexander Stephan

Mai 2005

Referent: Priv. Doz. Dr. Gerhard Gensing
Koreferentin: Prof. Dr. Barbara Schrempp
Tag der mündlichen Prüfung: 30. Juni 2005
Zum Druck genehmigt: Kiel, den 13. Juli 2005

Prof. Dr. Jürgen Grotemeyer,

Der Dekan

Abstract:

Alain Connes discovered an algebraic approach to geometry on replacing ordinary Riemannian spin geometry by spectral triples. A spectral triple is a set of three entities: an algebra, a Dirac operator, and a Hilbert space. They encode all the information of the geometry. A novel feature is the possibility to include so called noncommutative spaces. These are represented by noncommutative algebras, while our every-day space-time is encoded by commutative algebras. It is now tempting to render the commutative algebra representing space-time a little bit noncommutative, by tensorising it with a sum of matrix algebras. Alain Connes and Ali Chamseddine discovered that, for a certain choice of matrix algebras, one obtains general relativity and the classical field theory of the standard model of particle physics. These half commutative, half noncommutative spectral triples are called almost-commutative. They provide a natural interpretation of the Higgs boson as a connection in the noncommutative part of the geometry.

Every almost-commutative spectral triple represents a Yang-Mills-Higgs model and is a potential candidate for a physical theory. In this doctoral thesis further physical requirements are imposed on these spectral triples, such as non-degenerate fermion masses and renormalisability. From these first principles all almost-commutative spectral triples, with up to four algebras were classified in collaboration with Prof. Thomas Schücker, Prof. Bruno Iochum, and Jan-Hendrik Jureit. Surprisingly the standard model takes a most prominent position in this classification. It remains an open question whether more than four algebras contain further models.

Zusammenfassung:

Alain Connes formulierte einen algebraischen Ansatz, der es erlaubt, Riemannsche Spin-Mannigfaltigkeiten durch so genannte *spektrale Tripel* zu beschreiben. Ein spektrales Tripel ist eine Menge mit drei Elementen: Einer Algebra, einem Diracoperator und einem Hilbertraum. Unterwirft man diese Elemente einer Reihe von Konsistenzbedingungen, den Axiomen der *nichtkommutativen Geometrie*, so lassen sich bei geeigneter Wahl der Elemente alle Informationen einer Riemannschen Spinmannigfaltigkeit wiederherstellen. Das Interessante an dieser Umformulierung der Geometrie ist, daß in allen Definitionen und Beweisen die Kommutativität der Algebra und damit der Raumkoordinaten keine Rolle spielt.

Der erste Schritt über die bekannte Raumzeit hinaus ist nun, die Funktionenalgebra ein “bißchen nichtkommutativ” zu machen. Zu diesem Zweck wählt man eine Matrixalgebra, die im allgemeinen nichtkommutativ ist, einen dazu passenden Diracoperator und Hilbertraum, und tensorisiert das dazugehörige *diskrete* spektrale Tripel mit dem der Raumzeit. Das Ergebnis wird als fast-kommutatives spektrales Tripel bezeichnet und beschreibt eine Kaluza-Klein-artige Raumzeit mit diskreten, das heißt nicht direkt meßbaren, extra Dimensionen.

Connes und Chamsedine haben entdeckt, daß für eine bestimmte Wahl des diskreten Tripels die Yang-Mills-Higgs-Theorie des Standardmodells der Elementarteilchenphysik und die allgemeine Relativitätstheorie als klassische Feldtheorie vereinheitlicht reproduziert werden. Das erstaunliche an dieser Herangehensweise ist, neben der bisher einmaligen Vereinheitlichung, daß das normalerweise von Hand eingeführte Higgsboson aus der Theorie zwingend folgt und eine natürliche Erklärung als *Zusammenhang* im diskreten Raum erfährt.

Das Ziel dieser Dissertation war, eine Klassifikation der fast-kommutativen spektralen Tripel vom Standpunkt der Elementarteilchenphysik vorzunehmen. Zu diesem Zweck wurde eine bereits bestehende Klassifizierung diskreter spektraler Tripel durch Dr. Krajewski im physikalischen Sinne erweitert. Es wurden einige plausible physikalische Zusatzannahmen gemacht, und in Zusammenarbeit mit Prof. Schücker, Prof. Iochum und J.-H. Jureit konnten die fast-kommutativen spektralen Tripel mit bis zu vier Matrixalgebren vollständig klassifiziert werden. Das überraschende Ergebnis ist, daß das Standardmodell eine herausragende Position einnimmt. Es ist, bis auf ein exotisches Modell, das einzige physikalisch relevante spektrale Tripel.

Die vollständigen Ergebnisse sind dieser Arbeit als Anhang angefügt.

Contents

1	Introduction	1
2	The Standard Model of Particle Physics	11
2.1	The Gauge Principle	11
2.2	Spontaneous Symmetry Breaking	14
2.3	Renormalisation Constraints	16
2.4	How to Build a Gauge Theory	19
2.5	The Standard Model	20
2.6	General Relativity	24
2.7	The Euclidian Lagrangian	26
3	Noncommutative Geometry	29
3.1	Riemannian Spinmanifolds as Spectral Triples	30
3.2	General Relativity II	37
3.3	Finite Spectral Triples	41
3.4	Krajewski Diagrams	49
3.5	Almost-Commutative Spectral Triples	61
4	Classifying Almost-Commutative Geometries	67
4.1	Constraints from Particle Physics	68
4.2	The Almost-Commutative Standard Model	71
5	Conclusions	81
	Lebenslauf	91
	Erklärung	93
	Danksagung	95

Chapter 1

Introduction

In the last century fundamental physics saw two revolutions, overthrowing the Newtonian view of the laws that govern Nature. These were general relativity, pioneered by Einstein and Hilbert, and quantum mechanics, where many names such as Heisenberg, Schrödinger, Pauli, Dirac, Bohr and more come into mind.

The first revolution, general relativity, introduced space-time as a physical entity, which obtains dynamics and interacts with matter. It proved to be extremely efficient to describe structures reaching from cosmology to falling apples. Yet, there was a price to pay. The very concept of a universal time had to be abandoned and was replaced by the proper time τ of the observer. Dynamics is governed by the Einstein equations, where the metric of the space-time manifold itself becomes a variable. Symmetries play a fundamental rôle in physics and its laws are required to be invariant under these. For general relativity the principle of relativity implies that the theory should be invariant under generalised coordinate transformations or diffeomorphisms. Gravity is then nothing but a pseudo-force belonging to generalised coordinate transformations with matter as its source.

A few years later quantum mechanics and its descendent, quantum field theory, appeared on the scene. These theories allow to model the sub-atomic, atomic and molecular scales of Nature with extraordinary precision. But again, a price has to be paid. The very notion of exact measurement has to be abandoned. Due to Heisenberg's uncertainty relation the position and the momentum of a particle cannot be measured at the same time with arbitrary accuracy. The position and momentum observables x_i, p_i with $i = 1, 2, 3$, become operators on a Hilbert space, $x_i \rightarrow \hat{x}_i$ and $p_i \rightarrow \hat{p}_i$, which form a non-commutative algebra $[\hat{x}_i, \hat{p}_j] = i\delta_{ij}\hbar$. Represented on the

Hilbert space of wave functions $\mathcal{H} \ni \Psi(\mathbf{x})$ these operators take the well known form

$$\hat{x}_i \Psi(\mathbf{x}) = x_i \Psi(\mathbf{x}) \quad \hat{p}_i \Psi(\mathbf{x}) = -i\hbar \frac{\partial}{\partial x_i} \Psi(\mathbf{x}).$$

Note that the position operators and the momentum operators commute among themselves $[\hat{x}_i, \hat{x}_j] = [\hat{p}_i, \hat{p}_j] = 0$. In the special relativistic case the Klein-Gordon operator and the Dirac operator govern the dynamics of Bosons and Fermions, respectively. Now time is included into the formalism as a fourth dimension, x_0 , of space-time.

All attempts to merge general relativity and quantum mechanics have failed so far. Quantising general relativity leads to theories which are not renormalisable. So these theories exhibit infinite quantities which cannot be eliminated. On the other hand quantum mechanics is only well defined on flat spaces with universal time, i.e. Euclidian or Minkowski spaces.

But what should such a theory of quantum space-time look like on the mathematical level? There are two heuristic arguments which suggest that the points of space-time should lose all meaning, and so the classical notion of a manifold, fundamental to general relativity, should vanish.

The first argument, see [24], goes as follows. Imagine an accelerator that allows to measure the position of a particle with ever higher precision. Applying Heisenberg's uncertainty relation this means that the energy needed, will increase. Now the Einstein equations imply a threshold of energy, or equivalently mass, per volume unit, which, if surpassed, forces the space-time itself within the volume to collapse into a singularity surrounded by a Schwarzschild horizon. In this way the measurement of position and so of space-time has a limit. It was shown in [24] that this causes the position observables x_μ to become noncommutative, $[x_\mu, x_\nu] \neq 0$, they form a noncommutative algebra. This means as well that the very notion of a point loses all its meaning, and so does the mathematical tool of differential geometry, in which general relativity is formulated.

The second argument is based on the physical notion of a space-time point. In general, fundamental particles, such as electrons, are considered to be point-like, so they do not have a spatial extension. Modelling an abstract space-time point by an electron seems to be quite adequate. But how can one define the basic notions of geometry like distance? Defining distance as the way traveled by an electron is again plagued with uncertainties. If the starting and the end point are known more and more accurately, the momentum becomes reciprocally more and more obscure. But the momentum defines the actual distance travelled by the electron. Every physical

measurement is based necessarily on particles and so it is bound to be equipped with a fundamental uncertainty, which is not due to the technical accuracy of the experiment.

These two rather heuristic arguments may pave the way. It seems that space-time itself should be equipped with an uncertainty. One approach to tackle this problem is in the spirit of quantum mechanics. Space-time should be replaced by a suitable set of operators, acting on some Hilbert space with the dynamics defined by a Dirac operator. The choice of a relativistic operator is clear since the theory ought to be Lorentz invariant. As for the Dirac operator, in favour of the Klein-Gordon operator, matter is built from Fermions and so the Dirac operator is privileged. This approach, now known as noncommutative geometry, has been worked out by Alain Connes [2]. He started out on this field to find a generalised understanding to cope with mathematical objects that seemed geometrical, yet escaped the standard approaches. His work has its predecessors in Gelfand and Naimark, who stated that the topology of a manifold is encoded in the algebra of complex valued functions over the manifold. Connes extended this theorem and translated the whole set of geometric data into an algebraic language. The points of the manifold are replaced by an algebra, which, inspired by quantum mechanics, acts on a Hilbert space. With help of a Dirac operator acting as well on the Hilbert space, Connes formulated a set of axioms which allows to recover the geometrical data of the manifold. These three items, the algebra, the Hilbert space and the Dirac operator are called a spectral triple. But it should be noted that the set of manifolds, i.e. space-times, which allow to be described by a spectral triple is limited. These manifolds have to be Riemannian, i.e. of Euclidian signature, and they have to admit a Dirac operator, which is not true for any manifold. The second condition presents no drawback since matter is built out of fermions and so space-time falls exactly into this class. But asking the manifold to be Euclidian, whereas special relativity requires a Lorentzian signature, poses a problem, which is still open. Nevertheless one can argue, along the line of Euclidian quantum field theory that this can be cured by Wick rotations afterwards.

The strongest point in favour of the spectral triple approach is, as the name noncommutative geometry already implies, that the whole formulation is independent of the commutativity of the algebra. So even when the algebra is noncommutative it is possible to define a geometry in a consistent way. But then the geometry gets equipped with an uncertainty relation, just as in quantum mechanics.

A third theory that proved to be at the heart of Nature's laws is Yang-Mills-Higgs

theory. The standard model of particle physics is the most prominent example. It is a classical gauge theory which describes the known elementary particles by means of the symmetries they obey, together with the electro-weak and the strong force. In contrast to general relativity, this classical field theory allows to pass over to a quantum field theory. All elementary particles are fermions and the forces acting between them are mediated by bosons. The symmetries of the theory are compact Lie groups, for the standard model of particle physics it is $U(1) \times SU(2) \times SU(3)$. Fermions are Dirac spinors, placed in multiplets which are representations of the symmetry groups. A peculiar feature of the standard model is that fermions are chiral. This means that they come in two classes, called left- and right-handed. Now the left-handed fermions form a different representation of the symmetry group as the right-handed. This poses a serious problem, since mass terms would explicitly break the symmetry. To circumvent this an extra boson, the Higgs boson, has to be introduced. Its dynamics is governed by the so called Higgs potential, which breaks at low energy the gauge symmetry and introduces mass terms for the fermions, but leaves the over-all symmetry intact. In the standard formulation of the standard model this Higgs mechanism has to be introduced by hand. It should be pointed out that the standard model of particle physics is a highly successful theory. All the non-gravitational forces and all known matter is described in a unified and beautiful way. But again it is not possible to unify it on the footing of differential geometry with general relativity. The problem is that no manifold exists, which has general coordinate transformations and a compact Lie group as its diffeomorphism group. But here the power of noncommutative geometry comes in.

The first observation is that the general coordinate transformations of a manifold correspond to the automorphisms of the algebra of complex valued functions over the manifold. Chamseddine and Connes discovered that it is possible to define an action, called the *spectral action*, to give space-time in the setting of spectral triples a dynamics, just as the Einstein-Hilbert action for general relativity. This spectral action is given by the number of eigenvalues of the Dirac operator up to a cut-off. It is most remarkable that this action reproduces the Einstein-Hilbert action in the limit of high eigenvalues of the Dirac operator. The crucial observation is now that in contrast to the diffeomorphisms of a manifold, the automorphisms of an algebra allow to be extended to include compact Lie groups. These are the automorphisms of matrix algebras. And since the whole notion of a spectral triple is independent of the commutativity of the algebra, it is possible to combine the algebra of functions over the space-time manifold with an algebra being the sum of simple matrix algebras by ten-

sorising. These combined function-matrix geometries are called *almost-commutative* geometries. The part of the spectral triple based on the matrix algebra is often called the *finite* or *internal part*. Choosing as matrix algebra $\mathbb{C} \oplus \mathbb{H} \oplus M_3(\mathbb{C})$, where \mathbb{H} are the quaternions, one recovers with a suitable choice for the Hilbert space that the spectral action reproduces the Einstein-Hilbert action and the Yang-Mills-Higgs action of the standard model. The Higgs scalar together with its potential emerge naturally as the "Einstein-Hilbert action" in the noncommutative part of the algebra. Here it has become possible for the first time to give the Higgs scalar a geometrical interpretation. In the almost-commutative setting it plays at the same time the rôle of a connection in the finite part of the geometry as well as that of the fermionic mass matrix.

As gravity emerged in the classical setting as a pseudo-force belonging to general coordinate transformation, in almost-commutative geometry the electro-weak and the strong force emerge as pseudo-forces belonging to the automorphisms of the algebra. In this spirit one can put up a table which contains the pseudo-force, the transformation which allows to convert it into a simpler force, the geometry which emerges from the respective symmetry and finally the notion of time that is appropriate.

Pseudo Force	Transformation	Simple Force	Geometry	Time
Coriolis force	rotation	no force	Euclidian	absolute
magnetic force	Lorentz transf.	electric force	Minkowski	universal
gravity	gen. coor. transf.	no force	Riemannian	proper (τ)
el.-weak, strong	gauge transf.	gravity	almost-comm.	? $\Delta\tau \sim 10^{-40}s$?

The immediate question that arises is: Which kind of Yang-Mills-Higgs theory may fit into the frame work of almost-commutative geometry? The set of all Yang-Mills-Higgs theories is depicted in figure 1.1. One sees that left-right symmetric, grand unified and supersymmetric theories do not belong to the elected group of almost-commutative models. But, as mentioned above, the standard model does.

The main task of the work presented in this thesis is to clarify the structure of this restricted sub-set of Yang-Mills-Higgs theories that originate from spectral triples. Since this is still an unscalable challenge it is necessary to adopt a minimal approach. Imposing certain constraints which are gathered from different areas reaching from Riemannian geometry over high energy physics to quantum field theory and starting out with only up to four summands in the matrix algebra part of the almost commutative geometry, one can give a classification from the particles physi-

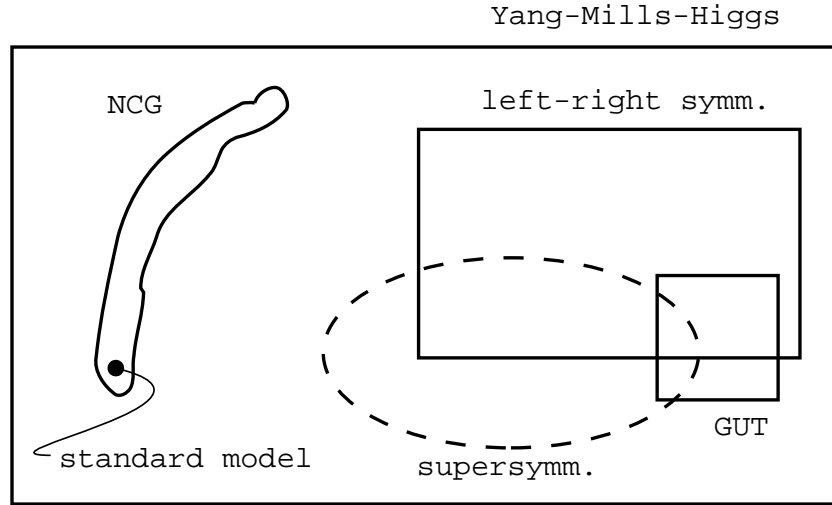

Figure 1.1: Yang-Mills-Higgs models and noncommutative geometry.

cist's point of view. As it is custom in particle physics, space-time curvature will be neglected. Nonetheless the Riemannian part of the spectral triple plays a crucial role in the spectral action, introducing derivatives and thus the gauge bosons. Setting the curvature to zero when the Einstein-Hilbert and Yang-Mills-Higgs action have been obtained from the spectral action leaves the Yang-Mills-Higgs action. With respect to this part of the spectral action the classification will be done. As a consequence only the finite matrix algebra part of the spectral triple has to be classified. The internal Dirac operator enters into the Higgs scalar and the minimum of the Higgs potential is the mass matrix of the fermions.

This classification proceeds in two steps. First all the possible finite spectral triples, with a given number of summands of simple matrix algebras, have to be found. This classification of finite spectral triples has been done in the most general setting by Paschke, Sitarz [22] and Krajewski [25]. To visualise a finite spectral triple Krajewski introduced a diagrammatic notion, the so called *Krajewski diagrams*, which encode all the algebraic data of a spectral triple. If one imposes now as a first condition that the spectral triple be irreducible, i.e. that the finite Hilbert space be as small as possible, one is led to the notion of a minimal Krajewski diagram. For a given number of algebras, the algebra representation on the Hilbert space and the possible Dirac operators are encoded in these diagrams by arrows connecting two sub-representations. Finding the minimal diagrams via this diagrammatic approach is very convenient and quite simple for up to two summands in the matrix algebra. In this case only a handful of diagrams exist and it is difficult to miss a diagram.

But with three and more algebras the task quickly becomes intractable. For three algebras it may be done by hand, but one risks to overlook some diagrams. It is thus fortunate that the diagrammatic treatment allows to translate the algebraic problem of finding spectral triples into the combinatorial problem of finding minimal Krajewski diagrams. This can then be put into a computer program. Still the problem is quite involved and the algorithm to find minimal Krajewski diagrams needs a lot of care. Furthermore the number of possible Krajewski diagrams increases rapidly with the number of summands of matrix algebras and reaches the maximal capacity of an up-to-date personal computer at five summands.

If one has found the minimal Krajewski diagrams the second major step follows. From each Krajewski diagram all the possible spectral triples have to be extracted. These are then analysed with respect to the following heteroclitic criteria:

- For simplicity and in view of the minimal approach the spectral triple should be irreducible. This means simply that the Hilbert space cannot be reduced while still obeying all the axioms of a spectral triple.
- The spectral triple should be non-degenerate, which means that the fermion masses should be non-degenerate, up to the inevitable degeneracies which are left and right, particle and antiparticle and a degeneracy due to a colour. This condition has its origin in perturbative quantum field theory and asserts that the possible mass equalities are stable under renormalisation flow.
- Another criterion also stemming from quantum field theory is that the Yang-Mills-Higgs models should be free of Yang-Mills anomalies. In hope of a possible unified quantum theory of all forces, including gravity, it is also demanded that the models be free of mixed gravitational anomalies.
- From particle phenomenology originates the condition that the representation of the little group has to be complex in each fermion multiplet, in order to distinguish particles from antiparticles.
- The last item is the requirement that massless fermions should be neutral under the little group. This is of course motivated by the Lorentz force.

Now the Higgs potential has to be minimised and the resulting models have to be compared with the above list of criteria. If a model fits all the points of the list it may be considered of physical importance, otherwise it will be discarded.

This thesis is now organised as follows: The second chapter gives a brief introduction into the standard model of particle physics and into general relativity. The main point in the treatment of general relativity is the derivation of gravity as a pseudo-force associated to generalised coordinate transformation. Since spectral triples require space-time to be of Euclidian signature a few words on Wick-rotation will be said.

The third chapter introduces the spectral triple of a 4-dimensional Riemannian spin manifold with all its necessary items and axioms. Most of the treatment will be from the physicists point of view, sometimes lacking complete mathematical rigour. Here the spectral action will be introduced which allows to recover Einsteinian gravity in the Euclidian setting. Next it will be shown how the notion of a spectral triple generalises to finite spaces with finite sums of matrix algebras. Some of the major geometrical notions such as geodesic length and dimension will be translated to the finite setting. Based on the axioms for the finite spectral triples the representation of these by Krajewski diagrams will be developed in some detail. In the last step almost-commutative spectral triples will be defined and some of their major properties highlighted.

In the fourth chapter the classification scheme of almost-commutative spectral triples will be presented. Therefore the criteria mentioned above are explained more thoroughly. Since understanding comes usually by giving a concrete example the standard model of particle physics will be treated from its Krajewski diagram to the minimisation of the Higgs potential.

This thesis is a cumulative thesis and the new scientific content is gathered in the publications attached to the end. These have been written in collaboration with Thomas Schücker, Bruno Iochum and Jan-Hendrik Jureit and are as follows:

1. *On a classification of almost-commutative spectral triples*, [7], by B. Iochum, T. Schücker and C.A.S.. This paper classifies almost-commutative Yang-Mills-Higgs models with up to three summands in the matrix algebra. This classification does not yet take into account the Yang-Mills anomalies nor the requirement that the representation of the little group should be complex. For further treatment of these issues for up to three algebras see [28].
2. *On a classification of almost-commutative spectral triples, a second helping*, [13], by J.-H. Jureit and C.A.S.. As mentioned above the search for all minimal Krajewski diagrams is a tedious task and when done by hand one risks to miss a few diagrams. The development of a computer program [12] allowed to search

for Krajewski diagrams with three algebras and surfaced four diagrams which were left out in [7]. These have been analysed again not taking into account Yang-Mills anomalies and the complex representation of the little group, which can again be found in [28].

3. *Finding the standard model of particle physics, a combinatorial problem*, [12], by J.-H. Jureit and C.A.S.. This publication explains in detail how to find all minimal Krajewski diagrams with letter changing arrows. An algorithm that allows to implement this problem on a computer is developed. It becomes apparent how a seemingly simple problem evolves into a highly complicated combinatorial structure. The program was written in C^{++} .
4. *On a classification of almost-commutative spectral triples, III*, [14], by J.-H. Jureit, T. Schücker and C.A.S.. In this publication the minimal Krajewski diagrams for four summands in the matrix algebra are analysed. These have been obtained with help of the algorithm developed in [12]. This classification exploits all the physical constraints mentioned above, including Yang-Mills anomalies and the criterion of a complex representation of the little group.

Chapter 2

The Standard Model of Particle Physics

A short survey of the standard model of elementary particle physics will be given concentrating on the classical fields. The theory of Yang-Mills-Higgs models is going to be reviewed and the ad hoc aspects of the standard model will be highlighted. The quantisation of Yang-Mills-Higgs theories is beyond the scope of this thesis, only some aspects arising from quantum corrections like mass renormalisation and anomalies will be presented briefly. In the noncommutative setting they serve to motivate some of the assumptions imposed for the classification. A thorough introduction into classical gauge theories, the necessary basics in group theory and the relevant standard references can be found in [20]. For a stronger focus on the standard model see [10, 8].

2.1 The Gauge Principle

One is interested in a theory where the fields $\Phi(x)$ transform covariantly under the Poincaré group in order that the Lagrangian and thus the action is invariant under these transformations. The unitary representation of a Poincaré transformation of $\Phi(x)$ is given by

$$(U(a, \Lambda)\Phi)(x) = D(\Lambda)\Phi(\Lambda^{-1}(x - a)), \quad (2.1)$$

where (a, Λ) are the parameters of the translation and the Lorentz transformation. To ensure renormalisability of the theory one may have scalar or pseudo-scalar fields where the representation of the Lorentz transformation is simply $D(\Lambda) = 1$. Additionally spin- $\frac{1}{2}$ fermions with a 4-dimensional representation on Dirac spinors or

a 2-dimensional representation on Weyl spinors is permitted. In the following the Poincaré invariance will be taken for granted for all appropriate quantities like fields and Lagrangians.

To construct a field theory start with the most general renormalisable matter Lagrangian for an arbitrary number of spin- $\frac{1}{2}$ Dirac or Weyl fields ψ_α , scalar fields φ_a :

$$\begin{aligned}
 -L &= \sum_{\alpha} \bar{\psi}_{\alpha} \not{\partial} \psi_{\alpha} + \frac{1}{2} \sum_a (\partial_{\mu} \varphi_a)^2 + \frac{1}{2} \sum_k (\partial_{\mu} \varphi_k)^2 + V(\varphi_a) \\
 &+ \left(\sum_{\alpha, \beta} m_{\alpha\beta} \bar{\psi}_{\alpha} \psi_{\beta} + \sum_{\alpha, \beta, a} g_{\alpha\beta}^a \bar{\psi}_{\alpha} \psi_{\beta} \varphi_a + \text{h.c.} \right) \tag{2.2}
 \end{aligned}$$

Weyl fields are included as Dirac fields satisfying the chiral condition $(1 \pm \gamma_5)\psi = 0$. The masses of the Dirac fields are encoded in the constant mass matrix $(m_{\alpha\beta})$ and the Yukawa couplings are given by the constants $g_{\alpha\beta}^a$. $V(\varphi_a)$ is a polynomial of fourth degree which is bounded from below. Any gauge theory will be based on such a Lagrangian.

One may now specialise our theory based on the Lagrangian 2.2 by incorporating further symmetries. In the spirit of the Poincaré symmetry the fields $\Phi(x)$ ($\Phi(x) = \psi(x)$ or $\varphi(x)$) will now be multiplet representations of a rigid (space-time independent) finite-dimensional compact Lie group G . The representation $U(u)$, $u \in G$, on a field will be required to be unitary in order to preserve the inner product of the fields and thus probability. A representation will be called *chiral* if it couples differently to left and right fields. If the representation is the same on left and right fields it is called *vectorial*. Furthermore the Lagrangian 2.2 will be demanded to be invariant under the group G . In a compactified notation this reads

$$L(\Phi, \partial\Phi) = L(U(u)\Phi, \partial U(u)\Phi). \tag{2.3}$$

The requirement of invariance reduces of course the number of independent constants in the Lagrangian. Chiral representations for example require the respective mass matrix of the fields to be zero, since chiral masses break the symmetry. The representation will in general not be the same for different fields nor will it necessarily be irreducible. As a consequence of these extra continuous symmetries one has new Noether currents and Noether charges.

The next step in our journey will be to gauge the rigid symmetry, i.e. to impose a dependence on the space-time M . It was Weyl who introduced the gauge procedure

in order to unify electro-magnetism with the general theory of relativity. While in his approach the scale invariance of the metric in general relativity was made local here the Lie group G will be gauged in the sense of Yang and Mills,

$$\begin{aligned} G &\rightarrow \{\text{differentiable maps from } M \text{ to } G\} \\ u &\mapsto u(x). \end{aligned} \tag{2.4}$$

An immediate consequence is that the invariant Lagrangian 2.2 is no longer invariant under $U(u(x))$. This is obvious since the representation no longer commutes with the derivative.

$$\begin{aligned} \partial_\mu U(u(x))\Phi(x) &\neq U(u(x))\partial_\mu\Phi(x) \quad \text{but} \\ \partial_\mu U(u(x))\Phi(x) &= (\partial_\mu U(u(x)))\Phi(x) + U(u(x))\partial_\mu\Phi(x). \end{aligned} \tag{2.5}$$

To cure this shortcoming one introduces a gauge connection or gauge field $A_\mu^k(x)$ (explicit space-time dependence will be suppressed in the following) which transforms *inhomogeneously* under the gauge group as

$$A_\mu^k \rightarrow UA_\mu^k U^{-1} + U\partial_\mu U^{-1}. \tag{2.6}$$

These gauge fields are identified with the force mediating gauge bosons of the physical theory. The derivative is generalised to the covariant derivative

$$D_\mu = \partial_\mu + gA_\mu^k \sigma_k, \tag{2.7}$$

σ_k being the generators of the group G in the appropriate representation and g is the coupling constant. The covariant derivative commutes with $U(u(x))$ and substituting it for the partial derivative will render the Lagrangian invariant with respect to local gauge transformations:

$$L(\Phi, D\Phi) = L(U(u(x))\Phi, DU(u(x))\Phi). \tag{2.8}$$

Abbreviating $A_\mu = A_\mu^k \sigma_k$ the gauge curvature of field strength

$$F_{\mu\nu} = g^{-1}[D_\mu, D_\nu] = \partial_\mu A_\nu - \partial_\nu A_\mu + g[A_\mu, A_\nu] \tag{2.9}$$

is introduced, which transforms *homogeneously* under gauge transformations as

$$F_{\mu\nu} = UF_{\mu\nu}U^{-1}. \quad (2.10)$$

In proper mathematical terms the gauge connection A_μ would be the connection of the principal G -bundle over Minkowski space and $F_{\mu\nu}$ its curvature. Now a kinetic term for the gauge connection is introduced and the Lagrangian is enlarged to the so called gauged Lagrangian

$$L(A, \Phi) = -\frac{1}{4}\text{tr}(F_{\mu\nu}F^{\mu\nu}) + L(\Phi, D\Phi). \quad (2.11)$$

The trace is being taken over the internal indices of the gauge multiplet. As a simple example take as rigid group $G = U(1)$ represented on Dirac spinors $\psi(x)$ as

$$U(H)\psi(x) = e^{-ieH}\psi(x) \quad (2.12)$$

and the Dirac Lagrangian

$$L_D(\psi, \partial\psi) = \bar{\psi}\not{\partial}\psi - m\bar{\psi}\psi. \quad (2.13)$$

Gauging the group with $H \rightarrow H(x)$ and gauging the Lagrangian leads immediately to the Maxwell-Dirac Lagrangian

$$L_{\text{MD}}(\psi, \partial\psi) = \bar{\psi}(\not{\partial} - e\not{A})\psi - m\bar{\psi}\psi + \frac{1}{4}F_{\mu\nu}F^{\mu\nu}, \quad (2.14)$$

where the coupling constant e is the electric charge of the electron and $\not{A} = i\gamma^\mu A_\mu$.

2.2 Spontaneous Symmetry Breaking

From the transformation properties of the gauge field 2.6 it becomes immediately clear that no mass term for the gauge fields can be added to the Lagrangian, since it would break gauge invariance. But it is known from experiment that there exist massive gauge bosons. The Meissner effect in superconductivity is due to a massive photon and the weak force is mediated by the massive vector bosons W^\pm and Z^0 . To introduce mass into the Lagrangian a closer inspection of the scalar potential $V(\varphi)$ in 2.2 will help.

Since the components of the Lagrangian are invariant under G we have of course

for any $u \in G$

$$V(U(u)\varphi) = V(\varphi). \quad (2.15)$$

But the constant minimum $\overset{\circ}{\varphi}$ of the scalar potential is in general not invariant under the whole gauge group G but has a subgroup $H \subset G$ as invariance group, the so called *little group*. That means if $\overset{\circ}{\varphi}$ minimises $V(\varphi)$ then $U(\overset{\circ}{u}) \overset{\circ}{\varphi} = \overset{\circ}{\varphi}$ with $\overset{\circ}{u} \in H$ and $U(u) \overset{\circ}{\varphi}$ is in the minimum of $V(\varphi)$ for all $u \in G$. The generators of G which do not leave the minimum invariant are called *broken*. If the minimum of $V(\varphi)$ is $\overset{\circ}{\varphi} = 0$ the subgroup is $H = G$. But if the minimum is non-trivial, $\overset{\circ}{\varphi} \neq 0$, one can, in view of the perturbative formulation of quantum field theory (QFT), expand the Lagrangian 2.11 around this minimum

$$L(A, \psi, \varphi(x)) \rightarrow L(A, \psi, H). \quad (2.16)$$

The new scalar field $H(x)$ is a small deviation from the minimum

$$H(x) = \varphi(x) - \overset{\circ}{\varphi}. \quad (2.17)$$

It is clear that the low energy limit Lagrangian $L(A, \psi, H)$ is invariant only with respect to the little group. The effect of the spontaneous symmetry breaking is that new mass terms are introduced. The gauge bosons, the Dirac fermions and the scalars will be reviewed briefly.

Through the constant minimum $\overset{\circ}{\varphi}$ some of the gauge bosons A_μ will acquire H -invariant masses via the kinetic term of $\overset{\circ}{\varphi}$:

$$\frac{1}{2}(D_\mu \overset{\circ}{\varphi})^2 = \frac{1}{2}g^2(A_\mu \overset{\circ}{\varphi})^2 = \frac{1}{2}M_{kl}A_\mu^k A_\mu^l, \quad M_{kl} = g^2(\sigma_k \overset{\circ}{\varphi}, \sigma_l \overset{\circ}{\varphi}). \quad (2.18)$$

Here g is the gauge coupling constant, (φ, φ') the respective inner product and σ_k the generators of the φ -representation. Not all the eigenvalues of the mass matrix M_{kl} are necessarily non-zero.

The Yukawa terms coupling the scalar field φ to the Dirac spinors ψ will produce in the expansion around the minimum an extra mass term

$$\bar{\psi}_\alpha m_{\alpha\beta} \psi_\beta + \bar{\psi}_\alpha G_{\alpha\beta}^a \overset{\circ}{\varphi}_a \psi_\beta. \quad (2.19)$$

The new mass matrix is then given by $m'_{\alpha\beta} = m_{\alpha\beta} + G_{\alpha\beta}^a \overset{\circ}{\varphi}_a$. It is again not required

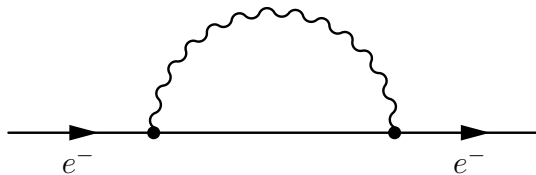

Figure 2.1: One-loop electron self-energy Feynman diagram

that all eigenvalues of $m'_{\alpha\beta}$ be non-zero. A gauge group G_C will be called a *colour group* if its representation commutes with the mass matrix, i.e. the mass matrix of the respective fermion multiplet is a multiple of the unity matrix. Nonetheless a colour group may be broken by the Higgs potential, for example if the scalar field does not couple via a Yukawa coupling to the fermion multiplet. Generically the scalar field would then give different masses to the gauge fields associated with the colour group.

Assuming the scalar potential $V(\varphi)$ to be a fourth order polynomial it can be expanded explicitly around $\overset{\circ}{\varphi}$:

$$V(\theta) = V(\varphi) - V(\overset{\circ}{\varphi}) = \frac{1}{2!}V_{\alpha\beta}H^\alpha H^\beta + \frac{1}{3!}V_{\alpha\beta\gamma}H^\alpha H^\beta H^\gamma + \frac{1}{4!}V_{\alpha\beta\gamma\delta}H^\alpha H^\beta H^\gamma H^\delta \quad (2.20)$$

where

$$V_{\alpha\beta} = \left(\frac{\partial^2 V}{\partial \varphi_\alpha \partial \varphi_\beta} \right)_{\varphi=\overset{\circ}{\varphi}}, \text{ etc.} \quad (2.21)$$

Since $\overset{\circ}{\varphi}$ is a minimum the symmetric mass matrix $V_{\alpha\beta}$ has to be positive. The Goldstone theorem for rigid G states now that $V_{\alpha\beta}$ cannot be positive-definite, but has at least $\dim G/H$ zero eigenvalues. So there are at least $\dim G/H$ massless scalar fields, the so called Goldstone bosons.

Since these massless fields are unphysical, i.e. they have never been observed, they are to be eliminated. When the rigid group G is gauged the *Higgs mechanism* uses the potential A_μ to absorb the Goldstone bosons by choosing a suitable gauge. The resulting theory has then the desired massive gauge bosons plus a number of massive scalar fields, called the Higgs bosons.

2.3 Renormalisation Constraints

As mentioned above the QFT of Yang-Mills-Higgs-theories is beyond the scope of this thesis. But since some aspects of renormalisation like running masses and anomalies

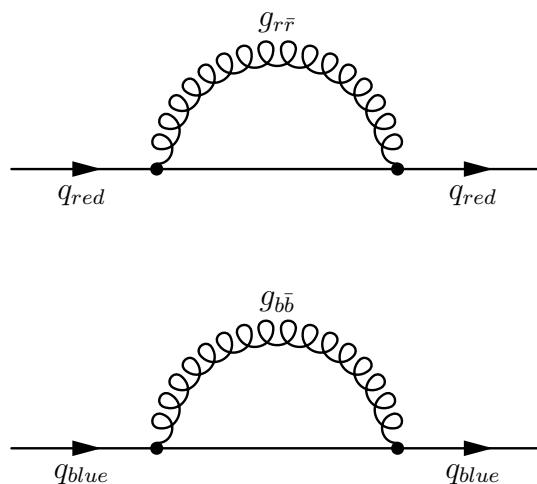

Figure 2.2: One-loop quark self-energy Feynman diagram

play a central role in the latter classification of almost-commutative geometries, some words on these topics are useful.

If one passes over from the classical Lagrangians 2.2 or 2.16 to QFT the masses and coupling constants turn out not to be the physical entities, i.e. they are not the masses and charges measured in experiments. For example the self-energy term of the electron as depicted in the Feynman diagram figure 2.1 is divergent and has to be renormalised.

The renormalisation procedure leads to renormalisation group equations which produce the renormalisation flows. As a result the particle masses and the couplings become energy dependent. For unbroken colour groups the masses of the colour multiplet stay degenerate under the renormalisation flow. If the colour group is broken this is no longer true since the gauge bosons possess different masses. Take the strong force with three coloured quarks as an example. The leading self-energy term for a red and a blue quark with red-antired and blue-antiblue gluons, see figure 2.2, will cause the masses of the quarks to develop differently under the renormalisation flow if the gluon masses do not coincide.

For a Yang-Mills-Higgs theory to be renormalisable there are two major constraints. The Higgs potential has to be a polynomial of maximal degree four, bounded from below. And the theory has to be free of anomalies. An anomaly is defined as a classical symmetry of the Lagrangian that is not respected by quantum corrections. In general such violations of the classical symmetry lead to nonrenormalisable theories, but for certain models, like the standard model, the anomalies cancel out. Being free of anomalies will be a major constraint in the classification of almost-commutative geometries. The two anomalies which have to be considered are the axial anomaly

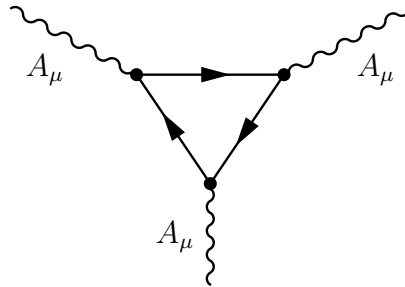

Figure 2.3: Feynman diagram of the Yang-Mills anomaly

due to Adler and Bardeen, figure 2.3, and the slightly speculative mixed gravitational anomaly, figure 2.4.

From the axial fermion coupling in the Lagrangian stems the conserved axial current

$$j_\mu^a = \bar{\psi} \gamma_5 \gamma_\mu \sigma^a \psi, \quad (2.22)$$

which is conserved on the classical level, $\partial_\mu j_\mu^a = 0$. After passing over to the QFT this is no longer true,

$$\partial_\mu j_\mu^a = \frac{g^2}{24\pi^2} T_{bc}^a(U) G^{bc}(A_\mu), \quad (2.23)$$

where the $G^{bc}(A_\mu)$ are pseudo-scalars which only depend on the gauge bosons and the $T_{bc}^a(U)$ are constants which depend only on the fermion representation of the gauge group. This anomaly always destroys the renormalisability of the QFT and so $T_{bc}^a(U) = 0$ has to be imposed. A treatment to first order of the loop expansion turns out to be sufficient and the anomalous triangle feynman graph is depicted in figure 2.3. There exists a simple way to express $T_{bc}^a(U)$ in terms of the generators $\sigma_{L,R}$ of the left- and right-handed fermion representations:

$$T_{bc}^a = L_{bc}^a - R_{bc}^a, \quad \text{where } (L, R)_{bc}^a = \text{tr} \sigma_{L,R}^a \{ \sigma_{L,R}^b, \sigma_{L,R}^c \}. \quad (2.24)$$

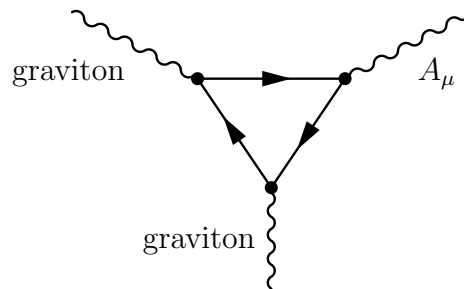

Figure 2.4: Feynman diagram of the mixed gravitational anomaly

The mixed gravitational anomaly is based on the assumption that a graviton should couple essentially the same way as the other gauge bosons. It should have a similar triangle diagram, see figure 2.4 as the Yang-Mills anomaly and takes a particularly simple form expressed in terms of generators. Again the vanishing of the anomaly only depends on the choice of the left- and right-handed fermion representation

$$\widetilde{T}^a = \text{tr}\sigma_L^a - \text{tr}\sigma_R^a. \quad (2.25)$$

A more thorough introduction into the topic on anomalies, index theorems and their applications in QFT can be found in [23].

2.4 How to Build a Gauge Theory

Iliopoulos [15] gave a recipe to find a physically relevant Yang-Mills-Higgs theory, which was meant as a joke but soon became the standard procedure:

1. Choose a gauge group G with N generators.
2. Choose the the matter fields (Dirac fermions, scalars, etc.) as representations of G .

3. Construct a covariant derivative by choosing the gauge bosons in a representation of G .
4. Write the most general renormalisable Lagrangian invariant under G .
5. Find the minimum of the Higgs potential and develop the Lagrangian to first order around this minimum. Now some of the gauge bosons and matter fields may acquire mass terms from spontaneous symmetry breaking.
6. Use the QFT of the model to obtain predictions.
7. Ask an experimentalist whether the predictions have any resemblance with Nature.
8. If the answer is “Yes” publish it. If the answer is “No” restart at 1.

2.5 The Standard Model

The standard model of particle physics is the result of a long series of trial and error, e.g. repeated use of Iliopoulos’ recipe. It took over thirty years to adjust the theory to the experimental data. The winner until further notice is a theory possessing only Dirac fermions, a Higgs doublet and as gauge group $SU(2)_W \times U(1)_Y \times SU(3)_C$. All the fermions are tensor products of the fundamental representations or the one dimensional representations of isospin group $SU(2)_W$, the hypercharge group $U(1)_Y$ and the colour group $SU(3)_C$. A table of the representations is given in figure 2.5. There is a subtlety concerning the d , s and the b quarks. They are the physical quarks, i.e. the eigenstates of the mass matrix and are obtained from the weak eigenstates d' , s' and the b' by a unitary transformation, the Cabibo-Kobayashi-Maskawa matrix U_{CKM} :

$$\begin{pmatrix} d' \\ s' \\ b' \end{pmatrix} = U_{CKM} \begin{pmatrix} d \\ s \\ b \end{pmatrix} \quad (2.26)$$

The Higgs scalar is an isospin doublet and a colour singlet. Its representation is given in figure 2.6.

The gauge connections are in the adjoint representations and the covariant deriva-

				$SU(2)_W$	$U(1)_Y$	$SU(3)_C$
$Q_L^i =$	$\begin{pmatrix} u_L \\ d_L' \end{pmatrix}$	$\begin{pmatrix} c_L \\ s_L' \end{pmatrix}$	$\begin{pmatrix} t_L \\ b_L' \end{pmatrix}$	2	$\frac{1}{6}$	3
$u_R^i =$	u_R	c_R	t_R	1	$-\frac{2}{3}$	3
$d_R^i =$	d_R'	s_R'	b_R'	1	$\frac{1}{3}$	3
$L_L^i =$	$\begin{pmatrix} \nu_{eL} \\ e_L \end{pmatrix}$	$\begin{pmatrix} \nu_{\mu L} \\ \mu_L \end{pmatrix}$	$\begin{pmatrix} \nu_{\tau L} \\ \tau_L \end{pmatrix}$	2	$-\frac{1}{2}$	1
$e_R^i =$	e_R	μ_R	τ_R	1	1	1

Figure 2.5: Fermionic representations of $SU(2)_W \times U(1)_Y \times SU(3)_C$

tives come in a left and a right version for leptons and quarks and a Higgs version:

$$\begin{aligned}
D_L^Q &= \partial_\mu + igW_\mu^k \frac{\tau_k}{2} + ig' \frac{Y_W}{2} B_\mu + ig_3 G_\mu^a t_a \\
&= \partial_\mu + igW_\mu + ig' \frac{Y_W}{2} B_\mu + ig_3 G_\mu \\
D_R^Q &= \partial_\mu + ig' \frac{Y_W}{2} B_\mu + ig_3 G_\mu^a t_a = \partial_\mu + ig' \frac{Y_W}{2} B_\mu + ig_3 G_\mu \\
D_L^L &= \partial_\mu + igW_\mu^k \frac{\tau_k}{2} + ig' \frac{Y_W}{2} B_\mu = \partial_\mu + igW_\mu + ig' \frac{Y_W}{2} B_\mu \\
D_R^L &= \partial_\mu + ig' \frac{Y_W}{2} B_\mu \\
D^H &= \partial_\mu + igW_\mu^k \frac{\tau_k}{2} + ig' \frac{Y_W}{2} B_\mu = \partial_\mu + igW_\mu + ig' \frac{Y_W}{2} B_\mu \quad (2.27)
\end{aligned}$$

Here Y_W is the hypercharge of $U(1)_Y$, τ_i and t_i are the generators of $SU(2)_L$ and $SU(3)_C$, and g , g' and g_3 are the coupling constants of $SU(2)$, $U(1)$ and $SU(3)$.

The gauge curvatures are given by

$$\begin{aligned}
W_{\mu\nu} &= \partial_\mu W_\nu - \partial_\nu W_\mu - g[W_\mu, W_\nu] \\
B_{\mu\nu} &= \partial_\mu B_\nu - \partial_\nu B_\mu \\
G_{\mu\nu} &= \partial_\mu G_\nu - \partial_\nu G_\mu - g_3[G_\mu, G_\nu]. \quad (2.28)
\end{aligned}$$

The experimental fact that the weak interaction breaks parity maximally leads to the

$$\phi = \begin{array}{ccc} \underline{SU(2)_W} & \underline{U(1)_Y} & \underline{SU(3)_C} \\ \begin{pmatrix} \phi^+ \\ \phi^0 \end{pmatrix} & 2 & \frac{1}{2} & 1 \end{array}$$

Figure 2.6: Higgs representation of $SU(2)_W \times U(1)_Y \times SU(3)_C$

standard model Lagrangian

$$L_{SM} = L_{gauge} + L_{fermion} + L_{Higgs} + L_{Yukawa}, \quad (2.29)$$

where

$$\begin{aligned} L_{gauge} &= -\frac{1}{4}\text{tr}(W_{\mu\nu}W^{\mu\nu}) - \frac{1}{4}B_{\mu\nu}B^{\mu\nu} - \frac{1}{4}\text{tr}(G_{\mu\nu}G^{\mu\nu}), \\ L_{fermion} &= i \sum_{i=e,\mu,\tau} \bar{L}_L^i D_L^L L_L^i + i \sum_{i=e,\mu,\tau} \bar{e}_R^i D_R^L e_R^i \\ &\quad + i \sum_{i=u,c,t} \bar{Q}_L^i D_L^Q Q_L^i + i \sum_{i=u,c,t} \bar{u}_R^i D_R^Q u_L^i + i \sum_{i=d,s,b} \bar{d}_R^i D_R^Q d_L^i \\ L_{Higgs} &= (D^H \phi)^* D^H \phi - V(\phi) \\ L_{Yukawa} &= - \sum_{i=e,\mu,\tau} \kappa_i \bar{L}_L^i \phi e_R^i - \text{h.c.} + \text{analogous quark terms.} \end{aligned} \quad (2.30)$$

There are no explicit mass terms since they would break gauge invariance due to the chiral structure. It should be noted that the Yukawa couplings κ_i and their quark analogs can be chosen freely and have to be determined by experimental data. The Higgs potential is chosen to be

$$V(\phi) = -\frac{\mu^2}{2}\phi^* \phi + \lambda(\phi^* \phi)^2, \quad \lambda > 0 \quad (2.31)$$

and has a minimum at

$$\phi = \begin{pmatrix} 0 \\ v/\sqrt{2} \end{pmatrix}, \quad v = \sqrt{\frac{\mu^2}{4\lambda}}. \quad (2.32)$$

This minimum breaks the $SU(2)_W \times U(1)_Y$ part of the gauge group down to the electromagnetic gauge group $U(1)_{em}$. The resulting three Goldstone bosons $\theta_a(x)$ associated to the three broken generators τ^a can be eliminated by a generalised gauge

rotation

$$\phi(x) = \exp\left(i\frac{\theta_a(x)\tau^a}{v}\right) \begin{pmatrix} 0 \\ \frac{1}{\sqrt{2}}(v + H(x)) \end{pmatrix}. \quad (2.33)$$

This gauge transformation will be absorbed by the the three massive gauge fields. The real field $H(x)$ is the physical Higgs scalar which still awaits its experimental discovery.

The mass eigenstates of the gauge bosons are linear combination of the W_μ^k and B_μ . They constitute the physical gauge bosons of the weak interaction W_μ^\pm and Z_μ^0 and the photon A_μ and are given, with their respective masses, by

$$\begin{aligned} W_\mu^\pm &= \frac{1}{\sqrt{2}}(W_\mu^1 \mp iW_\mu^2), & M_{W^\pm} &= \frac{1}{2}gv, \\ Z_\mu^0 &= \cos\theta_w W_\mu^3 - \sin\theta_w B_\mu, & M_{Z^0} &= \frac{M_{W^\pm}}{\cos\theta_w}, \\ A_\mu &= \sin\theta_w W_\mu^3 + \cos\theta_w B_\mu, & M_A &= 0, \end{aligned} \quad (2.34)$$

where $\tan\theta_w = g'/g$ defines the weak angle θ_w .

The standard model of particle physics has a number of intriguing properties that explain why it took so long to complete it:

- All fermions are in the fundamental or in the one dimensional representation of the gauge group.
- The representation of $SU(3)$ is vectorial, so the gluons couple in the same way to left- and right-handed quarks. Leptons are colour blind.
- $SU(3)$ is an unbroken colour group, since the Higgs scalar is a colour singlet. Its representation commutes with the quark mass matrix and all quarks in each colour triplet have the same mass. Since the colour is unbroken this mass relation stays untouched by the renormalisation group flow.
- The fermion masses are non-degenerate, the only exception being the colour degeneracy of the quark masses in the colour triplets.
- The left fermions are $SU(2)$ doublets and the right fermions are singlets. Parity is broken maximally by the weak interaction.
- The Higgs scalar is an isospin doublet and hence the gauge group is broken and the gauge bosons W_μ^\pm and Z_μ^0 acquire masses.

- The photon is massless and couples vectorially.

It takes a good deal of fine tuning of the representations and the hypercharges to achieve all these features, especially the last one. Most of the choices are completely ad-hoc and have to be carefully adjusted to match the experimental data.

2.6 General Relativity

In the classification of almost-commutative geometries, following in the later chapters, the aspect of general relativity will play the role of a mediator only. Therefore a short and rather incomplete account shall be sufficient, for an introduction see [9].

General relativity will be regarded as a theory of the dynamics of spacetime itself. It is thus not necessarily Einsteinian general relativity but may be any background independent or diffeomorphism invariant theory of the dynamics of Riemannian or pseudo-Riemannian manifolds. For the moment only the Einstein-Hilbert term will be taken into account, but in the noncommutative setting extra terms will appear in the Lagrangian.

The dynamical fields in general relativity are the components of the metric tensor $g_{\mu\nu}$ of the spacetime manifold M with respect to coordinates x^μ . If one starts out with a flat 4-dimensional Minkowski space, with signature $(+, -, -, -)$ and metric $\eta_{\mu\nu}$, with respect to cartesian coordinates \tilde{x}^μ , a freely falling particle on the trajectory $\tilde{x}^\lambda(s)$ will satisfy Newtons equation of motion

$$\frac{d^2 \tilde{x}^\lambda(s)}{ds^2} = 0, \quad (2.35)$$

where p parametrises the trajectory. A general coordinate transformation $x^\lambda = \sigma^\lambda(\tilde{x})$ will introduce pseudo forces

$$\frac{d^2 \tilde{x}^\lambda(s)}{ds^2} = -\Gamma_{\mu\nu}^\lambda \frac{dx^\mu}{ds} \frac{dx^\nu}{ds}, \quad (2.36)$$

via the Levi-Civita connection

$$\Gamma_{\mu\nu}^\lambda = \frac{1}{2} g^{\lambda\kappa} \left[\frac{\partial}{\partial x^\mu} g_{\kappa\nu} + \frac{\partial}{\partial x^\nu} g_{\kappa\mu} - \frac{\partial}{\partial x^\kappa} g_{\mu\nu} \right], \quad (2.37)$$

with

$$g_{\mu\nu}(x) = \mathcal{J}(x)^{-1\tilde{\mu}}{}_\mu \eta_{\tilde{\mu}\tilde{\nu}} \mathcal{J}(x)^{-1\tilde{\nu}}{}_\nu, \quad \mathcal{J}(\tilde{x})^\mu{}_{\tilde{\mu}} := \frac{\partial \sigma^\mu(\tilde{x})}{\partial \tilde{x}^{\tilde{\mu}}}. \quad (2.38)$$

By promoting $g_{\mu\nu}$ to be a dynamical variable the metric will no longer be flat and the pseudo forces are promoted to real forces. The potential of the gravitational force is now the metric $g_{\mu\nu}$.

Since the energy-momentum tensor $T_{\mu\nu}$ of matter should be the source of gravity, the dynamics of the metric should also be dictated by $T_{\mu\nu}$. So a covariant tensor of degree 2 has to be constructed from $g_{\mu\nu}$. For Einsteinian general relativity this leads to the celebrated Einstein field equations

$$R_{\mu\nu} - \frac{1}{2}R g_{\mu\nu} - \Lambda_c g_{\mu\nu} = \frac{8\pi G}{c^4} T_{\mu\nu}. \quad (2.39)$$

The curvature tensors involved are:

the Riemann tensor: $R_{\mu\nu\kappa}^{\lambda} = \partial_{\nu}\Gamma_{\mu\kappa}^{\lambda} - \partial_{\kappa}\Gamma_{\mu\nu}^{\lambda} + \Gamma_{\mu\kappa}^{\eta}\Gamma_{\nu\eta}^{\lambda} - \Gamma_{\mu\nu}^{\eta}\Gamma_{\kappa\eta}^{\lambda}$,

the Ricci tensor: $R_{\mu\kappa} = R_{\mu\lambda\kappa}^{\lambda}$,

the curvature scalar: $R = g^{\mu\nu} R_{\mu\nu}$.

Λ_c is the cosmological constant, which from latest observations is positive. The Einstein field equations can be derived via the Euler-Lagrange variational principle from the Einstein-Hilbert action

$$S_{EH}[g] = -\frac{1}{16\pi G} \int_M \sqrt{g} R d^4x - \frac{2\Lambda_c}{16\pi G} \int_M \sqrt{g} d^4x, \quad (2.40)$$

with the Einstein-Hilbert Lagrangian

$$L_{EH} = -\sqrt{g} \left(\frac{1}{16\pi G} R + \frac{2\Lambda_c}{16\pi G} \right), \quad (2.41)$$

where $g = \det g_{\mu\nu}$. Combined with the Lagrangian of the standard model 2.29 as matter source this gives the full classical Lagrangian of all known fermions and all four forces:

$$L = L_{EH} + \sqrt{g} L_{SM}. \quad (2.42)$$

Here one has to include into the Dirac operator a spin connection, which ensures its covariance on a curved manifold.

2.7 The Euclidian Lagrangian

Noncommutative geometry in Connes' sense requires the Dirac action to be a scalar product and thus the metric has to be Riemannian, i.e. of signature $(+, +, +, +)$. With a certain amount of care the combined Lagrangian 2.42 can be Wick rotated to the Lagrangian L^E with Euclidian signature. This rotation results in a change of sign for the cosmological part, the gauge part, the Yukawa part and the scalar potential in the Lagrangian. Putting everything together one finds the Euclidian Lagrangian

$$\begin{aligned}
L^E = & \sqrt{g} \left[-\frac{1}{16\pi G} R + \frac{2\Lambda_c}{16\pi G} \right. \\
& + \frac{1}{4} \text{tr}(W_{\mu\nu} W^{\mu\nu}) + \frac{1}{4} B_{\mu\nu} B^{\mu\nu} + \frac{1}{4} \text{tr}(G_{\mu\nu} G^{\mu\nu}) \\
& + i \sum_{i=e,\mu,\tau} L_L^{*i} D_L^L L_L^i + i \sum_{i=e,\mu,\tau} e_R^{*i} D_R^L e_R^i \\
& + i \sum_{i=u,c,t} Q_L^{*i} D_L^Q Q_L^i + i \sum_{i=u,c,t} u_R^{*i} D_R^Q u_L^i + i \sum_{i=d,s,b} d_R^{*i} D_R^Q d_L^i \\
& + (D^H \phi)^* D^H \phi + V(\phi) \\
& \left. + \sum_{i=e,\mu,\tau} \kappa_i L_L^{*i} \phi e_R^i + \text{h.c.} + \text{analogous quark terms} \right]. \quad (2.43)
\end{aligned}$$

Since the metric is now Riemannian, the Dirac inner product

$$(\psi, \psi)_{\text{Dirac}} = \int_{M_{\text{Lorenz}}} \psi^* \gamma_0 \psi d^4 x \quad (2.44)$$

goes over into the Euclidian inner product

$$(\psi, \psi)_{\text{Euclid}} = \int_{M_{\text{Euclid}}} \psi^* \psi d^4 x. \quad (2.45)$$

A further subtlety that occurs is the necessity of a fermion doubling. It is no longer possible to define mass terms and kinetic terms of chiral fermions by projecting out

the left- and right-handed part of the Dirac spinor. In the Lorentzian case one has

$$\begin{aligned}
(\psi, \psi)_{\text{Dirac}} &= m \int_{M_{\text{Lorentz}}} \psi^* \gamma_0 \frac{\mathbb{1}_4 - \gamma_5}{2} \psi d^4x + m \int_{M_{\text{Lorentz}}} \psi^* \gamma_0 \frac{\mathbb{1}_4 + \gamma_5}{2} \psi d^4x \\
&= \int_{M_{\text{Lorentz}}} \psi^{R*} \gamma_0 \psi^L d^4x + \int_{M_{\text{Lorentz}}} \psi^{L*} \gamma_0 \psi^R d^4x \\
&= (\psi^R, \psi^L)_{\text{Dirac}} + (\psi^L, \psi^R)_{\text{Dirac}}, \tag{2.46}
\end{aligned}$$

$$\begin{aligned}
(\psi, \not{\partial}\psi)_{\text{Dirac}} &= \int_{M_{\text{Lorentz}}} \psi^* \gamma_0 \not{\partial} \frac{\mathbb{1}_4 - \gamma_5}{2} \psi d^4x + \int_{M_{\text{Lorentz}}} \psi^* \gamma_0 \not{\partial} \frac{\mathbb{1}_4 + \gamma_5}{2} \psi d^4x \\
&= \int_{M_{\text{Lorentz}}} \psi^{L*} \gamma_0 \not{\partial} \psi^L d^4x + \int_{M_{\text{Lorentz}}} \psi^{R*} \gamma_0 \not{\partial} \psi^R d^4x \\
&= (\psi^L, \not{\partial}\psi^L)_{\text{Dirac}} + (\psi^R, \not{\partial}\psi^R)_{\text{Dirac}}. \tag{2.47}
\end{aligned}$$

Since in Euclidian space-time the inner product does not contain γ_0 , this split is no longer possible:

$$\begin{aligned}
(\psi, \psi)_{\text{Euclid}} &= \int_{M_{\text{Euclid}}} \psi^* \frac{\mathbb{1}_4 - \gamma_5}{2} \psi d^4x + \int_{M_{\text{Euclid}}} \psi^* \frac{\mathbb{1}_4 + \gamma_5}{2} \psi d^4x \\
&= \int_{M_{\text{Euclid}}} \psi^{L*} \psi^L d^4x + \int_{M_{\text{Euclid}}} \psi^{R*} \psi^R d^4x \\
&= (\psi^L, \psi^L)_{\text{Euclid}} + (\psi^R, \psi^R)_{\text{Euclid}}, \tag{2.48}
\end{aligned}$$

$$\begin{aligned}
(\psi, \not{\partial}\psi)_{\text{Euclid}} &= \int_{M_{\text{Euclid}}} \psi^* \not{\partial} \frac{\mathbb{1}_4 - \gamma_5}{2} \psi d^4x + \int_{M_{\text{Euclid}}} \psi^* \not{\partial} \frac{\mathbb{1}_4 + \gamma_5}{2} \psi d^4x \\
&= \int_{M_{\text{Euclid}}} \psi^{R*} \not{\partial} \psi^L d^4x + \int_{M_{\text{Euclid}}} \psi^{L*} \not{\partial} \psi^R d^4x \\
&= (\psi^R, \not{\partial}\psi^L)_{\text{Euclid}} + (\psi^L, \not{\partial}\psi^R)_{\text{Euclid}}. \tag{2.49}
\end{aligned}$$

To cure this shortcoming, the left and right spinors are treated as independent objects. Their appropriate interactions are put in by hand and after Wick rotating to Minkowski space and reintroduction of the Dirac inner product the superfluous degrees of freedom are projected out.

Chapter 3

Noncommutative Geometry

The aim of this chapter is to repeat the derivation of Einstein in a generalised way. Gravity turned out to be nothing but a pseudo-force having its origins in coordinate transformations and one is tempted to include the two forces of the standard model, the electro-weak and the strong force, into this framework. This program necessitates a fundamental twist in the way one should see the measurement of length. Since 1983 the meter is no longer defined to be rod made of a 90% platinum and 10% iridium but as the distance the light travels in vacuum in $1/299792458$ second. So geometry should consequently be renamed chronometry. The entities used to define a second are nothing but the excitation states of fermions, i.e. electrons, bound in a potential such as a caesium atom. Consequently geometry should be viewed with the eyes of a fermion and one could ask the question: How would an electron do general relativity? This point of view is essentially the same as Marc Kac's famous question: Can one hear the shape of a drum? The ear is replaced by a fermion and the shape of the drum is space-time, or now more correctly time-space.

In the realm of classical differential geometry the playground to describe spinors and their dynamics in curved space is a Riemannian or pseudo-Riemannian spin manifold. A spin manifold can be thought of as a manifold which admits a spinor bundle or spin structure, i.e. it is possible to associate to each point of the manifold a spinor space in a continuous way. For technical reasons the manifold will be taken to be compact, to allow discrete eigenvalues for the Dirac operator, Riemannian (with Euclidian signature) and orientable. In the models studied below it will always be possible to Wick rotate the final theory to a pseudo-Riemannian manifold with Minkowskian signature. The manifold will be taken to be 4-dimensional since this appears to be the dimension chosen by nature. Most 4-dimensional, orientable com-

pact Riemannian manifolds will allow a spin structure, examples being the 4-torus and the 4-sphere. In fact all parallelisable manifolds are spin manifolds.

Now it is time to change the point of view and leave the basic ingredients of classical differential geometry behind. Instead of a manifold, its metric, and spin structure the new actors will be the C^∞ -functions on the manifold, the Dirac operator and the fermion. The inspiration for this translation is drawn from quantum mechanics.

3.1 Riemannian Spinmanifolds as Spectral Triples

Starting out with the phase space M_P of a classical system \mathcal{S} , a classical observable is defined to be a differentiable function f on M_P . Time is considered to be a separate parameter. An example would be \mathbb{R}^2 being the phase space of an harmonic oscillator with its total energy as an observable. These observables form an algebra $\mathcal{A} = C^\infty(M_P)$ which is real, unital, involutive, associative and commutative. Observables can be added, multiplied among themselves and multiplied by real numbers. The involution $*$ is trivial in the sense that $a^* = a$ for any $a \in \mathcal{A}$. Position and momentum should also be thought of as elements of the algebra of observables and not as points in phase space. So it is \mathcal{A} that has a real physical significance and not M_P itself.

Passing over to quantum mechanics the algebra \mathcal{A} is made noncommutative by endowing it with a commutation relation for the position observables x_j , $j = 1, 2, 3$ and the momentum observables p_j ,

$$[x_j, p_i] = i\hbar 1 \delta_{ji}, \tag{3.1}$$

where δ_{ji} is the Kronecker delta and 1 is the unity of the algebra. Time is still a separate parameter and not an observable. The algebra is real, associative and the involution (hermitian conjugation) is a map from the algebra onto itself with the following properties:

$$\begin{aligned} (ab)^* &= b^* a^*, \\ 1^* &= 1 \quad \text{and} \\ a^{**} &= a. \end{aligned} \tag{3.2}$$

An immediate consequence of the noncommutativity in equation 3.1 is that the notion of an underlying phase space loses its meaning. Instead one could think of a space consisting of cells, the size of which is determined by an uncertainty Δx_j and Δp_j

of the “points”. To define such an uncertainty Δa of an observable, it is necessary to faithfully represent the algebra on a Hilbert space of wave functions \mathcal{H} via a representation ρ . The last ingredient one wishes to add is dynamics via a self adjoint observable $H^* = H \in \mathcal{A}$ and the Schrödinger equation:

$$i\hbar \frac{\partial}{\partial t} \psi(t, \mathbf{x}) = \rho(H) \psi(t, \mathbf{x}), \quad \psi(t, \mathbf{x}) \in \mathcal{H}_t. \quad (3.3)$$

The subscript t on the Hilbert space is to indicate that time is just a parameter, not an observable.

Passing over to special relativity Dirac realised that the treatment of fermions requires a different setting. Instead of wave functions the Hilbert space contains spinors and the Schrödinger equation is replaced by the Dirac equation

$$\not{D}\psi = 0. \quad (3.4)$$

The Dirac operator \not{D} is no longer a self adjoint observable but a first order differential operator acting on the Hilbert space. In Euclidian space-time it is a self adjoint operator. Curvature can be included by adding a spin connection $i\gamma^\mu \omega_\mu$ to the Dirac operator. It is the equivalent of the Levi-Civita connection $\Gamma_{\mu\nu}^\lambda$ in the tangent bundle.

Following this line one constructs relativistic quantum mechanics, the question is now, can one invert this derivation? In other words, given an algebra, a Dirac operator and a Hilbert space to act on, is it possible to recover the phase space or the configuration space? Or put even differently, given an electron, and a set of observational data, as complete as possible, can one reconstruct the local structure of space-time?

The answer to these questions was given by Alain Connes and it is: Yes, under some assumptions. It is possible to define a compact Riemannian spin geometry on the basis of a real, associative, unitary algebra with involution \mathcal{A} represented on a Hilbert space \mathcal{H} and a self adjoint operator \mathcal{D} , called the Dirac operator. The set $(\mathcal{A}, \mathcal{H}, \mathcal{D})$ is called a spectral triple. It allows an axiomatic approach to geometry, which is completely equivalent to classical differential geometry. The easiest access is by giving the axioms and relating them to the geometrical properties they reflect. Since the main interest in this thesis lies in an Euclidian version of space time, i.e. a 4-dimensional compact Riemannian spin manifold, this will be the calibrating example.

Even, real spectral triples; the ingredients: An even, real spectral triple contains all the necessary information to reconstruct an even dimensional compact Riemannian spin manifold, see [4]. Five items are needed:

First item: \mathcal{A} is a real, associative, unital, *commutative* algebra with involution. Commutative matrix algebras which represent point spaces are excluded for the moment, they will serve as a simple example later, when finite geometries are treated. For a compact manifold M it is the algebra $\mathcal{C}^\infty(M)$ of arbitrarily often differentiable functions with complex values. The involution is complex conjugation. If \mathcal{A} is commutative it encodes the topological information of an underlying space. For example the property *unital* of the algebra corresponds to the property *compact* of the space. The algebra plays the rôle of the algebra of coordinates of the manifold or equivalently the algebra of classical observables. Commutativity is not necessary for the consistency of this axiomatic approach, this will be vital later on. A short dictionary of translations from the algebra $\mathcal{C}^\infty(M)$ to topology the of M is given in the following table.

<u>Topology</u>	<u>Algebra</u>
topological space M	real, associative, involutive algebra \mathcal{A}
continuous proper map	morphism
homeomorphism	automorphism
compact	unital
metrisable	separable
open (dense) subset	(essential) ideal
closed subset	quotient algebra

The mathematical details are based on the theorem of Gelfand and Naimark which can be described in a sloppy way by “inverting” the idea of a function on points x of the space. Instead the points are seen as states δ_x acting on functions a ,

$$a \mapsto \delta_x(a). \tag{3.5}$$

The points x of the space M are recovered from the algebra $\mathcal{A} = \mathcal{C}^\infty(M)$ via the *pure* states of the algebra. A state δ of an algebra is a linear form on \mathcal{A} that is normalised, $\delta(1)$ and positive $\delta(a^*a) \geq 0$ for all $a \in \mathcal{A}$. If a state cannot be written as a convex combination of states it is said to be pure. The pure states of the algebra are in one-to-one correspondence with the points of the topological space M .

To refine the geometric information one has to pass from a topological space to a manifold, here to an orientable even dimensional Riemannian spin manifold. To achieve this the space has to be equipped with a metric, an orientation and a spin structure. For the translation into the spectral language four more items are needed.

Second item: \mathcal{H} is a Hilbert space on which the algebra \mathcal{A} is faithfully represented via a representation ρ . This is inspired by quantum mechanics where observables, here the elements of the algebra, are operators acting on a Hilbert space. In the case of a Riemannian spin manifold, $\mathcal{H} = \mathcal{L}^2(M, \mathcal{S})$ is the Hilbert space of complex, square integrable spinors ψ on M . Since M is taken to be 4-dimensional the spinor is locally a column vector $\psi(x) \in \mathbb{C}^4$, $x \in M$. The representation of the algebra of functions $\mathcal{C}^\infty(M)$ is simply by pointwise multiplication:

$$(\rho(a)\psi)(x) = a(x)\psi(x), \quad a \in \mathcal{C}^\infty(M) \text{ and } \psi \in \mathcal{H}. \quad (3.6)$$

Third item: \mathcal{D} is the Dirac operator. It is a self adjoint operator $\mathcal{D}^* = \mathcal{D}$ with compact resolvent. This operator furnishes the geometry of the space M with a differential structure, it plays the rôle of the metric, encodes the dimension of the space and will of course determine the dynamics of the fermions via the Dirac equation.

Fourth item: J is an anti-unitary operator on \mathcal{H} with $J^2 = -\mathbb{1}_4$ in four dimensions. It is called the real structure and can be identified with the charge conjugation operator C from particle physics. It permutes particles with antiparticles and in the case of the 4-dimensional Riemannian spin manifold it is given by

$$J = C = \gamma^0 \gamma^2 \circ \text{complex conjugation} = \begin{pmatrix} 0 & -1 & 0 & 0 \\ 1 & 0 & 0 & 0 \\ 0 & 0 & 0 & 1 \\ 0 & 0 & -1 & 0 \end{pmatrix} \circ \text{c.c.} \quad (3.7)$$

Fifth item: χ is a unitary operator on \mathcal{H} with $\chi^2 = \mathbb{1}_4$. It called the chirality and is for the calibrating example identical with the chirality operator γ_5 from particle physics:

$$\chi = \gamma_5 = \gamma^0 \gamma^1 \gamma^2 \gamma^3 = \begin{pmatrix} -\mathbb{1}_2 & 0 \\ 0 & \mathbb{1}_2 \end{pmatrix}. \quad (3.8)$$

These five items have to fulfil a number of axioms which ensure that all the properties of the compact Riemannian spin geometry can be properly recovered. These axioms are:

- $[\mathcal{D}, \rho(a)]$ is a bounded operator for all $a \in \mathcal{A}$ and $[[D, \rho(a)], J\rho(\tilde{a})J^{-1}] = 0$ for all $a, \tilde{a} \in \mathcal{A}$. This is the first order condition. It is the algebraic way to ensure that \mathcal{D} is a first order differential operator on a Riemannian spin manifold.
- Regularity. This axiom states that the elements of the algebra are differentiable. This is of course always the case for the algebra $\mathcal{C}^\infty(M)$.
- Orientability. This axioms states that there exists a Hochschild cycle c such that $\chi = \rho(c)$. This is the algebraic notion of orientability and the manifolds considered here will always be taken to be orientable. It also relates the chirality χ to the volume form.
- Poincaré duality. In ordinary differential geometry the Poincaré duality ensures that there exists a nondegenerate pairing between k forms and $n - k$ forms on compact orientable n -dimensional manifolds. It will allow terms like $\text{tr}(F_{\mu\nu}F^{\mu\nu})$ in the standard model Lagrangian to have a well defined integral. In noncommutative geometry this duality is promoted to an axiom. The algebraic translation is far more involved and digs deep into K-theory. The statement is that the intersection form $\cap : K_*(\mathcal{A}) \times K_*(\mathcal{A}) \rightarrow \mathbb{Z}$ is nondegenerate. $K_*(\mathcal{A})$ is a collective notion for the algebraic K-groups. For the purpose of this thesis it is sufficient to state that compact, orientable Riemannian spin manifolds always satisfy the Poincaré duality. In the case of finite geometries it will take a particularly simple form that will serve as a major ingredient for the classification program.
- $[\rho(a), J\rho(\tilde{a})J^{-1}] = 0$ for all $a, \tilde{a} \in \mathcal{A}$. This axiom ensures that the Hilbert space can be treated as a bimodule with $\rho(a)$ as left multiplication and $J\rho(a)J^{-1}$ as right multiplication.

- $[\chi, \rho(a)] = 0$ for all $a \in \mathcal{A}$ which allows the decomposition of the Hilbert space into left- and a right-handed spinors $\mathcal{H} = \mathcal{H}_L \oplus \mathcal{H}_R$. The left-handed spinors are the eigenspinors of χ corresponding to the eigenvalue -1 and the right-handed spinors are the eigenspinors corresponding to the eigenvalue $+1$.
- $[\mathcal{D}, J] = [J, \chi] = \{\mathcal{D}, \chi\} = 0$. These properties ensure that particles and antiparticles share the same dynamics and that chirality does not change under time evolution. From the geometric point of view they guarantee, together with the two preceding axioms, that the manifold is real.

Now the five actors are chosen and the stage is set by the axioms. The play of physics and geometry can take place. The collection $(\mathcal{A}, \mathcal{H}, \mathcal{D}, J, \chi)$, fulfilling the axioms given above, is what Connes calls an *even, real spectral triple*. It is most important to note that neither the algebraic data given by the spectral triple nor the axioms require the algebra \mathcal{A} to be commutative. A spectral triple with a noncommutative algebra will be called a *noncommutative geometry*. In the case of a commutative algebra Connes reconstruction theorem holds:

Reconstruction theorem (Connes 1996 [4]): Consider a real, even spectral triple $(\mathcal{A}, \mathcal{H}, \mathcal{D}, J, \chi)$ whose algebra \mathcal{A} is commutative. Then there exists a compact Riemannian spin manifold M (of dimension $4 \bmod 8$), whose spectral triple $(\mathcal{C}^\infty(M), \mathcal{L}^2(M, \mathcal{S}), \not{D}, C, \gamma_5)$ coincides with $(\mathcal{A}, \mathcal{H}, \mathcal{D}, J, \chi)$ whose algebra \mathcal{A} .

Here the case with dimension 4 is completely sufficient and the axioms are adjusted to reproduce exactly this dimension. It is of course possible to formulate axioms for any even dimension, including dimension zero. To achieve this, only the signs of some of the commutation relations and the squares of J and χ have to be altered. For a more detailed account on the reconstruction theorem and its mathematical foundations, the Costa Rica book [17] should be consulted. In the following some of the most important geometric properties will be reconstructed from the algebraic data.

Differential forms: A differential form $d\rho(a)$, $a \in \mathcal{A}$, of degree one is defined as

$$d\rho(a) = -i[\mathcal{D}, \rho(a)]. \tag{3.9}$$

For the case of a flat Riemannian spin manifold the Dirac operator is the ordinary Dirac operator

$$\mathcal{D} = \not{D} = i\gamma^\mu \partial_\mu. \quad (3.10)$$

The differential $d\rho(a)$ is then

$$\begin{aligned} (d\rho(a)\psi)(x) &= -i[\not{D}, a(x)]\psi(x) \\ &= \gamma^\mu \partial_\mu(a(x)\psi(x) - \gamma^\mu a(x)\partial_\mu\psi(x)) \\ &= \gamma^\mu (\partial_\mu a(x))\psi(x). \end{aligned} \quad (3.11)$$

Identifying γ^μ with dx^μ one recovers the usual differential of $a(x)$.

The metric: It is possible to recover the metric of the manifold via Connes' distance formula. One should remember that the points x on the manifold M are the pure states of the algebra δ_x . In the case where the algebra is simply the algebra of C^∞ -functions on the manifold, the pure states are given by the Dirac distributions. The distance formula for two pure states δ_x and δ_y is simply

$$\sup\{|\delta_x(a) - \delta_y(a)|; a \in \mathcal{A} \text{ such that } \|[\mathcal{D}, \rho(a)]\| \leq 1\}. \quad (3.12)$$

This is certainly well defined, since by definition $\|[\mathcal{D}, \rho(a)]\|$ is a bounded operator. For an explicit example the simplest compact oriented Riemannian spin manifold is instructive: The unit circle S^1 . The Dirac operator is $\mathcal{D} = id/dx$ and the algebra of functions $C^\infty(S^1)$ acts faithfully on a wave function $\psi \in \mathcal{L}^2(S^1)$ by pointwise multiplication $(\rho(a)\psi)(x) = a(x)\psi(x)$. The operator norm is defined as

$$\|[\mathcal{D}, \rho(a)]\| = \sup_\psi \frac{|[\mathcal{D}, \rho(a)]\psi|}{|\psi|} = \sup_x |a'(x)|, \quad (3.13)$$

with the scalar product

$$|\psi|^2 = \int_0^{2\pi} \bar{\psi}(x)\psi(x)dx. \quad (3.14)$$

From the distance formula 3.12 follows with $\delta_x(a) = a(x)$ the geodesic distance on the circle,

$$\sup_a \{|a(x) - a(y)|; \sup_x |a'(x)| \leq 1\} = |x - y|. \quad (3.15)$$

The dimension: From Weyl's spectral theorem it is well known that the eigenvalues of the Laplace operator Δ on a compact manifold M grow asymptotically as $n^{2/\dim M}$. The same holds for the eigenvalues of the Dirac operator, which is in a sense the "square root" of the Laplacian. Here the eigenvalues grow as $n^{1/\dim M}$. Thus the dimension of the manifold is a local property, determined by the asymptotical behaviour of the eigenvalues of the Dirac operator. Only the high energy part is of interest and this is in nice agreement with the picture of the electron "feeling" the geometry of space-time.

3.2 General Relativity II

To repeat Einstein's derivation of general relativity it is necessary to translate the notion of a general coordinate transformation or diffeomorphism $\tilde{\sigma}$ on the manifold M to the spinor space. The first thing to note is that the diffeomorphisms $\tilde{\sigma}$ of a compact manifold M are in one-to-one correspondence with the automorphisms σ of the algebra $\mathcal{C}^\infty(M)$. From now on σ will be used for diffeomorphisms and automorphisms.

Following Connes program these automorphisms $\text{Aut}(\mathcal{A})$ have to be lifted to the spinor space $\mathcal{L}^2(M, \mathcal{S})$. This lift $L(\sigma)$ is possible for automorphisms close to the identity. It is double-valued [18, 27] and acts on spinors $\psi \in \mathcal{L}^2(M, \mathcal{S})$ in a coordinate neighbourhood as

$$(L(\sigma)\psi)(x) = (S(\Lambda(\sigma, g))|_{\sigma^{-1}(x)}\psi(\sigma^{-1}(x))). \quad (3.16)$$

with

$$S : \text{SO}(4) \longrightarrow \text{Spin}(4) \quad \Lambda = \exp \omega \longmapsto \exp\left(\frac{1}{8}\omega_{ab}[\gamma^a, \gamma^b]\right). \quad (3.17)$$

The Lorentz transformation Λ and the Jacobian matrix \mathcal{J} are given by

$$\Lambda(\sigma, g)|_x = \left[\sqrt{\mathcal{J}_\sigma^{-1T} g \mathcal{J}_\sigma^{-1}} \mathcal{J}_\sigma \sqrt{g^{-1}} \right]_x, \quad \mathcal{J}_\sigma(x)^\nu{}_\mu = \frac{\partial \sigma^\nu(x)}{\partial x^\mu}, \quad (3.18)$$

and g is the metric tensor. This lift is unique infinitesimally [6] and its double valuedness has for the case of Pauli spinors been verified experimentally in neutron interferometry [11].

Starting out with the flat Dirac operator $\mathcal{D} = \not{\partial}$, pseudo forces will be introduced

in a covariant way by writing \not{D} in curved coordinates with the lifted automorphisms:

$$L(\sigma)\not{D}L(\sigma)^{-1} = ie_a^{-1\mu}\gamma^a \left[\frac{\partial}{\partial x^\mu} + s(\omega_\mu) \right], \quad (3.19)$$

where the vierbein $e^{-1} = \sqrt{\mathcal{J}\mathcal{J}^T}$ is a symmetric matrix. It is the spinor equivalent of the metric tensor. This equation corresponds to equation 2.36, where the spin connection ω_μ is the gauge transform of the Levi-Civita connection Γ . It has an explicit expression in terms of the vierbein e :

$$\omega_{b\mu}^a(e) = \frac{1}{2} \left[\frac{\partial e_\mu^a}{\partial x_\nu} - \frac{\partial e_\nu^a}{\partial x_\mu} + e_\mu^m \frac{\partial e_\alpha^m}{\partial x_\nu} e_a^{-1\alpha} \right] e_b^{-1\nu} - [a \leftrightarrow b] \quad (3.20)$$

Since 3.2 is just the flat Dirac operator in curved coordinates the forces are still pseudo forces. To impose the relativity principle means to promote the equivalent of the metric tensor, the vierbein e_μ^a to an arbitrary invertible symmetric matrix $e(x)$ depending smoothly on x .

The procedure just described has some shortcomings. It would be much more satisfactory if the act of promoting the vierbein to an arbitrary matrix, i.e. ‘‘curving’’ the flat Dirac operator, could be handled in a more ‘‘linear’’ way. Therefore the following conjecture is presented:

Conjecture: On a compact Riemannian spin manifold any Dirac operator ${}^f\mathcal{D}$ can be obtained from an arbitrarily chosen initial Dirac operator \mathcal{D} by a finite linear combination of generalised coordinate transformations:

$${}^f\mathcal{D} = \sum_j r_j L(\sigma_j) \mathcal{D} L(\sigma_j)^{-1}, \quad r_j \in \mathbb{R}, \quad \sigma_j \in \text{Aut}(\mathcal{A}). \quad (3.21)$$

These Dirac operators ${}^f\mathcal{D}$ will be called *fluctuated* Dirac operators.

For this conjecture no proof is known yet. But it has been inspired by a theorem of Moser [16] which says:

Theorem: Let M be an orientable, connected, compact, n -dimensional differentiable manifold (without boundary). Let $\omega, \eta \in \Omega^n$ be volume forms with

$$\int_M \omega = \int_M \eta. \quad (3.22)$$

There exists a diffeomorphism $\sigma : M \rightarrow M$ such that $\sigma^*\omega = \eta$.

This theorem states that the very rough geometrical notions of a volume form and the volume itself are determined by the diffeomorphisms of the manifold. The proposition is intended to be in the same spirit. Simple calculations show that linear combinations of two Dirac operators in different coordinate systems produce readily curvature and torsion. One should note that it is not possible to build linear combinations of metrics.

For a compact Riemannian spin manifold M the dynamical configuration space of all Dirac operators is now defined as

$$\mathcal{F} := \left\{ {}^f\mathcal{D} = \sum_j r_j L(\sigma_j) \mathcal{D} L(\sigma_j)^{-1}, r_j \in \mathbb{R}, \sigma_j \in \text{Aut}(\mathcal{A}) \right\}. \quad (3.23)$$

\mathcal{F} is an affine space that contains all the possible Dirac operators on M . To pursue Einstein's derivation of general relativity further it is necessary to define the dynamics of the Dirac operator itself, in the same way the metric became a dynamical variable.

The spectral action: As mentioned, a positive functional on the set \mathcal{F} of Dirac operators is needed to obtain the dynamics of the gravitational field. This is the celebrated spectral action $S_\Lambda : \mathcal{F} \rightarrow \mathbb{R}_+$ due to Chamseddine & Connes [1]. It is motivated by the modern unit of time in terms of the frequencies of atomic spectra, and as a bonus it is diffeomorphism invariant.

$S_\Lambda[{}^f\mathcal{D}]$ is simply the number of eigenvalues λ of ${}^f\mathcal{D}$ counted with their multiplicities up to a cut-off Λ such that $|\lambda| \leq \Lambda$. Since only the high-energy behaviour is of experimental interest, the asymptotical behaviour for $\Lambda \rightarrow \infty$ has to be computed. This can be done by introducing a sufficiently fast decreasing regulator function $h : \mathbb{R}_+ \rightarrow \mathbb{R}_+$. Since the Dirac operator anticommutes with the chirality its spectrum is even and it is sufficient to consider only the positive operator ${}^f\mathcal{D}^2$. The asymptotic

spectral action is given by

$$S_{\Lambda}^h[{}^f\mathcal{D}] := \text{tr} \left[h \left(\frac{{}^f\mathcal{D}^2}{\Lambda^2} \right) \right]. \quad (3.24)$$

If one replaced the differentiable function h by the discontinuous characteristic function of the unit interval one would recover S_{Λ} . The asymptotic functional can be approximated with the well known heat kernel expansion. For the 4-dimensional Riemannian spin manifold M one finds:

$$\begin{aligned} S_{\Lambda}^h[{}^f\mathcal{D}] &= \int_{\mathcal{M}} \left\{ \frac{1}{16\pi G} (2\Lambda_c - R) \right\} \sqrt{\det(g_{\mu\nu})} d^4x \\ &+ \int_{\mathcal{M}} a (5R^2 - 8R_{\mu\nu}R^{\mu\nu} - 7R_{\mu\nu\lambda\tau}R^{\mu\nu\lambda\tau}) \sqrt{\det(g_{\mu\nu})} d^4x \\ &+ \mathcal{O}(\Lambda^{-2}), \end{aligned} \quad (3.25)$$

where the cosmological constant is

$$\Lambda_c = \frac{h_0}{h_2} \Lambda^2, \quad (3.26)$$

Newton's constant is

$$G = \frac{3\pi}{h_2} \Lambda^{-2} \quad (3.27)$$

and

$$a = \frac{h_4}{5760\pi^2}. \quad (3.28)$$

The regulator function only enters through its first three moments

$$h_0 = \int_0^{\infty} u h(u) du, \quad h_2 = \int_0^{\infty} h(u) du, \quad \text{and } h_4 = h(0) \quad (3.29)$$

and is in this sense universal. For a small curvature the square terms of the curvature tensors in 3.25 can be neglected and the Einstein-Hilbert action with a positive cosmological constant is recovered. The square terms of the curvature tensors are proportional to the square of the Weyl tensor $C_{\mu\nu\lambda\tau}$, up to the Euler characteristic which is a topological invariant and does not depend on the metric. In Schwarzschild

and Robertson-Walker space-times the Weyl tensor vanishes identically.

Up to now the whole derivation of Euclidian Einsteinian gravity has been retraced. And again it was never necessary to take the algebra \mathcal{A} of the spectral triple to be commutative. Thus in view of quantum mechanics the next step will be to investigate noncommutative spectral triples and include them into the framework presented so far.

3.3 Finite Spectral Triples

General relativity is a diffeomorphism invariant theory. One of the main inspirations to pass over to a noncommutative regime is the desire to unify the symmetries of the standard model with those of general relativity on the same footing. It is not possible to do so within the frame work of classical differential geometry, i.e. there are no manifolds that possess at the same time the diffeomorphisms and a product of finite simple Lie groups as a symmetry group. This is due to a theorem of Mather, for details see [5]. To pave the way towards a unified view of symmetry the focus should be turned firstly to spaces with those finite Lie groups as symmetries.

Since the symmetries of spaces represented by spectral triples are the automorphisms of the algebras, matrix algebras will serve as the first noncommutative examples. These spectral triples will be called *finite* spectral triples or *finite geometries*.

The ingredients and axioms for a finite spectral triple resemble closely those of a spectral triple stemming from a Riemannian spin manifold, [3, 4]. Since the main interest of this thesis is particle physics, one extra condition will be added, the so called S^0 -reality. It will ensure that the Hilbert space of fermions can be decomposed into a particle and an antiparticle part and is encoded in an unitary operator ϵ . A spectral triple solely based on a Riemannian spin manifold can never be S^0 -real.

Real, S^0 -real, finite spectral triples; the ingredients: An real, S^0 -real, finite spectral triple does not represent a manifold or any kind of classical space if the algebra is noncommutative. Like the phase space in quantum mechanics can no longer be described by points, but instead has to be “imagined” as a space consisting of “cells”, the idea of an underlying space has to be abandoned. The power of noncommutative geometry is that these “spaces” can still be adequately handled within the setting of a spectral triple. Only minor changes are necessary.

First item: The algebra \mathcal{A}_f is again real, associative, unital and has an involution. The subscript f indicates the finite nature of the algebra. It is necessarily the direct finite sum of matrix algebras,

$$\mathcal{A}_f = M_{n_1}(\mathbb{K}_1) \oplus M_{n_2}(\mathbb{K}_2) \oplus \cdots \oplus M_{n_N}(\mathbb{K}_N), \quad (3.30)$$

where \mathbb{K}_i is either the field of real numbers \mathbb{R} , the field of complex numbers \mathbb{C} or the field of quaternions \mathbb{H} . The subscript n_i of the matrix subalgebras indicates the matrix size.

These matrix algebras are in general noncommutative, the only commutative examples are diagonal matrix algebras over the real or complex numbers. As in the commutative case it is possible to define states and pure states as positive functionals on the algebra. For commutative matrix algebras the finite set of pure states has an interpretation. It is a set of points, where the distance between the points can be calculated with Connes' distance formula 3.12, the so called n -point spaces. For noncommutative matrix algebras all such interpretations fail.

Second item: The Hilbert space \mathcal{H}_f is determined by the representation ρ of the algebra \mathcal{A}_f . In general it is of the form $\mathbb{C}^{\tilde{N}}$, a direct sum of irreducible spaces $\mathbb{C}^{(n_i)}$, each being the representation space of a fundamental representation of a simple summand $\mathcal{A}_f = M_{n_i}(\mathbb{K}_i)$. The convention is $(n) = n$ for $\mathbb{K} = \mathbb{R}, \mathbb{C}$ and $(n) = 2n$ for $\mathbb{K} = \mathbb{H}$ since the quaternions are represented as complex 2×2 -matrices. As the axioms for a finite spectral triple will allow a more lucid consideration of the representation this topic will be postponed until everything is established.

Third item: The Dirac operator \mathcal{D}_f is again a self adjoint operator. It has a simple structure being a fixed $\tilde{N} \times \tilde{N}$ -matrix acting on the Hilbert space $\mathcal{H}_f = \mathbb{C}^{\tilde{N}}$. The finite Dirac operator will be interpreted as the fermionic mass matrix. Again the structure of the Dirac operator can be largely simplified with help of the axioms.

Fourth item: The real structure J_f is an anti-unitary operator on \mathcal{H}_f with $J_f^2 = \mathbb{1}_{\dim \mathcal{H}_f}$. It permutes particles and antiparticles.

Fourth item: χ_f is a unitary operator on \mathcal{H}_f with $\chi_f^2 = \mathbb{1}_{\dim \mathcal{H}_f}$.

Fifth item: The S^0 -real structure ϵ is an unitary operator acting on \mathcal{H}_f with $\epsilon^2 = \mathbb{1}_{\dim \mathcal{H}_f}$. It allows to distinguish between particles and antiparticles and interdicts

Majorana-Weyl fermions.

The axioms for a finite spectral triple are the same as in the Riemannian case, up to a few signs. Two additional commutation relations for the S^0 -real structure are introduced and the orientability and the Poincaré duality can be cast into a simple form:

- $[J_f, \mathcal{D}_f] = [J_f, \chi_f] = \{\chi_f, \mathcal{D}_f\} = 0$ ensure again the triple to be real.
- $[\epsilon, \mathcal{D}_f] = 0$ ensures the S^0 -reality.
- $[\epsilon, \rho(a)] = [\epsilon, \chi_f] = 0$ and $\{\epsilon, J_f\} = 0$ allow the Hilbert space to split into a particle part and an antiparticle part. Together with the commutation relation for the chirality this it can be written as a sum of left, right, particle and antiparticle subspaces:

$$\mathcal{H}_f = \mathcal{H}_L \oplus \mathcal{H}_R \oplus \mathcal{H}_L^c \oplus \mathcal{H}_R^c. \quad (3.31)$$

Consequently the representation also decomposes

$$\rho = \begin{pmatrix} \rho_L & 0 & 0 & 0 \\ 0 & \rho_R & 0 & 0 \\ 0 & 0 & \overline{\rho_L^c} & 0 \\ 0 & 0 & 0 & \overline{\rho_R^c} \end{pmatrix}. \quad (3.32)$$

From $\epsilon^2 = \mathbb{1}_{\dim \mathcal{H}_f}$ follows that the eigenvalues of ϵ are $+1$ and -1 . They correspond to the particle and antiparticle spinors.

- **Orientability.** For matrix algebras \mathcal{A}_f this axiom reduces to the requirement that there exist a finite number of elements $a_i, b_i \in \mathcal{A}_f$ such that χ_f can be written in the form

$$\chi_f = \sum_i \rho(a_i) J_f \rho(b_i) J_f^{-1}. \quad (3.33)$$

- **Poincaré duality.** The nondegenerate intersection form can now be given explicitly:

$$\cap_{ij} = \text{tr}(\chi_f \rho(p_i) J_f \rho(p_j) J_f^{-1}), \quad (3.34)$$

where

$$p_i = 0 \oplus \dots \oplus 0 \oplus \pi_i \oplus 0 \oplus \dots \oplus 0 \in \mathcal{A}_f \quad (3.35)$$

is a projector with π_i a minimal projector of the respective matrix subalgebras in the i -th summand and zero otherwise. For a 3×3 -matrix algebra over the real or complex numbers the minimal projector would be

$$\begin{pmatrix} 1 & 0 & 0 \\ 0 & 0 & 0 \\ 0 & 0 & 0 \end{pmatrix}, \quad (3.36)$$

whereas a 2×2 -matrix algebra over the quaternions would have

$$\begin{pmatrix} \mathbb{1}_2 & 0 \\ 0 & 0 \end{pmatrix}. \quad (3.37)$$

These are the only minimal rank projectors, up to unitary equivalence. Nondegeneracy of the intersection form is of course equivalent to $\det(\cap_{ij}) \neq 0$.

Putting together the axioms some basic matrix manipulations lead to further simplifications. The real structure, the chirality and the S^0 -reality can be written as

$$J_f = \begin{pmatrix} 0 & \mathbb{1}_{(\dim \mathcal{H}_L^c + \dim \mathcal{H}_R^c)} \\ \mathbb{1}_{(\dim \mathcal{H}_L + \dim \mathcal{H}_R)} & 0 \end{pmatrix} \circ \text{c.c.} \quad (3.38)$$

$$\chi_f = \begin{pmatrix} -\mathbb{1}_{\dim \mathcal{H}_L} 0 & 0 & 0 & 0 \\ 0 & \mathbb{1}_{\dim \mathcal{H}_R} & 0 & 0 \\ 0 & 0 & -\mathbb{1}_{\dim \mathcal{H}_L^c} & 0 \\ 0 & 0 & 0 & \mathbb{1}_{\dim \mathcal{H}_R^c} \end{pmatrix} \quad (3.39)$$

and

$$\epsilon = \begin{pmatrix} \mathbb{1}_{\dim \mathcal{H}_L} 0 & 0 & 0 & 0 \\ 0 & \mathbb{1}_{\dim \mathcal{H}_R} & 0 & 0 \\ 0 & 0 & -\mathbb{1}_{\dim \mathcal{H}_L^c} & 0 \\ 0 & 0 & 0 & -\mathbb{1}_{\dim \mathcal{H}_R^c} \end{pmatrix} \quad (3.40)$$

It follows also easily that $\dim \mathcal{H}_L = \dim \mathcal{H}_L^c$ and $\dim \mathcal{H}_R = \dim \mathcal{H}_R^c$. From this, one can

deduce the general form of the Dirac operator

$$\mathcal{D}_f = \begin{pmatrix} 0 & \mathcal{M} & 0 & 0 \\ \mathcal{M}^* & 0 & 0 & 0 \\ 0 & 0 & 0 & \overline{\mathcal{M}} \\ 0 & 0 & \overline{\mathcal{M}^*} & 0 \end{pmatrix}, \quad (3.41)$$

where \mathcal{M} is an arbitrary complex $\dim\mathcal{H}_L \times \dim\mathcal{H}_R$ -matrix.

The metric: It is possible to define a consistent geodesic distance on a finite spectral triple. The distance formula is the same as in the Riemannian case. A simple example is the two-point space, where the algebra is commutative. The whole spectral triple is given by

$$\begin{aligned} \mathcal{A}_f &= \mathbb{C}_L \oplus \mathbb{C}_R \ni (a_L, a_R), \quad \mathcal{H}_f = \mathbb{C}^4 \\ \rho &= \begin{pmatrix} a_L & 0 & 0 & 0 \\ 0 & a_R & 0 & 0 \\ 0 & 0 & \bar{a}_R & 0 \\ 0 & 0 & 0 & \bar{a}_L \end{pmatrix}, \quad \mathcal{D}_f = \begin{pmatrix} 0 & m & 0 & 0 \\ \bar{m} & 0 & 0 & 0 \\ 0 & 0 & 0 & \bar{m} \\ 0 & 0 & m & 0 \end{pmatrix}, \quad m \in \mathbb{C} \\ J_f &= \begin{pmatrix} 0 & 1_2 \\ 1_2 & 0 \end{pmatrix} \circ \text{c.c.}, \quad \chi_f = \text{diag}(-1, 1, -1, 1), \quad \epsilon = \text{diag}(1, 1, -1, -1). \end{aligned} \quad (3.42)$$

This algebra has two pure states $\delta_L(a_L, a_R) = a_L$ and $\delta_R(a_L, a_R) = a_R$ which may be interpreted as the two points of the space. The distance between them is readily calculated via Connes' distance formula 3.12 to be $1/|m|$.

The dimension: Since the Dirac operator is a matrix of finite dimension it has only a finite number of eigenvalues. The spectral dimension is zero, which is rather intuitive if one thinks of the previous example. It should be noted that it becomes possible to use the full geometric machinery even on spaces which are only sets of points or on algebras which states do no longer represent points of any classical space.

The automorphisms of the algebra: All the automorphisms of matrix algebras connected to the unity element are inner, i.e. they are of the form

$$i_u a = u a u^* \quad a \in \mathcal{A}_f, \quad (3.43)$$

where

$$u \in \mathcal{U}(\mathcal{A}_f) = \{u \in \mathcal{A}_f | u^* u = u u^* = 1\} \quad (3.44)$$

is an element of the group of unitaries of the algebra and i is a map from the unitaries into the inner automorphisms $\text{Int}(\mathcal{A}_f)$

$$\begin{aligned} i : \mathcal{U}(\mathcal{A}_f) &\longrightarrow \text{Int}(\mathcal{A}_f) \\ u &\longmapsto i_u. \end{aligned} \quad (3.45)$$

In the kernel of i are the central unitaries, which commute with all elements in \mathcal{A}_f . These inner automorphisms $\text{Int}(\mathcal{A}_f)$ are equivalent to the group of unitaries $\mathcal{U}(\mathcal{A}_f)$ modulo the central unitaries $\mathcal{U}^c(\mathcal{A}_f)$. For the possible sub-matrix algebras one has the following list of unitaries, central unitaries and inner automorphisms:

\mathcal{A}	$\mathcal{U}(\mathcal{A})$	$\mathcal{U}^c(\mathcal{A})$	$\text{Int}(\mathcal{A}) = \mathcal{U}(\mathcal{A})/\mathcal{U}^c(\mathcal{A})$
\mathbb{R}	\mathbb{Z}_2	\mathbb{Z}_2	$\{1\}$
\mathbb{C}	$U(1)$	$U(1)$	$\{1\}$
\mathbb{H}	$USp(1) = SU(2)$	$\mathbb{Z}_2 \ni \pm 1_2$	$SU(2)/\mathbb{Z}_2$
$M_n(\mathbb{R}), n \geq 2$	$O(n)$	$\mathbb{Z}_2 \ni \pm 1_n$	$O(n)/\mathbb{Z}_2$
$M_n(\mathbb{C}), n \geq 2$	$U(n)$	$U(1) \ni \exp(i\theta) \mathbf{1}_n,$ $\theta \in [0, 2\pi)$	$U(n)/U(1) = SU(n)/\mathbb{Z}_n$
$M_n(\mathbb{H}), n \geq 2$	$USp(n)$	$\mathbb{Z}_2 \ni \pm 1_{2n}$	$USp(n)/\mathbb{Z}_2$

The Abelian algebras \mathbb{R} and \mathbb{C} do not possess any inner automorphisms. Remarkably the quaternions and the matrix algebras over the complex numbers produce exactly the kind of inner automorphisms that correspond to the nonabelian gauge groups of the standard model. Note that the exceptional groups do not appear. They are the automorphism groups of non-associative algebras.

The lift: As in the Riemannian case the automorphisms close to the identity are going to be lifted to the Hilbert space. This lift has a simple closed form [3],

$L = \hat{L} \circ i^{-1}$ with

$$\hat{L}(u) = \rho(u)J_f\rho(u)J_f^{-1}. \quad (3.46)$$

Here two crucial problems occur. The symmetry group of the standard model contains an Abelian sub-group $U(1)_Y$. But the inner automorphisms do not contain any Abelian subgroups by definition. Furthermore the lift is multivalued for matrix algebras over the complex numbers since the kernel of i contains an $U(1)$ -group. Note that neither the matrix algebras over the reals nor those over the quaternions have any central unitaries close to the identity. The solution to both of these problems is to centrally extend the lift, i.e. to adjoin some central elements. One has to distinguish between central unitaries stemming from the Abelian algebra \mathbb{C} and those from nonabelian matrix algebras $M_n(\mathbb{C})$, $n \geq 2$. To simplify let the algebra \mathcal{A}_f be a sum of matrix algebras over the complex numbers. Furthermore the commutative and noncommutative sub-algebras will be separated,

$$\mathcal{A}_f = \mathbb{C}^M \oplus \bigoplus_{k=1}^N M_{n_k}(\mathbb{C}) \ni (b_1, \dots, b_M, c_1, \dots, c_N), \quad n_k \geq 2. \quad (3.47)$$

The group of unitaries $\mathcal{U}(\mathcal{A}_f)$ and the group of central unitaries $\mathcal{U}^c(\mathcal{A}_f)$ are then given by:

$$\begin{aligned} \mathcal{U}(\mathcal{A}_f) &= U(1)^M \times U(n_1) \times \dots \times U(n_N) \ni u = (v_1, \dots, v_M, w_1, \dots, w_N), \\ \mathcal{U}^c(\mathcal{A}_f) &= U(1)^{M+N} \ni u^c = (v_1, \dots, v_M, w_1^c \mathbb{1}_{n_1}, \dots, w_N^c \mathbb{1}_{n_N}). \end{aligned} \quad (3.48)$$

For the inner automorphisms follows

$$\text{Int}(\mathcal{A}_f) = \mathcal{U}(\mathcal{A}_f)/\mathcal{U}^c(\mathcal{A}_f) \ni u^{in} = (1, \dots, 1, w_1^{in}, \dots, w_N^{in}), \quad (3.49)$$

with $w_j^{in} \in \mathcal{U}(M_{n_j})/U(1)$. The lift $L = \hat{L} \circ i^{-1}$ can be written explicitly with

$$\hat{L} = \rho(1, \dots, 1, w_1, \dots, w_M)J_f\rho(\dots)J_f^{-1}. \quad (3.50)$$

It is multivalued due to the kernel of i , $\ker(i) = \mathcal{U}^c(\mathcal{A}_f)$. This multivaluedness can be cured by introducing an additional lift ℓ for the central unitaries, which is restricted

to those unitaries $\mathcal{U}^{nc}(\mathcal{A}_f)$ stemming from the noncommutative part of the algebra,

$$\begin{aligned} \ell(w_1^c, \dots, w_N^c) &:= \rho \left(\prod_{j_1=1}^N (w_{j_1}^c)^{q_{1,j_1}}, \dots, \prod_{j_M=1}^N (w_{j_M}^c)^{q_{M,j_M}}, \prod_{j_{M+1}=1}^N (w_{j_{M+1}}^c)^{q_{1,j_{M+1}}} \mathbb{1}_{n_1}, \dots \right. \\ &\quad \left. \dots, \prod_{j_{M+N}=1}^N (w_{j_{M+N}}^c)^{q_{1,j_{M+N}}} \mathbb{1}_{n_N} \right) J_f \rho(\dots) J_f^{-1}, \end{aligned} \quad (3.51)$$

with the $(M+N) \times N$ matrix of charges $q_{k,j}$. The extended lift \mathbb{L} is then defined as

$$\mathbb{L}(u^i, w^c) := (\hat{L} \circ i^{-1})(u^i) \ell(w^c), \quad u^i \in \text{Int}(\mathcal{A}_f), \quad w^c \in \mathcal{U}^{nc}(\mathcal{A}_f). \quad (3.52)$$

In this way Abelian gauge groups have been introduced and the multivaluedness has been reduced, depending on the choice of the matrix of charges. If one desires a unique lift one can define a maximal central extension by allowing the whole group of unitaries to be lifted

$$\mathbb{L}_{max}(u) := \rho(u) J_f \rho(u) J_f^{-1} \quad u \in \mathcal{U}(\mathcal{A}_f). \quad (3.53)$$

Written out with the representation 3.32 and the real structure 3.38, a lift reads

$$\begin{aligned} \mathbb{L}(u) &= \begin{pmatrix} \rho_L(u) \rho_L^c(u) & 0 & 0 & 0 \\ 0 & \rho_R(u) \rho_R^c(u) & 0 & 0 \\ 0 & 0 & \overline{\rho_L^c(u)} \overline{\rho_L(u)} & 0 \\ 0 & 0 & 0 & \overline{\rho_R^c(u)} \overline{\rho_R(u)} \end{pmatrix} \\ &= \begin{pmatrix} \mathbb{L}_L(u) & 0 & 0 & 0 \\ 0 & \mathbb{L}_R(u) & 0 & 0 \\ 0 & 0 & \overline{\mathbb{L}_L(u)} & 0 \\ 0 & 0 & 0 & \overline{\mathbb{L}_R(u)} \end{pmatrix} \end{aligned} \quad (3.54)$$

with $\mathbb{L}_L(u) = \rho_L(u) \rho_L^c(u) = \rho_L^c(u) \rho_L(u)$ and $\mathbb{L}_R(u) = \rho_R(u) \rho_R^c(u) = \rho_R^c(u) \rho_R(u)$, by definition. The unitaries u are chosen to produce the kind of central extension desired. As in the Riemannian case a coordinate transformation of the Dirac operator 3.41 introduces a finite connection H ,

$$\tilde{\mathcal{D}}_f = \mathbb{L}(u) \mathcal{D}_f \mathbb{L}^{-1}(u) = \mathcal{D}_f + H + J_f H J_f^{-1}, \quad (3.55)$$

with $H(u) = \rho(u)[\mathcal{D}, \rho(u^{-1})]$ a finite 1-form, which will in the almost-commutative case be interpreted as the Higgs scalar. For the straight forward derivation of 3.55 only the axioms for finite spectral triples are used. Equation 3.55 clarifies the geometric interpretation of the Higgs scalar H , but for calculations it will be more convenient to work with the field

$$\varphi(u) = \rho_L(u)\rho_L^c(u)\mathcal{M}\rho_R^c(u)\rho_R(u) = \mathbb{L}_L(u)\mathcal{M}\mathbb{L}_R(u), \quad (3.56)$$

which will also be called Higgs scalar. The whole Dirac operator reads

$$\mathbb{L}\mathcal{D}_f\mathbb{L}^{-1} = \begin{pmatrix} 0 & \varphi & 0 & 0 \\ \varphi^* & 0 & 0 & 0 \\ 0 & 0 & 0 & \overline{\varphi} \\ 0 & 0 & \overline{\varphi^*} & 0 \end{pmatrix}. \quad (3.57)$$

The spectral action: It is clear that for the spectral action, being the number of eigenvalues of the Dirac operator up to a cut-off, there is no sensible meaning of asymptotic expansion in the finite case. This is different when Riemannian and finite geometries are combined in almost-commutative geometries.

3.4 Krajewski Diagrams

There exists a diagrammatic approach to describe all the properties of a real, S^0 -real finite spectral triple. It is a slightly tedious but straight forward calculation. This classification has been done in [21, 22, 25] and [26] in the more general case without S^0 -reality. The diagrammatic approach is due to Thomas Krajewski, therefore the diagrams will be called *Krajewski diagrams*. In the treatment presented here S^0 -reality will be employed from the start on, so the calculations become a little bit more lucid.

As a further simplification the calculation will be presented for real algebras \mathcal{A}_f being the sum of matrix algebras over \mathbb{R}

$$\mathcal{A}_f = \bigoplus_{i=1}^N M_{n_i}(\mathbb{R}) \ni a = \bigoplus_{i=1}^N a_i, \quad (3.58)$$

where a_i are the fundamental representations of the summands. The generalisation to algebras with complex or quaternionic entries will be straight forward. Note also that

in the zero-dimensional case the real structure J_f squares to one. Thus $J_f = J_f^* = J_f^{-1}$ and consequently J_f^{-1} will be replaced by J_f .

The representation, the Hilbert space and the chirality: The first step on the way to a diagrammatic description of the spectral triple is the representation ρ of the algebra on the Hilbert space \mathcal{H}_f . Due to the S^0 -real structure ϵ , which commutes with the representation

$$[\rho(a), \epsilon] = 0, \quad \text{for all } a \in \mathcal{A}_f, \quad (3.59)$$

ρ can be split into the particle representation ρ^P and the antiparticle representation ρ^A , with $\rho = \rho^P \oplus \overline{\rho^A}$. Again the complex conjugate of the antiparticle part is conventional. This split is achieved with the projectors

$$P^{P/A} = \frac{\mathbb{1}_{\dim \mathcal{H}_f} \pm \epsilon}{2}. \quad (3.60)$$

In the same way the Hilbert space splits into a particle and an antiparticle part $\mathcal{H}_f = \mathcal{H}_f^P \oplus \mathcal{H}_f^A$. The real structure acts on the representation by conjugation. It exchanges the particle and antiparticle part and complex conjugates both

$$J_f \rho(a) J_f = J_f (\rho^P(a) \oplus \overline{\rho^A(a)}) J_f = \rho^A(a) \oplus \overline{\rho^P(a)}. \quad (3.61)$$

On the Hilbert space it acts as

$$\begin{aligned} J_f : \mathcal{H}_f^P \oplus \mathcal{H}_f^A &\longrightarrow \mathcal{H}_f \\ \psi^P \oplus \psi^A &\longmapsto \overline{\psi^A} \oplus \overline{\psi^P}. \end{aligned} \quad (3.62)$$

Since $J_f^2 = 1$ it follows that $\dim \mathcal{H}_f^P = \dim \mathcal{H}_f^A$ and J_f can be written as

$$J_f = \begin{pmatrix} 0 & \mathbb{1}_{\dim \mathcal{H}_f^P} \\ \mathbb{1}_{\dim \mathcal{H}_f^P} & 0 \end{pmatrix} \circ \text{c.c.} \quad (3.63)$$

One can now choose a representation for the particle and antiparticle part which fullfills the bimodule axiom, stating that $[\rho(a), J\rho(\tilde{a})J] = 0$ for all $a, \tilde{a} \in \mathcal{A}_f$. A

convenient choice of basis for the Hilbert space gives the following representation,

$$\rho^P(a) = \rho^P \left(\bigoplus_{i=1}^N a_i \right) = \bigoplus_{i,j=1}^N a_i \otimes \mathbb{1}_{m_{ij}} \otimes \mathbb{1}_{n_j} \quad (3.64)$$

$$\rho^A(a) = \rho^A \left(\bigoplus_{j=1}^N a_j \right) = \bigoplus_{i,j=1}^N \mathbb{1}_{n_i} \otimes \mathbb{1}_{m_{ij}} \otimes a_j, \quad (3.65)$$

with the corresponding particle and antiparticle Hilbert spaces

$$\mathcal{H}_f^P = \bigoplus_{i,j=1}^N \mathcal{H}_{ij}^P \simeq \bigoplus_{i,j=1}^N \mathbb{C}^{n_i} \otimes \mathbb{C}^{m_{ij}} \otimes \mathbb{C}^{n_j} \quad (3.66)$$

$$\mathcal{H}_f^A = \bigoplus_{i,j=1}^N \mathcal{H}_{ij}^A \simeq \bigoplus_{i,j=1}^N \mathcal{H}_{ij}^P = \mathcal{H}_f^P. \quad (3.67)$$

Here $\mathbb{1}_{n_i} \in M_{n_i}$ denotes the unit matrix of the i -th algebra. $\mathbb{1}_{m_{ij}}$ encodes the possibility that the i -th and the j -th fundamental representation a_i and a_j occur m_{ij} times. By convention $\mathbb{1}_0 = 0$. The representation is determined up to chirality by the matrix $(m_{ij}) \in M_N(\mathbb{N}_0)$. For ρ to remain a faithful representation of \mathcal{A}_f each fundamental representation a_i has to occur at least once. Any other possible representation will only result in an exchange of some of the summands of ρ^P and ρ^A . The bimodule structure of the Hilbert space can be written in terms of the particle and antiparticle part of the representation as

$$[\rho^P(a), \rho^A(\tilde{a})] = 0 \quad \text{for all } a, \tilde{a} \in \mathcal{A}_f. \quad (3.68)$$

Since the chirality is a finite sum, see 3.33, and commutes with the S^0 -real structure it reads in the chosen basis

$$\chi_f = \chi^P \oplus \chi^A \quad (3.69)$$

with

$$\chi^P = \chi^A = \bigoplus_{i,j=1}^N \mathbb{1}_{n_i} \otimes \chi_{ij} \mathbb{1}_{m_{ij}} \otimes \mathbb{1}_{n_j}. \quad (3.70)$$

The number $\chi_{ij} = \mp 1$ indicates whether the Hilbert subspace \mathcal{H}_{ij} is left- or right-handed. With the matrices $(\chi_{ij}) \in M_N(\mathbb{Z}_2)$ and (m_{ij}) the representation of the

spectral triple is completely described up to a change of basis of the Hilbert space. Both matrices can be combined into a single matrix $\mu \in M_N(\mathbb{Z})$ with $\mu_{ij} = \chi_{ij} m_{ij}$ called the *multiplicity matrix*. The chirality matrix can be recovered from μ by $\chi_{ij} = \text{sgn}(\mu_{ij})$ and the multiplicity of the representation by $m_{ij} = |\mu_{ij}|$. Note that there is a slight difference in the convention of the matrix (m_{ij}) and multiplicity matrix μ in [21, 22, 25] and [26]. Here (m_{ij}) and μ are not necessarily symmetric which is in contrast to the treatment of Paschke, Sitarz and Krajewski. This is due to a different choice of the basis of the Hilbert space.

One can ask now if any matrix $\mu \in M_N(\mathbb{Z})$ will describe the representation, the chirality and the Hilbert space of a real, S^0 -real finite spectral triple. This is of course not the case, the reason being the Poincaré duality which is in general not respected. But it is easy to establish a connection between the multiplicity matrix μ and the intersection form \cap , see 3.34. With the projectors p_l and p_k from 3.35 the matrix elements of \cap are:

$$\begin{aligned}
\cap_{ij} &= \text{tr} \left(\chi_f \rho(p_l) J_f \rho(p_k) J_f \right) \\
&= \text{tr} \left[\left(\bigoplus_{i,j=1}^N \mathbb{1}_{n_i} \otimes \chi_{ij} \mathbb{1}_{m_{ij}} \otimes \mathbb{1}_{n_j} \oplus \bigoplus_{i,j=1}^N \mathbb{1}_{n_i} \otimes \chi_{ij} \mathbb{1}_{m_{ij}} \otimes \mathbb{1}_{n_j} \right) \right. \\
&\quad \times \left(\bigoplus_{i,j=1}^N p_{li} \otimes \mathbb{1}_{m_{ij}} \otimes \mathbb{1}_{n_j} \oplus \bigoplus_{i,j=1}^N \mathbb{1}_{n_i} \otimes \mathbb{1}_{m_{ij}} \otimes p_{lj} \right) \\
&\quad \left. \times \left(\bigoplus_{i,j=1}^N \mathbb{1}_{n_i} \otimes \mathbb{1}_{m_{ij}} \otimes p_{kj} \oplus \bigoplus_{i,j=1}^N p_{ki} \otimes \mathbb{1}_{m_{ij}} \otimes \mathbb{1}_{n_j} \right) \right]. \quad (3.71)
\end{aligned}$$

Multiplying the respective summands and using the projectors p_l and p_k to project on the respective subrepresentations gives

$$\begin{aligned}
\cap_{ij} &= \text{tr} \left(\bigoplus_{i,j=1}^N p_{li} \otimes \chi_{ij} \mathbb{1}_{m_{ij}} \otimes p_{kj} \oplus \bigoplus_{i,j=1}^N p_{li} \otimes \chi_{ij} \mathbb{1}_{m_{ij}} \otimes p_{kj} \right) \\
&= \text{tr} \left(\bigoplus_{i,j=1}^N p_{li} \otimes \chi_{ij} \mathbb{1}_{m_{ij}} \otimes p_{kj} \right) + \text{tr} \left(\bigoplus_{i,j=1}^N p_{li} \otimes \chi_{ij} \mathbb{1}_{m_{ij}} \otimes p_{kj} \right). \quad (3.72)
\end{aligned}$$

Since only the minimal rank projectors π_l and π_k contribute to the trace, 3.72 reduces

to

$$\begin{aligned}
\cap_{ij} &= \operatorname{tr}(\chi_{lk}\pi_l \otimes \mathbb{1}_{m_{lk}} \otimes \pi_k) + \operatorname{tr}(\chi_{kl}\pi_k \otimes \mathbb{1}_{m_{kl}} \otimes \pi_l) \\
&= \chi_{lk}m_{lk} \underbrace{\operatorname{tr}(\pi_l \otimes \pi_k)}_{=1} + \chi_{kl}m_{kl} \underbrace{\operatorname{tr}(\pi_k \otimes \pi_l)}_{=1} \\
&= \chi_{lk}m_{lk} + \chi_{kl}m_{kl} = \mu_{lk} + \mu_{kl}.
\end{aligned} \tag{3.73}$$

So the non-degenerate intersection form can be expressed with the multiplicity matrix as $\cap = \mu + \mu^t$. Conversely any matrix $\mu \in M_N(\mathbb{Z})$ with $\det \mu + \mu^t \neq 0$ depicts the representation of a real S^0 -real finite spectral triple with N matrix subalgebras over \mathbb{R} . Including matrix algebras over the quaternions is straight forward. Only the respective unit matrices in the representation and the chirality, as well as the size of the respective Hilbert spaces have to be doubled. Introducing matrix algebras over the complex numbers needs a bit more care, since these algebras have two irreducible representations, the fundamental one and its complex conjugate. These two representations have to be taken into account

$$\rho^P(a) = \rho^P \left(\bigoplus_{i=1}^N a_i \right) = \bigoplus_{i,j=1;\alpha_i,\alpha_j}^N a_{i\alpha_i} \otimes \mathbb{1}_{m_{i\alpha_i j\alpha_j}} \otimes \mathbb{1}_{(n_j)} \tag{3.74}$$

$$\rho^A(a) = \rho^A \left(\bigoplus_{j=1}^N a_j \right) = \bigoplus_{i,j=1;\alpha_i,\alpha_j}^N \mathbb{1}_{(n_i)} \otimes \mathbb{1}_{m_{i\alpha_i j\alpha_j}} \otimes a_{j\alpha_j}, \tag{3.75}$$

with $a_{i1} = a_i$ and $a_{i2} = \bar{a}_i$ if $a_i \in M_{n_i}(\mathbb{C})$ and $(n_i) = n_i$ if $a_i \in M_{n_i}(\mathbb{R})$, $M_{n_i}(\mathbb{C})$ and $(n_i) = 2n_i$ if $a_i \in M_{n_i}(\mathbb{H})$. Following the previous calculation is now very tedious and cluttered with indices. The elements of the multiplicity matrix are

$$\mu_{i\alpha_i j\alpha_j} = \chi_{i\alpha_i j\alpha_j} m_{i\alpha_i j\alpha_j}, \tag{3.76}$$

but $\tilde{\cap} = \mu + \mu^t$ is no longer the intersection form. To calculate the intersection form one has to sum over the indices which indicate complex conjugation

$$\cap_{ij} = \beta_{ij} \sum_{\alpha_i, \alpha_j} \tilde{\cap}_{i\alpha_i j\alpha_j}, \tag{3.77}$$

which can also be written as $\cap = \hat{\mu} + \hat{\mu}^t$ with

$$\hat{\mu} = \sum_{\alpha_i, \alpha_j} \mu_{i\alpha_i j\alpha_j}. \tag{3.78}$$

	\mathbb{R}	\mathbb{C}	\mathbb{H}
\mathbb{R}	$\cap_{ij} = \tilde{\cap}_{ij}$ $\hat{\mu}_{ij} = \mu_{ij}$	$\tilde{\cap}_{ij\alpha_j} \tilde{\cap}_{ij\bar{\alpha}_j} \geq 0$ $\cap_{ij} = \sum_{\alpha_j} \tilde{\cap}_{ij\alpha_j}$ $\hat{\mu}_{ij} = \sum_{\alpha_j} \mu_{ij\alpha_j}$	$\cap_{ij} = 2\tilde{\cap}_{ij}$ $\hat{\mu}_{ij} = \mu_{ij}$
\mathbb{C}	$\tilde{\cap}_{i\alpha_i j} \tilde{\cap}_{i\bar{\alpha}_i j} \geq 0$ $\cap_{ij} = \sum_{\alpha_i} \tilde{\cap}_{i\alpha_i j}$ $\hat{\mu}_{ij} = \sum_{\alpha_i} \mu_{i\alpha_i j}$	$\tilde{\cap}_{i\alpha_i j\alpha_j} \tilde{\cap}_{i\bar{\alpha}_i j\bar{\alpha}_j} \geq 0$ $\cap_{ij} = \sum_{\alpha_i\alpha_j} \tilde{\cap}_{i\alpha_i j\alpha_j}$ $\hat{\mu}_{ij} = \sum_{\alpha_i\alpha_j} \mu_{i\alpha_i j\alpha_j}$	$\tilde{\cap}_{i\alpha_i=1j} \tilde{\cap}_{i\bar{\alpha}_i j} \geq 0$ $\cap = 2 \sum_{\alpha_i} \tilde{\cap}_{i\alpha_i j}$ $\hat{\mu}_{ij} = \sum_{\alpha_i} \mu_{i\alpha_i j}$
\mathbb{H}	$\cap_{ij} = 2\tilde{\cap}_{ij}$ $\hat{\mu}_{ij} = \mu_{ij}$	$\tilde{\cap}_{ij\alpha_j} \tilde{\cap}_{ij\bar{\alpha}_j} \geq 0$ $\cap_{ij} = 2 \sum_{\alpha_j} \tilde{\cap}_{ij\alpha_j}$ $\hat{\mu}_{ij} = \sum_{\alpha_j} \mu_{ij\alpha_j}$	$\cap_{ij} = 4\tilde{\cap}_{ij}$ $\hat{\mu}_{ij} = \mu_{ij}$

Figure 3.1: Conditions imposed on $\tilde{\cap}$, \cap , $\hat{\mu}$ and μ .

Here β_{ij} is an integer that depends on the pair of algebras (i, j) and originates from the minimal rank projectors. The orientability 3.33 imposes some extra conditions on μ and \cap , if one or both subalgebras are over the complex numbers. For each possible pair of algebras (i, j) these conditions and β_{ij} are given in the table in figure 3.1. To tighten up the indices, $\bar{\alpha}_i$ is defined as $\bar{1} = 2$ and $\bar{2} = 1$.

The contracted multiplicity matrices $\hat{\mu}$ are the first ingredient of the diagrammatic approach. Any matrix $\hat{\mu} \in M(\mathbb{Z})$ with $\det(\hat{\mu} + \hat{\mu}^t) \neq 0$ encodes all the algebraic data of an real, S^0 -real finite spectral triple, up to possible blow-ups due to the complex conjugate representation. The only missing ingredient is the Dirac operator, which will be treated after an example.

As a simple example the reduced multiplicity matrix

$$\hat{\mu} = \begin{pmatrix} -1 & 2 \\ 0 & 0 \end{pmatrix} \quad (3.79)$$

shall be analysed. It corresponds indeed to a spectral triple, since $\det(\hat{\mu} + \hat{\mu}^t) = -2 \neq 0$. The particle part of the chirality is

$$\begin{aligned} \chi &= (-1)\mathbb{1}_1 \otimes \mathbb{1}_1 \otimes \mathbb{1}_1 \oplus \mathbb{1}_2 \otimes \mathbb{1}_2 \otimes \mathbb{1}_1 \\ &= -1 \oplus \mathbb{1}_2 \otimes \mathbb{1}_2. \end{aligned} \quad (3.80)$$

For the representation one finds

$$\begin{aligned} \rho(a \oplus b)^P &= a \otimes \mathbb{1}_1 \otimes \mathbb{1}_1 \oplus b \otimes \mathbb{1}_2 \otimes \mathbb{1}_1 \\ &= a \oplus b \otimes \mathbb{1}_2 \\ \rho(a \oplus b)^A &= \mathbb{1}_1 \otimes \mathbb{1}_1 \otimes a \oplus \mathbb{1}_2 \otimes \mathbb{1}_2 \otimes a \\ &= a \oplus \mathbb{1}_2 \otimes a\mathbb{1}_2 \end{aligned} \quad (3.81)$$

with $a \oplus b \in \mathcal{A}_f = A \oplus B$ and $A = \mathbb{R}, \mathbb{C}$ and $B = M_2(\mathbb{R}), M_2(\mathbb{C})$ or \mathbb{H} . One can now "un-reduce" or "blow up" the reduced multiplicity matrix to recover all the complex representation by writing down all the permitted multiplicity matrices μ that reduce to $\hat{\mu}$. Take for example $B = M_2(\mathbb{C})$. One possible blow-up would be

$$\mu = \begin{pmatrix} -1 & 1 & 1 \\ 0 & 0 & 0 \\ 0 & 0 & 0 \end{pmatrix} \quad (3.82)$$

where the representation reads

$$\begin{aligned} \rho(a \oplus b)^P &= a \otimes \mathbb{1}_1 \otimes \mathbb{1}_1 \oplus b \otimes \mathbb{1}_1 \otimes \mathbb{1}_1 \oplus \bar{b} \otimes \mathbb{1}_1 \otimes \mathbb{1}_1 \\ &= a \oplus b \oplus \bar{b} \\ \rho(a \oplus b)^A &= \mathbb{1}_1 \otimes \mathbb{1}_1 \otimes a \oplus \mathbb{1}_2 \otimes \mathbb{1}_1 \otimes a \oplus \mathbb{1}_2 \otimes \mathbb{1}_1 \otimes a, \\ &= a \oplus a\mathbb{1}_2 \oplus a\mathbb{1}_2 \end{aligned} \quad (3.83)$$

with the same chirality as in 3.80.

The Dirac operator: The last item missing to complete the finite spectral triple is the Dirac operator. Again the calculation will be shown for matrix algebras over the real numbers. The changes to allow matrix algebras over the complex numbers and the quaternions should be clear in view of the previous considerations. In the finite case the Dirac operator is nothing but a complex matrix $\mathcal{D}_f \in M_{\dim \mathcal{H}}(\mathbb{C})$, subject to the commutation relations presented in the axioms. Taking the Hilbert space basis of the previous considerations it is a matter of simple matrix manipulations to show that from $[\epsilon, \mathcal{D}_f] = [J_f, \mathcal{D}_f] = 0$ follows the general form

$$\mathcal{D}_f = \begin{pmatrix} \Delta & 0 \\ 0 & \bar{\Delta} \end{pmatrix}, \quad \text{with } \Delta \in M_{\dim \mathcal{H}^P}(\mathbb{C}). \quad (3.84)$$

So \mathcal{D}_f splits into two parts, Δ and $\bar{\Delta}$, which are equal up to complex conjugation. The first acts on the particle part of the Hilbert space, the second on the antiparticle part. Since the Dirac operator does not mix the particle and the antiparticle Hilbert space it is sufficient to treat only the particle part Δ . The Dirac operator anti-commutes with the chirality, which translates for Δ to $\Delta \chi^P = -\chi^P \Delta$. It follows that the Dirac operator maps the left Hilbert space to the right Hilbert space and vice versa. As a consequence only spectral triples with left- and right-handed Hilbert subspaces allow a non-zero Dirac operator.

The best one can do to determine the fine structure of Δ is achieved by investigating its action on the Hilbert subspaces \mathcal{H}_{pq}^P 3.67 associated to a multiplicity matrix element $\hat{\mu}_{pq}$. Remember that each such subspace is equivalent to a tensor product of finite complex spaces

$$\mathcal{H}_{pq}^P \simeq \mathbb{C}^{n_p} \otimes \mathbb{C}^{m_{pq}} \otimes \mathbb{C}^{n_q}. \quad (3.85)$$

One first constructs a projector to project onto these subspaces:

$$\begin{aligned} P_{pq} &= \rho^P(\mathbb{1}_p) \rho^A(\mathbb{1}_q) \\ &= \bigoplus_{i,j=1}^N \mathbb{1}_{pi} \otimes \mathbb{1}_{m_{ij}} \otimes \mathbb{1}_{qi}, \end{aligned} \quad (3.86)$$

with $\mathbb{1}_i = 0 \oplus \dots \oplus 0 \oplus \mathbb{1}_{n_i} \oplus 0 \oplus \dots \oplus 0 \in \mathcal{A}_f$. Ignoring the zero summands the projector can be written as

$$P_{pq} = \mathbb{1}_{n_p} \otimes \mathbb{1}_{m_{pq}} \otimes \mathbb{1}_{n_q}, \quad (3.87)$$

acting on \mathcal{H}^P as $P_{pq}\mathcal{H}^P = \mathcal{H}_{pq}^P$. The projectors satisfy the following conditions:

$$\begin{aligned} P_{pq} P_{pq} &= P_{pq} \quad \text{and} \\ P_{pq} P_{rs} &= \delta_{pr}\delta_{qs}P_{pq}P_{rs}. \end{aligned} \quad (3.88)$$

Now the particle part of the Dirac operator Δ can be split into submatrices $\Delta_{pq,rs}$ mapping the Hilbert subspace \mathcal{H}_{rs}^P to \mathcal{H}_{pq}^P ,

$$\Delta_{pq,rs} = P_{pq}\Delta P_{rs}. \quad (3.89)$$

The major constraint on these submatrices is the first order axiom

$$[[\mathcal{D}, \rho(a)], J_f \rho(\tilde{a}) J] = 0, \quad \text{for all } a, \tilde{a} \in \mathcal{A}_f, \quad (3.90)$$

which must of course hold for particle part

$$[[\Delta, \rho^P(a)], \rho^A(\tilde{a})] = 0, \quad \text{for all } a, \tilde{a} \in \mathcal{A}_f. \quad (3.91)$$

Choosing for $a = \mathbb{1}_r$ and for $\tilde{a} = \mathbb{1}_s$ leads to

$$\begin{aligned} [[\Delta, \rho^P(\mathbb{1}_r)], \rho^A(\mathbb{1}_s)] &= [(\Delta\rho^P(\mathbb{1}_r) - \rho^P(\mathbb{1}_r)\Delta), \rho^A(\mathbb{1}_s)] \\ &= \Delta\rho^P(\mathbb{1}_r)\rho^A(\mathbb{1}_s) - \rho^A(\mathbb{1}_s)\Delta\rho^P(\mathbb{1}_r) \\ &\quad - \rho^P(\mathbb{1}_r)\Delta\rho^A(\mathbb{1}_s) + \rho^A(\mathbb{1}_s)\rho^P(\mathbb{1}_r)\Delta. \end{aligned} \quad (3.92)$$

Using the definition of the projectors 3.86, this gives

$$\begin{aligned} 0 &= \Delta P_{rs} - \rho^A(\mathbb{1}_s)\Delta\rho^P(\mathbb{1}_r) \\ &\quad - \rho^P(\mathbb{1}_r)\Delta\rho^A(\mathbb{1}_s) + P_{rs}\Delta. \end{aligned} \quad (3.93)$$

Multiplying 3.93 from the left with P_{pq} and from the right with P_{rs} while keeping in mind that $P_{pq}\rho^P(\mathbb{1}_r) = \delta_{pr}P_{pq}$, $P_{pq}\rho^A(\mathbb{1}_s) = \delta_{qs}P_{pq}$ and $\Delta_{pq,rs} = P_{pq}\Delta P_{rs}$, one finds

$$\begin{aligned} \Delta_{pq,rs} &= -\delta_{pr}\delta_{qs}\Delta_{pq,rs} + \delta_{ps}\delta_{rs}\Delta_{pq,rs} + \delta_{qr}\delta_{sr}\Delta_{pq,rs} \\ &= (-\delta_{pr}\delta_{qs} + \delta_{ps}\delta_{rs} + \delta_{qr}\delta_{sr})\Delta_{pq,rs}. \end{aligned} \quad (3.94)$$

It follows that $\Delta_{pq,rs} \neq 0$ only if $p = r$ and $q \neq s$ or if $p \neq r$ and $q = s$. $\Delta_{pq,pq} = 0$ since the Dirac operator has to map between Hilbert subspaces with different chirality. To

pin down the shape of $\Delta_{pq,pq} = 0$ consider the case with $p \neq r$ and $q = s$. Applied to a spinor $\psi^P \in \mathcal{H}_f^P$

$$\Delta_{pq,rq}\psi^P = \Delta_{pq,rq}\psi_{rq}^P \longmapsto \psi_{pq}^P, \quad (3.95)$$

where

$$\begin{aligned} \psi_{rq} &\in \mathcal{H}_{rq}^P \simeq \mathbb{C}^{n_r} \otimes \mathbb{C}^{m_{rq}} \otimes \mathbb{C}^{n_q} \quad \text{and} \\ \psi_{pq} &\in \mathcal{H}_{pq}^P \simeq \mathbb{C}^{n_p} \otimes \mathbb{C}^{m_{pq}} \otimes \mathbb{C}^{n_q} \end{aligned} \quad (3.96)$$

with \mathcal{H}_{rq}^P and \mathcal{H}_{pq}^P being of opposite chirality. One deduces that $\Delta_{pq,rq}$ has the general form

$$\Delta_{pq,rq} = \mathcal{M}_{(n_r \cdot m_{rq}) \times (n_p \cdot m_{rq})} \otimes \tilde{\mathcal{M}}_{n_q \times n_q} \quad (3.97)$$

where $\mathcal{M}_{(n_r \cdot m_{rq}) \times (n_p \cdot m_{rq})} \in M_{(n_r \cdot m_{rq}) \times (n_p \cdot m_{rq})}(\mathbb{C})$ and $\tilde{\mathcal{M}}_{n_q \times n_q} \in M_{n_q \times n_q}(\mathbb{C})$. The rectangular matrix \mathcal{M} connects the first two entries in the tensor product of ψ_{rq} and ψ_{pq} and $\tilde{\mathcal{M}}$ the third. Applying the first order condition to $\Delta_{pq,rq}$ for arbitrary algebra elements $a, \tilde{a} \in \mathcal{A}_f$ gives

$$\begin{aligned} [[\Delta_{pq,rq}, \rho^P(a)], \rho^A(\tilde{a})] &= [(\Delta_{pq,rq}\rho^P(a) - \rho^P(a)\Delta_{pq,rq}), \rho^A(\tilde{a})] \\ &= \Delta_{pq,rq}\rho^P(a)\rho^A(\tilde{a}) - \rho^A(\tilde{a})\Delta_{pq,rq}\rho^P(a) \\ &\quad - \rho^P(a)\Delta_{pq,rq}\rho^A(\tilde{a}) + \rho^A(\tilde{a})\rho^P(a)\Delta_{pq,rq}. \end{aligned} \quad (3.98)$$

Using the projective property of $\Delta_{pq,rq}$ and leaving out the algebra elements projected to zero leads with 3.97 to

$$\begin{aligned} [[\Delta_{pq,rq}, \rho^P(a)], \rho^A(\tilde{a})] &= [\mathcal{M}_{(n_p \cdot m_{rq}) \times (n_r \cdot m_{rq})}(a_r \otimes \mathbb{1}_{m_{rq}}) \\ &\quad - (a_p \otimes \mathbb{1}_{m_{pq}})\mathcal{M}_{(n_p \cdot m_{rq}) \times (n_r \cdot m_{rq})}] \\ &\quad \otimes [\tilde{\mathcal{M}}_{n_q \times n_q}\tilde{a}_q - \tilde{a}_q\tilde{\mathcal{M}}_{n_q \times n_q}] \\ &\equiv 0. \end{aligned} \quad (3.99)$$

Since this has to be true for any element a_r , a_p and a_q of the subalgebras it follows that $\tilde{\mathcal{M}}_{n_q \times n_q} = \mathbb{1}_{n_q}$. And so

$$\Delta_{pq,rq} = \mathcal{M}_{(n_r \cdot m_{rq}) \times (n_p \cdot m_{rq})} \otimes \mathbb{1}_{n_q} \quad (3.100)$$

and by the same line of reasoning

$$\Delta_{pq,ps} = \mathbb{1}_{n_p} \otimes \mathcal{M}_{(n_q \cdot m_{ps}) \times (n_s \cdot m_{ps})}. \quad (3.101)$$

With the self-adjointness of Δ , it follows immediately from $\Delta_{pq,rq} : \mathcal{H}_{rq}^p \rightarrow \mathcal{H}_{pq}^p$, that $\Delta_{pq,rq}^* : \mathcal{H}_{pq}^p \rightarrow \mathcal{H}_{rq}^p$.

So, translating everything into the language of the multiplicity matrix means that $\Delta_{pq,rq}$ can connect Hilbert subspaces corresponding to the matrix elements $\hat{\mu}_{rq}$ and $\hat{\mu}_{pq}$ if $r \neq p$ and $\text{sign}(\hat{\mu}_{rq}) \neq \text{sign}(\hat{\mu}_{pq})$. The second possibility $\Delta_{pq,ps}$ can connect Hilbert subspaces corresponding to the matrix elements $\hat{\mu}_{ps}$ and $\hat{\mu}_{pq}$ if $p \neq s$ and $\text{sign}(\hat{\mu}_{ps}) \neq \text{sign}(\hat{\mu}_{pq})$.

Putting together the previous conclusions with the notion of the multiplicity matrix the Dirac operator may be depicted by joining two elements of $\hat{\mu}$ of opposite sign within the same row or the same column with a line. To avoid superfluous algebra representations any non-zero element of the multiplicity matrix has to be connected to an element of opposite sign via the Dirac operator. These Diagrams that encode all the information of a real S^0 -real finite spectral triple are called *Krajewski diagrams*.

It is evident that a given multiplicity matrix $\hat{\mu}$ will in general allow several different Dirac operators. By construction all of them will be in accordance with the axioms of a finite spectral triple.

Applying this to the example 3.79 one finds for the contracted multiplicity matrix one possible Dirac operator, joining $\hat{\mu}_{11}$ and $\hat{\mu}_{12}$. So the corresponding Krajewski diagram is

$$\begin{array}{ccc} & a & b \\ a & -1 & -2 \\ & b & 0 & 0 \end{array}$$

The algebra elements a, b corresponding to the entries of $\hat{\mu}_{ij}$ are written out explicitly over the corresponding row or left of the corresponding line. The Dirac operator can

be written off as

$$\mathcal{D} = \begin{pmatrix} 0 & \mathcal{M} & 0 & 0 \\ \mathcal{M}^* & 0 & 0 & 0 \\ 0 & 0 & 0 & \overline{\mathcal{M}} \\ 0 & 0 & \overline{\mathcal{M}^*} & \end{pmatrix} \quad (3.102)$$

with $\mathcal{M} \in M_{4 \times 1}(\mathbb{C})$. A further simplification that will become handy when multiplicity matrices with small numerical entries are treated, is the introduction of the arrow notation. An arrow unifies two multiplicity matrix entries $\hat{\mu}_{ij} = -1, \hat{\mu}_{ik} = 1$ and the Dirac operator submatrix joining them. It is depicted by pointing from positive to negative chirality:

$$\begin{array}{c} \ominus \longleftarrow \ominus \\ \mu_{ij} \quad \mu_{ik} \end{array}$$

The circles only intend to guide the eye of the reader. Every arrow comes with three algebras: Two algebras that localise its end points, they are called *left* (\mathcal{A}_j) and *right algebra* (\mathcal{A}_k) according to their chirality and a third algebra that localises the arrow, called the *colour algebra* (\mathcal{A}_i). The respective submatrice of \mathcal{M} is then of the form $M \otimes \mathbb{1}_{(n_i)}$.

For sums of up to three simple algebras the classification constraints will imply that most entries of μ have an absolute value less than or equal to two. So one can use a *simple arrow* to connect plus one to minus one and *double arrows* to connect plus one to minus two or plus two to minus one

$$\begin{array}{ccc} \ominus \longleftarrow \ominus & \ominus \longleftarrow \bullet & \bullet \longleftarrow \ominus \\ -1 \quad +1 & -2 \quad +1 & -1 \quad +2 \end{array}$$

For a given algebra, every spectral triple is encoded in its multiplicity matrix which itself is encoded in its Krajewski diagram, a field of arrows. In the conventions used here, for particles, $\epsilon = 1$, the column label of the multiplicity matrix indicates the representation, the row label indicates the multiplicity. For antiparticles, the row label of the multiplicity matrix indicates the representation, the column label indicates the multiplicity.

A *black disk* on a double arrow indicates that the coefficient of the multiplicity matrix is plus or minus one at this location, “the two arrows are joined at this location”. For example the following arrows

$$\begin{array}{cc} \ominus \longleftarrow \bullet & \bullet \longleftarrow \ominus \\ \mu_{ij} \quad \mu_{ik} & \mu_{ij} \quad \mu_{ik} \end{array}$$

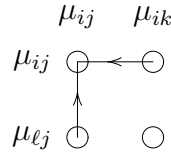

represent respectively submatrices of \mathcal{M} of type

$$\begin{pmatrix} M_1 \\ M_2 \end{pmatrix} \otimes 1_{(n_i)} \quad \text{and} \quad \begin{pmatrix} M_1 & M_2 \end{pmatrix} \otimes 1_{(n_i)} \tag{3.103}$$

with M_1, M_2 of size $(n_j) \times (n_k)$ or in the third case, a matrix of type

$$\begin{pmatrix} M_1 \otimes 1_{(n_i)} & 1_{(n_j)} \otimes M_2 \end{pmatrix} \tag{3.104}$$

where M_1 and M_2 are of size $(n_j) \times (n_k)$ and $(n_i) \times (n_\ell)$.

According to these rules, one can omit the number $\pm 1, \pm 2$ under the arrows, since they are now redundant.

3.5 Almost-Commutative Spectral Triples

The gauge symmetries of a theory correspond in the setting of noncommutative geometry to the automorphisms of the algebra of a spectral triple. For general relativity the gauge symmetries are the diffeomorphisms of a manifold M , for the standard model one has a finite dimensional Lie group. For a combined Einstein-Hilbert and standard model lagrangian the gauge group is the semi-direct product of the diffeomorphisms $\text{Diff}(M)$ and the differentiable maps from M into the gauge group of the standard model $SU(2)_w \times U(1)_Y \times SU(3)_C / (\mathbb{Z}_2 \times \mathbb{Z}_3)$. One can now pose the question whether there is some space X which has this semi-direct product as its diffeomorphism group $\text{Diff}(X)$. Within the set of manifolds no such space exists (this is due to a theorem of J.Mather, see [5]). But spectral triples allow exactly the right symmetries. The Riemannian spectral triple has the diffeomorphisms and the finite spectral triples have finite Lie groups as automorphisms. And spectral triples have a further property: One can build the tensor product of two spectral triples and this product is again a spectral triple. For two spectral triples of Riemannian manifolds M and N , one finds that the tensor product is the spectral triple of their direct product $M \times N$. To obtain the desired semi-direct product as an automorphism group, one has to build the tensor product of a Riemannian spectral triple and a finite spectral

triple.

The tensor product of a spectral triple from a 4-dimensional Riemannian spin manifold (denoted with a subscript R) and a finite spectral triple (denoted with a subscript f) is given by

$$\begin{aligned} \mathcal{A} &= \mathcal{A}_R \otimes \mathcal{A}_f, & \mathcal{H} &= \mathcal{H}_R \otimes \mathcal{H}_f \\ \mathcal{D} &= \not{D} \otimes \mathbb{1}_f + \gamma_5 \otimes \mathcal{D}_f, \\ J &= C \otimes J_f, & \chi &= \gamma_5 \otimes \chi_f, \end{aligned} \tag{3.105}$$

where $\mathbb{1}_f$ is a unit matrix of the size of the finite Hilbert space. The S^0 -real structure is only defined on the finite part. Writing out the Dirac operator gives

$$\mathcal{D} = \begin{pmatrix} \not{D} \otimes \mathbb{1}_{\dim \mathcal{H}_L} & \gamma_5 \otimes \mathcal{M} & 0 & 0 \\ \gamma_5 \otimes \mathcal{M}^* & \not{D} \otimes \mathbb{1}_{\dim \mathcal{H}_R} & 0 & 0 \\ 0 & 0 & \not{D} \otimes \mathbb{1}_{\dim \mathcal{H}_L} & \gamma_5 \otimes \overline{\mathcal{M}} \\ 0 & 0 & \gamma_5 \otimes \overline{\mathcal{M}}^* & \not{D} \otimes \mathbb{1}_{\dim \mathcal{H}_R} \end{pmatrix} \tag{3.106}$$

The lift L of the automorphisms to the Hilbert space is simply the multiplication of the lift for the diffeomorphisms 3.16 and the finite lift 3.54 extended to the differentiable maps $u(x)$ from M into the automorphisms of \mathcal{A}_f

$$L(\sigma(x), u(x)) = L(\sigma(x))\mathbb{L}(u(x)), \quad \sigma(x) \in \text{Diff}(M). \tag{3.107}$$

The space-time dependence will from now on not be written explicitly.

Repeating Einstein: As in the case of Riemannian spectral triples forces will be introduced by writing the Dirac operator in curved coordinates $\tilde{\mathcal{D}} = L(\sigma, u)\mathcal{D}L(\sigma, u)^{-1}$:

$$\tilde{\mathcal{D}} = \begin{pmatrix} \not{D}_L & \gamma_5 \otimes \varphi & 0 & 0 \\ \gamma_5 \otimes \varphi^* & \not{D}_R & 0 & 0 \\ 0 & 0 & C\not{D}_L C^{-1} & \gamma_5 \otimes \overline{\varphi} \\ 0 & 0 & \gamma_5 \otimes \overline{\varphi}^* & C\not{D}_R C^{-1} \end{pmatrix}, \tag{3.108}$$

with

$$\begin{aligned}\not{\phi}_L &= ie_a^{-1\mu}\gamma^a \otimes [\mathbb{1}_{\dim\mathcal{H}_L}\partial_\mu + \mathbb{1}_{\dim\mathcal{H}_L}s(\omega(e)_\mu) + A_{L\mu}], \\ \not{\phi}_R &= ie_a^{-1\mu}\gamma^a \otimes [\mathbb{1}_{\dim\mathcal{H}_R}\partial_\mu + \mathbb{1}_{\dim\mathcal{H}_R}s(\omega(e)_\mu) + A_{R\mu}], \\ A_{L\mu} &= \mathbb{L}_L(u)\partial_\mu\mathbb{L}_L(u)^{-1}, \quad A_{R\mu} = \mathbb{L}_R(u)\partial_\mu\mathbb{L}_R(u)^{-1}.\end{aligned}\tag{3.109}$$

Where the Higgs scalar φ is defined as in 3.56 and the vierbein e and the spin connection $\omega(e)$ as in 3.20. The vector fields $A_{L,R}$ are identified with the gauge bosons corresponding to the gauge group or inner automorphism group of the model. Because of the Riemannian nature of the manifold M the Dirac action is a scalar product

$$S_{Dirac} = (\psi, \mathcal{D}\psi), \quad \psi \in \mathcal{H},\tag{3.110}$$

where the scalar product of spinors is defined as

$$(\psi, \psi') = \int_M \psi(x)^*\psi'(x)dV, \quad \psi, \psi' \in \mathcal{H},\tag{3.111}$$

with $dV := \sqrt{\det(g_{\mu\nu})}d^4x$. Splitting the Hilbert space into left, right, particle and antiparticle spinor multiplets

$$\psi = \begin{pmatrix} \psi_L \\ \psi_R \\ \psi_L^c \\ \psi_R^c \end{pmatrix}\tag{3.112}$$

leads for the Dirac operator 3.108 to the ordinary Dirac action plus the Yukawa action

$$\begin{aligned}
 (\psi, \tilde{\mathcal{D}}\psi) &= \int_M (\psi_L^*, \psi_R^*, \psi_L^{c*}, \psi_R^{c*}) \begin{pmatrix} \not{\partial}_L & \gamma_5 \otimes \varphi & 0 & 0 \\ \gamma_5 \otimes \varphi^* & \not{\partial}_R & 0 & 0 \\ 0 & 0 & C\not{\partial}_L C^{-1} & \gamma_5 \otimes \bar{\varphi} \\ 0 & 0 & \gamma_5 \otimes \bar{\varphi}^* & C\not{\partial}_R C^{-1} \end{pmatrix} \begin{pmatrix} \psi_L \\ \psi_R \\ \psi_L^c \\ \psi_R^c \end{pmatrix} dV \\
 &= \int_M \{ \psi_L^* \not{\partial}_L \psi_L + \psi_R^* \not{\partial}_R \psi_R + \psi_L^{c*} C \not{\partial}_L C^{-1} \psi_L^c + \psi_R^{c*} C \not{\partial}_R C^{-1} \psi_R^c \} dV \\
 &+ \int_M \{ \psi_L^* (\gamma_5 \otimes \varphi^*) \psi_R + \psi_L^{c*} (\gamma_5 \otimes \bar{\varphi}) \psi_R^c + \text{h.c.} \} dV \tag{3.113}
 \end{aligned}$$

As in the pure gravity case there are two ways to implement the relativity principle. The first possibility consists in promoting the vierbein to become an arbitrary symmetric invertible matrix $e(x)$, $A_{L/R}(x)$ to become an arbitrary gauge connection and the Higgs scalar $\varphi(x)$ an arbitrary multiplet of scalar fields, all depending smoothly on x .

The second possibility is again in the spirit of Moser's theorem. One defines the fluctuated Dirac operator

$${}^f\mathcal{D} := \sum_j r_j L(\sigma_j, u_j) \mathcal{D} L(\sigma_j, u_j)^{-1}, \quad r_j \in \mathbb{R}, \quad \sigma_j \in \text{Diff}(M), \quad u_j \in \text{Aut}(\mathcal{A}_f), \tag{3.114}$$

as a finite sum over an arbitrarily chosen Dirac operator \mathcal{D} in different curved coordinate systems. In contrast to the purely gravitational case it will no longer be possible to reach any Dirac operator by fluctuating a given one. This proposition should still be valid for the vierbein e and the gauge connections $A_{L/R}$ but it is certainly not true for the Higgs scalar φ . One could think of this richer structure in the noncommutative part as a shortcoming, but in the classification it will prove to be vital. Due to this extra structure the dynamical configuration space

$$\mathcal{F} := \left\{ \sum_j r_j L(\sigma_j, u_j) \mathcal{D} L(\sigma_j, u_j)^{-1}, \quad r_j \in \mathbb{R}, \quad \sigma_j \in \text{Diff}(M), \quad u_j \in \text{Aut}(\mathcal{A}_f) \right\} \tag{3.115}$$

will in general depend on the choice of \mathcal{D} and here especially on this of \mathcal{D}_f .

The spectral action: For the three fields e , $A_{L/R}$ and φ the spectral action, being the number of eigenvalues of the Dirac operator ${}^f\mathcal{D}$ up to a cut-off Λ , has to be calculated. This is again a long and laborious calculation which is given in detail in [1]. Via the heat-kernel expansion one finds a Yang-Mills-Higgs action

$$\begin{aligned}
S_{CC}[e, A_{L/R}, \varphi] &= \text{tr} \left[h \left(\frac{{}^f\mathcal{D}^2}{\Lambda^2} \right) \right] \\
&= \int_M \left\{ \frac{2\Lambda_c}{16\pi G} - \frac{1}{16\pi G} R + a(5R^2 - 8R_{\mu\nu}R^{\mu\nu} - 7R_{\mu\nu\lambda\tau}R^{\mu\nu\lambda\tau}) \right. \\
&\quad + \sum_i \frac{1}{2g_i^2} \text{tr} F_{i\mu\nu}^* F_i^{\mu\nu} + \frac{1}{2} (D_\mu \varphi)^* D^\mu \varphi \\
&\quad + \lambda \text{tr} (\varphi^* \varphi)^2 - \frac{1}{2} \mu^2 \text{tr} (\varphi^* \varphi) \\
&\quad \left. + \frac{1}{12} \text{tr} (\varphi^* \varphi) R \right\} dV + \mathcal{O}(\Lambda^{-2}) \tag{3.116}
\end{aligned}$$

where the coupling constants are functions of the moments h_0 , h_2 , h_4 and of the cut-off Λ

$$\begin{aligned}
\Lambda_c &= \alpha_1 \frac{h_0}{h_2} \Lambda^2, \quad G = \alpha_2 \frac{1}{h_2} \Lambda^{-2}, \quad a = \alpha_3 h_4, \\
g_i^2 &= \alpha_{4i} \frac{1}{h_4}, \quad \lambda = \alpha_5 \frac{1}{h_4}, \quad \mu^2 = \alpha_5 \frac{h_2}{h_4} \Lambda^2. \tag{3.117}
\end{aligned}$$

The curvature terms $F_{\mu\nu}$ and the covariant derivative D_μ are in the standard form of Yang-Mills-Higgs theory and the constants α_j depend on the special choice of matrix algebras in the finite part of the algebra.

This action is valid at the cut-off Λ where it ties together the coupling constants g_i of the gauge connections and the Higgs coupling λ since they originate from the same heat-kernel coefficient. Comparing this with the running coupling constants of the nonabelian gauge sub-groups of the standard model, which meet at a unifying scale of $\Lambda = 10^{17}$ GeV, and assuming that the particle content of the model in question is complete, one may compute the value of λ at lower energies via the renormalisation groups. This calculation has been carried out explicitly for the standard model [19].

Chapter 4

Classifying Almost-Commutative Geometries

The aim of this thesis is to classify almost-commutative spectral triples from the point of view of elementary particle physics. Since this classification focuses only on the non-gravitational forces one may neglect the gravitational part of the spectral action 3.116. One has then to check all the possible spectral triples for a fixed number of matrix algebra summands in the finite part. There is of course an infinite number of possible finite spectral triples, but a minimal approach realised by imposing some reasonable conditions, which will be described later, and restricting oneself to no more than four summands in the algebra, renders the task feasible. Some of these conditions can be translated to the Krajewski diagrams, which allow to partially translate the algebraic problem into a combinatorial one. These restricted Krajewski diagrams will be called *minimal* and one starts with finding all these minimal diagrams for a given number of summands in the finite part of the algebra.

In the second step one has to analyse the obtained spectral triples, again under assumptions originating in particle physics. The main task consists in finding the minimum of the Yang-Mills-Higgs action. This is achieved by minimising the Higgs potential

$$V(\varphi) = \lambda \text{tr}(\varphi^* \varphi)^2 - \frac{1}{2} \mu^2 \text{tr}(\varphi^* \varphi). \quad (4.1)$$

since the gravitational part will be set to zero. This minimum $\overset{\circ}{\varphi}$ enters the Yang-Mills-Higgs action via the Yukawa terms as the mass term of the fermions. For the classification presented here, the Higgs scalar 3.56 will be defined in the spirit of

Moser's theorem. So the configuration space \mathcal{F} of the Higgs potentials is

$$\mathcal{F} := \left\{ \varphi = \sum_j r_j \mathbb{L}(u_j) \mathcal{D}_f \mathbb{L}(u_j)^{-1}, r_j \in \mathbb{R}, u_j \in \text{Aut}(\mathcal{A}_f) \right\}. \quad (4.2)$$

One has thus to find an element $\overset{\circ}{\varphi} \in \mathcal{F}$ that minimises $V(\varphi)$. For different initial Dirac operators the minima may differ. One has $\mathcal{F}(\mathcal{D}_f) = \mathcal{F}(\tilde{\mathcal{D}}_f)$ or $\mathcal{F}(\mathcal{D}_f) \cap \mathcal{F}(\tilde{\mathcal{D}}_f) = \{0\}$ for $\mathcal{D}_f \neq \tilde{\mathcal{D}}_f$. In the second case one may have $\overset{\circ}{\varphi}(\mathcal{D}_f) \neq \overset{\circ}{\varphi}(\tilde{\mathcal{D}}_f)$. This richer structure of the noncommutative part of the configuration space will be crucial for the standard model, since it allows non-degenerate masses of the fermions. The fermion masses generated by the minimum are gauge-invariant under the little group G_ℓ .

4.1 Constraints from Particle Physics

The present list of constraints from particle physics, which is to be employed in the classification of almost-commutative spectral triples, should be seen in the spirit of Sheldon Glashow's "shopping list" for grand unified theories. The constraints are heteroclitic in the sense that the items on the list have been chosen to please the "gout du jour" of particle physics and noncommutative geometry. A further guidance has been Riemannian geometry and the desire to stay as "minimal" as possible.

Non-degeneracy and irreducibility: A real spectral triple $(\mathcal{A}, \mathcal{H}, \mathcal{D}, J)$ is *degenerate* if the kernel of \mathcal{D} contains a non-trivial subspace of the complex Hilbert space \mathcal{H} invariant under the representation ρ on \mathcal{H} of the real algebra \mathcal{A} and under the real structure J . This requirement is inspired by spectral triples stemming from Riemannian manifolds which are never degenerate.

A non-degenerate spectral triple $(\mathcal{A}, \mathcal{H}, \mathcal{D}, J)$ is *reducible* if there is a proper subspace $\mathcal{H}_0 \subset \mathcal{H}$ invariant under the algebra $\rho(\mathcal{A})$ and the real structure J such that $(\mathcal{A}, \mathcal{H}_0, \mathcal{D}|_{\mathcal{H}_0})$ is a non-degenerate spectral triple. If the triple is S^0 -real and even, one requires the subspace \mathcal{H}_0 to be also invariant under the S^0 -real structure ϵ and under the chirality χ such that the triple $(\mathcal{A}, \mathcal{H}_0, \mathcal{D}|_{\mathcal{H}_0})$ is again S^0 -real and even. Demanding a spectral triple to be irreducible means to choose the smallest possible Hilbert space, i.e. the smallest possible number of fermions. In the quest for the standard model this requirement restricts all models to just one fermionic family. For more details see [7].

Finding minimal Krajewski diagrams: A Krajewski diagram is said to be minimal if erasing any number of arrows from the diagram always results in a diagram which does not respect the Poincarè duality, i.e. $\det(\hat{\mu} + \hat{\mu}^t) = 0$. Erasing an arrow which is connected to another arrow will leave the connection point unchanged. An example for a non-minimal diagram is

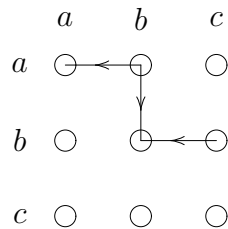

since the vertical arrow can be erased without changing the the multiplicity matrix. Minimality is a necessary but not a sufficient condition for the corresponding spectral triple to be non-degenerate and irreducible. A counter-example for a minimal diagram which is degenerate is diagram 5 of figure 6 in [7]. Finding all minimal Krajewski diagrams is a difficult combinatorial problem. An algorithm to compute all minimal diagrams for a given finite algebra and further details on the problem are presented in [12].

Invariant transformations of Krajewski diagrams: For the physical Yang-Mills-Higgs models following from a Krajewski diagram it is irrelevant if the corresponding multiplicity matrices are transposed, multiplied by -1 or if the rows and columns are renumbered simultaneously. These three transformations amount simply to exchanging particles and antiparticles, left-handed and right-handed particles and to a change of basis of the Hilbert space. They can consequently be regarded as equivalent from the physical point of view. Therefore in the classification only Krajewski diagrams up to these three equivalence relations are taken into account.

Dynamical non-degeneracy: The irreducible spectral triple $(\mathcal{A}, \mathcal{H}, \mathcal{D})$ is *dynamically non-degenerate* if all minima $\overset{\circ}{\varphi}$ of the action $V(\varphi)$ define a non-degenerate spectral triple $(\mathcal{A}, \mathcal{H}, \overset{\circ}{\mathcal{D}})$ and if the spectra of all minima have no degeneracies other than the three kinematical degeneracies: left-right, particle-antiparticle and colour. This means that the fermionic masses are non-degenerate apart from the three kinematical degeneracies. Of course in the massless case there is no left-right degeneracy.

Unbroken colour groups: It is also supposed that the colour degeneracies are protected by the little group. By this one means that all eigenvectors of $\hat{\varphi}$ corresponding to the same eigenvalue are in a common orbit of the little group (and scalar multiplication and charge conjugation). A colour group is defined to be the automorphism group of the colour algebra of an arrow. In physicists' language this last requirement means noncommutative colour groups are unbroken. It ensures that the corresponding mass degeneracies are protected from quantum corrections.

Anomalies: A crucial physical question is, whether a Yang-Mills-Higgs model is free of the Yang-Mills anomalies T_{bc}^a , see 2.24, and mixed gravitational anomalies \widetilde{T}^a , see 2.25. In the almost-commutative the corresponding quantity for T_{bc}^a is

$$T_{\text{YM}} = \text{tr} \left(\frac{1 - \epsilon}{2} \chi \mathbb{L}^3(X) \right) \quad (4.3)$$

and for \widetilde{T}^a it is

$$T_{\text{grav.}} = \text{tr} \left(\frac{1 - \epsilon}{2} \chi \mathbb{L}(X) \right), \quad (4.4)$$

where $\mathbb{L}(X)$ is the Lie algebra version of the lift $\mathbb{L}(u)$. These are required to vanish identically. Imposing the Yang-Mills-Higgs model to be free of those anomalies allows to partially fix the hypercharges via central extensions. For a thorough treatment of the standard model see [29], for the case of three algebras see [28] and for the case of four algebras [14]. As an example see the calculation of the standard model below. Note that there is no geometrical interpretation of the Yang-Mills anomalies and mixed gravitational anomalies within the context of spectral triples. They have their origin in quantum field theory.

The little group: To allow a distinction between particles and antiparticles after symmetry breaking, the little group G_ℓ is required to have a *complex representation* on all subspaces which are irreducible under G_ℓ , i.e. all G_ℓ -multiplets of the fermions. By definition a *real representation* fulfills $\overline{\rho(a)} = \rho(a)$ whereas for a *pseudo-real representation* there exists a unitary operator U , such that $U\overline{\rho(a)}U^{-1} = \rho(a)$. A complex representation is a representation which is neither real nor pseudo-real. Furthermore, if there is a massless fermion it should be uncharged with respect to the little group.

This requirement is inspired by the Lorentz force

$$m\ddot{x} = qF\dot{x} \quad (4.5)$$

which is only well defined for massive particles.

4.2 The Almost-Commutative Standard Model

As an example for the analysis of a minimal Krajewski diagram, the standard model shall be treated in more detail. The minimal approach implies that only one fermion family is considered. Since the calculation is intended to be as instructive as possible it had to be streamlined. Whenever more than one possibility to blow-up a reduced multiplicity matrix occurs, or whenever more than one spectral triple can be constructed from a Krajewski diagram, the way leading to the standard model will be chosen. For a complete treatment of all the possibilities see [7, 13, 12] and [28]. Furthermore the presentation will be restricted, where possible, to the particle part of the occurring operators and representations.

The minimal Krajewski diagram leading to the standard model is diagram 17 of figure 7 in [7], with chirality switched:

$$\begin{array}{ccccc}
 & a & b & c & \\
 a & \ominus \rightarrow \ominus & & \circ & \\
 b & \circ & \circ & \circ & \\
 c & \ominus \rightleftarrows \bullet & & \circ &
 \end{array}$$

The algebra is of the form $\mathcal{A}_f = A \oplus B \oplus C \ni (a, b, c)$, where the respective representations a , b and c of the subalgebras, A , B and C , are written over the columns and to the left of the rows. The size of a matrix subalgebra X shall be written as N_X . Reading off the contracted multiplicity matrix

$$\hat{\mu} = \begin{pmatrix} 1 & -1 & 0 \\ 0 & 0 & 0 \\ 2 & -1 & 0 \end{pmatrix}, \quad (4.6)$$

one sees that $\det(\hat{\mu} + \hat{\mu}^t) = 2 \neq 0$, up to a possible factor from algebras over the quaternions. The single arrow has as left algebra B , as right algebra A and as colour

algebra A . It follows immediately that the colour group is broken, i.e. that the Higgs scalar φ will only be an A -singlet if A is 1-dimensional. Here $A = \mathbb{C}$ is chosen.

The diagram allows for many possibilities to blow-up, i.e. to enlarge an algebra representation by its complex conjugate. For the standard model the blow-up of the first algebra A , leading to the following diagram is appropriate:

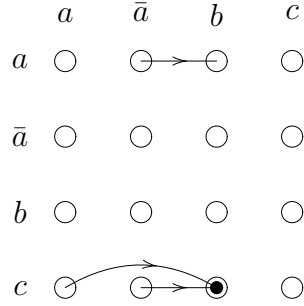

with its multiplicity matrix

$$\mu = \begin{pmatrix} 0 & 1 & -1 & 0 \\ 0 & 0 & 0 & 0 \\ 0 & 0 & 0 & 0 \\ 1 & 1 & -1 & 0 \end{pmatrix}, \quad (4.7)$$

again up to a factor due to matrix algebras over quaternions. From this, one reads off the representation of the algebra, ordered into left and right, particle and antiparticle part:

$$\begin{aligned} \rho_L(a, b, c) &= \begin{pmatrix} b \otimes \mathbb{1}_C & 0 \\ 0 & b \end{pmatrix}, & \rho_R(a, b, c) &= \begin{pmatrix} a\mathbb{1}_C & 0 & 0 \\ 0 & \bar{a}\mathbb{1}_C & 0 \\ 0 & 0 & \bar{a} \end{pmatrix}, \\ \rho_L^c(a, b, c) &= \begin{pmatrix} \mathbb{1}_2 \otimes c & 0 \\ 0 & \bar{a}\mathbb{1}_2 \end{pmatrix}, & \rho_R^c(a, b, c) &= \begin{pmatrix} c & 0 & 0 \\ 0 & c & 0 \\ 0 & 0 & \bar{a} \end{pmatrix}, \end{aligned} \quad (4.8)$$

where $\mathbb{1}_C$ is the unit matrix in C . This representation acts on the Hilbert space

$\mathcal{H} = \mathcal{H}^{PL} \oplus \mathcal{H}^{PR} \oplus \mathcal{H}^{AL} \oplus \mathcal{H}^{AR}$ with the left- and right-handed particle subspaces

$$\mathcal{H}^{PL} = \left(\begin{array}{c} \left(\begin{array}{c} d \\ u \end{array} \right)_L \\ \left(\begin{array}{c} \nu_e \\ e \end{array} \right)_L \end{array} \right), \quad \mathcal{H}^{PR} = \left(\begin{array}{c} d^R \\ u^R \\ e^R \end{array} \right) \quad (4.9)$$

and antiparticle subspaces

$$\mathcal{H}^{AL} = \left(\begin{array}{c} \left(\begin{array}{c} d^c \\ u^c \end{array} \right)_L \\ \left(\begin{array}{c} \nu_e^c \\ e^c \end{array} \right)_L \end{array} \right), \quad \mathcal{H}^{AR} = \left(\begin{array}{c} d^{cR} \\ u^{cR} \\ e^{cR} \end{array} \right), \quad (4.10)$$

where the denomination of the Dirac spinors d , u , ν_e , etc., is intended to be slightly suggestive in view of things to come. Note the fermions appear as left-handed doublets and right-handed singlets. A right-handed ν_e is missing.

The particle part Δ of the Dirac operator is

$$\Delta = \begin{pmatrix} 0 & 0 & M_1 \otimes \mathbf{1}_C & M_2 \otimes \mathbf{1}_C & 0 \\ 0 & 0 & 0 & 0 & M_3 \\ M_1^* \otimes \mathbf{1}_C & 0 & 0 & 0 & 0 \\ M_2^* \otimes \mathbf{1}_C & 0 & 0 & 0 & 0 \\ 0 & M_3^* & 0 & 0 & 0 \end{pmatrix} \quad (4.11)$$

with $M_1, M_2, M_3 \in M_{N_B \times 1}(\mathbb{C})$. To determine the maximal size N_B of the matrix algebra B one uses a trick called *neutrino counting*. Since the fermion masses are to be non-degenerate there must be no more than one massless particle. The Dirac operator with submatrices of the form $M_{N_B \times 1}(\mathbb{C})$ will always have more than one zero eigenvalue if $N_B > 2$. Since these eigenvalues are the masses of fermions, asking for non-degeneracy results in $B = \mathbb{R}, \mathbb{C}$ or $B = M_2(\mathbb{R}), M_2(\mathbb{C})$ or \mathbb{H} . For the present calculation $B = \mathbb{H}$ is chosen. A similar derivation of the standard model with $B = M_2(\mathbb{C})$ can be found in [29]. For the Dirac operator follows that $M_1, M_2, M_3 \in M_{2 \times 1}(\mathbb{C})$.

The last item that needs to be fixed is the algebra C . It is the colour algebra for the double arrow, but it is not broken, so one cannot determine its size. A complex, noncommutative algebra is needed for the central extension, so C is chosen to be

$M_C(\mathbb{C})$, a complex matrix algebra of size $N_C \geq 2$. One than has

$$\mathcal{A}_f = \mathbb{C} \oplus \mathbb{H} \oplus M_C(\mathbb{C}). \quad (4.12)$$

And for the particle part of the chirality one finds

$$\chi^P = \text{diag} [(-1)\mathbb{1}_2 \otimes \mathbb{1}_C, (-1)\mathbb{1}_2, \mathbb{1}_C, \mathbb{1}_C, 1]. \quad (4.13)$$

In the next step the lift \mathbb{L} has to be worked out. The unitaries of \mathcal{A}_f close to the identity are: $\mathcal{U}^e(A) = \mathcal{U}^e(\mathbb{C}) = \{1\}$, $\mathcal{U}^e(B) = \mathcal{U}^e(\mathbb{H}) = SU(2)$ and $\mathcal{U}^e(C) = \mathcal{U}^e(M_C(\mathbb{C})) = U(N_C)$. With definition 3.52 and the algebra representation one finds for the particle part of the lift

$$\begin{aligned} \mathbb{L}^P((\det w)^p, u, (\det w)^q w) &= \rho_L^P((\det w)^p, u, (\det w)^q w) \rho_L^A((\det w)^p, u, (\det w)^q w) \\ &\quad \oplus \rho_R^P((\det w)^p, u, (\det w)^q w) \rho_R^A((\det w)^p, u, (\det w)^q w) \\ &= \text{diag} [(\det w)^q u \otimes w, (\det w)^{-p} u, (\det w)^{p+q} w, \\ &\quad (\det w)^{q-p} w, (\det w)^{-2p}], \end{aligned} \quad (4.14)$$

where $u \in SU(2)$, $w \in U(N_C)$ and $p, q \in \mathbb{Q}$. To fix the exponents p and q the Yang-Mills anomaly condition $T_{\text{YM}} = 0$ is employed. To do so one has to render the lift 4.14 infinitesimal. With

$$\begin{aligned} u &= \mathbb{1}_2 + X + \mathcal{O}(X^2), \quad X \in \mathfrak{su}(2), \quad w = \mathbb{1}_C + Y + \mathcal{O}(Y^2), \quad Y \in \mathfrak{u}(N_C) \\ \text{and} \quad (\det w)^n &= 1 + n \text{tr} X \end{aligned} \quad (4.15)$$

one finds the particle part of the Lie algebra lift

$$\begin{aligned} \mathbb{L}^P &= \text{diag} [\mathbb{1}_2 \otimes (q \text{tr} Y \mathbb{1}_C + Y) + X \otimes \mathbb{1}_C, X - p \text{tr} Y \mathbb{1}_2, Y + \text{tr} Y (q + p) \mathbb{1}_C, \\ &\quad Y + \text{tr} Y (q - p) \mathbb{1}_C, -2p \text{tr} Y]. \end{aligned} \quad (4.16)$$

Demanding that

$$T_{\text{YM}} \text{tr} [\chi^P (\mathbb{L}^P)^3] \quad (4.17)$$

is equal to zero gives, after a tedious but straight forward calculation, a relation

between p , q and the size of C :

$$q = \frac{p-1}{N_C}. \quad (4.18)$$

It is not possible to fix N_C on reasons coming purely from anomalies. The correct physical quantities will have to be fixed later by experiment. Note that the gravitational anomaly T_{grav} vanishes identically for the Lie algebra lift 4.16 for any p , q or N_C . Now the lift \mathbb{L} is given in terms of p and N_C by

$$\begin{aligned} \mathbb{L}^P((\det w)^p, u, (\det w)^{\frac{p-1}{N_C}} w) &= \mathbb{L}^P((\det w)^p, u, (\det w)^{\frac{p}{N_C}} \tilde{w}) \\ &= \text{diag} \left[(\det w)^{\frac{p}{N_C}} u \otimes \tilde{w}, (\det w)^{-p} u, (\det w)^{p+\frac{p}{N_C}} \tilde{w}, \right. \\ &\quad \left. (\det w)^{\frac{p}{N_C}-p} \tilde{w}, (\det w)^{-2p} \right], \end{aligned} \quad (4.19)$$

with $(\det w)^{-1/N_C} w = \tilde{w} \in SU(N_C)$.

Next the Higgs potential $\varphi \in \mathcal{F}$ can be calculated. The three mass matrices M_1 , M_2 and M_3 of the initial Dirac operator are chosen as

$$M_1 = \begin{pmatrix} m_1 \\ 0 \end{pmatrix}, \quad M_2 = \begin{pmatrix} 0 \\ m_2 \end{pmatrix}, \quad \text{and} \quad M_3 = \begin{pmatrix} 0 \\ m_3 \end{pmatrix}, \quad (4.20)$$

with $m_1, m_2, m_3 \in \mathbb{C}$ arbitrary. It follows for the particle part of the Higgs potential

$$\begin{aligned} \varphi^P &= \sum_i r_i \mathbb{L}^P((\det w)^p, u, (\det w)^{\frac{p}{N_C}} \tilde{w}) \Delta \left[\mathbb{L}^P((\det w)^p, u, (\det w)^{\frac{p}{N_C}} \tilde{w}) \right]^{-1} \\ &= \begin{pmatrix} 0 & 0 & \varphi_1 \otimes \mathbb{1}_C & \varphi_2 \otimes \mathbb{1}_C & 0 \\ 0 & 0 & 0 & 0 & \varphi_3 \\ \varphi_1^* \otimes \mathbb{1}_C & 0 & 0 & 0 & 0 \\ \varphi_2^* \otimes \mathbb{1}_C & 0 & 0 & 0 & 0 \\ 0 & \varphi_3^* & 0 & 0 & 0 \end{pmatrix} \end{aligned} \quad (4.21)$$

with

$$\begin{aligned} \varphi_1 &= \sum_i r_i u_i M_1 (\det w_i)^{-p}, \quad \varphi_2 = \sum_i r_i u_i M_1 (\det w_i^p), \quad \text{and} \\ \varphi_3 &= \sum_i r_i u_i M_3 (\det w_i)^p. \end{aligned} \quad (4.22)$$

For the Dirac operator with mass matrices 4.20 it follows that φ_1 , φ_2 and φ_3 allow the following operations: One can combine φ_1 and φ_2 into a single matrix

$$\begin{aligned}\varphi_{1/2} &= \sum_i r_i u_i (M_1, M_2) \begin{pmatrix} (\det w_i)^{-p} & 0 \\ 0 & (\det w_i)^p \end{pmatrix} \\ &= \sum_i r_i u_i \begin{pmatrix} (\det w_i)^{-p} & 0 \\ 0 & (\det w_i)^p \end{pmatrix} (M_1, M_2)\end{aligned}\quad (4.23)$$

and write φ_3 as

$$\varphi_3 = \sum_i r_i u_i \begin{pmatrix} (\det w_i)^{-p} & 0 \\ 0 & (\det w_i)^p \end{pmatrix} M_3. \quad (4.24)$$

This is possible since (M_1, M_2) is a diagonal matrix. One sees further that

$$\begin{pmatrix} (\det w_i)^{-p} & 0 \\ 0 & (\det w_i)^p \end{pmatrix} \in SU(2) \quad (4.25)$$

and thus

$$u_i \begin{pmatrix} (\det w_i)^{-p} & 0 \\ 0 & (\det w_i)^p \end{pmatrix} \in SU(2). \quad (4.26)$$

With the observation that any quaternion $h \in \mathbb{H}$ can be written as $h = ru$ with $r \in \mathbb{R}$ and $u \in SU(2)$ it follows that $\varphi_{1/2}$ and φ_3 take the simple form

$$\varphi_{1/2} = h \begin{pmatrix} m_1 & 0 \\ 0 & m_2 \end{pmatrix}, \quad \varphi_3 = h \begin{pmatrix} 0 \\ m_3 \end{pmatrix}, \quad \text{with } h = \begin{pmatrix} x & y \\ -\bar{y} & \bar{x} \end{pmatrix} \in \mathbb{H}. \quad (4.27)$$

It is now easy to minimise the Higgs potential

$$V(\varphi) = \lambda \text{tr}(\varphi^* \varphi)^2 - \frac{1}{2} \mu^2 \text{tr}(\varphi^* \varphi) \quad (4.28)$$

with respect to the variables $x, y \in \mathbb{C}$. To break up the calculation into smaller steps

one starts with

$$\varphi^* \varphi = \begin{pmatrix} \varphi_{1/2} \varphi_{1/2}^* \otimes \mathbb{1}_C & 0 & 0 & 0 \\ 0 & \varphi_3 \varphi_3^* & 0 & 0 \\ 0 & 0 & \varphi_{1/2}^* \varphi_{1/2} \otimes \mathbb{1}_C & 0 \\ 0 & 0 & 0 & \varphi_3^* \varphi_3 \end{pmatrix}. \quad (4.29)$$

It follows that

$$\begin{aligned} \operatorname{tr}(\varphi \varphi^*) &= 2N_C \operatorname{tr}(\varphi_{1/2}^* \varphi_{1/2}) + 2\operatorname{tr}(\varphi_3 \varphi_3^*) \\ &= 2N_C \operatorname{tr}(\varphi_{1/2}^* \varphi_{1/2}) + 2\varphi_3^* \varphi_3 \end{aligned} \quad (4.30)$$

and

$$\begin{aligned} \operatorname{tr}(\varphi \varphi^*)^2 &= 2N_C \operatorname{tr}(\varphi_{1/2}^* \varphi_{1/2})^2 + 2\operatorname{tr}(\varphi_3 \varphi_3^*)^2 \\ &= 2N_C \operatorname{tr}(\varphi_{1/2}^* \varphi_{1/2})^2 + 2(\varphi_3^* \varphi_3)^2, \end{aligned} \quad (4.31)$$

where the cyclic property of the trace and the vector form of the φ_3 has been used. Furthermore one has

$$\varphi_{1/2}^* = \begin{pmatrix} \bar{m}_1 & 0 \\ 0 & \bar{m}_2 \end{pmatrix} \begin{pmatrix} \bar{x} & -y \\ \bar{y} & x \end{pmatrix} \quad (4.32)$$

and

$$\begin{aligned} \varphi_{1/2}^* \varphi_{1/2} &= \begin{pmatrix} \bar{m}_1 & 0 \\ 0 & \bar{m}_2 \end{pmatrix} \begin{pmatrix} \bar{x} & -y \\ \bar{y} & x \end{pmatrix} \begin{pmatrix} x & y \\ -\bar{y} & \bar{x} \end{pmatrix} \begin{pmatrix} m_1 & 0 \\ 0 & m_2 \end{pmatrix} \\ &= \begin{pmatrix} \bar{m}_1 & 0 \\ 0 & \bar{m}_2 \end{pmatrix} \begin{pmatrix} |x|^2 + |y|^2 & 0 \\ 0 & |x|^2 + |y|^2 \end{pmatrix} \begin{pmatrix} m_1 & 0 \\ 0 & m_2 \end{pmatrix} \\ &= r \begin{pmatrix} |m_1|^2 & 0 \\ 0 & |m_2|^2 \end{pmatrix}, \end{aligned} \quad (4.33)$$

with $r := |x|^2 + |y|^2$ as the new variable. In the same way follows

$$\varphi_3^* \varphi_3 = r |m_3|^2. \quad (4.34)$$

Putting everything into $V(\varphi)$ gives

$$\begin{aligned} V(\varphi) &= \lambda(2N_C|m_1|^4 + 2N_C|m_2|^4 + 2|m_3|^4) r^2 \\ &\quad - \frac{\mu^2}{2}(2N_C|m_1|^2 + 2N_C|m_2|^2 + 2|m_3|^2) r \\ &=: \lambda\alpha r^2 - \frac{\mu^2}{2}\beta r. \end{aligned} \quad (4.35)$$

The minimum in r is found by differentiating with respect to r and is

$$\overset{\circ}{r} = \frac{\alpha \mu^2}{\beta 4\lambda}. \quad (4.36)$$

Now one can construct a minimum of the Higgs potential as

$$\overset{\circ}{\varphi} = \sqrt{\overset{\circ}{r}} \Delta. \quad (4.37)$$

The minimum is given by the initial mass matrices M_1 , M_2 and M_3 up to a fixed numerical factor $\sqrt{\overset{\circ}{r}} \in \mathbb{R}^+$. The masses m_1 , m_2 and m_3 are identified as the quark masses and the electron mass and the Dirac operator has one zero eigenvalue, the mass of the electron-neutrino.

In the last step the little group and the charges of the fermions have to be found. $U(1) \times SU(2) \times SU(N_C)$ is the unbroken gauge group. The little group G_ℓ is defined by $\rho_L^P(g_\ell) \overset{\circ}{\varphi} - \overset{\circ}{\varphi} \rho_R^P(g_\ell) = 0$ for all $g_\ell \in G_\ell$. This is only possible if the representation is diagonal. It follows that $U(1) \times SU(2) \rightarrow U(1) \subset SU(2) \ni v$ so that $G_\ell = U(1) \times SU(N_C)$. The charges of the fermions are then given by the lift of G_ℓ :

$$\begin{aligned} \mathbb{L}^{PL} &= \begin{pmatrix} (\det w)^{\frac{p}{N_C}} \begin{pmatrix} v & 0 \\ 0 & \bar{v} \end{pmatrix} \otimes \tilde{w} & 0 \\ 0 & (\det w)^p \begin{pmatrix} v & 0 \\ 0 & \bar{v} \end{pmatrix} \end{pmatrix} \\ \mathbb{L}^{PR} &= \begin{pmatrix} (\det w)^{p+\frac{p}{N_C}} \tilde{w} & 0 & 0 \\ 0 & (\det w)^{-p+\frac{p}{N_C}} \tilde{w} & 0 \\ 0 & 0 & (\det w)^{-2p} \end{pmatrix}, \end{aligned} \quad (4.38)$$

the electric charges being the exponents of the $U(1)$ elements.

Finally p , N_C and v have to be fixed in view of experimental data. The neutrino has to be neutral under the little group and so $(\det w)^p \bar{v} = 1$ and it follows that

$v = (\det w)^p$. With $p = -1/2$ the electric charge of the electron is $Q_e = -1$. Now using the experimental fact that there are three colours for the quarks, $N_C = 3$ gives charge $Q_d = -1/3$ to the first quark corresponding to m_1 , which can now be identified as the down quark. In the same way one finds for the up quark, corresponding to m_2 , its electric charge $Q_u = +2/3$. Note that the charges for the left and right fermions are equal and that the colour and the electric charge couple vectorially, as desired.

Chapter 5

Conclusions

To conclude this thesis the main results of the work presented in [7, 12, 13] and [14] shall be summarised in a condensed form. Since [7] and [13] do not employ extended lifts as well as the full list of constraints presented in chapter 4, these conclusions will go beyond those publications. For a detailed account see [28]. For four summands the complete calculation is executed in [14].

In the work presented, a classification of spectral triples has been proposed. These spectral triples consist of the tensor product of a spectral triple encoding a 4-dimensional compact Riemannian spin manifold and a finite, real, S^0 -real, irreducible spectral triple whose algebra is a sum of up to four simple matrix algebras. For these spectral triples the spectral action and the Dirac action produce a complete Yang-Mills-Higgs theory, which was analysed with respect to heteroclitic conditions from different areas in theoretical physics.

The major tool to find the spectral triples were Krajewski diagrams which allowed to convert the algebraic problem into a combinatorial one, executable by a computer. This combinatorial problem of finding all minimal Krajewski diagrams for a given number of summands in the finite part of the algebra has been presented in [12]. By ordering all possible diagrams with a given number of arrows into so called *nets*, encoding the reducibility with respect to one another, allows to determine the minimal diagrams. These nets grow rapidly in size and complexity as the number of summands in the finite algebra augments and the algorithm quickly reaches the capacity limits of an ordinary personal computer. For example a net for four algebras with up to four arrows has approximately 11000 diagrams connected among each other. But since each diagram is only the representative of a whole equivalence class, a few million diagrams have to be considered. This explains the trouble with the computer

capacity. An open problem that remains, is the question whether for a given number of arrows all minimal diagrams appear. One could imagine the case that one finds minimal diagrams for two and three arrows but none for four and five. But this does not ensure that there will not be further minimal diagrams for more than five arrows. No criterion telling when and where such "islands" may appear exists. Although for three summands in the finite algebra the complexity is sufficiently small that one can be sure that no minimal diagrams with more than three arrows exist.

Having found the minimal diagrams the corresponding finite spectral triples have been constructed and their Yang-Mills-Higgs models were analysed. If one discards all models that have a dynamically degenerate fermionic mass spectrum, Yang-Mills or gravitational anomalies, a fermion multiplet whose representation under the little group is not complex or a massless particle transforming non-trivially under the little group, the following models survive:

One simple summand: This set is void. The Yang-Mills-Higgs models either produce dynamically degenerate spectral triples or the algebra is commutative and does not have automorphisms close to the identity that could be lifted.

Two simple summands: This set is void, too. The only model which is dynamically non-degenerate consists of the electro-weak part of the standard model for leptons, but it displays a Yang-Mills anomaly and the representation of the little group is not complex.

Three simple summands: Here the diagrams 17 and 22 in the publication [7] fulfil all the requirements.

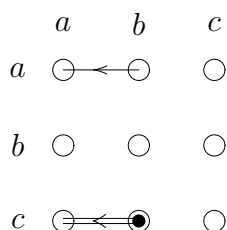

Diagram 17 from [7]

They produce the standard model of particle physics and several sub-models. With their respective algebras the gauge groups and the little groups are as follows:

$$(a) \quad \mathcal{A}_f = \mathbb{C} \oplus M_2(\mathbb{C}) \oplus M_C(\mathbb{C}), \quad U(1) \times SU(2) \times SU(N_C) \rightarrow U(1) \times SU(N_C)$$

The size of the algebra $M_C(\mathbb{C})$ cannot be determined and consequently the number of colours $N_C \geq 2$ remains open. One could argue that the proton, while being a colour singlet, should be a fermion. Then $N_C = 3$ would be the minimal number of colours. So this model reproduces the standard model.

$$(b) \quad \mathcal{A}_f = \mathbb{C} \oplus \mathbb{H} \oplus M_C(\mathbb{C}), \quad U(1) \times SU(2) \times SU(N_C) \rightarrow U(1) \times SU(N_C)$$

This model exhibits the same features as the preceding model and reproduces also the standard model.

$$(c) \quad \mathcal{A}_f = \mathbb{C} \oplus M_2(\mathbb{R}) \oplus M_C(\mathbb{C}), \quad U(1) \times SO(2) \times SU(N_C) \rightarrow U(1) \times SU(N_C)$$

This model closely resembles the standard model, but the W -vector bosons are missing.

$$(d) \quad \mathcal{A}_f = \mathbb{C} \oplus M_2(\mathbb{C}) \oplus M_C(\mathbb{H}), \quad U(1) \times SU(2) \times USp(N_C) \rightarrow U(1) \times USp(N_C)$$

Here roughly half the gluons of the standard model are missing since the symplectic group has roughly half the generators of the special unitary group with equal size. Furthermore the number of colours has to be even, excluding fermionic protons.

$$(e) \quad \mathcal{A}_f = \mathbb{C} \oplus M_2(\mathbb{C}) \oplus M_C(\mathbb{R}), \quad U(1) \times SU(2) \times SO(N_C) \rightarrow U(1) \times SO(N_C)$$

As in the case with quaternionic colour algebra roughly half of the standard model gluons are missing.

Four simple summands: The diagrams 18 and 19 in [14] reproduce exactly the same models as the diagrams 17 and 22 from [7] for three summands.

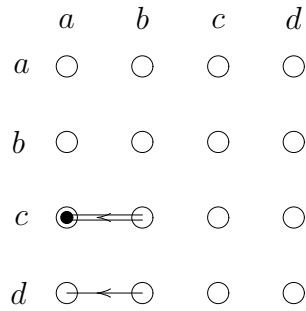

Diagram 18 from [14]

The fourth algebra appearing has to be 1-dimensional since it is the colour algebra for the neutrino. Dimension 1 follows from the condition that a massless fermion should be neutral with respect to the little group. A fascinating feature of this model is that the extra gauge boson, which is produced by the extra colour, decouples completely and has no physical appearance.

In the case of four summands a second Yang-Mills-Higgs model, fulfilling all the requirements, shows up. It is an electro-strong model and may be reconstructed from the diagrams 1,2,3,4,7 and 8 in [14].

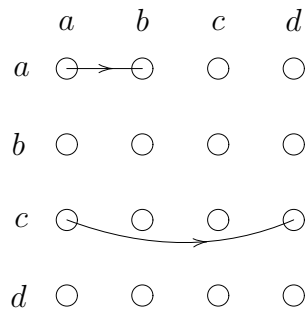

Diagram 1 from [14]

Its particle content consists of two fermions and the algebra and the gauge group are given by

$$\mathcal{A}_f = \mathbb{C} \oplus \mathbb{C} \oplus \mathbb{C} \oplus M_C(\mathbb{C}) \quad U(1) \times SU(N_C) \rightarrow U(1) \times SU(N_C).$$

One of the fermions is electron-like with no colour, the other is quark-like with a colour group $SU(N_C)$ and $N_C \geq 2$. The gauge group couples vectorially and thus it

is not spontaneously broken. It follows that the masses of the fermions are real Dirac masses not originating from a Higgs scalar and the little group is equal to the gauge group.

Summary:

Almost-commutative geometry allows to unify Euclidian general relativity and the standard model of particle physics as classical field theories. This is achieved via the language of spectral triples, the commutative part describing gravity and the finite part, based on sums of matrix algebras, describing the electro-weak and the strong force. In the present setting, and this the essential fact, the Higgs boson acquires a natural interpretation as a connection in the finite part of the spectral triple. These almost-commutative spectral triples were classified with respect to the number of summands of the matrix algebra and under the assumption of reasonable, but heteroclitic physical assumptions stemming from geometry, particle physics and perturbative quantum field theory. The classification resulted, for up to four summands, in a most prominent position of the standard model of particle physics.

Open problems:

Two major open problems remain, to which almost-commutative geometry does not seem to have an answer: Why are there three colours? Why are there three families of fermions? These questions may find a solution in a fully noncommutative theory which has the almost-commutative case as its low-energy limit. But within the almost-commutative regime no solution is in sight.

An outlook:

One may dream of a really noncommutative theory encompassing not only the classical field theories of gravity, the electro-weak and the strong force, but also allowing to describe a unified quantum field theory. But this seems still far beyond the reach of today's theories. A more modest objective is to pursue the chase for spectral triples with more than four simple summands in the finite part of the algebra, and see if new insights can be gained.

Bibliography

- [1] A. Chamseddine, A. Connes, 1997. The Spectral Action Principle. [*hep-th/9606001*], *Comm.Math.Phys.*, **186**, 731.
- [2] A. Connes, 1994. Noncommutative Geometry. *Academic Press*.
- [3] A. Connes, 1995. Noncommutative Geometry and Reality. *J.Math.Phys.*, **36**, 6194.
- [4] A. Connes, 1996. Gravity Coupled with Matter and the Foundations of Noncommutative Geometry. [*hep-th/9603053*], *Comm.Math.Phys.*, **155**.
- [5] A. Connes, 2000. Noncommutative Geometry, Year 2000. *math.QA/0011193*.
- [6] B. Iochum, T. Schücker, 2004. On the Uniqueness of Spin Lifts. *hep-th/0406313*.
- [7] B. Iochum, T. Schücker and C.A. Stephan, 2004. On a Classification of Irreducible Almost Commutative Geometries. [*hep-th/0312276*], *J.Math.Phys.*, **45**, 5003.
- [8] C. Itzykson, J.-B. Zuber, 1985. Quantum Field Theory. *McGraw-Hill Education*.
- [9] C.W. Misner, K.W. Thorne and J.A. Wheeler, 1973. Gravitation. *W.H. Freeman and Company, San Francisco*.
- [10] D. Ebert, 1989. Eichtheorien. *Wiley-VCH*.
- [11] H. Rauch, A. Zeilinger, G. Badurek, A. Wilfing, W. Bauspiess and U. Bonse, 1975. Verification of Coherent Spinor Rotation of Fermions. *Phys.Lett.*, **54A**, 425.
- [12] J.-H. Jureit, C.A. Stephan, 2005. Finding the Standard Model of Particle Physics: A Combinatorial Problem. *hep-th/0503085*.

-
- [13] J.-H. Jureit, C.A. Stephan, 2005. On a Classification of Irreducible Almost Commutative Geometries, a Second Helping. [*hep-th/0501134*], *J.Math.Phys.*, **46**, 3512.
- [14] J.-H. Jureit, T. Schücker and C.A. Stephan, 2005. On a Classification of Irreducible Almost Commutative Geometries III. [*hep-th/0503190*], *J.Math.Phys.* *in press*.
- [15] J. Iliopoulos, 1976. An Introduction to Gauge Theories. *Yellow Report, CERN*.
- [16] J. Moser, 1965. On the Volume Elements on a Manifold. *Trans.Amer.Math.Soc.*, **120**, 286.
- [17] J.M. Gracia-Bondía, J.C. Várilly and H. Figueroa, 2001. Elements of Noncommutative Geometry. *Birkhäuser Advanced Texts*.
- [18] J.P. Bourguignon, P. Gauduchon, 1992. Spinors, Dirac Operators and Metric Variations. *Comm.Math.Phys*, **144**, 581.
- [19] L. Carminati, B. Iochum and T. Schücker, 1999. Noncommutative Yang-Mills and Noncommutative Relativity: A Bridge Over Troubled Water. [*hep-th/9706105*], *Eur. Phys. J.*, **C8**, 697.
- [20] L. O’Raifeartaigh, 1986. Group Structure of Gauge Theories. *Cambridge University Press*.
- [21] M. Paschke, 2001. Von Nichtkommutativen Geometrien, ihren Symmetrien und etwas Hochenergiephysik. *Doctoral Thesis*.
- [22] M. Paschke, A. Sitarz, 1998. Discrete Spectral Triples and their Symmetries. [*q-alg/9612029*], *J.Math.Phys*, **39**, 6191.
- [23] R.A. Bertlmann, 1996. Anomalies in Quantum Field Theory. *Oxford Science Publications*.
- [24] S. Doplicher, K. Fredenhagen and J. E. Roberts, 1995. The Quantum Structure of Spacetime at the Planck Scale and Quantum Fields. [*hep-th/0303037*], *Comm.Math.Phys*, **172**, 187.
- [25] T. Krajewski, 1998. Classification of Finite Spectral Triples. [*hep-th/9701081*], *J.Gem.Phys*, **28**, 1.

-
- [26] T. Krajewski, 1998. Noncommutative Geometry and Fundamental Interactions. [*math-ph/9903047*], *Doctoral Thesis*.
- [27] T. Schücker, 2000. Spin Group and Almost-Commutative Geometry. *hep-th/0007047*.
- [28] T. Schücker, 2005. Krajewski Diagrams and Spin Lifts. *hep-th/0501181*.
- [29] T. Schücker, S. Zouzou, 2001. Spectral Action Beyond the Standard Model. *hep-th/0109124*.

Lebenslauf

Christoph Alexander Stephan
geboren am 27. Mai 1976
in Schleswig.
Staatsangehörigkeit: Deutsch

Schulbildung:

- Domschule zu Schleswig Sept. 1986 - Juni 1995
- Abitur Juni 1995

Zivildienst:

- Domgemeinde Schleswig Juli 1995 - Aug. 1996

Studium:

- Grundstudium und Beginn des
Hauptstudiums an der Christian-
Albrechts-Universität zu Kiel Okt. 1996 - Sept. 1999
- Auslandsstudienjahr an der University
of Cambridge, England, Großbritannien.
Anfertigung einer Masterarbeit bei
Dr. Anthony Challinor zum Thema
*Probing a Cosmological Background
with a One-Electron Atom* Okt. 1999 - Aug. 2000
- Verleihung des Abschlusses März 2001
Master of Philosophy
von der University of Cambridge

- Fortsetzung des Physikstudiums an der CAU, Diplom-Hauptprüfungen Okt. 2000 - März 2002
- Überarbeitung der Masterarbeit aus Cambridge zur Diplomarbeit bei Priv. Doz. Dr. Gerhard Grensing
- Diplom der CAU im Fach Physik März 2002

- Promotion zum Thema *Noncommutative Geometry and the Standard Model of Particle Physics* seit April 2002
bei Priv. Doz. Dr. Gerhard Grensing und Prof. Thomas Schücker.
Die Promotion findet im Rahmen einer *co-tutelle* mit der Université de Provence, Marseille statt.

Stipendien:

- Stipendiat des Cambridge European Trust und des Queens' College zu Cambridge Okt. 1999 - Aug. 2000
- Stipendiat der Friedrich-Ebert-Stiftung, Doktorandenstipendium seit Juli 2002

Erklärung

Diese Dissertationsschrift wurde von mir in Form und Inhalt unter Anleitung von Priv. Doz. Dr. Gerhard Grensing und Prof. Thomas Schücker und nur unter Zuhilfenahme der angegebenen Hilfsmittel angefertigt. Diese Arbeit hat weder in gleicher, noch in ähnlicher Form an anderer Stelle im Rahmen eines Prüfungsverfahrens vorgelegen.

Teile dieser Arbeit wurden bei der Zeitschrift *Journal of Mathematical Physics* eingereicht und zur Veröffentlichung akzeptiert.

Kiel, den 23. Mai 2005

Christoph A. Stephan

Danksagung

Mein Dank gilt meinem Doktorvater Herrn Priv. Doz. Dr. Gerhard Grensing und meinem Gastgeber und Betreuer in Marseille, Prof. Thomas Schücker. Sie haben im Rahmen einer "co-tutelle" meine Dissertation gemeinsam betreut und den erfolgreichen Abschluß der Doktorarbeit überhaupt erst ermöglicht. Beide hatten zu jeder Zeit ein offenes Ohr und eine offene Tür, um alle meine Fragen zu beantworten und mich vor Fehlritten und den Fallstricken der theoretischen Physik zu bewahren.

Herrn Prof. Bruno Iochum danke ich für die fruchtbare Zusammenarbeit, die zu meiner ersten Veröffentlichung geführt hat und für die vielen hilfreichen Ratschläge zu den darauf folgenden Veröffentlichungen. Bei Herrn Dr. Thomas Krajewski möchte ich mich für die geduldige Einführung in die von Ihm mitentwickelte Klassifizierung diskreter spektraler Tripel bedanken.

Mein besonderer Dank gilt meinem mit-Doktoranden Jan-Hendrik Jureit, der mit seinen Programmierkenntnissen und unzähligen kritischen Nachfragen die Klassifizierung fast-kommutativer spektraler Tripel über drei Algebren hinaus überhaupt erst ermöglicht hat. Desweiteren möchte ich mich bei Herrn Dr. Robert Oeckel für seine Einladung nach Mexiko und für viele erkenntnisreiche Diskussionen bedanken.

Für die so dringend benötigte finanzielle Unterstützung danke ich sehr herzlich der Friedrich-Ebert-Stiftung. Ohne Ihr Doktorandenstipendium, wäre diese Dissertation wohl nie zustande gekommen. Hier gilt mein besonderer Dank Herrn Adalbert Schlag, der stets bereit war, meine Auslandsaufenthalte unbürokratisch und großzügig zu unterstützen. In diesem Zusammenhang möchte ich mich auch bei meinem gastgebenden Institut, dem Centre de Physique Théorique in Marseille bedanken, welches mir ebenfalls umfangreiche Reisemittel zur Verfügung gestellt hat.

Zu guter Letzt möchte ich meiner Mutter Marlene Stephan, meinem Bruder Gerald Stephan und meiner ganzen Familie danken. Sie haben mich immer unterstützt und haben mir ein sorgenfreies Studium überhaupt erst ermöglicht. Ich hoffe, daß die bisherige Auswahl meiner Studienorte und die damit verbundenen Möglichkeiten für Besuche und Urlaube zur allgemeinen Zufriedenheit ausgefallen sind.

List of Publications

The following publications are attached to this thesis:

1. *On a classification of almost-commutative spectral triples*, by B. Iochum, T. Schücker and C.A.S.. This paper classifies almost-commutative Yang-Mills-Higgs models with up to three summands in the matrix algebra. This classification does not yet take into account the Yang-Mills anomalies nor the requirement that the representation of the little group should be complex. For further treatment of these issues for up to three algebras see [28].
2. *On a classification of almost-commutative spectral triples, a second helping*, by J.-H. Jureit and C.A.S.. As mentioned above the search for all minimal Krajewski diagrams is a tedious task and when done by hand one risks to miss a few diagrams. The development of a computer program [12] allowed to search for Krajewski diagrams with three algebras and surfaced four diagrams which were left out in [7]. These have been analysed again not taking into account Yang-Mills anomalies and the complex representation of the little group, which can again be found in [28].
3. *Finding the standard model of particle physics, a combinatorial problem*, by J.-H. Jureit and C.A.S.. This publication explains in detail how to find all minimal Krajewski diagrams with letter changing arrows. An algorithm that allows to implement this problem on a computer is developed. It becomes apparent how a seemingly simple problem evolves into a highly complicated combinatorial structure. The program was written in C^{++} .
4. *On a classification of almost-commutative spectral triples, III*, by J.-H. Jureit, T. Schücker and C.A.S.. In this publication the minimal Krajewski diagrams for four summands in the matrix algebra are analysed. These have been obtained with help of the algorithm developed in [12]. This classification exploits all the physical constraints mentioned above, including Yang-Mills anomalies and the criterion of a complex representation of the little group.

CENTRE DE PHYSIQUE THÉORIQUE ¹
CNRS–Luminy, Case 907
13288 Marseille Cedex 9
FRANCE

On a Classification of Irreducible Almost Commutative Geometries

Bruno Iochum ², Thomas Schücker ², Christoph Stephan ³

Abstract

We classify all irreducible, almost commutative geometries whose spectral action is dynamically non-degenerate. Heavy use is made of Krajewski's diagrammatic language. The motivation for our definition of dynamical non-degeneracy stems from particle physics where the fermion masses are non-degenerate.

PACS-92: 11.15 Gauge field theories
MSC-91: 81T13 Yang-Mills and other gauge theories

December 2003

CPT-2003/P.4605
hep-th/yymmxxx

¹ Unité Propre de Recherche 7061

² and Université de Provence,
iochum@cpt.univ-mrs.fr schucker@cpt.univ-mrs.fr

³ and Université de Provence and Universität Kiel,
stephan@cpt.univ-mrs.fr

Contents

1	Introduction	3
2	Irreducibility	4
3	Krajewski diagrams	6
3.1	Conventions and multiplicity matrices	6
3.2	Multiplicity matrix and irreducibility	10
4	Fluctuations and dynamical non-degeneracy	11
5	Statement of the result	12
6	One simple algebra	13
7	Two simple algebras	17
8	Three simple algebras	22
8.1	Proof for $N = 3$	22
8.2	The standard model of electro-weak and strong forces	36
9	Beyond irreducible triples	37
9.1	A reducible triple with non-degenerate spectrum	37
10	Conclusion	38
11	Appendix	40

1 Introduction

Within noncommutative geometry pioneered by Connes [4,5,6,3], the almost commutative ones play an interesting role. They are defined by spectral triples $(\mathcal{A}, \mathcal{H}, \mathcal{D})$ where the algebra \mathcal{A}_t has the form $\mathcal{A}_t = C^\infty(M) \otimes \mathcal{A}$ with \mathcal{A} a direct sum of matrix algebras and M a (compact Euclidean) spacetime. For instance in the standard model of particle physics, $\mathcal{A} = \mathbb{H} \oplus \mathbb{C} \oplus M_3(\mathbb{C})$. It is important to classify the almost commutative triples because of their applications to physics. Let us sketch some of them.

Einstein's derivation of general relativity from Riemannian geometry goes in two steps. The first step sets up the kinematics: the equivalence principle uses general coordinate transformations and starts from the flat metric of special relativity to guess curved metrics. The second step constructs a dynamics for the set of all metrics by imposing covariance under general coordinate transformations.

Connes generalizes Einstein's derivation to noncommutative geometry [6,3]. In this new setting the metric is encoded in a Dirac operator and a coherent definition of the equivalence principle becomes available: the fluctuations of the Dirac operator by algebra automorphisms properly lifted to the Hilbert space of spinors. Indeed in Riemannian geometry, the algebra is the commutative algebra of functions on spacetime, the automorphisms are precisely the general coordinate transformations and fluctuating the flat Dirac operator leads to Dirac operators with curvature and torsion. The second step is the spectral action which in the commutative i.e. Riemannian case reproduces the Einstein-Hilbert action plus a positive cosmological constant and a curvature squared term. The Euclidean spectral action is positive definite and its ground states can be interpreted as a regularization of the initial singularity.

A noncommutative space or geometry is defined by a 'spectral triple' consisting of an algebra \mathcal{A} , a Hilbert space \mathcal{H} and a Dirac operator \mathcal{D} . One important property of noncommutative geometry is that it contains discrete spaces, commutative or not. They have finite dimensional algebras and Hilbert spaces. An almost commutative geometry is a tensor product of the infinite dimensional commutative algebra consisting of space-time functions with a finite dimensional noncommutative algebra, the 'internal space'. The internal Dirac operator is simply an initial fermionic mass matrix and the internal algebra automorphisms of the tensor product are gauge transformations. The internal fluctuations produce gauge bosons and Higgs scalars and the spectral action of an almost commutative geometry produces – besides the gravitational action – the complete Yang-Mills-Higgs action. The Higgs scalar is therefore the internal metric and its dynamics is the Higgs potential. The initial fermionic mass matrix in general is not a solution of the internal dynamics, the 'internal Einstein equation'. These solutions are the minima of the Higgs potential which induces the spontaneous symmetry breaking. They yield the true fermionic mass matrix and we have to compute it. Let us remark that in the prior approach of noncommutative Yang-Mills theories without gravity [7], the Dirac operator was not a dynamical variable. Consequently there was no nuance between initial and true fermion masses.

Although only a small subset of all Yang-Mills-Higgs models can be described as an almost commutative geometry this subset is still infinite and difficult to assess. We

propose to reduce it using two constraints. The first is inspired by ‘grand unified theories’, in particular $SO(10)$: the gauge group of the standard model of electro-magnetic, weak and strong forces is embedded into a simple group and the representation of one generation of quarks and leptons is embedded into an irreducible representation. Therefore our first constraint is: take the internal algebra simple and its spectral triple irreducible. As we will see the resulting fermion masses in the ground state are degenerate in flagrant contradiction to experiment. We therefore analyze internal algebras with two and three simple summands and their irreducible spectral triples. Again, in most cases the fermion masses come out degenerate with a few exceptions. Our aim is to list these exceptions. In other words, our second constraint is to impose a non-degenerate fermionic mass spectrum in the ground state, namely to restrict the analysis to dynamically non-degenerate spectral triples. The mathematical definitions of these constraints are given in sections 2 and 4.

2 Irreducibility

A spectral triple is given by $(\mathcal{A}, \mathcal{H}, \mathcal{D})$ such that the real $*$ -algebra \mathcal{A} acts on the complex Hilbert space \mathcal{H} , the Dirac operator \mathcal{D} on \mathcal{H} is selfadjoint and a priori unbounded. These three items satisfy certain constraints of geometrical significance [4,5,6]. The commutative examples come from the triple $(\mathcal{A} = \mathcal{C}^\infty(M), \mathcal{H} = \mathcal{L}^2(M, \mathcal{S}), \mathcal{D} = i\gamma^\mu \partial_\mu)$ associated to a compact Riemannian spin manifold M . As the resolvent of \mathcal{D} is compact, $(\mathcal{A}, \mathcal{H}, \mathcal{D} = 0)$ is never a spectral triple for infinite dimensional \mathcal{H} . However, this degenerate situation can occur in finite cases, but is excluded from our definition of irreducible spectral triples.

Definition 2.1. i) A spectral triple $(\mathcal{A}, \mathcal{H}, \mathcal{D})$ is *degenerate* if the kernel of \mathcal{D} contains a non-trivial subspace of the complex Hilbert space \mathcal{H} invariant under the representation ρ on \mathcal{H} of the real algebra \mathcal{A} .

ii) A non-degenerate spectral triple $(\mathcal{A}, \mathcal{H}, \mathcal{D})$ is *reducible* if there is a proper subspace $\mathcal{H}_0 \subset \mathcal{H}$ invariant under the algebra $\rho(\mathcal{A})$ such that $(\mathcal{A}, \mathcal{H}_0, \mathcal{D}|_{\mathcal{H}_0})$ is a non-degenerate spectral triple. If the triple is real, S^0 -real and even, we require the subspace \mathcal{H}_0 to be also invariant under the real structure J , the S^0 -real structure ϵ and under the chirality χ such that the triple $(\mathcal{A}, \mathcal{H}_0, \mathcal{D}|_{\mathcal{H}_0})$ is again real, S^0 -real and even.

Remark 2.2. i) $(\mathcal{A} = \mathcal{C}^\infty(M), \mathcal{H} = \mathcal{L}^2(M, \mathcal{S}), \mathcal{D} = i\gamma^\mu \partial_\mu)$ is never degenerate.

ii) If $(\mathcal{A}_i, \mathcal{H}_i, \mathcal{D}_i)$ are two spectral triples then $(\mathcal{A}_1 \otimes \mathcal{A}_2, \mathcal{H}_1 \otimes \mathcal{H}_2, \mathcal{D}_1 \otimes 1)$ is a spectral triple whose kernel of $\mathcal{D}_1 \otimes 1$ is infinite dimensional when \mathcal{H}_2 is of infinite dimension.

iii) A finite dimensional commutative triple is a collection of points. It is non-degenerate if all points have finite distances. The converse is wrong, $\mathcal{A} = \mathbb{C} \oplus \mathbb{C} \oplus \mathbb{C}$ with the triple given by diagram 15 is a counterexample.

iv) A reducible triple is not necessarily decomposable into a direct sum. For example,

$$\mathcal{A} = \mathbb{C} \oplus \mathbb{C} \ni (a, b), \quad \rho(a, b) = \begin{pmatrix} \begin{pmatrix} a & 0 \\ 0 & \bar{a} \end{pmatrix} & 0 & 0 & 0 \\ 0 & b & 0 & 0 \\ 0 & 0 & \begin{pmatrix} \bar{a} & 0 \\ 0 & \bar{a} \end{pmatrix} & 0 \\ 0 & 0 & 0 & \bar{a} \end{pmatrix}, \quad (2.1)$$

$$\mathcal{D} = \begin{pmatrix} 0 & \mathcal{M} & 0 & 0 \\ \mathcal{M}^* & 0 & 0 & 0 \\ 0 & 0 & 0 & \overline{\mathcal{M}} \\ 0 & 0 & \overline{\mathcal{M}^*} & 0 \end{pmatrix}, \quad \mathcal{M} = \begin{pmatrix} 1 \\ 2 \end{pmatrix}. \quad (2.2)$$

Here and throughout, $\bar{}$ and * mean complex conjugation and adjoint.

v) Our definition of irreducibility differs from the one in our favorite book [8]. Indeed every spectral triple coming from a Riemannian spin manifold is irreducible in our case, even if the manifold is not connected, that is when the commutative spectral triple is a direct sum.

vi) In our definition of reducibility, the Dirac operator is not supposed to leave the subspace \mathcal{H}_0 invariant. Our definition is adapted to the use we will make of spectral triples: the fluctuations under algebra automorphisms properly lifted to the Hilbert space promote the Dirac operator to a dynamical variable and we are interested in its dynamics, the spectral action [3].

Since we are mainly interested in finite or 0-dimensional triples, we only recall the definition for this case and also restricting ourselves to the real and S^0 -real triples [5, 6]:

Definition 2.3. A real, S^0 -real, finite spectral triple is given by $(\mathcal{A}, \mathcal{H}, \mathcal{D}, J, \epsilon, \chi)$ with a finite dimensional real algebra \mathcal{A} , a faithful representation ρ of \mathcal{A} on a finite dimensional complex Hilbert space \mathcal{H} . Four additional operators are defined on \mathcal{H} : the Dirac operator \mathcal{D} is selfadjoint, the real structure J is antiunitary, and the S^0 -real structure ϵ and the chirality χ are both unitary involutions. These operators satisfy:

- $J^2 = 1$, $[J, \mathcal{D}] = [J, \chi] = [\epsilon, \chi] = [\epsilon, \mathcal{D}] = 0$, $\epsilon J = -J\epsilon$, $\mathcal{D}\chi = -\chi\mathcal{D}$,
 $[\chi, \rho(a)] = [\epsilon, \rho(a)] = [\rho(a), J\rho(b)J^{-1}] = [[\mathcal{D}, \rho(a)], J\rho(b)J^{-1}] = 0, \forall a, b \in \mathcal{A}$.
- The chirality can be written as a finite sum $\chi = \sum_i \rho(a_i)J\rho(b_i)J^{-1}$. This condition is called *orientability*.
- The intersection form $\cap_{ij} := \text{tr}(\chi \rho(p_i)J\rho(p_j)J^{-1})$ is non-degenerate, $\det \cap \neq 0$. The p_i are minimal rank projections in \mathcal{A} . This condition is called *Poincaré duality*.

With the help of the projectors $(1 \pm \chi)/2$ and $(1 \pm \epsilon)/2$, the Hilbert space is decomposed as

$$\mathcal{H} = \mathcal{H}_L \oplus \mathcal{H}_R \oplus \mathcal{H}_L^c \oplus \mathcal{H}_R^c. \quad (2.3)$$

The two first components correspond in physics to particles, $\epsilon = 1$, the last two correspond to antiparticles, $\epsilon = -1$. We use the convention where left-handed spinors have negative and right-handed spinors have positive chirality.

If we denote by ρ_L the restriction of ρ to \mathcal{H}_L , ... and by ρ_R^c the restriction to \mathcal{H}_R^c , we will always write the representation in the following form

$$\rho := \begin{pmatrix} \rho_L & 0 & 0 & 0 \\ 0 & \rho_R & 0 & 0 \\ 0 & 0 & \overline{\rho_L^c} & 0 \\ 0 & 0 & 0 & \overline{\rho_R^c} \end{pmatrix}. \quad (2.4)$$

With respect to the decomposition (2.3) of \mathcal{H} , \mathcal{D} has the form

$$\mathcal{D} = \begin{pmatrix} 0 & \mathcal{M} & 0 & 0 \\ \mathcal{M}^* & 0 & 0 & 0 \\ 0 & 0 & 0 & \overline{\mathcal{M}} \\ 0 & 0 & \overline{\mathcal{M}^*} & 0 \end{pmatrix}. \quad (2.5)$$

Note that the S^0 -reality of internal spaces is equivalent to the absence of Majorana-Weyl spinors. These are possible in 0-dimensional spaces, but impossible in 4- and (1+3)-dimensional spaces M .

3 Krajewski diagrams

Krajewski and Paschke & Sitarz have classified all finite, thus 0-dimensional, real spectral triples [14,10]. Let us summarize this classification for the S^0 -real case using Krajewski's diagrammatic language.

3.1 Conventions and multiplicity matrices

- The algebra: it is a finite sum of N simple algebras, $\mathcal{A} = \bigoplus_{i=1}^N M_{n_i}(\mathbb{K}_i)$ and $\mathbb{K}_i = \mathbb{R}, \mathbb{C}, \mathbb{H}$ where \mathbb{H} denotes the quaternions.
- The representation: let us start with the easy case, $\mathbb{K} = \mathbb{R}, \mathbb{H}$ in all components of the algebra. The algebras $M_n(\mathbb{R})$ and $M_n(\mathbb{H})$ only have one irreducible representation, the fundamental one on $\mathbb{C}^{(n)}$, where $(n) = n$ for $\mathbb{K} = \mathbb{R}$ and $(n) = 2n$ for $\mathbb{K} = \mathbb{H}$. Therefore ρ is of the form

$$\rho(\bigoplus_{i=1}^N a_i) := (\bigoplus_{i,j=1}^N a_i \otimes 1_{m_{ij}} \otimes 1_{(n_j)}) \oplus (\bigoplus_{i,j=1}^N 1_{(n_i)} \otimes 1_{m_{ji}} \otimes \overline{a_j}). \quad (3.1)$$

The multiplicities m_{ij} are non-negative integers and we denote by 1_n the $n \times n$ identity matrix and set by convention $1_0 := 0$. At the same time the real structure J permutes the two main summands and complex conjugates them, while the S^0 -real structure and the chirality read

$$\epsilon = (\bigoplus_{i,j=1}^N 1_{(n_i)} \otimes 1_{m_{ij}} \otimes 1_{(n_j)}) \oplus (\bigoplus_{i,j=1}^N 1_{(n_i)} \otimes (-1)1_{m_{ji}} \otimes 1_{(n_j)}), \quad (3.2)$$

$$\chi = (\bigoplus_{i,j=1}^N 1_{(n_i)} \otimes \chi_{ji}1_{m_{ji}} \otimes 1_{(n_j)}) \oplus (\bigoplus_{i,j=1}^N 1_{(n_i)} \otimes \chi_{ji}1_{m_{ji}} \otimes 1_{(n_j)}), \quad (3.3)$$

where $\chi_{ij} = \pm 1$ according to our previous convention on left-(right-)handed spinors.

We define the *multiplicity matrix* $\mu \in M_N(\mathbb{Z})$ such that $\mu_{ij} := \chi_{ij} m_{ij}$. There are N minimal projectors in \mathcal{A} , each of the form $p_i = 0 \oplus \dots \oplus 0 \oplus \text{diag}(1_{(1)}, 0, \dots, 0) \oplus 0 \oplus \dots \oplus 0$. With respect to the basis $p_i/(1)$, the matrix of the intersection form is $\mu + \mu^T$.

If the algebra has summands with $\mathbb{K} = \mathbb{C}$, things get more complicated. Indeed $M_n(\mathbb{C})$ has two non-equivalent irreducible representations, the fundamental one and its complex conjugate, so we change (3.1) into

$$\rho(\bigoplus_{i=1}^N a_i) := (\bigoplus_{i,j=1; \alpha_i, \alpha_j}^N a_{i\alpha_i} \otimes 1_{m_{j\alpha_j i\alpha_i}} \otimes 1_{(n_j)}) \oplus (\bigoplus_{i,j=1}^N 1_{(n_i)} \otimes 1_{m_{j\alpha_j i\alpha_i}} \otimes \overline{a_{j\alpha_j}}). \quad (3.4)$$

where $\alpha_i = 1$ when $a_i \in M_{n_i}(\mathbb{K}), \mathbb{K} = \mathbb{R}, \mathbb{H}$ and $\alpha_i = 1, 2$ when $a_i \in M_{n_i}(\mathbb{C})$, and $a_{i1} := a_i, a_{i2} := \bar{a}_i$.

Therefore the multiplicity matrix is an integer valued square matrix of size equal to the number of summands with $\mathbb{K} = \mathbb{R}$ and \mathbb{H} plus two times the number of summands with $\mathbb{K} = \mathbb{C}$ and decomposes into N^2 submatrices of size $1 \times 1, 2 \times 2, 1 \times 2$ and 2×1 . For example $\mathcal{A} = M_n(\mathbb{C}) \oplus M_m(\mathbb{C}) \oplus M_q(\mathbb{R}) \ni (a, b, c)$ has a 5×5 multiplicity matrix. Let us label its rows and columns with algebra elements:

$$\mu = \begin{pmatrix} \mu_{aa} & \mu_{ab} & \mu_{ac} \\ \mu_{ba} & \mu_{bb} & \mu_{bc} \\ \mu_{ca} & \mu_{cb} & \mu_{cc} \\ a\bar{a} & b\bar{b} & c \end{pmatrix} \begin{matrix} a \\ \bar{a} \\ b \\ \bar{b} \\ c \end{matrix}.$$

If both entries μ_{ij} and μ_{ji} of the multiplicity matrix are non-zero, then they must have the same sign.

The nonvanishing entries within each submatrix 1×2 or 2×1 , like μ_{ca} or μ_{ac} , must have the same sign, while the signs of the nonvanishing entries in each 2×2 submatrix, e.g. μ_{aa} or μ_{ab} must be checker board like: $\begin{pmatrix} + & - \\ - & + \end{pmatrix}$ or $\begin{pmatrix} - & + \\ + & - \end{pmatrix}$.

The *contracted multiplicity matrix* $\hat{\mu}$ is the $N \times N$ matrix constructed from μ by replacing each of the previous submatrices in μ by the sum of the entries of the submatrix.

- Poincaré duality: The last condition to be satisfied by the multiplicity matrix reflects the Poincaré duality. With respect to the basis $p_i/(1)$ introduced above, $(1) = 1$ for $\mathbb{K} = \mathbb{R}$ and \mathbb{C} , $(1) = 2$ for $\mathbb{K} = \mathbb{H}$, the matrix of the intersection form is $\hat{\mu} + \hat{\mu}^T$. Therefore we must have $\det(\hat{\mu} + \hat{\mu}^T) \neq 0$.

- The Dirac operator: The components of the (internal) Dirac operator are represented by horizontal or vertical lines connecting two nonvanishing entries of opposite signs in the multiplicity matrix μ and we will orient them from plus to minus. Each arrow represents a nonvanishing, complex submatrix in the Dirac operator: For instance μ_{ij} can be linked to μ_{ik} or μ_{kj} by

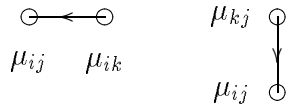

and these arrows represent respectively submatrices of \mathcal{M} in \mathcal{D} of type $M \otimes 1_{(n_i)}$ with M a complex $(n_j) \times (n_k)$ matrix and $1_{(n_j)} \otimes M$ with M a complex $(n_i) \times (n_k)$ matrix.

The requirement of non-degeneracy of a spectral triple means that every nonvanishing entry in the multiplicity matrix μ is touched by at least one arrow.

- Convention for the diagrams: We will see that (for sums of up to three simple algebras) irreducibility implies that most entries of μ have an absolute value less than or equal to two. So we will use a *simple arrow* to connect plus one to minus one and *double arrows* to connect plus one to minus two or plus two to minus one (Figure 1.)

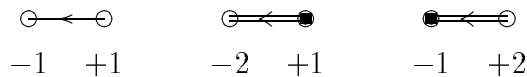
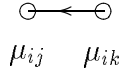
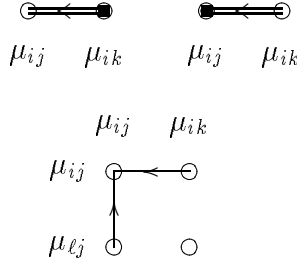

Fig. 1

Our arrows always point from plus, that is right chirality, to minus, that is left chirality. For a given algebra, every spectral triple is encoded in its multiplicity matrix which itself is encoded in its Krajewski diagram, a field of arrows. In our conventions, for particles, $\epsilon = 1$, the column label of the multiplicity matrix indicates the representation, the row label indicates the multiplicity. For antiparticles, the row label of the multiplicity matrix indicates the representation, the column label indicates the multiplicity. Every arrow comes with three algebras: Two algebras that localize its end points, let us call them *right and left algebras* and a third algebra that localizes the arrow, let us call it *colour algebra*. For example for the arrow



the left algebra is \mathcal{A}_j , the right algebra is \mathcal{A}_k and the colour algebra is \mathcal{A}_i . The *circles* in the diagrams only intend to guide the eye. A *black disk* on a double arrow indicates that the coefficient of the multiplicity matrix is plus or minus one at this location, “the two arrows are joined at this location”. For example the the following arrows



represent respectively submatrices of \mathcal{M} of type

$$(M_1 \ M_2) \otimes 1_{(n_i)} \quad \text{and} \quad \begin{pmatrix} M_1 \\ M_2 \end{pmatrix} \otimes 1_{(n_i)}$$

with M_1, M_2 of size $(n_j) \times (n_k)$ or in the third case, a matrix of type $(M_1 \otimes 1_{(n_i)} \ 1_{(n_j)} \otimes M_2)$ where M_1 and M_2 are of size $(n_j) \times (n_k)$ and $(n_i) \times (n_\ell)$.

According to these rules, we can omit the number $\pm 1, \pm 2$ under the arrows like in Figure 2, since they are now redundant.

Let us give a few examples of the explicit form of the spectral triple associated to a given Krajewski’s diagram:

Take the algebra $\mathcal{A} = \mathbb{H} \oplus M_3(\mathbb{C}) \ni (a, b)$ with the first diagram of Figure 2.

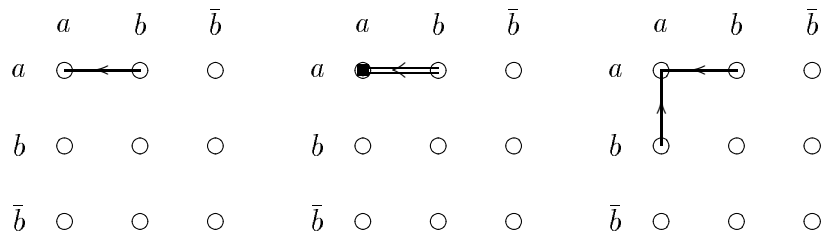

Fig. 2

Then the multiplicity matrix and its contraction are

$$\mu = \begin{pmatrix} -1 & 1 & 0 \\ 0 & 0 & 0 \\ 0 & 0 & 0 \end{pmatrix}, \quad \hat{\mu} = \begin{pmatrix} -1 & 1 \\ 0 & 0 \end{pmatrix}.$$

Using (2.4), its representation is, up to unitary equivalence

$$\rho_L(a, b) = a \otimes 1_2, \quad \rho_R(a, b) = b \otimes 1_2, \quad \rho_L^c(a, b) = 1_2 \otimes a, \quad \rho_R^c(a, b) = 1_3 \otimes a.$$

The Hilbert space is

$$\mathcal{H} = \mathbb{C}^4 \oplus \mathbb{C}^6 \oplus \mathbb{C}^4 \oplus \mathbb{C}^6.$$

In its Dirac operator (2.5), $\mathcal{M} = M \otimes 1_2$, where M is a nonvanishing complex 2×3 matrix.

Real structure, S^0 -real structure and chirality are given by (cc stands for complex conjugation)

$$J = \begin{pmatrix} 0 & 1_{10} \\ 1_{10} & 0 \end{pmatrix} \circ \text{cc}, \quad \epsilon = \begin{pmatrix} 1_{10} & 0 \\ 0 & -1_{10} \end{pmatrix}, \quad \chi = \begin{pmatrix} -1_4 & 0 & 0 & 0 \\ 0 & 1_6 & 0 & 0 \\ 0 & 0 & -1_4 & 0 \\ 0 & 0 & 0 & 1_6 \end{pmatrix}.$$

The first tensor factor in $a \otimes 1_2$ concerns particles, the second concerns antiparticles denoted by \cdot^c . The antiparticle representation is read from the transposed multiplicity matrix.

The second diagram of Figure 2 yields

$$\mu = \begin{pmatrix} -1 & 2 & 0 \\ 0 & 0 & 0 \\ 0 & 0 & 0 \end{pmatrix}, \quad \hat{\mu} = \begin{pmatrix} -1 & 2 \\ 0 & 0 \end{pmatrix},$$

and its spectral triple reads:

$$\rho_L(a, b) = a \otimes 1_2, \quad \rho_R(a, b) = \begin{pmatrix} b & 0 \\ 0 & b \end{pmatrix} \otimes 1_2,$$

$$\rho_L^c(a, b) = 1_2 \otimes a, \quad \rho_R^c(a, b) = \begin{pmatrix} 1_3 & 0 \\ 0 & 1_3 \end{pmatrix} \otimes a,$$

$$\mathcal{M} = (M_1 \quad M_2) \otimes 1_2, \quad M_1 \text{ and } M_2 \text{ of size } 2 \times 3,$$

$$J = \begin{pmatrix} 0 & 1_{16} \\ 1_{16} & 0 \end{pmatrix} \circ \text{cc}, \quad \epsilon = \begin{pmatrix} 1_{16} & 0 \\ 0 & -1_{16} \end{pmatrix}, \quad \chi = \begin{pmatrix} -1_4 & 0 & 0 & 0 \\ 0 & 1_{12} & 0 & 0 \\ 0 & 0 & -1_4 & 0 \\ 0 & 0 & 0 & 1_{12} \end{pmatrix}.$$

In Krajewski's notations, equation (3.1), we would have written $\rho_R(a, b) = b \otimes 1_2 \otimes 1_2$, the middle factor showing the entry of the multiplicity matrix μ .

Finally, still for the same algebra, let us consider the third diagram of Figure 2. It gives

$$\mu = \begin{pmatrix} -1 & 1 & 0 \\ 1 & 0 & 0 \\ 0 & 0 & 0 \end{pmatrix}, \quad \hat{\mu} = \begin{pmatrix} -1 & 1 \\ 1 & 0 \end{pmatrix},$$

and

$$\rho_L(a, b) = a \otimes 1_2, \quad \rho_R(a, b) = \begin{pmatrix} b \otimes 1_2 & 0 \\ 0 & a \otimes 1_3 \end{pmatrix},$$

$$\rho_L^c(a, b) = 1_2 \otimes a, \quad \rho_R^c(a, b) = \begin{pmatrix} 1_3 \otimes a & 0 \\ 0 & 1_2 \otimes b \end{pmatrix},$$

$$\mathcal{M} = (M_1 \otimes 1_2 \quad 1_2 \otimes M_2), \quad M_1 \text{ and } M_2 \text{ of size } 2 \times 3.$$

In the three above examples all arrows have left algebra \mathbb{H} , right algebra $M_3(\mathbb{C})$ and colour algebra \mathbb{H} . The numerous examples below should allow the reader to get familiar with the translation between diagrams and triples.

3.2 Multiplicity matrix and irreducibility

Our work is based on the following lemma indicating that a classification of irreducible spectral triples is possible.

Lemma 3.1. *i) The direct sum of multiplicity matrices is again a multiplicity matrix describing the direct sum of spectral triples.*

ii) For a given algebra there is only a finite list of multiplicity matrices describing irreducible triples.

Proof. i) is obvious.

ii) Given an algebra \mathcal{A} , denote by \mathcal{S} the set of multiplicity matrices $\mu \in M_n(\mathbb{Z})$ (n is determined by \mathcal{A}) associated to irreducible spectral triples. Define a partial order in $M_n(\mathbb{Z})$ by $\mu \geq \nu$ when μ_{ij} and ν_{ij} have the same sign and $|\mu_{ij}| \geq |\nu_{ij}|$ for all $i, j = 1, \dots, n$. The interest of this order is that for two different multiplicity matrices μ, ν such that $\mu \geq \nu$ and $\nu \in \mathcal{S}$, μ corresponds to a reducible triple.

To prove that $\text{card}(\mathcal{S}) < \infty$, we first identify $M_n(\mathbb{Z})$ with \mathbb{Z}^{n^2} . We denote by $\{e_i\}_{i \in \{1, \dots, n^2\}}$ be the canonical basis of \mathbb{Z}^{n^2} and $\mathcal{S}^+ := \mathcal{S} \cap \mathbb{N}^{n^2}$. We now prove that $\text{card}(\mathcal{S}^+) < \infty$, which is sufficient.

Assume $\text{card}(\mathcal{S}^+) = \infty$. Then there exists at least one direction (say along e_1) such that $\sup\{(\mu)_1 | \mu \in \mathcal{S}^+\} = \infty$. Suppose now that in each hyperplane defined by $m e_1, m \in \mathbb{N}$, all points $\mu \in \mathcal{S}^+$ remain uniformly bounded, $\mu_i < B, i = 2, \dots, n^2$. This means that there exists an infinite family of points in an hypertube parallel to e_1 . Necessarily, there exists an infinite subfamily $\{\mu_k\}_{k \in \mathbb{N}} \subset \mathcal{S}^+$ of points in the hypertube which are aligned: $(\mu_k)_i = (\mu_{k+1})_i, \forall i \neq 1$ and $(\mu_k)_1 < (\mu_{k+1})_1$. But this is impossible since $\mu_k \leq \mu_{k+1}$ cannot happen. As a consequence, there exists a second direction (say along e_2 after

renumbering) where the intersection of successive hyperplanes along e_1 and e_2 contain an infinite family of points of \mathcal{S}^+ . By induction, the same reasoning in each direction e_i implies that there exists an infinite family $\{\mu_k\}_k$ of points in \mathcal{S}^+ with increasing vectors: $(\mu_k)_i < (\mu_{k+1})_i, \forall i$. Again this yields the contradiction $\mu_k \leq \mu_{k+1}$ and $\mu_{k+1} \notin \mathcal{S}^+$. \square

4 Fluctuations and dynamical non-degeneracy

The aim of this work is two-fold. First, we work out all irreducible real, S^0 -real diagrams for algebras with one, two and three simple summands. Second, we give all associated spectral triples that are ‘dynamically non-degenerate’. By this we mean the following. The spectrum of the (internal) Dirac operator \mathcal{D} is always degenerate: all nonvanishing eigenvalues come in pairs of opposite sign due to the chirality that anticommutes with \mathcal{D} . All eigenvalues appear twice due to the real structure that commutes with \mathcal{D} . There is a further degeneracy, two-fold in the example above, $\mathcal{M} = M \otimes 1_2$, that comes from the first order axiom. Let us call it *colour degeneracy*. It is absent if and only if the colour algebras of all arrows are commutative. Of course, these three degeneracies survive the fluctuations of the Dirac operator and the minimization of the Higgs potential. By dynamical non-degenerate we mean (see precise definition below) that no minimum of the Higgs potential has degeneracies other than the above three. The first two degeneracies survive *quantum fluctuations* as well. We also want the colour degeneracies to be protected from quantum fluctuations. A natural protection is unbroken gauge invariance, a requirement that we will include into the definition of dynamical non-degeneracy.

Except for complex conjugation in $M_n(\mathbb{C})$ and permutations of identical summands in the algebra $\mathcal{A} = \mathcal{A}_1 \oplus \mathcal{A}_2 \oplus \dots \oplus \mathcal{A}_N$, every algebra automorphism σ is inner, $\sigma(a) = uau^{-1}$ for a unitary $u \in U(\mathcal{A})$. Therefore the connected component of the automorphism group is $\text{Aut}(\mathcal{A})^e = U(\mathcal{A})/(U(\mathcal{A}) \cap \text{Center}(\mathcal{A}))$. Its lift to the Hilbert space [5]

$$L(\sigma) = \rho(u)J\rho(u)J^{-1}$$

is multi-valued.

The *fluctuation* ${}^f\mathcal{D}$ of the Dirac operator \mathcal{D} is given by a finite collection f of real numbers r_j and algebra automorphisms $\sigma_j \in \text{Aut}(\mathcal{A})^e$ such that

$${}^f\mathcal{D} := \sum_j r_j L(\sigma_j) \mathcal{D} L(\sigma_j)^{-1}, \quad r_j \in \mathbb{R}, \sigma_j \in \text{Aut}(\mathcal{A})^e.$$

The fluctuated Dirac operator ${}^f\mathcal{D}$ is often denoted by φ , the ‘Higgs scalar’, in the physics literature. We consider only fluctuations with real coefficients since ${}^f\mathcal{D}$ must remain selfadjoint.

To avoid the multi-valuedness in the fluctuations, we allow the entire unitary group viewed as a (maximal) central extension of the automorphism group. We will come back to minimal central extensions in another work.

An almost commutative geometry is the tensor product of a finite noncommutative triple with an infinite, commutative spectral triple. By Connes’ reconstruction theorem [6] we know that the latter comes from a Riemannian spin manifold, which we will take to

be any 4-dimensional, compact, flat manifold like the flat 4-torus. The spectral action of this almost commutative spectral triple reduced to the finite part is a functional on the vector space of all fluctuated, finite Dirac operators:

$$V({}^f\mathcal{D}) = \lambda \operatorname{tr}[({}^f\mathcal{D})^4] - \frac{\mu^2}{2} \operatorname{tr}[({}^f\mathcal{D})^2],$$

where λ and μ are positive constants [3,11]. The spectral action is invariant under lifted automorphisms and even under the unitary group $U(\mathcal{A}) \ni u$,

$$V([\rho(u)J\rho(u)J^{-1}]{}^f\mathcal{D}[\rho(u)J\rho(u)J^{-1}]^{-1}) = V({}^f\mathcal{D}),$$

and it is bounded from below. Our task is to find the minima $\hat{{}^f\mathcal{D}}$ of this action, their spectra and their *little groups*

$$G_\ell := \left\{ u \in U(\mathcal{A}), [\rho(u)J\rho(u)J^{-1}] \hat{{}^f\mathcal{D}} [\rho(u)J\rho(u)J^{-1}]^{-1} = \hat{{}^f\mathcal{D}} \right\}.$$

Definition 4.1. The irreducible spectral triple $(\mathcal{A}, \mathcal{H}, \mathcal{D})$ is *dynamically non-degenerate* if all minima $\hat{{}^f\mathcal{D}}$ of the action $V({}^f\mathcal{D})$ define a non-degenerate spectral triple $(\mathcal{A}, \mathcal{H}, \hat{{}^f\mathcal{D}})$ and if the spectra of all minima have no degeneracies other than the three kinematical degeneracies: left-right, particle-antiparticle and colour. Of course in the massless case there is no left-right degeneracy. We also suppose that the colour degeneracies are protected by the little group. By this we mean that all eigenvectors of $\hat{{}^f\mathcal{D}}$ corresponding to the same eigenvalue are in a common orbit of the little group (and scalar multiplication and charge conjugation).

In physicists' language this last requirement means noncommutative colour groups are unbroken. It ensures that the corresponding mass degeneracies are protected from quantum corrections.

5 Statement of the result

The main result of this work is the following

Theorem 5.1. *The sum of simple algebras, $\mathcal{A} = \bigoplus_{i=1}^N \mathcal{A}_i$ with $N = 1, 2, 3$ admits a finite, real, S^0 -real, irreducible and dynamically non-degenerate spectral triple if and only if it is in this list, up to a reordering of the summands:*

$N = 1$	$N = 2$	$N = 3$
	$\mathbf{1} \oplus \mathbf{1}$	$\mathbf{1} \oplus \mathbf{1} \oplus \mathcal{C}$
void		$\mathbf{1} \oplus \mathbf{1} \oplus \mathbf{1}$
	$\mathbf{2} \oplus \mathbf{1}$	$\mathbf{2} \oplus \mathbf{1} \oplus \mathcal{C}$
		$\mathbf{2} \oplus \mathbf{1} \oplus \mathbf{1}$

Here **1** is a short hand for \mathbb{R} or \mathbb{C} and **2** for $M_2(\mathbb{R})$, $M_2(\mathbb{C})$ or \mathbb{H} .

The ‘colour’ algebra \mathcal{C} is any simple algebra and has two important constraints:

- i) Its representations on corresponding left- and right-handed subspaces of \mathcal{H} are identical (up to possibly different multiplicities).
- ii) The Dirac operator \mathcal{D} is invariant under $U(\mathcal{C})$,

$$\rho(1, 1, w) \mathcal{D} \rho(1, 1, w)^{-1} = \mathcal{D}, \quad \text{for all } w \in U(\mathcal{C}).$$

This implies that the unitaries of \mathcal{C} do not participate in the fluctuations and are therefore unbroken, i.e. elements of the little group.

Let us emphasize that although the 4-dimensional ‘spacetime’ manifold M used to define the almost commutative geometry does not show up in this result, it is an important ingredient of the spectral action and its asymptotic behavior. In particular the dimension of M is linked to the order of the polynomial V . Therefore our classification indeed concerns 4-dimensional, almost commutative geometries.

We give in section 9.1 an example of a reducible triple which is dynamically non-degenerate and whose algebra is not in the above list.

6 One simple algebra

From the classification [14,10], we know that $\mathcal{A} = M_n(\mathbb{C})$ are the only simple algebras to admit real spectral triples. Up to permutation of a and \bar{a} (complex conjugation in \mathcal{A}), up to permutation of particles and antiparticles (reflection of the diagram with respect to the main diagonal) and up to permutation of left- and right-handed particles (changing the direction of all arrows), all real S^0 -real and irreducible triples have Krajewski diagrams indicated in Figure 3:

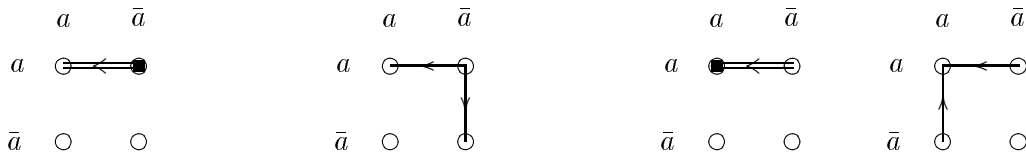

Fig. 3

Indeed, a Krajewski diagram must contain at least one arrow which can be put into the position $\mu = \begin{pmatrix} -1 & +1 \\ 0 & 0 \end{pmatrix}$ by use of the three above permutations. However, alone this arrow does not fulfil Poincaré duality, $\hat{\mu} + \hat{\mu}^T = 0$. There are four ways to add a second arrow. But Poincaré duality can only be satisfied if the two arrows are joined in one point. Adding a third arrow makes the diagram corresponding to a reducible spectral triple. The first diagram yields:

$$\rho_L(a) = \begin{pmatrix} a & 0 \\ 0 & a \end{pmatrix} \otimes 1_n, \quad \rho_R(a) = \bar{a} \otimes 1_n, \quad \rho_L^c(a) = 1_n \otimes \begin{pmatrix} a & 0 \\ 0 & a \end{pmatrix}, \quad \rho_R^c(a) = 1_n \otimes a, \quad (6.1)$$

$$\mathcal{M} := M \otimes 1_n := \begin{pmatrix} M_1 \\ M_2 \end{pmatrix} \otimes 1_n, \quad M_1, M_2 \in M_n(\mathbb{C}).$$

Real structure, S^0 -real structure and chirality are:

$$J = \begin{pmatrix} 0 & 1_{3n^2} \\ 1_{3n^2} & 0 \end{pmatrix} \circ \text{cc}, \quad \epsilon = \begin{pmatrix} 1_{3n^2} & 0 \\ 0 & -1_{3n^2} \end{pmatrix}, \quad \chi = \begin{pmatrix} -1_{2n^2} & 0 & 0 & 0 \\ 0 & +1_{n^2} & 0 & 0 \\ 0 & 0 & -1_{2n^2} & 0 \\ 0 & 0 & 0 & +1_{n^2} \end{pmatrix}.$$

Let us write the fluctuations of \mathcal{D} as

$${}^f\mathcal{D} := \begin{pmatrix} 0 & {}^f\mathcal{M} & 0 & 0 \\ {}^f\mathcal{M}^* & 0 & 0 & 0 \\ 0 & 0 & 0 & \overline{{}^f\mathcal{M}} \\ 0 & 0 & \overline{{}^f\mathcal{M}^*} & 0 \end{pmatrix}. \quad (6.2)$$

Here

$${}^f\mathcal{M} = {}^fM \otimes 1_n = \begin{pmatrix} {}^fM_1 \\ {}^fM_2 \end{pmatrix} \otimes 1_n.$$

Then

$${}^fM_1 = \sum_j r_j u_j M_1 u_j^T, \quad {}^fM_2 = \sum_j r_j u_j M_2 u_j^T, \quad \text{so } {}^fM = \sum_j r_j \begin{pmatrix} u_j & 0 \\ 0 & u_j \end{pmatrix} \begin{pmatrix} M_1 \\ M_2 \end{pmatrix} u_j^T.$$

and

$$V({}^f\mathcal{D}) = \lambda \text{tr} [{}^f\mathcal{D}^4] - \frac{\mu^2}{2} \text{tr} [{}^f\mathcal{D}^2] = 4n (\lambda \text{tr} [({}^fM^* {}^fM)^2] - \frac{\mu^2}{2} \text{tr} [{}^fM^* {}^fM]).$$

The matrix fM is of size $2n \times n$. Therefore the fluctuation ${}^f\mathcal{D}$ has at least n vanishing eigenvalues each still coming with its n -fold colour degeneracy and all triples with $n \geq 2$ are dynamically degenerate since ${}^fM {}^fM^* \in M_{2n}(\mathbb{C})$ has at least n zero eigenvalues.

For $n = 1$, all minima of the action V are of the form $|\hat{M}_1|^2 + |\hat{M}_2|^2 = \frac{\mu^2}{4\lambda}$. But the corresponding fluctuated Dirac operator has a nontrivial invariant subspace in its kernel and the triple is degenerate. To make the subspace explicit apply a unitary change of basis to set fM_2 to zero. In every minimum the little group is \mathbb{Z}_2 .

At this point, an overkill is instructive. We will show that the case $n \geq 2$ also features dynamical degeneracy in the non-zero eigenvalues.

In general, the set of all possible fluctuations ${}^f\mathcal{D}$, i.e. the image under the fluctuations (6.3), is difficult to describe. However, the action V only depends on the positive $n \times n$ matrix $C := {}^fM^* {}^fM$ and is a sum of n^2 polynomials of fourth order in the matrix elements of C :

$$V(C) = 4n \left(\sum_{i=1}^n (\lambda C_{ii}^2 - \frac{\mu^2}{2} C_{ii}) + \sum_{i \neq j} \lambda |C_{ij}|^2 \right). \quad (6.3)$$

If $C = \frac{\mu^2}{4\lambda}1_n$ is in this image then it is the unique minimum in terms of the variable C .

To compute the minima of the action, we now distinguish cases:

1: At least one diagonal element of one of the two matrices is non-zero:

After a suitable renumbering of the basis of the Hilbert space \mathcal{H} , we may assume $(M_1)_{11} \neq 0$. With a first fluctuation,

$$r_1 = \frac{1}{2}, r_2 = \frac{1}{2}, \quad u_1 = 1_n, \quad u_2 = \begin{pmatrix} 1 & 0 \\ 0 & -1_{n-1} \end{pmatrix},$$

we obtain for fM a block diagonal matrix with 2×2 blocks. By means of the fluctuation

$$r_1 = \frac{1}{2}, r_2 = \frac{1}{2}, \quad u_1 = 1_n, \quad u_2 = \begin{pmatrix} 1 & 0 \\ 0 & i1_{n-1} \end{pmatrix},$$

we isolate the (1,1) elements of M_1 and M_2 and with $r_1 = r_2 = \dots = r_n = 1, u_1 = 1_n,$

$$u_2 = \begin{pmatrix} 0 & 1 & 0 \\ 1 & 0 & 0 \\ 0 & 0 & 1_{n-2} \end{pmatrix}, \quad u_3 = \begin{pmatrix} 0 & 0 & 1 & 0 \\ 0 & 1 & 0 & 0 \\ 1 & 0 & 0 & 0 \\ 0 & 0 & 0 & 1_{n-3} \end{pmatrix}, \quad u_4 = \begin{pmatrix} 0 & 0 & 0 & 1 & 0 \\ 0 & 1 & 0 & 0 & 0 \\ 0 & 0 & 1 & 0 & 0 \\ 1 & 0 & 0 & 0 & 0 \\ 0 & 0 & 0 & 0 & 1_{n-4} \end{pmatrix}, \dots$$

we distribute them over the entire diagonal obtaining

$${}^fM = \begin{pmatrix} (M_1)_{11} 1_n \\ (M_2)_{11} 1_n \end{pmatrix}.$$

Then C is a non-vanishing multiple of the identity and a suitable multiple of the above fM is a minimum. The spectrum of this minimum ${}^f\mathcal{D}$ has an additional dynamical degeneracy and up to the sign, ${}^f\mathcal{D}$ has one single eigenvalue. The little group is $G_\ell = O(n)$. Note also that fM_1 and fM_2 are proportional, ${}^fM_1 = \alpha {}^fM_2, \alpha \in \mathbb{C}$, so there is a unitary change of basis in the Hilbert space \mathcal{H} such that ${}^fM_2 = 0$ in the new basis and the spectral triple $(M_n(\mathbb{C}), \mathcal{H}, {}^f\mathcal{D})$ is degenerate.

2: All diagonal elements of M_1 and M_2 vanish but M_1 and M_2 are not both skewsymmetric:

After a suitable renumbering, we may assume $(M_1)_{12} = \beta - \gamma, (M_1)_{21} = \beta + \gamma, (M_1)_{11} = (M_1)_{22} = 0,$ with $\beta \neq 0$. As in case **1** we can isolate this block. Fluctuating with

$$r_1 = 1, \quad u_1 = \begin{pmatrix} 1/\sqrt{2} & -1/\sqrt{2} & 0 \\ 1/\sqrt{2} & 1/\sqrt{2} & 0 \\ 0 & 0 & 1_{n-2} \end{pmatrix},$$

we obtain $({}^fM_1)_{11} = -\beta$ and conclude as in case **1**.

3: M_1 and M_2 are skewsymmetric and linearly dependent:

Thus M can be written as $M = M_1 \otimes \begin{pmatrix} 1 \\ \alpha \end{pmatrix}, \alpha \in \mathbb{C}$ and by a unitary change of basis, we may assume $\alpha = 0$ that is $M_2 = 0$ without changing the representation (6.1). Then

the spectral triple is degenerate. Let us nevertheless finish this case. By another unitary change of basis (or fluctuation), cf. appendix (11.1), we put

$$M_1 = \begin{pmatrix} \begin{pmatrix} 0 & -\lambda_1 \\ \lambda_1 & 0 \end{pmatrix} & & & \\ & \begin{pmatrix} 0 & -\lambda_2 \\ \lambda_2 & 0 \end{pmatrix} & & \\ & & \ddots & \\ & & & 0 \end{pmatrix},$$

where the zero in the lower right corner concerns the case n odd. Let us suppose that λ_1 is not zero. By isolating the upper left block and by distributing it over the entire diagonal we obtain a ${}^fM_{1ii} = \lambda_1$ for all i . If n is even, we then have the minimum $\hat{C} = \frac{\mu^2}{4\lambda} 1_n$ for $V(C)$. Its spectrum is again completely degenerate with little group $G_\ell = USp(\frac{n}{2})$. If n is odd the spectrum of $\hat{\mathcal{D}}$ contains 4 vanishing eigenvalues, all others being of same absolute value and $G_\ell = USp(\frac{n-1}{2}) \times U(1)$.

4: M_1 and M_2 are skewsymmetric and linearly independent:

Then fM_1 and fM_2 vary independently over all skewsymmetric matrices (cf. Lemma A.2). For $n = 3$ the minimization can be done by direct calculation. All minima are gauge equivalent to

$${}^fM = \frac{\mu}{\sqrt{6\lambda}} \begin{pmatrix} 0 & 1 & 0 \\ -1 & 0 & 0 \\ 0 & 0 & 0 \\ 0 & 0 & 1 \\ 0 & 0 & 0 \\ -1 & 0 & 0 \end{pmatrix}, \quad \hat{C} := \hat{M}^* \hat{M} = \frac{\mu^2}{6\lambda} \begin{pmatrix} 2 & 0 & 0 \\ 0 & 1 & 0 \\ 0 & 0 & 1 \end{pmatrix}.$$

Although the spectrum has a two-fold dynamical degeneracy the little group is only $G_\ell = U(1) \ni \text{diag}(e^{i\theta}, e^{-i\theta}, e^{-i\theta})$. For general n , we were unable to compute a minimum explicitly, but we will show that its spectrum is dynamically degenerate. To alleviate notations let us rescale variables, ${}^f\mathcal{D} \rightarrow \frac{\mu}{\sqrt{2\lambda}} {}^f\mathcal{D}$. Then the spectral action reads for $C_i := {}^fM_i^* {}^fM_i$

$$V({}^fM_1, {}^fM_2) = \frac{n\mu^4}{\lambda} (\text{tr}[C_1^2] - \text{tr}[C_1] + \text{tr}[C_2^2] - \text{tr}[C_2] + 2 \text{tr}[C_1 C_2]).$$

All minima of this fourth order polynomial have vanishing partial derivatives with respect to ${}^fM_1^*$ and ${}^fM_2^*$. These equations read

$$\begin{aligned} \hat{M}_1 &= 2 \hat{M}_1 \hat{M}_1^* \hat{M}_1 + \hat{M}_1 \hat{M}_2^* \hat{M}_2 + \hat{M}_2 \hat{M}_2^* \hat{M}_1, \\ \hat{M}_2 &= 2 \hat{M}_2 \hat{M}_2^* \hat{M}_2 + \hat{M}_2 \hat{M}_1^* \hat{M}_1 + \hat{M}_1 \hat{M}_1^* \hat{M}_2. \end{aligned} \tag{6.4}$$

Let us put $X := \hat{C}_1$, $Y := \hat{C}_2$ and $Z := \hat{M}_1^* \hat{M}_2$. We multiply equation (6.4) from the left by \hat{M}_1 and likewise for (6.5) to get

$$\begin{aligned} X &= 2X^2 + XY + ZZ^*, \\ Y &= 2Y^2 + XY + Z^*Z. \end{aligned} \tag{6.5}$$

Subtracting (6.5) from its Hermitian conjugate, we have that X and Y commute and subtracting (6.6) from (6.5) we get

$$2(X - Y)(X + Y - \frac{1}{2}1_n) = [Z^*, Z].$$

Multiplying (6.5) from the left with $\hat{f}M_1^*$ and multiplying the Hermitian conjugate of (6.4) from the right with $\hat{f}M_2$, we have

$$\begin{aligned} Z &= 2ZY + ZX + XZ, \\ Z &= 2XZ + YZ + ZY. \end{aligned} \tag{6.6}$$

Taking the difference, we find that Z commutes with $X + Y$.

We are to show that the spectrum of $\hat{C} = \hat{f}M^*\hat{f}M = X + Y$ is degenerate: Let us suppose that it is non-degenerate. Take an orthonormal basis of eigenvectors of \hat{C} . Then it is also an eigenbasis of Z implying that $[Z, Z^*] = 0$ and by (6.6) the eigenvalues x_j and y_j of X and Y corresponding to the j -th basis vector satisfy at least one of the equations $x_j = y_j$, $x_j + y_j = \frac{1}{2}$. But as $\hat{f}M_1$ and $\hat{f}M_2$ are skewsymmetric, each eigenvalue of X and Y is doubly degenerate with the exception of one vanishing eigenvalue if n is odd. This contradicts the non-degeneracy of $X + Y$.

The triple of the second diagram of figure 3 differs from the first only with respect to representation and Dirac operator

$$\rho_L(a) = \begin{pmatrix} a & 0 \\ 0 & \bar{a} \end{pmatrix} \otimes 1_n, \quad \rho_R(a) = \bar{a} \otimes 1_n, \quad \rho_L^c(a) = 1_n \otimes \begin{pmatrix} a & 0 \\ 0 & \bar{a} \end{pmatrix}, \quad \rho_R^c(a) = 1_n \otimes a,$$

$$\mathcal{M} = \begin{pmatrix} M_1 \otimes 1_n \\ 1_n \otimes M_2 \end{pmatrix}, \quad M_1, M_2 \in M_n(\mathbb{C}).$$

Again, non-degeneracy of the zero eigenvalue requires $n = 1$ and all minima, $|\hat{f}M_1|^2 + |\hat{f}M_2|^2 = \frac{\mu^2}{4\lambda}$, have little group \mathbb{Z}_2 . But now all minima of the action V are not gauge equivalent. Indeed when $\hat{f}M_1 = \mu(4\lambda)^{-1/2}$, $\hat{f}M_2 = 0$ and $\text{Ker}(\mathcal{D}) = \text{Span}\{\mathcal{H}_{L_2}, \mathcal{H}_{L_2}^c\}$. Thus the eigenvector in the image of $\frac{1}{2}(1 - \epsilon)$ associated to the zero eigenvalue of the fluctuated Dirac operator, which is in \mathcal{H}_{L_2} , transforms under $\rho(u)J\rho(u)J^{-1}$ as multiplication by u^{-2} , while it transforms as multiplication by u^2 when $\hat{f}M_2 = \mu(4\lambda)^{-1/2}$. According to our definition the triple is dynamically degenerate because in both cases, the eigenvectors define a one-dimensional complex subspace invariant under \mathcal{A} and contained in the kernel of the fluctuated Dirac operator $\hat{f}\mathcal{D}$.

The last two diagrams of Figure 3 are treated as the first two and yield the same conclusions.

7 Two simple algebras

Again our starting point is the list, Figure 4, of all irreducible Krajewski diagrams up to the three mentioned types of permutations and up to permutations of the two algebras and disregarding any direct sum of two diagrams from Figure 3.

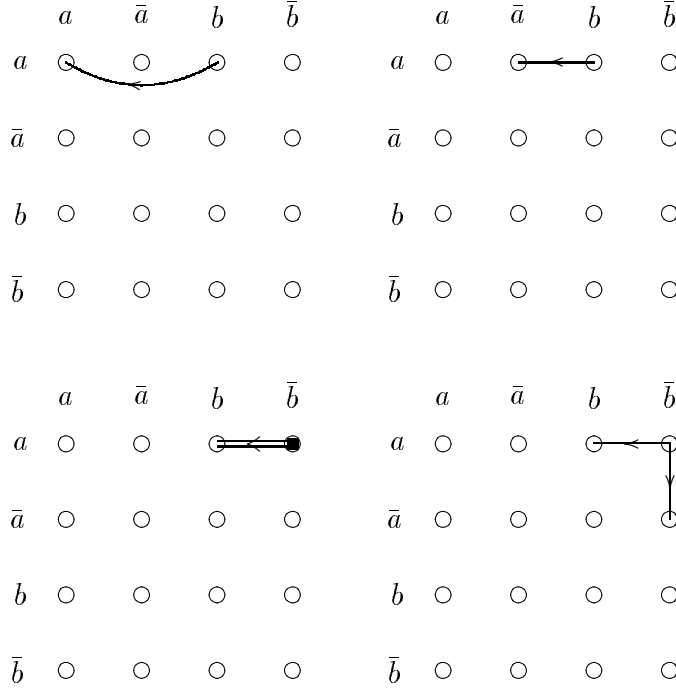

Fig. 4

Let k and ℓ be the size of the matrices of $\mathcal{A}_1 = M_n(\mathbb{K}) \ni a$ and $\mathcal{A}_2 = M_m(\mathbb{K}) \ni b$. E.g. $k = n$ for $\mathcal{A}_1 = M_n(\mathbb{R})$ or $M_n(\mathbb{C})$ and $k = 2n$ for $\mathcal{A}_1 = M_n(\mathbb{H})$.

The first diagram of figure 4 yields:

$$\rho_L(a, b) = a \otimes 1_k, \quad \rho_R(a, b) = b \otimes 1_k, \quad \rho_L^c(a, b) = 1_k \otimes a, \quad \rho_R^c(a, b) = 1_\ell \otimes a,$$

$$\mathcal{M} = M \otimes 1_k, \quad M \in M_{k \times \ell}(\mathbb{C}).$$

M is non-zero and we may assume $M_{11} \neq 0$. Except for the k -fold colour degeneracy, we accept at most one zero eigenvalue of M^*M . Therefore we must have $k = \ell$ or $k = \ell \pm 1$. We assume $\ell \leq k$. Let in (6.2)

$${}^f\mathcal{M} = {}^fM \otimes 1_k, \quad {}^fM = \sum_j r_j u_j M v_j^{-1}, \quad u_j \in U(\mathcal{A}_1), \quad v_j \in U(\mathcal{A}_2).$$

If $k \geq 2, \ell > 2$ or $k > 2, \ell \geq 2$, we may isolate the upper 2×2 block by fluctuations: With the first fluctuation,

$$r_1 = \frac{1}{2}, \quad r_2 = \frac{1}{2}, \quad u_1 = 1_k, \quad v_1 = 1_\ell, \quad u_2 = \begin{pmatrix} 1_2 & 0 \\ 0 & -1_{k-2} \end{pmatrix}, \quad v_2 = \begin{pmatrix} 1_2 & 0 \\ 0 & -1_{\ell-2} \end{pmatrix},$$

we obtain for M a block diagonal type matrix. By means of the fluctuation

$$r_1 = \frac{1}{2}, \quad r_2 = \frac{1}{2}, \quad u_1 = 1_k, \quad v_1 = 1_\ell, \quad u_2 = 1_k, \quad v_2 = \begin{pmatrix} 1_2 & 0 \\ 0 & -1_{\ell-2} \end{pmatrix}.$$

we isolate the upper block. If $k = \ell = 2$ this step is empty.

Now we may distinguish cases.

1: $\mathcal{A}_1 = M_n(\mathbb{R})$ or $M_n(\mathbb{C})$, $\mathcal{A}_2 = M_m(\mathbb{R})$ or $M_m(\mathbb{C})$: like above, we isolate M_{11} and as in case **1** for one algebra we distribute M_{11} over the entire diagonal, obtaining thus ${}^fM^* {}^fM$ proportional to the identity. The spectrum of the fluctuated Dirac operator ${}^f\mathcal{D}$ minimizing the action V has an ℓ -fold dynamical degeneracy.

2: $\mathcal{A}_1 = M_n(\mathbb{H})$, $\mathcal{A}_2 = M_m(\mathbb{H})$, define the fluctuation

$$r_1 = \frac{1}{2}, r_2 = \frac{1}{4}, r_3 = \frac{1}{4}, \quad u_1 = 1_k, v_1 = 1_\ell, u_2 = \begin{pmatrix} \begin{pmatrix} 0 & 1 \\ -1 & 0 \end{pmatrix} & 0 \\ 0 & 1_{k-2} \end{pmatrix},$$

$$v_2 = \begin{pmatrix} \pm \begin{pmatrix} 0 & 1 \\ -1 & 0 \end{pmatrix} & 0 \\ 0 & 1_{\ell-2} \end{pmatrix}, u_3 = \begin{pmatrix} \begin{pmatrix} 0 & i \\ i & 0 \end{pmatrix} & 0 \\ 0 & 1_{k-2} \end{pmatrix}, v_3 = \begin{pmatrix} \pm \begin{pmatrix} 0 & i \\ i & 0 \end{pmatrix} & 0 \\ 0 & 1_{\ell-2} \end{pmatrix},$$

the upper block is proportional to 1_2 . The plus signs in \pm are used if $M_{11} = M_{22}$. We distribute the block over the diagonal and get an ℓ -fold dynamical degeneracy (recall that $\ell \leq k$).

3: $\mathcal{A}_1 = M_n(\mathbb{R})$ or $M_n(\mathbb{C})$, $\mathcal{A}_2 = M_m(\mathbb{H})$. If $M_{12} = 0$ we fluctuate with

$$r_1 = r_2 = \frac{1}{4}, r_3 = \frac{1}{2}, \quad u_1 = 1_k, v_1 = 1_\ell, u_2 = \begin{pmatrix} \begin{pmatrix} 1 & 0 \\ 0 & -1 \end{pmatrix} & 0 \\ 0 & 1_{k-2} \end{pmatrix}, v_2 = 1_\ell,$$

$$u_3 = \begin{pmatrix} \begin{pmatrix} 0 & 1 \\ 1 & 0 \end{pmatrix} & 0 \\ 0 & 1_{k-2} \end{pmatrix}, v_3 = \begin{pmatrix} -\begin{pmatrix} 0 & -1 \\ 1 & 0 \end{pmatrix} & 0 \\ 0 & 1_{\ell-2} \end{pmatrix},$$

and obtain

$${}^fM = \begin{pmatrix} \begin{pmatrix} M_{11} & 0 \\ 0 & -M_{11} \end{pmatrix} & 0 \\ 0 & 0 \end{pmatrix}.$$

If $M_{12} \neq 0$ we fluctuate with

$$r_1 = r_2 = \frac{1}{4}, r_3 = \frac{1}{2}, \quad u_1 = 1_k, v_1 = 1_\ell, u_2 = \begin{pmatrix} 1_2 & 0 \\ 0 & -1_{k-2} \end{pmatrix}, v_2 = 1_\ell,$$

$$u_3 = 1_k, v_3 = \begin{pmatrix} \begin{pmatrix} e^{-i\theta} & 0 \\ 0 & e^{i\theta} \end{pmatrix} & 0 \\ 0 & -1_{\ell-2} \end{pmatrix},$$

with $\theta := \frac{1}{2}(\text{Arg}(M_{11}) - \text{Arg}(M_{12}))$ and obtain

$${}^fM = \begin{pmatrix} \begin{pmatrix} e^{i\theta}M_{11} & e^{-i\theta}M_{12} \\ 0 & 0 \end{pmatrix} & 0 \\ 0 & 0 \end{pmatrix}.$$

In both cases, we distribute the 2×2 block over the diagonal and achieve ${}^fM^* {}^fM$ proportional to the identity.

In all three cases, ℓ must be one to avoid dynamical degeneracy.

The second diagram of Figure 4 is treated in the same fashion. The last two diagrams of Figure 4 have no ‘letter changing arrow’, an arrow connecting an a to a b . They are treated as the triples with one simple algebra: *Counting neutrinos*, that is requiring at most one zero eigenvalue (up to a possible colour degeneracy) yields $\mathcal{A} = \mathbb{C} \oplus \mathbb{C}$ and degeneracy.

Finally using the permutations we get the list of all irreducible, dynamically non-degenerate triples with two algebras:

- There are the commutative triples, that is the two-point spaces, $\mathcal{A} = \mathbb{C} \oplus \mathbb{C} \ni (a, b)$:

$$\rho(a, b) = \begin{pmatrix} a & 0 & 0 & 0 \\ 0 & b & 0 & 0 \\ 0 & 0 & \bar{a} & 0 \\ 0 & 0 & 0 & \bar{a} \end{pmatrix}, \text{ and in } \mathcal{D}, \mathcal{M} \in \mathbb{C}. \quad (7.1)$$

There is a second one with the same algebra:

$$\rho(a, b) = \begin{pmatrix} \bar{a} & 0 & 0 & 0 \\ 0 & b & 0 & 0 \\ 0 & 0 & \bar{a} & 0 \\ 0 & 0 & 0 & \bar{a} \end{pmatrix}. \quad (7.2)$$

And there are the real versions, $\mathcal{A} = \mathbb{C} \oplus \mathbb{R}$, $\mathbb{R} \oplus \mathbb{C}$ and $\mathbb{R} \oplus \mathbb{R}$.

- The noncommutative triples have $\mathcal{A} = M_2(\mathbb{C}) \oplus \mathbb{C} \ni (a, b)$ with four irreducible triples:

$$\rho(a, b) = \begin{pmatrix} a \otimes 1_2 & 0 & 0 & 0 \\ 0 & b1_2 & 0 & 0 \\ 0 & 0 & 1_2 \otimes \bar{a} & 0 \\ 0 & 0 & 0 & \bar{a} \end{pmatrix}, \quad \mathcal{M} = \begin{pmatrix} 0 \\ m \end{pmatrix} \otimes 1_2, \quad m \in \mathbb{C}, \quad (7.3)$$

$$\rho(a, b) = \begin{pmatrix} \bar{a} \otimes 1_2 & 0 & 0 & 0 \\ 0 & b1_2 & 0 & 0 \\ 0 & 0 & 1_2 \otimes \bar{a} & 0 \\ 0 & 0 & 0 & \bar{a} \end{pmatrix}, \quad \mathcal{M} = \begin{pmatrix} 0 \\ m \end{pmatrix} \otimes 1_2, \quad (7.4)$$

$$\rho(a, b) = \begin{pmatrix} a & 0 & 0 & 0 \\ 0 & b & 0 & 0 \\ 0 & 0 & \bar{b}1_2 & 0 \\ 0 & 0 & 0 & \bar{b} \end{pmatrix}, \quad \mathcal{M} = \begin{pmatrix} 0 \\ m \end{pmatrix}, \quad (7.5)$$

$$\rho(a, b) = \begin{pmatrix} a & 0 & 0 & 0 \\ 0 & \bar{b} & 0 & 0 \\ 0 & 0 & \bar{b}1_2 & 0 \\ 0 & 0 & 0 & \bar{b} \end{pmatrix}, \quad \mathcal{M} = \begin{pmatrix} 0 \\ m \end{pmatrix}. \quad (7.6)$$

In all four cases, all minima $\hat{f}\mathcal{D}$ are gauge equivalent to the Dirac operator \mathcal{D} with the absolute value of m fixed in terms of λ and μ and the little groups are

$$G_\ell = U(1) \times U(1) \ni \left(\begin{pmatrix} e^{i\alpha} & 0 \\ 0 & e^{-i\beta} \end{pmatrix}, e^{i\beta} \right).$$

In the two triples (7.3) and (7.4), the unitaries of the colour algebra, $M_2(\mathbb{C})$, are spontaneously broken, they do not leave any minimum invariant, $U(2) \not\subset G_\ell$. According to our definition these two triples are dynamically degenerate.

- Then there are diverse real versions: replace the complex 2×2 matrices $M_2(\mathbb{C})$ by quaternions \mathbb{H} or by real matrices $M_2(\mathbb{R})$ and/or replace \mathbb{C} by \mathbb{R} . For the real forms, of course, we have no complex conjugations in the representations. We summarize the little groups (arrows mean group homomorphisms):

$$\begin{array}{llll} \mathbb{C} \oplus \mathbb{C} & \supset & U(1) \times U(1) & \longrightarrow & U(1), \\ \mathbb{C} \oplus \mathbb{R} & \supset & U(1) \times \mathbb{Z}_2 & \longrightarrow & U(1), \\ \mathbb{R} \oplus \mathbb{R} & \supset & \mathbb{Z}_2 \times \mathbb{Z}_2 & \longrightarrow & \mathbb{Z}_2, \\ M_2(\mathbb{C}) \oplus \mathbb{C} & \supset & U(2) \times U(1) & \longrightarrow & U(1) \times U(1), \\ M_2(\mathbb{C}) \oplus \mathbb{R} & \supset & U(2) \times \mathbb{Z}_2 & \longrightarrow & U(1) \times \mathbb{Z}_2, \\ \mathbb{H} \oplus \mathbb{C} & \supset & SU(2) \times U(1) & \longrightarrow & U(1), \\ \mathbb{H} \oplus \mathbb{R} & \supset & SU(2) \times \mathbb{Z}_2 & \longrightarrow & \mathbb{Z}_2, \\ M_2(\mathbb{R}) \oplus \mathbb{C} & \supset & O(2) \times U(1) & \longrightarrow & \mathbb{Z}_2 \times \mathbb{Z}_2, \\ M_2(\mathbb{R}) \oplus \mathbb{R} & \supset & O(2) \times \mathbb{Z}_2 & \longrightarrow & \mathbb{Z}_2 \times \mathbb{Z}_2. \end{array} \quad (7.7)$$

The triples (7.3) or its commutative version (7.1), (7.4) or its commutative version (7.2), (7.5), and (7.6) are represented by the four diagrams of figure 5.

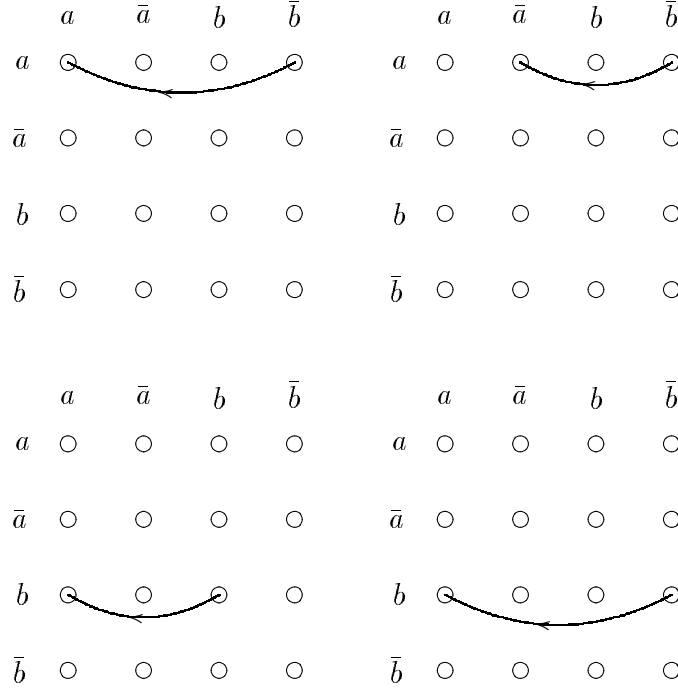

Fig. 5

8 Three simple algebras

8.1 Proof for $N = 3$

So far, we found that all irreducible, dynamically non-degenerate triples were associated to diagrams with letter changing arrows only, i.e. arrows connecting two different algebras. These arrows are stable under contraction of the multiplicity matrix. Therefore we start by constructing all irreducible, contracted diagrams, Figure 6. In other words we neglect the complex conjugate representations.

This list becomes exhaustive upon permutations of the three algebras $\mathcal{A}_1 = M_n(\mathbb{K}) \ni a$, $\mathcal{A}_2 = M_m(\mathbb{K}) \ni b$, $\mathcal{A}_3 = M_q(\mathbb{K}) \ni c$, upon permuting left and right, i.e. changing the directions of all two or three arrows simultaneously, and upon permutations of particles and antiparticles independently in every connected component of the diagram.

Let k, ℓ, p be the sizes of the matrices a, b, c .

Diagram 1 yields:

$$\rho_L(a, b, c) = \begin{pmatrix} a \otimes 1_k & 0 \\ 0 & b \otimes 1_\ell \end{pmatrix}, \quad \rho_R(a, b, c) = \begin{pmatrix} b \otimes 1_k & 0 \\ 0 & c \otimes 1_\ell \end{pmatrix},$$

$$\rho_L^c(a, b, c) = \begin{pmatrix} 1_k \otimes a & 0 \\ 0 & 1_\ell \otimes b \end{pmatrix}, \quad \rho_R^c(a, b, c) = \begin{pmatrix} 1_\ell \otimes a & 0 \\ 0 & 1_p \otimes b \end{pmatrix},$$

and

$$\mathcal{M} = \begin{pmatrix} M_1 \otimes 1_k & 0 \\ 0 & M_2 \otimes 1_\ell \end{pmatrix}, \quad M_1 \in M_{k \times \ell}(\mathbb{C}), \quad M_2 \in M_{\ell \times p}(\mathbb{C}).$$

The fluctuations,

$$\begin{aligned} \hat{f}M_1 &= \sum_j r_j u_j M_1 v_j^{-1}, \quad u_j \in U(\mathcal{A}_1), \quad v_j \in U(\mathcal{A}_2), \\ \hat{f}M_2 &= \sum_j r_j v_j M_2 w_j^{-1}, \quad w_j \in U(\mathcal{A}_3), \end{aligned}$$

produce two *decoupled* fields $\hat{f}M_1$ and $\hat{f}M_2$ as can be seen by applying the fluctuation: $r_1 = \frac{1}{2}$, $u_1 = 1_k$, $v_1 = 1_\ell$, $w_1 = 1_p$, $r_2 = \frac{1}{2}$, $u_2 = 1_k$, $v_2 = 1_\ell$, $w_2 = -1_p$.

Since the arrows M_1 and M_2 are disconnected, the action is a sum of an action in $\hat{f}M_1$ and of an action in $\hat{f}M_2$. Proceeding as in the preceding section we find that a minimum $\hat{f}M_1$ has $\min\{k, \ell\}$ eigenvalues $\mu(4\lambda)^{-\frac{1}{2}}$ and $|k - \ell|$ eigenvalues zero and $\hat{f}M_2$ has $\min\{\ell, p\}$ eigenvalues $\mu(4\lambda)^{-\frac{1}{2}}$ and $|\ell - p|$ eigenvalues zero. All triples associated to the first diagram are therefore dynamically degenerate.

For the same reason, we can discard **diagrams 2, 3, 4, 6**, because they also have two disconnected horizontal arrows not vertically aligned.

Diagram 5 yields:

$$\begin{aligned} \rho_L(a, b, c) &= \begin{pmatrix} a \otimes 1_k & 0 \\ 0 & b \otimes 1_p \end{pmatrix}, \quad \rho_R(a, b, c) = b \otimes 1_k, \\ \rho_L^c(a, b, c) &= \begin{pmatrix} 1_k \otimes a & 0 \\ 0 & 1_\ell \otimes c \end{pmatrix}, \quad \rho_R^c(a, b, c) = 1_\ell \otimes a, \\ \mathcal{M} &= \begin{pmatrix} M_1 \otimes 1_k \\ 1_\ell \otimes M_2 \end{pmatrix}, \quad M_1 \in M_{k \times \ell}(\mathbb{C}), \quad M_2 \in M_{p \times k}(\mathbb{C}). \end{aligned}$$

Again the fluctuations,

$$\begin{aligned} \hat{f}M_1 &= \sum_j r_j u_j M_1 v_j^{-1}, \quad u_j \in U(\mathcal{A}_1), \quad v_j \in U(\mathcal{A}_2), \\ \hat{f}M_2 &= \sum_j r_j w_j M_2 u_j^{-1}, \quad w_j \in U(\mathcal{A}_3), \end{aligned}$$

produce two decoupled fields $\hat{f}M_1$ and $\hat{f}M_2$ but now the arrows are connected and consequently, the action does not decouple,

$$V(C_1, C_2) = 4k [\lambda \operatorname{tr}(C_1^2) - \frac{1}{2}\mu^2 \operatorname{tr}(C_1)] + 4\ell [\lambda \operatorname{tr}(C_2^2) - \frac{1}{2}\mu^2 \operatorname{tr}(C_2)] + 8\lambda \operatorname{tr}(C_1) \operatorname{tr}(C_2),$$

where $C_i := {}^fM_i^* {}^fM_i$. Let x_1, x_2, \dots, x_ℓ be the eigenvalues of C_1 and y_1, y_2, \dots, y_k be the eigenvalues of C_2 . The action only depends on these variables and in its minimum all x_i are equal or vanish and all y_i are equal or vanish. The spectrum of the minimal Dirac operator ${}^f\mathcal{D}$ contains at most three non-vanishing numbers: $\sqrt{x}, \sqrt{y}, \sqrt{x+y}$ implying that k and ℓ are less than or equal to two. The fermionic mass matrix \mathcal{M} is of size $(k^2 + \ell p) \times (k\ell)$. To get at most one zero eigenvalue we must require $|k^2 + \ell p - k\ell| \leq 1$ implying $k = p = 1$. For $\ell = 1$ the minimum is at $|{}^fM_1|^2 + |{}^fM_2|^2 = \frac{\mu^2}{4\lambda}$, for $\ell = 2$ the minimum is at ${}^fM_1 = 0, |{}^fM_2|^2 = \frac{\mu^2}{4\lambda}$. In both cases, ${}^fM_1 = 0$, the triple is degenerate in the sense that the Dirac operator has an invariant subspace in the kernel.

Diagram 7 falls in the same way.

Diagram 8 yields the representations

$$\rho_L(a, b, c) = \begin{pmatrix} a \otimes 1_k & 0 & 0 \\ 0 & c \otimes 1_k & 0 \\ 0 & 0 & b \otimes 1_p \end{pmatrix}, \quad \rho_R(a, b, c) = \begin{pmatrix} b \otimes 1_k & 0 \\ 0 & c \otimes 1_p \end{pmatrix},$$

$$\rho_L^c(a, b, c) = \begin{pmatrix} 1_k \otimes a & 0 & 0 \\ 0 & 1_p \otimes a & 0 \\ 0 & 0 & 1_\ell \otimes c \end{pmatrix}, \quad \rho_R^c(a, b, c) = \begin{pmatrix} 1_\ell \otimes a & 0 \\ 0 & 1_p \otimes c \end{pmatrix}.$$

The possible complex conjugations in the representation will not be important in this diagram. The mass matrix is

$$\mathcal{M} = \begin{pmatrix} M_1 \otimes 1_k & 0 \\ M_2 \otimes 1_k & 0 \\ 0 & M_3^* \otimes 1_p \end{pmatrix}, \quad M_1 \in M_{k \times \ell}(\mathbb{C}), \quad M_2, M_3 \in M_{p \times \ell}(\mathbb{C}).$$

The fluctuations are

$${}^fM_1 = \sum_j r_j u_j M_1 v_j^{-1}, \quad u_j \in U(\mathcal{A}_1), \quad v_j \in U(\mathcal{A}_2),$$

$${}^fM_2 = \sum_j r_j w_j M_2 v_j^{-1}, \quad w_j \in U(\mathcal{A}_3),$$

$${}^fM_3 = \sum_j r_j w_j M_3 v_j^{-1},$$

and the action is, with $C_i := {}^fM_i^* {}^fM_i$

$$V(C_1, C_2, C_3) = 4k [\lambda \operatorname{tr}(C_1 + C_2)^2 - \frac{1}{2} \mu^2 \operatorname{tr}(C_1 + C_2)] + 4p [\lambda \operatorname{tr}(C_3)^2 - \frac{1}{2} \mu^2 \operatorname{tr}(C_3)].$$

Requiring at most one zero eigenvalue (up to a possible colour degeneracy) implies $k = 1, \ell = p+1$ or $k = 1, \ell = p$. In both cases fM_1 and fM_2 vary independently. The colour group consists of the u s and w s. As they are spontaneously broken we must have $k = p = 1$, leaving $\ell = 1$ and $\ell = 2$. In the commutative case with no complex conjugations in the

representation, ${}^fM_3 = \beta {}^fM_2$ for a complex constant $\beta \neq 0$. If $|\beta| \geq 1$ the minimum is given by

$$|{}^fM_1|^2 = \frac{(1 - |\beta|^{-2})\mu^2}{4\lambda}, \quad |{}^fM_2|^2 = \frac{|\beta|^{-2}\mu^2}{4\lambda}, \quad \text{and} \quad |{}^fM_3|^2 = \frac{\mu^2}{4\lambda}.$$

Its mass spectrum $\{0, \frac{\mu}{\sqrt{4\lambda}}, \frac{\mu}{\sqrt{4\lambda}}\}$ is dynamically degenerate. If $|\beta| \leq 1$ the minimum is given by

$$|{}^fM_1|^2 = 0, \quad |{}^fM_2|^2 = \frac{1 + |\beta|^2}{1 + |\beta|^4} \frac{\mu^2}{4\lambda}, \quad \text{and} \quad |{}^fM_3|^2 = \frac{|\beta|^2(1 + |\beta|^2)}{1 + |\beta|^4} \frac{\mu^2}{4\lambda}.$$

The triple is degenerate because of the invariant subspace in the kernel of the Dirac operator. With additional complex conjugations in the representation, fM_3 may decouple from fM_2 and the triple becomes dynamically degenerate as in diagram 1.

In the noncommutative case $k = 1, \ell = 2, p = 1$, M_1 and M_2 must be linearly independent. To get a nondegenerate triple for any choice of \mathcal{A}_1 and $\mathcal{A}_3 = \mathbb{R}$ or \mathbb{C} and $\mathcal{A}_2 = M_2(\mathbb{R}), M_2(\mathbb{C})$ or \mathbb{H} it is sufficient to take the example: $M_1 = (m_1, 0)$, $M_2 = (0, m_2)$, $M_3 = \beta M_2$. The minimum is given by ${}^fM_1 {}^fM_2^* = 0$ and

$$|{}^fM_1|^2 = \frac{\mu^2}{4\lambda}, \quad |{}^fM_2|^2 = \frac{1 + |\beta|^2}{1 + |\beta|^4} \frac{\mu^2}{4\lambda}, \quad |{}^fM_3|^2 = |\beta|^2 \frac{1 + |\beta|^2}{1 + |\beta|^4} \frac{\mu^2}{4\lambda},$$

dynamically non-degenerate for $\beta \neq 0$ and $|\beta| \neq 1$.

Let us note a new phenomenon: the three eigenvalues of a minimum ${}^f\mathcal{D}$ are tied together by a *mass relation*. Its origin is clear, when we add more and more irreducible components to the Hilbert space the number of possible fluctuations does not change, the number of components in the Dirac operator increases. This phenomenon does not only occur for the particular choice of the mass matrices M_1, M_2, M_3 above, but is generic for diagram 8. The little groups are same as the last six in (7.7).

Diagram 9 yields the representations

$$\rho_L(a, b, c) = \begin{pmatrix} a \otimes 1_k & 0 & 0 \\ 0 & a \otimes 1_p & 0 \\ 0 & 0 & b \otimes 1_p \end{pmatrix}, \quad \rho_R(a, b, c) = \begin{pmatrix} b \otimes 1_k & 0 & 0 \\ 0 & a \otimes 1_\ell & 0 \\ 0 & 0 & c \otimes 1_p \end{pmatrix},$$

$$\rho_L^c(a, b, c) = \begin{pmatrix} 1_k \otimes a & 0 & 0 \\ 0 & 1_k \otimes c & 0 \\ 0 & 0 & 1_\ell \otimes c \end{pmatrix}, \quad \rho_R^c(a, b, c) = \begin{pmatrix} 1_\ell \otimes a & 0 & 0 \\ 0 & 1_k \otimes b & 0 \\ 0 & 0 & 1_p \otimes c \end{pmatrix},$$

with possible complex conjugations. The mass matrix is

$$\mathcal{M} = \begin{pmatrix} M_1 \otimes 1_k & 0 & 0 \\ 0 & 1_k \otimes M_2^* & 0 \\ 0 & 0 & M_3 \otimes 1_p \end{pmatrix}, \quad M_1 \in M_{k \times \ell}(\mathbb{C}), \quad M_2, M_3 \in M_{\ell \times p}(\mathbb{C}).$$

The fluctuations are

$${}^fM_1 = \sum_j r_j u_j M_1 v_j^{-1}, \quad u_j \in U(\mathcal{A}_1), \quad v_j \in U(\mathcal{A}_2),$$

$$\begin{aligned}
{}^f M_2 &= \sum_j r_j v_j M_2 w_j^{-1}, \quad w_j \in U(\mathcal{A}_3), \\
{}^f M_3 &= \sum_j r_j v_j M_3 w_j^{-1},
\end{aligned}$$

and the action $V(C_1, C_2, C_3)$ is equal to

$$4k [\lambda \operatorname{tr}(C_1)^2 - \frac{1}{2} \mu^2 \operatorname{tr}(C_1)] + 4k [\lambda \operatorname{tr}(C_2)^2 - \frac{1}{2} \mu^2 \operatorname{tr}(C_2)] + 4p [\lambda \operatorname{tr}(C_3)^2 - \frac{1}{2} \mu^2 \operatorname{tr}(C_3)].$$

Counting neutrinos and imposing broken colour to be commutative leaves only one case, $k = \ell = p = 1$. We choose $M_3 = \beta M_2$ and get the minima at

$$|\hat{f}M_1|^2 = \frac{\mu^2}{4\lambda}, \quad |\hat{f}M_2|^2 = \frac{1 + |\beta|^2}{1 + |\beta|^4} \frac{\mu^2}{4\lambda}, \quad |\hat{f}M_3|^2 = |\beta|^2 \frac{1 + |\beta|^2}{1 + |\beta|^4} \frac{\mu^2}{4\lambda},$$

so it is dynamically non-degenerate for $\beta \neq 0$ and $|\beta| \neq 1$.

Diagram 10 yields the representations

$$\begin{aligned}
\rho_L(a, b, c) &= \begin{pmatrix} a \otimes 1_k & 0 & 0 \\ 0 & a \otimes 1_k & 0 \\ 0 & 0 & b \otimes 1_p \end{pmatrix}, & \rho_R(a, b, c) &= \begin{pmatrix} b \otimes 1_k & 0 \\ 0 & c \otimes 1_p \end{pmatrix}, \\
\rho_L^c(a, b, c) &= \begin{pmatrix} 1_k \otimes a & 0 & 0 \\ 0 & 1_k \otimes a & 0 \\ 0 & 0 & 1_\ell \otimes c \end{pmatrix}, & \rho_R^c(a, b, c) &= \begin{pmatrix} 1_\ell \otimes a & 0 \\ 0 & 1_p \otimes c \end{pmatrix},
\end{aligned}$$

with possible complex conjugations. The mass matrix is

$$\mathcal{M} = \begin{pmatrix} M_1 \otimes 1_k & 0 \\ M_2 \otimes 1_k & 0 \\ 0 & M_3 \otimes 1_p \end{pmatrix}, \quad M_1, M_2 \in M_{k \times \ell}(\mathbb{C}), \quad M_3 \in M_{\ell \times p}(\mathbb{C}).$$

The fluctuations are

$$\begin{aligned}
{}^f M_1 &= \sum_j r_j u_j M_1 v_j^{-1}, \quad u_j \in U(\mathcal{A}_1), \quad v_j \in U(\mathcal{A}_2), \\
{}^f M_2 &= \sum_j r_j u_j M_2 v_j^{-1}, \\
{}^f M_3 &= \sum_j r_j v_j M_3 w_j^{-1}, \quad w_j \in U(\mathcal{A}_3),
\end{aligned}$$

and the action is

$$V(C_1, C_2, C_3) = 4k [\lambda \operatorname{tr}(C_1 + C_2)^2 - \frac{1}{2} \mu^2 \operatorname{tr}(C_1 + C_2)] + 4p [\lambda \operatorname{tr}(C_3)^2 - \frac{1}{2} \mu^2 \operatorname{tr}(C_3)].$$

Neutrino counting implies $k = 1, \ell = 2, p = 1$ or $k = \ell = p = 1$. In both cases ${}^f M_3$ varies independently of ${}^f M_1$ and ${}^f M_2$.

The commutative case has always $|\hat{f}M_1|^2 + |\hat{f}M_2|^2 = |\hat{f}M_3|^2 = \mu^2(4\lambda)^{-1}$ and is dynamically degenerate.

In the noncommutative case $k = 1, \ell = 2, p = 1$, M_1 and M_2 must be linearly independent. For $\mathcal{A}_1 \oplus \mathcal{A}_2 = \mathbb{R} \oplus M_2(\mathbb{C})$, $\mathbb{C} \oplus M_2(\mathbb{R})$ and $\mathbb{C} \oplus M_2(\mathbb{C})$, lemma A.1 decouples fM_1 and fM_2 and the triples are dynamically degenerate, ${}^fM_1 = (\mu(4\lambda)^{-1/2}, 0)$, ${}^fM_2 = (0, \mu(4\lambda)^{-1/2})$, ${}^fM_3 = (0, \mu(4\lambda)^{-1/2})^T$. For $\mathcal{A}_1 \oplus \mathcal{A}_2 = \mathbb{R} \oplus \mathbb{H}$ and $\mathbb{C} \oplus \mathbb{H}$ we choose

$$\rho_L(a, b, c) = \begin{pmatrix} a \otimes 1_k & 0 & 0 \\ 0 & \bar{a} \otimes 1_k & 0 \\ 0 & 0 & b \otimes 1_p \end{pmatrix}, \quad M_1 = (m_1, 0), \quad M_2 = (0, \alpha m_1).$$

Its minimum has the non-degenerate spectrum $\{\frac{1+|\alpha|^2}{1+|\alpha|^4}, \frac{|\alpha|^2(1+|\alpha|^2)}{1+|\alpha|^4}, 1, 0\}$ in units of $\frac{\mu^2}{4\lambda}$ with one mass relation. Finally for $\mathcal{A}_1 \oplus \mathcal{A}_2 = \mathbb{R} \oplus M_2(\mathbb{R})$ we choose $M_1 = (i, 1)$ and $M_2 = (1, 0)$ to obtain the non-degenerate spectrum $\{\frac{2 \pm \sqrt{2}}{3}, 1, 0\}$ in units of $\frac{\mu^2}{4\lambda}$.

Diagram 11 yields the representations

$$\rho_L(a, b, c) = \begin{pmatrix} a \otimes 1_k & 0 \\ 0 & b \otimes 1_p \end{pmatrix}, \quad \rho_R(a, b, c) = \begin{pmatrix} b \otimes 1_k & 0 & 0 \\ 0 & b \otimes 1_k & 0 \\ 0 & 0 & c \otimes 1_p \end{pmatrix},$$

$$\rho_L^c(a, b, c) = \begin{pmatrix} 1_k \otimes a & 0 \\ 0 & 1_\ell \otimes c \end{pmatrix}, \quad \rho_R^c(a, b, c) = \begin{pmatrix} 1_\ell \otimes a & 0 & 0 \\ 0 & 1_\ell \otimes a & 0 \\ 0 & 0 & 1_p \otimes c \end{pmatrix},$$

with possible complex conjugations. The mass matrix is

$$\mathcal{M} = \begin{pmatrix} M_1 \otimes 1_k & M_2 \otimes 1_k & 0 \\ 0 & 0 & M_3 \otimes 1_p \end{pmatrix}, \quad M_1, M_2 \in M_{k \times \ell}(\mathbb{C}), \quad M_3 \in M_{\ell \times p}(\mathbb{C}).$$

The fluctuations are

$$\begin{aligned} {}^fM_1 &= \sum_j r_j u_j M_1 v_j^{-1}, \quad u_j \in U(\mathcal{A}_1), \quad v_j \in U(\mathcal{A}_2), \\ {}^fM_2 &= \sum_j r_j u_j M_2 v_j^{-1}, \\ {}^fM_3 &= \sum_j r_j v_j M_3 w_j^{-1}, \quad w_j \in U(\mathcal{A}_3), \end{aligned}$$

and the action is

$$V(C_1, C_2, C_3) = 4k [\lambda \operatorname{tr}(C_1 + C_2)^2 - \frac{1}{2}\mu^2 \operatorname{tr}(C_1 + C_2)] + 4p [\lambda \operatorname{tr}(C_3)^2 - \frac{1}{2}\mu^2 \operatorname{tr}(C_3)].$$

Neutrino counting and imposing broken colour to be commutative leaves only one possibility: $k = \ell = p = 1$, which is treated as the case $k = \ell = p = 1$ of diagram 10 with the same conclusion, degeneracy.

Diagram 12 yields the representations

$$\rho_L(a, b, c) = \begin{pmatrix} a \otimes 1_k & 0 & \\ 0 & b \otimes 1_p & \end{pmatrix}, \quad \rho_R(a, b, c) = \begin{pmatrix} b \otimes 1_k & 0 & 0 \\ 0 & a \otimes 1_\ell & 0 \\ 0 & 0 & c \otimes 1_p \end{pmatrix},$$

$$\rho_L^c(a, b, c) = \begin{pmatrix} 1_k \otimes a & 0 & \\ 0 & 1_\ell \otimes c & \end{pmatrix}, \quad \rho_R^c(a, b, c) = \begin{pmatrix} 1_\ell \otimes a & 0 & 0 \\ 0 & 1_k \otimes b & 0 \\ 0 & 0 & 1_\ell \otimes c \end{pmatrix},$$

with possible complex conjugations. The mass matrix is

$$\mathcal{M} = \begin{pmatrix} M_1 \otimes 1_k & 1_k \otimes M_2 & 0 \\ 0 & 0 & M_3 \otimes 1_p \end{pmatrix}, \quad M_1, M_2 \in M_{k \times \ell}(\mathbb{C}), \quad M_3 \in M_{\ell \times p}(\mathbb{C}).$$

The fluctuations are

$${}^f M_1 = \sum_j r_j u_j M_1 v_j^{-1}, \quad u_j \in U(\mathcal{A}_1), \quad v_j \in U(\mathcal{A}_2),$$

$${}^f M_2 = \sum_j r_j u_j M_2 v_j^{-1},$$

$${}^f M_3 = \sum_j r_j v_j M_3 w_j^{-1}, \quad w_j \in U(\mathcal{A}_3).$$

The action $V(C_1, C_2, C_3)$ equals

$$4k [\lambda \operatorname{tr}(C_1)^2 - \frac{1}{2} \mu^2 \operatorname{tr}(C_1)] + 4k [\lambda \operatorname{tr}(C_2)^2 - \frac{1}{2} \mu^2 \operatorname{tr}(C_2)] \\ + 8\lambda \operatorname{tr}(C_1) \operatorname{tr}(C_2) + 4p [\lambda \operatorname{tr}(C_3)^2 - \frac{1}{2} \mu^2 \operatorname{tr}(C_3)].$$

Since ${}^f M_3$ decouples, ℓ and p can at most differ by one. The neutrino count and imposing broken colour to be commutative implies $k = \ell = p = 1$. Then $M_2 = \alpha M_1$ and we must distinguish two cases: ${}^f M_2 = \alpha {}^f M_1$ or ${}^f M_1$ and ${}^f M_2$ independent. Both possibilities have a dynamically degenerate minimum: $|{}^f M_1|^2 + |{}^f M_2|^2 = |{}^f M_3|^2 = \frac{\mu^2}{4\lambda}$.

Diagram 13 has a *ladder form*, i.e. it consists of horizontal arrows, vertically aligned. Its representations are

$$\rho_L(a, b, c) = \begin{pmatrix} a \otimes 1_k & 0 & 0 \\ 0 & a \otimes 1_k & 0 \\ 0 & 0 & a \otimes 1_p \end{pmatrix}, \quad \rho_R(a, b, c) = \begin{pmatrix} b \otimes 1_k & 0 \\ 0 & b \otimes 1_p \end{pmatrix},$$

$$\rho_L^c(a, b, c) = \begin{pmatrix} 1_k \otimes a & 0 & 0 \\ 0 & 1_k \otimes a & 0 \\ 0 & 0 & 1_k \otimes c \end{pmatrix}, \quad \rho_R^c(a, b, c) = \begin{pmatrix} 1_\ell \otimes a & 0 \\ 0 & 1_\ell \otimes c \end{pmatrix},$$

with possible complex conjugations here and there. The mass matrix is

$$\mathcal{M} = \begin{pmatrix} M_1 \otimes 1_k & 0 \\ M_2 \otimes 1_k & 0 \\ 0 & M_3 \otimes 1_p \end{pmatrix}, \quad M_1, M_2, M_3 \in M_{k \times \ell}(\mathbb{C}).$$

The fluctuations are

$$\begin{aligned} {}^fM_1 &= \sum_j r_j u_j M_1 v_j^{-1}, \quad u_j \in U(\mathcal{A}_1), \quad v_j \in U(\mathcal{A}_2), \\ {}^fM_2 &= \sum_j r_j u_j M_2 v_j^{-1}, \\ {}^fM_3 &= \sum_j r_j u_j M_3 v_j^{-1}, \end{aligned}$$

and the action is

$$V(C_1, C_2, C_3) = 4k [\lambda \operatorname{tr}(C_1 + C_2)^2 - \frac{1}{2}\mu^2 \operatorname{tr}(C_1 + C_2)] + 4p [\lambda \operatorname{tr}(C_3)^2 - \frac{1}{2}\mu^2 \operatorname{tr}(C_3)].$$

The neutrino count implies $k = 1$, $\ell = 2$ or $k = \ell = 1$.

The case $k = \ell = 1$ has the following possibilities:

1: $\mathbb{R} \oplus \mathbb{R} \oplus \mathcal{C}$, where \mathcal{C} is any simple ‘colour’ algebra. All possible triples are degenerate in the sense that the Dirac operator has an invariant subspace in its kernel.

2: $\mathbb{R} \oplus \mathbb{C} \oplus \mathcal{C}$, all possible triples are degenerate.

3: $\mathbb{C} \oplus \mathbb{R} \oplus \mathcal{C} \ni (a, b, c)$. The non-degenerate triples have:

$$\rho_L(a, b, c) = \begin{pmatrix} a & 0 & 0 \\ 0 & \bar{a} & 0 \\ 0 & 0 & \bar{a} \otimes 1_p \end{pmatrix}, \quad \rho_R(a, b, c) = \begin{pmatrix} b & 0 \\ 0 & b \otimes 1_p \end{pmatrix}.$$

The fluctuations respect the mass ratios: $|M_1| : |M_2| : |M_3| = |{}^fM_1| : |{}^fM_2| : |{}^fM_3|$. If M_1 and M_2 are different from zero, the kernel of the Dirac operator, $\mathbb{C}(-\overline{M_2}, \overline{M_1}, 0, 0, 0; -M_2, M_1, 0, 0, 0)^T$, is not invariant under $a \in \mathbb{C}$. If $|M_3|^2 \neq |M_1|^2 + |M_2|^2$, the triple is dynamically non-degenerate.

4: $\mathbb{C} \oplus \mathbb{C} \oplus \mathcal{C} \ni (a, b, c)$. The only not obviously degenerate triples have the representations:

$$\rho_L(a, b, c) = \begin{pmatrix} a & 0 & 0 \\ 0 & \bar{a} & 0 \\ 0 & 0 & \bar{a} \otimes 1_p \end{pmatrix}, \quad \rho_R(a, b, c) = \begin{pmatrix} b & 0 \\ 0 & b \otimes 1_p \end{pmatrix}, \quad (8.1)$$

and

$$\rho_L(a, b, c) = \begin{pmatrix} a & 0 & 0 \\ 0 & \bar{a} & 0 \\ 0 & 0 & \bar{a} \otimes 1_p \end{pmatrix}, \quad \rho_R(a, b, c) = \begin{pmatrix} b & 0 \\ 0 & \bar{b} \otimes 1_p \end{pmatrix}. \quad (8.2)$$

The fluctuations do not respect all mass ratios, in fact fM_1 and fM_2 are independent variables and only the ratio $M_2/M_3 = {}^fM_2/{}^fM_3 =: 1/\beta$ is invariant under fluctuations via (8.1). If $|\beta| \geq 1$ the minima are given by

$$|{}^fM_1|^2 = \frac{(1 - |\beta|^{-2})\mu^2}{4\lambda}, \quad |{}^fM_2|^2 = \frac{\mu^2}{|\beta|^2 4\lambda}, \quad \text{and} \quad |{}^fM_3|^2 = \frac{\mu^2}{4\lambda}.$$

Its mass spectrum $\{0, \frac{\mu}{2\sqrt{\lambda}}, \frac{\mu}{2\sqrt{\lambda}} p \text{ times}\}$ is dynamically degenerate. If $|\beta| \leq 1$ the minima are given by

$$|\hat{f}M_1|^2 = 0, \quad |\hat{f}M_2|^2 = \frac{1 + p|\beta|^2}{1 + p|\beta|^4} \frac{\mu^2}{4\lambda}, \quad \text{and} \quad |\hat{f}M_3|^2 = \frac{|\beta|^2(1 + p|\beta|^2)}{1 + p|\beta|^4} \frac{\mu^2}{4\lambda}.$$

The triple is degenerate since there is an invariant subspace in the kernel of the Dirac operator. For the representation (8.2) the computations are identical to the case above, (8.1), after permuting M_1 and M_2 and after replacing M_3 by $\overline{M_3}$.

In the case $k = 1, \ell = 2$, the three submatrices M_1, M_2, M_3 are linearly dependent over \mathbb{C} . If M_1 is proportional to M_2 then both M_3 and $\begin{pmatrix} M_1 \\ M_2 \end{pmatrix}$ have a zero eigenvalue. Therefore M_1 and M_2 are linearly independent over \mathbb{C} and $M_3 =: \alpha M_1 + \beta M_2$ with complex coefficients α and β .

5: $\mathbb{C} \oplus M_2(\mathbb{C}) \oplus \mathcal{C} \ni (a, b, c)$. By lemma A.1, fM_1 and fM_2 vary independently in \mathbb{C}^2 . For the representations with

$$\rho_L(a, b, c) = \begin{pmatrix} a & 0 & 0 \\ 0 & a & 0 \\ 0 & 0 & a \otimes 1_p \end{pmatrix}, \quad \rho_R(a, b, c) = \begin{pmatrix} b & 0 \\ 0 & b \otimes 1_p \end{pmatrix}, \quad (8.3)$$

we get ${}^fM_3 =: \alpha {}^fM_1 + \beta {}^fM_2$. For instance for $\alpha = 0$ we get $\hat{f}M_1 \hat{f}M_2^* = 0$ as for diagram 8 and a similar mass relation,

$$|\hat{f}M_1|^2 = \frac{\mu^2}{4\lambda}, \quad |\hat{f}M_2|^2 = \frac{1 + p|\beta|^2}{1 + p|\beta|^4} \frac{\mu^2}{4\lambda}, \quad |\hat{f}M_3|^2 = |\beta|^2 \frac{1 + p|\beta|^2}{1 + p|\beta|^4} \frac{\mu^2}{4\lambda}. \quad (8.4)$$

For general α , we get the same relations with $|\beta|^2$ replaced by $|\alpha|^2 + |\beta|^2$. For the representations with

$$\rho_L(a, b, c) = \begin{pmatrix} a & 0 & 0 \\ 0 & \bar{a} & 0 \\ 0 & 0 & \bar{a} \otimes 1_p \end{pmatrix}, \quad \rho_R(a, b, c) = \begin{pmatrix} b & 0 \\ 0 & b \otimes 1_p \end{pmatrix},$$

and $\alpha \neq 0$, all three doublets, ${}^fM_1, {}^fM_2$ and fM_3 vary independently. The minima, $|\hat{f}M_1|^2 = |\hat{f}M_2|^2 = |\hat{f}M_3|^2 = \frac{\mu^2}{4\lambda}$ produce a dynamical degeneracy in this case. The other case, $\alpha = 0$ is dynamically non-degenerate with the same mass relation as above, equations (8.4). All other representations of this algebra are treated the same way and they either have a mass relation or are dynamically degenerate, which means a particularly simple mass relation.

6: $\mathbb{R} \oplus M_2(\mathbb{C}) \oplus \mathcal{C}$. This case is identical to case **5** with representation (8.3).

7: $\mathbb{C} \oplus \mathbb{H} \oplus \mathcal{C} \ni (a, b, c)$. For example, all triples with

$$\rho_L(a, b, c) = \begin{pmatrix} a & 0 & 0 \\ 0 & \bar{a} & 0 \\ 0 & 0 & \bar{a} \otimes 1_p \end{pmatrix}, \quad \rho_R(a, b, c) = \begin{pmatrix} b & 0 \\ 0 & b \otimes 1_p \end{pmatrix},$$

$M_1 = (m_1, 0)$, $M_2 = (0, m_2)$ and $M_3 = (0, m_3)$ have no mass relation. Indeed like in case **3**, the mass ratios are stable under fluctuations: $|M_1| : |M_2| : |M_3| = |{}^f M_1| : |{}^f M_2| : |{}^f M_3|$. Other triples behave like in case **5**.

8: $\mathbb{R} \oplus \mathbb{H} \oplus \mathcal{C}$ has the same examples without mass relations as in case **7**.

9: $\mathbb{C} \oplus M_2(\mathbb{R}) \oplus \mathcal{C}$. For representations (8.3) and $\alpha = 0$, we get minima with mass relation (8.4).

10: $\mathbb{R} \oplus M_2(\mathbb{R}) \oplus \mathcal{C}$. Here we take a representation (8.3) with $M_1 = (m_1, 0)$, $M_2 = (0, m_2)$ and $M_3 = (0, \beta m_2)$ and get again the mass relation (8.4).

Up to different multiplicities, we have the same conclusion for the **diagrams 18, 17, 22**. After permuting \mathcal{A}_1 and \mathcal{A}_2 we also have the same results for the other four ladders, **diagrams 14, 19, 16, 21**.

Diagram 15 yields the representations

$$\rho_L(a, b, c) = \begin{pmatrix} a \otimes 1_k & 0 & \\ 0 & a \otimes 1_p & \end{pmatrix}, \quad \rho_R(a, b, c) = \begin{pmatrix} b \otimes 1_k & 0 & 0 \\ 0 & a \otimes 1_\ell & 0 \\ 0 & 0 & b \otimes 1_p \end{pmatrix},$$

$$\rho_L^c(a, b, c) = \begin{pmatrix} 1_k \otimes a & 0 & \\ 0 & 1_k \otimes c & \end{pmatrix}, \quad \rho_R^c(a, b, c) = \begin{pmatrix} 1_\ell \otimes a & 0 & 0 \\ 0 & 1_k \otimes b & 0 \\ 0 & 0 & 1_\ell \otimes c \end{pmatrix},$$

with possible complex conjugations. The mass matrix is

$$\mathcal{M} = \begin{pmatrix} M_1 \otimes 1_k & 1_k \otimes M_2 & 0 \\ 0 & 0 & M_3 \otimes 1_p \end{pmatrix}, \quad M_1, M_2, M_3 \in M_{k \times \ell}(\mathbb{C}).$$

The fluctuations are

$${}^f M_1 = \sum_j r_j u_j M_1 v_j^{-1}, \quad u_j \in U(\mathcal{A}_1), \quad v_j \in U(\mathcal{A}_2),$$

$${}^f M_2 = \sum_j r_j u_j M_2 v_j^{-1},$$

$${}^f M_3 = \sum_j r_j u_j M_3 v_j^{-1}.$$

Neutrino counting and imposing broken colour to be commutative implies $k = \ell = 1$. This case with \mathcal{A}_1 and $\mathcal{A}_2 = \mathbb{R}$ or \mathbb{C} is treated as in diagram 13, **3** yielding a non-degenerate triple without mass relation. After replacing M_3^* by M_3 , **diagram 20** has identical computations.

Diagram 23 yields the representations

$$\rho_L(a, b, c) = \begin{pmatrix} a \otimes 1_k & 0 & 0 \\ 0 & b \otimes 1_\ell & 0 \\ 0 & 0 & b \otimes 1_p \end{pmatrix}, \quad \rho_R(a, b, c) = \begin{pmatrix} b \otimes 1_k & 0 \\ 0 & a \otimes 1_p \end{pmatrix},$$

$$\rho_L^c(a, b, c) = \begin{pmatrix} 1_k \otimes a & 0 & 0 \\ 0 & 1_\ell \otimes b & 0 \\ 0 & 0 & 1_\ell \otimes c \end{pmatrix}, \quad \rho_R^c(a, b, c) = \begin{pmatrix} 1_p \otimes a & 0 \\ 0 & 1_k \otimes c \end{pmatrix},$$

with possible complex conjugations. The mass matrix is

$$\mathcal{M} = \begin{pmatrix} M_1 \otimes 1_k & 0 \\ 1_\ell \otimes M_2^* & 0 \\ 0 & M_3^* \otimes 1_p \end{pmatrix}, \quad M_1, M_2, M_3 \in M_{k \times \ell}(\mathbb{C}).$$

The fluctuations are

$$\begin{aligned} fM_1 &= \sum_j r_j u_j M_1 v_j^{-1}, \quad u_j \in U(\mathcal{A}_1), \quad v_j \in U(\mathcal{A}_2), \\ fM_2 &= \sum_j r_j u_j M_2 v_j^{-1}, \\ fM_3 &= \sum_j r_j u_j M_3 v_j^{-1}. \end{aligned}$$

Neutrino counting implies $k = \ell = 1$. This model with \mathcal{A}_1 and $\mathcal{A}_2 = \mathbb{R}$ or \mathbb{C} is treated as in diagram 13, **3** yielding a non-degenerate triple without mass relation. After replacing M_3^* by M_3 , **diagram 24** has identical computations.

We must now extend our analysis to include the possibility of complex conjugate representations. As in the case of two algebras, one shows that any diagram containing a connected component consisting of only letter unchanging arrows leads to degenerate spectra. Therefore within the class of irreducible and dynamically non-degenerate triples the leitmotiv of a Krajewski diagram is still carried by its letter changing arrows. For three algebras there are two additional diagrams, **diagrams 25, 26**, figure 7, that involve only letter changing arrows. Their contracted diagrams resemble diagrams 4 and 9 of figure 6 except for the change of chirality in one arrow and the computation of their triples is similar.

Note that without the presence of conjugate representations, this change violates the condition that nonvanishing entries of the multiplicity matrix and its transposed must have same signs. Figure 8 lists the contractions of all irreducible diagrams whose letter unchanging arrows are connected to at least one letter changing arrow. The blow up of the new symbols is given in Figure 9.

All triples attached to the eleven diagrams of Figure 8 are degenerate or dynamically degenerate:

Diagram 27 with the first blow up yields

$$\rho_L(a, b, c) = \begin{pmatrix} c \otimes 1_k & 0 \\ 0 & b \otimes 1_p \end{pmatrix}, \quad \rho_R(a, b, c) = \begin{pmatrix} b \otimes 1_k & 0 & 0 \\ 0 & \bar{c} \otimes 1_k & 0 \\ 0 & 0 & a \otimes 1_p \end{pmatrix},$$

$$\mathcal{M} = \begin{pmatrix} M_1 \otimes 1_k & M_2 \otimes 1_k & 0 \\ 0 & 0 & M_3 \otimes 1_p \end{pmatrix},$$

$M_1 \in M_{p \times \ell}(\mathbb{C})$, $M_2 \in M_{p \times p}(\mathbb{C})$, $M_3 \in M_{\ell \times k}(\mathbb{C})$. Counting neutrinos leads to $k = \ell = 1$. To get a handle on p we repeat the overkill from section 4. In the worst case M_2 and consequently ${}^f M_2$ is skewsymmetric and p is odd. By fluctuations we can obtain

$${}^f M_2 = \begin{pmatrix} \begin{pmatrix} 0 & -1 \\ 1 & 0 \end{pmatrix} & & & \\ & \begin{pmatrix} 0 & -1 \\ 1 & 0 \end{pmatrix} & & \\ & & \ddots & \\ & & & 0 \end{pmatrix} =: \begin{pmatrix} A & 0 \\ 0 & 0 \end{pmatrix}.$$

Now ${}^f M_1$ fluctuates independently and we may obtain for its transpose ${}^f M_1^T = (0, \dots, 0, 1)$. We get $({}^f M_1, {}^f M_2)({}^f M_1, {}^f M_2)^* = 1_p$ and the minimum of the action is dynamically degenerate if $p \geq 1$. The commutative case $k = \ell = p = 1$ is obviously degenerate. For the second blow up the computations are similar with ${}^f M_2$ now proportional to 1_p from the start.

Diagram 28 is treated as diagram 27.

Diagram 29 has $k = \ell = p = 1$ by neutrino count and admits only degenerate triples.

Diagrams 30, 31, 32, 34, 35, 36 have $k = \ell = 1$ by neutrino count. As in the commutative case of diagram 8, all their triples are degenerate.

Diagram 33 with the first of the six possible blow ups yields:

$$\rho_L(a, b, c) = \begin{pmatrix} a \otimes 1_k & 0 & 0 \\ 0 & a \otimes 1_p & 0 \\ 0 & 0 & \bar{b} \otimes 1_p \end{pmatrix},$$

$$\rho_R(a, b, c) = \begin{pmatrix} b \otimes 1_k & 0 & 0 & 0 \\ 0 & b \otimes 1_p & 0 & 0 \\ 0 & 0 & b \otimes 1_p & 0 \\ 0 & 0 & 0 & b \otimes 1_p \end{pmatrix},$$

$$\rho_L^c(a, b, c) = \begin{pmatrix} 1_k \otimes a & 0 & 0 \\ 0 & 1_k \otimes c & 0 \\ 0 & 0 & 1_\ell \otimes c \end{pmatrix},$$

$$\rho_R^c(a, b, c) = \begin{pmatrix} 1_\ell \otimes a & 0 & 0 & 0 \\ 0 & 1_\ell \otimes c & 0 & 0 \\ 0 & 0 & 1_\ell \otimes c & 0 \\ 0 & 0 & 0 & 1_\ell \otimes c \end{pmatrix},$$

$$\mathcal{M} = \begin{pmatrix} M_1 \otimes 1_k & 0 & 0 & 0 \\ 0 & M_2 \otimes 1_p & 0 & 0 \\ 0 & M_3 \otimes 1_p & M_4 \otimes 1_p & M_5 \otimes 1_p \end{pmatrix},$$

$M_1, M_2 \in M_{k \times \ell}(\mathbb{C})$, $M_3, M_4, M_5 \in M_{\ell \times \ell}(\mathbb{C})$. Counting neutrinos and imposing broken colour to be commutative gives $k = \ell = 1$. This case is degenerate: the kernel of the Dirac operator contains the invariant subspace with elements $(0, 0, 0, 0, 0, M_5 v, -M_4 v; 0, 0, 0, 0, 0, \overline{M_5 w}, \overline{-M_4 w})^T$, $v, w \in \mathbb{C}^p$.

With the second blow up diagram 33 yields

$$\begin{aligned} \rho_L(a, b, c) &= \begin{pmatrix} a \otimes 1_k & 0 & 0 \\ 0 & a \otimes 1_p & 0 \\ 0 & 0 & \bar{b} \otimes 1_p \end{pmatrix}, \\ \rho_R(a, b, c) &= \begin{pmatrix} b \otimes 1_k & 0 & 0 & 0 \\ 0 & b \otimes 1_p & 0 & 0 \\ 0 & 0 & b \otimes 1_p & 0 \\ 0 & 0 & 0 & \bar{b} \otimes 1_p \end{pmatrix}, \\ \rho_L^c(a, b, c) &= \begin{pmatrix} 1_k \otimes a & 0 & 0 \\ 0 & 1_k \otimes c & 0 \\ 0 & 0 & 1_\ell \otimes c \end{pmatrix}, \\ \rho_R^c(a, b, c) &= \begin{pmatrix} 1_\ell \otimes a & 0 & 0 & 0 \\ 0 & 1_\ell \otimes c & 0 & 0 \\ 0 & 0 & 1_\ell \otimes c & 0 \\ 0 & 0 & 0 & 1_\ell \otimes \bar{c} \end{pmatrix}, \\ \mathcal{M} &= \begin{pmatrix} M_1 \otimes 1_k & 0 & 0 & 0 \\ 0 & M_2 \otimes 1_p & 0 & 0 \\ 0 & M_3 \otimes 1_p & M_4 \otimes 1_p & 1_k \otimes M_5 \end{pmatrix}, \end{aligned}$$

$M_1, M_2 \in M_{k \times \ell}(\mathbb{C})$, $M_3, M_4 \in M_{\ell \times \ell}(\mathbb{C})$, $M_5 \in M_{p \times p}(\mathbb{C})$. Counting neutrinos and imposing broken colour to be commutative gives $k = \ell = p = 1$. In the notations of Corollary 11.4, the action reads

$$\begin{aligned} V(a, b, c) &= 4\lambda [|M_1 ab|^4 + |M_2 ab|^4 + 2|M_2 ab|^2 |M_3 b^2|^2 + (|M_3 b^2|^2 + |M_4 b^2|^2 + |M_5 c^2|^2)^2] \\ &\quad - 2\mu^2 [|M_1 ab|^2 + |M_2 ab|^2 + (|M_3 b^2|^2 + |M_4 b^2|^2 + |M_5 c^2|^2)]. \end{aligned}$$

Its minimum is degenerate, $\hat{b} = 0$.

The other blow ups as well as **diagram 37** lead to the same conclusion: degeneracy. This completes the proof of the theorem. \square

We summarize the possible algebras with $N = 3$ and the corresponding Krajewski diagrams of all their irreducible, dynamically non-degenerate triplets in a table:

Algebra	Diagrams
$\mathbb{C} \oplus \mathbb{R} \oplus (\mathcal{C} = \mathbf{1})$	14,16,19,21
$\mathbb{C} \oplus \mathbb{R} \oplus \mathcal{C}$	13,17,18,22
$\mathbf{1} \oplus \mathbf{1} \oplus \mathcal{C}$	15,20,23,24
$\mathbf{2} \oplus \mathbf{1} \oplus (\mathcal{C} = \mathbf{1})$	14,16,19,21
$\mathbf{2} \oplus \mathbf{1} \oplus \mathcal{C}$	13,17,18,22
$\mathbb{C} \oplus \mathbb{C} \oplus \mathbf{1}$	26
$\mathbf{1} \oplus \mathbf{1} \oplus \mathbf{1}$	9
$M_2(\mathbb{R}) \oplus \mathbb{R} \oplus \mathbf{1}$	10
$\mathbb{H} \oplus \mathbf{1} \oplus \mathbf{1}$	10
$\mathbf{2} \oplus \mathbf{1} \oplus \mathbf{1}$	8

Note that relaxing the hypothesis of unbroken noncommutative colour does not add any algebra to the list with $N = 1$ and 2. It adds only few algebras to the list with $N = 3$ coming from diagrams 8, 9 and 11. We were unable to treat some of their triples, in particular quaternionic ones.

8.2 The standard model of electro-weak and strong forces

Let us close this section by remarking that diagram 17 of Figure 6 with flipped chirality and with algebra $\mathcal{A} = \mathbb{C} \oplus \mathbb{H} \oplus M_3(\mathbb{C}) \ni (b, a, c)$, with representation

$$\rho_L(a, b) = \begin{pmatrix} a \otimes 1_3 & 0 \\ 0 & a \end{pmatrix}, \quad \rho_R(a, b) = \begin{pmatrix} b1_3 & 0 & 0 \\ 0 & \bar{b}1_3 & 0 \\ 0 & 0 & \bar{b} \end{pmatrix},$$

$$\rho_L^c(a, b) = \begin{pmatrix} 1_2 \otimes c & 0 \\ 0 & \bar{b}1_2 \end{pmatrix}, \quad \rho_R^c(a, b) = \begin{pmatrix} c & 0 & 0 \\ 0 & c & 0 \\ 0 & 0 & \bar{b} \end{pmatrix},$$

and with mass matrix

$$\mathcal{M} = \begin{pmatrix} \begin{pmatrix} m_u \\ 0 \end{pmatrix} \otimes 1_3 & \begin{pmatrix} 0 \\ m_d \end{pmatrix} \otimes 1_3 & 0 \\ 0 & 0 & \begin{pmatrix} 0 \\ m_e \end{pmatrix} \end{pmatrix}$$

produces the standard model of electro-magnetic, weak and strong forces with one generation of quarks and leptons, u , d , ν and e . The neutrino is a massless Weyl spinor. The

intersection form written with respect to the basis of projectors

$$p_1 = (0, 1_2, 0), \quad p_2 = (1, 0, 0), \quad p_3 = \left(0, 0, \begin{pmatrix} 1 & 0 & 0 \\ 0 & 0 & 0 \\ 0 & 0 & 0 \end{pmatrix} \right)$$

is

$$\cap = -2 \begin{pmatrix} 0 & 1 & 1 \\ 1 & -1 & -1 \\ 1 & -1 & 0 \end{pmatrix},$$

and non-degenerate. The colour group $U(3)$ is unbroken and its representations on corresponding left- and right-handed fermions are identical. In physicists' language this means that gluons are massless and couple vectorially. Further details on the standard model as an almost commutative geometry can be found in [13, 2].

9 Beyond irreducible triples

For the standard model, allowing reducible triples has two important physical consequences:

i) Suppose we want to render the neutrino massive. Majorana masses are incompatible with the axiom that the Dirac operator anticommutes with the chirality. Therefore we must increase the Hilbert space by adding a right-handed neutrino. Then the triple becomes reducible, but worse Poincaré duality breaks down: the intersection form becomes

$$\cap = -2 \begin{pmatrix} 0 & 1 & 1 \\ 1 & -2 & -1 \\ 1 & -1 & 0 \end{pmatrix},$$

degenerate.

ii) We may add more generations of quarks and leptons. Then the Cabibbo-Kobayashi-Maskawa matrix makes its appearance. Now we may add right-handed neutrinos in some but not in all generations and give Dirac masses to the corresponding neutrinos without violating Poincaré duality.

So far we have no clue to why the standard model comes with three colours, with three generations of quarks and with three generations of leptons. Note however that anomaly cancellations [1] imply further constraints that are satisfied with three colours and with a number of quark generations equal to the number of lepton generations.

9.1 A reducible triple with non-degenerate spectrum

The criterion of dynamical degeneracy loses its meaning in presence of reducible triples as illustrated by the following example: $\mathcal{A} = M_3(\mathbb{C}) \oplus M_2(\mathbb{C}) \oplus \mathbb{C} \ni (a, b, c)$,

$$\rho(a, b, c) = \begin{pmatrix} a \otimes 1_2 & 0 & 0 & 0 \\ 0 & b \otimes 1_3 & 0 & 0 \\ 0 & 0 & \bar{c} 1_3 \otimes 1_2 & 0 \\ 0 & 0 & 0 & \bar{c} 1_2 \otimes 1_3 \end{pmatrix},$$

$$\mathcal{M} = m \begin{pmatrix} \sqrt{\frac{5}{17}} \begin{pmatrix} 1 & 0 & 0 \\ 0 & 2 & 0 \end{pmatrix} & 0 \\ 0 & \frac{1}{\sqrt{5}} \begin{pmatrix} 1 & 0 & -2 \\ 0 & 2 & 0 \end{pmatrix} \\ \begin{pmatrix} 0 & 0 & 1 \\ 0 & 0 & 0 \end{pmatrix} & \frac{2}{\sqrt{5}} \begin{pmatrix} 0 & 0 & 0 \\ 1 & 0 & 0 \end{pmatrix} \end{pmatrix}.$$

The fluctuations of the Dirac operator generate an 18 dimensional complex vector space in which the spectral action $V(\hat{f}\mathcal{D})$ has to be minimized. We used a steepest descend method of Mathematica for this task and found an absolute minimum at $\hat{f}\mathcal{D} = \mathcal{D}$ with $m = \frac{\mu}{\sqrt{4\lambda}}$ and $V(\hat{f}\mathcal{D}) = -\frac{431\mu^4}{340\lambda}$. The spectrum of this minimum $\hat{f}\mathcal{D}$ is non-degenerate: in units of $\frac{\mu}{\sqrt{4\lambda}}$ we have $\{1, \frac{4}{5}, \frac{5}{17}, \frac{20}{17}, \frac{9\pm\sqrt{17}}{10}\}$. All six values of course appear twice with a positive and twice with a negative sign in the spectrum of $\hat{f}\mathcal{D}$. The little group of this minimum is $G_\ell = U(1) \times U(1) \subset U(3) \times U(2) \times U(1)$ with generic element $(e^{i\alpha}1_3, e^{i\alpha}1_2, e^{i\gamma})$. The spectrum of the minimum appears completely rigid, i.e. there are mass relations.

10 Conclusion

Suppose we want to apply conventional, perturbative quantum field theory to the Yang-Mills-Higgs models coming from almost commutative geometries. Then after renormalization, fermion masses are functions of energy and the colour degeneracy is compatible with this energy dependence only if all noncommutative colour groups are unbroken. Furthermore the renormalization of fermion masses is incompatible with mass relations, in particular with the completely rigid reducible spectral triple of section 9. In irreducible spectral triples, mass relations other than degeneracies only appear starting with $N = 3$. All triples without such mass relations come from ladder diagrams and have algebras $\mathbf{1} \oplus \mathbf{1} \oplus \mathcal{C}$ or $\mathbb{H} \oplus \mathbf{1} \oplus \mathcal{C}$.

Let us suppose that also for $N \geq 4$ the irreducible triples without mass relations have contracted multiplicity matrices of ladder type:

$$\hat{\mu} = \begin{pmatrix} \alpha & \beta & 0 & 0 \\ \gamma & \delta & 0 & 0 \\ \rho & \sigma & 0 & 0 \\ \theta & \xi & 0 & 0 \end{pmatrix}, \quad N = 4.$$

Then $\det(\hat{\mu} + \hat{\mu}^T) = (\rho\xi - \sigma\theta)^2$ and irreducibility implies $\alpha = \beta = \gamma = \delta = 0$. For $N \geq 5$, all contracted multiplicity matrices $\hat{\mu}$ of ladder type have $\det(\hat{\mu} + \hat{\mu}^T) = 0$ leading us to the

Conjecture 10.1. *The sum of N simple algebras, $\mathcal{A} = \mathcal{A}_1 \oplus \mathcal{A}_2 \oplus \dots \oplus \mathcal{A}_N$ admits a finite, real, S^0 -real, irreducible and dynamically non-degenerate spectral triple free of mass relations if and only if it is in the list, up to a reordering of the summands:*

$N = 1$	$N = 2$	$N = 3$	$N = 4$	$N \geq 5$
void	$\mathbb{R} \oplus \mathbb{R}$	$\mathbb{R} \oplus \mathbb{R} \oplus \mathcal{C}$	$\mathbb{R} \oplus \mathbb{R} \oplus \mathcal{C}_1 \oplus \mathcal{C}_2$	void
	$\mathbb{R} \oplus \mathbb{C}$	$\mathbb{R} \oplus \mathbb{C} \oplus \mathcal{C}$	$\mathbb{R} \oplus \mathbb{C} \oplus \mathcal{C}_1 \oplus \mathcal{C}_2$	
	$\mathbb{C} \oplus \mathbb{C}$	$\mathbb{C} \oplus \mathbb{C} \oplus \mathcal{C}$	$\mathbb{C} \oplus \mathbb{C} \oplus \mathcal{C}_1 \oplus \mathcal{C}_2$	
	$M_2(\mathbb{R}) \oplus \mathbb{R}$			
	$M_2(\mathbb{R}) \oplus \mathbb{C}$			
	$M_2(\mathbb{C}) \oplus \mathbb{R}$			
	$M_2(\mathbb{C}) \oplus \mathbb{C}$			
	$\mathbb{H} \oplus \mathbb{R}$	$\mathbb{H} \oplus \mathbb{R} \oplus \mathcal{C}$	$\mathbb{H} \oplus \mathbb{R} \oplus \mathcal{C}_1 \oplus \mathcal{C}_2$	
$\mathbb{H} \oplus \mathbb{C}$	$\mathbb{H} \oplus \mathbb{C} \oplus \mathcal{C}$	$\mathbb{H} \oplus \mathbb{C} \oplus \mathcal{C}_1 \oplus \mathcal{C}_2$		

Here \mathcal{C} , \mathcal{C}_1 and \mathcal{C}_2 are three arbitrary simple algebras. The colour algebras \mathcal{C} for $N = 3$ and $\mathcal{C}_1 \oplus \mathcal{C}_2$ for $N = 4$ have two constraints:

i) Their representations on corresponding left- and right-handed subspaces of \mathcal{H} are identical (up to possibly different multiplicities).

ii) The Dirac operator \mathcal{D} is invariant under $U(\mathcal{C})$ or $U(\mathcal{C}_1 \oplus \mathcal{C}_2)$,

$$\rho(1, 1, w) \mathcal{D} \rho(1, 1, w)^{-1} = \mathcal{D}, \quad \text{for all } w \in U(\mathcal{C}) \text{ or } U(\mathcal{C}_1 \oplus \mathcal{C}_2).$$

This implies that the unitaries of \mathcal{C} or $\mathcal{C}_1 \oplus \mathcal{C}_2$ do not participate in the fluctuations and are therefore unbroken, i.e. elements of the little group.

We must admit that our brute force proof by exhaustion is not suitable for $N = 4$ and it seems already a formidable task to write down the list of all contracted irreducible diagrams.

Besides renormalizability, there are two other important items on the physicist's shopping list, which will further constrain the model building kit:

i) The electric charge of a massless particle must be zero.

ii) The representation of the little group on the Hilbert space of fermions must be complex.

Recall that a unitary representation is called real if it is equal to its complex conjugate and pseudo-real if it is unitarily equivalent to its complex conjugate. Otherwise the representation is complex. For example the fundamental representation of $SU(2)$ is pseudo-real. An irreducible, unitary representation of $U(1)$ is complex if and only if its charge is non-zero.

Before we can examine these two criteria in the irreducible context, we must compute the minimal central extensions [12,15] that allow the lift of algebra automorphisms to the Hilbert space of fermions to have at most a finite number of values. This calculation is under way.

Acknowledgements: One of us (T.S.) thanks Harald Grosse for his hospitality at the Erwin Schrödinger Institute where part of this work was done. We gratefully acknowledge a fellowship of the Friedrich-Ebert-Stiftung for C.S.

11 Appendix

Since this paper deals with matrices, let us briefly recall two standard results, one on the singular value decomposition of rectangular matrices and the second on the standard form of skewsymmetric matrices.

We write $O(n) := U(M_n(\mathbb{R}))$, $U(n) := U(M_n(\mathbb{C}))$ and $USp(n) := U(M_n(\mathbb{H}))$.

Lemma 11.1. *i) Let $M \in M_{n \times m}(\mathbb{C})$. Then there exist $U \in U(n), V \in U(m)$ such that $M = U D V$ where $D \in M_{n \times m}(\mathbb{R})$ satisfies $D_{ij} = 0$ for $i \neq j$ and $D_{11} \geq D_{22} \geq \dots \geq D_{kk} > D_{k+1,k+1} = \dots = D_{qq} = 0$ where $k = \text{rank}(M)$ and $q = \min(n, m)$. The D_{ii}^2 are the eigenvalues of $M^* M$, the columns of U (resp. V) are the eigenvectors of $M M^*$ (resp. $M^* M$) arranged in the same order as the eigenvalues D_{ii}^2 . In particular, when $M \in M_{n \times m}(\mathbb{R})$, we may assume $U \in O(n), V \in O(m)$ ([9] 7.3.5).*

ii) Let $M \in M_n(\mathbb{C})$ be a skewsymmetric matrix. Then, there exists $U \in U(n)$ such that

$$U M U^T = \left(\bigoplus_{i=1}^p m_i x \right) \oplus 0 \cdots \oplus 0 \quad \text{where} \quad x = \begin{pmatrix} 0 & 1 \\ -1 & 0 \end{pmatrix}, \quad m_i \in \mathbb{C}^* \quad (11.1)$$

and the numbers of zeros equals $n - 2p$ ([9] 4.4, Problem 26).

For our purpose, M is the *complex* fermionic mass matrix. Then, in *i)*, the diagonal elements D_{jj} are the Dirac masses and the unitaries U and V are related to the Cabibbo-Kobayashi-Maskawa matrix.

Definition 11.2. Let $M \in M_{n \times m}(\mathbb{C})$ and

$$f \in \mathcal{F}_{\mathbb{K}, \mathbb{K}'} := \{(r_j, u_j, v_j)_{j \in J} \in \mathbb{R} \times U(M_n(\mathbb{K})) \times U(M_m(\mathbb{K}')) \mid J \text{ finite}\}$$

where \mathbb{K}, \mathbb{K}' are \mathbb{R}, \mathbb{C} or \mathbb{H} . The *fluctuation* of M is defined by

$${}^f M := \sum_j r_j u_j M v_j.$$

In the case that \mathbb{C} and \mathbb{H} are involved, we assume of course that $\mathbb{C} \subset \mathbb{H}$.

Note that for a given M ,

$$\{{}^f M \mid f \in \mathcal{F}_{\mathbb{R}, \mathbb{C}}\} = \{{}^f M \mid f \in \mathcal{F}_{\mathbb{C}, \mathbb{R}}\} = \{{}^f M \mid f \in \mathcal{F}_{\mathbb{C}, \mathbb{C}}\}.$$

Lemma 11.3. *Let $\text{Span}_{\mathbb{R}}(E)$ be the real vector space spanned by the set E . Then,*

- i) $\text{Span}_{\mathbb{R}}(O(n)) = M_n(\mathbb{R})$.*
- ii) $\text{Span}_{\mathbb{R}}(U(n)) = M_n(\mathbb{C})$.*
- iii) $\text{Span}_{\mathbb{R}}(USp(n)) = M_n(\mathbb{H})$.*

Proof. i) It is sufficient to prove that any $a = \pm a^T \in M_n(\mathbb{R})$ is in $\text{Span}_{\mathbb{R}}(O(n))$.

When $a = a^T$, there exists $v \in O(n)$ such that $a = v d v^T$ where d is a real diagonal matrix. Since

$$d = \sum_{i=1}^n \frac{d_{ii}}{2} (2p_i - 1_n) + \frac{d_{ii}}{2} 1_n,$$

where p_i is the projection on the i -th vector basis, so d is in $\text{Span}_{\mathbb{R}}(O(n))$ and so is a .

When $a = -a^T$, there exist $v \in O(n)$ and a family $r_k \in \mathbb{R}, k \leq \frac{n}{2}$ such that

$$a = v \text{diag}(0, \dots, 0, r_1 b, \dots, r_k b) v^T$$

where $b = \begin{pmatrix} 0 & 1 \\ -1 & 0 \end{pmatrix}$. Thus for $r = \sum_i r_i$,

$$v^T a v = b_1 \text{diag}(1, \dots, 1, b, 1_2, \dots, 1_2) + r_2 \text{diag}(1, \dots, 1, 1_2, b, 1_2 \dots, 1_2) + \dots + r_k (1, \dots, 1, 1_2, \dots, 1_2, b) - \text{diag}(r, \dots, r, (r - r_1)1_2, \dots, (r - r_k)1_2)$$

is a real linear combination of matrices in $O(n)$ by i). So $a \in \text{Span}_{\mathbb{R}}(O(n))$.

ii) This follows by i) since $O(n)$ and $iO(n)$ are included in $U(n)$.

iii) Let $1, e_1, e_2, e_3$ be the canonical basis of \mathbb{H} such that $e_i e_j = \delta_{ij} 1 - \epsilon_{ijk} e_k$ and $1 e_i = e_i 1 = e_i$. Since $M_n(\mathbb{H})$ is an \mathbb{H} -vector space, $M_n(\mathbb{H}) = 1 M_n(\mathbb{R}) + e_1 M_n(\mathbb{R}) + e_2 M_n(\mathbb{R}) + e_3 M_n(\mathbb{R})$ and the result follows from $e_i O(n) \subset USp(n)$. \square

Corollary 11.4. $\{ {}^f M \mid f \in \mathcal{F}_{\mathbb{K}, \mathbb{K}'} \} = \{ \sum_i a_i M b_i \mid a_i \in M_n(\mathbb{K}), b_i \in M_m(\mathbb{K}') \}$.

Remark 11.5. If $\mathbb{K} = \mathbb{K}'$, then for any $0 \neq M \in M_{n \times m}(\mathbb{K})$,

$$\{ {}^f M \mid f \in \mathcal{F}_{\mathbb{K}, \mathbb{K}} \} = M_{n \times m}(\mathbb{K}).$$

Nevertheless, we have a priori

$$\{ {}^f M \mid f \in \mathcal{F}_{\mathbb{K}, \mathbb{K}'} \} \not\subset \{ a M b \mid a \in M_n(\mathbb{K}), b \in M_m(\mathbb{K}') \},$$

while the converse inclusion is true by the previous corollary. Actually, for $n = m = 2$ and $\mathbb{K} = \mathbb{K}' = \mathbb{C}$, if $M = \begin{pmatrix} 1 & 0 \\ 0 & 0 \end{pmatrix}$, $\text{Rank}(a M b) \leq 1$ for any a and b in $M_n(\mathbb{C})$, but for the fluctuation

$$f = \{ r_1 = r_2 = 1, u_1 = v_1 = 1_2, u_2 = v_2 = \begin{pmatrix} 0 & 1 \\ 1 & 0 \end{pmatrix} \}, \text{Rank}({}^f M) = \text{Rank}(1_2) = 2.$$

Lemma 11.6. *Given a family of k \mathbb{R} -linearly independent matrices $M_i \in M_{n \times m}(\mathbb{R})$, $i = 1, \dots, k$, there exists a fluctuation $f \in \mathcal{F}_{\mathbb{R}, \mathbb{R}}$ such that ${}^f M_i = 0$ for all $i \neq 1$ and ${}^f M_1 \neq 0$.*

Proof. Let $\{c_i\}_{i \in \{1, \dots, p\}}$ be the canonical basis of column vectors in \mathbb{R}^p . (We use abusively the same notation for different ps .) Remark first that the fluctuation defined for given $r_1, r_2 \in \mathbb{R}, i, k \in \{1, \dots, n\}$ and $j, l \in \{1, \dots, m\}$ by

$${}^f M := r_1 M + r_2 c_i c_k^T M c_l c_j^T$$

$$= r_1 M + r_2 M_{kl} c_i c_j^T$$

satisfies $({}^f M)_{pq} = r_1 M_{pq}$ for all $p \neq i$ and $q \neq j$ and $({}^f M)_{ij} = r_1 M_{ij} + r_2 M_{kl}$.

For any $M \in M_{n \times m}(\mathbb{R})$ let

$$W(M) := \begin{pmatrix} M_{11} \\ \vdots \\ M_{1m} \\ M_{21} \\ \vdots \\ M_{nm} \end{pmatrix} \in \mathbb{R}^{nm}.$$

Given a family of matrices $M_1, \dots, M_k \in M_{n \times m}(\mathbb{R})$, let N be the matrix in $M_{nm \times k}(\mathbb{R})$ defined by the columns $W(M_i)$:

$$N := (W(M_1) \mid W(M_2) \mid \dots \mid W(M_k)).$$

Thus, if a fluctuation $f \in \mathcal{F}_{\mathbb{R}, \mathbb{R}}$ is defined simultaneously on all M_i 's, N is transformed in $f(N) := (W({}^f M_1) \mid W({}^f M_2) \mid \dots \mid W({}^f M_k))$. By the previous remark, adding a multiple of a line of N to a multiple of another one correspond precisely to a fluctuation. Using Gauß' method, if the M_i 's are linearly independent (thus $k \leq nm$), so are the $W(M_i)$'s and there exists a fluctuation f such that

$$f(N) = \begin{pmatrix} 1_{k \times k} \\ 0_{(nm-k) \times k} \end{pmatrix}$$

since the rank of N is k . This means that a second fluctuation given by ${}^g M := c_1 c_1^T M c_1 c_1^T$ will give ${}^{fg} M_1 = {}^f M_1 \neq 0$ while ${}^{fg} M_i = 0$ for all $i \neq 1$. \square

Remark 11.7. This lemma is false when the matrices have complex entries: Let $M_1 = \begin{pmatrix} i \\ 1 \end{pmatrix}$ and $M_2 = \begin{pmatrix} 1 \\ 0 \end{pmatrix}$. Then M_1 and M_2 are \mathbb{R} - and \mathbb{C} -linearly independent. Nevertheless, ${}^f M_1 = 0$ always yields ${}^f M_2 = \text{Im}({}^f M_1) = 0$. There only remains the following

Lemma 11.8. *Let $M_i \in M_{n \times m}(\mathbb{C})$, $i = 1, \dots, k$ be k matrices such that their real and imaginary parts are $2k$ \mathbb{R} -linearly independent matrices. Then there exists a fluctuation $f \in \mathcal{F}_{\mathbb{R}, \mathbb{R}}$ such that ${}^f M_1 \neq 0$ and ${}^f M_i = 0$ for all $i \neq 1$.*

Proof. According to the previous lemma, there exists a fluctuation $f \in \mathcal{F}_{\mathbb{R}, \mathbb{R}}$ such that $\text{Re}({}^f M_1) \neq 0$ while $\text{Im}({}^f M_1) = \text{Re}({}^f M_i) = \text{Im}({}^f M_i) = 0$ for all $i \neq 1$, yielding the conclusion since real and imaginary extractions commute with fluctuations. \square

Within fluctuations, there are the symmetric ones in the following sense:

Definition 11.9. Let $\mathcal{F}_{\mathbb{C},\mathbb{C}^T} := \{(r_j, u_j)_{j \in J} \in \mathbb{R} \times U(n) \mid J \text{ finite}\}$ and define fluctuations $f^T \in \mathcal{F}_{\mathbb{C},\mathbb{C}^T}$ on $n \times n$ square matrices by

$$f^T M := \sum_j r_j u_j M u_j^T.$$

Lemma 11.10. *Let M_1, M_2 be two skewsymmetric matrices in $M_n(\mathbb{C})$. Then*

i) *If the constraints $f^T M_1 = 0$ for $f \in \mathcal{F}_{\mathbb{C},\mathbb{C}^T}$ always implies $f^T M_2 = 0$, then M_2 is \mathbb{C} -colinear to M_1 .*

ii) *If M_2 is not colinear to M_1 , then there exists a fluctuation $f^T \in \mathcal{F}_{\mathbb{C},\mathbb{C}^T}$ such that $f^T M_1 = 0$ and $f^T M_2 \neq 0$.*

Proof. Note that ii) is a consequence of i).

To prove i), we may assume that M_1 has the form as in (11.1).

$s := \begin{pmatrix} 0 & 1 \\ 1 & 0 \end{pmatrix}$ and $t := \begin{pmatrix} 1 & 0 \\ 0 & -1 \end{pmatrix}$ are two unitaries satisfying $wxw^T = -x$ for $w = s, t$.

Define $u = v \oplus 1 \oplus \cdots \oplus 1 \in U(n)$ with $v = \bigoplus_{i=1}^p v_i \in U(2p)$ where $v_i \in \{s, t\}$. Then $M_1 + u M_1 u^T = 0$, so if M_2 has the form $\begin{pmatrix} A & B \\ C & D \end{pmatrix}$, with $A \in M_{2p}(\mathbb{C}), B \in M_{2p, n-2p}(\mathbb{C}), C \in M_{n-2p, 2p}(\mathbb{C}), D \in M_{n-2p, n-2p}(\mathbb{C})$, then $0 = M_2 + u M_2 u^T$. We deduce $0 = A + v A v^T = B + v B = C + C v^T = D + D$. Thus choosing $v_s = \bigoplus_{i=1}^p s$ and $v_t = \bigoplus_{i=1}^p t$, we have $(1_{2p} + v_s)B + (1_{2p} + v_t)B = 0$, so $B = 0$ since $2 \cdot 1_{2p} + v_s + v_t$ is invertible. Similarly, $C = D = 0$.

If A_{kl} is the partition of A in 2×2 matrices, the constraint $A + v A v^T = 0$ implies $0 = A_{kl} + u_k A_{kl} u_l^T$. When $k \neq l$, A_{kl} is necessarily zero since we may choose independently u_k and u_l in $\{s, t\}$. When $k = l$, $A_{kk} = \begin{pmatrix} \alpha_k & \gamma_k \\ -\gamma_k & \beta_k \end{pmatrix}$ where the α, β, γ 's are complex numbers, since A is skewsymmetric. If $u_k = t$, $0 = A_{kk} + u_k A_{kk} u_k = 2 \begin{pmatrix} \alpha_k & 0 \\ 0 & \beta_k \end{pmatrix}$ and $A_{kk} = \gamma_k x$. Thus $M_2 = \bigoplus_{k=1}^p \gamma_k x \oplus 0 \oplus \cdots \oplus 0$ and it remains to prove that $\gamma_k = c m_k$ for some constant c .

Define

$$\begin{aligned} u_k &:= s \oplus 1_2 \oplus \cdots \oplus 1_2 \oplus 1 \oplus \cdots \oplus 1, \\ v_k &:= 1_2 \oplus \cdots \oplus s \oplus \cdots \oplus 1_2 \oplus 1 \oplus \cdots \oplus 1, \\ w_k &:= \begin{pmatrix} 0 & 0 & \cdots & 0 & 1_2 \\ 0 & 1_2 & & & 0 \\ \vdots & & \ddots & & \vdots \\ 0 & & & 1_2 & 0 \\ 1_2 & 0 & \cdots & 0 & 0 \end{pmatrix} \oplus 1_2 \oplus \cdots \oplus 1_2 \oplus 1 \oplus \cdots \oplus 1, \end{aligned}$$

three unitaries where the perturbation in v_k is put at the k -th entry. Then

$$0 = (2m_1)^{-1} (M_1 - u M_1 u^T) - (2m_k)^{-1} w_k (M_1 - v_k M_1 v_k^T) w_k^T$$

and the same relation for M_2 yields $0 = 2(\gamma_1 m_1^{-1} - \gamma_k m_k^{-1})$, so $\gamma_k = \gamma_1 m_1^{-1} m_k$ and $M_2 = (\gamma_1 m_1^{-1}) M_1$. \square

References

- [1] E. Alvarez, J. M. Gracia-Bondía & C. P. Martín, “Anomaly cancellation and the gauge group of the Standard Model in Non-Commutative Geometry”, hep-th/9506115, Phys. Lett. B364 (1995) 33
- [2] L. Carminati, B. Iochum & T. Schücker, “Noncommutative Yang-Mills and noncommutative relativity: A bridge over troubled water”, hep-th/9706105, Eur. Phys. J. C8 (1999) 697
- [3] A. Chamseddine & A. Connes, “The spectral action principle”, hep-th/9606001, Comm. Math. Phys. 186 (1997) 731
- [4] A. Connes, *Noncommutative Geometry*, Academic Press, London and San Diego (1994)
- [5] A. Connes, “Noncommutative geometry and reality”, J. Math. Phys. 36 (1995) 6194
- [6] A. Connes, “Gravity coupled with matter and the foundation of noncommutative geometry”, hep-th/9603053, Comm. Math. Phys. 155 (1996) 109
- [7] A. Connes & J. Lott, “Particle models and noncommutative geometry”, Nucl. Phys. B 18B (1990) 29
A. Connes & J. Lott, “The metric aspect of noncommutative geometry”, in the proceedings of the 1991 Cargèse Summer Conference, eds.: J. Fröhlich et al., Plenum Press (1992)
- [8] J. M. Gracia-Bondía, J. C. Várilly & H. Figueroa, *Elements of Noncommutative Geometry*, Birkhäuser Advanced Text, Boston (2000)
- [9] R. A. Horn & C. A. Johnson, *Matrix Analysis*, Cambridge University Press, Cambridge (1985)
- [10] T. Krajewski, “Classification of finite spectral triples”, hep-th/9701081, J. Geom. Phys. 28 (1998) 1
- [11] T. Krajewski, “Constraints on scalar potential from spectral action principle”, hep-th/9803199
- [12] S. Lazzarini & T. Schücker, “A farewell to unimodularity”, hep-th/0104038, Phys. Lett. B 510 (2001) 277
- [13] C. P. Martín, J. M. Gracia-Bondía & J. C. Várilly, “The standard model as a noncommutative geometry: the low mass regime”, hep-th/9605001, Phys. Rep. 294 (1998) 363
- [14] M. Paschke & A. Sitarz, “Discrete spectral triples and their symmetries”, q-alg/9612029, J. Math. Phys. 39 (1998) 6191

[15] T. Schücker & S. ZouZou, "Spectral action beyond the standard model", hep-th/0109124

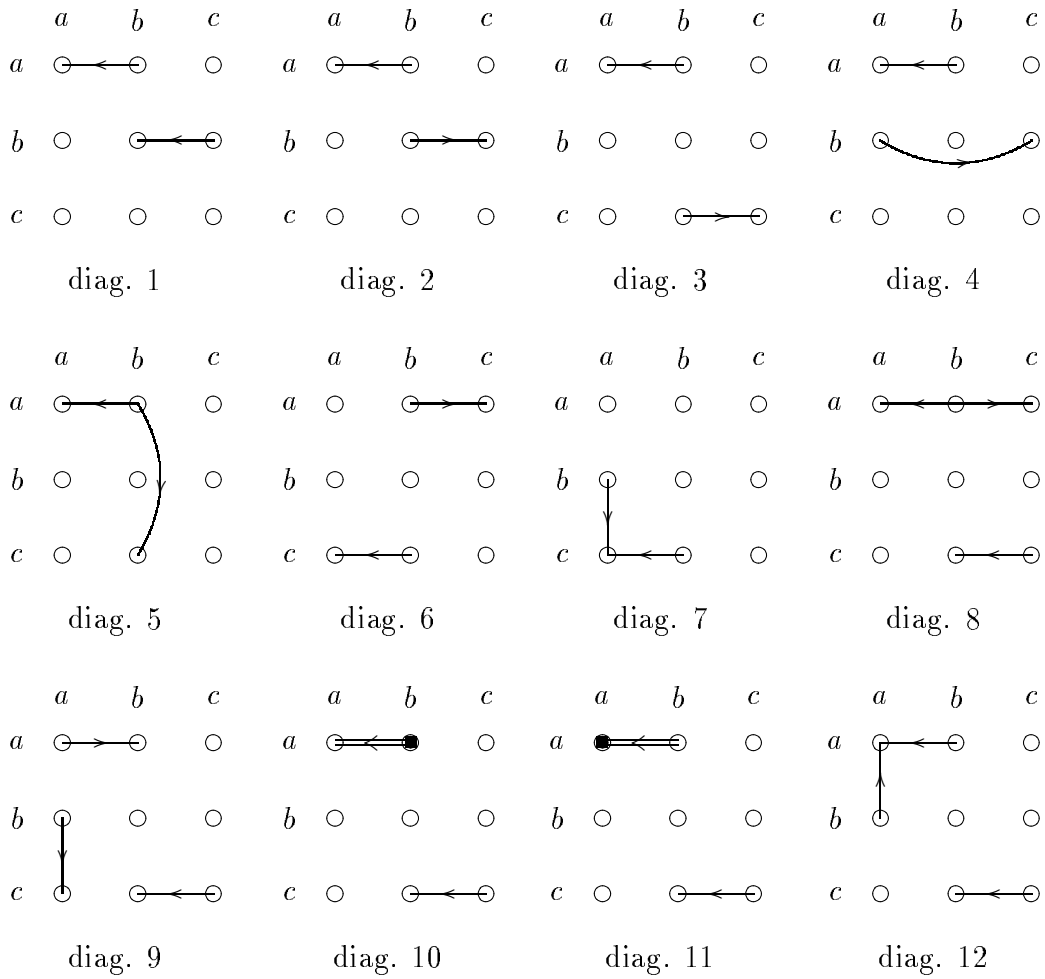

Fig. 6.1

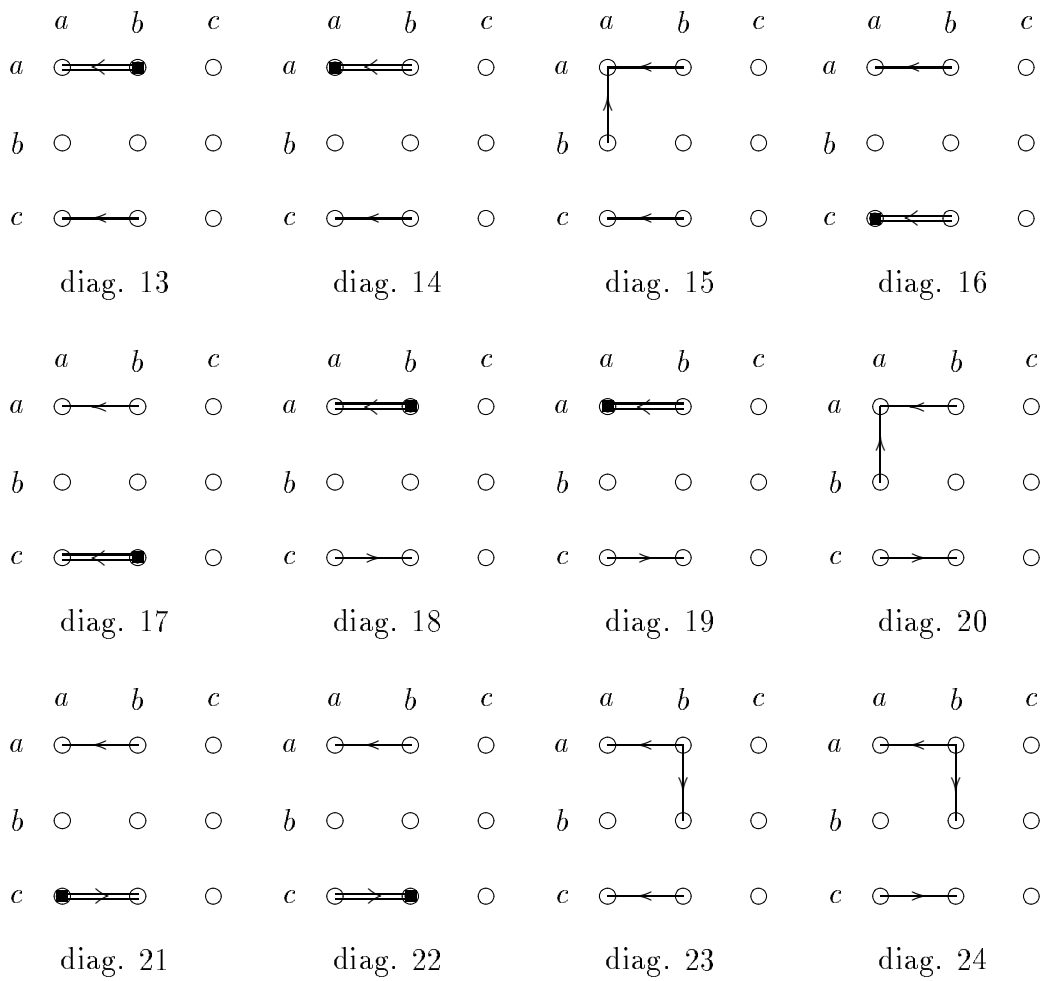

Fig. 6.2

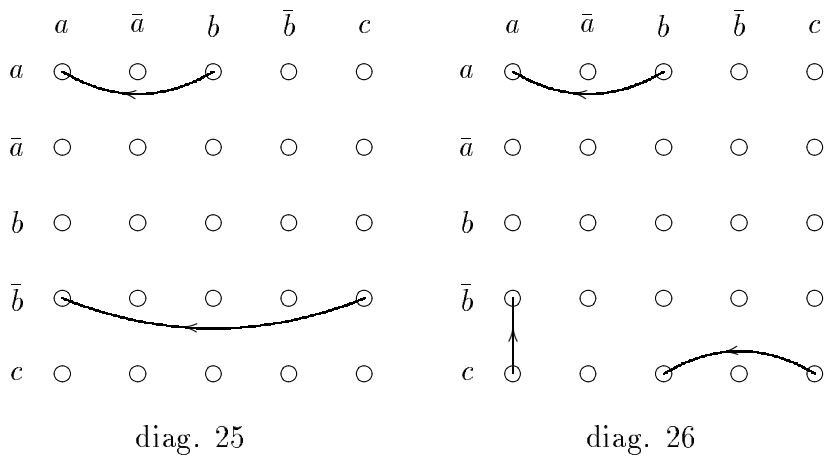

Fig. 7

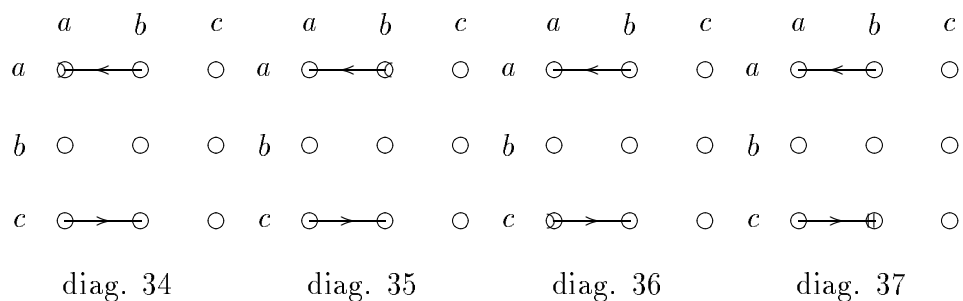
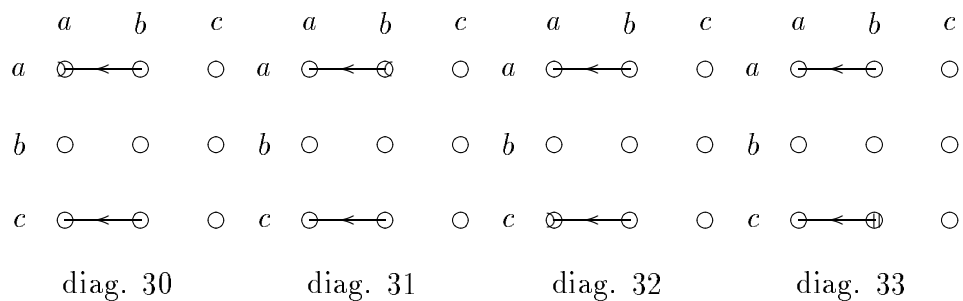
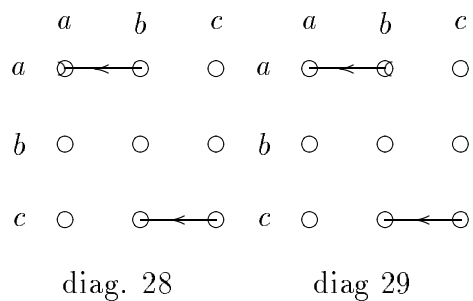
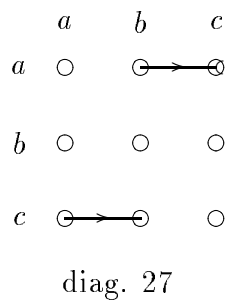

Fig. 8

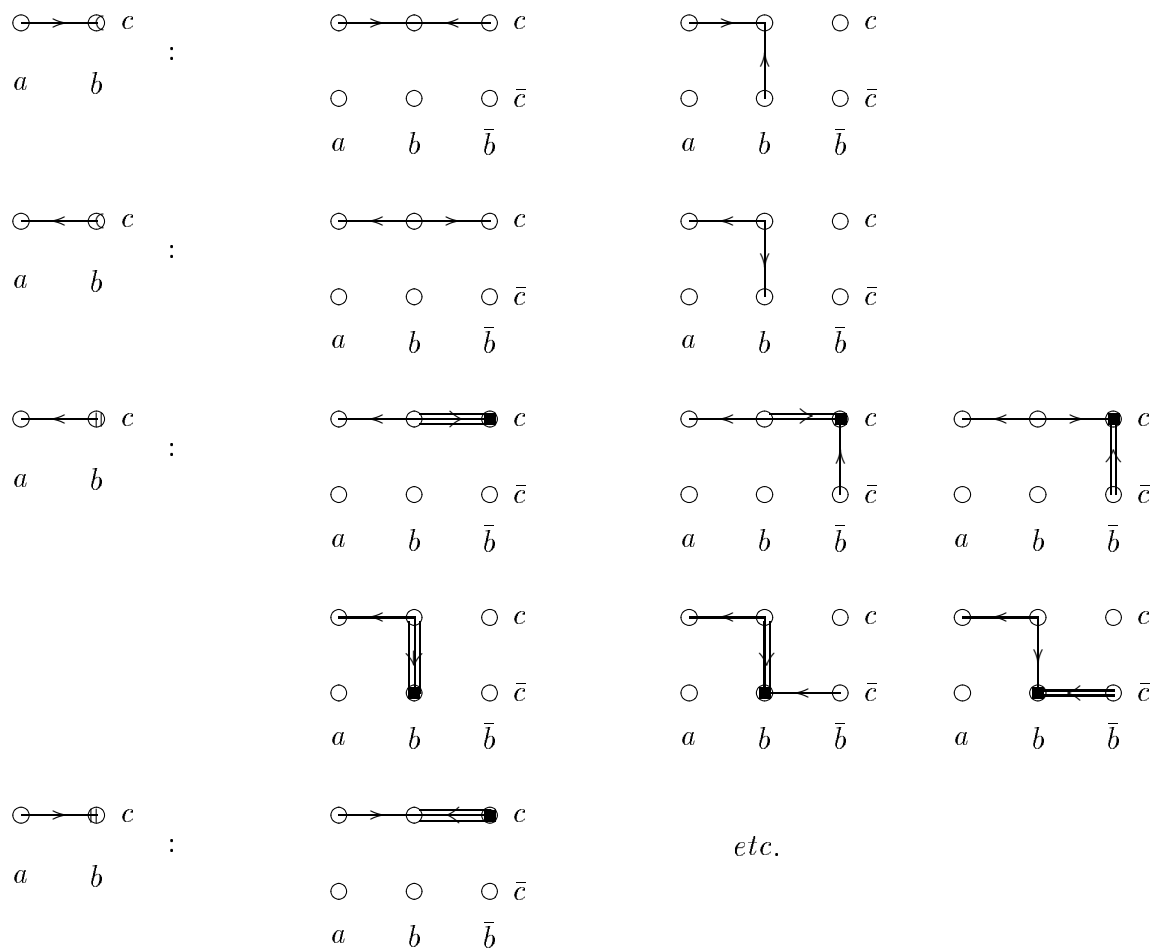

Fig. 9

CENTRE DE PHYSIQUE THÉORIQUE ¹
CNRS–Luminy, Case 907
13288 Marseille Cedex 9
FRANCE

On a Classification of Irreducible Almost Commutative Geometries, A Second Helping

Jan-Hendrik Jureit ^{2, 3} Christoph A. Stephan ^{2, 4}

Abstract

We complete the classification of almost commutative geometries from a particle physics point of view given in [1]. Four missing Krajewski diagrams will be presented after a short introduction into irreducible, non-degenerate spectral triples.

PACS-92: 11.15 Gauge field theories
MSC-91: 81T13 Yang-Mills and other gauge theories

January 2005

CPT-2005/P.002

¹ Unité Mixte de Recherche (UMR) 6207 du CNRS et des Universités Aix-Marseille 1 et 2
Sud Toulon-Var, Laboratoire affilié à la FRUMAM (FR 2291)

² and Université de Provence and Universität Kiel

³ jureit@cpt.univ-mrs.fr

⁴ stephan@cpt.univ-mrs.fr

1 Introduction

Alain Connes' noncommutative geometry [2–5] allows in an elegant way to unify gravity and the standard model of particle physics. A central role in this formalism is played by almost commutative spectral triples $(\mathcal{A}, \mathcal{H}, \mathcal{D})$ which decompose into an external and an internal, finite dimensional component. The external part encodes a compact 4-dimensional Euclidian spacetime and the internal one corresponds to a discrete 0-dimensional Kaluza-Klein space, determining the particle content of the theory. Via the spectral action [6] one recovers the Einstein-Hilbert action combined with the bosonic action of a Yang-Mills-Higgs (YMH) theory. Since the set of allowed YMH-theories is determined by the possible internal, finite dimensional spectral triples, we will restrict ourselves to this part. The standard model of particle physics is the most prominent example in this context.

Real, finite dimensional spectral triples have been completely classified by Krajewski [7] and Paschke & Sitarz [8]. A classification of almost commutative geometries from a physical point of view was given in [1]. The spectral triples were required to be irreducible and non-degenerate, in the sense that the Hilbert space was chosen to be as small as possible with non-degenerate fermion masses. Heavy use was made of Krajewski's diagrammatic method, which will be described briefly below. The main obstacle in finding all physically relevant almost commutative spectral triples is the sheer mass of diagrams which have to be considered. Since this is a purely combinatorial problem it is convenient to let a computer do the tedious task. The cases of one and two matrix algebras can still be done by hand. But already three algebras produce hundreds of diagrams and one easily loses sight.

Therefore we developed an algorithm to calculate these diagrams and used the known results from [1] to test and calibrate the program. The main goal was to extend the calculations to more than three algebras, where we expect thousands of possible irreducible spectral triples. During the calibration it turned out that four diagrams were overlooked in the case of three algebras. To complete the proof we will present these four missing diagrams and their models in this paper. The algorithm to compute the diagrams and the results for the case of four algebras will be presented elsewhere.

In section 2 and 3 we will briefly introduce Krajewski diagrams and irreducible, non-degenerate spectral triples. The missing diagrams for three algebras will be presented in section 4.

2 Basic definitions and Krajewski diagrams

In this section we will give the necessary basic definitions for a classification of almost commutative geometries from a particle physics point of view. As mentioned above only the 0-dimensional part will be taken into account, so we restrict ourselves to real, S^0 -real, finite spectral triples $(\mathcal{A}, \mathcal{H}, \mathcal{D}, J, \epsilon, \chi)$. The algebra \mathcal{A} is a finite sum of matrix algebras $\mathcal{A} = \bigoplus_{i=1}^N M_{n_i}(\mathbb{K}_i)$ with $\mathbb{K}_i = \mathbb{R}, \mathbb{C}, \mathbb{H}$ where \mathbb{H} denotes the quaternions. A faithful representation ρ of \mathcal{A} is given on the finite dimensional Hilbert space \mathcal{H} . The Dirac operator \mathcal{D} is a selfadjoint operator on \mathcal{H} and plays the role of the fermionic mass

matrix. J is an antiunitary involution, $J^2 = 1$, and is interpreted as the charge conjugation operator of particle physics. The S^0 -real structure ϵ is a unitary involution, $\epsilon^2 = 1$. Its eigenstates with eigenvalue $+1$ are the particle states, eigenvalue -1 indicates antiparticle states. The chirality χ is as well a unitary involution, $\chi^2 = 1$, whose eigenstates with eigenvalue $+1$ (-1) are interpreted as right (left) particle states. These operators are required to fulfill Connes' axioms for spectral triples:

- $[J, \mathcal{D}] = [J, \chi] = [\epsilon, \chi] = [\epsilon, \mathcal{D}] = 0$, $\epsilon J = -J\epsilon$, $\mathcal{D}\chi = -\chi\mathcal{D}$,
 $[\chi, \rho(a)] = [\epsilon, \rho(a)] = [\rho(a), J\rho(b)J^{-1}] = [[\mathcal{D}, \rho(a)], J\rho(b)J^{-1}] = 0, \forall a, b \in \mathcal{A}$.
- The chirality can be written as a finite sum $\chi = \sum_i \rho(a_i)J\rho(b_i)J^{-1}$. This condition is called *orientability*.
- The intersection form $\cap_{ij} := \text{tr}(\chi \rho(p_i)J\rho(p_j)J^{-1})$ is non-degenerate, $\det \cap \neq 0$. The p_i are minimal rank projections in \mathcal{A} . This condition is called *Poincaré duality*.

Now the Hilbert space \mathcal{H} and the representation ρ decompose with respect to the eigenvalues of ϵ and χ into left and right, particle and antiparticle spinors and representations:

$$\mathcal{H} = \mathcal{H}_L \oplus \mathcal{H}_R \oplus \mathcal{H}_L^c \oplus \mathcal{H}_R^c \quad (2.1)$$

$$\rho = \rho_L \oplus \rho_R \oplus \overline{\rho}_L^c \oplus \overline{\rho}_R^c \quad (2.2)$$

In this representation the Dirac operator has the form

$$\mathcal{D} = \begin{pmatrix} 0 & \mathcal{M} & 0 & 0 \\ \mathcal{M}^* & 0 & 0 & 0 \\ 0 & 0 & 0 & \overline{\mathcal{M}} \\ 0 & 0 & \overline{\mathcal{M}}^* & 0 \end{pmatrix}, \quad (2.3)$$

where \mathcal{M} is the fermionic mass matrix connecting the left and the right handed Fermions.

Since the individual matrix algebras have only one fundamental representation for $\mathbb{K} = \mathbb{R}, \mathbb{H}$ and two for $\mathbb{K} = \mathbb{C}$ (the fundamental one and its complex conjugate), ρ may be written as a direct sum of these fundamental representations with multiplicities

$$\rho(\oplus_{i=1}^N a_i) := (\oplus_{i,j=1}^N \alpha_i, \alpha_j a_{i\alpha_i} \otimes 1_{m_{j\alpha_j i\alpha_i}} \otimes 1_{(n_j)}) \oplus (\oplus_{i,j=1}^N 1_{(n_i)} \otimes 1_{m_{j\alpha_j i\alpha_i}} \otimes \overline{a_{j\alpha_j}}). \quad (2.4)$$

The first summand denotes the particle sector and the second the antiparticle sector. For the dimensions of the unity matrices we have $(n) = n$ for $\mathbb{K} = \mathbb{R}, \mathbb{C}$ and $(n) = 2n$ for $\mathbb{K} = \mathbb{H}$ and the convention $1_0 = 0$. The index α indicates whether the representation is the fundamental one or its complex conjugate and thus applies only to the $\mathbb{K} = \mathbb{C}$ case. The multiplicities $m_{j\alpha_j i\alpha_i}$ are non-negative integers. Acting with the real structure J on ρ permutes the main summands and complex conjugates them. It is also possible to write the chirality as a direct sum

$$\chi = (\oplus_{i,j=1}^N 1_{(n_i)} \otimes \chi_{j\alpha_j i\alpha_i} 1_{m_{j\alpha_j i\alpha_i}} \otimes 1_{(n_j)}) \oplus (\oplus_{i,j=1}^N 1_{(n_i)} \otimes \chi_{j\alpha_j i\alpha_i} 1_{m_{j\alpha_j i\alpha_i}} \otimes 1_{(n_j)}), \quad (2.5)$$

where $\chi_{j\alpha_j i\alpha_i} = \pm 1$ according to our previous convention on left-(right-)handed spinors. One can now define the multiplicity matrix $\mu \in M_N(\mathbb{Z})$ such that $\mu_{j\alpha_j i\alpha_i} := \chi_{j\alpha_j i\alpha_i} m_{j\alpha_j i\alpha_i}$. This matrix is symmetric and decomposes into a particle and an antiparticle matrix, the second being just the particle matrix transposed, $\mu = \mu_P + \mu_A = \mu_P + \mu_P^T$. The entries of the multiplicity matrix must fulfill certain consistency conditions, which are given by table 1 in [7]. It is also possible to recover the intersection form of the Poincaré duality, up to a numerical factor, if the multiplicity matrix is contracted by summation over the α 's.

The mass matrix \mathcal{M} of the Dirac operator connects the left and the right handed Fermions. Using the decomposition of the representation ρ and the corresponding decomposition of the Hilbert space \mathcal{H} we find two types of submatrices in \mathcal{M} , namely $M \otimes 1_{(n_k)}$ and $1_{(n_k)} \otimes M$. M is a complex $(n_i) \times (n_j)$ matrix connecting the i -th and the j -th sub-Hilbert space and its eigenvalues give the masses of the fermion multiplet. We will call the k -th algebra the colour algebra.

Connes' axioms, the decomposition of the Hilbert space, the representation and the Dirac operator allow a diagrammatic depiction. As was shown in [7] and [1] this can be boiled down to simple arrows, which encode the multiplicity matrix and the fermionic mass matrix. From these information all the ingredients of the spectral triple can be recovered. For our purpose a simple arrow and a double arrow are sufficient. The arrows allways point from right fermions (positive chirality) to left fermions (negative chirality). We may also restrict ourselves to the particle part, since the information of the antiparticle part is included by transposing the particle part. As an example we will retranslate these two generic arrows into the multiplicity matrix, the representation of the algebra and the Dirac operator. We will adopt the conventions of [1] so that algebra elements tensorised with $1_{m_{ij}}$ will be written as a direct sum of m_{ij} summands.

Take the algebra $\mathcal{A} = \mathbb{H} \oplus M_3(\mathbb{C}) \ni (a, b)$ with the first diagram of Figure 1.

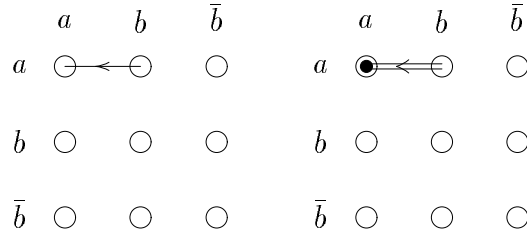

Fig. 1

Then the multiplicity matrix and its contraction are

$$\mu = \begin{pmatrix} -1 & 1 & 0 \\ 0 & 0 & 0 \\ 0 & 0 & 0 \end{pmatrix}, \quad \hat{\mu} = \begin{pmatrix} -1 & 1 \\ 0 & 0 \end{pmatrix}.$$

Using (2.2), its representation is, up to unitary equivalence

$$\rho_L(a, b) = a \otimes 1_2, \quad \rho_R(a, b) = b \otimes 1_2, \quad \rho_L^c(a, b) = 1_2 \otimes a, \quad \rho_R^c(a, b) = 1_3 \otimes a.$$

The Hilbert space is

$$\mathcal{H} = \mathbb{C}^4 \oplus \mathbb{C}^6 \oplus \mathbb{C}^4 \oplus \mathbb{C}^6.$$

In its Dirac operator (2.3) the mass matrix is $\mathcal{M} = M \otimes 1_2$, where M is a nonvanishing complex 2×3 matrix.

Real structure, S^0 -real structure and chirality are given by (cc stands for complex conjugation)

$$J = \begin{pmatrix} 0 & 1_{10} \\ 1_{10} & 0 \end{pmatrix} \circ \text{cc}, \quad \epsilon = \begin{pmatrix} 1_{10} & 0 \\ 0 & -1_{10} \end{pmatrix}, \quad \chi = \begin{pmatrix} -1_4 & 0 & 0 & 0 \\ 0 & 1_6 & 0 & 0 \\ 0 & 0 & -1_4 & 0 \\ 0 & 0 & 0 & 1_6 \end{pmatrix}.$$

The first tensor factor in $a \otimes 1_2$ concerns particles, the second concerns antiparticles denoted by \cdot^c . The antiparticle representation is read from the transposed multiplicity matrix.

The second diagram of Figure 1 yields

$$\mu = \begin{pmatrix} -1 & 2 & 0 \\ 0 & 0 & 0 \\ 0 & 0 & 0 \end{pmatrix}, \quad \hat{\mu} = \begin{pmatrix} -1 & 2 \\ 0 & 0 \end{pmatrix},$$

and its spectral triple reads:

$$\begin{aligned} \rho_L(a, b) &= a \otimes 1_2, & \rho_R(a, b) &= \begin{pmatrix} b & 0 \\ 0 & b \end{pmatrix} \otimes 1_2, \\ \rho_L^c(a, b) &= 1_2 \otimes a, & \rho_R^c(a, b) &= \begin{pmatrix} 1_3 & 0 \\ 0 & 1_3 \end{pmatrix} \otimes a, \\ \mathcal{M} &= (M_1 \ M_2) \otimes 1_2, & M_1 \text{ and } M_2 & \text{ of size } 2 \times 3, \end{aligned}$$

$$J = \begin{pmatrix} 0 & 1_{16} \\ 1_{16} & 0 \end{pmatrix} \circ \text{cc}, \quad \epsilon = \begin{pmatrix} 1_{16} & 0 \\ 0 & -1_{16} \end{pmatrix}, \quad \chi = \begin{pmatrix} -1_4 & 0 & 0 & 0 \\ 0 & 1_{12} & 0 & 0 \\ 0 & 0 & -1_4 & 0 \\ 0 & 0 & 0 & 1_{12} \end{pmatrix}.$$

It should be clear that the number of possible ways to fit one and more arrows into a diagram increases factorially with the number of matrix algebras, i.e. with the size of the diagram. Thus this seemingly simple problem soon becomes intractable, even for a powerful computer.

We started out with the flat Dirac operator of a 4-dimensional spacetime with a fixed fermionic mass matrix. To generate curvature we have to perform a general coordinate transformation and then fluctuate the Dirac operator. This can be achieved by lifting the automorphisms of the algebra to the Hilbert space, unitarily transforming the Dirac operator with the lifted automorphisms and then building linear combinations. Again we restrict ourselves to the finite case. Except for complex conjugation in $M_n(\mathbb{C})$ and

permutations of identical summands in the algebra $\mathcal{A} = \mathcal{A}_1 \oplus \mathcal{A}_2 \oplus \dots \oplus \mathcal{A}_N$, every algebra automorphism σ is inner, $\sigma(a) = uau^{-1}$ for a unitary $u \in U(\mathcal{A})$. Therefore the connected component of the automorphism group is $\text{Aut}(\mathcal{A})^e = U(\mathcal{A})/(U(\mathcal{A}) \cap \text{Center}(\mathcal{A}))$. Its lift to the Hilbert space [4]

$$L(\sigma) = \rho(u)J\rho(u)J^{-1}$$

is multi-valued.

The *fluctuation* ${}^f\mathcal{D}$ of the Dirac operator \mathcal{D} is given by a finite collection f of real numbers r_j and algebra automorphisms $\sigma_j \in \text{Aut}(\mathcal{A})^e$ such that

$${}^f\mathcal{D} := \sum_j r_j L(\sigma_j) \mathcal{D} L(\sigma_j)^{-1}, \quad r_j \in \mathbb{R}, \sigma_j \in \text{Aut}(\mathcal{A})^e.$$

The fluctuated Dirac operator ${}^f\mathcal{D}$ is often denoted by φ , the ‘Higgs scalar’, in the physics literature. We consider only fluctuations with real coefficients since ${}^f\mathcal{D}$ must remain selfadjoint.

To avoid the multi-valuedness in the fluctuations, we allow the entire unitary group viewed as a (maximal) central extension of the automorphism group.

An almost commutative geometry is the tensor product of a finite noncommutative triple with an infinite, commutative spectral triple. By Connes’ reconstruction theorem [5] we know that the latter comes from a Riemannian spin manifold, which we will take to be any 4-dimensional, compact, flat manifold like the flat 4-torus. The spectral action of this almost commutative spectral triple reduced to the finite part is a functional on the vector space of all fluctuated, finite Dirac operators:

$$V({}^f\mathcal{D}) = \lambda \text{tr}[({}^f\mathcal{D})^4] - \frac{\mu^2}{2} \text{tr}[({}^f\mathcal{D})^2],$$

where λ and μ are positive constants [2, 9]. The spectral action is invariant under lifted automorphisms and even under the unitary group $U(\mathcal{A}) \ni u$,

$$V([\rho(u)J\rho(u)J^{-1}]{}^f\mathcal{D}[\rho(u)J\rho(u)J^{-1}]^{-1}) = V({}^f\mathcal{D}),$$

and it is bounded from below. Our task is to find the minima $\hat{{}^f\mathcal{D}}$ of this action and their spectra.

3 Irreducibility, Non-Degeneracy

To classify the almost commutative spectral triples we will impose some extra conditions as in [1]. We will require the spectral triples to be irreducible and non-degenerate according to the following definitions:

Definition 3.1. i) A spectral triple $(\mathcal{A}, \mathcal{H}, \mathcal{D})$ is *degenerate* if the kernel of \mathcal{D} contains a non-trivial subspace of the complex Hilbert space \mathcal{H} invariant under the representation ρ on \mathcal{H} of the real algebra \mathcal{A} .

ii) A non-degenerate spectral triple $(\mathcal{A}, \mathcal{H}, \mathcal{D})$ is *reducible* if there is a proper subspace

$\mathcal{H}_0 \subset \mathcal{H}$ invariant under the algebra $\rho(\mathcal{A})$ such that $(\mathcal{A}, \mathcal{H}_0, \mathcal{D}|_{\mathcal{H}_0})$ is a non-degenerate spectral triple. If the triple is real, S^0 -real and even, we require the subspace \mathcal{H}_0 to be also invariant under the real structure J , the S^0 -real structure ϵ and under the chirality χ such that the triple $(\mathcal{A}, \mathcal{H}_0, \mathcal{D}|_{\mathcal{H}_0})$ is again real, S^0 -real and even.

Definition 3.2. The irreducible spectral triple $(\mathcal{A}, \mathcal{H}, \mathcal{D})$ is *dynamically non-degenerate* if all minima $\hat{f}\mathcal{D}$ of the action $V(\hat{f}\mathcal{D})$ define a non-degenerate spectral triple $(\mathcal{A}, \mathcal{H}, \hat{f}\mathcal{D})$ and if the spectra of all minima have no degeneracies other than the three kinematical degeneracies: left-right, particle-antiparticle and colour. Of course in the massless case there is no left-right degeneracy. We also suppose that the colour degeneracies are protected by the little group. By this we mean that all eigenvectors of $\hat{f}\mathcal{D}$ corresponding to the same eigenvalue are in a common orbit of the little group (and scalar multiplication and charge conjugation).

In physicists' language non-degeneracy excludes all models with pairwise equal fermion masses in the left handed particle sector up to colour degeneracy. Irreducibility tells us that the Krajewski diagrams, which we have to find must not contain more arrows than strictly necessary to satisfy Connes' Axioms, especially the Poincaré duality. The last requirement of definition 3.2 means noncommutative colour groups are unbroken. It ensures that the corresponding mass degeneracies are protected from quantum corrections.

4 The Missing Diagrams

In this section we will present the diagrams missing in the proof for three algebras in [1]. For every diagram only one representative model will be given. All the other models can be obtained by simply exchanging left with right and particles with antiparticles. On the diagrammatic side this is equivalent to changing the directions of all arrows or reflecting the diagram on its diagonal. Permutations of the diagrams are neglected as well, since they lead to the same physical models with a different order of the particles. For every diagram there are several ways to connect the algebras by arrows in accordance with the consistency conditions of table 1. in [7]. With respect to this, the four diagrams are all computed in the same way and they all fall in the same way. The possibilities of complex conjugating an algebra representation are limited and yield no essentially new models. It should be obvious from the diagrams whether the matrix algebras are complex, real or quaternionic. In all other cases the choice of the field will not affect the calculations, so we will not specify the algebras explicitly. For the four missing diagrams, $\mathcal{A}_1, \mathcal{A}_2, \mathcal{A}_3$ denote the algebras, a, b, c their generic elements and k, ℓ, p the respective size of the matrices.

Diagram 1 yields the representation

$$\rho_L(a, b, c) = \begin{pmatrix} b \otimes 1_k & 0 & 0 \\ 0 & c \otimes 1_k & 0 \\ 0 & 0 & b \otimes 1_p \end{pmatrix}, \quad \rho_R(a, b, c) = \begin{pmatrix} \bar{a} \otimes 1_k & 0 & 0 \\ 0 & \bar{b} \otimes 1_k & 0 \\ 0 & 0 & a \otimes 1_p \end{pmatrix},$$

$$\rho_L^c(a, b, c) = \begin{pmatrix} 1_\ell \otimes a & 0 & 0 \\ 0 & 1_p \otimes a & 0 \\ 0 & 0 & 1_\ell \otimes \bar{c} \end{pmatrix}, \quad \rho_R^c(a, b, c) = \begin{pmatrix} 1_k \otimes a & 0 & 0 \\ 0 & 1_\ell \otimes a & 0 \\ 0 & 0 & 1_p \otimes \bar{c} \end{pmatrix}.$$

The mass matrix is

$$\mathcal{M} = \begin{pmatrix} M_1 \otimes 1_k & 0 & 0 \\ 0 & M_2 \otimes 1_k & 0 \\ 0 & 0 & M_3 \otimes 1_p \end{pmatrix}, \quad M_1, M_3 \in M_{k \times \ell}(\mathbb{C}), \quad M_2 \in M_{p \times \ell}(\mathbb{C}),$$

where all three algebras are $M_n(\mathbb{C})$. The fluctuations are

$$\begin{aligned} {}^f M_1 &= \sum_j r_j v_j M_1 \bar{u}_j^{-1}, \quad u_j \in U(\mathcal{A}_1), \quad v_j \in U(\mathcal{A}_2), \\ {}^f M_2 &= \sum_j r_j w_j M_2 \bar{v}_j^{-1}, \quad w_j \in U(\mathcal{A}_3), \\ {}^f M_3 &= \sum_j r_j v_j M_3 u_j^{-1}, \end{aligned}$$

and the action $V(C_1, C_2, C_3)$ is, with $C_i := {}^f M_i^* {}^f M_i$ equal to

$$4k [\lambda \operatorname{tr}(C_1)^2 - \frac{1}{2} \mu^2 \operatorname{tr}(C_1)] + 4k [\lambda \operatorname{tr}(C_2)^2 - \frac{1}{2} \mu^2 \operatorname{tr}(C_2)] + 4p [\lambda \operatorname{tr}(C_3)^2 - \frac{1}{2} \mu^2 \operatorname{tr}(C_3)].$$

Counting neutrinos and imposing broken colour to be commutative leaves only one case, $k = \ell = p = 1$. The fluctuations decouple the ${}^f M_i$ so it is always possible to reach the absolute minimum of the Higgs potential and the triple is degenerate.

Diagram 2 falls in the same way.

Diagram 3 is degenerate in the commutative case and exhibits mass relations in the noncommutative case. The calculation runs along the lines of diagram 8 in [1].

Diagram 4 yields the representation

$$\begin{aligned} \rho_L(a, b, c) &= \begin{pmatrix} c \otimes 1_k & 0 \\ 0 & a \otimes 1_\ell \end{pmatrix}, \quad \rho_R(a, b, c) = \begin{pmatrix} \bar{b} \otimes 1_k & 0 & 0 \\ 0 & \bar{b} \otimes 1_k & 0 \\ 0 & 0 & c \otimes 1_\ell \end{pmatrix}, \\ \rho_L^c(a, b, c) &= \begin{pmatrix} 1_p \otimes a & 0 \\ 0 & 1_k \otimes b \end{pmatrix}, \quad \rho_R^c(a, b, c) = \begin{pmatrix} 1_\ell \otimes a & 0 & 0 \\ 0 & 1_\ell \otimes a & 0 \\ 0 & 0 & 1_p \otimes b \end{pmatrix}, \end{aligned}$$

with possible complex conjugations here and there. The mass matrix is

$$\mathcal{M} = \begin{pmatrix} M_1 \otimes 1_k & M_2 \otimes 1_k & 0 \\ 0 & 0 & M_3 \otimes 1_\ell \end{pmatrix}, \quad M_1, M_2 \in M_{p \times \ell}(\mathbb{C}), \quad M_3 \in M_{k \times p}(\mathbb{C}).$$

The fluctuations are

$$\begin{aligned}
{}^f M_1 &= \sum_j r_j w_j M_1 \bar{v}_j^{-1}, \quad w_j \in U(\mathcal{A}_3), \quad v_j \in U(\mathcal{A}_2), \\
{}^f M_2 &= \sum_j r_j w_j M_2 \bar{v}_j^{-1}, \\
{}^f M_3 &= \sum_j r_j u_j M_3 w_j^{-1}, \quad u_j \in U(\mathcal{A}_1)
\end{aligned}$$

and the action is

$$V(C_1, C_2, C_3) = 4k [\lambda \text{tr}(C_1 + C_2)^2 - \frac{1}{2} \mu^2 \text{tr}(C_1 + C_2)] + 4p [\lambda \text{tr}(C_3)^2 - \frac{1}{2} \mu^2 \text{tr}(C_3)].$$

The neutrino count and broken colour imply $k = \ell = 1$ and $p = 1$ or $p = 2$.

The case $k = \ell = p = 1$ is obviously degenerate.

For $k = \ell = 1, p = 2$ we have one neutrino. ${}^f M_3$ fluctuates independently and can be pushed into the absolute minimum of the Higgs potential. Let us put ${}^f M_1$ and ${}^f M_2$ into one matrix

$${}^f M_{1,2} = \sum_j r_j w_j (M_1, M_2) \begin{pmatrix} \bar{v}_j^{-1} & 0 \\ 0 & \bar{v}_j^{-1} \end{pmatrix}$$

Since the $\bar{v}_j^{-1} \in \mathbb{C}$ they commute with (M_1, M_2) and so

$${}^f M_{1,2} = C(M_1, M_2),$$

where $C \in M_{2 \times 2}(\mathbb{C})$ is an arbitrary matrix. M_1 has to be linearly independent of M_2 because otherwise they would produce a second neutrino. It follows that (M_1, M_2) is invertible and we can choose C to be its inverse. In this way we reach the absolute minimum of the Higgs potential and the triple is degenerate.

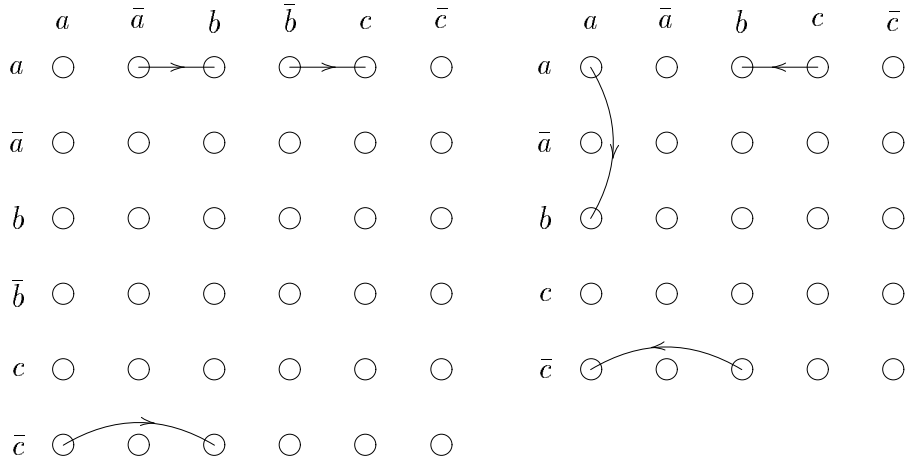

diag. 1

diag. 2

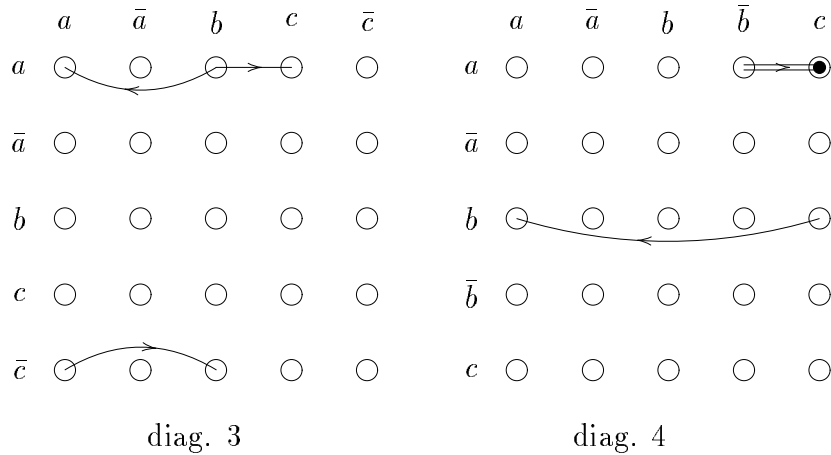

5 Conclusion

The new models discovered with help of the computer complete the proof for up to three algebras given in [1]. We did not find anything of interest from the particle physics point of view but we gained confidence in our algorithm and it seems sensible to compute the case with four algebras.

Acknowledgements: The authors would like to thank T. Schücker for his advice and support. We gratefully acknowledge our fellowships of the Friedrich-Ebert-Stiftung.

References

- [1] B. Iochum, T. Schücker, C. Stephan, “On a Classification of Irreducible Almost Commutative Geometries”, hep-th/0312276, J. Math. Phys. in press
- [2] A. Chamseddine & A. Connes, “The spectral action principle”, hep-th/9606001, Comm. Math. Phys. 182 (1996) 155
- [3] A. Connes, *Noncommutative Geometry*, Academic Press, London and San Diego (1994)
- [4] A. Connes, “Noncommutative geometry and reality”, J. Math. Phys. 36 (1995) 6194
- [5] A. Connes, “Gravity coupled with matter and the foundation of noncommutative geometry”, hep-th/9603053, Comm. Math. Phys. 155 (1996) 109
- [6] A. Connes & J. Lott, “Particle models and noncommutative geometry”, Nucl. Phys. B 18B (1990) 29
A. Connes & J. Lott, “The metric aspect of noncommutative geometry”, in the proceedings of the 1991 Cargèse Summer Conference, eds.: J. Fröhlich et al., Plenum Press (1992)

- [7] T. Krajewski, “Classification of finite spectral triples”, hep-th/9701081, J. Geom. Phys. 28 (1998) 1
- [8] M. Paschke & A. Sitarz, “Discrete spectral triples and their symmetries”, q-alg/9612029, J. Math. Phys. 39 (1998) 6191
- [9] T. Krajewski, “Constraints on scalar potential from spectral action principle”, hep-th/9803199

Finding the Standard Model of Particle Physics A Combinatorial Problem

Jan-Hendrik Jureit^{2, 3, 5} Christoph A. Stephan^{2, 4, 5}

Abstract

We present a combinatorial problem which consists in finding irreducible Krajewski diagrams from finite geometries. This problem boils down to placing arrows into a quadratic array with some additional constraints. The Krajewski diagrams play a central role in the description of finite noncommutative geometries. They allow to localise the standard model of particle physics within the set of all Yang-Mills-Higgs models.

March 2005

¹ Leibnizstraße 15, D-24098 Kiel, Germany

² Université de Provence

³ jureit@cpt.univ-mrs.fr

⁴ stephan@cpt.univ-mrs.fr

⁵ Centre de Physique Théorique Unité Mixte de Recherche (UMR) 6207 du CNRS
et des Universités Aix-Marseille 1 et 2 Sud Toulon-Var, Laboratoire
affilié à la FRUMAM (FR 2291)

1 Introduction

In this paper we present an algebraic problem which has its roots in noncommutative geometry. Given the set of all square matrices $M \in M_n(\mathbb{Z})$, with integer entries and for fixed n . These matrices are called multiplicity matrices. Define a partial order in $M_n(\mathbb{Z})$ by $M \geq M'$ when M_{ij} and M'_{ij} have the same sign and $|M_{ij}| \geq |M'_{ij}|$ for all $i, j = 1, \dots, n$. The task is now to find all the minimal multiplicity matrices which obey two further conditions. First, the determinant of M has to be non-zero. The second condition asserts that for any non vanishing matrix element there has to exist a second element of opposite sign in the same row or in the same column. It is straight forward to translate this problem into a combinatorial problem using diagrammatic language with arrows as basic elements. We will give a simple set of rules how to fit arrows into a quadratic diagram body. The resulting diagrams are called Krajewski diagrams. They can be reduced by combining or “clipping” the arrows in the diagram in accordance with the rules. To each Krajewski diagram a multiplicity matrix will be associated. Our aim will be to find those Krajewski diagrams with a minimal number of arrows that are also as much reduced as possible while the determinant of the multiplicity matrix is non-zero. These diagrams will be called irreducible.

The rules to construct Krajewski diagrams follow directly from Alain Connes non-commutative geometry [3]. They are due to a special class of noncommutative geometries called almost-commutative geometries. These unify the general theory of relativity with the classical field theory of the standard model of particle physics [2]. It is possible to give a complete classification of almost-commutative geometries [5] which can be narrowed under addition of some physical assumptions to a classification of a class of Yang-Mills-Higgs theories. Within these theories the standard model of particle physics takes a most prominent place [1]. For a thorough introduction into the physical application of almost-commutative geometry we refer to [4].

2 Constructing the Diagrams

Our task will now be to construct an algorithm that finds the irreducible Krajewski diagrams. To begin with we will give the basic rules that follow from the axioms of spectral triples and from the requirement of irreducibility. These rules will allow us to generate the diagrams and to perform all the necessary operations.

2.1 Basic Rules

The diagram body: The diagram body is the basis to construct diagrams from. It is a quadratic array of a given size with circles indicating the intersection points or the rows and the columns. These circles have no meaning on their own but are there to guide the eye of the reader. The size of the diagram body will be fixed in advance.

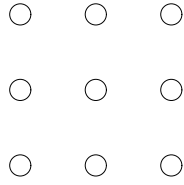

3×3 diagram body

The basic arrow: The basic simple arrow connects two circles of the diagram body. With the end points of an arrow we associate two numbers which are called the chirality. This term stems from noncommutative geometry and corresponds to the chirality of particle physics. A simple arrow points from chirality $+1$ to chirality -1 .

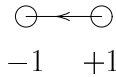

Simple Arrow

Constructing a basic diagram: To construct a basic diagram we put n horizontal arrows in an arbitrary way into the body. Only an antiparallel arrangement of arrows is forbidden.

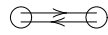

Forbidden antiparallel arrows

Diagrams are sorted by their total number of arrows. The empty diagram (i.e. the diagram body) is said to lie in level 0, the diagrams with one arrow are said to lie in level 1 and so on. For 3×3 diagrams some examples of possible diagrams are:

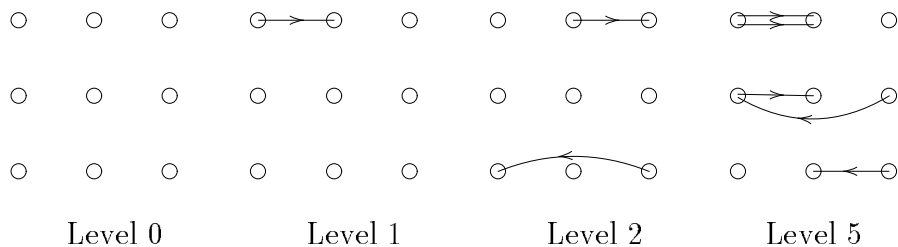

The Multiplicity Matrix: To every diagram a matrix, called the *multiplicity matrix* M , is associated. It is a direct translation of the diagram by taking the values of the chiralities at each end of an arrow. These values are then written into a square matrix

of the same size as the diagram and at the same position as they appear in the diagram. The multiplicity matrix is then this matrix plus its transposed as shown in the following example:

$$\begin{array}{ccc}
 \circ & \circ \rightarrow \circ \\
 \circ & \circ & \circ \\
 \circ & \circ \leftarrow \circ
 \end{array}
 \longrightarrow
 M = \begin{pmatrix} 0 & 1 & -1 \\ 0 & 0 & 0 \\ -1 & 0 & 1 \end{pmatrix} + \begin{pmatrix} 0 & 0 & -1 \\ 1 & 0 & 0 \\ -1 & 0 & 1 \end{pmatrix} = \begin{pmatrix} 0 & 1 & -2 \\ 1 & 0 & 0 \\ -2 & 0 & -2 \end{pmatrix}$$

The multiplicity matrix of a diagram

Clipping two arrows: There are two ways to reduce a diagram. The first is by combining or *clipping* two arrows at a common point with common chirality or by building a corner again with arrow heads of common chirality. This creates a multiple arrow. Building a corner is achieved by transposing one of the arrows (reflecting it on the main diagonal of the diagram) which are to be clipped.

$$\begin{array}{ccc}
 \circ \rightleftarrows \circ & \circ & \bullet \rightleftarrows \circ & \circ & \circ \rightleftarrows \bullet & \circ \\
 \circ & \circ & \circ & \longrightarrow & \circ & \circ & \circ & \circ & \circ & \circ & \circ \\
 \circ & \circ & \circ & & \circ & \circ & \circ & , & \circ & \circ & \circ
 \end{array}$$

$$M = \begin{pmatrix} 4 & -2 & 0 \\ -2 & 0 & 0 \\ 0 & 0 & 0 \end{pmatrix} \longrightarrow M = \begin{pmatrix} 2 & -2 & 0 \\ -2 & 0 & 0 \\ 0 & 0 & 0 \end{pmatrix}, M = \begin{pmatrix} 4 & -1 & 0 \\ -1 & 0 & 0 \\ 0 & 0 & 0 \end{pmatrix}$$

Building a double arrow by clipping two parallel arrows

$$\begin{array}{ccc}
 \circ \rightarrow \circ & \circ & \circ \rightarrow \bullet & \circ \\
 \circ \leftarrow \circ & \circ & \circ & \circ \\
 \circ & \circ & \circ & \circ
 \end{array}
 \longrightarrow
 \begin{array}{ccc}
 \circ \rightarrow \bullet & \circ \\
 \circ & \circ \\
 \circ & \circ & \circ
 \end{array}$$

$$M = \begin{pmatrix} 2 & -2 & 0 \\ -2 & 2 & 0 \\ 0 & 0 & 0 \end{pmatrix} \longrightarrow M = \begin{pmatrix} 2 & -1 & 0 \\ -1 & 2 & 0 \\ 0 & 0 & 0 \end{pmatrix}$$

Building a corner by clipping an arrow and a transposed arrow

The procedure to clip arrows extends in a straight forward way to more than two arrows. One only has to keep in mind to clip the arrows always at the same point in each connected component. Even two multiple arrows can be combined at their clipping points. Clipping arrows will not change the level a diagram belongs to.

Erasing an arrow from a diagram: The second way to reduce a diagram is by erasing an arrow. Erasing an arrow from a diagram is completely trivial and lowers the level of the diagram by one. A simple arrow will be deleted and an arrow which is clipped to another (multiple) arrow will be deleted while leaving the element of the multiplicity matrix at clipping point unaltered:

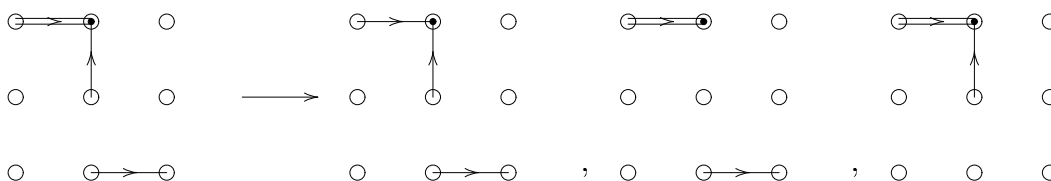

All possibilities to erase one arrow from a diagram

Irreducible Diagrams: A diagram is said to be irreducible if it satisfies two conditions. First, the determinant of the multiplicity matrix has to be non-zero. Second, reducing the diagram by clipping or erasing arrows in all possible ways until one is left with the bare diagram body will on the way always produce diagrams with $\det M = 0$.

The Labels: Every diagram carries a label indicating the reducibility. An ‘i’ stands for an irreducible diagram (the determinant of the multiplicity matrix M is necessarily non-zero). Diagrams which carry an ‘r’ can be reduced to a diagram equipped with an ‘i’ or an ‘r’ ($\det M$ is of no importance). The label ‘0’ is carried by diagrams where the determinant of the multiplicity matrix is zero and which cannot be reduced to diagrams equipped with an ‘r’ or an ‘i’. The labels are of internal use only and we usually do not write them explicitly.

Equivalence of Diagrams: The physical theory following from a diagram is not dependent on the order of the rows and columns or on a reversal of all arrows at once. Permuting the rows and columns together or reversing the arrows does not change the absolute value of the determinant of the multiplicity matrix. Consequently diagrams that differ only by permutations of columns and rows or by reversing the arrows will be regarded as equivalent. All these diagrams build an equivalence class and only one representative will be used for further operations. As an example the following three diagrams are equivalent:

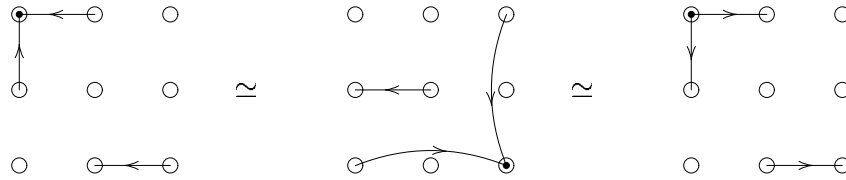

Three equivalent diagrams

With regard to several thousands of diagrams it becomes a very time consuming procedure to directly test all diagrams for possible equivalence. To compare two diagrams the set of arrows of one of the diagrams has to be permuted in all possible ways and reversed. All the resulting diagrams have to be compared to the other diagram. Sorting the diagrams of one level into equivalence classes by direct comparison is most uneconomical.

But there exist invariants of the diagrams. These will provide us with a quicker way to decide whether two diagrams are inequivalent or not. Only if all these invariants prove to be equal for two diagrams it becomes necessary to decide the question of equivalence by permuting and reversing the arrows:

1. Compare directly the arrows of the two diagrams. If the arrows coincide the diagrams are equal and thus equivalent.
2. Compare the absolute values of the determinants of the multiplicity matrices. If they do not coincide the diagrams are inequivalent.
3. Compare the absolute values of the traces of the multiplicity matrices. If they do not coincide the diagrams are inequivalent.
4. Compare the Chern character of the multiplicity matrices. If they do not coincide the diagrams are inequivalent. This Chern character of the multiplicity matrix is defined as $\det(1 + M^2)$.
5. If the two diagrams are not inequivalent by virtue of points 1 to 4, permute and reverse the set of arrows and compare the resulting diagrams.

It is remarkable that the operations of point 1 to 4 are powerful enough to find out in most cases whether two diagrams are inequivalent. This reduces the computation time most considerably.

The Game: With the basic rules formulated above our combinatorial game is to find all the equivalence classes of irreducible Krajewski diagrams for a given size of the diagram body and for a given maximal number of arrows. This seemingly simple task will produce complex structures which we will call *diagram nets*. These nets fall into two categories, the main-nets and the clip-nets. We will now present an algorithm to generate these nets and to find the embedded irreducible Krajewski diagrams.

3 The Algorithm

The algorithm to find the irreducible Krajewski diagrams can be divided into four subalgorithms. Every subalgorithm stands independently but builds up on the data produced by its predecessor. Summarised quickly the subalgorithms achieve the following: The first subalgorithm, dubbed the “main-net subalgorithm” creates a diagram net consisting of all equivalence classes of diagrams with up to N arrows. The “clip-net subalgorithm” creates a diagram net of equivalence classes from every element in the main-net, reducing each diagram by clipping the contained arrows in all possible ways. The third subalgorithm which we call the “label subalgorithm” checks whether the elements of a clip-net represent an irreducible diagram and sets the labels ‘i’, ‘r’ and ‘0’ accordingly. Since the third subalgorithm can only see the elements in a single clip-net the equivalence classes carrying an ‘i’ or a ‘0’ might still be reducible to an element one level below by erasing an arrow. So the last subalgorithm, the “label correction subalgorithm” checks these diagrams on their reducibility and changes their label to ‘r’ if necessary. The output of the whole algorithm are the diagrams labeled with an ‘i’ representing irreducible Krajewski diagrams.

3.1 The Main-Net Subalgorithm

The “main-net subalgorithm” fills the diagram body with up to N simple arrows. The maximal number of arrows, i.e. the maximal level, is chosen before. The arrows are put into the diagram body horizontally in every possible way, excluding only antiparallel arrows. Starting with the empty diagram body level 1 is filled with one horizontal arrow. The resulting diagrams are checked if they are equivalent and only one representative from each equivalence class is kept. In the same way every following level is built from the representative diagrams of the equivalence classes by adding one arrow. Each equivalence class is connected to its predecessors and its successors. Usually an equivalence class has several predecessors.

The subalgorithm to generate the main-net is depicted in flow chart 1 in figure 3. Some explanations to read the flowchart are necessary:

1. N is the maximal number of arrows and is put in by hand.
2. L is the level index from which the diagrams are taken.
3. D_L is an element of the ordered set that contains one representative of each equivalence class on level L . This kind of set is a basic notion in our flow charts. The specific order in the set is arbitrary, its only raison d’être is that the set can be run through from the first to the last element. This notion of ordered set has as its aim to unclutter the flow charts and to eliminate superfluous indices.
4. f_{D_L} is an element of the ordered set that contains all the operators which put one simple arrow into the diagram D_L in an allowed way. Each of these ordered sets is to be understood to belong to the specific diagram D_L that is processed in the current loop.

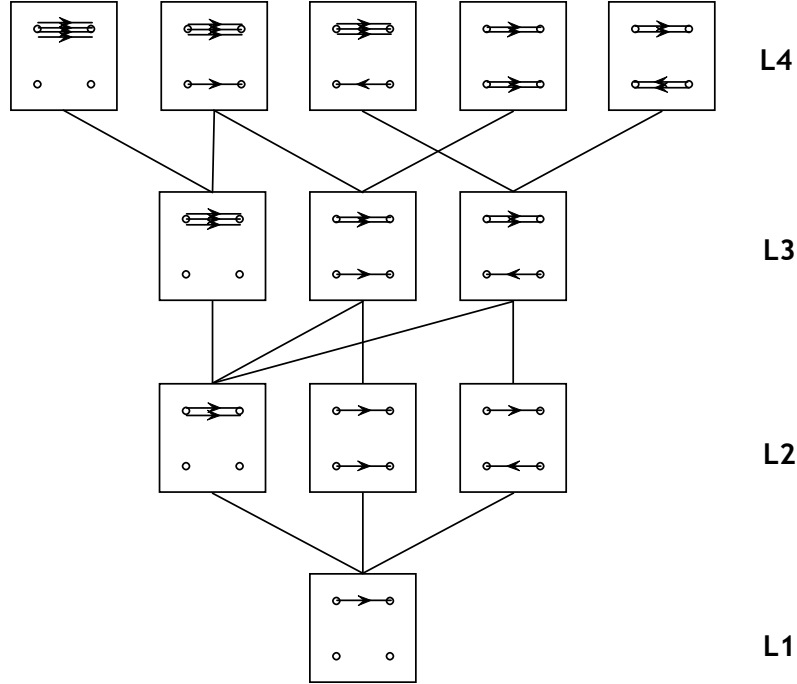

Figure 1: A main-net for a 2×2 diagram with up to four arrows

5. D_{L+1} is the diagram that is generated by putting in an arrow by virtue of the operator f_{D_L} .
6. The equivalence of diagrams is checked making use of the definitions and invariants specified in section 2.1.

An example of a main-net for a 2×2 diagram body with up to four arrows is given in figure 1.

3.2 The Clip-Net Subalgorithm

This algorithm creates a clip-net from each main-net diagram by clipping the arrows in all possible ways. The main-net diagram is said to lie in clip level 0. The diagrams where two arrows have been clipped are said to be in clip level 1, and so on. Each of the diagrams in the clip-nets is again gathered in equivalence classes which are connected with regard to their predecessors and successors. Here a technicality from the noncommutative geometry comes in: Whenever a corner is built by clipping the diagram has to ‘forget’ its predecessor. For a mathematical justification of this rule we refer to [1]. The maximal number of clip levels is determined by the number of arrows in the main-net diagram. If there are L arrows in a diagram there are up to $L - 1$ ways to clip these arrows.

The subalgorithm to generate the clip-net is depicted in flow chart 2 in figure 4. The explanations to read the flowchart are:

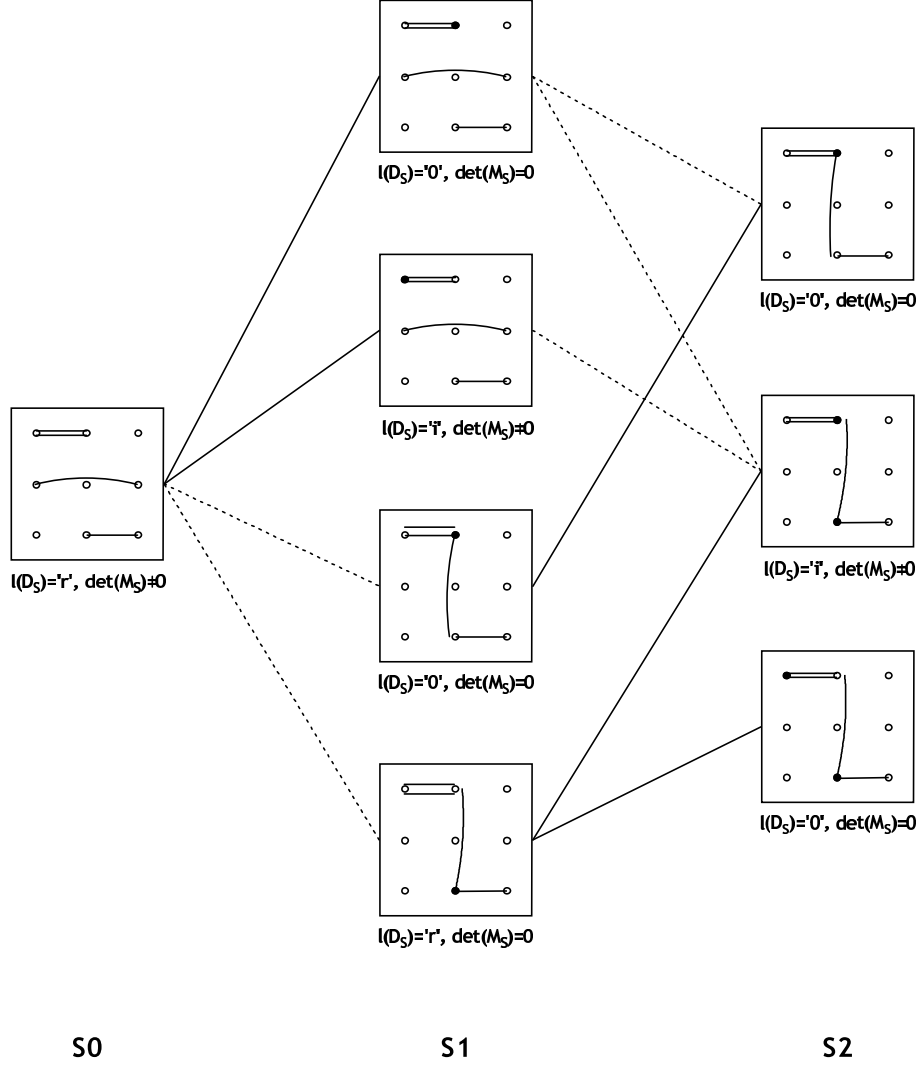

Figure 2: A simplified clip-net with 4 arrows and an example for the labelling

1. The representative of the equivalence class from the main-net is a member of the clip-net. It is the only element on clip level 0.
2. S is the clip level index. It can go up to $L - 1$.
3. D_S is an element of the ordered set of representatives of the equivalence classes of the diagrams in clip-net S .
4. C_{D_S} is an element of the ordered set of operators which clip pairs of arrows in the diagram D_S , if possible. This set can be empty if it is impossible to clip any arrows.
5. D_{S+1} is the diagram produced by applying C_{D_S} to D_S , i.e. by clipping two arrows in D_S .

A simple example of such a clip-net is given by figure 2. Here we have left out the arrows to visualise only the basic structure of a clip-net. The dashed lines represent the forgotten connections due to the building of a corner.

3.3 The Label Subalgorithm

This subalgorithm assigns to each equivalence class in a clip-net one of the labels ‘i’, ‘r’ or ‘0’ (one should not forget that the elements of the main-net are included in the clip-net). For the labels ‘i’ and ‘0’ this assignment is provisional since it might be changed by the “label correction subalgorithm”. The subalgorithm starts with the highest clip level since here the most reduced diagrams are situated. Here the labels are set to ‘i’ or ‘0’ depending on the determinant of the multiplicity matrix of the diagram being non-zero or not. Then the algorithm descends one by one to clip level 0 setting the labels according to the determinant to ‘i’ and ‘0’ or setting the label to ‘r’ if the diagram is connected to a successor with label ‘i’ or ‘r’.

The subalgorithm to label the clip-net is depicted in flow chart 3 in figure 5. The explanations to read the flowchart are:

1. If S is the highest clip level the command “Get label of D_{S+1} ” will always give label ‘0’ the since clip level $S + 1$ does not exist and consequently there are no diagrams D_{S+1} .
2. $l(D_S)$ is the label of the element D_S and takes values ‘i’, ‘0’ or ‘r’.
3. $\text{Det}(M_S)$ represents the determinant of the multiplicity matrix of D_S .

As an example for the labelling of a clip-net we also refer to figure 2. The labels and the determinants are only examples.

3.4 The Label Correction Subalgorithm

Since it may be possible to reduce a diagram carrying label ‘i’ or ‘0’ to a diagram with label ‘i’ or ‘r’ by erasing an arrow, it is necessary to correct these labels. It is evident that only the clip-nets of the predecessors of the main-net diagram are of importance for relabelling. The subalgorithm to relabel the clip-net is depicted in flow chart 4 in figure 6. The explanations to read the flowchart are:

1. $D_S^{0,i}$ is an element of the ordered set of *all* diagrams in the clip-net with label ‘i’ or ‘0’. The relations among the elements in the clip-net are of no importance since the diagrams are directly reduced to diagrams in clip-nets one level below.
2. $R_{D_S^{0,i}}$ is an element of the ordered set of operators that erase one arrow from the diagram $D_S^{0,i}$.
3. $l(D_S^{0,i})$ is the label of the element $D_S^{0,i}$ and takes values ‘i’, ‘0’ or ‘r’.

3.5 Assembling the Algorithm

The main algorithm is composed of the four subalgorithms. Its input is the size of the diagram body and the maximal number of arrows N . The assembly of the algorithm is now straight forward:

Step 1: Use the main-net subalgorithm to create the main-net up to level N .

Step 2: Create for each element in the main-net its clip-net with the clip-net subalgorithm.

Step 3: Starting with level 1 label all clip-nets on this level with the label subalgorithm and afterwards check the labels with the label correction algorithm. Repeat this procedure successively for each level up to N .

Step 4: Print out all the elements with label ‘i’. These are the equivalence classes representing irreducible Krajewski diagrams.

This algorithm runs very quickly on a recent PC with computation times of ca. 20 minutes for 4×4 diagrams and five levels. But the complexity of the nets with their clip-nets grows rapidly with the size of the diagram bodies and the maximal number of arrows.

4 Open Problems

There are two major open problems. The first problem is the question how to choose the maximal number N of arrows to be put into a diagram body. We know that the total number of irreducible Krajewski diagrams is finite, see [1], but we do not know the exact number of such diagrams. Up to now we adopted the simple conjecture that if no diagrams with label ‘i’ appear in two successive levels (say level 4 and level 5 for four algebras), we considered the maximal number of irreducibles as reached. But there is still a possibility of “islands” of irreducible Krajewski diagrams in higher levels. Although we have checked all the elements of the diagram net for 3×3 diagram bodies and can be sure that no more than three levels are necessary, already for 4×4 diagram bodies this is no longer possible. We are therefore looking for a criterion to determine the maximal level for a given size of the diagrams.

The second problem is the rapid increase of computational time and of memory required by the algorithm. We quickly exceed the capabilities of an ordinary personal computer and it will probably be necessary to use some sort of parallel computer or cluster to go beyond 5×5 diagram bodies.

5 Statement of the Result and Conclusions

We presented an algorithm to find irreducible Krajewski diagrams. The rules given here quickly produce very complex nets of diagrams in which the irreducibles are embedded.

One of the most surprising features of these nets is that for 3×3 and 4×4 diagram bodies only some twenty irreducible Krajewski diagrams appear. A complete list of these diagrams can be found in [1]. But already 5×5 diagram bodies produce several hundreds of irreducible diagrams. The order of magnitude of the total number of irreducibles seems to be linked to the minimal number of arrows to produce an irreducible diagram. 3×3 and 4×4 diagrams need two arrows whereas 5×5 diagrams already need three arrows.

The irreducible Krajewski diagrams are a vital ingredient for the classification of almost-commutative geometries from the view point of a particle physicist. From this classification follows the prominent position of the standard model within the Yang-Mills-Higgs theories compatible with noncommutative geometry. To underline the virtue of the algorithm we would like to present the diagram corresponding to the standard model of particle physics:

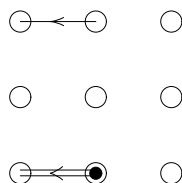

The Krajewski diagram of the standard model

The actual program for the algorithm was written in C^{++} .

Acknowledgements: The authors would like to thank T. Schücker and B. Iochum for their advice and support. We gratefully acknowledge our fellowships of the Friedrich-Ebert-Stiftung.

References

- [1] B. Iochum, T. Schücker, C. Stephan, “On a Classification of Irreducible Almost Commutative Geometries”, hep-th/0312276, J. Math. Phys. in press
 J.-H. Jureit, C. Stephan, “On a Classification of Irreducible Almost Commutative Geometries, a Second Helping”, hep-th/0501134, J. Math. Phys. in press
 J.-H. Jureit, T. Schücker, C. Stephan, “On a Classification of Irreducible Almost Commutative Geometries III”, to be published,
 T. Schücker “Krajewski diagrams and spin lifts”, hep-th/0501181
- [2] A. Chamseddine & A. Connes, “The spectral action principle”, hep-th/9606001, Comm. Math. Phys. 182 (1996) 155
- [3] A. Connes, *Noncommutative Geometry*, Academic Press, London and San Diego (1994)

- [4] T. Schücker, "Forces from Geometry", hep-th/0111236
- [5] T. Krajewski, "Classification of finite spectral triples", hep-th/9701081, J. Geom. Phys. 28 (1998) 1
M. Paschke & A. Sitarz, "Discrete spectral triples and their symmetries", q-alg/9612029, J. Math. Phys. 39 (1998) 6191

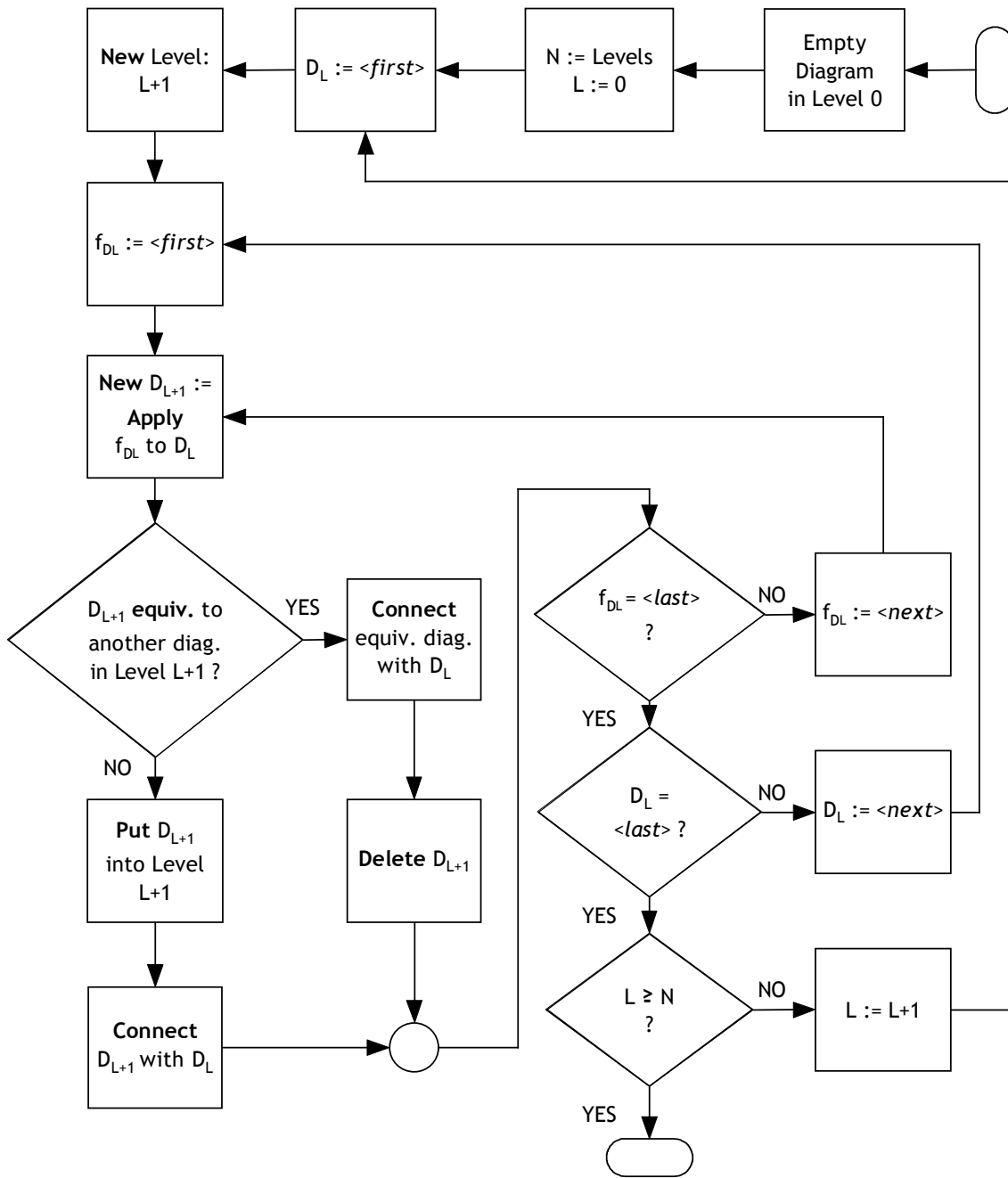

Figure 3: The Main-Net Subalgorithm

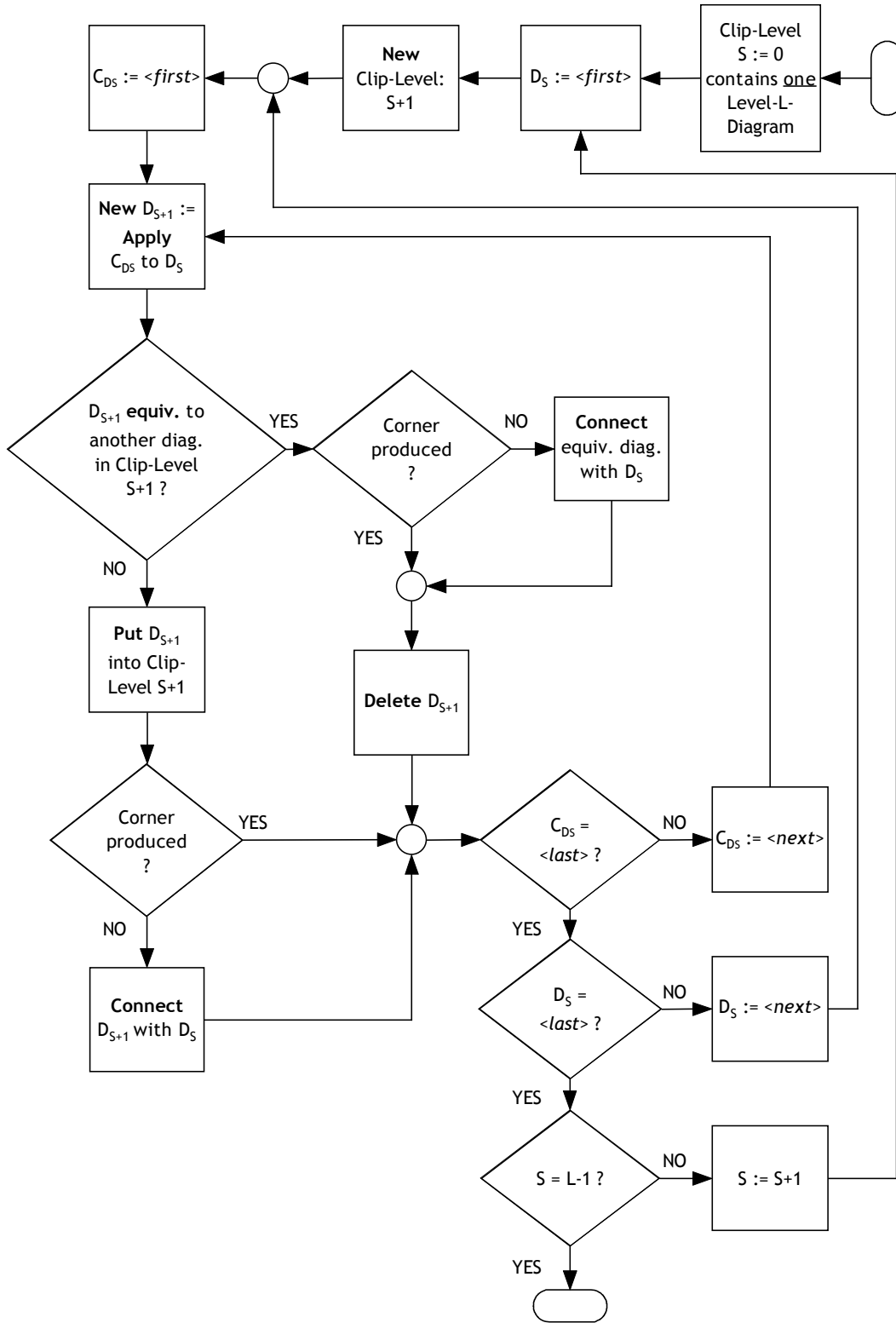

Figure 4: The Clip-Net Subalgorithm

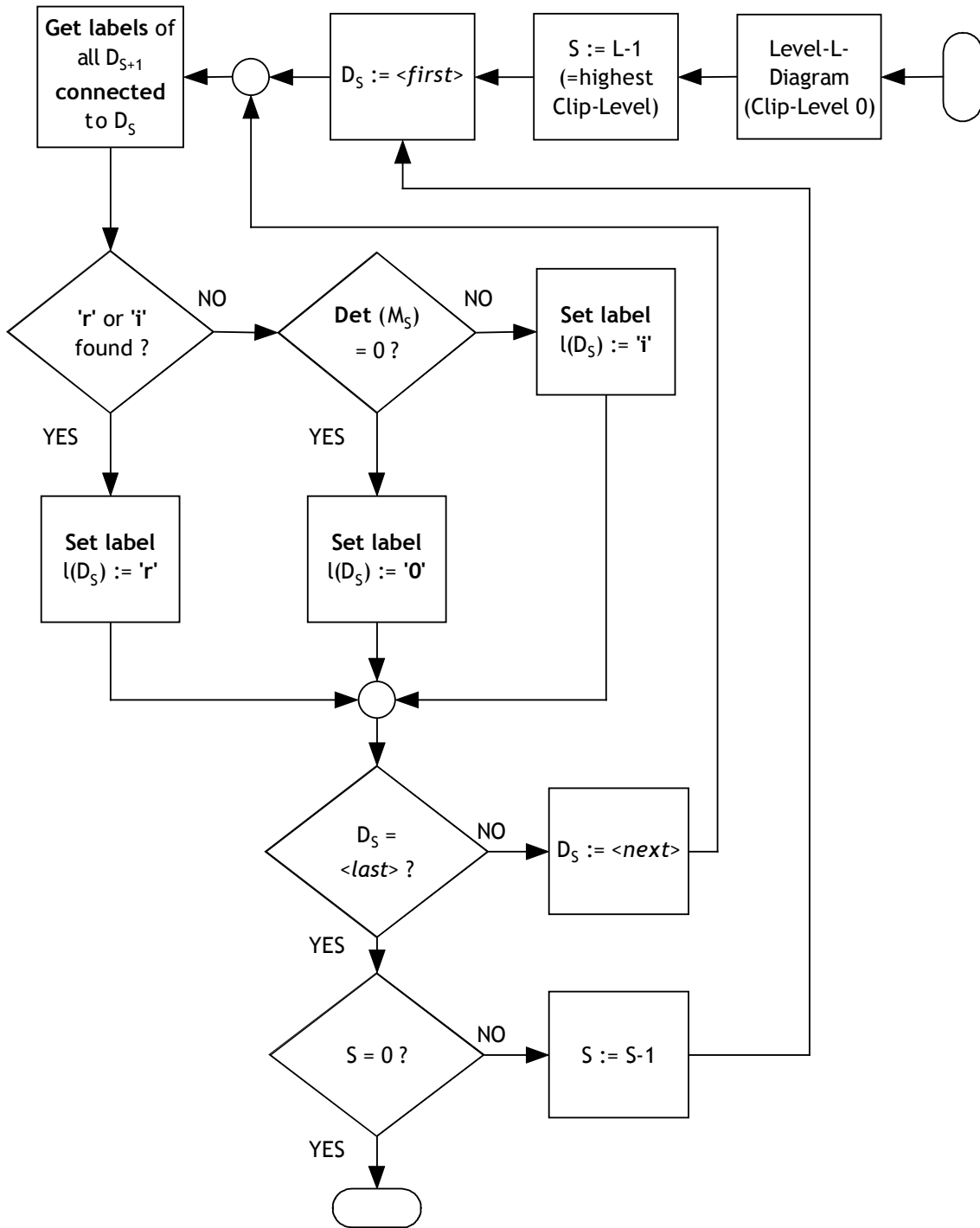

Figure 5: The Label Subalgorithm

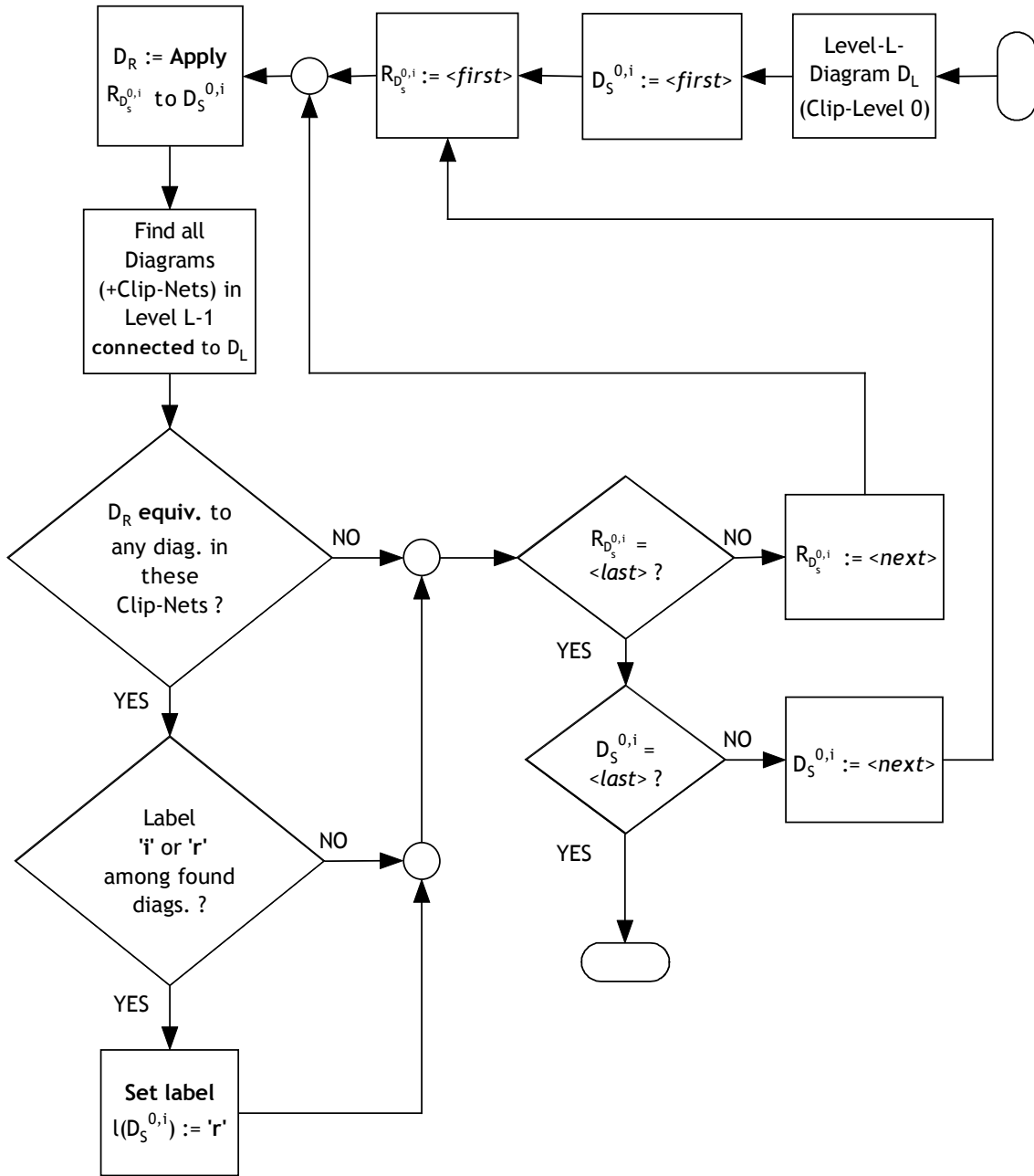

Figure 6: The Label Correction Subalgorithm

CENTRE DE PHYSIQUE THÉORIQUE ¹
CNRS–Luminy, Case 907
13288 Marseille Cedex 9
FRANCE

On a Classification of Irreducible Almost Commutative Geometries III

Jan–Hendrik Jureit ², Thomas Schücker ³, Christoph Stephan ⁴

Abstract

We extend a classification of irreducible, almost commutative geometries whose spectral action is dynamically non-degenerate to internal algebras that have four simple summands.

PACS-92: 11.15 Gauge field theories
MSC-91: 81T13 Yang-Mills and other gauge theories

CPT-2005/P.015

¹ Unité Mixte de Recherche (UMR 6207) du CNRS et des Universités Aix–Marseille 1 et 2 et Sud Toulon–Var, Laboratoire affilié à la FRUMAM (FR 2291)

² and Université de Provence and Universität Kiel,
jureit@cpt.univ-mrs.fr

³ and Université de Provence,
schucker@cpt.univ-mrs.fr

⁴ and Université de Provence and Universität Kiel,
stephan@cpt.univ-mrs.fr

1 Introduction

A Yang-Mills-Higgs model is specified by choosing a real compact Lie group describing the gauge bosons and three unitary representations describing the left- and right-handed fermions and the Higgs scalars. Connes [1] remarks that the set of all Yang-Mills-Higgs models comes in two classes, fig.1. The first is tiny and contains all those models that derive from gravity by generalizing Riemannian to almost commutative geometry. The intersections of this tiny class with the classes of left-right symmetric, grand unified or supersymmetric Yang-Mills-Higgs models are all empty. However the tiny class does contain the standard model of electromagnetic, weak and strong forces with an arbitrary number of colours.

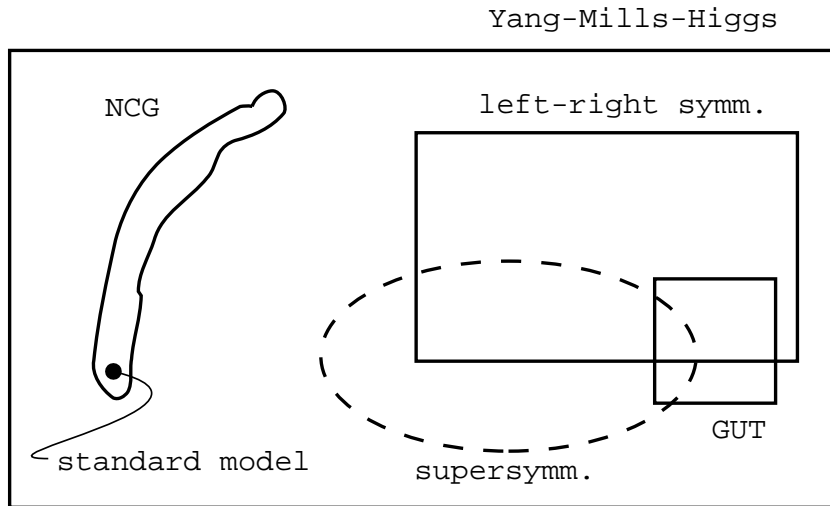

Figure 1: Pseudo forces from noncommutative geometry

The first class is tiny, but still infinite and difficult to assess. We have started putting some order into this class. The criteria we apply are heteroclitic [2].

Two criteria are simply motivated by simplicity: we take the internal algebra to be simple, or with two, three,... simple summands, we take the internal triple to be irreducible.

Two criteria are motivated from perturbative quantum field theory of the non-gravitational part in flat timespace: vanishing Yang-Mills anomalies and dynamical non-degeneracy. The later imposes that the number of possible fermion mass equalities be restricted to the minimum and that they be stable under renormalization flow. The origin of these mass equalities is the following. In almost commutative geometry, the fermionic mass matrix is the ‘Riemannian metric’ of internal space and as such becomes a dynamical variable. Its ‘Einstein equation’ is the requirement that the fermionic mass matrix minimize the Higgs potential. Indeed, in almost commutative geometry, the Higgs potential is the ‘Einstein-Hilbert action’ of internal space.

Two criteria are motivated from particle phenomenology: We want the fermion representation to be complex under the little group in each of its irreducible components,

because we want to distinguish particles from anti-particles by means of unbroken charges. We want possible massless fermions to remain neutral under the little group, i.e. not to couple to massless gauge bosons.

Two criteria are motivated from the hope that, one day, we will have a unified quantum theory of all forces: vanishing mixed gravitational Yang-Mills anomalies and again dynamical non-degeneracy.

Our analysis is based on a classification of all finite spectral triples by means of Krajewski diagrams [3] and centrally extended spin lifts of the automorphism group of their algebras [4]. The central extension serves two purposes: (i) It makes the spin lift of complex algebras $M_n(\mathbb{C})$ well defined. (ii) It allows the corresponding $U(n)$ anomalies to cancel.

Of course we started with the case of a simple internal algebra. Here there is only one contracted, irreducible Krajewski diagram and all induced Yang-Mills-Higgs models are dynamically degenerate.

The second case concerns algebras with two simple summands. It admits three contracted, irreducible Krajewski diagrams, one of them being a direct sum of two diagrams from the first case. The corresponding triples induce two Yang-Mills-Higgs models which are dynamically non-degenerate and anomaly free: $SU(2)$ with a doublet of left-handed fermions and a singlet of right-handed fermions. The Higgs scalar is a doublet. Therefore the little group is trivial, $SU(2) \rightarrow \{1_2\}$, and the fermion representation is real under the little group. The second model is the $SO(2)$ submodel of the first.

The case of three summands has 41 contracted, irreducible diagrams plus direct sums. Its combinatorics is on the limit of what we can handle without a computer. There are only four induced models satisfying all criteria: The first is the standard model with C colours, $C \geq 2$, $SU(2) \times U(1) \times SU(C)$, with one generations of leptons and quarks and one colourless $SU(2)$ doublet of scalars. The three others are submodels, $SO(2) \times U(1) \times SU(C)$, $SU(2) \times U(1) \times SO(C)$ and $SU(2) \times U(1) \times USp(C/2)$ and must have $C \geq 2$, the last submodel of course requires C even, $C \geq 4$.

In the following we push our classification to four summands. For simplicity we will only consider diagrams made of letter changing arrows, i.e. we exclude arrows of type $a \bar{a}$ because in the first three cases these arrows always produced degeneracy. When the algebra is simple, of course all arrows are of this type and all models were degenerate. All direct sum diagrams in cases two and three necessarily contain such arrows. For two summands, there is only one contracted, irreducible diagram, that is not a direct sum and that is made of letter changing arrows, for three summands there are 30 such diagrams.

For four summands, a well educated computer [5] tells us that there are 22 contracted, irreducible diagrams made of letter changing arrows and which are not direct sums. They are shown in fig.2. We have two pleasant surprises: (i) the number of these diagrams is small, (ii) there are only two ladder diagrams, diagrams 18 and 19, i.e. diagrams with vertically aligned arrows, and all other diagrams have no subdiagrams of ladder form. We will see that these other diagrams are easily dealt with.

2 Statement of the result

Consider a finite, real, S^0 -real, irreducible spectral triple whose algebra has four simple summands and the extended lift as described in [4]. Consider the list of all Yang-Mills-Higgs models induced by these triples and lifts. Discard all models that have either

- a dynamically degenerate fermionic mass spectrum,
- Yang-Mills or gravitational anomalies,
- a fermion multiplet whose representation under the little group is real or pseudo-real,
- or a massless fermion transforming non-trivially under the little group.

The remaining models are the following, C is the number of colours, the gauge group is on the left-hand side of the arrow, the little group on the right-hand side:

$C = 3, 5, \dots$

$$\frac{SU(2) \times U(1) \times SU(C)}{\mathbb{Z}_2 \times \mathbb{Z}_C} \longrightarrow \frac{U(1) \times SU(C)}{\mathbb{Z}_C}$$

The left-handed fermions transform according to a multiplet $\underline{2} \otimes \underline{C}$ with hypercharge $q/(2C)$ and a multiplet \underline{C} with hypercharge $-q/2$. The right-handed fermions sit in two multiplets \underline{C} with hypercharges $q(1+C)/(2C)$ and $q(1-C)/(2C)$ and one singlet with hypercharge $-q$, $q \in \mathbb{Q}$. The elements in $\mathbb{Z}_2 \times \mathbb{Z}_C$ are embedded in the center of $SU(2) \times U(1) \times SU(C)$ as

$$\left(\exp \frac{2\pi i k}{2} 1_2, \exp[2\pi i(Ck - 2\ell)/q], \exp \frac{2\pi i \ell}{C} 1_p \right), \quad k = 0, 1, \quad \ell = 0, 1, \dots, C-1.$$

The Higgs scalar transforms as an $SU(2)$ doublet, $SU(C)$ singlet and has hypercharge $-q/2$.

With the number of colours $C = 3$, this is the standard model with one generation of quarks and leptons.

We also have in our list two submodels of the above model defined by the subgroups

$$\frac{SO(2) \times U(1) \times SU(C)}{\mathbb{Z}_2 \times \mathbb{Z}_C} \longrightarrow \frac{U(1) \times SU(C)}{\mathbb{Z}_C},$$

$$\frac{SU(2) \times U(1) \times SO(C)}{\mathbb{Z}_2} \longrightarrow U(1) \times SO(C).$$

They have the same particle content as the standard model, in the first case only the W^\pm bosons are missing, in the second case roughly half the gluons are lost.

$C = 2, 4, \dots$

$$\frac{SU(2) \times U(1) \times SU(C)}{\mathbb{Z}_C} \longrightarrow \frac{U(1) \times SU(C)}{\mathbb{Z}_C}$$

with the same particle content as for odd C . But now we have three possible submodels:

$$\frac{SO(2) \times U(1) \times SU(C)}{\mathbb{Z}_C} \longrightarrow \frac{U(1) \times SU(C)}{\mathbb{Z}_C},$$

$$SU(2) \times U(1) \times SO(C) \longrightarrow U(1) \times SO(C),$$

$$\frac{SU(2) \times U(1) \times USp(C/2)}{\mathbb{Z}_2} \longrightarrow \frac{U(1) \times USp(C/2)}{\mathbb{Z}_2}.$$

electro-strong

$$U(1) \times SU(C) \longrightarrow U(1) \times SU(C)$$

The fermionic content is $\underline{C} \oplus \underline{1}$, one quark and one charged lepton. The two fermion masses are arbitrary but different and nonvanishing. The number of colours is greater than or equal to two, the two charges are arbitrary but vectorlike, of course the lepton charge must not vanish. There is no scalar and no symmetry breaking.

3 Diagram by diagram

We will use the following letters to denote algebra elements and unitaries: Let $\mathcal{A} = M_A(\mathbb{C}) \oplus M_B(\mathbb{C}) \oplus M_C(\mathbb{C}) \oplus M_D(\mathbb{C}) \ni (a, b, c, d)$. The extended lift is defined by

$$L(u, v, w, z) := \rho(\hat{u}, \hat{v}, \hat{w}, \hat{z}) J \rho(\hat{u}, \hat{v}, \hat{w}, \hat{z}) J^{-1} \quad (1)$$

with

$$\hat{u} := u (\det u)^{q_{11}} (\det v)^{q_{12}} (\det w)^{q_{13}} (\det z)^{q_{14}} \in U(A), \quad (2)$$

$$\hat{v} := v (\det u)^{q_{21}} (\det v)^{q_{22}} (\det w)^{q_{23}} (\det z)^{q_{24}} \in U(B), \quad (3)$$

$$\hat{w} := w (\det u)^{q_{31}} (\det v)^{q_{32}} (\det w)^{q_{33}} (\det z)^{q_{34}} \in U(C), \quad (4)$$

$$\hat{z} := z (\det u)^{q_{41}} (\det v)^{q_{42}} (\det w)^{q_{43}} (\det z)^{q_{44}} \in U(D), \quad (5)$$

and unitaries $(u, v, w, z) \in U(M_A(\mathbb{C}) \oplus M_B(\mathbb{C}) \oplus M_C(\mathbb{C}) \oplus M_D(\mathbb{C}))$. It is understood that for instance if $A = 1$ we set $u = 1$ and $q_{j1} = 0$, $j = 1, 2, 3, 4$. If $M_A(\mathbb{C})$ is replaced by $M_A(\mathbb{R})$ or $M_{A/2}(\mathbb{H})$ we set $q_{j1} = 0$ and $q_{1j} = 0$.

Diagram 1 yields:

$$\rho_L = \begin{pmatrix} b \otimes 1_A & 0 \\ 0 & d \otimes 1_C \end{pmatrix}, \quad \rho_R = \begin{pmatrix} a \otimes 1_A & 0 \\ 0 & \alpha a \otimes 1_C \end{pmatrix},$$

$$\rho_L^c = \begin{pmatrix} 1_B \otimes \alpha' a & 0 \\ 0 & 1_D \otimes c \end{pmatrix}, \quad \rho_R^c = \begin{pmatrix} 1_A \otimes \alpha' a & 0 \\ 0 & 1_A \otimes c \end{pmatrix}, \quad (6)$$

and

$$\mathcal{M} = \begin{pmatrix} M_1 \otimes 1_A & 0 \\ 0 & M_2 \otimes 1_C \end{pmatrix}, \quad M_1 \in M_{B \times A}(\mathbb{C}), \quad M_2 \in M_{D \times A}(\mathbb{C}). \quad (7)$$

The parameters α and α' take values ± 1 and distinguish between fundamental representation and its complex conjugate: ${}^1 a := a$, ${}^{-1} a := \bar{a}$. The colour algebras consist of as and cs . The as are broken and therefore we must have $A = 1$. We want at most one massless Weyl fermion, which leaves us with three possibilities. The first is $B = 2$, $D = 1$. The fluctuations read:

$$\varphi_1 = \sum_j r_j \hat{v}_j M_1 \hat{u}_j^{-1}, \quad \varphi_2 = \sum_j r_j \hat{z}_j M_2 \alpha \hat{u}_j^{-1}. \quad (8)$$

We can decouple the two scalars φ_1 and φ_2 by means of the fluctuation: $r_1 = \frac{1}{2}$, $\hat{u}_1 = 1$, $\hat{v}_1 = 1_2$, $\hat{w}_1 = 1_C$, $\hat{z}_1 = 1$, $r_2 = \frac{1}{2}$, $\hat{u}_2 = 1$, $\hat{v}_2 = -1_2$, $\hat{w}_2 = 1_C$, $\hat{z}_2 = 1$. Since the arrows M_1 and M_2 are disconnected, the Higgs potential is a sum of a potential in φ_1 and of a potential in φ_2 . The minimum is $\hat{\varphi}_1 = \mu(4\lambda)^{-\frac{1}{2}} \begin{pmatrix} 1 \\ 0 \end{pmatrix}$ and $\hat{\varphi}_2 = \mu(4\lambda)^{-\frac{1}{2}}$ and the model is dynamically degenerate. The same accidents happen for the second possibility, $B = 1$, $D = 2$. We are left with the third possibility, $B = D = 1$. Anomaly cancellations imply that the fermion couplings are vectorial: $q_{13} = q_{23}$, $q_{43} = \alpha q_{13}$, and there is no spontaneous symmetry breaking, $SU(C) \times U(1) \rightarrow SU(C) \times U(1)$. The model describes electro-strong forces with one charged lepton, one quark and no scalar. The masses of both fermions are arbitrary but nonvanishing, the electric charges are arbitrary, nonvanishing for the lepton, and the number of colours C is arbitrary, $C \geq 2$.

Diagrams 3, 4 and 7 are treated in the same way and produce only the electro-strong model.

Diagram 2 yields:

$$\rho_L = \begin{pmatrix} b \otimes 1_A & 0 \\ 0 & \alpha a \otimes 1_C \end{pmatrix}, \quad \rho_R = \begin{pmatrix} a \otimes 1_A & 0 \\ 0 & d \otimes 1_C \end{pmatrix},$$

$$\rho_L^c = \begin{pmatrix} 1_B \otimes \alpha' a & 0 \\ 0 & 1_A \otimes c \end{pmatrix}, \quad \rho_R^c = \begin{pmatrix} 1_A \otimes \alpha' a & 0 \\ 0 & 1_D \otimes c \end{pmatrix}, \quad (9)$$

and

$$\mathcal{M} = \begin{pmatrix} M_1 \otimes 1_A & 0 \\ 1_A \otimes M_3 & M_2 \otimes 1_C \end{pmatrix}, \quad M_1 \in M_{B \times A}(\mathbb{C}), \quad M_2 \in M_{A \times D}(\mathbb{C}), \quad M_3 \in M_{C \times A}(\mathbb{C}). \quad (10)$$

If $M_3 = 0$ diagram 2 is treated as diagram 1. We consider the case $M_3 \neq 0$. Then the first order axiom implies $\alpha = 1$. The colour algebras consist of as and cs . Both are broken and we take $A = C = 1$. Then \mathcal{M} is of rank two or less. If we want at most one massless Weyl fermion, we must take $B = 2$ and $D = 1$ or $B = 1$ and $D = 2$. Anomaly cancellations then imply that the doublet of fermions does not couple to the determinant of the 2×2 unitary, ‘the hypercharge of the doublet is zero’. On the other hand the little group turns out either trivial or $U(1)$. In the latter case the neutrino sitting in the doublet is charged under this $U(1)$.

Diagram 5 has no unbroken colour and fails as the first possibility of diagram 1, $B = 2$, $D = 1$.

Diagram 6 has colour a and b , both are broken implying $A = B = 1$. Then we must have $C = D = 1$ to avoid two or more neutrinos.

Diagram 8 yields

$$\begin{aligned}\rho_L &= \begin{pmatrix} a \otimes 1_C & 0 \\ 0 & c \otimes 1_B \end{pmatrix}, & \rho_R &= \begin{pmatrix} a \otimes 1_A & 0 \\ 0 & d \otimes 1_C \end{pmatrix}, \\ \rho_L^c &= \begin{pmatrix} 1_A \otimes \gamma c & 0 \\ 0 & 1_C \otimes b \end{pmatrix}, & \rho_R^c &= \begin{pmatrix} 1_A \otimes b & 0 \\ 0 & 1_D \otimes b \end{pmatrix},\end{aligned}\tag{11}$$

and

$$\mathcal{M} = \begin{pmatrix} 1_A \otimes M_1 & 0 \\ M_3 \otimes 1_B & M_2 \otimes 1_B \end{pmatrix}, \quad M_1 \in M_{C \times B}(\mathbb{C}), \quad M_2 \in M_{C \times D}(\mathbb{C}), \quad M_3 \in M_{C \times A}(\mathbb{C}).\tag{12}$$

We suppose that M_3 does not vanish otherwise diagram 8 is treated as diagram 1. Broken colour implies $A = B = 1$. Neutrino counting leaves two possibilities, $C = 1$ and $D = 2$ or $C = D = 2$. The first possibility is disposed of as in diagram 2. For the second possibility, anomaly cancellations imply that the determinants of the 2×2 unitaries w and z do not couple to the right-handed fermions.

Diagrams 14, 15, 16 and **17** share the fate of diagram 6.

Diagram 9 yields

$$\begin{aligned}\rho_L &= \begin{pmatrix} b \otimes 1_A & 0 & 0 \\ 0 & c \otimes 1_B & 0 \\ 0 & 0 & d \otimes 1_D \end{pmatrix}, & \rho_R &= \begin{pmatrix} a \otimes 1_A & 0 & 0 \\ 0 & \beta_1 b \otimes 1_B & 0 \\ 0 & 0 & \beta_2 b \otimes 1_D \end{pmatrix}, \\ \rho_L^c &= \begin{pmatrix} 1_B \otimes \alpha' a & 0 & 0 \\ 0 & 1_C \otimes \beta' b & 0 \\ 0 & 0 & 1_D \otimes \delta' d \end{pmatrix}, & \rho_R^c &= \begin{pmatrix} 1_A \otimes \alpha' a & 0 & 0 \\ 0 & 1_B \otimes \beta' b & 0 \\ 0 & 0 & 1_B \otimes \delta' d \end{pmatrix},\end{aligned}$$

and

$$\mathcal{M} = \begin{pmatrix} M_1 \otimes 1_A & 1_B \otimes M_4 & 1_B \otimes M_5 \\ 0 & M_2 \otimes 1_B & 0 \\ 0 & 0 & M_3 \otimes 1_D \end{pmatrix} \quad (13)$$

with $M_1 \in M_{B \times A}(\mathbb{C})$, $M_2 \in M_{C \times D}(\mathbb{C})$, $M_3 \in M_{D \times B}(\mathbb{C})$, $M_4 \in M_{A \times B}(\mathbb{C})$, $M_5 \in M_{A \times D}(\mathbb{C})$. If M_4 is nonzero β_1 must be one and if M_5 is nonzero β_2 must be one. From broken colour and neutrino counting we have $A = B = D = 1$ and $C = 2$. Vanishing anomalies imply that the first and the third fermion have vectorlike hypercharges, while the hypercharges of the second fermion are zero. It is therefore neutral under the little group $U(1)$.

Diagrams 10, 11, 12 and 13 fail in the same way.

Diagram 18 produces the following triple:

$$\rho_L = \begin{pmatrix} a \otimes 1_C & 0 \\ 0 & \alpha a \otimes 1_D \end{pmatrix}, \quad \rho_R = \begin{pmatrix} b \otimes 1_C & 0 & 0 \\ 0 & \beta_1 \bar{b} \otimes 1_C & 0 \\ 0 & 0 & \beta_2 \bar{b} \otimes 1_D \end{pmatrix},$$

$$\rho_L^c = \begin{pmatrix} 1_A \otimes c & 0 \\ 0 & 1_A \otimes d \end{pmatrix}, \quad \rho_R^c = \begin{pmatrix} 1_B \otimes c & 0 & 0 \\ 0 & 1_B \otimes c & 0 \\ 0 & 0 & 1_B \otimes d \end{pmatrix},$$

and

$$\mathcal{M} = \begin{pmatrix} M_1 \otimes 1_C & M_2 \otimes 1_C & 0 \\ 0 & 0 & M_3 \otimes 1_D \end{pmatrix}, \quad M_1, M_2, M_3 \in M_{A \times B}(\mathbb{C}). \quad (14)$$

Counting neutrinos leaves two possibilities, $A = 2$ and $B = 1$, or $A = 1$ and $B = 1$. If the neutrino is to be neutral under the little group we must have $D = 1$ for the first possibility and $C = 1$ for the second.

The first possibility has two $U(1)$ s if $C \geq 2$ and all four algebras consist of matrices with complex entries. They are parameterized by $\det u$ and by $\det w$. For $(\alpha, \beta_1, \beta_2) = + + +, - + +, + + -, \text{ and } - + -$, anomaly cancellations imply that the fermionic hypercharges of both $U(1)$ s are proportional:

$$q_{11} = -\frac{1}{2}, \quad q_{21} = Cp, \quad q_{31} = p, \quad q_{41} = -Cp, \quad (15)$$

$$q_{13} = 0, \quad q_{23} = Cq, \quad q_{33} = q - \frac{1}{C}, \quad q_{43} = -Cq, \quad (16)$$

with $p, q \in \mathbb{Q}$. Consequently one linear combination of the two generators decouples from the fermions and is absent from the spectral action. This is similar to what happens to the scalar in the electro-strong model of diagram 1. The hypercharges of the remaining generator are those of the standard model with C colours. In the remaining four cases $(\alpha, \beta_1, \beta_2) = + - +, - - +, + - -, \text{ and } - - -$, all 10 fermionic hypercharges vanish and the three leptons are neutral under the little group. Finally the cases where some of the

four summands consist of matrices with real or quaternionic entries are treated as in the situation with three summands and they produce the same submodels of the standard model.

The first possibility with $C = 1$ has only one $U(1)$. For the four sign assignments: $(\alpha, \beta_1, \beta_2) = + + +, - + +, + + -, \text{ and } - + -$, we find anomaly free lifts with non-trivial little group. E.g. for the first assignment, we get $q_{11} = -1/2, q_{21} = p, q_{31} = -p$, and $q_{41} = -p$, with $p \in \mathbb{Q}$. All four assignments produce the electro-weak model $(SU(2) \times U(1))/\mathbb{Z}_2 \rightarrow U(1)$ of protons, neutrons, neutrinos and electrons.

The second possibility, $A = B = C = 1$, contains at least one chiral lepton with vanishing hypercharge and therefore neutral under the little group.

Diagram 19 gives the same results as diagram 18.

In **diagrams 20, 21** and **22**, the elements a and b must be matrices with complex entries to allow for conjugate representations. Without both the fundamental representation and its complex conjugate these diagrams would violate the condition that every nonvanishing entry of the multiplicity matrix of a (blown up) Krajewski diagram must have the same sign as its transposed element if the latter is not zero. Diagram 20 is treated and fails as diagram 2, diagrams 21 and 22 are treated and fail as diagram 13.

At this point we have exhausted all diagrams of figure 2.

4 Conclusion and outlook

For three summands there was essentially one irreducible spectral triple satisfying all items on our shopping list: the standard model with one generation of quarks and leptons and an arbitrary number of colours (greater than or equal to two). We say ‘essentially’ because a few submodels of the standard model can be obtained. Going to four summands adds precisely one model, the electro-strong model for one massive quark with an arbitrary number of colours and one massive, charged lepton. Note that this is the first appearance of a spectral triple without any Higgs scalar and without symmetry breaking.

We still have to prove that spectral triples in four summands involving letter preserving arrows like $a \bar{a}$ do not produce any model compatible with our shopping list.

We are curious to know what happens in five (and more) summands. Here ladder diagrams do not exist and we may speculate that our present list of models exhausts our shopping list also in any number of summands.

Anyhow two questions remain: Who ordered three colours? Who ordered three generations?

References

- [1] A. Connes, *Noncommutative Geometry*, Academic Press (1994)
A. Connes, *Noncommutative geometry and reality*, J. Math. Phys. 36 (1995) 6194

- A. Connes, *Gravity coupled with matter and the foundation of noncommutative geometry*, hep-th/9603053, Comm. Math. Phys. 155 (1996) 109
- A. Chamseddine & A. Connes, *The spectral action principle*, hep-th/9606001, Comm. Math. Phys. 182 (1996) 155
- [2] B. Iochum, T. Schücker & C. Stephan, *On a classification of irreducible almost commutative geometries*, hep-th/0312276, *J. Math. Phys.*, in press
 J.-H. Jureit & C. Stephan, *On a classification of irreducible almost commutative geometries, a second helping*, hep-th/0501134, *J. Math. Phys.*, in press
 T. Schücker, *Krajewski diagrams and spin lifts*, hep-th/0501181
- [3] M. Paschke & A. Sitarz, *Discrete spectral triples and their symmetries*, q-alg/9612029, *J. Math. Phys.* 39 (1998) 6191
 T. Krajewski, *Classification of finite spectral triples*, hep-th/9701081, *J. Geom. Phys.* 28 (1998) 1
- [4] S. Lazzarini & T. Schücker, *A farewell to unimodularity*, hep-th/0104038, *Phys.Lett. B* 510 (2001) 277
- [5] J.-H. Jureit & C. Stephan, *Finding the standard model of particle physics, a combinatorial problem*, hep-th/0503085

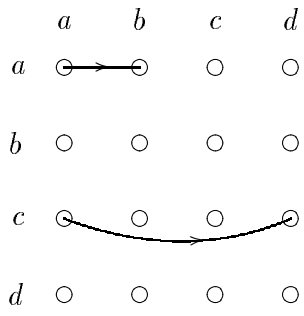

diag. 1

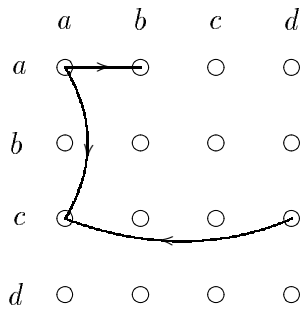

diag. 2

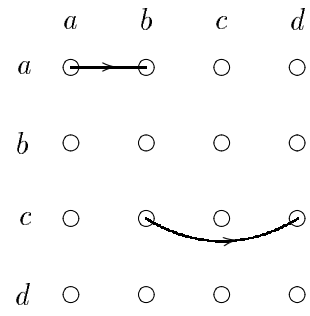

diag. 3

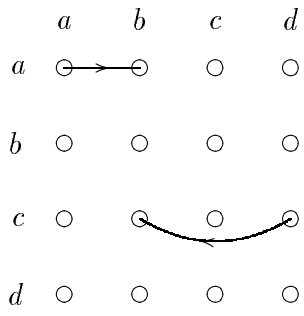

diag. 4

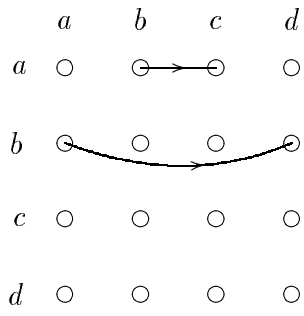

diag. 5

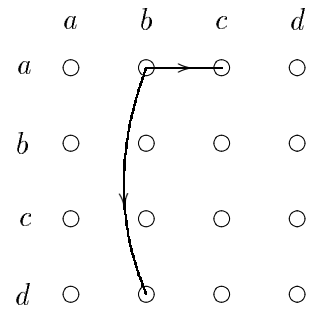

diag. 6

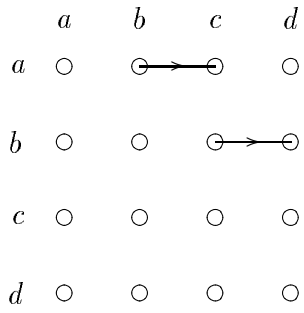

diag. 7

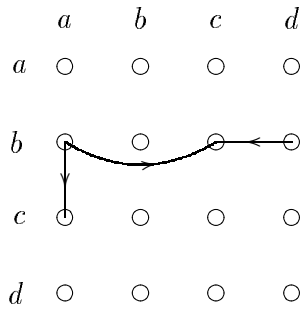

diag. 8

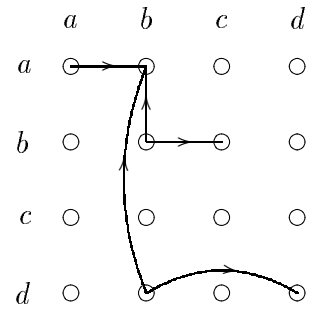

diag. 9

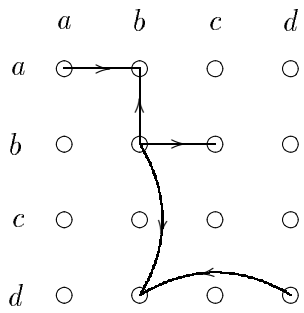

diag. 10

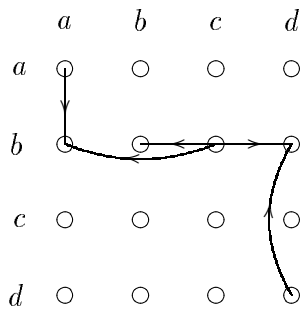

diag. 11

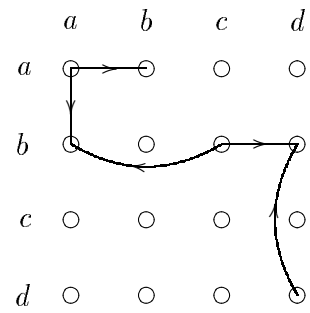

diag. 12

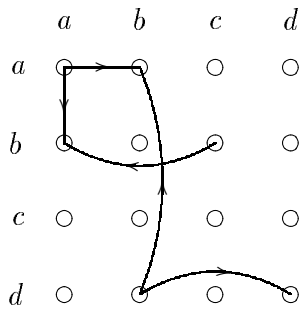

diag. 13

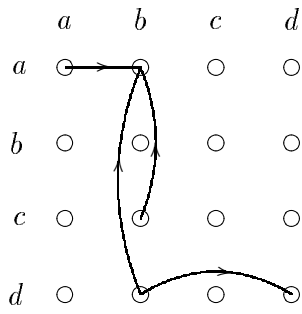

diag. 14

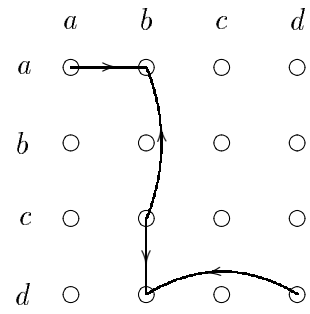

diag. 15

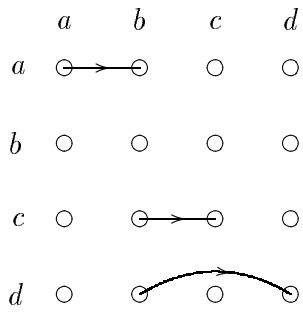

diag. 16

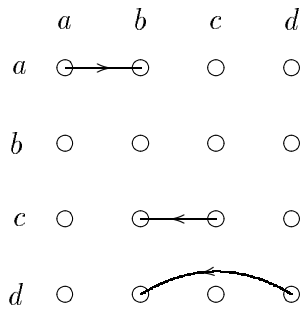

diag. 17

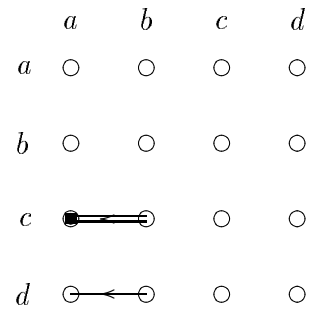

diag. 18

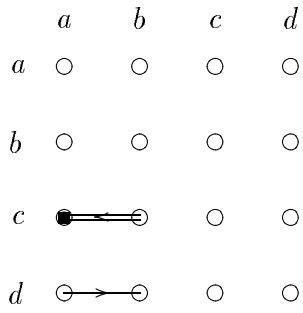

diag. 19

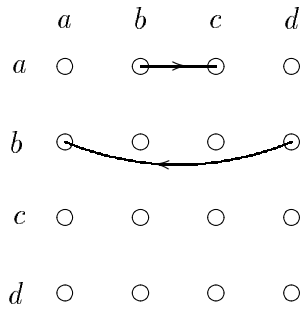

diag. 20

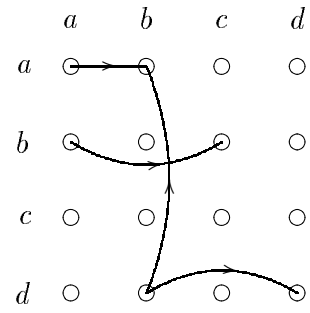

diag. 21

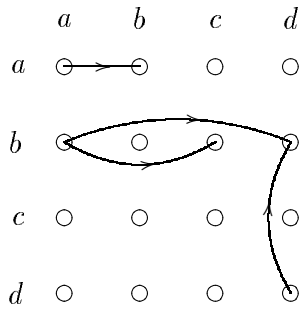

diag. 22