

The role of small fish species in eelgrass food webs of the Baltic Sea

**Dissertation
zur Erlangung des Doktorgrades
der Mathematisch-Naturwissenschaftlichen Fakultät
der Christian-Albrechts-Universität zu Kiel**

vorgelegt von

Ivo Christian Bobsien

Kiel 2006

Referent: Prof. Dr. H. Brendelberger

Koreferent/in:

Tag der mündlichen Prüfung:

Zum Druck genehmigt:

Kiel, den.....

Der Dekan

Contents

Summary.....	2
Zusammenfassung.....	4
List of papers.....	6
General introduction.....	7
Outline of the study.....	11
Chapters	
I	Comparison of an enclosure drop trap and a visual diving census technique to estimate fish populations in eelgrass habitats..... 13
II	Seasonal variation of fish community and habitat structure in an eelgrass bed (<i>Zostera marina</i> L.) in the southern Baltic Sea.....37
III	Predation of small fish species on epiphyte grazers in eelgrass beds of the Baltic Sea..... 64
IV	The fifteen-spined stickleback (<i>Spinachia spinachia</i>): An effective predator of grazing crustaceans in eelgrass beds..... 106
V	Behavioural responses of <i>Gammarus salinus</i> and <i>Spinachia spinachia</i> to vertical oxygen gradients in eelgrass habitats.....137
Summary of the results.....	154
General discussion.....	157
Conclusions.....	162
References.....	164
Appendix.....	180
Danksagung.....	182
Lebenslauf.....	183
Erklärung.....	184

Summary

Eutrophication is a major cause of dramatic changes in the species composition and the structure of aquatic food webs. The exceeding increase of nutrients contributes to the decline of marine seagrasses because of shading by rapidly growing algal epibionts. At moderate nutrient regimes, invertebrate grazers (amphipods, isopods, gastropods) are capable of controlling these epiphytes and as a consequence recovering seagrass productivity. Fishes may contribute to the control of epiphyte grazers by predation, but their impact on trophic relationships and functions in marine coastal food webs are poorly understood.

The present study combines descriptive and experimental approaches to investigate communities of small fish species and the trophic relationships between these fishes and epiphyte grazers in *Zostera marina* beds of the Baltic Sea. The thesis aims to compare quantitatively the fish assemblages of two eelgrass beds (Falkenstein, Vilm) including their feeding habits. The effects of selected biotic and abiotic factors on the feeding interactions between fishes and crustacean epiphyte grazers were tested experimentally. The eelgrass fish fauna was sampled quantitatively by using a newly developed enclosure trap. Gobiids, syngnathids and gasterosteids dominated the fish assemblages in both eelgrass systems. Gut content analysis indicated considerable differences in the feeding habits between the fish communities at both sampling sites. The predation on epiphyte grazers was of minor relevance to fishes in the Vilm eelgrass meadow. By contrast, epiphyte crustacean grazers were of pivotal dietary importance for the fish community in the Falkenstein eelgrass bed. Gastropods were generally of minor importance to the fishes at both sampling sites. The fish assemblage at Falkenstein foraged mainly upon small development stages (1-6 mm) of crustacean grazers, constituting a substantial food resource for the majority of fish. The overall consumption by small fish species is unlikely to have an impact on gastropod grazer populations, but crustacean grazer populations may be affected by fish predation. *Spinachia spinachia* is a common inhabitant of the eelgrass meadows at Falkenstein. Adult *S. spinachia* emerges as main predators of epiphyte grazing amphipods and isopods, and shows high potential to affect *Idotea balthica* and gammaridean amphipod populations through predation. *Spinachia spinachia* forages efficiently in dense vegetation, and feeding success is not restricted within shoot densities up to 400 shoots per m².

The eutrophication of marine systems promotes sedimentation of organic material and ultimately leads to hypoxic conditions in bottom waters. The resulting oxygen gradients were experimentally simulated in microcosms, and the consequences on predator-prey

relationships were investigated. *Spinachia spinachia* shows complex behavioural responses when exposed to short-term bottom oxygen deficiencies. Fish are capable of foraging efficiently over a wide range of oxygen gradients. *Spinachia spinachia* is slightly less tolerant to reduced water oxygen concentrations than its prey, and at less severe oxygen gradients thus prey remains within the canopy, whilst *S. spinachia* have to leave the eelgrass cover. At very low oxygen concentrations within the artificial eelgrass habitat, both predator and prey are forced out of the vegetation and *S. spinachia* then successfully preys upon *G. salinus* above the eelgrass canopy. The areas with reduced oxygen concentrations, however, do not provide refuge against fish predation because *S. spinachia* dips into these areas from above the canopy to forage. In between these dives *S. spinachia* resides within the oxygen-saturated regions above the eelgrass canopy, in turn exposed to potential predators.

In conclusion, this study shows that crustacean grazers constitute the key diet for the majority of small eelgrass-associated fish species in Falkenstein eelgrass beds. *Spinachia spinachia* is the most important predator of these grazers, foraging effectively and successfully in dense vegetation and under bottom oxygen deficiencies in eelgrass habitat. *Spinachia spinachia* exhibits a high capacity to regulate crustacean grazer populations in eelgrass beds.

Zusammenfassung

Die Eutrophierung ist eine bedeutende Ursache für drastische Veränderungen der Artenzusammensetzung und der Nahrungsnetzstruktur von aquatischen Ökosystemen. Die übermäßige Zunahme von Nährstoffen führt durch schnelles Epiphytenwachstum zur Beschattung der Seegraspflanzen und letztendlich zu deren Absterben. Bei moderaten Nährstofffrachten sind wirbellose Weidegänger (Amphipoda, Isopoda, Gastropoda) in der Lage die Epiphyten effektiv zu entfernen und auf diese Weise die Produktivität der Seegraspflanzen wiederherzustellen. Fische sind potentielle Räuber dieser Weidegänger. Über die Ernährungsbeziehungen und Funktionen der Kleinfischgemeinschaften in marinen Nahrungsnetzen ist wenig bekannt.

Die vorliegende Studie verbindet Freiland- mit Laboruntersuchungen und beschreibt quantitativ die Fischgemeinschaften zweier Seegraswiesen (Falkenstein, Vilm) und ihre Nahrungsbeziehungen zu epiphytischen Weidegängern in *Zostera marina* Wiesen der Ostsee. Sie prüft experimentell die Auswirkungen einiger biotischer und abiotischer Faktoren auf die Fraßinteraktionen zwischen Fischen und herbivoren crustaceen Weidegängern. Dazu wurde die Seegras-Fischfauna mittels einer neu entwickelten Einschlussfalle quantitativ beprobt. Gobiidae, Syngnathidae und Gasterosteidae dominierten in beiden Seegrassystemen. Die Mageninhaltsuntersuchungen zeigten beträchtliche Unterschiede in der Ernährung der Fischgemeinschaften. Die Fischprädation auf Weidegänger war am Standort Vilm von geringer Bedeutung. In Gegensatz dazu waren epiphytische Weidegänger von zentraler Bedeutung für die Ernährung der Fische in der Seegraswiese vor Falkenstein. Gastropoden waren für die Ernährung der Fische an beiden untersuchten Standorten von geringer Bedeutung. Die Fische in der Seegraswiese vor Falkenstein fraßen hauptsächlich kleine Entwicklungsstadien (1-6 mm) der crustaceen Weidegänger, die eine bedeutende Nahrungsressource für die Mehrheit der Fische darstellt. Die Gesamtkonsumption aller Kleinfische hat wahrscheinlich keinen Einfluss auf die Schneckenpopulationen, die Abundanzen der crustaceen Weidegänger könnten jedoch durch Fischprädation reduziert werden. *Spinachia spinachia* ist ein häufiger Kleinfisch in der Seegraswiese vor Falkenstein. Adulte *S. spinachia* gehören zu den bedeutendsten Räufern von Isopoden und Amphipoden, und besitzen ein großes Potential die Populationen von *Idotea balthica* und Gammariden in Seegraswiesen der Ostsee durch Prädation zu kontrollieren. *Spinachia spinachia* kann auch in dichter Vegetation effektiv Beute fangen und sein Fangerfolg wird durch Seegrassprossdichten bis zu 400 pro m² nicht eingeschränkt.

Die Eutrophierung kann zu hypoxischen Bedingungen am Boden der Gewässer führen. Diese Bedingungen wurden in Laborexperimenten simuliert und ihre Auswirkungen auf Räuber-Beutebeziehungen untersucht. *Spinachia spinachia* zeigt komplexe Verhaltensantworten, wenn er kurzzeitigem Sauerstoffmangel in Bodennähe ausgesetzt ist. Er fängt über einen weiten Bereich verschiedenstarker Sauerstoffgradienten effektiv seine Beute. Gegenüber reduzierten Sauerstoffkonzentrationen reagiert er weniger tolerant als seine Beute. Bei weniger starken Sauerstoffgradienten verbleiben die Beutetiere im Seegras während *S. spinachia* das schützende Habitat verlassen muss. Bei sehr niedrigen Sauerstoffkonzentrationen werden Räuber und Beute aus dem Seegras getrieben. Dann fängt *S. spinachia* erfolgreich Gammariden über dem Seegras. Selbst Bereiche mit stark reduzierten Sauerstoffkonzentrationen bieten den Gammariden keinen ausreichenden Schutz gegenüber Fischprädation, weil *S. spinachia* kurzzeitig von oben herab in die sauerstoffreduzierten Bereiche hineintaucht, um dort erfolgreich Beute zu suchen und zu fangen. Zwischen diesen „Tauchgängen“ hält sich *S. spinachia* in den sauerstoffgesättigten Bereichen oberhalb der Seegraspflanzen auf, wo er selbst potentiellen Räufern ausgesetzt ist.

Zusammenfassend zeigt diese Studie, dass crustacee Weidegänger die Hauptnahrung für die Mehrheit der Klein-Fische in der Seegraswiese vor Falkenstein darstellen. *Spinachia spinachia* ist der bedeutendste Räuber dieser Weidegänger, der seine Beute effektiv und erfolgreich in dichter Vegetation und sogar bei Sauerstoffdefiziten in Seegrashabitat erbeutet. *Spinachia spinachia* besitzt ein großes Potential die crustaceen Weidegänger in Seegraswiesen zu kontrollieren.

List of chapters

This thesis is based on the following chapters, referred to by their roman numerals in the text:

- Chapter I Comparison of an enclosure drop trap and a visual diving census technique to estimate fish populations in eelgrass habitats ⁽¹⁾
- Chapter II Seasonal variation of fish community and habitat structure in an eelgrass bed (*Zostera marina* L.) in the southern Baltic Sea ⁽²⁾
- Chapter III Predation of small-sized fish species on epiphyte grazers in eelgrass beds of the Baltic Sea (manuscript)
- Chapter IV The fifteen-spined stickleback (*Spinachia spinachia*): An effective predator of grazing crustaceans in eelgrass beds (manuscript)
- Chapter V Behavioural response of *Gammarus salinus* and *Spinachia spinachia* to vertical oxygen gradients in eelgrass habitats ⁽³⁾

(1) Bobsien, I. C., Brendelberger, H., 2006. Limnology and Oceanography: Methods, (in press)

(2) Updated version of: Bobsien, I. C., Munkes; B., 2004. Seasonal variation of the fish community and habitat structure in an eelgrass bed (*Zostera marina* L.) in the southern Baltic Sea. Rostocker Meeresbiologische Beiträge, 12: 39-59

(3) Bobsien, I. C., Brendelberger, H., Journal of Experimental Marine Biology and Ecology (submitted)

General introduction

Submerged macrophytes constitute productive ecosystems that fulfil important physical, chemical and biological functions in the marine and limnic environment (Jeppesen et al. 1998, Hemminga and Duarte 2000). Early investigations documented the faunal richness and the biological importance of submerged macrophytes, especially *Zostera marina* (Linnaeus, 1758) meadows for ecosystem processes (Petersen 1918, Rasmussen 1973). In the Baltic Sea *Z. marina* forms continuous meadows or patchy beds in depth between 1 to 6 m on muddy and sandy bottoms (Boström et al. 2003). *Zostera marina* beds are highly productive and build up three-dimensional structures, rich in microhabitats and niches providing food and shelter for multifaceted and diverse animal communities (Hemminga and Duarte 2000). The fauna of seagrass beds can be highly diverse and faunal abundances are frequently orders of magnitude higher than in adjacent unvegetated areas (Bell and Pollard 1989). Enhanced food supply and protection against predation have been considered the main causes for the extraordinary richness of the fauna in vegetated habitats compared with bare sand (Bell and Pollard 1989). The structural complexity of the vegetation may considerably affect the foraging efficiency of fishes (Heck and Orth 1980, Orth et al 1984).

Threats to eelgrass and its associated communities

Seagrass beds and its associated communities are frequently threatened due to natural and anthropogenic impacts (Short and Wyllie-Echeverria 1996, Duarte 2002). Human activities resulted in pervasive alterations of these habitats including significant changes in species composition, mass occurrence and mass mortality of organisms up to total disappearance of the submerged vegetation and the associated animal communities (Fredriksen et al. 2004, Pihl et al. 2006).

Eutrophication is one of the major causes in the change of marine coastal ecosystems (Gray et al. 2002). A decline in seagrass meadows has been reported worldwide and was often associated with increased nutrient loads resulting from growing agriculture and urbanization (Short and Wyllie-Echeverria 1996). Anthropogenic nitrogen loads enhance the growing conditions of nutrient limited primary producers, such as phytoplankton and epiphytic algae, which in turn lead to reduced water transparency, increasing epiphyte cover on the eelgrass leaves and elevated macroalgae growth (Baden et al. 1990, Vahteri et al. 2000, Hauxwell et al. 2003). As a result shading ultimately leads to a decline in shoot density and finally to eelgrass disappearance (Hauxwell et al. 2000).

Changing habitat complexity or total eelgrass loss directly or indirectly affect the fauna that utilizes eelgrass beds as feeding, spawning, or nursery ground or relies on eelgrass for shelter (Edgar and Shaw 1995b, Pihl et al. 2006).

Effects of epiphyte grazers

Epiphytic grazers, like isopods, amphipods and gastropods are capable of significantly reducing the loads of attached epiphytes and in this way enhance macrophyte productivity (Van Montfrans et al. 1984, Jernakoff et al. 1996). Among marine isopods *Idotea balthica* (Orav-Kotta and Kotta 2004) and *I. chelipes* represent effective grazers (Hootsmans and Vermaat 1985). *Idotea chelipes* removes the epiphyton on *Z. marina* leaves more effectively than *Hydrobia ulvae* and *Littorina littorea* (Hootsmans and Vermaat 1985). Amphipods as well substantially reduce the load of epiphytes settled on eelgrass leaves (Howard 1982, Duffy and Harvilicz 2001). Gastropods are well-known herbivorous grazers scraping epiphytes from seagrass leaves (Norton et al. 1990). *Hydrobia ulvae*, for example, efficiently removes attached epiphytes and enhances growth rates of *Z. noltii* (Phillipart 1995), and grazing *Lacuna variegata* significantly reduces epiphyte biomass from eelgrass blades (Nelson 1997). Recent experimental investigations on feeding effects of eelgrass gastropods and crustaceans in the Baltic Sea on epiphytes and eelgrass growth demonstrated *L. littorea* and *Rissoa membranacea* to graze more efficiently compared to *I. balthica* and *Gammarus oceanicus* (Jaschinski, pers. comm.). The above-mentioned mesograzers can be potential preys for fishes living in seagrass beds (Edgar et al. 1995).

Effects of fishes

Changes in abundance and composition of predatory fishes can significantly alter aquatic ecosystems. In the pelagic zone of temperate lakes, for example, the removal of large predators can trigger a trophic cascade that eventually benefits small zooplankton and grazer-resistant phytoplankton (Carpenter et al. 1985, 1987). In the littoral zone of freshwater habitats, the exclusion of large fish predators results in a chain of strong reactions from fish to snails to periphyton and ultimately to macrophytes (Martin et al. 1992, Brönmark and Vermaat 1998). In the marine environment, fish predators may also have significant top-down effects in determining the composition and abundance of animals, thus modifying ecosystem structure and functions (Nelson 1979; Kennelly 1991, Heck et al. 2000, Nilsson and Engkvist 2004).

In the Baltic Sea the stocks of large predatory fishes, such as cod (*Gadus morhua*), have drastically declined (Jonzén et al. 2002). Simultaneously, mass occurrence of herbivorous grazers is observed (Engkvist et al. 2000, Fredriksen et al. 2004). The isopod *I. balthica*, for example, is considered the proximate cause of the decline in abundance of *Fucus vesiculosus* populations in the Baltic Sea (Engkvist et al. 2000). These grazing invertebrates constitute a potential food source of fish. Nilsson (2004) demonstrated that herring (*Clupea harengus*) could be a significant contributing factor to the rapid decline in the autumn populations of *I. balthica*. Recent abundances, biomasses and feeding habits as well as the functional role of small fish species in eelgrass beds of the Baltic Sea are widely unknown.

The quantitative collection of fishes in vegetated habitats and subsequent diet analysis provides the first information on the species richness and the trophic function of local seagrass fish communities. A variety of methods is available for assessing the abundance and biomass of fishes in vegetated habitats (Gilmore 1990; Edgar et al. 2001). The collection of quantitative data requires a sampling device with stable and predictable catch efficiency. Water depth can greatly affect gear efficiency and subtidal seagrass beds normally require complex and inefficient equipment. Edgar et al. (2001) recommended seine nets (towed nets) as standardised gear that is most appropriate for collecting small fishes and decapods up to 5 m depth. Seine nets, however, usually have low and variable catch efficiencies and the effect of vegetation on catch efficiency is significant (Rozas and Minello 1997). One major cause of low catch efficiency is that fine mesh seine nets can become clogged with jellyfish or dense loads of algae or debris. The development of a reliable method to sample small fish communities, therefore, was of crucial importance for the assessment of the abundance and biomass of fishes in vegetated habitats.

Bottom hypoxic gradients

The heavy increase of nutrients results in enhanced production of particulate organic matter that is often too large to be taken up by animals and subsequently sink to the sea bed. There, the microbial decomposition leads to lowered oxygen concentrations in the sediment and in the water column above (Rosenberg and Loo 1988). Hypoxia can profoundly affect benthic communities (Diaz and Rosenberg 1995, Powers et al. 2005) as well as species living in the water column (Gray et al. 2002).

The lowered oxygen concentrations in the bottom water layer can lead to shifts in the vertical distribution of benthic macroinvertebrates depending on the behavioural responses of the affected species, and may thus influence predator-prey relationships (Baden et al. 1990). However, the effects of vertical oxygen gradients on feeding behaviour and predator-prey relationships are widely unknown in the marine environment (Karlson et al. 2002). Most studies on this subject focussed on mortality experiments at a specific oxygen concentration and exposure time. Other workers stressed non-lethal effects of oxygen deficiencies such as growth, feeding and metabolic rates (Gray et al. 2002). In the present study, the behavioural responses of species were used as indication of oxygen tolerance and to characterise the influence of vertical oxygen gradients on predator-prey relationships in eelgrass beds.

Outline of the study

The aim of the present study was to elucidate the trophic interactions that shape eelgrass beds of the Baltic Sea. For this, the trophic relationships between small fish species and important epiphyte grazers as well as biotic and abiotic factors affecting and regulating predator-prey relationships in eelgrass beds were investigated.

The primary focus was to analyse quantitatively the fish communities associated with *Zostera marina* beds and to describe seasonal aspects of their community structure. For this purpose, an enclosure trap (ET) was developed and the relative sampling efficiencies was assessed by comparison with a visual diving census technique (**Chapter I**). The fish communities of two eelgrass meadows located in the outer Kiel Fjord (Falkenstein) and in the Greifswald Lagoon (Vilm) were regularly sampled quantitatively with the ET over a period of eighteen months. The seasonal characteristics of the eelgrass fish communities were described and the data correlated with structural vegetation components and abiotic parameters (**Chapter II**). Chapter II reflects published work (Bobsien and Munkes 2004), but includes improvements of the measurement of fish abundances and biomasses based on the catch efficiency coefficients determined during the comparison study (**Chapter I**). Additional aims were to reveal fish predators that predominantly consume epiphyte grazers and to clarify the trophic relationships between small fish species and these grazers (**Chapters III**). Therefore, the fish species composition and the feeding habits of the fish assemblages were quantitatively investigated at both eelgrass locations including the size relationships between predator and prey. Further aims were to estimate the impact (defined as the proportions of grazer production consumed) of fish predation on epiphyte grazers (**Chapter III**). Fish production, fish consumption and grazer production were estimated. The estimates of fish abundance, biomass and somatic production as well as the proportions of grazer production consumed by the fish were compared between the sampling locations and related to results obtained from other seagrass communities (**Chapter III**). A further aim was to describe the foraging skills of a fish predator predominantly inhabiting eelgrass beds. The fifteen-spined stickleback *S. spinachia* emerged as one of the most important predators and was used to investigate predator-prey interactions between fish and epiphyte grazers in the laboratory. **Chapter IV** describes the foraging ecology of *S. spinachia*. This chapter discusses feeding habits, food preferences under field and laboratory conditions and the effects of prey size, prey density and habitat complexity on foraging success of *S. spinachia*.

Additional goals were to investigate the behavioural responses of fish predators and their prey to declining oxygen concentrations and hypoxic bottom layers (oxygen gradients). Therefore, the hypoxic tolerances of *S. spinacha* and *Gammarus salinus* were quantified by means of behavioural responses, and additionally the impact of bottom oxygen gradients on predator-prey relationships is described (**Chapter V**).

**Comparison of an enclosure drop trap and a visual
diving census technique to estimate fish populations
in eelgrass habitats**

Abstract

In shallow vegetated aquatic habitats exceeding 2 m depth conventional methods to determine fish abundances are of limited success. In this study the sampling qualities of two methods for investigating the fish community associated with the eelgrass *Zostera marina* were tested. A newly developed enclosure drop trap (ET) operated from the water surface, and a visual diving strip transect technique were compared. The construction and the sampling procedure of the enclosure trap are described in detail. Both sampling procedures were performed simultaneously at the same eelgrass sampling site at depth between 2 and 5 m. The comparison revealed deficiencies in relative catch efficiency for both methods. Limitations with respect to bottom dwelling forms are obvious for the ET and with respect to the Syngnathidae and Gasterosteidae for the visual diving census. Abundance estimates of pelagic, schooling species were highly variable with both methods. Correction coefficients for the different behavioural categories of eelgrass fish were calculated. The fish species composition showed good agreement between both methods, but the number of species on each sampling occasion was consistently higher in the ET catches. The length class frequency distributions estimated by the divers corresponded approximately with direct measurements of fish from the ET catches. The methods complemented one another and can be recommended for simultaneous deployment to get accurate quantitative estimates of eelgrass fish populations. The relative capture efficiency of the enclosure trap can be incorporated to improve abundance measurements of small fish species in *Z. marina* beds without the help of divers.

Introduction

The seagrass beds of shallow water ecosystems are important habitats because of their trophic and nursery functions for many fish and crustaceans throughout the world (Watson et al. 1993, Murphy et al. 2000). These functions also mean that they are considered of paramount economical value (Costanza et al. 1997).

At the same time, however, most seagrass beds are threatened by aspects of coastal environmental degradation, mainly linked to eutrophication. Scientific research may provide the impetus for the protection, restoration and conservation of these diverse communities and resources. In this context, reliable quantitative methods to determine fish and macroinvertebrate abundances in submerged aquatic vegetation are of special importance.

Eelgrass beds in the Baltic Sea typically occur at depths of 1 to 6 meters (Boström et al. 2003). In these shallow areas conventional quantitative methods to determine fish abundances are of limited success. Passive collection devices such as gill nets are unsuitable for quantitative sampling because the catches cannot be clearly related to a distinct area and time, although they are useful for collecting qualitative information about fish communities (Edgar and Shaw 1995a) or to document the migration of larger fishes (Sogard et al. 1989).

Traditionally seagrass community studies employ seines and trawls for sampling small epibenthic animals in coastal waters down to 10 and 20 m depth, respectively. Trawls and seines provide a rapid assessment of large areas and comparable data for a broad range of conditions and habitats. However, they are also known for their high operating cost, lack of replicability and destructive effect on vegetated habitats (Edgar et al. 2001). Further drawbacks are the difficulties in assessing defined sampling areas and the low, variable catch efficiencies, depending on species, fish behaviour, fish size, macrophyte biomass, bottom type, trawl size, mesh size, net clogging and towing speed (Kjelson and Johnson 1978, Parsley et al. 1989, Pierce et al. 1990, Wennhage et al. 1997).

Traps that rapidly enclose a clearly defined area have been increasingly used to sample fish populations in shallow water habitats because they are a precise and accurate means to obtain quantitative estimates of fish assemblage abundance and biomass in vegetated habitats (Kushlan 1981, Jacobsen and Kushlan 1987, Jordan et al. 1997).

The absolute efficiency of drop traps can be estimated in shallow block net separated areas with known fish densities (Kushlan 1981, Jordan et al. 1997), and they have often been used to estimate the relative efficiency of seines and trawls (Freeman et al. 1984, Dewey et al. 1989, Wennhage et al. 1997).

Enclosure traps, including drop-traps (Kahl 1963, Kushlan 1974, Gilmore et al. 1978, Pihl and Rosenberg 1982, Pihl and Pihl 1984, Nellbring 1985), drop-nets (Hellier 1958, Mosely and Copeland 1969, Kjelson et al. 1975, Adams 1976a), buoyant pop-nets (Larson et al. 1986, Serafy et al. 1988, Dewey et al. 1989, Conolly 1994), lift-nets (Higer and Kolipinski 1967, Rozas 1992) and throw-traps (Kushlan 1981, Jacobsen and Kushlan 1987, Chick et al. 1992, Jordan et al. 1997), provide instantaneous samples and are considered to be the most efficient sampling devices for small fishes and invertebrates in shallow water habitats, less than 1.5 m deep (Kushlan 1981, Jordan et al. 1997). Only a few complex and labour intensive buoyant drop- and pop-nets with floating frames are useable at depths of 2 to 5 m (Mosely and Copeland 1969, Larson et al. 1986, Serafy et al. 1988). The major disadvantages of these systems are the need for divers to set or to clear the traps, the additional bottom structure (pop-nets) that can attract or repel organisms, and the long equilibration time (hours to a day) after setting.

Other techniques, such as the visual diving census (VDC) provide a powerful tool to estimate fish abundance. The diving census method was first described by Brock (1954) and has been applied especially for coral reefs. Subsequently, the VDC has been used under a wide range of environmental conditions to investigate the fish fauna of the Baltic Sea, including submerged vegetation (Jansson et al. 1985, Thetmeyer 1998). VDC has also been applied in Mediterranean seagrass beds (*Posidonia oceanica*) compared to trawling, and biases associated with these techniques are well documented (Brock 1982, Harmelin-Vivien and Francour 1992, Edgar et al. 2004). VDC is considered as an accurate technique, and is widely accepted for estimating fish abundances under clear water conditions in different habitats types. The success of this method depends on the experience of the divers, rapid and accurate determination of the fish species encountered is necessary. This is even more critical in seagrass beds where most resident fishes are rather small, camouflaged, and many show cryptic behaviour.

The aim of the present study was to design a quantitative collection technique that adequately reflects the abundances of small fish in temperate eelgrass beds. For this purpose a portable enclosure drop-trap (ET) was constructed which operates without the help of divers.

Information about gear catch efficiency is important for adjusting catch data and providing more accurate estimates of fish abundances. We therefore quantified the catch efficiencies of the ET relative to estimates obtained by the VDC technique. Correction coefficients for typical seagrass-dwelling fishes of five different behavioural categories (guilds) were calculated by comparing animal abundance supplied by the two methods. Further species richness, diversity, and size composition were compared. Additionally, the abundance of the dominant shore crab (*Carcinus maenas*) was recorded. Abundance estimates by two divers were compared to correct for personal bias.

Materials and Procedures

Area investigated and environmental conditions

The comparative study was carried out in a monotypic eelgrass meadow (*Zostera marina* Linnaeus) on the north-west coast of the outer Kiel Fjord in the Baltic Sea, Germany (Figure 1).

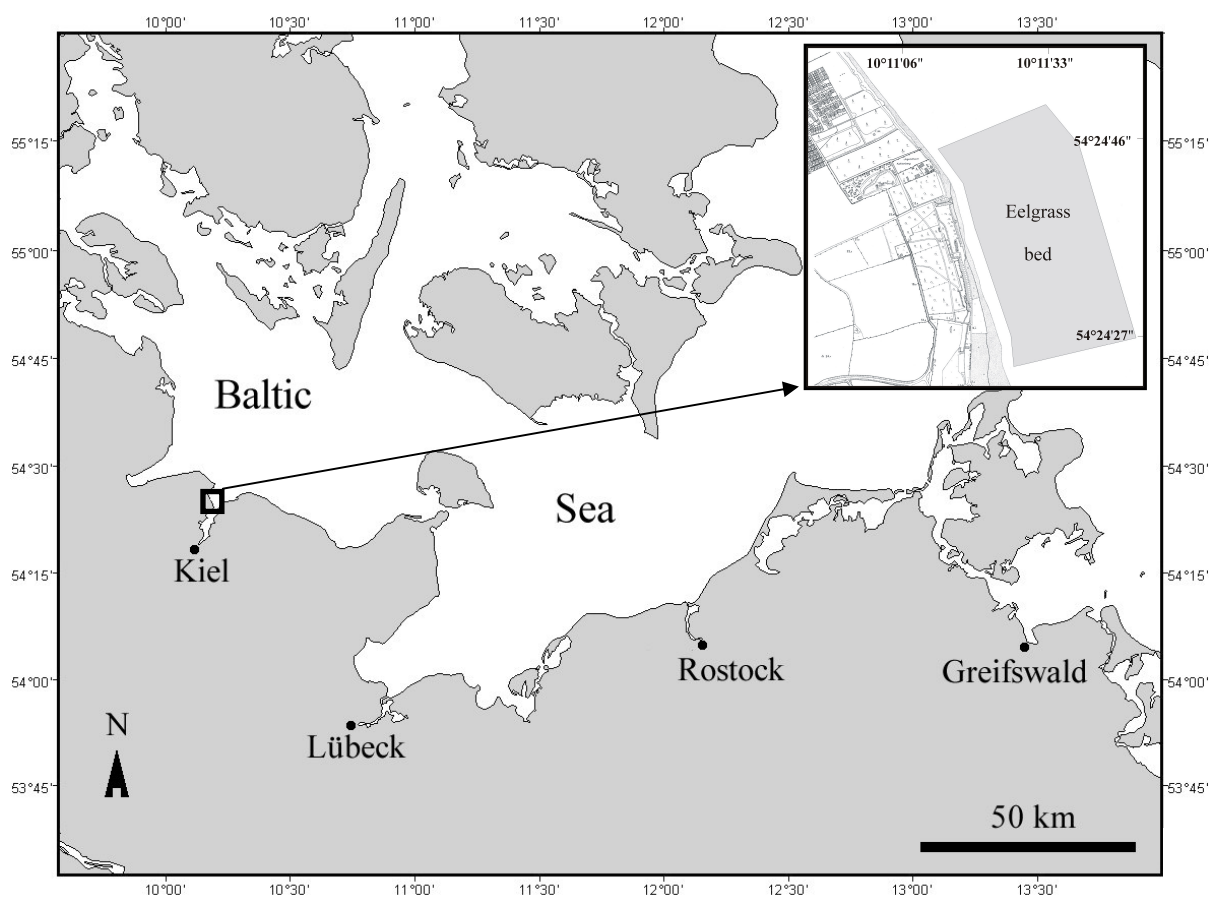

Fig. 1. Study area showing the location of the eelgrass bed in the outer Kiel Fjord

The eelgrass bed extended over a 23 ha area in depths of 2 to 5 m and was interrupted by small, unvegetated, sandy patches. The study site was wind and wave exposed with sediments conditions ranging from coarse (<3 m depth) to fine sand or muddy silt (>3 m depth), lacking big stones. The structural components of the eelgrass meadow were investigated by divers on 21 August, 25 September, and 27 October 2003 (Tab. 1). Fish census and ET catches were carried out simultaneously on 21 Aug, 25 Sep, and 27 Oct 2003 between 9 am and 7 pm.

Table 1. Structural characteristics of the *Zostera marina* meadow sampled. Biomass values are given as dry weight per unit area. Values are arithmetical means \pm standard deviation. n=number of replicates sampled

Eelgrass structure	n	Sampling date		
		16 Aug 03	25 Sep 03	27 Oct 03
Shoot density [number m ⁻²]	30	381 \pm 95	315 \pm 113	293 \pm 97
Shoot length [mm]	100	490 \pm 183	474 \pm 145	500 \pm 139
Leaf area [dm ² m ⁻²]	100	42 \pm 23	48 \pm 31	34 \pm 19
Above-ground biomass [g m ⁻²]	30	98 \pm 72	109 \pm 69	68 \pm 48
Below-ground biomass [g m ⁻²]	30	154 \pm 92	131 \pm 64	75 \pm 75

Description of the sampling methods

Enclosure trap

Square-profiled (12 x 12 mm, 1.2 mm thick) aluminium bars with open ends were welded together to form a frame (Fig. 2, D, of 2.0 x 1.0 x 0.6 m, length x width x height) with stabilizing elements (Fig. 2, C, L) and a sealable, two-part lid (Fig. 2, A). Knotless white nylon net material (Fig. 2, B), 6 mm mesh size, covers the frame and lid. The underside is free of netting. The bottom edge is bordered by an aluminium flange (Fig. 2, H, 100 mm high, 2 mm thick). An adjustable length steel pin (Fig. 2, G) is located at each bottom corner to prevent the ET from sliding over the ground during the closing procedure. By pulling the shutter ropes (Fig. 2, F), the roller shutter (Fig. 2, K), lead by a guide rail (Fig. 2, E), unwinds and closes the underside of the ET. The roller shutter (Fig. 2, K) consists of a shaft (Fig. 2, I) with a strap roll (Fig. 2, M) to wind up the roller shutter segments. During sampling the ET is suspended with four ropes from a buoy (lift: 20 kp), and it is balanced horizontally in the water column using 4 kg lead weights (Fig. 2, J). The total weight of the enclosure trap is 36 kilograms. A remote trigger mechanism on a release rope frees the trap from the buoy and the ET descends to the bottom at approximately 1.5 m s⁻¹ down. The enclosed area is 2 m².

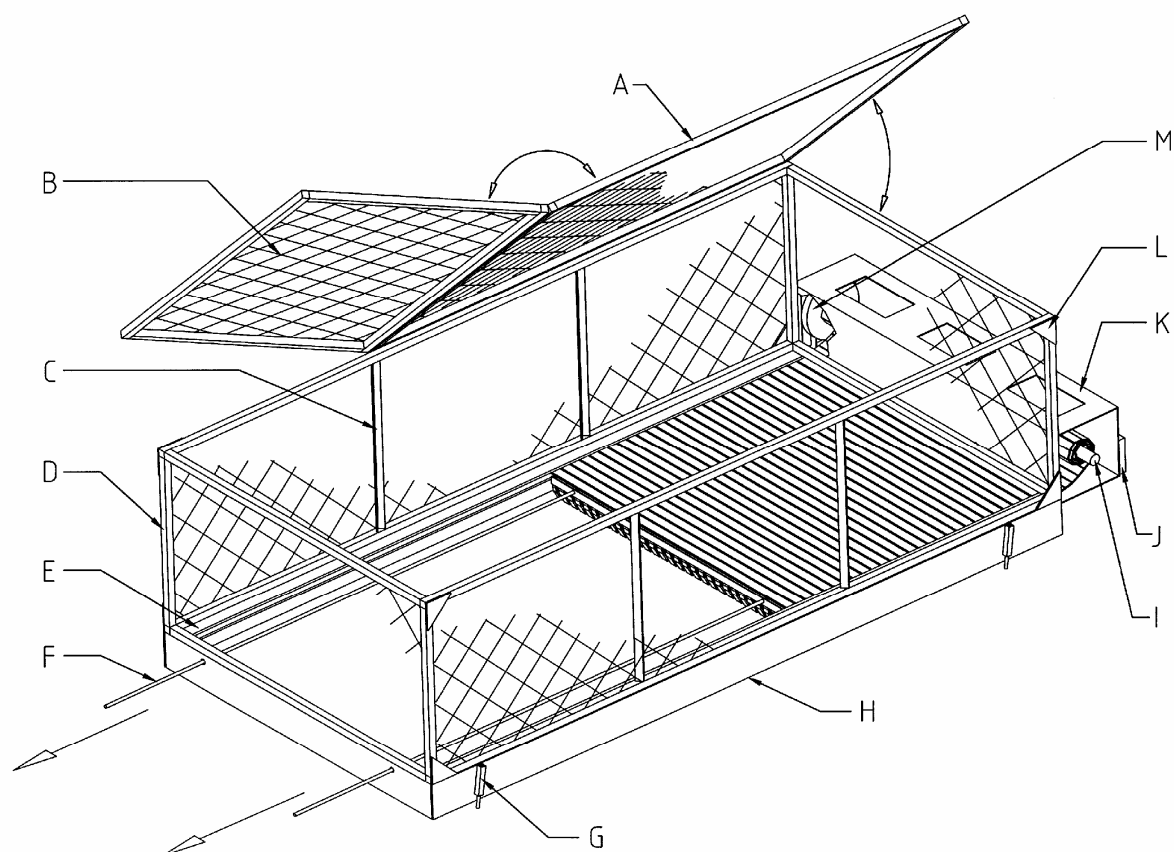

Figure 2. Aluminium enclosure drop trap for sampling small epibenthos in eelgrass beds. Double-headed arrows demonstrate the function of the divided lid. White-headed arrows indicate the pull direction of the shutter rope to close the trap. See text for further explanations

Sampling procedure

Sampling requires a small boat (4 m) or flat-bottomed punt with an outboard engine and two operators. The ET is aligned perpendicularly to the side of the boat so that one person can operate both sides of the trap. Once the boat is positioned over the sampling ground, the ET is carefully pushed into the water. It then hangs below the buoy and is balanced horizontally in the water column. Equilibration time after pushing the ET into the water is 1-3 minutes depending on wind and wave action while the boat and ET drift in the water. The release rope is pulled when the boat has drifted 10-15 m away from the ET. This minimizes disturbance by the boat. The lowered drop trap then encloses a 2 m² area including eelgrass and its associated fauna. When the shutter rope is pulled, the roller shutter closes the underside 10 cm above the sediment. The shutter rope (20 m) allows closure without lifting the ET from the bottom. In preliminary tests divers did not observe any lift or tilt of the ET during the closure procedure. It was not necessary to clip weights onto the shutter rope to ensure its horizontal alignment. During the closure, flexible rubber lips (50 x 30 x 3 mm) brush across the sediment, depressing the macrophytes, disturbing the

demersal fauna and thus guiding animals into the trap. The flexible rubber lips on the underside of the first segment of the roller shutter are aligned at right angles to the sediment, blocking the space between the sliding door and the sediment. While closing the ET, the rubber lips are slightly deflected across the depressed eelgrass plants. Irregularities in the seabed, such as small stones (<50 mm in height) draw the lips aside, after which they swing back to their former positions, not allowing fish to escape easily. Minor depressions in the seabed allow the lips to straighten and thereby also sweep the ground. Major depressions are insufficiently cleared. The closed ET is then lifted up and pulled into the boat. The lid allows quick and easy removal of all organisms and debris. The roller shutter must then be rewound to prepare the ET for further sampling. In previous tests the capture procedure, especially the descent behaviour and the closure was monitored by two divers. The well-balanced ET was never observed to hit the ground at an angle or to roll over. The sliding door mechanism runs smoothly and worked perfectly in unvegetated areas (sandy ground) as well as in heavily vegetated *Zostera marina* beds. The capture qualities of the ET were tested to a maximum depth of 5 m and to maximum eelgrass densities of approximately 600 shoots m⁻². Subsequently, the ET has successfully completed more than 1000 drops without any damage to its construction.

During the comparative study described here a total of 90 drops were performed, which correspond to 180 m² eelgrass area. Five trap drops were pooled to give blocks of 10 m². Animal abundances were compared with abundances within 10 m² transect segments inspected by divers (see below). Catch efficiencies were also calculated from these 10 m² block samples. The fish caught with the trap were anaesthetised with benzocaine (Ethyl 4-aminobenzoate) and immediately preserved in 96 % ethanol. They were counted, identified to species level and measured to the nearest millimetre. Size frequency distributions of directly measured fish were compared with size estimates obtained by the divers.

Visual diving census

The underwater visual census technique was carried out in accordance to the diving census procedure described by Jansson et al. (1985). On each sampling occasion a lead weighted 60 m transect line, marked in meter increments and subdivided into 10 m transect segments, was set across the sampling area in 2-5 m of water. Both ends of each line were fixed to the bottom with 5 kg lead weights, and additional line segments passed to surface marker buoys. The 10 m transect segments were assumed to be independent of each other within each 60 m block. To compare abundances and catch efficiency the 10 m transect

segments (=10 m² eelgrass area) were compared to 5 drops sampling blocks of the ET. The diving census began at least 45 minutes after the deployment of the transect lines. Two experienced census divers swam slowly and quietly on both sides of the line counting, identifying and recording all fishes and the shore crabs within a strip of 0.5 m on both sides of the line and within the water column above. Hidden fish were found by carefully parting the vegetation and turning shells and stones. Most fish species were measured against a ruler marked in cm segments. The duration of the diving census varied between 3 and 4 hours for 60 m² eelgrass area. Abundance and size-structure were noted on a white plastic sheet, 0.5 m in length, which was used as both a notepad and reference width for the inspected transect. Previous investigations had shown that inspection fields greater than 0.5 m markedly increased the probability of double counting. All counting and measuring was undertaken by the same two divers. Statistical comparisons of the different counts were performed for total fish and shore crab abundances to detect any personal bias.

Behavioural and Microhabitat categories

Five categories (A-E) were chosen to characterise the microhabitat preference and reflect the feeding mode and behaviour of dominant species in the eelgrass meadows of the western Baltic Sea. The classification was developed from personal observations and gut content analysis:

- (A) Fast moving planktivorous fish feeding above the canopy and sheltering below it,
- (B) Slower moving fish living under the leaf canopy,
- (C) Faster moving fish living under the leaf canopy,
- (D) Fish living on the sediment,
- (E) Shore crab living on and hiding in the sediment.

Quantitative comparison

The catch efficiency of the ET was determined relative to the VDC technique according to a method described by Salthaug (2002). The catch efficiency (r) of one sampling method relative to another can be estimated by taking the abundance ratio between the methods when they are sampling on the same density of organisms under comparable conditions:

$$r = N_{(ET)} N_{(VDC)}^{-1} \quad \text{for } N > 0 \quad (1)$$

where $N_{(ET)}$ is the species abundance estimated by enclosure trap and $N_{(VDC)}$ the abundance estimated by VDC. To ensure as equal a density of organisms as possible, the ET sampling and VDC were conducted simultaneously in the same place. The median of the relative

catch efficiency (r values) was used as an estimator. X -values were calculated and plotted on frequency graphs to show outliers and variability of the comparative study. To eliminate the problem of asymmetry the r -values between 0 and 1 were adjusted by transformation to the same scale as values above 1. A useful transformation is given in Salthaug (2002):

$$\begin{aligned} X_1 &= r-1 && \text{for } r \geq 1 \\ X_2 &= -(r^{-1}) + 1 && \text{for } r < 1 \end{aligned} \quad (2)$$

where x values corresponding to r values below 1 become negative. Values of 0 indicated no differences in catch efficiency between the sampling methods.

The fish diversity reflected by the two methods was quantified by the Shannon-Weaver index (H_S). The Shannon-Weaver index of diversity (Krebs 1999) was calculated from

$$H_S = - \sum p_i \ln p_i \quad (3)$$

where p_i is the proportion of the i^{th} species in the sample. The species number (richness, S) was also recorded.

Schooling behaviour

Some fish species aggregate in large schools within eelgrass meadows and density estimates from diving census or ET sampling may deviate substantially from the true density, depending on the presence or absence of a school along the transect or in the drop area of the ET. For this reason these species were sometimes excluded from the analysis (see below).

Statistical analysis

The total fish abundances and abundances for the shore crab, *C. maenas*, obtained by each method and pooled over the sampling period were compared with sign test to detect differences in sampling efficiency (Salthaug 2002). Total fish abundances were compared, including and excluding the two spotted goby (*G. flavescens*), which exhibited major fluctuations in catches due to its swarming behaviour. The sign test was also applied to the different behavioural groups established for the eelgrass fish community. Differences in total fish abundances between sampling dates and sampling methods were analysed by Kruskal-Wallis Test. The Wilcoxon signed rank test was used to evaluate differences in abundance estimates between the two divers performing the VDC.

Assessment

Fish community and species richness

A total of 1278 fish individuals were counted, 548 with the ET and 730 with the diving census. Thirteen fish species from seven families were recorded by the combination of the two methods. The size spectrum of the fish ranged from 15 to 300 mm (Tab. 2). The relative frequencies of species determined with both methods differed considerably. The rank order obtained by the combination of the two methods indicated that the Gobiidae were the most frequent species, followed by *Nerophis ophidion* (Syngnathidae) and the Gasterosteidae, namely *Spinachia spinachia* and *Gasterosteus aculeatus* (Tab. 2).

Table 2. Number (N) in decreasing order, proportion and range of total length (TL) of species detected by enclosure trap (ET) and visual diving census (VDC) technique in a *Zostera marina* eelgrass bed during August, September and October 2003. *Potamoschistus minutus* and *Gobius niger* were combined due to uncertain discrimination in the visual diving census.

Behavioural categories (BC):

- (A) Fast moving planktivorous fish feeding above the canopy and sheltering below it,
- (B) slower moving fish living under the leaf canopy,
- (C) fast moving fish living under the leaf canopy,
- (D) fish living on the sediment,
- (E) shore crab living on and hiding in the sediment

BC	Family	Species	Method	[N]	[%]	TL [mm]
Teleostei						
A	Gobiidae	<i>Gobiusculus flavescens</i>	ET/VDC	565	44.2	15-36
D		<i>Potamoschistus minutus</i> <i>Gobius niger</i>	ET/VDC	367	28.7	20-84
B	Syngnathidae	<i>Nerophis ophidion</i>	ET/VDC	174	13.6	103-256
C	Gasterosteidae	<i>Spinachia spinachia</i>	ET/VDC	71	5.5	63-140
C		<i>Gasterosteus aculeatus</i>	ET/VDC	47	3.7	20-75
B	Syngnathidae	<i>Syngnathus typhle</i>	ET/VDC	32	2.5	42-237
D	Zoarcidae	<i>Zoarcetes viviparus</i>	ET/VDC	10	0.8	120-300
B	Syngnathidae	<i>Syngnathus rostellatus</i>	ET	4	0.3	100-113
D	Cottidae	<i>Taurulus bubalis</i>	ET/VDC	3	0.2	37-43
D		<i>Myoxocephalus scorpio</i>	VDC	2	0.2	113-127
C	Labridae	<i>Ctenolabrus rupestris</i>	ET/VDC	2	0.2	47-51
D	Gadidae	<i>Gadus morhua</i>	VDC	1	0.1	120
Sum				1278	100.0	15-300
Decapoda						
E	Portunidae	<i>Carcinus maenas</i> L.	ET/VDC	371	-	carapace length > 20 mm

The semi-pelagic two spotted goby, *Gobiusculus flavescens*, was by far the most common species, both by VDC and ET. The VDC method recorded the demersal gobies, *Gobius niger* and *Pomatoschistus minutus*, as the second frequent species, whereas the straight-nosed pipefish, *N. ophidion* occupied rank two as determined with the ET (Tab. 3).

Table 3. Comparison of species composition, numbers of fish and shore crabs as well as richness and diversity detected with enclosure traps (ET) and visual diving census (VDC) during comparative sampling of 60 m² eelgrass bed in August, September and October 2003. *Pomatoschistus minutus* and *Gobius niger* were combined due to uncertain discrimination during the visual diving census

Species	21 Aug 2003		25 Sep 2003		27 Oct 2003		Sum	
	ET	VDC	ET	VDC	ET	VDC	ET	VDC
<i>N. ophidion</i>	23	4	40	-	84	23	147	27
<i>S. rostellatus</i>	1	-	2	-	1	-	4	-
<i>S. typhle</i>	9	-	17	-	4	2	30	2
<i>G. niger/ P. minutus</i>	37	168	34	104	7	17	78	289
<i>G. flavescens</i>	18	8	150	357	33	-	201	365
<i>G. aculeatus</i>	33	-	12	1	-	-	45	1
<i>S. spinachia</i>	12	4	12	12	11	20	35	36
<i>T. bubalis</i>	1	-	-	2	-	-	1	2
<i>M. scorpio</i>	-	-	-	-	-	2	-	2
<i>Z. viviparus</i>	4	2	2	2	-	-	6	4
<i>G. morhua</i>	-	-	-	1	-	-	-	1
<i>C. rupestris</i>	-	1	1	-	-	-	1	1
Sum	138	187	270	479	140	64	548	730
Richness	9	6	9	7	6	5	10	11
Diversity	1.82	0.47	1.41	0.71	1.13	1.30	1.65	1.09
<i>C. maenas</i>	56	77	28	96	15	99	99	272

Only minor differences in species composition were seen between the methods. *Myoxocephalus scorpio* and *Gadus morhua* were detected only by the diving census method, whereas *Syngnathus rostellatus* was exclusively detected with the ET. The portunid crab, *C. maenas*, was also very common in the eelgrass meadow, but was underrepresented in the ET catches (Tab. 3). The number of species and their abundances varied greatly with sampling date and method. In September the divers found high numbers of swarming two spotted gobies (*G. flavescens*) feeding above the transects. In August and October no such aggregations were observed and thus only some or no *G. flavescens* were found. On each sampling occasion the species richness recorded with the ET was consistently higher than with the VDC counts, but the divers recorded a total of

11 fish species compared to 10 by the ET method (Tab. 3). If the total number of species recorded by the two methods ($S=13$) is assumed to be the closest approximation to the actual species number, an average of 69 % (Aug. and Sep.) and 46 % (Oct.) of the species richness was captured with the ET and only 54 % (Aug. and Sep.) and 38 % (Oct.) by VDC.

Diversity

The Shannon-Weaver diversity index calculated for both methods showed divergent trends over the sampling period, with increasing values for the VDC and decreasing values for the ET. In August and September ET catch diversity exceeded that established by the diving census, but in October this trend was reversed (Tab. 3). These differences could be related to the relatively low species richness but high numbers of *G. flavescens* and demersal gobies detected by the divers, affecting evenness and thereby diversity. Total species richness decreased in October, as detected by both methods, but the ET diversity index was lower (Tab. 3). This was not explained by richness but by the relatively high abundances of *N. ophidion* and *G. flavescens* captured by the ET, affecting evenness. The ET appears to reflect the biological diversity and species richness much more accurately than the VDC.

Abundance

Significant differences in total fish abundances obtained by the two methods only occurred in October ($H_{(1,N=12)}=7.99$, $p=0.005$), where the ET catch characteristics were superior to the visual diving census technique. Both the ET ($H_{(2,N=18)}=8.67$, $p=0.01$) and the VDC ($H_{(2,N=18)}=15.19$, $p=0.005$) detected significant difference in fish abundance between the sampling occasions.

Mean total numbers and total fish abundances determined with the ET were lower than values obtained by the VDC method, but the efficiency values were not significantly different, independent of the presence of *G. flavescens* (Tab. 4 and 5).

Table 4: Total number and total mean abundance (\pm SD) of fish and shore crab (*Carcinus maenas*) obtained by enclosure trap (ET) and visual diving census (VDC) in August, September and October 2003 in an eelgrass bed at Kiel Bight. ET = Enclosure trap, VDC = visual diving census, w/o = without, Gobfla = *Gobiusculus flavescens*

Method	Area	Number	Abundance	21 Aug 03	25 Sep 03	27 Oct 03
	[m ²]	[N]	n=18 [N m ⁻²]	n=6 [N m ⁻²]		
ET	180	548	3.0 \pm 1.4	2.3 \pm 0.9	4.5 \pm 1.2	2.3 \pm 0.8
VDC	180	730	4.1 \pm 3.5	3.1 \pm 0.6	8.0 \pm 3.5	1.1 \pm 0.4
ET (w/o Gobfla)	180	347	1.9 \pm 0.1	2.0 \pm 0.5	2.0 \pm 0.5	1.8 \pm 0.6
VDC (w/o Gobfla)	180	365	2.0 \pm 1.0	3.0 \pm 0.8	2.0 \pm 0.6	1.1 \pm 0.2
ET (<i>C. maenas</i>)	180	99	0.6 \pm 0.3	0.9 \pm 0.4	0.5 \pm 0.2	0.3 \pm 0.2
VDC (<i>C. maenas</i>)	180	272	1.5 \pm 0.2	1.3 \pm 0.6	1.6 \pm 0.6	1.7 \pm 0.4

The statistical analysis revealed the selective features of the two methods based on the behavioural classifications and microhabitat categories of the fish. These results should be used to improve the abundance estimates derived from both methods.

Relative catch efficiency

Gobiusculus flavescens

For the shoaling two spotted goby, *G. flavescens*, (category A) no significant differences in the relative catch efficiency were found, but relative efficiency values indicated restricted catch characteristics for ET (Tab. 5). The estimated efficiency values declined slightly during the experiment but remained stable after 9 simultaneous comparisons. Frequency graphs of the x values showed minor positive and negative variations (zero indicated no differences in efficiency) but several negative values misalign the weighting towards negative x values (Fig.3A). To obtain improved abundance estimates for *G. flavescens* the catches made by the ET should be multiplied by 1.5.

Table 5. Efficiency values (r) of the enclosure trap (ET) relative to the visual diving census (VDC) transect technique and results from statistical comparison (sign test). For behavioural categories (BC) see Table 2

BC	r	n	Z	P
A	0.44	18	0.52	0.61
B	4.00	18	4.00	0.0001
C	1.83	18	2.12	0.03
D	0.28	18	3.54	0.0004
E	0.39	18	3.40	0.0007
Total (A-D)	0.76	18	0.24	0.81
Total (B-D)	1.05	18	0.49	0.63

Syngnathidae

As expected, the Syngnathidae (category B) were detected with high relative efficiency by the ET, significantly higher than the diving census (Tab. 5). All median efficiency values ranged between 4 and 5 indicating the severe limitations of the VDC method for phytomimetic and well-camouflaged fish hiding motionless in dense vegetation, escaping the attention of the divers. Variation in the frequency graph is low and limited to values between 3 and 4 (Fig. 3B). The abundances estimates obtained by a diving census should be corrected by multiplying abundance values for Syngnathidae by a factor of 4.0.

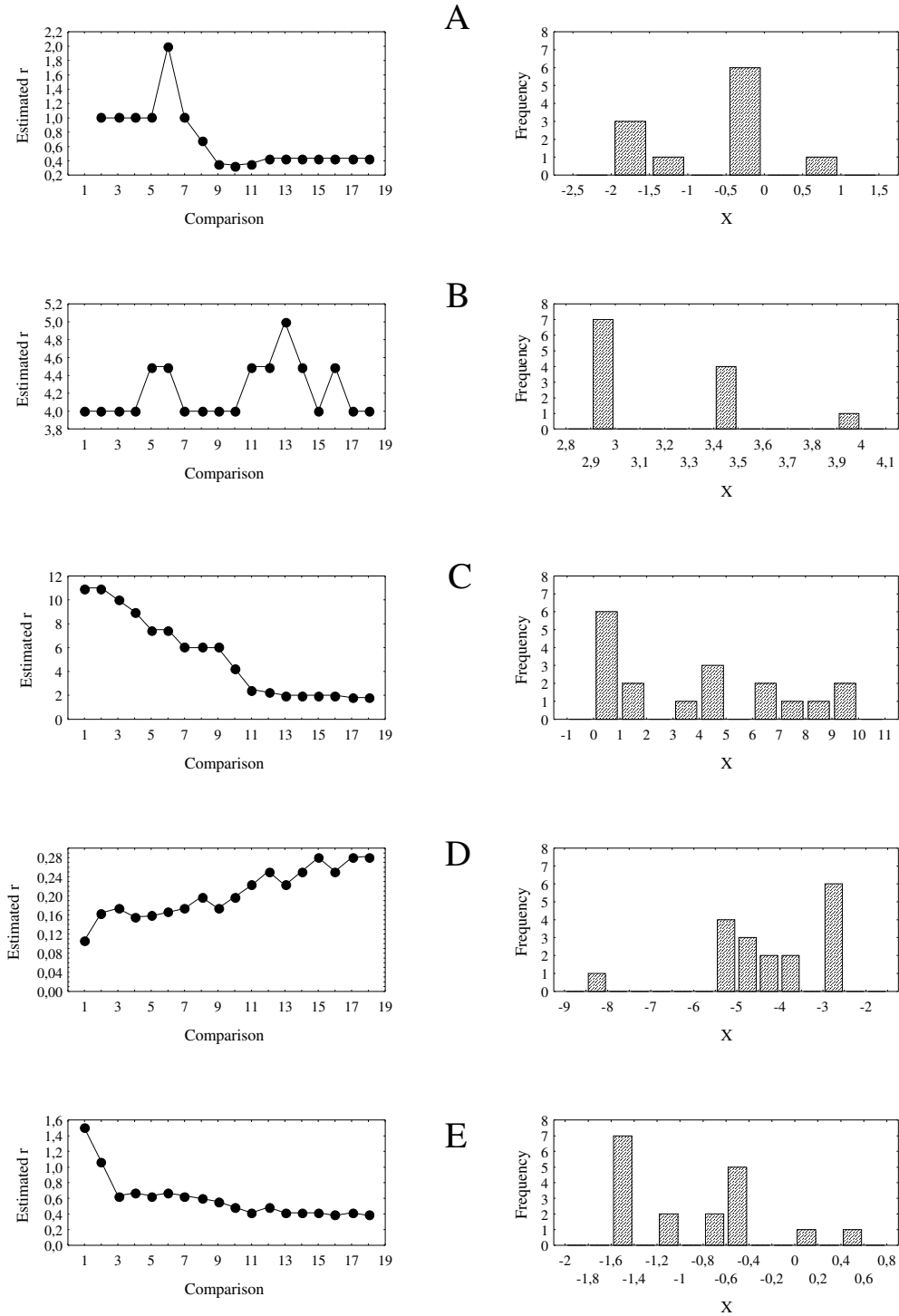

Fig 3. Frequency graphs of the x-values and estimated relative catch efficiency (r) for the chronologically increasing number of comparisons made between the enclosure trap (ET) and visual diving census (VDC). Results are shown for behavioural classifications and microhabitat preferences: *Gobiusculus flavescens* (A), Syngnathidae (B), Gasterosteidae (C), bottom dwelling Gobiidae (D), and portunid crab *Carcinus maenas* (E). Note that the scales differ

Gasterosteidae

The Gasterosteidae (category C) are composed of the fifteen-spined stickleback, *S. spinachia* and the three-spined stickleback *G. aculeatus*. *Spinachia spinachia* was recorded in similar total abundances by both methods. Significant differences in relative catch efficiency (Tab. 5), however, were attributed to the three-spined sticklebacks, *G. aculeatus*, which seems to avoid the divers and thus is rarely detected. During the sampling period from August to October the ET abundances decreased, whereas the diving census abundances increased (Tab. 3). These contrasting trends with decreasing differences in abundance estimates during the study period lead to consistently decreasing efficiency values. Variations of x values in the frequency graphs indicate the better detection characteristics of the ET (Fig. 3C). VDC abundance estimates for the three-spined stickleback in eelgrass beds should be corrected by a factor of 1.8.

Bottom dwellers

The comparison revealed the serious limitations of the ET for estimating the bottom dwelling fish (category D). Significant differences in relative detection efficiency between the methods were discovered for the demersal Gobiidae, represented by *P. minutus* and *G. niger*, which seem able to avoid capture by the ET (Tab. 5). The relative efficiency values increased during the study (Fig. 3D) due to decreasing differences in abundance between the methods over the sampling period (Tab. 3). The frequency graphs of the x values showed one outlier, but consistently negative values supporting the general findings of the comparison. Abundance estimates by the ET should be adjusted by a factor of 1.7.

Carcinus maenas

Significant differences in relative detection efficiency between the methods were also discovered for the shore crab (Tab. 5), *C. maenas*, which seems to be able to avoid capture by the ET. The median of the efficiency values remained relatively stable after 11 comparisons indicating minor variation in catch efficiency between the methods over the sampling period (Fig. 3E). Variation in the frequency graphs included positive as well negative x values, with more negative numbers (Fig. 3E). The correction value suggested for the shore crab is 1.6 for the ET.

Divers

The abundance estimates for fish do not differ significantly between the divers. Significant statistical differences in abundance estimates occurred only for the shore crab (*C. maenas*) in October 2003 (Tab. 6).

Table 6. Statistical comparison of the total fish and shore crab (*Carcinus maenas*) abundances estimated by the two divers during visual diving census. n=number of replicate samples

Sampling date	category	n	T	Z	p
21 Aug 03	Total fish	12	36	0.24	0.81
	Shore crab	12	11	1.05	0.29
25 Sep 03	Total fish	12	36	0.24	0.81
	Shore crab	12	19	1.24	0.21
27 Oct 03	Total fish	12	11	1.36	0.17
	Shore crab	12	0.0	2.80	0.005

However, variability between divers was small compared to variability between sampling occasions (Tab. 4).

Visual estimate of fish length

The size-frequency distribution based on estimated sizes was in good agreement with the directly measured individuals. For this reason the use of 10 mm interval size classes for the length measurements of the divers is justifiable. The data illustrate that the divers were able to estimate fish sizes with a high degree of precision. However, the curves for the Gobiidae (Fig. 4A and 4D) based on visual estimates were shifted slightly to the left, indicating that divers tend to underestimate the length of these fish. Suboptimal agreement of length frequency distributions between the methods was found for the Syngnathidae and the Gasterosteidae (Fig. 4B and 4C). Larger individuals (>160 mm long) of the Syngnathidae were rarely found during the diving census counts (Fig. 4B) indicating a lower detection efficiency for adult pipefish. The Gasterosteidae showed opposite results. Smaller *G. aculeatus* and *S. spinachia* (<80 mm long) were rarely detected by the divers (Fig. 4C). Whereas *G. aculeatus* was almost absent from the divers' counts, probably due to its avoidance response, juvenile *S. spinachia* were not seen because of their camouflaged behaviour and coloration.

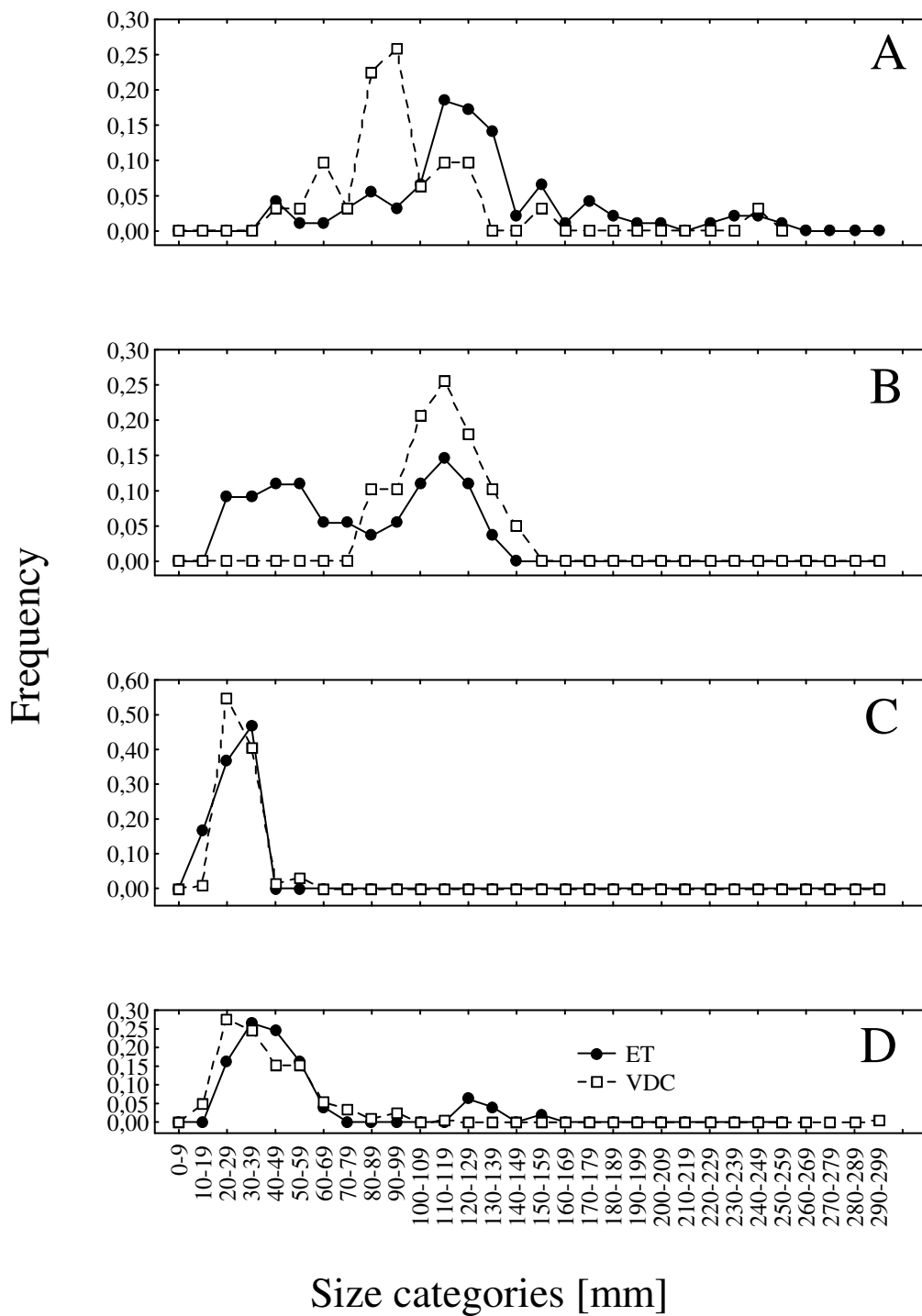

Fig. 4. Size-frequency distribution based on in situ estimates of fish size by visual diving census (VDC) transect technique and directly measured fish size obtained by enclosure trap (ET) sampling. Results are shown for behavioural classifications and microhabitat preferences: *Gobiusculus flavescens* (A), Syngnathidae (B), Gasterosteidae (C), bottom dwelling fish (D)

Discussion

In this investigation the catch efficiency of a newly constructed enclosure drop trap, which operates without the help of divers, was compared with a visual diving census technique carried out simultaneously in an eelgrass bed of the Baltic Sea. The methods differ in their characterisation of the fish fauna. Differences were found in the rank order of frequent fish species. The fish species spectrum represented by both methods was consistent with results of other investigations of shallow water habitats in the Baltic Sea (Winkler and Thiel 1993, Bischoff et al. 1997, Thetmeyer 1998). This was true for species richness as well as abundance (Jansson et al. 1985, Hunter-Thomson et al. 2002). More than 30 fish species can be found in the shallow waters of the western Baltic Sea (Gründel 1980, Thetmeyer 1998). Thetmeyer (1998) surveyed eight stations at 2, 4 and 8 m depth with visual diving transect census and 17 stations with beam trawl (3 m beam length, 1 cm mesh size) at approximately 6 m depth. The VDC detected 1-10 fish species at each site respectively, sampling 3x25 m strip transects of 2 m width. The beam trawl found 1-14 species at each station. These results are in accordance with the richness detected by both methods in this study. The species richness detected by the ET was negligibly higher on each sampling occasion compared to the diving census technique. Only minor differences in species composition were obtained over the sampling period by the two methods, the visual census detected 11 and the ET 10 species (Tab. 3). Diversity and time course of abundances showed contrasting results, with diversity values for the pooled data being higher from the ET than from the VDC technique. No differences in efficiency in terms of total fish abundance were found (Tab. 5), but significant differences occurred with regard to the behavioural classifications of the eelgrass fish assemblage. These results indicate that the new ET yields consistent and adequate predictions about the fish community structure and abundance in eelgrass beds.

Selectivity and fish behaviour

Pelagic species

The common semi-pelagic *G. flavescens*, which aggregates in large schools above the eelgrass canopy, was detected with low relative efficiency by the ET although there were no significant differences between the methods (Tab. 5). Fast-swimming, pelagic, schooling species are generally underrepresented in enclosure traps (Rozas and Minello 1997). Depending on the presence or absence of the schools, density estimates from the two methods varied greatly between sampling occasions. Numerous replicate hauls and

observations are required to avoid this bias, although another approach is to exclude schooling pelagic fish from the analyses because of the data distortion they cause (Edgar et al. 2001).

Crypsis and avoidance

Bias may be introduced because of the differential visibility of fish. Small cryptic fish can be underestimated by more than an order of magnitude by the visual diving census, even with meticulous searches of small areas (Brock 1982, Willis 2001). Pipefish of the family Syngnathidae were among the most frequent species captured by the ET in this study (Tab. 3). The Syngnathidae are characterized by an ambush feeding mode or a slow approach to prey. Their slow movements and crypsis make it difficult for the divers to quantify these species. In particular, adult individuals >160 mm long were rarely discovered by the divers (Fig. 4), because of their perfect camouflage coloration and the behaviour of adults as compared to juveniles. On the other hand, the ET efficiently captured these cryptic forms, which are often closely associated with the eelgrass and show a low escape response. Small individuals may however have escaped the ET due to their morphology. Although the inspection field of each diver was only 0.5 m wide, phytomimetic Syngnathidae were significantly underestimated compared to the ET method (Tab. 5), which caught six times more Syngnathidae than were detected by the visual diving census.

Other small fish, like the frequent Gasterosteidae, were slightly underestimated by the diving census method. The fifteen-spined stickleback, *S. spinachia*, was detected in similar abundances by both methods, indicating low avoidance response and good perception by the divers. In contrast, the three-spined stickleback, *G. aculeatus*, exhibited the lowest detectability and was almost absent from VDC counts. The ET, however, showed *G. aculeatus* to be a frequent eelgrass inhabitant, rank four in the frequency of fish species (Tab. 3). A pronounced avoidance response of *G. aculeatus* to the silhouette and the noise of divers, noted by Jansson et al. (1985), was also found in this study. Significant differences in relative catch efficiency for the Gasterosteidae between the two methods was directly related to the avoidance response of *G. aculeatus*. Because the ET operates vertically, it does not seem to induce any pronounced avoidance response in *G. aculeatus*.

Demersal fauna

The bottom dwelling fish (mostly Gobiidae) and the shore crab, *C. maenas*, were caught with significantly reduced efficiency by the ET compared to the visual census (Tab. 5). These results are in general accordance with published data, e.g. Rozas and Minello (1997), who stated that sedentary, non-schooling animals are generally underrepresented in enclosure trap catches.

The avoidance response of benthic Gobiidae to divers seems to be less pronounced than in the three-spined stickleback but demersal Gobiidae particularly hide in sea floor irregularities and depressions and partly escaped the ET. The avoidance reactions of the Gobiidae occur horizontally, close to the ground, only 28% bottom dwelling Gobiidae were guided vertically into the ET.

Shore crabs are able to hide by burying themselves in the sediment, a feature that may explain the reduced relative catch efficiency of the ET. Only 39% of the shore crabs were detected by the ET compared to the diving census (Tab. 3).

Species identification

A major problem of the visual diving census was the species identification in situ. Notably the bottom dwelling juvenile Gobiidae, *P. minutus* and *G. niger*, could not easily be distinguished by the divers (Edlund et al. 1980). In situ identification of *P. minutus*, *P. microps* and *P. pictus* appeared almost impossible, but *P. microps* and *P. pictus* are assumed to be absent from the study area because neither was found during intensive ET sampling attempts in the same eelgrass bed over two years. Demersal Gobiidae were pooled in the bottom-dwelling fish category. Uncertainties with respect to other rare species could be overcome by capturing with small dip nets for identification, but this method is not applicable to highly abundant species like the Gobiidae. The ET, in contrast, provides (a priori) the possibility of definitive identification of the captured animals.

Mesh size

The 6 mm mesh size used in this investigation excluded quantitative sampling of larval and juvenile stages. Smaller mesh sizes were not tested, but would presumably increase the early faunal stages in the catches although they may also affect the descent of the trap.

Diver variability

Edgar et al. (2004) pointed out that the diving strip transect technique used in this investigation is not greatly affected by variability between divers. However, other authors suggested that the variability between divers confounded the analysis of diving census data (Thompson and Mapstone 1997). In this study the variation between the two divers was tested and found not to be significantly different (except for *C. maenas* in October) and to be relatively low (Tab. 6) compared to the variability between sampling dates.

Visual size estimates

During the visual diving census fish were measured against a ruler marked with cm increments and the results were compared to direct measurements of the fish captured with the ET. The census divers were found to be capable of making precise size estimates, but with a slight tendency to underestimate the size of small fish (Fig. 4). Major differences in size-frequency distribution only occurred for the Syngnathidae and the Gasterosteidae, but this may be due to the low numbers of Syngnathidae and *G. aculeatus* detected by the VDC. Edgar et al. (2004) found that divers' size estimates become increasingly inaccurate as fish size deviates from 300 mm. Fish <175 mm long were underestimated by about 20% and fish >400 mm long were overestimated by about 10%.

Comments and recommendations

In the present investigation some general drawbacks of the ET were found: (1) solid and irregular sediment with big stones made sampling impossible, (2) disturbance involved with the sampling procedure and rough seas may increase the avoidance response of fish due to the noise, shadows and vertical movements of the ET within the water column, (3) the shutter mechanism worked inadequately if the pull direction of the shutter rope was not more or less parallel to the long axis of the trap, (4) the catches were highly variable due to the small sampling area of the ET, (5) the trap is unsuitable for sampling adequately larger areas, and (6) the ET is not suitable for catching larger fishes.

On the other hand, the enclosure trap has several advantages over other assessment techniques: (1) the portable trap is relatively cheap and can be used in dense *Z. marina* beds, <600 shoots m², (2) it can yield a relatively high number of replicates and allows repeated sampling at short time intervals from relatively small areas or experimental plots essential in coastal monitoring programmes and scientific research, (3) the trap enclosed a defined area, important for quantitative assessments, (4) it could be used at depths down to

five meters without the help of divers, (5) it collected relatively clean samples minimizing time-consuming sorting, (6) high spatial resolution allowed the determination of indices of dispersion, and (7) the fish were collected live and with minimal trauma, facilitating identification, accurate length and weight measurements, gut content analysis with the option of live release.

The enclosure trap as presented here is a useful sampling device for the rapid and easy assessment of the fish community in eelgrass beds. The correction coefficients for different behavioural groups and species facilitate quantitative sampling of small common eelgrass nekton. The limitations and suitability of the visual diving census for detecting the different behavioural categories of small fish in dense eelgrass beds are now better understood. The enclosure trap and visual diving census methods are complementary and their simultaneous use can be recommended to obtain accurate quantitative estimates of eelgrass fish populations. Data on the relative capture efficiency of the enclosure trap can be used to improve abundance measurements of small fish in *Zostera marina* eelgrass beds without the help of divers.

Acknowledgement

This research was funded by the environmental foundation Deutsche Bundesstiftung Umwelt (DBU). We would like to thank Thomas Walter and Michael Bachmann for assembling the enclosure trap and Uwe Kuchler (Rolladen-Kuchler Company) for putting two roller shutters at our disposal. We also thank Klaus Kreyelkamp for developing an accurate scale drawing of the enclosure trap, Björn Thoma and Michael Teßmann for help with the underwater diving census and Kerstin Maczassek for collecting and analysing eelgrass samples. Eileen J. Cox kindly helped to improve the English.

Chapter II

Seasonal variation of fish community and habitat structure in an eelgrass bed (*Zostera marina* L.) in the Southern Baltic Sea

Abstract

A *Zostera marina* bed in the Greifswald Lagoon and its associated fish population were quantitatively investigated in monthly intervals from May 2002 to December 2002 and from March 2003 until August 2003 to determine seasonal aspects of their community structure. Additionally, abiotic parameters such as water temperature, salinity, and Secchi disc transparency were recorded. The results of the eelgrass and fish samples were correlated with abiotic parameters. Twelve fish species were found, but only 5 of them were frequent in the eelgrass meadow. The fish community was dominated by Gobiidae, Syngnathidae and Gasterosteidae, which comprises 97% of the fish abundance and 35% of the fish biomass. Total fish abundances and biomass increased significantly during night catches. Abundances and biomasses of fishes as well as eelgrass shoot densities and biomasses indicated strong seasonal variations and displayed seasonal characteristics with maximum values in spring and summer, respectively. The correlation analysis revealed significant relationships between eelgrass structure, fish community and abiotic parameters. Water temperature displayed significant negative correlation with secchi-depth (water transparency) and secchi-depth on its part correlated significantly with eelgrass biomass and fish biomass. Weak correlations between the biomass of the phytomimetic straight-nosed pipefish, *Nerophis ophidion*, and eelgrass leaf area were observed. Significant correlations between fish abundance and eelgrass biomass were detected, when the three spined sticklebacks, which achieved highest abundances during spawning season in May, were excluded from the analysis. Water transparency and water temperature were assumed to be important factors structuring eelgrass beds and its associated fish community in the Greifswald Lagoon.

Introduction

Eelgrass meadows are important coastal ecosystems. They fulfil various physical, chemical and biological functions and the leaves provide a complex spatial structure to its inhabitants (Heck and Crowder 1991). Eelgrass beds offer protection from predators and dispersal by water currents and act as nursery- and feeding grounds (Watson et al. 1993, Murphy et al. 2000). Numerous investigations have shown that the eelgrass associated fish fauna is diverse and the abundances of fishes are frequently orders of magnitude higher than in nearby unvegetated sandy areas (Hyndes 2000). The diversity of the fauna is most often explained by the greater food supply in comparison to other habitats and by greater survival of prey organisms. Only few studies concerning the fish community in eelgrass meadows of the Baltic Sea exist. Most investigators sampled the shallow water fish fauna in general and did not explicitly focus on the fish community living in eelgrass meadows. Worthmann (1975) investigated the fish fauna at three shallow sites in the Kiel Bight, including two eelgrass meadows. His main focus, however, was on the macrozoobenthos invertebrate community, and the catch efficiencies of the towed fishing device used in his work were unknown. In the lower Chesapeake Bay Orth and Heck (1980) found positive relationships between total fish abundance and eelgrass biomass. They explained this relationship with the greater food supply due to the presence of a denser invertebrate population associated with the increasing shoot density and protection offered by the eelgrass shoots. Adams (1976a and b) analysed and compared two *Zostera marina* (Linnaeus, 1758) beds in North Carolina to determine aspects of their fish community structure. He found significant correlations between fish biomass, water temperature and eelgrass biomass. He considered water temperature to be the main factor influencing the biomass of fishes. Stoner (1983) investigated several structural eelgrass parameters in relationship to fish colonisation. On one site he found strong correlations between fish abundance and eelgrass biomass. On another site fish abundances significantly correlated with blade densities.

In the present study the structure of the fish fauna of a temperate eelgrass meadow (*Z. marina*) in the Greifswald Lagoon (Baltic Sea) is described. Abundance, biomass and diversity of the fish community were determined. At the same time shoot density, leaf area and eelgrass biomass were measured, as well as water temperature, salinity and water transparency (secchi-depth). The seasonal fluctuations of the eelgrass bed and the associated fish community were described and seasonal fish data were correlated with

eelgrass structural parameters and abiotic factors to elucidate interrelationships between these factors.

Study area

The investigated area was an eelgrass meadow in the south east of Vilm Island located in the northern part of the Greifswald Lagoon (Fig. 1).

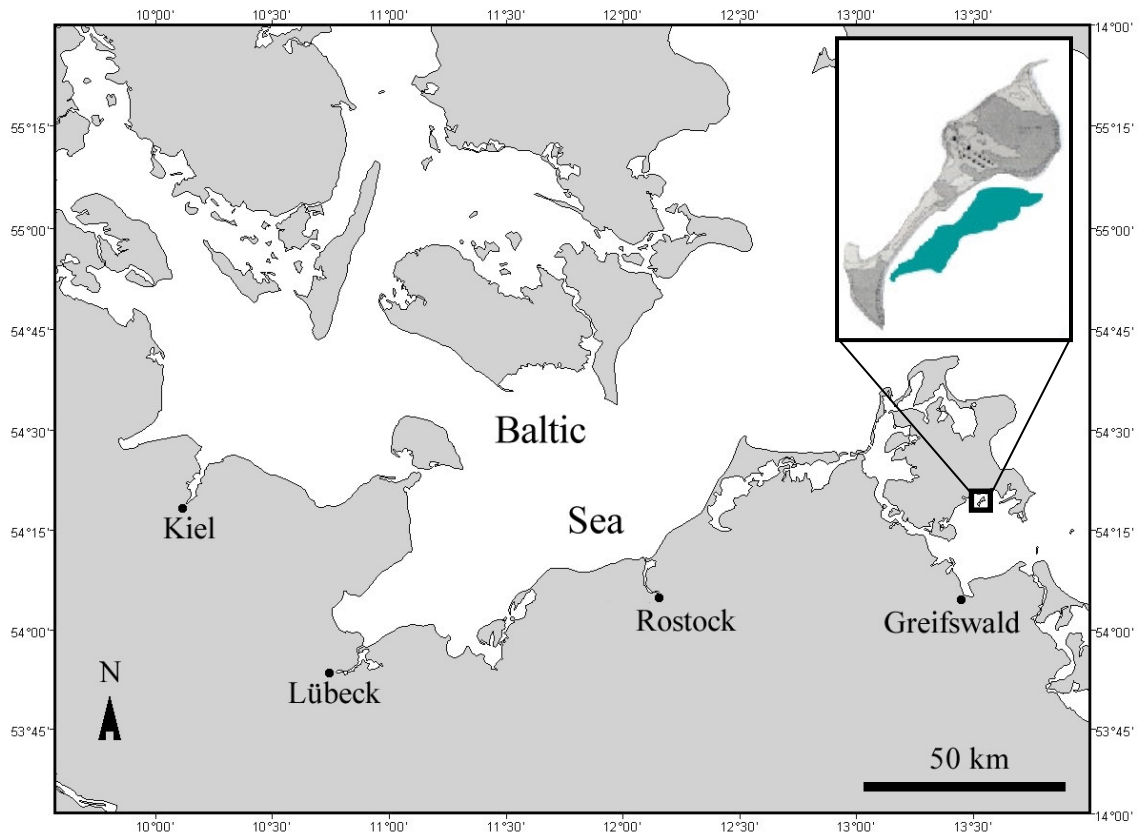

Fig. 1. Sampling site in the Greifswald Lagoon with Vilm Island. The dark shaded area indicates the sampling location and the expansion of the eelgrass meadow

The Greifswald Lagoon is a shallow semiclosed bay characterised by a water surface area of 514 km², a water volume of 3*10⁶ m³ and a mean depth of 5.6 m. The salinity ranges from 5.3 to 12.2 psu with a mean value of 7.5 psu (Schwier 2001). The bay is characterised by high nutrient supply and high pelagic primary production. There is no tidal range. Aperiodic water level fluctuations between 30 and 100 cm depend on wind direction and wind speed. Water exchange with the Baltic Sea takes place through the Strela Sund and the opening to the Pommerian Bay (Jönsson et al. 1998). Eelgrass occurs in the south-eastern parts of Vilm Island in depths from 2.2 to 3.6 m and builds up monotypic stocks, occasionally interrupted by small unvegetated sandy areas. The study area is exposed to wind and waves. The sediment is sandy-grit with lack of big stones. Towards the shore the

eelgrass meadow is bordered by expanded stands of *Potamogeton pectinatus* L. and to the open water by sandy to muddy ground (Messner and von Orthen 1991).

Material and Methods

Fishes

The fish community of the eelgrass bed was quantitatively sampled with an enclosure drop trap once a month from May 2002 until December 2002 (except July 2002) and from March 2003 until August 2003 (except June 2003). Ice cover in January and February 2003 made sampling infeasible. Night sampling was conducted in 2003 on Aug 26 to Aug 27, during 22:30 p.m. and 3:30 a.m. Fifty hauls with the enclosure trap were conducted at each sampling date, comprising 100 m² sampled eelgrass area. During night sampling we performed only thirty hauls. Bobsien and Brendelberger (2006) provide a detailed description of the trap, its sampling characteristics and relative efficiency coefficients, calculated for bottom dwelling fishes, leaf associated fishes and fishes swimming above the eelgrass canopy. The abundance and biomass values of demersal gobiids were corrected using an efficiency coefficient of 1.7. The net mesh opening of the enclosure drop trap was 6 mm and samples were taken in 2.5 to 4.0 m depth. The fish species were identified to species level, counted, measured and weighted. Total abundance and biomass values were related to 100 m² eelgrass meadow. All other abundance values are presented as means of fifty enclosure trap hauls and were calculated for 1 m² eelgrass area. I summed fish biomass for each sampling occasion and divided it through the sampled eelgrass area. Wet mass for fishes were recalculated on the assumption that water content was 78 % (Heerkloss 1996). The richness is the number of fish species captured in the eelgrass meadow. To characterise the fish diversity the Shannon-Weaver diversity index (H') was calculated, based on species numbers for each month, on the logarithm to the basis e. Rare fish species (total mean abundance <10 individuals per 100 m²) and the three-spined stickleback, which utilise the eelgrass meadow for spawning, were excluded from the regression analysis.

Eelgrass

The eelgrass shoot density, above-ground biomass and leaf area was investigated in monthly periods from May until December 2002. Shoot densities were counted by divers in ten squares of 625 cm², respectively. Shoot parameters were established out of six randomly chosen sub samples, composed of ten to twelve adjoining eelgrass plants. Eelgrass shoots were divided into single leaves and leaf length, leaf area as well as the number of leaves per shoot (vegetative and reproductive) was determined. To calculate leaf area the leaf width and length were measured with 1 mm accuracy. Eelgrass samples were dried for 24 h at 60°C (Short and Duarte 2001). The above-ground wet biomass was recalculated on the basis of conversion factors (dry mass [g] = 0.032+0.107 wet mass [g], R²=0.93, n=203) established in the context of a monitoring programme in 2001 that had been carried out in the same eelgrass meadow.

Abiotic parameters

The water temperature, salinity and secchi-depth were measured once a week from May to December 2002.

Results

Fish community

Twelve different fish species out of nine families were collected from the eelgrass meadow. The bottom dwelling gobiids represented the most abundant fish family followed by the syngnathids and gasterosteids. *Potamoschistus microps*, *P. minutus* (Gobiidae), *Syngnathus typhle*, *Nerophis ophidion* (Syngnathidae), and *Gasterosteus aculeatus* (Gasterosteidae) were the five most frequent fish species captured during the study. Notable was the lack of cyprinids (Tab. 1).

Table 1. Number, size, wet biomass ranges and sum of wet biomass of all fish species detected in the eelgrass meadow in the Greifswald Lagoon during monthly sampling from May 2002 to August 2003

Family	Species	N	TL [mm]	Mass [g]	ΣMass [g]
Gobiidae	<i>Potamoschistus microps</i>	620	20-39	0.06-0.34	70.7
	<i>Potamoschistus minutus</i>	571	21-57	0.04-1.0	78.4
Syngnathidae	<i>Syngnathus typhle</i>	191	34-175	0.01-2.4	72.4
	<i>Nerophis ophidion</i>	168	89-304	0.07-1.6	80.2
Gasterosteidae	<i>Gasterosteus aculeatus</i>	139	19-67	0.04-3.2	209.9
Gobiidae	<i>Gobius niger</i>	27	43-80	0.9-6.5	21.9
Percidae	<i>Perca fluviatilis</i>	20	72-107	5.1-13.0	211.6
Pleuronectidae	<i>Platichthys flesus</i>	4	142-163	31.7-43.4	131.5
Zoarcidae	<i>Zoarcetes viviparus</i>	4	108-127	5.3-9.7	26.2
Gasterosteidae	<i>Pungitius pungitius</i>	2	32-39	0.26-0.34	0.6
Ammodytidae	<i>Ammodytes tobianus</i>	1	79	0.7	0.7
Esocidae	<i>Esox lucius</i>	1	372	273.4	273.4

The five most common species constituted 97 % of the abundance but only 35 % of the total biomass. Total mean (\pm SE) fish abundance was $1.3 \pm 0.9 \text{ N m}^{-2}$ and total biomass $1.1 \pm 0.7 \text{ g m}^{-2}$. Biomass proportions of larger fishes such as *E. lucius*, *P. flesus* and *P. fluviatilis* were relatively high, because only adults of these species were captured (Tab. 2).

Table 2. Abundance and wet biomass of eelgrass fish community in the Greifswald Lagoon. Values are means (\pm SE) of 660 enclosure trap hauls and proportions [%] throughout the complete sampling period, including the night catch

Species	Abundance		Biomass	
	[N 100 ⁻¹ m ⁻²]	[%]	[g 100 ⁻¹ m ⁻²]	[%]
<i>P. microps</i>	47.7 \pm 36.0	35.7	5.4 \pm 3.7	4.9
<i>P. minutus</i>	43.9 \pm 36.1	32.8	6.0 \pm 3.7	5.5
<i>S. typhle</i>	14.7 \pm 5.7	11.0	5.6 \pm 1.6	5.1
<i>N. ophidion</i>	12.9 \pm 2.9	9.7	6.2 \pm 1.5	5.6
<i>G. aculeatus</i>	10.7 \pm 6.7	8.0	16.1 \pm 11.3	14.7
<i>G. niger</i>	2.0 \pm 1.2	1.5	1.7 \pm 1.0	1.6
<i>P. fluviatilis</i>	1.1 \pm 0.5	0.8	56.4 \pm 36.0	51.5
<i>P. flesus</i>	0.3 \pm 0.2	0.2	10.1 \pm 6.9	9.2
<i>Z. viviparus</i>	0.3 \pm 0.2	0.2	2.0 \pm 1.4	1.8
<i>P. pungitius</i>	0.2 \pm 0.1	0.1	0.05 \pm 0.03	0.1
Total	133.8 \pm 89.6	100.0	109.6 \pm 67.1	100.0

Day-night abundances

During night sampling on the total fish abundance increased significantly compared to the day sampling. The species composition did not change (Tab. 3).

Table 3. Statistical comparison (U-test) of the day and night fish abundances of each fish species captured in the eelgrass meadow of the Greifswald Lagoon. *P. minutus* and *P. microps* are combined in the genus *Pomatoschistus*

Species	n	T	Z	p
<i>N. ophidion</i>	30	16.0	0.28	0.78
<i>S. typhle</i>	30	12.5	1.18	0.24
<i>Pomatoschistus spp.</i>	30	3.0	4.38	0.00001
<i>G. niger</i>	30	0.0	1.60	0.11
<i>P. fluviatilis</i>	30	4.0	0.37	0.72
Total	30	10.0	4.39	0.00001

Pomatoschistus spp. were responsible for the heavy increase of total fish abundances during the night sampling. They achieved mean (\pm SE) night abundances of $8.4 \pm 0.9 \text{ N m}^{-2}$ (day $0.5 \pm 0.2 \text{ N m}^{-2}$), whereas the mean *S. typhle* abundance decreased compared to the day sampling (day $0.7 \pm 0.3 \text{ N m}^{-2}$, night $0.2 \pm 0.1 \text{ N m}^{-2}$). Abundances of *N. ophidion*, *G. niger* and *P. fluviatilis* did not increase significantly between day and night.

Seasonal variation of abundance and biomass

The total fish abundances and wet biomasses varied considerably during the sampling season 2002 and 2003. Maximum values occurred in May and August and minima in March and December. No fishes were captured in March 2003 (Fig. 2).

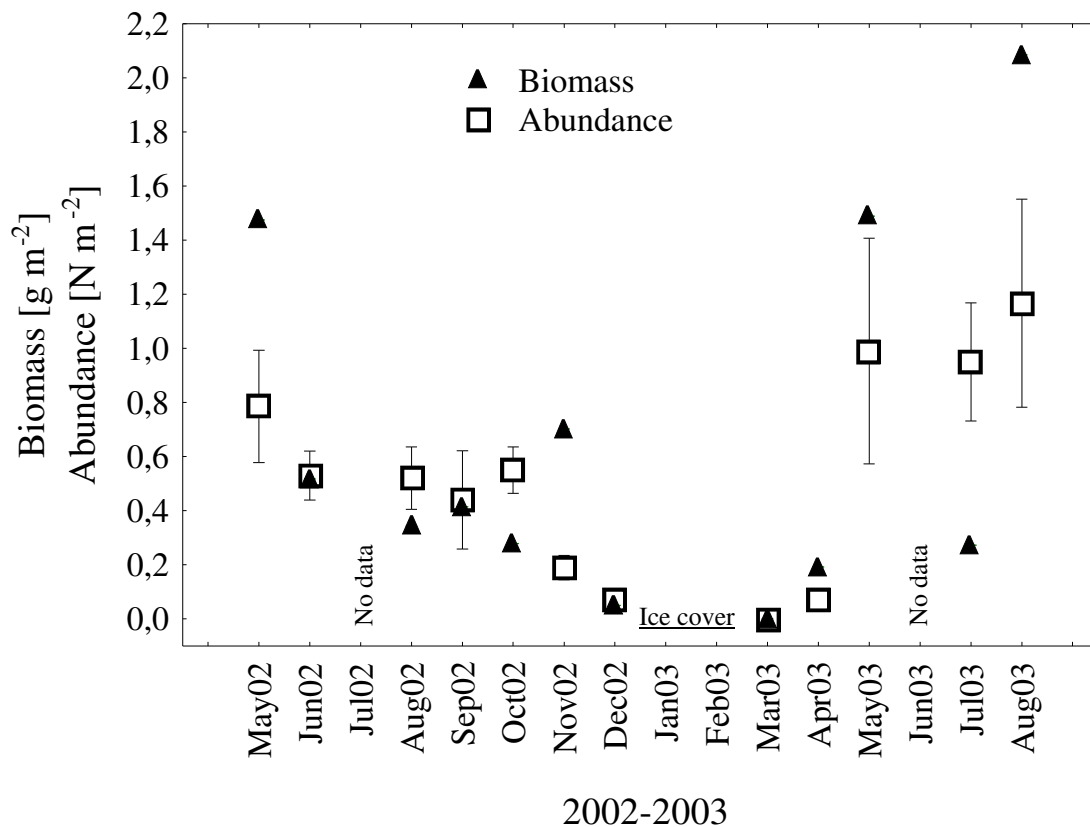

Fig. 2. Total fish abundances and wet biomasses of small fishes in the eelgrass meadow of the Greifswald Lagoon. Abundance values are means (\pm SE) of fifty trap hauls, biomass values are sums of each month

Three-spined sticklebacks *G. aculeatus* dominated fish community in May and June, *S. typhle* in the summer months and the gobiids in fall. *Nerophis ophidion* was most abundant (>20% proportion of abundance) throughout the sampling period in 2002, in 2003 the relative abundance did not exceed 20% (Tab. 4).

Table 4. Proportions [%] of abundance (A) and biomass (B) of the eelgrass fish community in the Greifswald Lagoon in 2002 and 2003. No fish individual was captured in March 2003. The scientific fish names were abbreviated with the first character of the genus and the first three characters of the species-specific epitheton. The full scientific names are given in Table 1. The grey background colour accentuated abundance and biomass values exceeding 20 %. Aug-d=day catch in August 26, Aug-n=night catch in August 26 to 27

2002	May		Jun		Aug		Sep		Oct		Nov		Dec		
	A	B	A	B	A	B	A	B	A	B	A	B	A	B	
Noph	24.6	4.7	51.9	31.1	27.8	14.4	53.2	27.9	40.8	52.0	13.3	2.9	20.0	24.5	
Styp	16.8	7.3	6.7	11.4	23.2	15.2	23.7	13.5	19.6	23.4					
Pmic	6.8	1.2	8.8	2.3	32.4	6.0	10.3	1.7	26.4	10.2	28.0	3.2	17.5	7.7	
Pmin	13.6	2.6	14.6	8.5	8.1	1.9	6.9	0.8	10.6	4.6	51.3	12.2	52.5	60.9	
Gnig	2.3	1.0							2.6	9.7					
Gacu	33.7	31.7	15.1	28.6							2.7	2.6			
Ppun					1.5	0.6								10.0	6.9
Pflu					6.9	61.9	5.9	56.1							
Zviv			2.9	18.1											
Pfle	2.3	51.5									4.7	79.1			

2003	Apr		May		Jul		Aug-d		Aug-n		Total	
	A	B	A	B	A	B	A	B	A	B	A	B
Noph	18.6	2.5	5.8	1.4	9.9	27.8	6.4	2.3	1.1	1.4	9.6	5.6
Styp			1.0	0.4	44.7	51.1	43.7	8.7	1.9	1.4	10.9	5.1
Pmic	16.3	1.2	3.4	0.1	15.6	8.0	35.5	1.6	94.6	16.0	35.5	5.0
Pmin	48.8	9.1	5.1	0.7	12.2	4.1	7.5	0.4			32.7	5.5
Gnig					1.7	0.6	3.7	1.3	1.5	2.0	1.5	1.5
Gacu			84.7	97.5	15.9	8.3					8.0	14.7
Ppun											0.1	0.04
Pflu							3.1	85.7	0.8	79.2	1.2	51.4
Zviv	16.3	87.1									0.2	1.8
Pfle											0.2	9.2

Gobiidae

The bottom dwelling common goby, *P. microps*, and the sand goby, *P. minutus*, were the most common fish species found in the eelgrass meadow. Except in March 2003 they were regularly found in the catches and could be considered residents in the eelgrass bed. The black goby, *G. niger*, appeared sporadically in the catches. The size spectrum of the gobiids ranged from 20 to 39 mm TL for the common goby and from 21 to 57 mm TL for the sand goby (Tab. 1). *Pomatoschistus microps* were most frequent in August 2003 with maximum mean (\pm SE) abundances of $0.4 \pm 0.2 \text{ N m}^{-2}$ (Fig. 3).

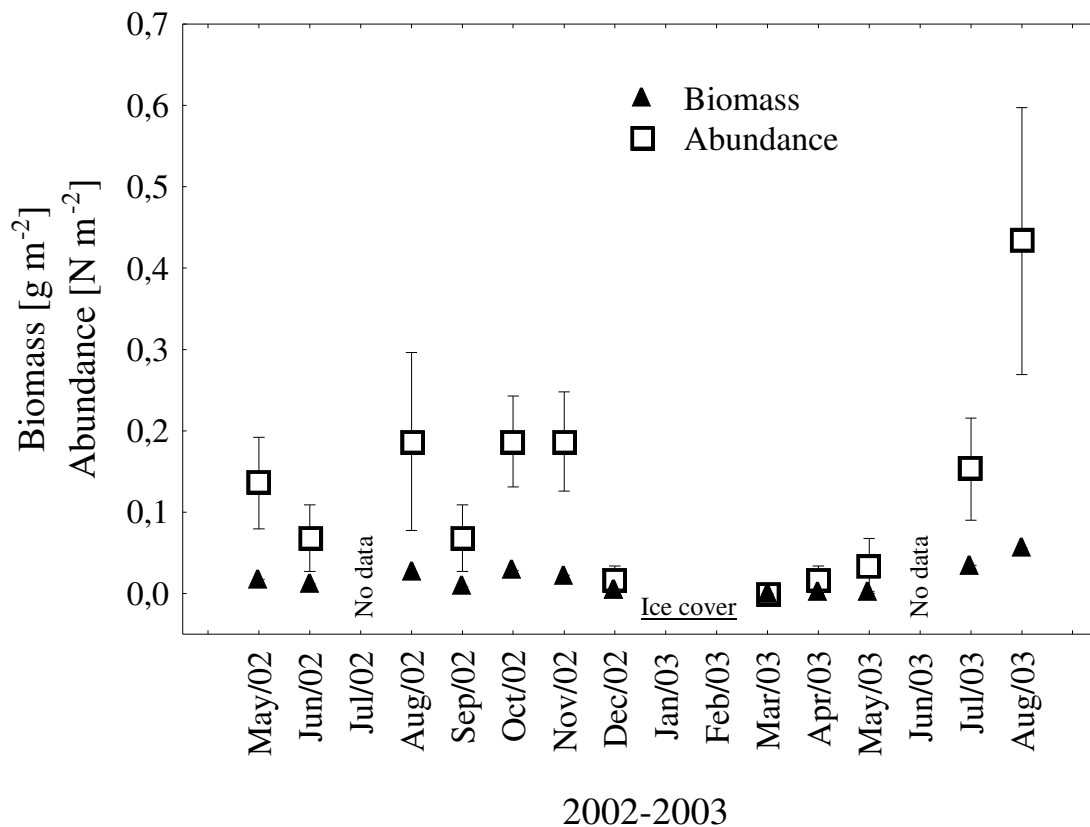

Fig. 3. Mean seasonal abundances and absolute wet biomasses of *P. microps* in the eelgrass meadow of the Greifswald Lagoon. Abundance values are means (\pm SE) of fifty trap hauls, biomass values are sums of each month

The sand goby achieved mean (\pm SE) maximum abundances of 0.1 ± 0.1 N m⁻² in October 2002 and July 2002 but maximum absolute wet biomass of 0.1 g m⁻² in November 2002 (Fig. 4). The decreasing abundances of the gobiids in fall and the absence in March 2003 indicate migration to deeper parts of the Lagoon in the winter months of 2002.

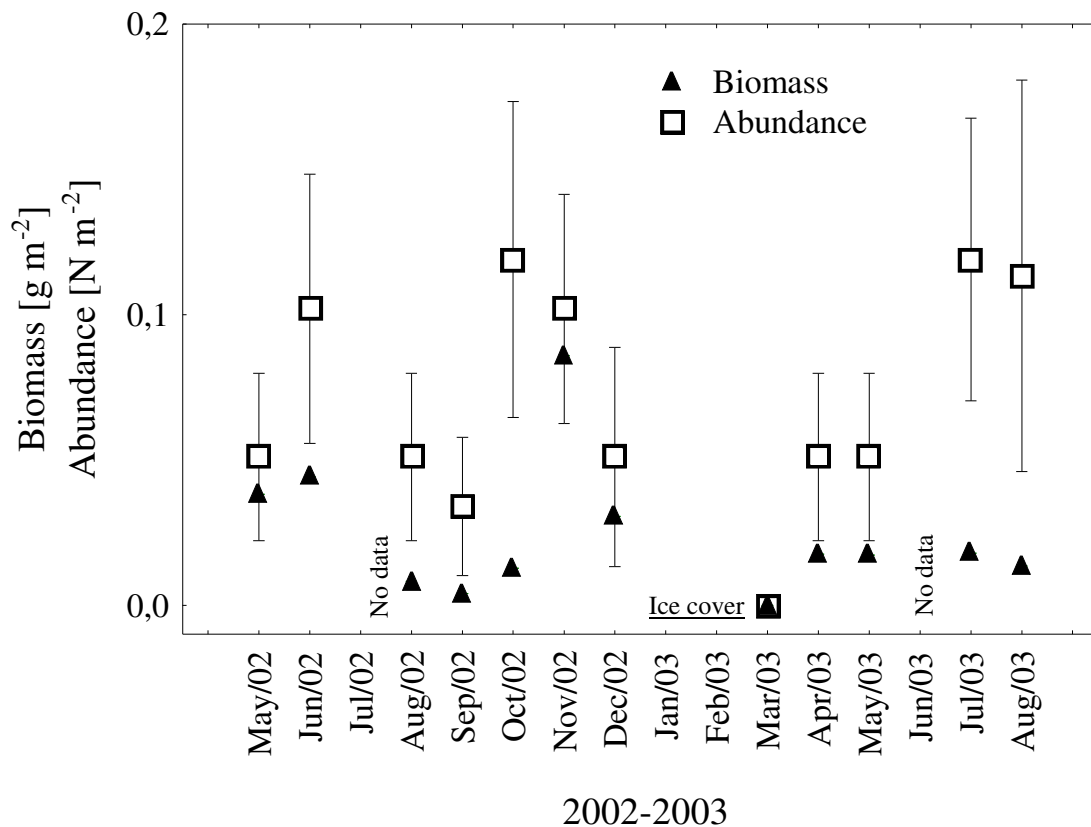

Fig. 4. Mean seasonal abundances and absolute wet biomasses of *P. minutus* in the eelgrass meadow of the Greifswald Lagoon. Abundance values are means (\pm SE) of fifty trap hauls, biomass values are sums of each month

Syngnathidae

The syngnathids were the next most abundant fish species collected. Their proportion on total fish wet biomass accounted for nearly 20 to 84%. The enclosure trap sampled a size range between 34 and 304 mm TL (Tab. 1). Juvenile straight-nosed pipefish, *N. ophidion*, less than 100 mm length appeared in the catches from August 2002 until December 2002. *Nerophis ophidion* were present in all samples throughout the whole season (except March 2003) and considered a resident in the eelgrass bed. They dominated the sampling in June 2002 until October 2002 and several individuals were also found in November and December (Fig. 5).

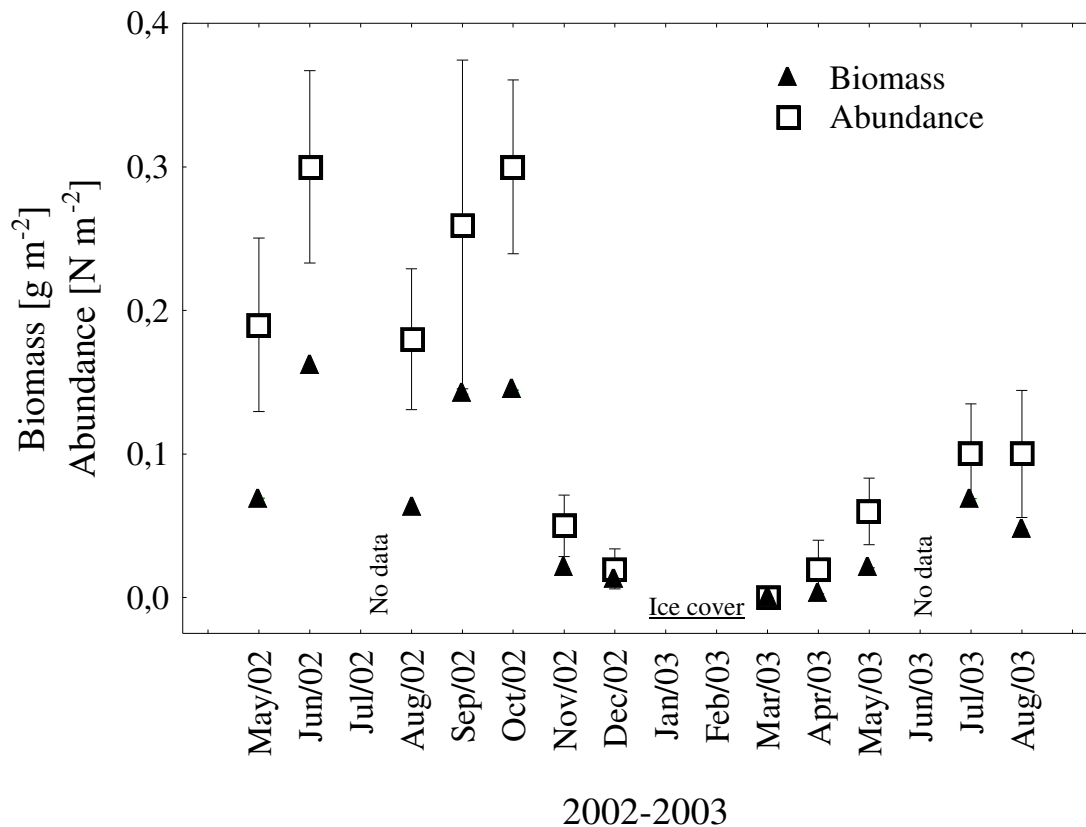

Fig. 5. Mean seasonal abundances and absolute wet biomasses of *N. opidion* in the eelgrass meadow of the Greifswald Lagoon. Abundance values are means (\pm SE) of fifty trap hauls, biomass values are sums of each month

The broad-nosed pipefish, *S. typhle*, was a frequent fish, but not considered a resident in the eelgrass meadow. Their proportion of abundance was 30% in August 2002 and 55% in August 2003. In October 2002 and July 2003 the proportion of total biomass comprised 23% and 51%, respectively. The size spectrum was 34-175 mm (Tab. 1). Juveniles below 90 mm length were captured in May 2002. Smaller juveniles below 33 mm length were first detected in July 2002 and July 2003. *Syngnathus typhle* displayed a distinct seasonal migration pattern. In contrast to the straight-nosed pipefish, *S. typhle* was absent in November and December 2002 and March and April 2003 (Fig. 6). The lesser pipefish, *Syngnathus rostellatus*, could not be detected in the eelgrass meadow.

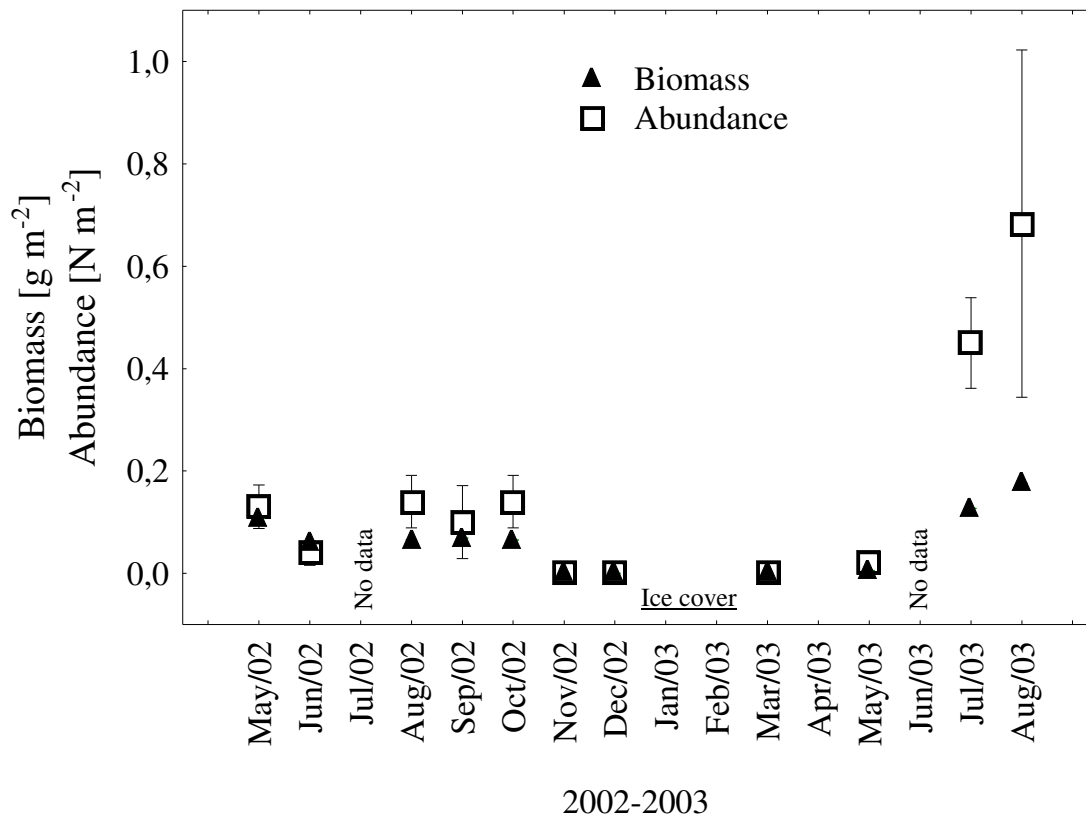

Fig. 6. Mean seasonal abundances and absolute wet biomasses of *S. typhle* in the eelgrass meadow of the Greifswald Lagoon. Abundance values are means (\pm SE) of fifty trap hauls, biomass values are sums of each month

Gasterosteidae

Adult three-spined sticklebacks, *G. aculeatus*, colonised the eelgrass meadow particularly during the spawning season in May and June. Eighty-seven adult specimens with a total mass of 144 g caused the high abundance and biomass in May 2003. The size range was 19-67 mm TL (Tab. 1). The relative biomass was 32 and 98% in May 2002 and May 2003, respectively. In the end of June and the beginning of July the adults had left the eelgrass meadow and juveniles appeared. The total wet biomass of sixteen three spined sticklebacks captured in July was only 2.1 g. Until August almost all of the sticklebacks had disappeared (Fig. 7). The results indicate that sticklebacks utilize the eelgrass meadow predominantly as spawning ground for the adults and feeding area for the juveniles. Only two individual of the nine-spined sticklebacks, *P. pungitius*, were captured, one in August and December 2002, respectively. The fifteen-spined stickleback, *Spinachia spinachia*, did not appear in the samples.

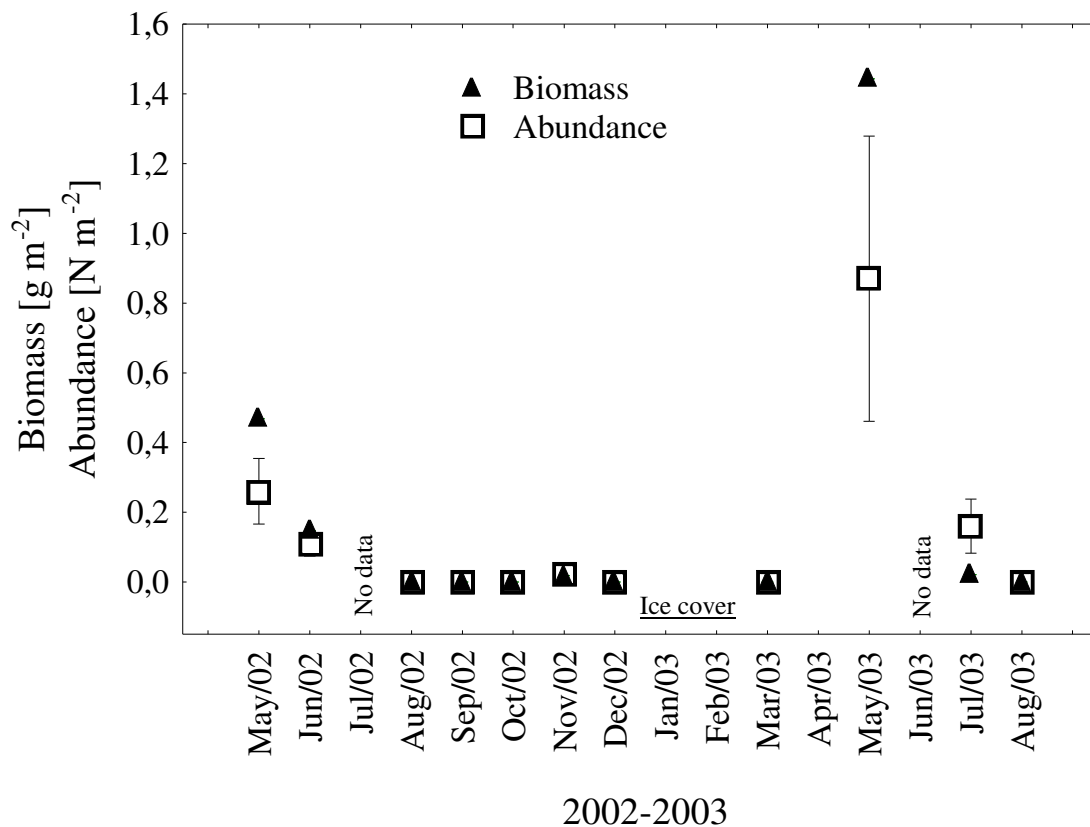

Fig. 7. Mean seasonal abundances and absolute wet biomasses of *G. aculeatus* in the eelgrass meadow of the Greifswald Lagoon. Abundance values are means (\pm SE) of fifty trap hauls, biomass values are sums of each month

Richness and diversity

The species number captured with the trap decreased from seven in May 2002 to four in December 2002. In January and February 2003 the Greifswald Lagoon was partly covered by ice, which made fish sampling impossible. In March 2003 no fishes were captured with the trap. In the following months the species number increased slightly from four in April to six in August (Tab. 4).

The Shannon-Weaver diversity index decreases slightly from 1.6 in May 2002 to 1.2 in December 2002, indicating decreasing diversity. The species diversity displayed no consistent trend in 2003. The values ranged between 0.6 and 1.3. Ten fish species were detected during the study and total species diversity was 1.6 (Tab. 5).

Table 5. Richness (S) and diversity (H') of the fish community in the Greifswald Lagoon (Vilm) in 2002 and 2003

2002	May	Jun	Aug	Sep	Oct	Nov	Dec
S	7	6	6	5	5	5	4
H'	1.60	1.40	1.48	1.21	1.36	1.21	1.19
2003	Mar	Apr	May	Jul	Aug-d	Aug-n	Total
S	0	4	5	6	6	6	10
H'	0	1.25	0.61	1.50	1.33	0.96	1.64

Migration

In both years the three-spined stickleback, *G. aculeatus*, showed the most pronounced migration pattern with maximum abundances in May and June, when large swarms populate the eelgrass meadow for feeding and reproduction. Most of the adult sticklebacks had disappeared until July. Juveniles between 19 to 30 mm SL were first captured in July. *Syngnathus typhle* was absent in the eelgrass zone in November and December 2002 and March and April 2003, suggesting emigration during the colder period. The abundance of *S. typhle* also decreased considerably during the night catches, indicating feeding habits outside the eelgrass bed.

Eelgrass structure and fish community

The shoot densities, above-ground biomasses and leaf areas of *Z. marina* varied greatly during the 2002 study. Shoot density and above-ground biomass displayed typical seasonal patterns with increasing values in spring until early summer, maximum values in the summer months, decreasing values in late summer and fall and minimum values in the winter period. The leaf area deviated slightly from this seasonal pattern.

Shoot density

The mean shoot density in May 2002 was 94 shoots m⁻². Shoot density increased to maximum values of nearly 170 shoots in August 2002. From August the shoot density declined until December 2002 (Fig. 8).

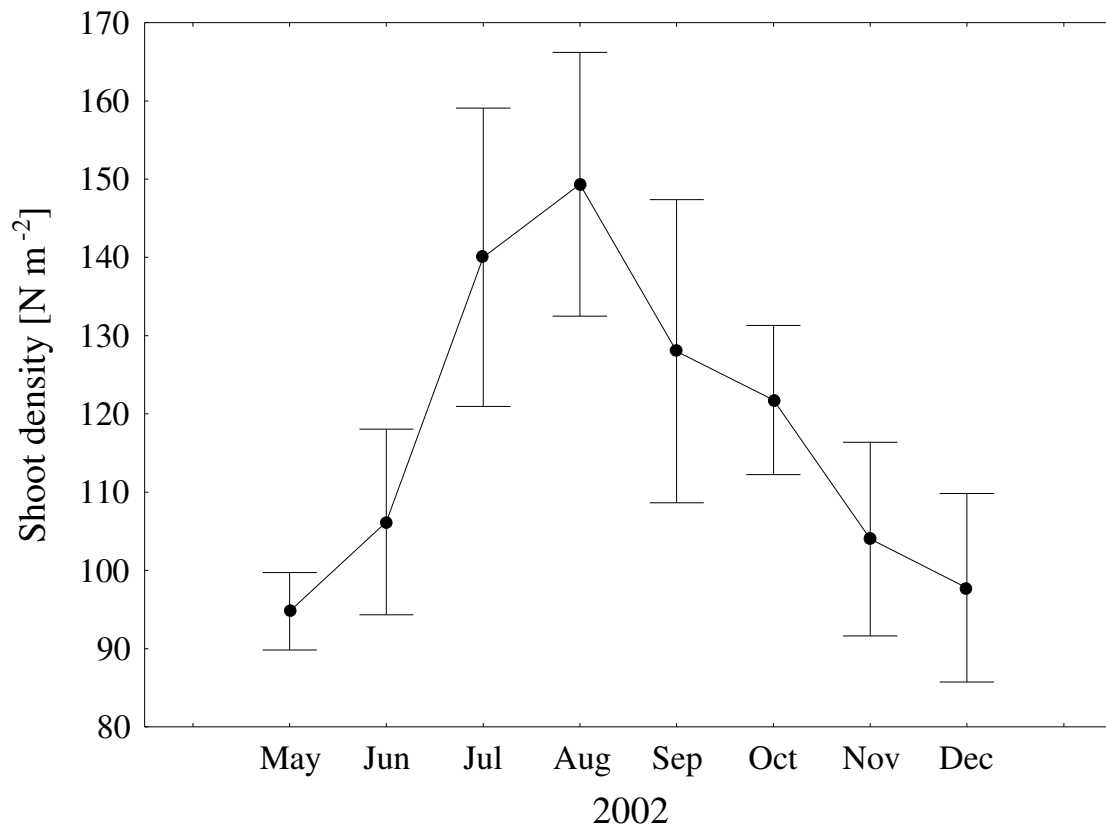

Fig. 8: Seasonal variation of *Zostera marina* shoot density in the eelgrass meadow of the Greifswald Lagoon. The values are means (\pm SE) of $n=10$ per sampling date

Water temperature, salinity and water transparency

In May 2002 the water temperature had already increased to 13°C. An average maximum water temperature of 22.4°C was detected in August, the lowest temperature of 1.2°C was recorded in December. Salinity underlay only minor changes between 5.8 and 6.4 psu. The water transparency decreased heavily from May to June and fell to minimum values of 0.8 m. From October the secchi-depth increased until maximum values of 3.0 m were achieved in December (Fig. 9).

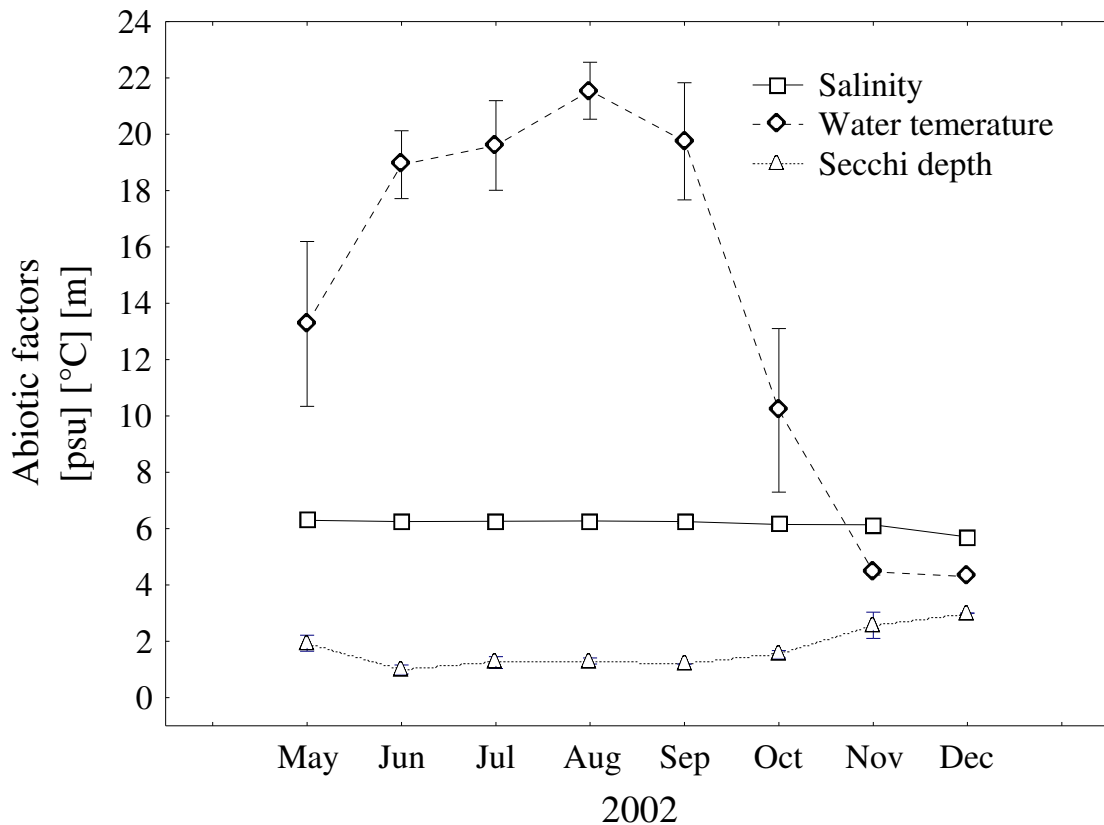

Fig. 9. Seasonal variation of salinity, water temperature and water transparency (secchi-depth) in the Greifswald Lagoon. Values are means (\pm SD) of $n=4-15$ per month

Above-ground biomass, fish biomass and abiotic factors

If the three-spined sticklebacks and the larger fish species were excluded from the analysis, the fish biomasses match the typical seasonal course pattern for temperate eelgrass meadows with maximum values in late summer and minimum values in spring and fall. Figure 10 combines the seasonal pattern of eelgrass above-ground biomass, fish biomass and water temperature. The three-spined sticklebacks were excluded from this analysis because they populated the eelgrass meadow only during the spawning season in spring. The general profile of the three variables indicates relationships between water temperature, eelgrass above ground biomass and fish biomass. When the water temperature increased in spring the eelgrass biomass and fish biomass also increased. Water temperature and eelgrass biomass achieved their maximum in August, whereas fish biomass culminated in September. In fall water temperature, eelgrass and fish biomass were minimal. The data suggest that water temperature is an important factor controlling the eelgrass biomass, and both eelgrass biomass and water temperature influence the biomass of fishes.

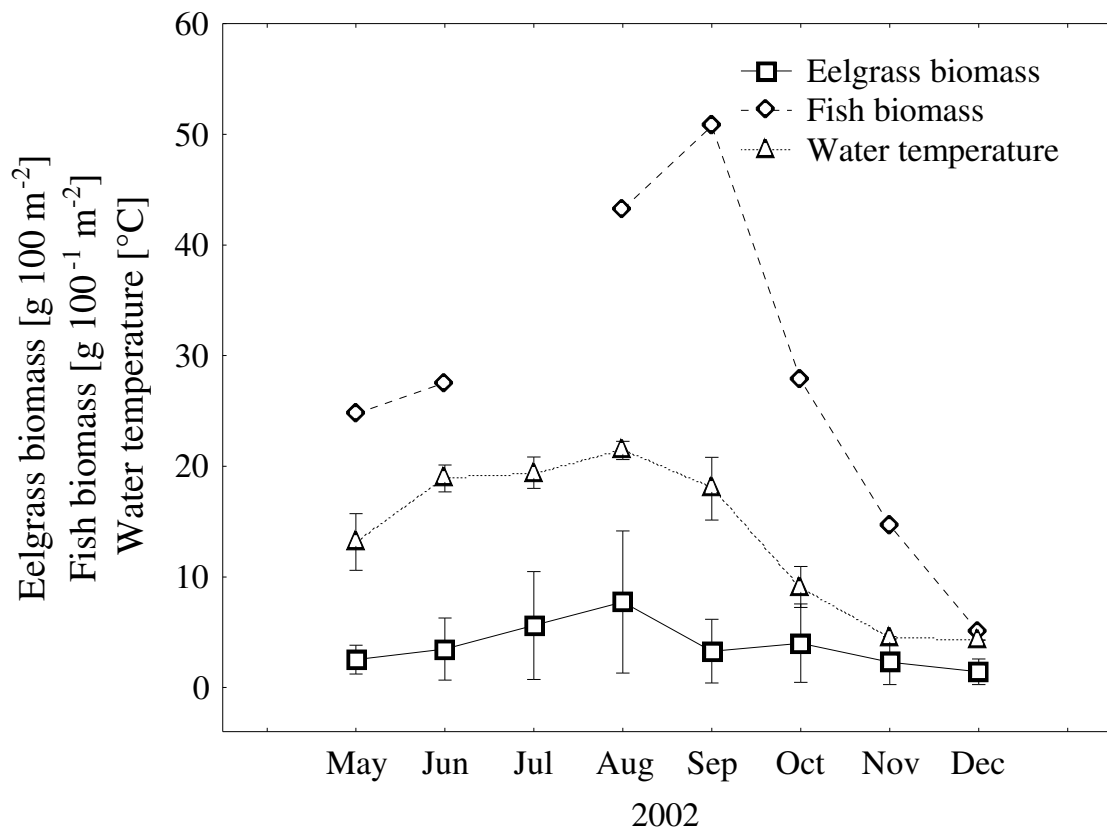

Fig. 10. Seasonal variation of eelgrass above-ground wet biomass (n=10), total fish wet biomass (*G. aculeatus* excluded) and water temperature (n=10) in the Greifswald Lagoon. Values are means (\pm SD)

Biomass of *N. ophidion* and eelgrass leaf area

The seasonal course pattern of leaf area of *Z. marina* diverged from the seasonal pattern described above for biomass and shoot densities. The maximum values in the summer months were interrupted by depressions in July and September. The seasonal biomass pattern of the phytomimetic straight-nosed pipefish, *N. ophidion*, which lives closely related to the eelgrass leaves, showed weak correlations with leaf area of *Z. marina* ($r=0.73$, $n=7$, $p=0.06$).

Correlation analysis

There were significant negative correlations between water temperature and water transparency (secchi-depth). Secchi-depth on its part correlated significantly with total fish biomass (*G. aculeatus* and larger fish species excluded) and secchi-depth displayed weak correlations with eelgrass biomass. These correlations indicated water clarity and water temperature as important abiotic factors influencing eelgrass growth. Significant correlations were also detected for eelgrass biomass and total fish abundance (*G. aculeatus* excluded), suggesting that eelgrass influence fish community structure in the Greifswald Lagoon (Tab. 6).

Table 6. Correlation matrix of abiotic factors, fish and eelgrass parameters from an eelgrass bed in the Greifswald Lagoon in 2002. T_w =water temperature, S=salinity, SeD=secchi-depth, A=abundance, AG=eelgrass above-ground biomass, B_w = fish wet biomass, H' =Shannon-Weaver Diversity Index, ShD=shoot density, LA=leaf area. P-values are arranged in the right top and r-values down to the left of the table. Significant correlations ($p < 0.01$) are accentuated with grey background colour and correlations between different clusters are framed

		Abiotic factors			Fish			Eelgrass		
		T_w	S	SeD	A	B	H'	ShD	AG	LA
Abiotic factors	T_w		0.006	0.001	0.22	0.02	0.13	0.21	0.07	0.21
	S	0.90		0.037	0.35	0.04	0.07	0.43	0.21	0.61
	SeD	-0.95	-0.78		0.10	0.008	0.29	0.10	0.04	0.10
Fish	A	0.53	0.42	-0.66		0.05	0.36	0.04	0.003	0.02
	B	0.82	0.78	-0.88	0.75		0.45	0.02	0.05	0.12
	H'	0.63	0.72	-0.46	0.41	0.34		0.91	0.18	0.67
Eelgrass	ShD	0.54	0.36	-0.67	0.78	0.82	0.05		0.02	0.007
	AG	0.71	0.54	-0.77	0.92	0.75	0.58	0.82		0.007
	LA	0.54	0.24	-0.67	0.82	0.64	0.20	0.89	0.89	

Discussion

Eelgrass

Shoot densities, above ground-biomasses and leaf area of *Z. marina* plants exhibit seasonal course patterns with a pronounced summer maximum (Figs. 8, 10 and 11). This pattern could be explained by increasing shoot densities from spring to early summer. The growth increment of *Z. marina* depends on water temperature and photoperiod (Bulthuis 1987, Wohlenberg 1935, cited from Gründel 1982). When water temperature in spring reaches 6-

10°C and photoperiod increases, the growth rate increases and the eelgrass generate new shoots and leaves. The shoot densities between 90 and 150 shoots m⁻² found during this study were relatively low compared to other studies (Tab. 7).

Table 7. Shoot densities in different *Z. marina* meadows of the Baltic Sea

Author	Location	Shoot density [N m ⁻²]
Feldner 1976	Germany	1366 (mean)
Gründel 1982	Germany	500 (max)
Reusch et al. 1994	Germany	880-1200 (min-max)
Olesen 1999	Denmark	596-1054 (min-max)
Boström et al. 2002	Denmark	115-170 (min-max)
this study 2002	Germany	90-150 (min-max)

The mean wet eelgrass above-ground biomass throughout the whole season was 0.4 ±0.4 kg m⁻². The maximum value in August 2002 was 2.9 kg m⁻². Compared to other eelgrass beds in the Baltic Sea these values are relatively low. Borum and Wium-Andersen (1980) found mean biomass values of 0.6 kg m⁻² in Denmark, Gründel (1982) 0.3 to 2.9 kg m⁻² in Surendorf near Kiel (Germany) and Feldner (1976) 0.7 to 4.0 kg m⁻² in Großenbrode (Germany).

Eelgrass fish community

Twelve different fish species were recorded in the eelgrass meadow, including frequent small fishes of the southern Baltic Sea (Winkler and Thiel 1993, Bischoff et al. 1997) and larger fishes like pike, *E. lucius*, eelpout, *Z. viviparus*, perch, *P. fluviatilis*, and flounder, *P. flesus*, in limited numbers. The eelgrass meadow in the eastern parts of Vilm Island is mainly inhabited by marine fish species, although proportions of limnic fish species, especially cyprinids, on the total fish community are relatively high in the Greifswald Lagoons (Thiel 1990, Jönsson et al. 1998). The fifteen-spined stickleback, *S. spinachia*, and the two spotted goby, *G. flavescens*, are regularly present in the outer coastline of the southern Baltic Sea, but they were often absent in semiclosed waterbodies, as shown in this study for the Greifswald Lagoon (Winkler and Thiel 1993, Ubl et al. 2000). The total absence of cyprinids in the catches is in accordance with observations of Fricke (pers. comm.), who found more limnic fish species, including the cyprinids, on the landward directed side in comparison to the seaward directed side of Vilm island.

Abundances and biomasses

The seasonal course pattern of fish abundances and biomasses are generally characterised by a heavy increase in spring, maximum values in late summer to fall and decreasing values in late fall and winter. Maximum abundance and biomass values in late summer are representative for shallow water fish communities in the Baltic Sea (Nellbring 1988, Jönsson et al. 1998). The increasing abundances and biomasses in spring and early summer are often attributed to immigration and recruitment. The complex structure of the phytal (*Z. marina*, *Potamogeton pectinatus*) offers spawning- and nursery-ground for many fish species (Gasterosteidae, Syngnathidae, Gobiidae). Minimum values of abundance and biomass in winter and early spring are explained by emigration, predation and natural mortality. The magnitudes of the abundance and biomass values are in accordance with other studies concerning the shallow water fish communities in the Baltic Sea (Tab. 8). The deployment of different fishing devices with large and unpredictable catch efficiencies, however, restricted the comparison of the results (Rozas and Minello 1997). Fish abundances in submerged aquatic vegetation tends to be higher than in nearby unvegetated areas (Orth and Heck 1980, Hyndes 2000). Jönsson et al. (1998) investigated the fish community in shallow areas near Vilm Island with beach seine. They sampled sandy areas and macrophyte communities, however, did not include *Z. marina* beds. The catches were restricted to 1.8 m water depth. The mean abundances of small and juvenile fishes in the eelgrass bed of this study exceeded the values of Jönsson et al. (1998) by far. Other studies from Sweden detected considerable higher abundances and biomasses of small fishes in shallow water areas, but also considerable larger seasonal variations (Tab. 8).

Table 9. Mean abundances and wet biomasses of fishes captured at different sampling locations and with different sampling gear in the Baltic Sea. Values in parenthesis are ranges of average year or month values

Location country depth	Year	Abundance [N 100 ⁻¹ m ⁻²]	Biomass [g 100 ⁻¹ m ⁻²]	Sampling method	Source Year
Askö Sweden 0-20 m	1980- 1981	210 (5-1380)	267 (0.1-730)	SCUBA- census	Jansson et al. 1985
Vilm Germany 0-1.8 m	1994- 1996	3.4 (1.2-6.7)	11.1 (6.9-13.4)	Beach seine	Jönsson et al. 1998
Lysekil Sweden 0.7-1.5 m	1980- 1982	630 (340-1040)	21.7 (16.8-26.7)	Enclosure trap	Pihl Baden und Pihl 1984
Vilm Germany 2.0-3.5 m	2002	44 (14-138)	43 (3.6-112)	Enclosure trap	This study 2002-2003

Day-night

The significantly higher fish abundances during the night, caused by gobiids, may indicate that fishes migrate into the eelgrass bed at night and utilize it for feeding or as refuge from predation. Other species like *S. typhle* leave the eelgrass meadow at night, maybe finding better feeding conditions outside eelgrass.

Gobies

The gobies were the most abundant fish species populating the sandy bottom of the eelgrass meadow. Maximum abundances in late summer and fall are in accordance to the migration pattern observed in the Barther Lagoon (Thiel 1990) and could be explained by immigration of young recruits. Inconsistent information exists about the seasonal migration of common- and sand goby. Hesthagen (1977) observed that sand gobies emigrate from the shallow coastal areas in winter, whereas Nellbring (1988) detected gobies under ice in shallow parts in the northern Baltic Sea. In this study, the gobies were found migrating into deeper regions of the Greifswald Lagoon during winter months.

Pipefish

The straight-nosed pipefish, *N. ophidion*, and the broad-nosed pipefish, *S. typhle*, are typical members of temperate eelgrass fish communities and dominant in terms of abundance and biomass in Vilm eelgrass beds in the summer months (Bischoff et al. 1997, Ubl et al. 2000). *Nerophis ophidion* was also abundant in the colder season and considered a resident in the eelgrass bed of the Greifswald Lagoon. It lives closely associated to the eelgrass habitat and is known to clinch eelgrass blades with its tail tip to prevent itself from dispersal by water currents. The weak correlation between wet fish biomass and leaf area of *Z. marina* confirmed the above mentioned close relationship between *Z. marina* and *N. ophidion*. The eelgrass leaf area is in close relation to shoot density and eelgrass biomass. The seasonal course pattern of leaf area is connected with leaf width growth in June, leaf loss in August, new length growth in October and due to the loss of older leaves and whole shoots at the end of the year.

In the eelgrass meadow of Vilm the broad-nosed pipefish, *S. typhle*, was a major component of the fish community, but was absent in November, December, and early spring. In a study from Ubl et al. (2000) the broad-nosed pipefish, *S. typhle*, was a frequent resident in the Salzhaff (Baltic Sea), a brackish area with expanded eelgrass meadows. In contrast to the straight-nosed pipefish, *S. typhle* was not detected during the colder season. These results indicate a migration of *S. typhle*, leaving the eelgrass bed in fall and winter. In the night samples *S. typhle* abundance was lowered compared to the day sampling, suggesting a diurnal migration pattern.

Sticklebacks

Three-spined sticklebacks, *G. aculeatus*, undertake pronounced spawning migrations during spring. During this time large schools migrate from the pelagial into the phytal for reproduction (FitzGerald and Wootton 1986, Paepke 2001). Highest abundances and biomasses were found in May and June, in July only juveniles were detected. This migration pattern following breeding was in coincidence with findings of Thorman and Wiedeholm (1986), who observed adult *G. aculeatus* disappearing from shallow areas in the Bothnian Sea (northern Baltic Sea) in July, while juveniles occurred throughout the summer. These results suggested that adult three-spined sticklebacks do have their feeding grounds outside the eelgrass meadow and utilize the bed almost exclusively for spawning and feeding of the juveniles.

Diversity

Diversity indices were low compared with those found for fishes in non eelgrass communities. Hoese et al. (1968) calculated diversity indices for fishes in Aransas Bay (Texas), ranging from 0.9 to 2.1. Bechtel and Copeland (1970) found mean diversity indices for fishes in Galveston Bay to be 1.3. Adams (1976a) found diversities for fishes in two shallow estuarine systems in North Carolina between 0.5 and 1.5. In this investigation diversity indices ranged from 0.6 to 1.6 and were thus of comparable magnitudes. Adams (1976a), however, detected a total of 39 fish species in two eelgrass meadows and 24 species were collected more than once during the 1971-1972 period.

Biomass and light conditions

The eelgrass, *Z. marina*, is characterised by high light requirements and takes advantage of nutrient deficiencies in comparison to micro- and macro-algae (Sand-Jensen and Borum 1991). According to this the Greifswald Lagoon is assumed an unsuitable habitat for *Z. marina*. The Greifswald Lagoon is rich in nutrients and has often unsuitable light conditions due to phytoplankton blooms and resuspended sediments. The extremely low above-ground biomasses found in this investigation are explained to some extent by the low water clarity. The eelgrass plants in the Greifswald Lagoon were suggested embarking on another strategy, because of the surplus supply of nutrients and the unfavourable light conditions involved compared to other habitats in the Baltic Sea.

While the eelgrass meadow of Vilm displays relatively low shoot densities, above ground biomasses and leaf areas, it is populated by a diverse and rich fish community. The high nutrient regime was suggested offering best feeding conditions and sufficient food supply for small fishes. Increasing shoot densities in spring increase spatial structure of the eelgrass habitat, providing shelter for invertebrates and small fishes (Orth et al. 1984).

Salinity

Salinity and water temperature are important factors affecting the distribution and dispersion of fishes in shallow water habitats (Thorman 1986, Thiel et al. 1995). The seasonal fluctuations of salinity in the sampling area were low and were not considered to be the structuring force for the observed migration pattern of the fish community. In general, the relatively low salinity facilitates euryhaline marine and euryhaline limnic fish species inhabiting the eelgrass meadow.

Water temperature

The water temperature can also considerably affect the distribution and composition of fish communities. Many small fishes leave shallow waters due to decreasing water temperature in late fall and winter (Hesthagen 1977, Adams 1976a). In this study, no correlations were found between water temperature and fish abundance and only weak correlations were found between water temperature and fish biomass, supporting the conclusions of Hesthagen (1977) and Adams (1976a).

Secchi-depth

Cyanobacteria are well known developing summer blooms and thereby reducing water transparency in the marine environment (Hübel and Hübel 1995). In this study water clarity was identified correlating with eelgrass biomass and abundances of small fishes seemed to be regulated by eelgrass biomass and water temperature. Adams (1976a) detected positive correlations between fish abundance and *Z. marina* biomass. Both parameters correlated significantly with the water temperature. Adams (1976a) concluded that water temperature is the most important abiotic factor structuring eelgrass beds and its associated fish communities in North Carolina. In Chesapeake Bay fish abundances increased in spring and early summer as both water temperature and eelgrass biomass increased and decreased in the fall and winter as temperature and eelgrass biomass decreased (Orth and Heck 1980). In the present study water temperature was also shown to be an important factor triggering migration and thus regulating distribution and dispersion of fishes in shallow water eelgrass habitats. The regression analysis, however, revealed a deviating pattern, different from the one detected by Adams (1976a). Significant correlations between fish abundance and eelgrass biomass were also found, but only weak correlations were identified between fish biomass and water temperature. The most pronounced and strongest correlations, however, exist between water transparency and fish biomass as well as between water transparency and eelgrass biomass (Tab. 4), indicating that underwater light conditions constitute the most important abiotic factor structuring the eelgrass meadow. Water temperature and eelgrass structure represented main factors influencing the fish community composition in the eelgrass beds of the Greifswald Lagoon.

Acknowledgements

The study was supported by the environmental foundation Deutsche Bundesstiftung Umwelt (DBU) in the framework of the scholarship group: „The southern Baltic Sea and its coast in change”. We thank Peter Hübner and Dr. Henning von Nordheim from the Federal Nature Conservation Agency, outpost Vilm, for their technical support and assistance. The Federal Nature Conservation Agency kindly put boats and laboratory to our disposal. We further thank the national park office Rügen and the state office of fisheries Mecklenburg-Vorpommern for the license to collect eelgrass and fish samples in the national park area of Vilm Island. Special thanks go to Britta Munkes who helped collecting fish samples and providing seasonal eelgrass data.

Chapter III

**Predation of small fish species on epiphyte grazers in
eelgrass beds of the Baltic Sea**

Abstract

Epiphyte grazers (amphipods, isopods, amphipods) are playing a vital role for the growth conditions of seagrass plants by reducing the loads of attached epiphytes from the seagrass leaves. Shallow water fish communities, in turn, may contribute to the control of these epiphyte grazers. The small-sized fish assemblages of two eelgrass beds in the Baltic Sea (Falkenstein, Vilm) and their feeding habits were therefore quantitatively investigated. We studied fish predation on zoobenthos and compared secondary grazer production and fish consumption. Gobiidae, Syngnathidae and Gasterosteidae dominated the eelgrass fish assemblages at both sampling sites. At Vilm, *Nerophis ophidion* turned out to be the main fish predator of epiphyte crustacean grazers, notably gammaridean amphipods and *Idotea chelipes*. The annual consumption of *N. ophidion* achieved nearly 70% of total amphipod and 37% of the total isopod mortality by fish predation. Gastropods were generally of minor dietary importance at both sampling sites. The fish community at Falkenstein consumed less than 1% of the annual gastropod production in 2002. In contrast to Vilm, crustacean grazers played a pivotal role in fish nutrition at Falkenstein. The grazer sizes consumed by the fishes ranged from 0.2 to 15.5 mm body length, but the majority of prey sizes were below 6 mm. *Spinachia spinachia* and *Zoarces viviparus* represented the major consumers grazing isopods and amphipods. During fish growth the dietary relevance of *I. balthica* considerably increased in both species. *Spinachia spinachia* and *Z. viviparus* shifted their diets from preliminarily consuming copepods to *I. balthica* at 73 mm and 87 mm total length, respectively. *Spinachia spinachia* ingested over 60% of the total isopod consumption in 2002 corresponding to about 23% of the total annual *I. balthica* production. *Zoarces viviparus* ingested 45% of the total amphipod and 43% of the total isopod (mainly *I. balthica*) fish consumption in 2003. The mean consumption of both fish species achieved nearly 50% total amphipod and 80% of total isopod fish consumption in 2002 and 2003. The results indicate a pronounced predation upon the smallest development stages of the crustacean, constituting a substantial food resource for the eelgrass fish assemblage. *Spinachia spinachia* and *Z. viviparus* showed high potential in controlling amphipods and *I. balthica* in eelgrass beds of the Baltic Sea. The predation by small fish species was not likely to be having an impact on the gastropod population but the crustacean grazer population may slightly reduced by fish predation.

Introduction

Zostera marina beds often harbour dense populations of small herbivorous and detritivorous invertebrates, primarily amphipods, isopods and gastropods. The herbivorous grazers can play a decisive ecologic role because they are capable of effectively reducing epiphytic layers from eelgrass leaves. As a result they can enhance or recover eelgrass productivity (Orth and Montfrans 1984, Jernakoff et al. 1996). Gastropods are one of the main feeders on eelgrass epiphytes and grazing ability is related to the design of their radula and the morphology of their food (Steneck and Watling 1982, Norton et al. 1990). Many crustacean grazers have the ability to switch among different food types and their feeding mode is therefore regarded as omnivorous. Several idoteid isopods and amphipod species have been reported to graze effectively on epiphytes (Jernakoff et al. 1996). *Idotea balthica* and *I. chelipes* are widespread and temporarily abundant in the eelgrass beds of the Baltic Sea. Both species are considered effective epiphyte grazers when compared with the amphipod *Gammarus oceanicus* (Ovra-Kotta and Kotta 2003) and the gastropods *Hydrobia ulvae* and *Littorina littorea* (Hootsmans and Vermaat 1985). Other studies found *Littorina littorea* and *Rissoa membranacea* to be more efficient grazers than *I. balthica* and *G. oceanicus* (Jaschinski, pers. com.). The effects of grazing may vary considerably between these species and grazer populations fluctuate with environmental conditions, fish predation and food availability (Edgar 1990b, Engkvist et al. 2004, Nilsson 2004). Field surveys in the Baltic Sea and grazing experiments performed by Engkvist et al. (2000) indicated that mass occurrence of grazing *I. balthica* is also an important structuring factor in the belts of bladder wrack *Fucus vesiculosus*. High abundances of *I. balthica* have been reported for several coastal regions in the Baltic Sea, including eelgrass beds. Nilsson et al. (2004) explained these great abundances due to a combination of eutrophication, mild winters and reduced predation pressure by fishes. Svensson et al. (2004) also stated the small stocks of predatory fish in the Baltic Sea could be one potential factor for today's high densities of *I. balthica* along the Baltic Sea coasts. Nilsson (2004) investigated the seasonal population dynamics of *I. balthica* and its potential fish predators with gill nets. He detected a sharp decrease in the *I. balthica* population from August to November and explained these decreasing abundances by a simultaneously increasing predation pressure from herring (*Clupea harengus*) in September. But he established no plausible predator responsible for the decline of juvenile *I. balthica* (3-7 mm length) from the middle of August and mentioned small-sized fish species such as gasterosteids and gobiids as possible fish predators.

While the stocks of larger fish predators such as perch, cod and plaice have declined drastically during the last decades (Köster and Möllmann 2000, Jonzén et al. 2002), the relative biomass of small-sized fish species colonizing shallow water habitats increased (Niemann 1991). These changes in the fish community structure may result in varying feeding intensities and interactions between epiphyte grazers and small predatory fish species. The eelgrass fish community may control epiphyte grazers due to predation (Nelson 1979, Orth et al. 1984, Heck et al. 2000). The feeding relationships between small eelgrass fish species and epiphyte grazers in the Baltic Sea, however, are weakly investigated and studies focussing on nutritional aspects of eelgrass fish communities are sparse (Huh and Kitting 1985). It is not known how much of the diet the epiphyte grazers constitute for the different fish species of the eelgrass community and there are no estimates of the quantities of the secondary production consumed by these fishes.

The present investigation studies the trophic relationships between small predatory fish species and grazers (amphipods, isopods, gastropods) in two eelgrass beds of the Baltic Sea.

We addressed the following questions:

- (1) What are the fish species dominating in eelgrass communities?
- (2) Which fishes do prey mainly on epiphyte grazers?
- (3) Which biomasses and sizes of grazers are consumed?
- (4) Can invertebrate production be related to fish consumption?

Material and Methods

Fish predation on grazers was estimated by field examinations. We quantitatively sampled benthic invertebrates and the fish communities of two eelgrass beds located in the Baltic Sea. We determined species composition, abundance and biomass and estimated annual somatic production rates of both fishes and grazers. Fish diet analyses provided data of diet composition, prey sizes and consumption rates. The dietary relevance of different prey items to the fishes was calculated for different fish length-classes by using the index of relative importance (IRI, Hyslop 1980). Diet proportions provided the basis for clustering eelgrass fishes due to similarities in nutrition. We further compared production of grazers with consumption rates of individual fish species and the total fish community.

Study area

Quantitative fish sampling was carried out in two monotypic *Zostera marina* eelgrass meadows of the Baltic Sea. One site is located in the outer Kiel Fjord near Falkenstein (F, 54°24'42''N, 10°11'24''E), the other in the Greifswald Lagoon near Vilm Island (V, 54°19'22''N, 13°32'24''E) (Fig. 1).

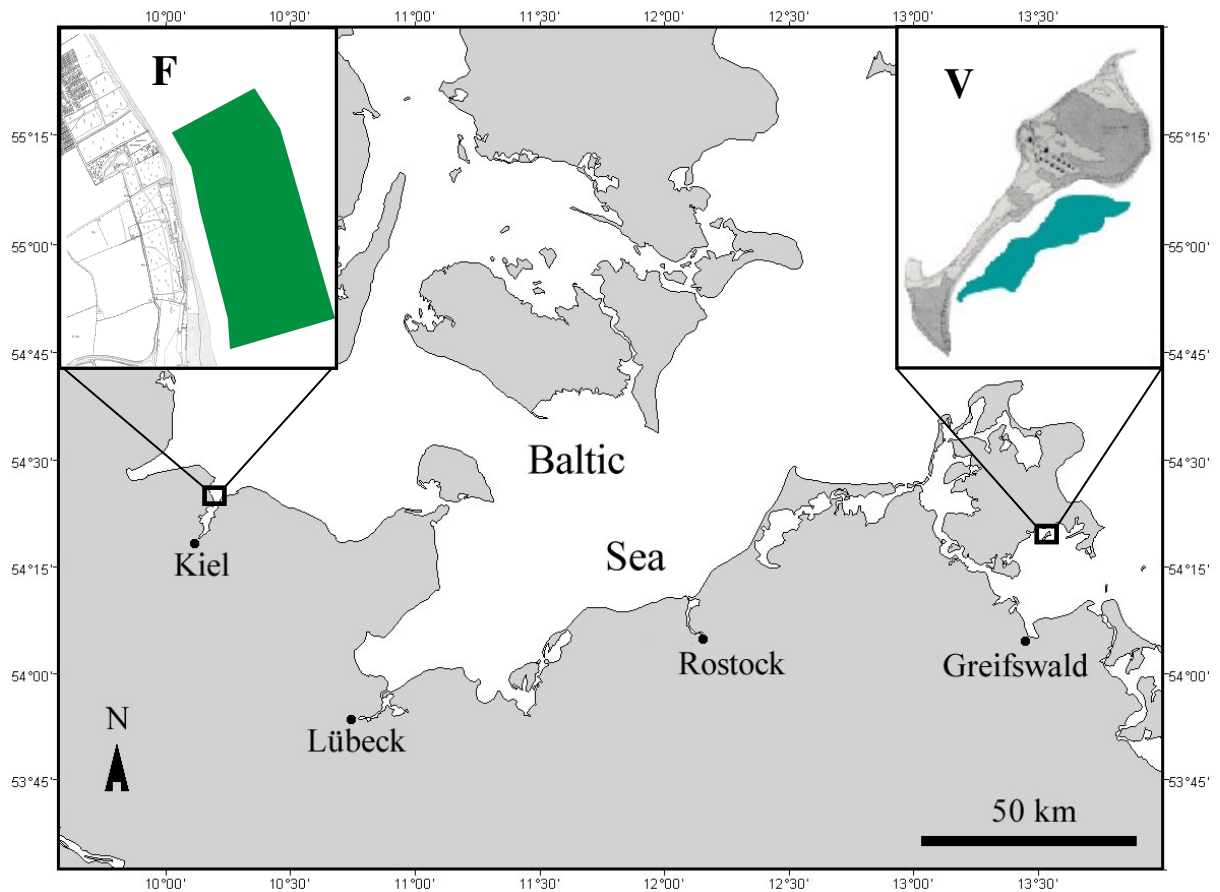

Fig. 1. Areas investigated with position of the eelgrass beds (dark shaded areas) in Kiel Fjord (F) and in the Greifswald Lagoon (V)

Both sampling sites were exposed to wind and wave actions. The bottom sediment was sandy with lack of big stones. Major characteristics of the two sampling locations are summarised in Table 1. For a detailed description of the sampling sites see Chapter I and Chapter II.

Table 1. Sampling site characteristics for Falkenstein and Vilm eelgrass meadows. Data are ranges which occurred during the sampling period and means ($n=50$, \pm SD)

Sampling location	Area [ha]	Salinity [psu]	Secchi-depth [m]	Shoot length [mm]	Shoot density [shoots m⁻²]
Vilm	20	6-7	0.5-3.0	626 \pm 106	117 \pm 47
Falkenstein	23	14-17	2-7	488 \pm 156	330 \pm 102

Eelgrass fauna

Eelgrass bed structure and invertebrate fauna were monitored monthly by divers from April until October 2001 and 2002 at the Falkenstein sampling site. These data were collected and provided by Sandra Gohse-Reimann within the framework of her the PhD project. Additionally, eelgrass structure was assessed from August 2003 until October 2003. The shoot density of eelgrass was determined using a square counting fame of 25*25 cm. The frame was randomly dropped on the ground within the eelgrass meadow and all shoots inside the frame were counted. This was done in five parallels. Ten shoots were sampled from each parallel to determine shoot length and eelgrass above-ground biomass. Leaf length of the shoots was measured to the nearest 0.5 cm. The distances between two sampling parallels were not smaller than 5 meters. Invertebrate fauna in and on the sediment were quantitatively sampled within each parallel ($n=5$) using a plastic corer (height 25 cm, diameter 10.0 cm). Sediment samples were sieved through a nylon gaze with 355 μ m meshes. The eelgrass leaf fauna were quantitatively sampled utilizing a net bag (height 50 cm, mesh size 500 μ m). The net bag was put top down over the eelgrass thus entrapping 5-10 eelgrass shoots, which were then cut off directly above the sediment surface. Five replicate samples were collected monthly. The abundances values of the leaf fauna were calculated using the shoot density data. The animals collected from the sediment samples and from the cut off eelgrass shoots were identified to the lowest possible taxonomic level, counted and measured in length with 0.1 mm accuracy. Sub-samples of the animals were weighted, dried for 24 h at 60°C and ashed at 550°C for 3 hours to measure the loss on ignition. Length-wet mass and length-ash free dry mass (AFDM) relationships of isopods, amphipods and gastropods (including the shells) were calculated. These regression equations (Appendix, Table I) then enabled us to recalculate the mass of prey items found in the fish diets. Abundances of the leaf and the bottom fauna were combined to obtain overall invertebrate densities. Invertebrate fauna were assessed only at Falkenstein eelgrass site.

Fish species composition, abundance and biomass

The fish communities of two eelgrass beds were sampled quantitatively in monthly intervals from May 2002 until August 2003 (Vilm) and from April 2002 until October 2003 (Falkenstein), utilising an enclosure drop trap. Abundance and biomass values of gobiids were corrected using efficiency coefficients established during a comparison study between the enclosure drop trap and a visual diving transect census (Bobsien and Brendelberger 2006). For the bottom dwelling Gobiidae (*Gobius niger*, *Pomatoschistus minutus* and *P. microps*) and for the shoaling two-spotted goby (*Gobiusculus flavescens*) correction coefficients of 1.7 and 1.5 were used, respectively. No sampling was conducted in May, July and August 2002 at Falkenstein as well as in July 2002 and June 2003 at Vilm sampling site. Night sampling was conducted in 2003 on Aug 26 to Aug 27, during 22:30 p.m. and 3:30 a.m. The captured fish were immediately anaesthetized in 0.2% benzocaine seawater solution (ethyl-4-aminobenzoate) and then preserved in 90% ethanol. In the laboratory the animals were sorted by species, measured for standard length (SL) and total length (TL) to the nearest millimetre as well as for wet mass with 0.01 g accuracy. To evaluate size related variations in the food habits, each fish species were separated into three size classes (Appendix, Table II).

Analysis of stomach content

The stomach contents of the fish were quantitatively analysed with special regard to epiphyte grazers. A maximum of ten individuals of one fish species, size class and sampling date were used for stomach content analysis. Total prey mass was measured by wet weight differences between full and emptied gastrointestinal tract with 0.01 g accuracy. Diet were sorted into major food categories such as isopods, amphipods, copepods, cladocerans, mysids, cirripeds, ostracods, decapods, acarids, dipterans, gastropods, bivalves, hydrozoans, polychaets and fishes. Isopods and amphipods were identified to genus or to species level, whenever possible. The gastropods found in the fish diets were not identified by species and were combined to the category “gastropods”. The categories inorganic material (sand) and miscellaneous (unidentifiable material) were no further considered in the analyses. The main food categories included different developmental stages like eggs, larvae and pupae as well as adults. Fish eggs and fish larvae, for example, belong to the category fish, cypris larvae to the cirripeds and veliger larvae to the bivalves. We visually estimated the percent prey volume for each food category by using a counting grid. The gut content of one fish were evenly distributed on

the grid and the number of squares covered by each category were counted and divided through the total number of covered grids. The mass proportions for each food category were calculated from the total prey mass by using the volume proportions. We calculated the biomasses of epiphytic grazers consumed by the fishes (amphipods, isopods and gastropods) by using the above-mentioned length-mass relationships. Therefore, the prey items of each food category were counted and measured in length, maximum width (isopods, copepods) and maximum height (amphipods, mysids, gastropods), whenever possible. Prey dimensions were measured to the nearest 0.01 mm. For *Gammarus* spp. the distance from the anterior end of the caput to the dorsal posterior end of thoracomer four (CT_G) was measured and the total length (L_G) and maximum height (H_G) were recalculated by the regression $L_G = 2.5264 CT_G + 0.3804$ ($r^2 = 0.94$, $n = 20$, $p < 0.05$) and $H_G = 0.238 L_G - 0.076$ ($r^2 = 0.92$, $n = 225$, $p < 0.001$), respectively. Measurable fragments of partly digested prey were utilized to recalculate prey dimensions. This was done by means of regression equations between prey width (P_W) and prey height (P_H), and the prey length (P_L), obtained from intact prey species (Appendix, Table III).

Index of relative importance

To estimate the relevance of different food categories to the fish the index of relative importance (IRI, Hyslop 1980) was calculated for each prey category and for the epiphytic grazers (on genus and species level). Diets of each fish species were characterised using percent of number (%N), percent of mass (%M) and frequency of occurrence (%FO). %N was calculated as the number of all prey individuals of each food category divided by the total number of food items in the stomachs for all fishes of a species. %W was calculated as the total wet weight of each food category divided by the total food weight of all stomachs a fish species. %FO of a prey type was expressed as the number of stomachs containing the food category divided by all stomachs of a fish species containing food. The IRI was then calculated as the sum of the %N and the %M multiplied by the %FO for each prey category.

Estimation of grazer production

The estimates of the daily production rate (P , $\mu\text{g d}^{-1}$) depend on water temperature (T , $^{\circ}\text{C}$) and animal AFDM (B , μg) and was evaluated with the equation $P = 0.0049 * B^{0.80} T^{0.89}$ (Edgar 1990a). The wet masses and ash free dry masses (AFDM) of the grazers were calculated from length measurements using regression equations (Appendix, Table I).

Annual benthos production was estimated by calculating daily production for a three month period according to the season spring (Apr, May, Jun), summer (Jul, Aug, Sep) and fall (Oct, Nov) in 2001 and 2002 respectively. Annual grazer production was calculated as the sum of seasonal means from Apr to Nov of each year. Mean water temperature (\pm SD, $n > 10$) used in the calculations were Apr $7.6 \pm 1.3^\circ\text{C}$, May $14.1 \pm 1.9^\circ\text{C}$, Jun $17.8 \pm 1.2^\circ\text{C}$, Jul $19.3 \pm 1.3^\circ\text{C}$, Aug $20.3 \pm 0.7^\circ\text{C}$, Sep $16.4 \pm 2.0^\circ\text{C}$, Oct $11.3 \pm 0.9^\circ\text{C}$ and Nov $5.9 \pm 0.6^\circ\text{C}$.

Estimation of fish production and consumption

The production of the most abundant eelgrass fish species collected with the enclosure trap was estimated using the general equation $P = 0.000051 \cdot B^{0.69} T^{1.04}$ which relates daily fish production (P , g d^{-1}) to the AFDM of fish (B , g) and water temperature (T , $^\circ\text{C}$) (Edgar and Shaw 1995a). The logged version of the equation with standard error values, is $\log P = -3.30 (\pm 0.39) + 0.69 (\pm 0.03) \log B + 1.04 (\pm 0.31) \log T$ ($r=0.91$, $n=62$). This equation was calculated by Edgar and Shaw (1995a) using published literature on biomass, daily somatic production and water temperature for 62 fish species distributed worldwide. Annual fish production at Falkenstein and Vilm eelgrass sites was estimated by calculating daily production for a three month period according to the seasons spring (Apr, May, Jun.), summer (Jul, Aug, Sep) and fall (Oct, Nov, Dec) in 2002 and for winter (Jan, Feb, Mar), spring (Apr, May, Jun.), summer (Jul, Aug, Sep) in 2003. At Falkenstein the October production values were used to estimate fall production in 2003. Mean water temperatures (\pm SD, $n > 10$) used in the calculations were Jan $1.1 \pm 0.8^\circ\text{C}$, Feb $2.7 \pm 0.3^\circ\text{C}$, Mar $3.7 \pm 0.3^\circ\text{C}$, Apr $7.6 \pm 1.3^\circ\text{C}$, May $14.1 \pm 1.9^\circ\text{C}$, Jun $17.8 \pm 1.2^\circ\text{C}$, Jul $19.3 \pm 1.3^\circ\text{C}$, Aug $20.3 \pm 0.7^\circ\text{C}$, Sep $16.4 \pm 2.0^\circ\text{C}$, Oct $11.3 \pm 0.9^\circ\text{C}$, Nov $5.9 \pm 0.6^\circ\text{C}$ and Dec $4.1 \pm 0.1^\circ\text{C}$.

The total daily consumption (C) of different food categories by fish, for example isopods (I), was estimated for each sampling occasion using the equation obtained from Edgar and Shaw (1995b):

$$C_I = \sum_{i=1}^n \frac{W_i \cdot 0.22 \cdot R_i \cdot P_i}{N \cdot H} \quad (1)$$

where W_i is the wet mass (g) of fish i , n is the total number of fish collected during the sampling occasion, R_i is the estimated daily ration of fish i , P_i is the percentage of the diet of fish I that consisted of isopods, N is the total number of trap hauls during the sampling occasion, H is the factor that converts the drop trap haul data to number per m^2 and 0.22 is the conversion factor that translates wet mass to AFDM. Fish species captured in the eelgrass meadow were assumed to consume 3.1% of their body mass per day (Edgar and

Shaw 1995b). The diet of the fish whose gut content was not investigated was assumed to be similar to the individual fish of the same species with closest body length in the same season. Annual consumption rates were calculated using the mean daily consumption rate in each season.

Results

Gastropods, isopods and amphipods comprised the most frequent groups of invertebrate grazers living in the eelgrass meadow of Falkenstein. Among the isopods *I. balthica* dominated within the Falkenstein eelgrass and *I. chelipes* in Vilm eelgrass systems. *I. balthica*, *E. difformis* and *R. membranacea* achieved the highest mean abundances calculated for Falkenstein eelgrass beds in 2001 and 2002 (Tab. 2).

Table 2. Abundances [$N\ m^{-2}$] of frequent isopods, amphipods and gastropods sampled monthly in the Falkenstein eelgrass meadow between April and October in 2001 and 2002. Data are means (\pm SD) and ranges (n=7)

Species	Abundance		Range	Abundance		Range
	2001			2002		
<u>Isopoda</u>						
<i>Idotea balthica</i>	651	\pm 1072	22-3133	439	\pm 438	90-785
<i>Jaera albifrons</i>				38	\pm 67	0-97
<u>Amphipoda</u>						
<i>Erichthonius difformis</i>	1104	\pm 2015	0-5815	2737	\pm 1676	15-9751
<i>Corophium</i> spp.	541	\pm 624	39-1950	1493	\pm 770	25-6554
<i>Microdeutopus gryllotalpa</i>	241	\pm 276	0-670	1450	\pm 606	87-7441
<i>Gammarus</i> spp.	65	\pm 44	0-140	212	\pm 266	32-386
<u>Gastropoda</u>						
<i>Rissoa membranacea</i>	1900	\pm 3645	0-10616	2518	\pm 1370	0-9204
<i>Hydrobia ulvae</i>	192	\pm 220	0-625	2296	\pm 1529	1418-4591
<i>Rissoa inconspicua</i>	62	\pm 123	0-360	191	\pm 128	0-671
<i>Littorina littorea</i>	78	\pm 67	27-228	79	\pm 83	5-331
<i>Littorina saxatilis</i>				30	\pm 30	0-138

Fish species composition, abundance and biomass

A total of 20 fish species were captured, thereof 15 at Falkenstein and 12 at the Vilm eelgrass site. Gobiidae (55% and 69%), Syngnathidae (29% and 21%) and Gasterosteidae (11% and 8%) represented up to 95% and 98% of the total number of fish caught at Falkenstein and Vilm eelgrass meadows, respectively. The fish species composition differed substantially between the different localities. The semi-pelagic *Gobiusculus flavescens* was most frequent at Falkenstein but absent at Vilm and the demersal *Pomatoschistus microps* was most frequent at Vilm but absent at Falkenstein. *Spinachia spinachia* and *Syngnathus rostellatus* were also missing at the Vilm eelgrass site (Tab. 3).

Table 3. Fish species sampled in the eelgrass meadows at location (L) Falkenstein (F) and Vilm (V), including the scientific fish names, acronyms, number of fishes (N), proportion on abundance (P), ranges of fish lengths and fish wet masses. The backslash separated the data of the two locations

Species	Acronym	L	N	P [%]	TL [mm]	Mass [g]
<i>Gobiusculus flavescens</i> Fabricius	Gofl	F	833	33.4	15-45	0.01-0.7
<i>Pomatoschistus microps</i> Krøyer	Pomic	V	620	35.5	20-39	0.06-0.3
<i>Nerophis ophidion</i> L.	Neop	F/V	449/168	18.0/9.6	10-285/89-304	0.07-1.6/0.08-1.5
<i>Gobius niger</i> L.	Goni	F/V	371/27	14.9/1.5	18-84/43-80	0.04-6.5/0.9-6.5
<i>Syngnathus typhle</i> L.	Syty	F/V	201/191	8.1/10.9	36-237/34-175	0.01-4.8/0.01-2.4
<i>Pomatoschistus minutus</i> Pallas	Pomi	F/V	172/571	6.9/32.7	18-72/21-57	0.04-2.6/0.05-1.0
<i>Spinachia spinachia</i> L.	Spsp	F	150	6.0	30-148	0.07-6.0
<i>Gasterosteus aculeatus</i> L.	Gaac	F/V	113/139	4.5/7.9	20-79/19-67	0.01-4.7/0.04-3.2
<i>Zoarces viviparus</i> L.	Zovi	F/V	97/4	4.0/0.2	44-190/108-127	0.23-36.6/5.3-9.7
<i>Syngnathus rostellatus</i> Nilsson	Syro	F	82	3.3	51-164	0.03-1.6
<i>Perca fluviatilis</i> L.	Pefl	V	20	1.1	72-104	5.9-13.0
<i>Taurulus bubalis</i> Euphrasen	Tabu	F	6	0.2	43-111	1.0-27.0
<i>Platichthys flesus</i> L.	Plfl	F/V	4/4	0.2/0.2	142-163/130-156	31.7-43.4/26.0-33.6
<i>Myoxocephalus scorpio</i> L.	Mysc	F	4	0.2	105-133	11.0-31.7
<i>Pholis gunellus</i> L.	Phgu	F	4	0.2	112-135	2.9-7.6
<i>Pungitius pungitius</i> L.	Pupu	V	2	0.1	32-39	0.26-0.34
<i>Ammodytes tobianus</i> L.	Amto	V	1	0.1	123	3.0
<i>Gadus morhua</i> L.	Gamo	F	1	0.1	125	18.5
<i>Ctenolabrus rupestris</i> L.	Ctru	F	1	0.04	51	1.4
<i>Esox lucius</i> L.	Eslu	V	1	0.06	372	273.4

In general, the Falkenstein eelgrass bed was richer in euryhaline marine species, notably *G. flavescens* and *S. spinachia*, than the Vilm eelgrass meadow, which was inhabited by some limnic predators, such as *Perca fluviatilis* and *Esox lucius*. *Spinachia spinachia*, *S. rostellatus*, *Gadus morhua*, *Myoxocephalus scorpio*, *Taurulus bubalis*, *Pholis gunellus* and *Ctenolabrus rupestris* were also totally absent in the catches at Vilm eelgrass site. *E. lucius*, *P. microps*, *Pungitius pungitius* and *Ammodytes tobianus* were captured exclusively at Vilm (Tab. 3). Most fish species were small-sized (<150 mm TL) and only minor proportions of commercial important species were registered. No juvenile flat fish occurred in the catches. The flounders *Plathichthys flesus* ranged between 130 and 163 mm TL. One individual of cod *G. morhua* with 125 mm TL was detected in September 2003 at Falkenstein. The plaice *Pleuronecta platessa* was absent from the catches at both sampling sites. Seasonal abundance and biomass pattern of the total fish community differ considerably between the two sampling sites.

At Falkenstein total abundances and wet biomasses peaked in late summer or early fall, while the lowest values were observed during winter and spring (Fig. 2F). In April, June and July 2003 the wet biomass values at the Falkenstein eelgrass meadow exceeded the abundance values because next to juveniles large, adult *Z. viviparus* appeared in the catches, which account for nearly 70% of the wet biomass. *Zoarces viviparus* are among the larger fish species, but was included into the analysis because it occurred regularly and in high abundances in the catches in 2003. By contrast, the abundance of the fish assemblage at Vilm culminated two times a year. High abundances and wet biomasses occurred in late spring, due to shoals of *G. aculeatus* entering the eelgrass meadow for spawning and in late summer, when *Pomatoschistus* recruits populate the eelgrass meadow and shoals of *P. fluviatilis* preyed upon these juvenile gobiids (Fig. 2V).

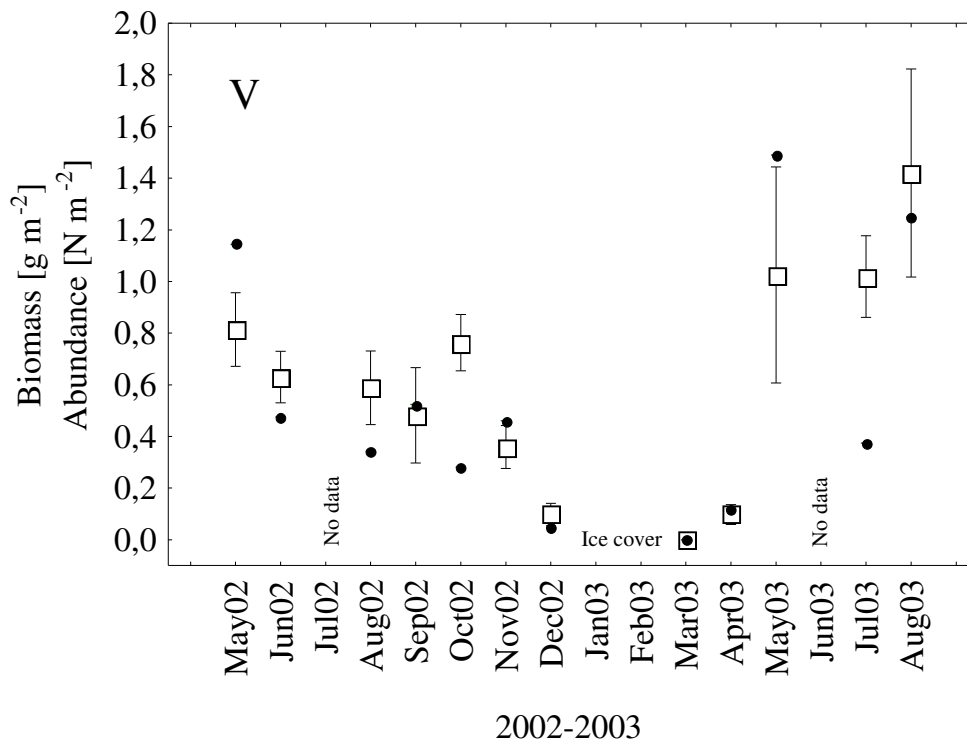
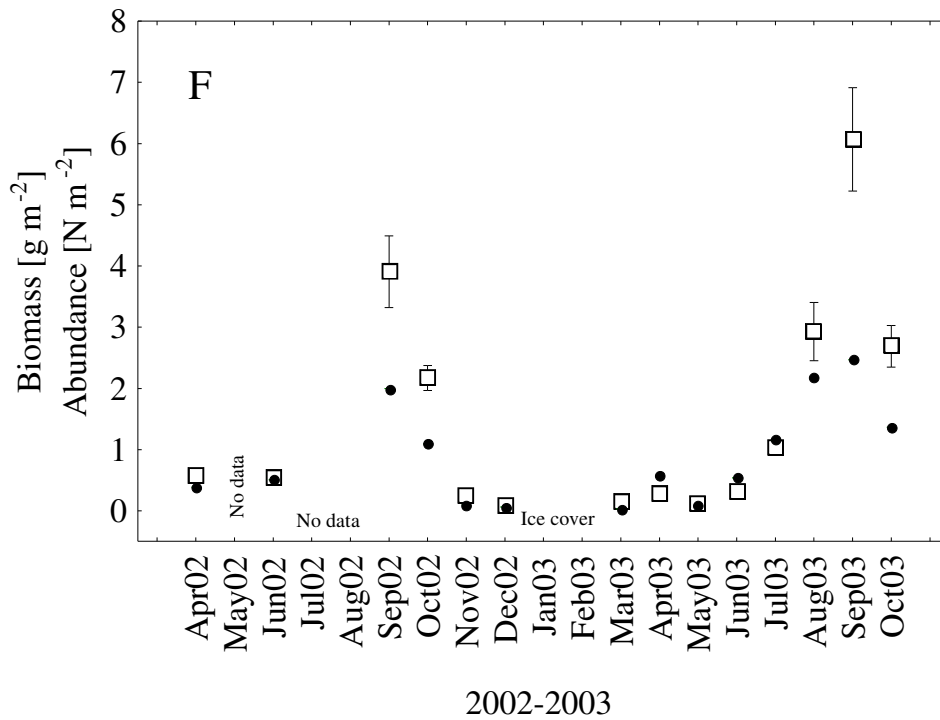

Fig. 2. Abundances (\square) and wet biomasses (\bullet) of all fishes captured in the eelgrass meadows of Falkenstein (F) and Vilm (V) in 2002 and 2003. Abundance values are means (\pm SE, $n=50$, $n=30$ in Aug, Sep and Oct 2003). Biomasses represent single values calculated from the overall fish wet biomass divided by the total sampled area at each month

The highest mean (\pm SD) day abundances and biomasses of small fish species at Falkenstein eelgrass beds achieved $6.1 \pm 4.6 \text{ N m}^{-2}$ and 2.5 g m^{-2} in September 2003, respectively. Maximum day abundance and biomass values at Vilm were $1.4 \pm 2.2 \text{ N m}^{-2}$ in August 2003 and 1.5 g m^{-2} in May 2003, respectively.

Day-night comparison

A comparison of day and night catches showed no differences between the fish abundances and fish species composition in the Falkenstein eelgrass beds. By contrast, the species composition at Vilm altered and the night abundances significantly exceeded the day abundances (Tab. 4).

Table 4. Paired statistical comparison (U-test) of fish abundances in the day (11:00-15:00) and at night (23:00-03:00) catches at Vilm (V) and Falkenstein (F) eelgrass sites. Abundances are means (\pm SD)

Sampling site/date	Abundance [N m ⁻²]	n	T	Z	p
F-day/21.08.03	2.3 \pm 1.8	30	181.0	0.50	0.61
F-night/21.-22.08.03	2.4 \pm 1.5	30			
V-day/26.08.03	1.4 \pm 2.2	30	24.5	4.1	<0.0001
V-night/26.-27.08.03	5.3 \pm 3.2	30			

The comparison of the data collected during the day with those collected during the night indicated a significant increase of small *P. minutus* and *P. microps* recruits (U-test, $n = 30$, $T = 3.0$, $Z = 4.4$, $p = 0.00001$) and decreasing abundances of *S. typhle*. The significantly higher gobiid abundances during the night suggest that these fishes migrate into the eelgrass bed at night, while others (*S. typhle*) leave it at night. At Falkenstein the abundances of *N. ophidion* and *G. flavescens* slightly increased whereas abundances of *P. minutus* and *G. aculeatus* markedly decreased (Fig. 3).

Seasonal fish abundances and biomasses

Falkenstein

The seasonal variations of abundance and biomass within the Falkenstein eelgrass meadows deviate from those described above for the Vilm eelgrass meadows. *G. flavescens* was the most common fish species and relative abundances culminated in September 2002 and 2003. *Gasterosteus aculeatus* contributed only to minor proportions on total abundance and biomass, when compared with Vilm (Figs. 3 and 4).

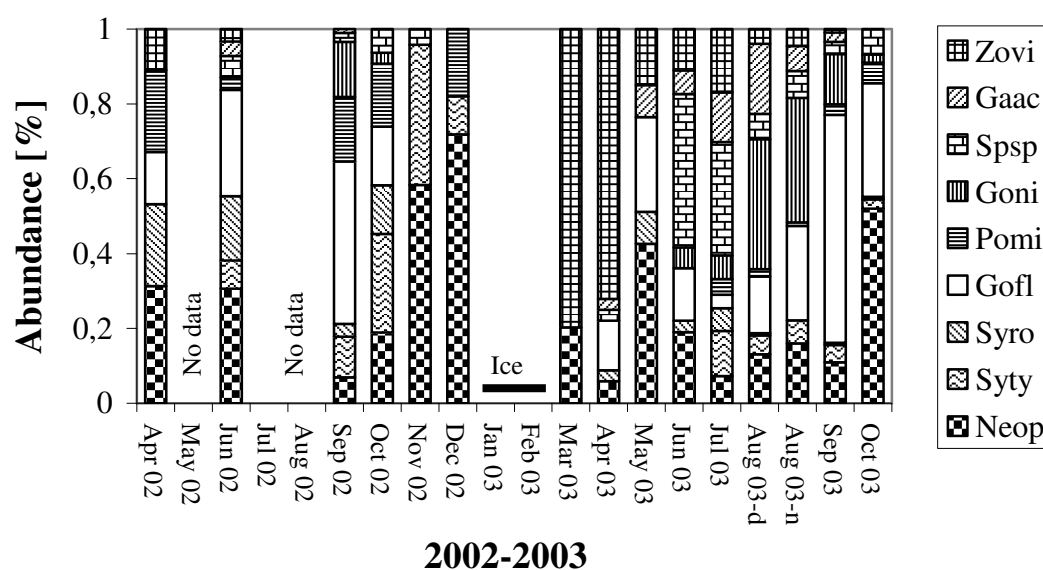

Fig. 3. Seasonal changes in abundance proportions [%] of the Falkenstein eelgrass fish assemblage, including the day-night comparison. Abbreviations of fish species names are given in Table 1. d=day, n=night

Among the syngnathids *N. ophidion* was considered an eelgrass resident, whereas *S. typhle* was absent from the catches in spring and *S. rostellatus* during the colder season. Relative abundances of the syngnathids constituted to high proportions on total abundance values in 2002, ranging from about 10 in April 2003 to almost 100% in November 2002 (Figs. 3 and 4).

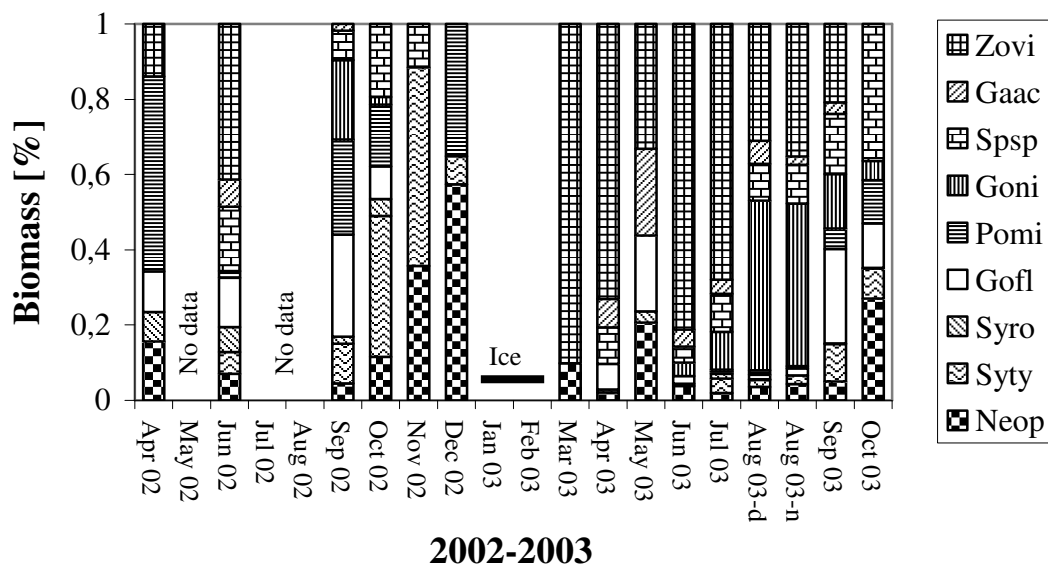

Fig. 4. Seasonal changes in biomass proportions [%] of the Falkenstein eelgrass fish assemblage, including the day-night comparison. Abbreviations of fish species names are given in Table 1. d=day, n=night

Spinachia spinachia and especially *Z. viviparus* dominated the fish community of Falkenstein eelgrass beds in terms of abundance and biomass, particularly during the 2003 sampling period. Juveniles of *Z. viviparus* and *S. spinachia* massively occurred in March 2003 and June 2003, respectively. During the summer months in 2003 large numbers of *G. niger* occurred within the eelgrass meadows (Figs. 3 and 4).

Vilm

Pronounced changes in fish abundances and wet biomasses occurred during the sampling period. *Gasterosteus aculeatus* were most commonly found during spring and early summer and *S. typhle* appeared leaving the eelgrass bed during the colder season between November and April (Fig. 5). Both, *Pomatoschistus* species and *N. opheidion* were captured throughout the entire sampling period and were therefore regarded as residents in the Vilm eelgrass meadows. The relative abundance of *P. microps* and *P. minutus* increased heavily from early winter to early spring (Fig. 5).

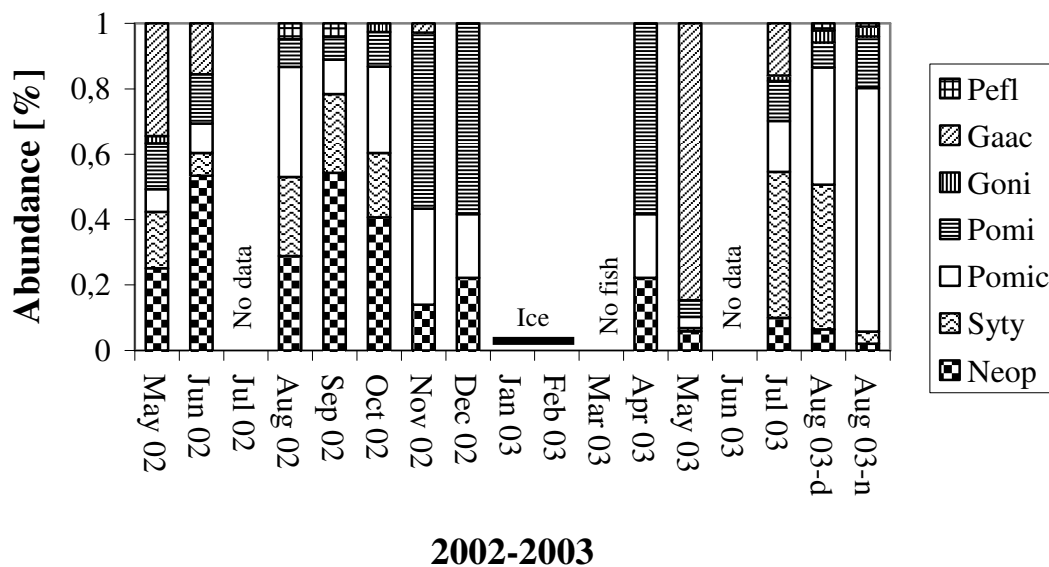

Fig. 5. Seasonal changes in abundance proportions [%] of the Vilm eelgrass fish assemblage, including the day-night comparison. Abbreviations of fish species names are given in Table 1. d=day, n=night

Only few specimens of *G. niger* were captured in the eelgrass meadow and we detected no consistent seasonal abundance pattern. *Perca fluviatilis* appeared in the eelgrass bed in late summer of both years and because of its high individual body mass contributed largely to the biomass proportions (Fig. 6)

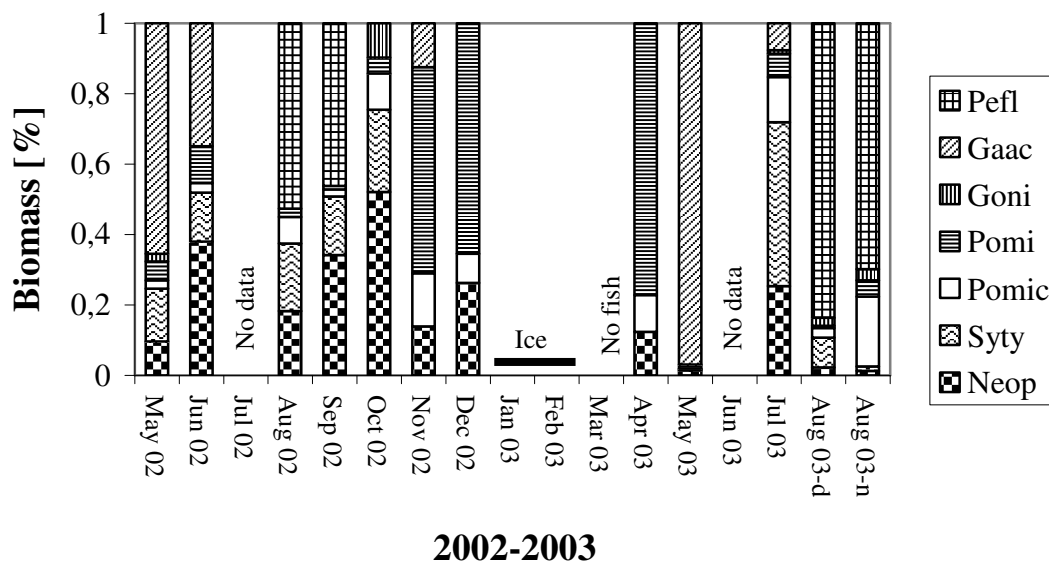

Fig. 6. Seasonal changes in biomass proportions [%] of the Vilm eelgrass fish assemblage, including the day-night comparison. Abbreviations of fish species names are given in Table 1. d=day, n=night

General food composition and feeding habits

The dietary composition of the eelgrass fish assemblages varied substantially depending on sampling locality, season, species and age of the fishes. The general classification by diet shows that the eelgrass fish assemblages of both study sites can be subdivided into four trophic groups (Fig. 7). At Falkenstein Group 1F (Fig. 7) consisted of fish species mainly consuming amphipods. Group 2F contained isopod, amphipod and polychaet feeders. This group includes the most important predators of crustacean mesograzers. The group 3F contained only one species, *S. typhle* that especially fed on decapods, teleost fishes and mysids. Group 4F combined *S. rostellatus* and *G. flavescens* both primarily utilising pelagic food sources including copepods, cladocerans and planktonic gastropod and bivalve larvae. None of the fishes examined exhibited a highly specialised diet. High similarities in diet compositions indicate dietary overlap between *S. rostellatus* and *G. flavescens*, between *S. spinachia* and *Z. viviparus* and between *P. minutus* and *G. aculeatus*. Diet overlap may refer to food competition between fish species. At Vilm the fish species of Group 1V primarily fed on copepods, amphipods and polychaets. The diets of *N. ophidion* additionally contained large amounts of dipterans. *Gobius niger* (Group 2V) fed predominantly on isopods and polychaets. The Group 3V consisted of fish species that mostly consumed copepods, mysids and small quantities of fishes. *Perca fluviatilis* (Group 4V) represented a typical piscivorous predator consuming larger amounts of small teleost fishes. High similarities in diet compositions indicate dietary overlap between *P. microps* and *P. minutus* and between *S. typhle* and *G. aculeatus*. Only *G. niger* consumed notable mass proportions of gastropods.

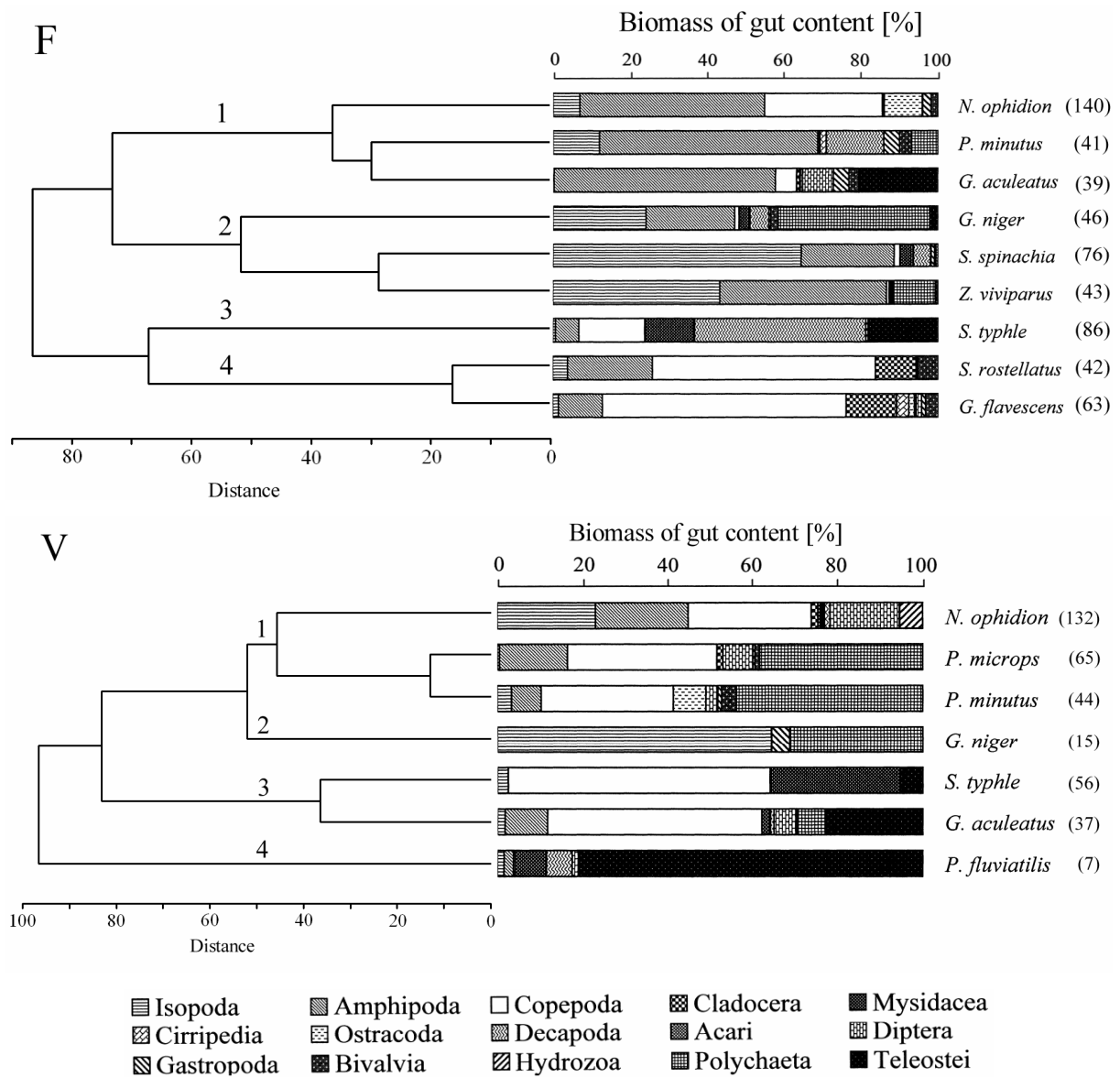

Fig. 7. Classification (cluster analysis) of fish species based on mean diet biomass proportions of different food categories in fish guts. Distances between species were calculated using Euclidean distances which were grouped using single linkage procedure. Number of fish guts inspected is shown in parentheses after the species name. F: Falkenstein, V: Vilm

Food composition and ontogenetic shift

The index of relative importance (IRI) reflects considerable inter- and intraspecific differences in the feeding habits of the fishes captured at the two eelgrass localities. The size-class classification allowed detection of dietary shifts during ontogenesis (Tab. 5).

At **Falkenstein** amphipods, isopods and copepods represented major food components of the eelgrass fish community and volume proportions of crustaceans in the diet ranged from 51 to 95%. The smallest amounts of crustaceans were found in *G. niger*, *G. aculeatus* and *S. typhle*, with 51, 65 and 77%, respectively. Higher values for crustaceans, from 81 and 83% of the total amount of food consumed, were detected in *S. rostellatus* and *P. minutus*. The crustacean proportions consumed by *S. spinachia* and *G. flavescens* exceeded 90% with maximum values of 95% in *N. ophidion*. Important non-crustacean food types belonged to the categories polychaets and fish. The polychaets were mainly fed by *P. minutus*, *G. niger* and *Z. viviparus*. Fishes, including all ontogenetic stages (egg, larva, juvenile, adult) were solely consumed by *G. aculeatus*, *Z. viviparus*, *G. niger* and *S. typhle*.

Nerophis ophidion utilized by far the most food categories and can be considered a generalist with respect to the feeding habit. Major food categories were isopods, amphipods, copepods, cirripeds larvae, ostracods and different development stages of gastropods and bivalves. The importance of copepods in the diet decreased, when fish size increased, whereas importance of isopods and amphipods increased with increasing fish size (Tab. 5). Copepods, amphipods and isopods dominated the diet of *S. typhle* up to 140 mm TL. Mysids, decapods and fishes increased considerably in the diet of larger individuals. *Syngnathus rostellatus* fed mainly on small diets like copepods, cladocerans and bivalve larvae. With increasing fish size the prey spectrum increased and isopods and amphipods became more important food types.

The gobiid fishes were also the dominating fish family in the Falkenstein eelgrass meadow. Their food consisted of isopods, amphipods, copepods, cirripeds, ostracods, gastropods, bivalves and polychaets. During fish ontogenesis smaller prey became less important and amphipods, isopods, mysids, decapods and polychaets became more important. *Gobius niger* consumed notable amounts of fish, when exceeding 50 mm total length. *G. flavescens*, a semi pelagic fish species that shoals and feeds above the eelgrass canopy, was the most abundant species at Falkenstein.

Their food mainly consists of copepods, cladocerans and larvae of bivalves and gastropods. Whereas the importance of gastropods and bivalves larvae in the diet decreased with increasing body size, the importance of cladocerans and cirriped larvae increased. The dietary importance of copepods and ostracods did not change during ontogenesis.

Spinachia spinachia fed substantially on isopods, amphipods and copepods. The importance of copepods decreased to zero with increasing fish size while the importance of isopods simultaneously increased. Isopods, mainly *I. balthica*, were the predominant food of fish between 64 and 150 mm TL. The importance of amphipods did not differ substantially between different size classes. *Spinachia spinachia* emerged as the most important predator of *I. balthica* and gammaridean amphipods within the community of small fish species associated with *Z. marina*. Amphipods, copepods and bivalve larvae represented main food groups consumed by *G. aculeatus* in the eelgrass meadow. The dietary importance of fish in the diet increased slightly with increasing fish size, while importance of isopods, ostracods and bivalves decreased.

Major food categories of *Z. viviparus* were isopods, amphipods, copepods, polychaets and fishes. *Zoarces viviparus* showed pronounced ontogenetic changes in dietary importance. The importance of copepods in the diet decreased to zero during ontogenesis, whereas isopod (especially *I. balthica*) importance heavily increased. Besides the gobies, *Z. viviparus* was the only other fish species ingesting appreciable amounts of polychaets. Individuals exceeding 130 mm total length consumed notable amounts of fish (Tab. 5).

Table 5. Index of Relative Importance [%IRI] calculated for fifteen different food categories and three length classes of frequent small fish species captured from April 2002 until December 2002 and from March 2003 until October 2003 in Vilm and Falkenstein eelgrass meadows

Fish species	TL [mm]	Isopoda	Amphipoda	Copepoda	Cladocera	Mysidacea	Cirripedia	Ostracoda	Decapoda	Acari	Diptera	Gastropoda	Bivalvia	Hydrozoa	Polychaeta	Teleostei
Falkenstein																
<i>N. ophidion</i>	100-149	1.3	23.6	68.4	<0.05		0.8	4.2				1.2	0.5	<0.05		<0.05
	150-199	0.9	17.8	70.2		<0.05	2.3	8.1		<0.05	<0.05	0.2	0.4			<0.05
	200-299	4.1	59.8	30.0			0.2	3.9			<0.05	0.6	1.2			
<i>S. typhle</i>	35-90	0.4	35.3	63.8		<0.05	<0.05	0.4	<0.05				<0.05			
	91-140	2.0	2.9	92.4	0.5	2.0		0.1					<0.05			
	141-240		0.1	37.4	0.1	8.3	0.1	<0.05	48.4				<0.05			5.2
<i>S. rostellatus</i>	70-99			88.6	11.3				<0.05				<0.05			
	100-119		1.5	91.1	7.2		<0.05	<0.05			<0.05	<0.05	0.1			<0.05
	120-165	0.9	6.2	81.6	9.0		<0.05	0.1			<0.05	<0.05	2.2			
<i>G. flavescens</i>	15-24	0.1	0.2	68.0	0.8	0.1	<0.05	0.2				6.3	24.2			0.1
	25-34		3.2	66.5	6.1	<0.05	1.1	0.4	<0.05			4.2	18.5			
	35-45	0.1	2.1	81.0	13.3		2.2	0.3	<0.05		<0.05	0.4	0.5			
<i>P. minutus</i>	15-45	2.4	58.1	17.2			1.0	1.8		0.1		7.5	11.5			0.3
	46-59	14.4	50.8	5.8	0.1	<0.05	3.7	<0.05				9.9	12.0			3.2
	60-75	7.3	82.2	0.1			0.1		0.5			0.6	1.3			8.0
<i>G. niger</i>	20-34	0.9	48.5	40.5		<0.05	<0.05	4.1		<0.05	<0.05	<0.05	2.5			3.4
	35-49	7.7	40.5	22.3		<0.05	0.1	1.2	0.7	<0.05	0.6	1.8	25.0			1.8
	50-85	21.2	43.3	2.2		0.5	0.2	0.2	0.8		0.1	0.1	2.4			28.8
<i>S. spinachia</i>	27-63	1.6	35.2	62.4		<0.05		0.7			<0.05	<0.05	0.1			
	64-100	47.2	46.9	0.6		2.9	1.2				0.1	0.2	0.9			<0.05
	101-150	79.1	19.7			0.1	0.1	<0.05	0.2		<0.05	0.6	0.2			<0.05
<i>G. aculeatus</i>	20-34	0.1	37.3	39.5		<0.05		2.2			0.1	0.5	20.5			
	35-49	2.0	82.8	3.8	0.7	0.1		1.1				2.4	7.3			<0.05
	50-80	<0.05	32.7	48.0	0.5		0.2	1.6			4.1	7.7	0.1			<0.05
<i>Z. viviparus</i>	40-79	0.2	69.8	26.8				0.6			<0.05	<0.05	0.3			2.5
	80-129	44.0	53.0	0.3				<0.05	0.1		<0.05	<0.05	0.3			2.3
	130-190	77.8	19.1				0.1				0.1	0.1	0.5			1.3
Vilm																
<i>N. ophidion</i>	80-149	3.8	0.1	86.2	0.2				0.2		0.1	<0.05	<0.05	9.4		
	150-199	7.6	0.1	74.8	0.2		0.1	<0.05		<0.05	0.3			16.9		
	200-305	13.8	10.3	64.6	0.5	<0.05	<0.05	0.1	0.1		10.0	<0.05	<0.05	0.7		
<i>S. typhle</i>	30-90			98.6		1.4										
	91-130	0.2		95.8	<0.05	4.0										
	131-175			74.2	<0.05	25.8										
<i>P. minutus</i>	20-32	0.5		62.2				2.0			4.7	1.3	0.1			29.2
	33-42		2.5	89.6	3.5						2.0					2.4
	43-60		2.1	62.8					<0.05				0.1			34.9
<i>P. microps</i>	20-25		12.6	33.3				36.2			0.8		3.5			13.5
	26-30	0.2	0.7	71.7			<0.05	<0.05	<0.05		0.1	0.1	0.2			27.1
	31-40			53.4			6.7									39.9
<i>G. aculeatus</i>	19-34		90.4							6.9						2.7
	35-49		50.0				3.3									46.7
	50-67	0.6	4.2	88.4	<0.05	0.1	0.2	<0.05	<0.05	2.4						3.8

At **Vilm** pelagic and benthic copepods dominated the diets of juvenile and adult syngnathids, gasterosteids and gobiids. Isopods and amphipods were generally of minor dietary importance. Gastropods do not reach relevance as food component of small fish species and their mass proportions remained below 1%.

Among the syngnathids *N. ophidion* emerged as a generalised feeder preying upon 11 different food categories. The relative importance of isopods, mainly *Idotea chelipes*, amphipods and dipterans increased in the diet with increasing fish length. In November and December 2002, large amounts of hydrozoans and green epiphytic remains (mostly diatoms) occurred in the diets. These prey components were exclusively consumed by the *N. ophidion*. *Syngnathus typhle* preyed substantially on copepods and mysids. The importance of mysids in the diet increased with increasing fish size, whereas the importance copepods decreased (Tab. 5).

The demersal gobiids *P. microps* and *P. minutus* were the most abundant fish species found in the eelgrass bed. Their food consists largely of copepods and polychaets, and to lesser proportions of dipterans (larvae and pupae) and bivalves, including veliger larvae. Juvenile *P. minutus* between 20 and 32 mm TL also preyed upon gastropods and juvenile *P. microps* between 20 and 25 mm TL consumed amphipods, ostracods and bivalves.

Gasterosteus aculeatus immigrate into the eelgrass bed in May and June. During this period they fed mainly upon copepods, fish (mostly eggs and few larvae), dipterans and polychaets. For adult sticklebacks >34 TL copepods and teleostei (eggs and larvae) are the most important food types. Sticklebacks exceeding 49 mm TL preyed upon ten different food categories, including isopods and amphipod grazer (Tab. 5).

Dietary importance of isopods, amphipods and gastropods

One of the major goals of this study is the assessment of the trophic interactions between herbivorous macroinvertebrates and small fish species. Thus, amphipods and isopods found in the fish diets were subdivided into lower taxonomic units such as genera and species. The %IRI values reflected the relative importance of these eight food components among each other. If only one of these prey types occurred in the diet the %IRI take the value 100 (Tab. 6). Among the isopods *I. balthica* (Falkenstein) and *I. chelipes* (Vilm) and among the amphipods *Gammarus* spp. and *M. gryllotalpa* are considered effective herbivorous grazers on eelgrass leaves. *E. difformis* and *M. gryllotalpa* (with the exception of *N. ophidion* at Vilm) were exclusively found in the fish diets at the Falkenstein eelgrass beds. *C. carinata* were solely detected in the fish diets at Vilm eelgrass site. *Corophium* spp. and *C. carinata*

preferred muddy and fine sandy bottoms and their relevance as epiphyte grazers on eelgrass leaves are considered to be low.

Within the **Falkenstein** eelgrass fish community the isopod *I. balthica* and amphipods represented important food components for the majority of fishes. In general, the dietary importance of *I. balthica* increased with increasing fish length and culminated in *P. minutus* exceeding 45 mm TL, in *G. niger* exceeding 49 mm TL, in *S. spinachia* exceeding 100 mm TL and in *Z. viviparus* exceeding 129 mm TL. Among the amphipods these trends were contrarian and in some cases reversed to the increasing IRI values of *I. balthica*. The dietary importance of *Gammarus* spp. and *E. difformis*, for example, decreased with increasing length of *S. spinachia*. Another example is *Z. viviparus*, whose %IRI values for *Gammarus* spp. increased with increasing length, whereas the values for *Corophium* spp. decreased simultaneously (Tab. 6). These changes indicate complex dietary shifts during fish ontogeny. The isopod *I. balthica* considered as an important food item for the larger individuals of small fish species, especially for *P. minutus*, *S. spinachia* and *Z. viviparus*. On the other side, amphipods were found to be especially important for juvenile fishes, but also for the adults. The detritivorous isopod *C. carinata* was absent from all stomachs and *M. gryllotalpa* was mostly fed by *S. spinachia*. In total, isopods and amphipods represented by far the dominating food component of all fishes examined at Falkenstein (Tab. 6). *Zoarces viviparus*, *S. spinachia*, *P. minutus* emerged as most important predators of idoteid isopods and gammaridean amphipods in Falkenstein.

At **Vilm**, only *Idotea* spp. (*I. chelipes*), *Gammarus* spp. and *Corophium* spp. achieved relatively high dietary importance values. *I. chelipes* attained importance for all length classes of *N. ophidion* and in medium sized *S. typhle*. The importance of gastropod grazers compared to other grazers in the fish diets was negligible. The importance of small gammaridean amphipods reached highest values for medium sized *P. microps*, small *P. minutus* and adult *G. aculeatus* exceeding 49 mm TL (Tab. 6). The results indicated *I. chelipes* and gammaridean amphipods to be of less dietary importance for the minority of eelgrass fishes. Only *N. ophidion* and large *G. aculeatus* consumed notable quantities of important epiphyte grazers.

The feeding habits of rare fish species at Vilm, such as *P. fluviatilis*, *P. flesus* and *G. niger* were inadequately reflected and therefore excluded from the ontogenetic analysis. The dissection, however, indicated *P. fluviatilis* and *P. flesus* as important consumers of idoteid isopods and gammaridean amphipods. The dietary analysis of seven individuals of *P. fluviatilis* between 72 and 107 mm TL revealed decapods (*Rhithropanopeus harrisi*), isopods (*I. chelipes*), gammaridean amphipods and fish (*Pomatoschistus* spp.) as frequent prey items. One individual of *P. flesus* captured in November 2002 had ingested 19 *I. chelipes* between 5.4 and 11.3 mm body length. By contrast, *G. niger* (43-80 mm TL) consumed mainly benthic invertebrates, including polychaets and large proportions of the isopod *C. carinata*, which were not considered to be a herbivorous grazer. Gastropods were assumed to play a minor role in the nutrition of small-sized eelgrass associated fish species in both eelgrass sites investigated.

Table 6. Index of Relative Importance [%IRI] for isopods, amphipods and gastropods consumed by three length classes of frequent small fish species captured from April 2002 until December 2002 and from March 2003 until October 2003 in Vilm and Falkenstein eelgrass meadows

Sampling site	Fish species	TL [mm]	Isopoda			Amphipoda			Gastropoda			Total
			<i>Idotea</i> spp.	<i>J. albifrons</i>	<i>C. carinata</i>	<i>Gammarus</i> spp.	<i>M. gryllotalpa</i>	<i>E. difformis</i>	<i>Corophium</i> spp.			
Falkenstein	Neop	100-149	6.8	0.3		7.0	<0.05	75.2	7.0	3.8	100.0	
		150-199	2.7	1.2		14.1		75.9	4.8	1.3	100.0	
		200-299	11.0	0.3		18.1	0.2	57.0	12.5	1.0	100.0	
	Syty	35-90		0.8		0.5		96.4	2.2		100.0	
		91-140	8.0	0.1		30.9	0.1	50.0	10.8		100.0	
		141-240				4.4		95.6			100.0	
	Syro	70-99									0.0	
	Gofl	100-119				12.0	2.7	82.7		2.7	100.0	
		120-165	15.7	1.3		27.6		50.0		5.3	100.0	
		15-24	2.5			1.7				95.8	100.0	
		25-34				2.0		14.1		83.9	100.0	
		35-45	2.9			13.3		9.8	5.8	68.2	100.0	
		15-45	4.7			24.3		19.1	42.9	9.0	100.0	
	Pomi	46-59	26.8	0.3		4.5	2.4	8.0	46.1	11.9	100.0	
		60-75	18.0			2.7		0.1	78.3	0.8	100.0	
20-34		0.9			19.8	1.4	49.9	27.8		100.0		
Goni	35-49	22.2			16.3	0.7	27.2	32.5	1.2	100.0		
	50-85	45.5	0.1		17.5	0.1	27.0	9.6	0.1	100.0		
	27-63	0.4	1.6		72.0	6.8	11.4	7.7		100.0		
SpSP	64-100	33.3	0.4		29.0	10.3	9.8	16.5	0.6	100.0		
	101-150	91.4			4.7	0.4	0.7	2.3	0.5	100.0		
	20-34		1.3		8.1		87.2	2.0	1.5	100.0		
Gaac	35-49	0.1	0.1		8.0		71.6	18.1	2.1	100.0		
	50-80				47.4		12.9	6.1	33.5	100.0		
	40-79		0.2		2.7		0.2	96.8		100.0		
Zovi	80-129	59.4	0.9		22.3		13.5	3.9		100.0		
	130-190	60.6	3.7		32.6		1.7	1.2	0.2	100.0		
	80-149	91.6			1.7				6.8	100.0		
Neop	150-199	95.5	1.4		1.3				1.9	100.0		
	200-305	73.1	0.5	2.3	19.6	0.1		3.7	0.6	100.0		
	30-90									0.0		
Syty	91-130	96.4							3.6	100.0		
	131-175									0.0		
Pomi	20-32			30.0					70.0	100.0		
	33-42				100.0					100.0		
	43-60							100.0		100.0		
Pomic	20-25				29.9			70.1		100.0		
	26-30			21.1	9.7			58.2	11.0	100.0		
	31-40									0.0		
Gaac	19-34									0.0		
	35-49									0.0		
	50-67	9.3			90.7					100.0		

Size relationships between predator and prey

The size of the prey is one of most important characteristics of predator-prey relationships. Generally prey size increases with increasing predator size and considerable varieties exist between different fish species. *M. gryllotalpa* and the idoteid isopods represented the largest and gastropods the smallest epiphyte grazers consumed by all small fish species (Tab. 7).

Table 7. Median and minimum-maximum length [mm] of amphipods, isopods and gastropods (shell height) preyed upon by the Falkenstein eelgrass fish assemblage

	Species	n	Median	Minimum	Maximum
Amphipoda	<i>Gammarus</i> spp.	542	2.2	0.6	14.4
	<i>M. gryllotalpa</i>	54	3.4	1.2	7.8
	<i>E. difformis</i>	1033	1.8	0.2	9.2
	<i>Corophium</i> spp.	437	2.4	0.7	5.6
Isopoda	<i>I. balthica</i>	474	3.8	0.8	15.3
	<i>J. albifrons</i>	82	1.4	0.7	4.0
Gastropoda		227	0.4	0.1	2.5

Among the frequent fishes at Falkenstein eelgrass beds the syngnathids and *G. aculeatus* preyed upon the smallest prey sizes, whereas the *G. niger*, *S. spinachia* and *Z. viviparus* consumed the largest amphipods and isopods (Fig. 8).

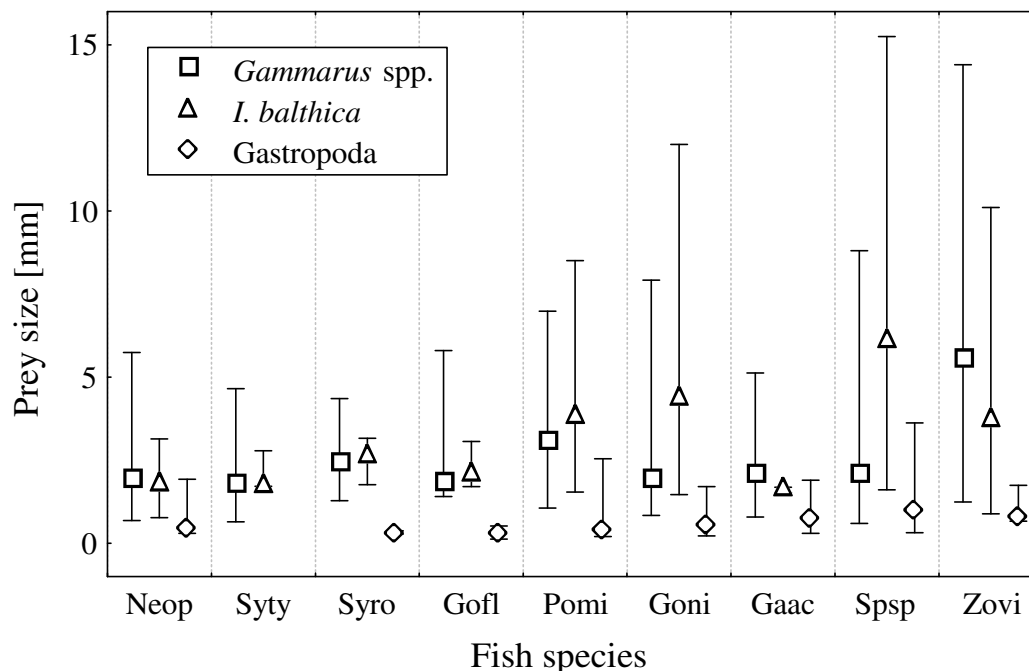

Fig. 8. Median body length [mm] of gammaridean amphipods, *I. balthica* and height of gastropods ingested by fishes captured in the Falkenstein eelgrass meadow between 2002 and 2003. Bars indicate minimum and maximum values. Abbreviations are explained in Fig. 1

Isopods and amphipods exceeding 16 mm body length and gastropods exceeding 4 mm shell height were assumed to be safe from predation of small eelgrass fish species. The prey sizes ranged between 0.2 and 15.5 mm body length, but the majority of prey sizes consumed by the fishes ranged below 6 mm. About 90% of the amphipods, 70% of *I. balthica* and 75% of the gastropods consumed by the total fish community in Falkenstein ranged from 1 to 4 mm body length, 1 to 6 mm body length and 0.2 to 1 mm shell height, respectively. These results emphasise *S. spinachia* and *Z. viviparus* as important predators preying upon the widest size range of herbivorous crustacean grazers up to 15.3 mm body length and the importance of juvenile crustacean benthos to nurture small-sized fishes in eelgrass meadows.

Ontogenetic changes

Most fishes show characteristic changes in diet as they grow. *Spinachia spinachia* and *Z. viviparus* were found to shift from primarily preying on copepods to predation on isopods at larger sizes. This ontogenetic shift in diets takes place for *S. spinachia* at 73 mm TL and for *Z. viviparus* at 87 mm TL (Fig. 9).

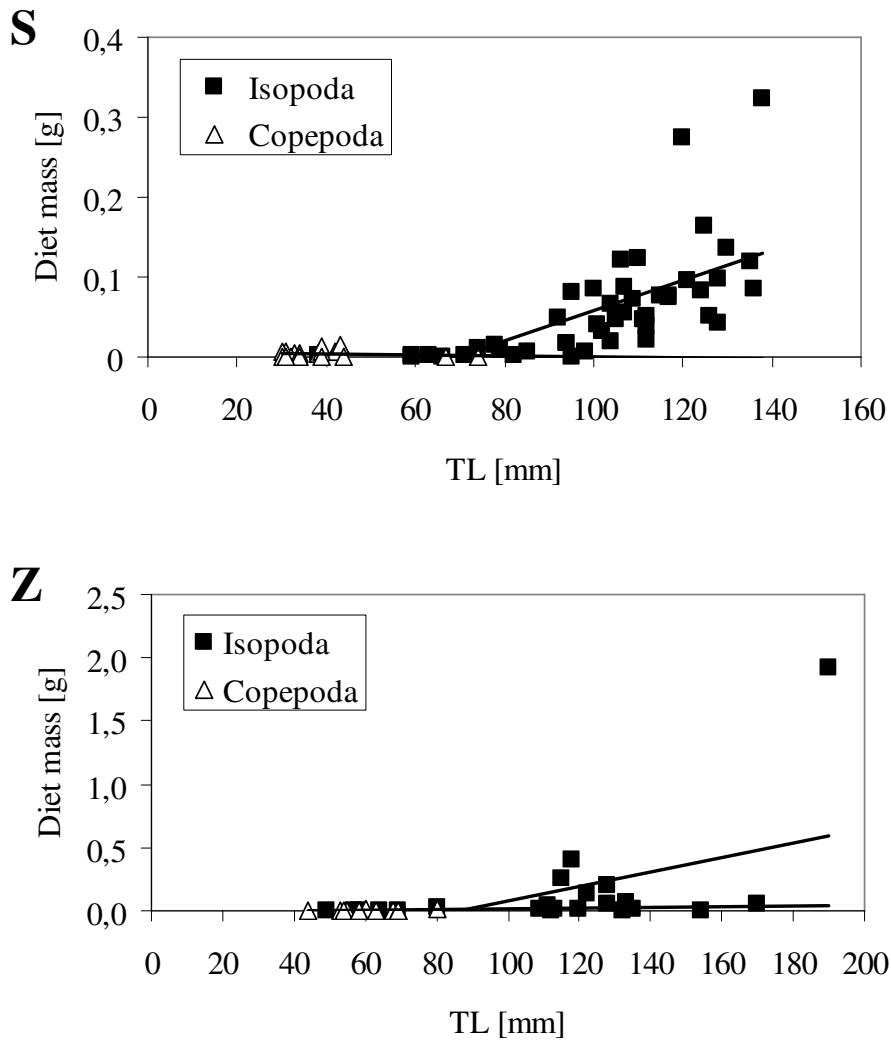

Fig. 9. Ontogenetic shift from copepods to idoteid isopods in *S. spinachia* (S) and *Z. viviparus* (Z). The intersection of the two regressions indicates the point of shifting from copepods to *I. balthica*

The comparison of the length frequency distribution of invertebrates ingested by the fishes and invertebrates inhabiting the eelgrass meadow showed that the small-sized fish assemblage utilized the whole prey size spectrum of *M. gryllotalpa*, *E. difformis*, *Corophium* spp. and *J. albifrons* occurring within the eelgrass meadow. In contrast larger sized gammaridean amphipods, *I. balthica* and gastropods were less common in the fish diets (Fig. 10).

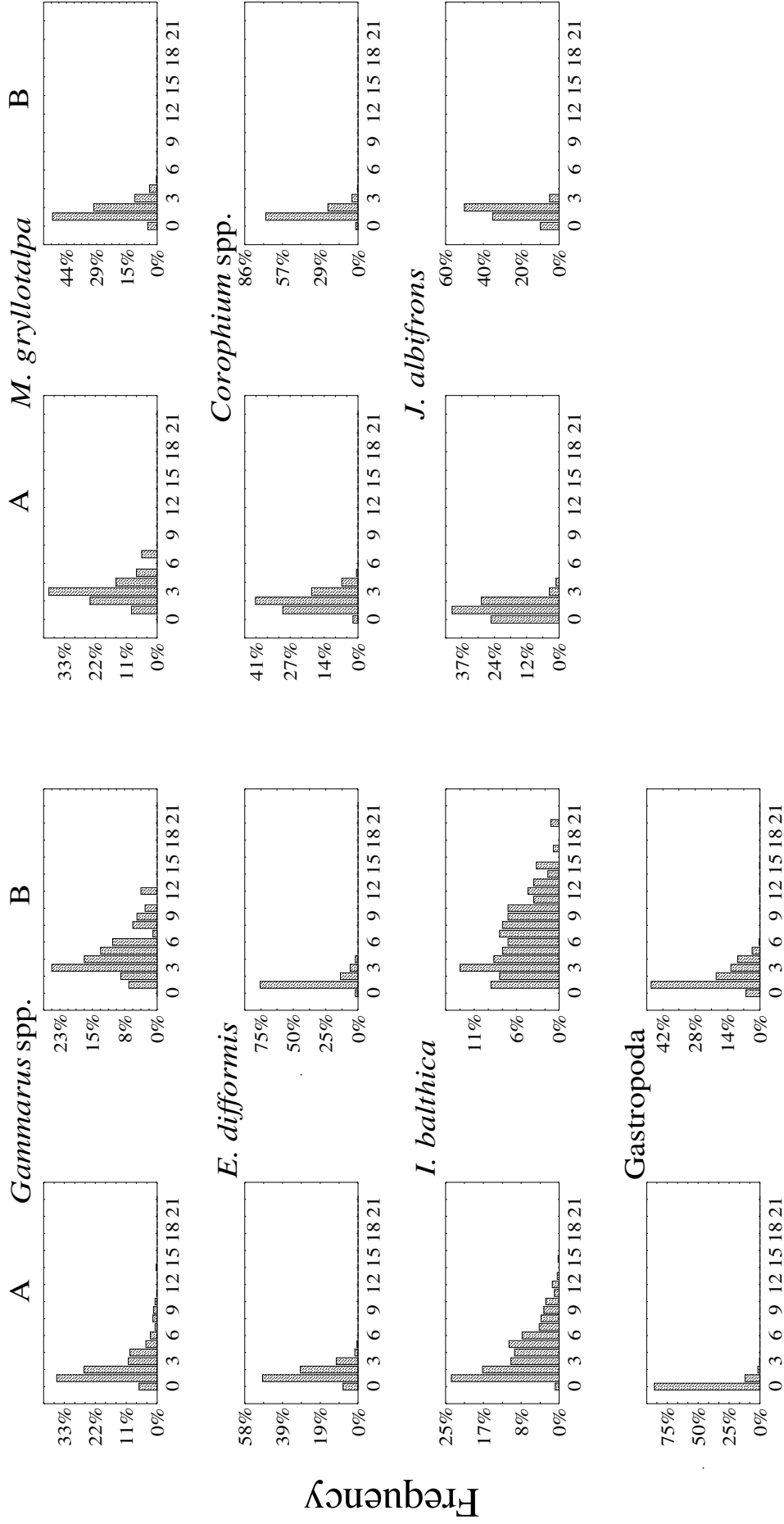

Fig. 10. Length frequency distribution of amphipods, isopods and gastropods (shell height) consumed by fishes (A) and detected in the Falkenstein eelgrass meadow (B)

Production and consumption

The mean total abundance, biomass and production of the small fish species community varied considerably between the years (2002, 2003) and the sampling locations (Vilm, Falkenstein). The abundances ranged from 0.5 to 2.3 N m⁻², the biomasses from 0.13 to 0.38 g AFDM m⁻² and the productions from 0.64 to 1.67 g AFDM m⁻² a⁻¹. The P/B ratios ranged from 3.8 to 4.9 (Tab. 8).

Table 8. Estimated abundance, biomass, production and P/B ratios of small fish species at Vilm and Falkenstein eelgrass sites sampled during 2002 and 2003. Mean abundance and biomass values (\pm SD) are based on monthly sampling data. Annual fish production is based on the seasons (three month period) spring, summer and fall in 2002 and winter spring, summer (Vilm) and fall (Falkenstein) in 2003

Location	Year	n	Abundance [N m ⁻²]	Biomass [g AFDM m ⁻²]	Production [g AFDM m ⁻² a ⁻¹]	P/B
Vilm	2002	7	0.52 \pm 0.23	0.13 \pm 0.10	0.64 \pm 0.6	4.9
	2003	6	2.30 \pm 3.85	0.38 \pm 0.46	1.67 \pm 1.9	4.4
Falkenstein	2002	6	1.33 \pm 1.58	0.23 \pm 0.27	0.88 \pm 1.0	3.8
	2003	9	1.88 \pm 2.05	0.31 \pm 0.22	1.44 \pm 1.1	4.6

The mean values (\pm SD) for abundance (Vilm: 1.3 \pm 2.7, Falkenstein: 1.7 \pm 1.8), biomass (Vilm: 0.24 \pm 0.33, Falkenstein: 0.28 \pm 0.24) and production (Vilm: 1.1 \pm 1.4, Falkenstein: 1.2 \pm 1.1) calculated over the whole sampling period showed minor differences between the sampling locations.

The seasonal somatic fish production rates indicated strong variations with lowest values in the winter and maximum values in the summer months. At Vilm eelgrass beds the spring production in 2002 exceeded the summer production values and during the winter fish production was zero, because no fish was captured at the Vilm study site (Tab. 9).

Table 9. Estimated mean daily fish production [mg AFDM m⁻² d⁻¹] of small fish species in different seasons at Vilm and Falkenstein eelgrass locations. Standard deviation is given when more than one sampling date take place during each season

Year	2002				2003		
	Spring	Summer	Fall	Winter	Spring	Summer	Fall
Vilm	2.97 \pm 0.99	2.17 \pm 0.17	0.64 \pm 0.47	0	1.87 \pm 1.65	10.91 \pm 3.18	-
Falkenstein	1.78 \pm 1.33	7.24	1.24 \pm 1.90	0.09	1.70 \pm 1.35	6.89 \pm 0.97	2.78

The annual consumption rates estimated for the different fish species, sampling sites (Vilm, Falkenstein) and sampling periods (2002, 2003) provide evidence of dietary relevance of

amphipods, isopods and gastropods for the eelgrass fish community at Falkenstein eelgrass site and emphasise the relevance of copepods and detritivorous invertebrates for the Vilm eelgrass fish assemblages in both years of investigation (Table 10).

Table 10. Estimated annual consumption of amphipods, isopods, gastropods, crustaceans and total food consumption by small fish species at Vilm and Falkenstein eelgrass sites during the sampling period 2002 and 2003

Location	Species	Consumption [mg AFDM m ⁻² a ⁻¹]				
		Amphipoda	Isopoda	Gastropoda	Crustacea	Total
Falkenstein 2002	Neop	55.6	19.2	7.1	201.5	242.8
	Syty	18.4	6.6	0.0	320.1	364.3
	Syro	2.3	0.0	0.0	89.5	93.4
	Gofl	25.9	0.3	5.0	383.7	469.8
	Pomi	181.8	120.3	30.6	352.0	536.0
	Goni	46.9	40.9	3.8	121.4	251.2
	Spsp	56.1	307.0	3.9	246.5	815.7
	Gaac	1.9	0.0	11.9	6.1	41.3
	Zovi	28.2	12.6	0.0	41.0	146.8
	Total	417.1	506.9	62.4	1761.9	2961.3
Vilm 2002	Neop	20.8	44.8	0.1	183.8	220.0
	Syty	0.0	3.0	0.0	111.9	124.5
	Pomic	2.5	1.0	0.6	13.1	42.9
	Pomi	9.2	0.1	0.1	36.3	99.0
	Goni	0.0	10.4	0.6	11.0	19.2
	Gaac	14.7	2.3	0.2	84.3	136.7
	Pefl	8.2	3.1	0.0	29.2	173.3
	Total	55.4	64.7	1.7	469.6	815.6
Falkenstein 2003	Neop	189.9	3.4	8.0	232.6	253.7
	Syty	13.3	0.1	6.8	54.9	70.4
	Syro	13.0	1.8	0.0	18.6	33.2
	Gofl	35.7	1.1	10.5	430.7	567.2
	Pomi	44.0	8.3	4.9	57.2	98.5
	Goni	138.1	114.8	1.6	284.0	603.7
	Spsp	135.4	435.8	2.5	377.8	1988.2
	Gaac	75.2	0.5	3.4	82.4	126.8
	Zovi	527.7	425.9	0.6	971.4	1029.5
	Total	1172.4	991.7	38.2	2509.6	4771.1
Vilm 2003	Neop	9.8	15.3	0.0	64.9	67.3
	Syty	0.0	4.7	0.0	151.3	159.0
	Pomic	6.6	0.0	0.0	11.8	49.3
	Pomi	0.4	0.3	0.0	8.0	28.4
	Goni	0.0	14.5	0.9	15.5	31.3
	Gaac	5.7	0.4	0.0	186.2	303.3
	Pefl	0.0	0.0	0.0	0.0	0.0
	Total	22.4	35.2	0.9	437.7	638.7

The results indicate a overall relevance of crustaceans for fish nutrition. At Falkenstein the proportion of annual crustacean consumption on total consumption ranged from 14.8% (*G. aculeatus*) to 95.8% (*S. rostellatus*) in 2002 and from 19.0% (*S. spinachia*) to 94.3% (*Z. viviparus*) in 2003. At Vilm the proportion of annual crustacean consumption on total consumption ranged from 30.5% (*P. microps*) to 89.9% (*S. typhle*) in 2002 and from 23.9% (*P. microps*) to 96.4% (*N. ophidion*) in 2003. *Perca fluviatilis* was excluded from this analysis because only adult specimens were examined. The mean proportions of crustacean consumption by all small fish species taken together were 59% in 2002 and 53% in Falkenstein in 2002. At Vilm these proportions were 58% in 2002 and 69% in 2003. The annual consumption data also showed that the copepod consumption by fishes at Vilm is much more important than compared with Falkenstein eelgrass system. At Vilm 36.2% and 45.0% of the total fish consumption consists of copepods compared with 17.7% and 6.2% at Falkenstein in 2002 and 2003, respectively. The proportions of grazers (amphipods, isopods and gastropods) consumption on total fish consumption was 14.9% and 9.2% at Vilm and 33.3% and 46.2% at Falkenstein in 2002 and 2003, respectively, emphasising the nutritional importance of grazing invertebrates to the majority of fish in the Falkenstein eelgrass bed. Proportions of total amphipods and isopod consumption of *P. minutus* decreased from 43% and 24% in 2002 to 3.7% and 3.8% in 2003. The amphipod and isopod consumption of *Z. viviparus* increased from 6.8% and 2.5% in 2002 to 45 and 43% in 2003, respectively. These pronounced seasonal differences are explained by the heavy decrease of *P. minutus* biomasses from 2002 to 2003 and by the heavy increase of *Z. viviparus* biomass from 2002 to 2003.

Grazer production and fish consumption at Falkenstein eelgrass beds

Amphipods and isopods found in the eelgrass meadow and in the fish diets were subdivided into lower taxonomic units such as genera and species. For these categories we calculated the annual biomass production and compared it with annual fish consumption rates to identify the proportions of annual production consumed by small eelgrass fish species (Tab. 11).

The proportion of the annual amphipod and isopod production consumed by fishes was 39.0 and 37.5%, respectively. Important consumers of gammaridean amphipod and *M. gryllotalpa* were *P. minutus* (12.3 and 8.6% respectively) and *S. spinachia* (8.4 and 6.8% respectively). Large proportions (>50%) of the *E. difformis* production was ingested by *N. ophidion* (25.7%), *P. minutus* (14.5%) and *G. niger* (10.7%) and more than 23% of the *Corophium* production was fed by *P. minutus*. The most pronounced predator of isopods, *S. spinachia*, ingested 23% of the total annual *I. balthica* production which comprised 61% of the total *I. balthica* production consumed by all fishes investigated during 2002. The gastropod production at Falkenstein was 4.7 and 7.1 g AFDM m⁻² a⁻¹ in 2002 and 2003, respectively. These values exceeded the annual production of isopods (1.4 g AFDM m⁻² a⁻¹) and amphipods (1.1 g AFDM m⁻² a⁻¹) by far. The proportion of the gastropod production ingested by the total fish community was extremely low (0.9%) and thereof 0.4% was attributed to *P. minutus* predation.

The consumption rates estimated for the fish assemblages at Falkenstein (Tab. 10) pointed out considerable differences between 2002 and 2003. When comparing the years 2002 and 2003, the consumption rates of *P. minutus* concerning amphipods and isopods were significant lower and rates of *G. niger*, *S. spinachia* and *Z. viviparus* were markedly greater. The over-all results lead to the final conclusions that *G. niger*, *S. spinachia* and *Z. viviparus* belonged to the most important predators of amphipods and isopods. The *S. spinachia* eelgrass population in particular consumed the largest absolute amount of *I. balthica* during the field observations in 2002 and 2003.

Discussion

Fish species composition

The dominating fish families detected in the eelgrass meadows during this study were syngnathids, gobiids and gasterosteids. We recorded 12 fish species at Vilm and 15 fish species at the Falkenstein eelgrass site. Pihl Baden and Pihl (1984) found 14 fish species and the same fish families as mentioned above dominating eelgrass meadows in Western Sweden. Pollard (1984) ranked syngnathids, gobiids and gasterosteids among the prominent fish families occurring in seagrass habitats at various geographical localities in the Atlantic-Mediterranean region. The total fish assemblages evaluated during this study represents a species composition typical for the western and southern Baltic Sea. In general, the Vilm eelgrass meadow accommodates more limnic fish species, whereas Falkenstein eelgrass beds provide a habitat including more marine fish species (Thetmeyer

1998, Jönsson et al. 1998). The total absence of cyprinids in the catches at Vilm is in accordance with observations of Roland Fricke (pers. comm.), who also recorded less limnic fish species, particular the cyprinids, on the seaward directed side of Vilm island. The geographical distribution of different fish species in the Baltic Sea is mainly related to salinity. Euryhaline marine species are more frequent in the western parts whereas euryhaline limnic species occur more often in estuaries and in the southern, eastern and north-eastern parts of the Baltic Sea. At Vilm *E. lucius*, a piscivorous top predator, occurred and no ecological complement was detected at Falkenstein. Juveniles and adults of larger predatory fishes, such as *G. morhua* or flat fish were unique or absent from the catches corroborating the large-scale changes in fish composition due to overfishing and disturbed recruitment (Jackson et al. 2001, Jonzén et al. 2002). Worthmann (1975) and Möller (1984) detected *G. morhua* as a frequent component of the shallow water fish communities at Kiel Bight, particularly inhabiting the shallow eelgrass regions at day time. By contrast Niemann (1991) observed a heavy decrease of juvenile cod and flatfish in Kiel Fjord by sampling the same locations and utilising the same fishing methods as used by Möller (1984) in 1976.

Abundance and biomass

The abundance estimates of fishes in vegetated habitats include a major source of error due to the difficulties quantifying catch efficiencies of the sampling device (Rozas and Minello 1997). The relative catch characteristics of the enclosure drop trap deployed in eelgrass meadows are known (Bobsien and Brendelberger 2006). Total mean (\pm SD) fish abundances calculated over the whole sampling period were 1.3 ± 2.7 and 1.7 ± 1.8 N m⁻² and maximum abundances 5.3 ± 3.2 and 6.1 ± 4.6 N m⁻² for Vilm (night) and Falkenstein (day) eelgrass sites, respectively. Other investigators utilising trawled fishing devices to sample the fish fauna of shallow coastal waters in Kiel Bight generally found lower fish abundances. Thetmeyer (1998), for example, sampled several shallow areas along the east coast of Schleswig-Holstein including eelgrass sites. He reported maximum fish abundances of 0.1 N m⁻² and mean abundances of 0.01 N m⁻². Major differences occurred with regard to individual fish species. The abundances of *S. spinachia*, for example, assessed with the enclosure trap was 0.25 N m⁻², Worthmann (1975) detected 0.013 N m⁻², Niemann (1991) 0.038 N m⁻² and Thetmeyer (1998) 0.01 N m⁻².

During this study only few and no juveniles of larger commercially important species were captured and species such as *S. spinachia* and *Z. viviparus* achieved high relative

abundances and biomasses. These findings confirm the results of Niemann (1991), who detected a slight increase in total fish abundance but a pronounced decrease in total fish biomass in the shallow water fish communities of Kiel Bight between 1976 and 1990. She explained these differences by a substantial increase of small fish species and a marked decrease in larger fishes such as cod and flat fish. The relative proportions of *Z. viviparus*, for example, increased from 1 to 12% and the proportions of gasterosteids from 8 to 42%. The proportions of *S. spinachia* in total fish biomass (captured in October) increased substantially from 1.6% (Worthmann 1975) to 18.6% (Niemann 1991) and to 36.0% (our study). The present study pointed out major changes in the shallow water fish communities of the Baltic Sea, with increasing abundances and biomasses of small-sized fish species. Additionally, the results emphasise the increasing ecological importance of small fish species to eelgrass ecosystem processes particularly for *S. spinachia* and *Z. viviparus*.

Day-night sampling

No differences in fish abundance and species composition between day and night occurred at Falkenstein, whereas abundances significantly increased and species composition changed during night catches at Vilm. Immigration of demersal gobiids was responsible for the heavy abundance increase at night. Species composition changed due to emigration of *S. typhle* out of the eelgrass meadow. The higher fish abundances during the night indicate that the fish migrate into and out of the meadow in response to changing environmental factors, or due to better feeding conditions in or outside the eelgrass meadow and escape from predators. Robertson (1980) suggested predation and food availability as the most likely factors influencing day-night migration of fishes in eelgrass beds in Australia. We also suggest *Pomatoschistus* spp. and *S. typhle* feeding inside and outside the eelgrass meadow at night respectively either due to favoured feeding conditions or due to reduced predation risk.

General nutrition and food composition

The general nutrition pattern observed in this study was similar to those of other seagrass fish assemblages studied worldwide. Many of the fish species found in eelgrass beds are generalists and forage on sandy bottoms as well as in vegetated habitats. Generally, as also shown for both eelgrass locations examined, crustaceans were found to be the major food items in the fish diets of seagrass fish communities (Bell and Harmelin-Vivien 1983, Pollard 1984, Edgar and Shaw 1995a). The present study, however, discovered major

differences in fish feeding habits between Vilm and Falkenstein eelgrass fish assemblage. The proportions of copepod consumption were substantially higher in the eelgrass fish community of Vilm, when compared with Falkenstein. By contrast higher proportions of amphipods, isopods and gastropods were consumed by the Falkenstein eelgrass fish community.

Index of relative importance

A number of factors have been found affecting gut passage rates, including food deprivation, slow digestible or indigestible parts of the food items, the fat content of the prey and lastly, the water temperature (for references see Hyslop 1980). The susceptibility to digestion and gut passage rates differs among prey species and the importance of prey with indigestible structures and slow passage rates may therefore have been overestimated. The index of relative importance used to describe the feeding habit of fishes is probably affected by these factors. In the present study gastropod shells were rarely found in the stomachs, but their relative importance is may be still overrated. This may also be the case for crustacean diets consumed in large quantities by the majority of fishes. In contrast smaller prey items (copepods and cladocerans) and polychaets are liable to fast digestion and therefore certainly be underestimated. The IRI also included information about the number of prey species ingested and therefore the importance of frequent small prey species such as copepods and cladocerans are overestimated. In the cases of copepods and cladocerans these effects are in the opposite direction and may have compensated each other. Polychaets, however, were often found partly digested in the fish guts and enumeration of individuals was impossible. In these cases the number of polychaets was decided to be at least one. In this case both effects are in the same direction and the importance of polychaets in the fish diets was therefore likely to be underestimated.

Individual nutrition and ontogenetic diet shift

Several fish species start out feeding on one prey type and switch to another with increasing body length (Scharf et al. 2000). At Vilm, *N. ophidion* and adult *G. aculeatus* increased their prey spectrum when growing up and the adults represented the most important predators of epiphyte grazing crustaceans, particularly idoteid isopods and gammaridean amphipods. But we generally suggest herbivorous grazers to be of minor importance structuring the eelgrass meadow at the Vilm site. *G. aculeatus* preyed heavily on fish eggs and larvae, which may considerable effect reproduction success of fishes, for

example, large piscivorous predators like *E. lucius* (Nilsson 2004) and thereby can greatly influence ecosystem processes. Gastropods were of minor nutritional importance at both sampling locations.

At Falkenstein *S. spinachia* and *Z. viviparus* were recorded as the most important predators of crustacean grazers, especially gammaridean amphipods and *I. balthica*. Both fish species possess pronounced ontogenetic diet shifts and feeding pressure on idoteid isopods varied strongly depending on fish length. The juveniles predominantly fed on amphipods and copepods. When the fishes grow, the importance of copepods decrease to zero and the importance of amphipods slightly decrease. Simultaneously predation upon *I. balthica* increased heavily in *S. spinachia* and *Z. viviparus* when exceeding 73 and 87 mm TL, respectively.

Size relations

The size relationships between predator and prey are of paramount importance when examining predator-prey interactions. In general, the maximum prey size ingested increases with increasing body size of the fish and the maximum prey size ingested by a fish is often positively related to fish biomass (Scharf et al. 2000). The median sizes of amphipods (1.8-3.4 mm) and isopods (1.4 and 3.8 mm) ingested by small-sized fish species at Falkenstein eelgrass beds were similar, but the median shell heights of gastropods were continuously smaller (0.4 mm). The maximum shell height found in the fish guts was 2.5 mm. In the majority of fishes, the maximum prey sizes of amphipods and isopods do not exceed 10 mm body length. *Spinachia spinachia* and *Z. viviparus* ingested the largest amphipods and isopods up to 14.4 and 15.3 mm body length, respectively. The length frequency distributions of amphipods, isopods and gastropods showed that the fishes mainly preyed upon small-sized prey items up to 5 mm length with emphasis on sizes between 1 and 3 mm length. These size classes between 1 and 3 mm length were also most abundant in the Falkenstein eelgrass meadow. Larger sized gammaridean amphipods and isopods (>16 mm) and gastropods above 3 mm shell height were assumed to be safe from predation by small eelgrass fish species.

Production and P/B ratios

The annual somatic fish production (1.1 and 1.2 g AFDM m⁻² a⁻¹) and the P/B ratios (4.6 and 4.4) calculated over the entire sampling period were similar at Vilm and Falkenstein eelgrass beds, respectively. Edgar and Shaw (1995a) concluded that production

calculations provide a much more stable signal than density calculations. They further considered that production estimates provide better insight into biological properties of communities than estimates of abundance. Pihl Baden and Pihl (1984) sampled the mobile epibenthic fauna with a drop trap (mesh size 1 mm) including small fish species in three *Z. marina* meadows in Western Sweden. They reported mean fish abundances of 6.3 N m^{-2} (range: 0.2 to 30.0 N m^{-2}) and mean biomasses of $0.11 \text{ g AFDM m}^{-2}$ (range: 0.08 to $0.13 \text{ g AFDM m}^{-2}$). The fish production was $0.71 \text{ g AFDM m}^{-2}$, calculated for four dominating fish species during their sampling from May to December at Lindholmen eelgrass site. Compared with our study the abundances assessed in the Swedish eelgrass beds were relatively high, and biomasses and production values relatively low, which was probably due to higher proportion of juveniles in their catches. The enclosure trap (mesh size 6 mm) used during this study insufficiently collected the early juvenile individuals. The total fish production estimated for the Falkenstein and Vilm eelgrass systems were therefore slightly higher compared with the *Zostera* meadows in Western Sweden. Compared with other seagrass beds in the world the estimated fish production at Vilm and Falkenstein eelgrass beds ($\approx 1.1 \text{ g AFDM m}^{-2} \text{ a}^{-1}$) was low. Lubbers et al. (1990) calculated about $4.1 \text{ g AFDM m}^{-2} \text{ a}^{-1}$ for six dominant fish species in Chesapeake Bay and Edgar and Shaw (1995a) about $3.8 \text{ g AFDM m}^{-2} \text{ a}^{-1}$ for small fish species in vegetated habitats in Western Port, Victoria.

At Falkenstein and Vilm eelgrass sites the fish production exceeded the fish biomass which resulted in production-biomass ratios ranging between 3.8 and 4.4. Thorman and Fladvad (1981, cited from Pihl Baden and Pihl 1984) used a drop-net to estimate the biomass and production of small fish species in an estuary on the Swedish west coast. They cited a small fish species biomass and production of 4.4 and $5.3 \text{ g wet mass m}^{-2}$, respectively, given a P/B ratio of 1.2. As compared with other seagrass systems outside of Europe the fish biomass detected during this study was explicitly lower and P/B ratios higher. Adams (1976a and b), for example, assessed a mean fish biomass of about $1.5 \text{ g AFDM m}^{-2}$ and production rates of about $4.6 \text{ g AFDM m}^{-2}$ resulting in P/B ratios of about 2.8. We can explain the high P/B ratios found at Vilm and Falkenstein as a result of high production rates and low fish biomasses. The relatively low biomasses originate from high proportions of syngnathids and young recruits which exhibit low individual biomasses.

Consumption and trophic relations

The estimated annual fish consumption provides evidence for the dietary relevance of grazing amphipods and isopods for the eelgrass fish community at Falkenstein and emphasises the importance of copepods and detritivorous benthic fauna for the Vilm eelgrass fish assemblage. Generally the consumption of isopods, amphipods and gastropods by fish was very low at Vilm eelgrass site and the relative proportions of detritivorous species such as *C. carinata* and *Corophium* spp. in the fish diets were high. The abundances of herbivorous grazers were very low at Vilm and at the same time the quantities of attached epiphytes were low, suggesting other factors than grazing invertebrates to regulate the epiphyte and eelgrass growth (Munkes 2005). In contrast, herbivorous grazers dominated the invertebrate fauna of the Falkenstein eelgrass beds and also the diets of the small fish species assemblage.

The over-all fish consumption of the annual gastropod production was very low (0.9%) at Falkenstein eelgrass beds and thereof 0.4% was attributed to *P. minutus* predation. The majority of gastropods occurring in the eelgrass meadows of Falkenstein are effective epiphyte grazers. This was shown for *Hydrobia ulvae* (Phillipart, 1995), for *Lacuna* spp. (Nelson 1997) and for *Bittium varium* (Van Montfrans et al. 1982). The gastropods *R. membranacea* and *L. littorea* belong to the most abundant gastropods at Falkenstein with highest grazing capabilities. Both species were capable to reduce the epiphytes effectively from eelgrass leaves and as a result enhance eelgrass growth (Jaschinski, pers. comm.). The predation pressure on gastropods coming from the small-sized fish species community inhabiting eelgrass meadows was suggested to be marginal.

The proportions of the total annual amphipod and isopod production consumed by all eelgrass fishes were 39 and 38% in 2002, respectively. *Spinachia spinachia*, *Z. viviparus* and *P. minutus* emerged as the most important predators of gammaridean amphipods and idoteid isopods. The annual consumption rates of *P. minutus* and *Z. viviparus* varied considerably between both years of investigation, depending on annual abundance and biomass fluctuations. Adult *S. spinachia* (> 73 mm TL) emerged as the most important predators of *I. balthica* in 2002 and 2003. *Spinachia spinachia* population consumed 60% (2002) and 44% (2003) of the total isopod consumption and 23% of the total annual *I. balthica* production in 2002. The proportions of annual crustacean grazer production consumed by all fishes appeared relatively low and structuring effects on crustacean epiphyte grazers due to predation of small-sized fish species appeared less likely.

The fish community of the Falkenstein eelgrass beds were shown to substantially feed upon the smallest development stages of the crustacean grazers. These epiphyte crustacean grazers seem to be an important food resource for the eelgrass fish assemblage at Falkenstein.

Acknowledgement

The environmental foundation Deutsche Bundesstiftung Umwelt (DBU) financed this research. We thank Britta Munkes and the students Björn Thoma, Michael Teßmann, Tonio Lorenzen, Daniel Oesterwind, Stefan Conrad, Arno Dung, Hanno Iven for their help in collecting field samples. Further, we thank Sandra Gohse-Reimann for invertebrate abundance, size data and size-mass relationships as well as Kerstin Maczassek and Britta Munkes providing data of seasonal changes in eelgrass structure.

**The fifteen-spined stickleback (*Spinachia spinachia*):
An effective predator of grazing crustaceans
in eelgrass beds**

Abstract

Marine mesograzers, such as isopods, amphipods and gastropods, are competent at reducing epiphytic cover from eelgrass leaves and may be an important factor in the maintenance of eelgrass productivity and growth. The trophic interaction between small eelgrass fish species and herbivorous mesograzers in temperate eelgrass beds is widely unknown. Field research and laboratory experiments were made to elucidate the feeding ecology of fifteen-spined sticklebacks, *Spinachia spinachia* L., living in eelgrass beds of the western Baltic Sea.

Seasonal quantitative abundance estimates of sticklebacks and potential prey organisms were performed. Fish diet analysis showed feeding habits, size relationships between predator and prey, maximum prey sizes eaten and food preferences in the field. Feeding experiments in the laboratory yielded results concerning size relationships between predator and prey, as well as food choice. Furthermore, the feeding efficiency of *S. spinachia* was quantified, preying on varying densities of *Gammarus oceanicus* and *Idotea balthica*, respectively, and under varying eelgrass shoot densities. *Spinachia spinachia* emerged as a common and prominent member of the eelgrass fish community in terms of abundance and biomass, as well as an important predator in eelgrass habitats consuming considerable amounts of epiphyte grazers, especially *I. balthica*. Gastropods, amphipods and isopods were the most abundant grazers in the eelgrass meadow. *Rissoa membranacea* (Gastropoda), *I. balthica* (Isopoda), and *Microdeutopus gryllotalpa* (Amphipoda) dominated in terms of quantity. Sticklebacks fed mainly on isopods, amphipods and copepods. Proportions of the main food categories displayed pronounced ontogenetic and seasonal variations. Copepods represented the major food component of juvenile sticklebacks, but as fish size increased, *I. balthica* became the most important food type. Amphipods occurred in juveniles as well as in adult fish, whereas gastropods appeared only to a negligible extent. In the eelgrass habitat *S. spinachia* positively selected *I. balthica*. Preference differed considerably between different amphipod species. Gastropods were avoided. *Spinachia spinachia* selected *M. gryllotalpa* positively and avoided *Gammarus* spp., *Erichthonius difformis* and *Corophium* spp.. The fact that *S. spinachia* selected *I. balthica* positively in comparison to amphipods could not be corroborated in the laboratory examinations. Feeding choice as determined in the laboratory ranked in the order *Neomysis integer* > *G. salinus* > *I. balthica*. *I. balthica* captured by *S. spinachia* in the eelgrass meadow were significantly larger compared to *Gammarus* spp.. The maximum length of *I. balthica* consumed by sticklebacks in the

eelgrass meadow was 15.3 mm, the maximum length of *Gammarus* spp. 8.8 mm (non-gammaridean amphipods 5.3 mm) and the maximum height of gastropods 3.6 mm. The maximum handling time for large *G. oceanicus* was up to twenty fold longer than for large *I. balthica*. The feeding rates of the sticklebacks preying on amphipods correlated positively with prey density. Ingestion rates of *S. spinachia* feeding on amphipods or isopods were not limited by eelgrass densities up to 400 shoots m⁻², but feeding success on *I. balthica* decreased significantly in the absence of vegetation.

Introduction

Eelgrass meadows constitute economically and ecologically important ecosystems, fulfilling pivotal physical, chemical, and biological functions (Hemminga and Duarte 2000). A decline in eelgrass beds has been reported worldwide and is often associated with increasing anthropogenic nutrient loads (Short and Wyllie-Echewerria 1996, Hauxwell et al. 2003). Increasing nutrient supply enhances the growth of macroalgae and microalgae, colonizing both the eelgrass leaves and the sediment, which results in shading and finally in a decline of eelgrasses (Hauxwell et al. 2000). Herbivorous invertebrate grazers, mainly isopods, amphipods and gastropods, are capable of reducing these epiphytes efficiently and therefore constitute a vital component facilitating eelgrass dominance by consuming their competitively superior epiphytic algae (Jernakoff et al. 1996). Important mesograzers with potential effects on ecosystem functions are gastropods (Schanz et al., 2002), isopods (Hootsmans and Vermaat 1985) and amphipods (Howard 1982). Small fish species, in turn, may have important consequences in structuring eelgrass grazer assemblages by preying on these invertebrates (Nelson 1979, Orth et al. 1984, Heck et al. 2000). The qualitative and quantitative examination of eelgrass fish communities, including their diets and size relationships of predator and prey (Gill 2003), is essential to understand the complex trophic interactions and regulations of coastal marine ecosystems at these intermediate trophic levels. The population dynamics and feeding ecology of eelgrass fishes have been described from many countries all over the world (Kikuchi 1974, Orth and Heck 1980, Robertson 1984, Bell and Pollard 1989, Edgar and Shaw 1995a, b, c). Comparable investigations of temperate seagrass beds in northern Europe, however, are sparse. Most studies focussed on the fish fauna of shallow waters in general (Pihl Baden and Pihl 1984, Nellbring 1985, Thetmeyer 1998). Pihl and Pihl (1984) quantitatively sampled the mobile epibenthic fauna of three *Zostera marina* beds at 0.7-1.5 m depth on the west coast of Sweden. There *Zostera* occurred together with *Fucus serratus* and *Fucus*

vesiculosus, covering up to 40 % of the bottom and *Ruppia* spp. at the most shallow part of one site. Nellbring (1988) performed intensive quantitative and qualitative studies of fishes in shallow waters in the Northern Baltic Proper (Sweden). He sampled the fish fauna by means of a drop trap and the deeper parts using the visual diving census technique and gill nets. *Z. marina* beds, however, were not included in his studies.

The present paper focuses on the predator-prey interactions between fifteen-spined sticklebacks (*Spinachia spinachia* Linnaeus, 1758) living in eelgrass beds, and epiphyte mesograzers inhabiting the littoral zone of the Baltic Sea. We quantified small fishes as well as macroinvertebrate seasonal abundances and biomasses in the field and determined the dietary habits of sticklebacks by analysing gut content. Special attention was paid to the size relationships between fish predator and mesograzer prey including the effects of prey size on handling time. The food choice of sticklebacks was determined under laboratory conditions and for field-caught fishes. The maximum prey sizes ingested by the sticklebacks under natural conditions were compared with laboratory results. Additionally, we investigated the effects of varying prey abundances and eelgrass shoot densities on the feeding efficiency of sticklebacks in the laboratory.

Material and methods

Study area and animal maintenance

Sampling took place in a *Zostera marina* seagrass meadow located in the outer Kiel Fjord (Falkenstein, 57°24'42''N, 10°11'24''E) from November 2001 until October 2003. Abundances and biomasses of sticklebacks were quantitatively estimated at monthly intervals. Bobsien and Brendelberger (2006) give a detailed description of the sampling site and the fish sampling method.

For laboratory experiments *S. spinachia* and crustacean grazers, *Gammarus oceanicus* (Segerstråle, 1947), *Gammarus salinus* (Spooner, 1947) and *Idotea balthica* (Pallas, 1772), were collected by dredging and dip netting from eelgrass beds in Kiel Bay. In the laboratory we kept fish and crustacean grazers in 250 L square tanks and 60 L aquaria, respectively, supplied with running Baltic Sea water, at 13±1 °C and 17±1 psu. Sticklebacks were fed with living *Gammarus* spp. and *I. balthica* of all sizes (2-20 mm body length), allowing the fish to become experienced with the different prey types and sizes.

Diet analysis

Seventy-six sticklebacks, captured between Nov 2001 and Sep 2003, were grouped into three size classes (27-63, 64-100 and 101-150 mm total length) to detect seasonal and ontogenetic changes in diet composition. Immediately after capture, we anaesthetised the fish with benzocaine (0.1 % ethyl-4-aminobenzoate solution) and fixed them in 96 % ethanol. The fish were measured for total length (TL) and for standard length (SL) to the nearest millimetre as well as for wet biomass with 0.01 g accuracy. The mouth width (W_M) of *S. spinachia* was calculated from body length with the formula obtained from Kislalioglu and Gibson (1976a). The sticklebacks were dissected and their digestive tracts inspected. The total diet content was removed and diet mass was determined gravimetrically with 0.001 g accuracy. Total diet mass was estimated from the difference between full and emptied gastrointestinal tract. The prey species were determined to the lowest possible taxonomic level. The diets were categorized in food groups comprising (1) isopods, (2) amphipods, (3) gastropods, (4) copepods, (5) mysids, (6) cirripeds, (7) ostracods, (8) decapods, (9) dipterans, (10) bivalves and (11) polychaets. Further categories included organic (unidentifiable) and inorganic (sand) components. The prey items were counted, measured in length, maximum width (isopods, gastropods, copepods) and maximum height (amphipods, mysids). The widths of isopods and gastropods as well as the heights of amphipods were assumed to limit the maximum prey size eaten by *S. spinachia*. Body height of amphipods was chosen because fish eat large amphipods sideways (pers. obs.). Prey dimensions were measured to the nearest 0.01 mm. Measurable fragments of partly digested prey were used to recalculate prey dimensions. This was done by means of regression equations between prey width, prey height and prey length obtained from intact prey species (Appendix, Tab. III). For curvilinear-shaped *Gammarus* spp. the distances from the anterior end of the caput to the dorsal posterior end of thoracomer four (CT_G) were measured. These measurements were used to recalculate total length (L_G) and height (H_G) by regression (Appendix, Tab. IV). The diet volume of the different food categories was estimated visually (Hyslop 1980). The volume of each food category was used to recalculate the mass of each food category from the total diet mass. Mass of isopods and amphipods were estimated using length-weight relationships (Appendix, Tab. I), then summed for the prey group and expressed as a percentage of the total wet weight of all food items. Diets of each fish species were estimated using percent of number (%N), percent of volume (%V), percent of mass (%M) and frequency of occurrence (%F). %N was calculated as the number of individuals of each food category

divided by the total number of food items in the stomachs and %V as the volume of each prey category divided by the total volume of all stomach contents. %W was calculated as the total wet weight of each food category divided by the total weight of stomach contents. %F of a prey type was expressed as the number of stomachs containing the food category divided by all stomachs containing food. Finally, the “index of relative importance” (IRI) was calculated as the sum of the %N and the %V multiplied by the %F for each prey category (Hyslop 1980).

Experimental design and procedures

Handling time and food choice

The relationship between prey size and prey type on handling time as well as food choice of the fifteen-spined sticklebacks was investigated in transparent aquaria (40x21x25 cm), each stocked with one stickleback. The bottom of each aquarium was covered with washed beach sand (grain size \approx 0.4 mm). Prior to all feeding experiments the sticklebacks were deprived of food for 12 hours.

Handling time

Forty-one *S. spinachia* between 102 and 164 mm TL were kept in holding tanks and fed with different sized gammarids and *I. balthica*. The prey, *G. oceanicus* and *I. balthica*, presented in the experimental trials were subdivided into seven size classes (Tab. 1).

Table 1. Size categories of *I. balthica* and *G. oceanicus* offered *S. spinachia* in the handling time experiments

prey type	length categories [mm]						
	I	II	III	IV	V	VI	VII
<i>I. balthica</i>	2.0-2.9	3.0-3.9	4.0-4.9	5.0-5.9	6.0-6.9	7.0-7.9	8.0-8.9
<i>G. oceanicus</i>	2.9-4.4	4.7-6.4	6.7-8.5	8.7-10.7	10.9-12.7	13.0-14.8	15.0-16.8

Prior to one handling time experiment, we randomly chose twelve fish specimen out of the stock of sticklebacks and kept them separately in individual aquaria. We presented single prey items to each fish, either *I. balthica* or *G. oceanicus*, released with a pipette at the front wall of the aquarium, allowing optimal observation of prey handling. The aquaria were visually partitioned from each other. The handling time was recorded from the first attack to the swallowing of the prey. At termination of the experiments, the fish were measured for total length and were relocated into the holding tank. We performed a maximum of two runs of twelve replicates in a day. All seven size-classes of both prey

types were offered in a random size order with a maximum of two prey items per fish and day. A total of 195 repeated measurements were conducted within two weeks. In 27 cases the fish rejected the prey items, including 14 trials with *G. oceanicus* and 13 trials with *I. balthica*, respectively.

Preference

Feeding selectivity of sticklebacks caught in the field was estimated using the index of electivity (α) (Chesson 1983):

$$\alpha_i = \frac{r_i \cdot p_i^{-1}}{\sum_{j=1}^m (r_j \cdot p_j^{-1})}$$

where α_i = preference index for prey type i,

r_i and r_j = proportion of prey type i or j in the diet,

p_i and p_j = proportion of prey type i or j in the environment,

i and j = 1, 2, 3, ... m,

m = number of prey types.

The formula compares the proportions of prey types present in the fish's diet with proportions of prey in the natural environment. It assumes that food density does not change appreciably during the observational period. The observed values were compared with a value expected if feeding were random on all prey categories ($\alpha = 1/m$, m = number of prey categories).

Multiple food choice experiments

Experiments were conducted to investigate the food choice of fifteen-spined sticklebacks for three different prey types (isopods, amphipods, mysids) and two size categories (large, small) in the laboratory. Kislalioglu and Gibson (1976a) discovered that a prey width of 0.6 times as wide as the mouths of the fifteen-spined sticklebacks provides the best energy return for the lowest costs and therefore prey items were considered "small" when the above-mentioned mean ratio is ≤ 0.6 and "large" when this ratio is > 0.6 (Tab. 2).

Table 2. Prey dimension (D_p) of the food items offered in the multiple-choice experiments and the ratio of prey dimension (D_p) to mouth width (M_w) of *S. spinachia*. Prey dimension considered maximum height of *N. integer* and *G. salinus* as well as maximum width of *I. balthica*. Values are means (\pm SD)

Food item	Category	D_p [mm]		Ratio [$D_p M_w^{-1}$]	
<i>N. integer</i>	Large	2.9	± 0.3	0.9	± 0.1
	Small	1.0	± 0.1	0.3	± 0.04
<i>G. salinus</i>	Large	2.4	± 0.2	0.8	± 0.1
	Small	1.7	± 0.2	0.6	± 0.1
<i>I. balthica</i>	Large	2.8	± 0.2	0.9	± 0.1
	Small	1.9	± 0.1	0.6	± 0.1

Forty-seven *S. spinachia* between 88 and 110 mm TL were kept in holding tanks. Prior to each experiment we randomly chose twelve fish specimens out of the stock of sticklebacks and kept them separately in individual aquaria. We presented three different prey types simultaneously in random size combinations to single individuals of fifteen-spined sticklebacks. Each of the eight possible prey-size combinations out of three food types and two size categories were replicated in twelve independent aquaria. We divided each aquarium into a resting and a feeding compartment by means of a removable non-transparent separating plate and introduced single fish individuals into the resting compartments two days prior to the experiments. The feeding compartments were fitted out with three plexiglass tubes (height 135 mm, width 30 mm, inner diameter 25 mm). The tubes were located side by side near the front wall of the aquaria allowing unrestricted observations to the sticklebacks' foraging behaviour. The positions of the tubes were predefined so that all prey items were presented at the same level and with equal distances between them. In order to eliminate biases related to a distinct position of the tubes, each food combination was arranged in random order (left, middle, right). Freshly killed (frozen) prey items were fixed separately with fine nylon filaments inside the plexiglass cylinders 6 cm above the sediment. The upper sides of the tubes were covered with fine gauze to prevent the fish from entering. At the beginning of the experiments we removed the separating plate and observed *S. spinachia*'s prey capture behaviour. The visual fixation of one of the prey followed by the fish's body assuming an S-shape was considered as positive prey choice.

Prey density and shoot density

We designed foraging experiments in order to estimate the effects of prey abundance (Exp I and II) and eelgrass shoot density (Exp III and IV) on predation efficiency of *S. spinachia*. Experiments were carried out in opaque plastic containers (65 cm high, 75 L vol.) evenly illuminated by fluorescent tubes from above. A 10 cm thick layer of washed beach sand (grain size ≈ 0.4 mm) covered the bottom of each container. The containers expanded slightly from the base (28x28 cm) to the top (34x34 cm). At the sediment surface (10 cm above the bottom) the dimension was 29x29 cm. *Z. marina* plants collected in eelgrass beds by hand at low water level were planted uniformly with fragments of their rhizomes into the sediment. Shoot densities and prey densities utilized in the experiments were derived from density measurements in the field. The *Zostera* shoot length was 458 ± 64 mm (mean \pm SD, $n=20$). Fifteen-spined sticklebacks acted as predators, *G. oceanicus* and *I. balthica* as prey. Experimental treatments of Exp I and II included three levels of prey densities, 20, 50 and 100 *G. oceanicus* or *I. balthica* per container, respectively. *Zostera* shoot density was 25 shoots per container in all treatments. Exp III comprised three levels of eelgrass shoot densities, with 3, 17 and 33 *Zostera* shoots per container. Exp IV incorporated treatments with 3 *Zostera* shoots per container (low eelgrass density) and 33 *Zostera* shoots per container (high eelgrass density). Identical treatments without vegetation were also prepared. Prey densities of *G. oceanicus* or *I. balthica* were 25 individuals per container in Exp III and IV, respectively. Each treatment was replicated in six independent containers. The dependent variable was the ingestion rate of the sticklebacks. The ratios of prey width (or height) to mouth width of *S. spinachia* ranged between 0.3 and 0.5. Table 3 presents the sizes of predator and prey utilized in the feeding experiments.

Table 3. Sizes of predator ($n=18$) and prey used in the feeding efficiency experiments. Prey dimensions indicate the height of *G. oceanicus* ($n=10$) and the width of *I. balthica* ($n=10$). Values are means (\pm SD)

Exp	Predator	TL [mm]	Prey	dimension [mm]
I	<i>S. spinachia</i>	176 \pm 10	<i>G. oceanicus</i>	2.1 \pm 0.3
II	<i>S. spinachia</i>	115 \pm 13	<i>I. balthica</i>	1.4 \pm 0.2
III	<i>S. spinachia</i>	179 \pm 8	<i>G. oceanicus</i>	2.1 \pm 0.3
IV	<i>S. spinachia</i>	117 \pm 11	<i>I. balthica</i>	1.4 \pm 0.2

Each experimental container was stocked with one *S. spinachia*. Twenty-four hours later the prey animals were added in absolute darkness to allow the prey to disperse and settle, without being captured by the sticklebacks. The experiments began 30 minutes later by switching on the illumination. After eight hours exactly the fish were removed from the containers and the remaining prey organisms were counted. For this purpose, we removed the complete contents of the containers and carefully searched for and counted the remaining prey animals. Water and sediment were filtered with a fine sieve (mesh size 1.0 mm) and all eelgrass blades were stripped off by hand to detect prey animals attached to the eelgrass leaves or retained in the leaf folds. The differences between the number of prey animals added and the number of prey returned was taken as the number of prey eaten by *S. spinachia* during the experimental period. In the graphs prey density is given as the mean of initial and final concentration of the prey individuals.

Further experiments quantified the biases involved with the experimental design. Sources of biases are cannibalism and prey organisms escaping from detection. Experimental treatments with shoot densities of 400 shoots m^{-2} and 25 *I. balthica* (n=10) or 25 *G. oceanicus* per aquarium (n=10), respectively, but without predator presence were set up and evaluated after eight hours.

Statistical analysis

T-test distinguished widths or lengths between amphipods and isopods. Mann-Whitney U-tests differentiated handling times between *G. oceanicus* and *I. balthica*. Spearman rank correlations were calculated for relationships between prey size and handling time as well as prey density and ingestion rates of *S. spinachia*. We statistically evaluated the multiple food choice experiments using the resampling approach described by Bärlocher (1998). The resampling approach compared the actual food choice data with randomly reshuffled actual data obtained by five replicate runs of 10 000 simulations (Monte Carlo analysis). Differences between prey sizes consumed in the field and under laboratory conditions were analysed by Wilcoxon matched-pairs signed-ranks test. The effects of prey density and *Zostera* shoot density to the feeding rates of *S. spinachia* were evaluated by Kruskal-Wallis test.

Results

Macrozoobenthos abundance

Gastropods, isopods, and amphipods comprised the most frequent and important groups of herbivorous mesograzers living in the eelgrass meadow. *Rissoa membranacea*, *Microdeutopus gryllotalpa* and *I. balthica* achieved the highest total abundances throughout the sampling period (Tab. 4).

Table 4. Abundances [$N\ m^{-2}$] of crustacean and gastropod mesograzers sampled monthly between April 2001 and October 2002 in the eelgrass meadow. Data are means \pm SD and ranges

Species	Abundance		Range		Abundance		Range	
			2001				2002	
<u>Isopoda</u>								
<i>Idotea balthica</i>	651	\pm 1072	22-3133		439	\pm 438	90-785	
<i>Jaera albifrons</i>					38	\pm 67	0-97	
<u>Amphipoda</u>								
<i>Gammarus</i> spp.	65	\pm 44	0-140		212	\pm 266	32-386	
<i>Microdeutopus gryllotalpa</i>	241	\pm 276	0-670		1450	\pm 606	87-7441	
<i>Erichthonius difformis</i>	1104	\pm 2015	0-5815		2737	\pm 1676	15-9751	
<i>Corophium</i> spp.	541	\pm 624	39-1950		1493	\pm 770	25-6554	
<u>Gastropoda</u>								
<i>Littorina saxatilis</i>					30	\pm 30	0-138	
<i>Rissoa membranacea</i>	1900	\pm 3645	0-10616		2518	\pm 1370	0-9204	
<i>Rissoa inconspicua</i>	62	\pm 123	0-360		191	\pm 128	0-671	
<i>Hydrobia ulvae</i>	192	\pm 220	0-625		2296	\pm 1529	1418-4591	
<i>Littorina littorea</i>	78	\pm 67	27-228		79	\pm 83	5-331	

Abundance and biomass of *S. spinachia*

Spinachia spinachia represented a common member of the eelgrass fish community in terms of abundance and biomass as well as a major consumer of herbivorous mesograzers. Maximum abundance of 0.25 *S. spinachia* m^{-2} occurred in July 2003 and maximum wet biomasses of 0.5 g m^{-2} in October 2003, corresponding to 30% of the total fish abundance in July 2003 and to 36% of the total fish biomass in October 2003. Fig. 1 shows the size-frequency distribution of *S. spinachia* used for the gut content analysis and the total fish lengths at different sampling dates.

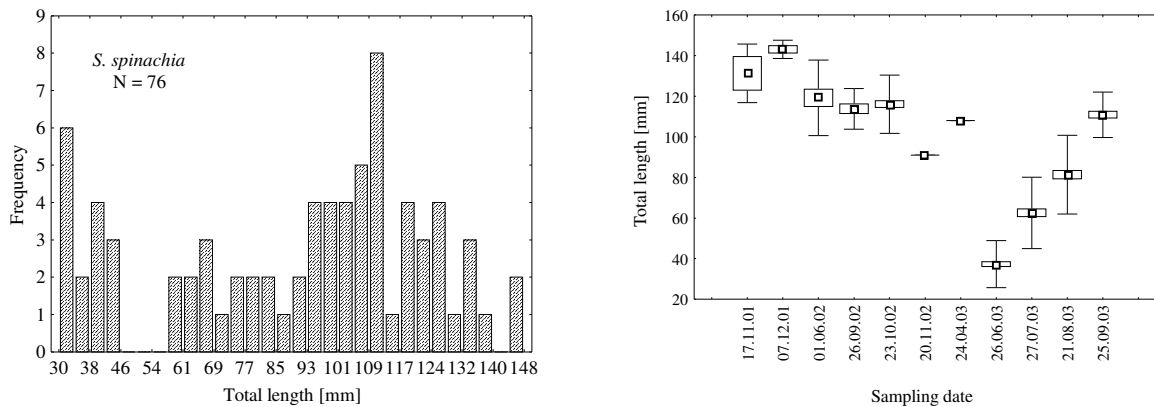

Fig. 1. Length frequency distribution and total length of *S. spinachia* captured between November 2001 and September 2003 in the eelgrass beds. Length values are means with standard deviation and standard error

Diet composition

The diet analysis of *S. spinachia* revealed eleven food components. Isopods, amphipods and copepods were considered as the most important food groups, followed by mysids, ostracods and bivalves. Gastropods were of minor importance (Tab. 5). Two isopod species, *I. balthica* and *J. albifrons*, and four amphipod genera, *Gammarus*, *Microdeutopus*, *Ericthonius* and *Corophium* occurred in the diet. The numerical proportion of isopods was for *I. balthica* 96% and for *J. albifrons* 4.0%. Amphipods consisted of *Gammarus* spp. 45%, *M. gryllotalpa* 15%, *E. difformis* 20% and *Corophium* spp. 21%.

Ontogenetic changes

Isopods and amphipods were the most important prey types in adult sticklebacks, whereas copepods and amphipods dominated in juvenile sticklebacks. The proportion of copepods decreased rapidly when fish size increased. Above 85 mm TL copepods were absent from stomach contents. At the same time, the proportion of isopods increased abruptly in the diet. Crustaceans contributed more than 90 % of the diet mass of each size class of *S. spinachia*. Gastropods, mysids as well as all other prey categories constituted only minor proportions in the diet (Tab. 5).

Table 5. Dietary composition in guts of *S. spinachia* (n=76) captured in Falkenstein eelgrass beds from Nov 2001 until September 2003. *Spinachia* were grouped into three length class categories. Diet composition is presented in percent of mass [%M], percent of number [%N], frequency of occurrence [%FO], index of relative importance [IRI] and percent of IRI [%IRI]

Length [mm]	[%M]			[%N]			[%FO]		
	27-63	64-100	101-150	27-63	64-100	101-150	27-63	64-100	101-150
Isopoda	5.4	38.0	73.8	0.5	32.2	63.9	45.5	85.7	76.9
Amphipoda	57.9	48.0	16.9	8.4	44.9	26.0	86.4	64.3	61.5
Copepoda	34.6	0.2	0.0	89.6	3.1	0.0	81.8	21.4	0.0
Mysidacea	0.0	11.8	0.9	0.0	5.5	1.0	4.5	21.4	7.7
Cirripedia	0.0	0.0	0.7	0.0	0.0	1.4	0.0	0.0	3.8
Ostracoda	1.5	0.5	0.0	1.0	5.8	0.5	45.5	25.0	3.8
Decapoda	0.0	0.0	5.6	0.0	0.0	0.5	0.0	0.0	3.8
Diptera	0.1	0.2	0.1	0.1	0.7	1.4	9.1	7.1	3.8
Gastropoda	0.0	0.5	1.0	0.2	1.4	2.9	4.5	14.3	19.2
Bivalvia	0.5	0.7	0.2	0.3	5.8	1.9	18.2	17.9	15.4
Polychaeta	0.0	0.0	0.6	0.0	0.7	0.5	0.0	3.6	3.8

Length [mm]	[IRI]			[%IRI]		
	27-63	64-100	101-150	27-63	64-100	101-150
Isopoda	264.1	6018.3	10594.8	1.6	47.2	79.1
Amphipoda	5727.8	5971.9	2634.9	35.2	46.9	19.7
Copepoda	10156.0	71.2	0.0	62.4	0.6	0.0
Mysidacea	0.2	370.3	14.6	0.0	2.9	0.1
Cirripedia	0.0	0.0	8.2	0.0	0.0	0.1
Ostracoda	112.0	157.5	2.0	0.7	1.2	0.0
Decapoda	0.0	0.0	23.6	0.0	0.0	0.2
Diptera	2.2	6.6	6.0	0.0	0.1	0.0
Gastropoda	0.8	26.4	75.6	0.0	0.2	0.6
Bivalvia	14.7	116.7	33.3	0.1	0.9	0.2
Polychaeta	0.0	2.4	4.3	0.0	0.0	0.0

Seasonal changes

From summer to fall 2002 and 2003 a contrary course pattern between ingested prey volume of *I. balthica* and amphipods was observed (Fig. 2). The decrease of copepods in the diet was negatively related to size increase of *S. spinachia* in summer 2003 (Fig. 1 and 2).

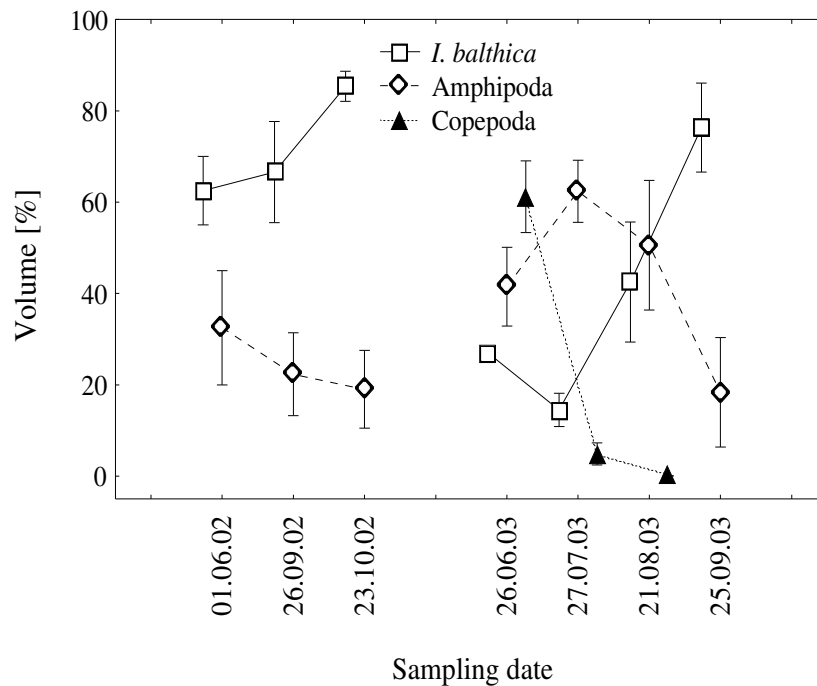

Fig. 2. Diet volume proportions (means \pm SE) of *I. balthica*, amphipods and copepods captured by *S. spinachia* from June 2002 to September 2003

Size relationships between predator and prey

The relationship of width and height of the prey and the length of *S. spinachia* was best described by exponential regression models and was significant for pooled prey organisms, isopods and amphipods (Tab. 6).

Table 6. Regression equations that best describe the relationship of prey width (W) and prey height (H, amphipods only) [mm] for the main prey types in stomachs on standard length [mm] of the predator *S. spinachia* (SL_{SP}) caught in eelgrass meadows of Kiel Bay

prey type	n	equation	r ²	p
Pooled prey (PP)	582	$PP_{W/H}=0.148 \exp(0.185 SL_{SP})$	0.51	<0.001
Isopods (I)	171	$I_W=0.352 \exp(0.134 SL_{SP})$	0.16	<0.001
Amphipods (A)	275	$A_H=0.209 \exp(0.119x SL_{SP})$	0.35	<0.001
Copepods (C)	120	$C_W=0.229 \exp(0.019 SL_{SP})$	0.01	0.22
Mysids (M)	19	$M_W=0.691 \exp(0.044 SL_{SP})$	0.07	0.33

The prey length of amphipods was averaging $3.6\pm 1.8\%$ (n=275) and isopods $5.8\pm 2.3\%$ (n=171) of the total fish length.

Sizes of isopods, amphipods and gastropods in the diet

The mean length (t=3.69, df=390, p=0.0002) and the mean width (t=9.76, df=390, p<0.0001) of *I. balthica* fed under natural conditions were significantly greater than the length and height of amphipods ingested. The mean length of isopods and amphipods found in the stomachs varied between 1.5 and 6.6 mm and 2.4 and 3.2 mm, respectively (Tab. 7).

Table 7. Prey sizes [mm] of potential epiphyte grazers (isopods, amphipods and gastropods) found in diets of *S. spinachia*. Values are means (\pm SD) as well as minimum and maximum values (ranges)

Isopoda	n	Length	Range	Width	Range
<i>I. balthica</i>	168	6.6 \pm 2.9	1.6-15.3	1.8 \pm 0.8	0.4-4.5
<i>J. albifrons</i>	11	1.5 \pm 0.1	1.4- 1.5	0.5 \pm 0.05	0.5-0.6
Amphipoda				Height	Range
<i>Gammarus</i> spp.	123	2.7 \pm 1.6	0.6-8.8	0.6 \pm 0.4	0.2-2.2
<i>M. gryllotalpa</i>	41	3.2 \pm 1.0	1.2-5.2	0.5 \pm 0.2	0.2-1.0
<i>E. difformis</i>	55	2.4 \pm 0.7	1.2-5.6	0.4 \pm 0.1	0.2-0.8
<i>Corophium</i> spp.	58	2.5 \pm 0.7	1.2-5.1	0.4 \pm 0.1	0.2-0.6
Gastropoda		Height	Range	Width	Range
	12	1.2 \pm 1.0	0.3-3.6	0.9 \pm 0.7	0.3-2.8

Optimal prey size

The mean ratios between prey width (isopods) or height (amphipods) and mouth width of *S. spinachia* found in the eelgrass meadow deviated considerably from the value of 0.6 quoted by Kislalioglu and Gibson (1976a) (Fig. 3). The mean ratio for *I. balthica* was 0.42 ± 0.23 (range 0.04-1.09) and for amphipods 0.28 ± 0.19 (range 0.07-1.12).

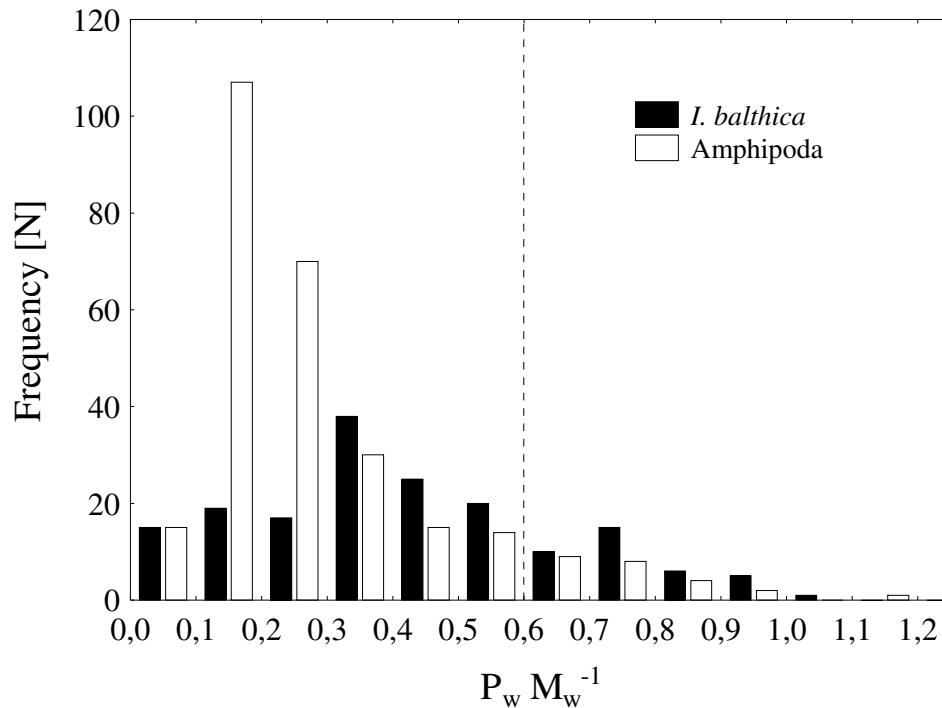

Fig. 3. Frequency distribution of the ratio between prey body size (P_s), the width of *I. balthica* as well as body height of amphipods, and mouth width (M_w) of *S. spinachia*. The dashed line indicates the reference value of 0.6 (see above), which was assumed to provide the best energy return for the lowest costs

Maximum prey size

The maximum prey length (MPL) of isopods (I) and amphipods (A), consumed by *S. spinachia* in the eelgrass beds, in relation to fish total length [TL, mm] is best described by exponential equations $MPL_I = 1.2211 \exp(0.0206 TL)$, $r^2 = 0.96$, $n = 6$, and $MPL_G = 1.4012 \exp(0.0234 TL)$, $r^2 = 0.95$, $n = 12$, respectively (Fig. 4).

Idotea balthica >4.5 mm and amphipods >2.0 mm in width and height, respectively, were not found in stomach contents of even the largest sticklebacks (147 mm TL). Size differences between isopods and amphipods consumed by sticklebacks in eelgrass beds are evident throughout the sampling period (Fig. 5).

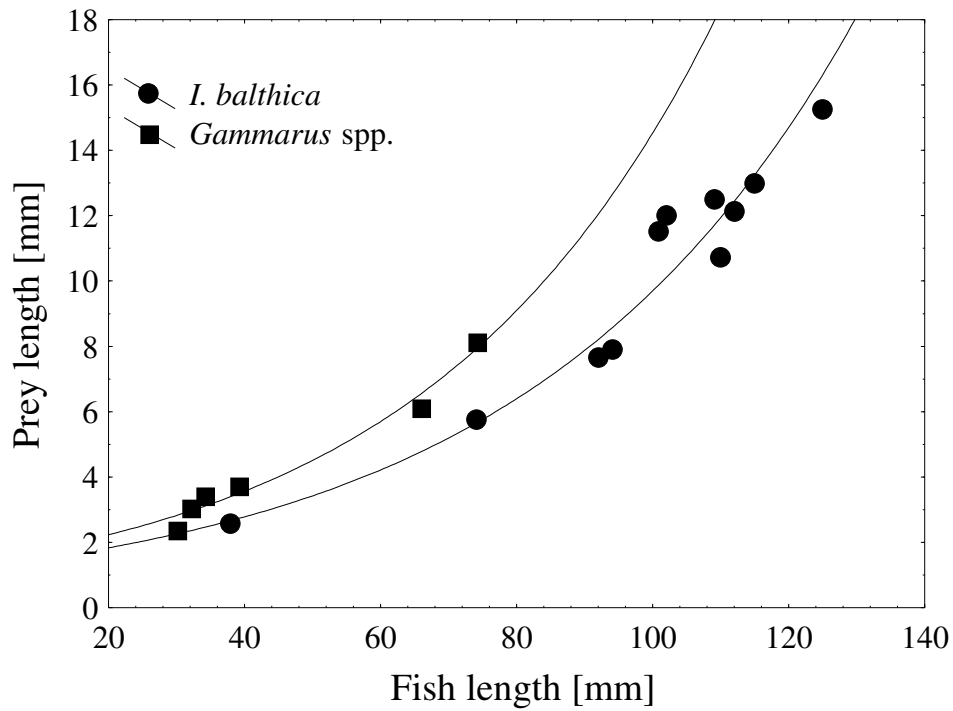

Fig. 4. Maximum prey length in relation to fish length (TL) shown for *I. balthica* and *Gammarus* spp. eaten by *S. spinachia* in the eelgrass beds with exponential fit

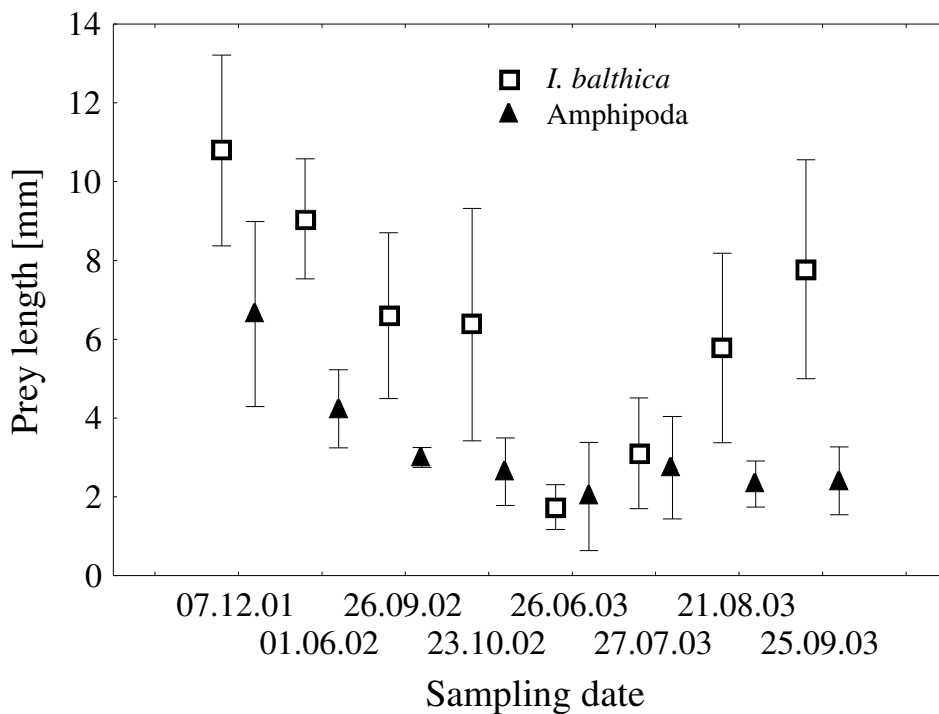

Fig. 5. Length of *I. balthica* and amphipods found in stomachs of *S. spinachia* sampled in eelgrass beds. Values are means (\pm SD)

Laboratory Experiments

Handling time and prey size

Handling time experiments offering *S. spinachia* (102-164 mm TL) various prey length categories revealed significant Spearman rank correlations between both prey width of *I. balthica* ($r_s=0.759$, $t_{(N-2)}=10.093$, $p<0.0001$, $n=83$) and prey height of *G. oceanicus* ($r_s=0.791$, $t_{(N-2)}=9.929$, $p<0.0001$, $n=86$) and handling time. Only fish >120 mm TL ate prey in length category VI (*I. balthica* 7.0-7.9 mm, *G. oceanicus* 13.0-14.8 mm), whereas even the largest sticklebacks could not ingest those in length category VII (*I. balthica* 8.0-8.9 mm, *G. oceanicus* 15.0-16.8 mm). With ascending ratios of prey width to mouth width the handling time for *G. oceanicus* increased more rapidly as compared to *I. balthica* (Fig. 6). The maximum handling time for large *G. oceanicus* was up to twenty-fold higher than for *I. balthica* of equal size. The maximum amount of time *S. spinachia* spent overcoming *I. balthica* was 38 seconds and 720 seconds for *G. oceanicus*. These handling times were significantly different from each other (U-test, $Z=-2.71$, $p=0.007$). *Idotea balthica* ≥ 8.0 mm and *G. oceanicus* ≥ 15.0 mm in length, respectively, were rejected by even the largest sticklebacks (164 mm TL) in the laboratory trials.

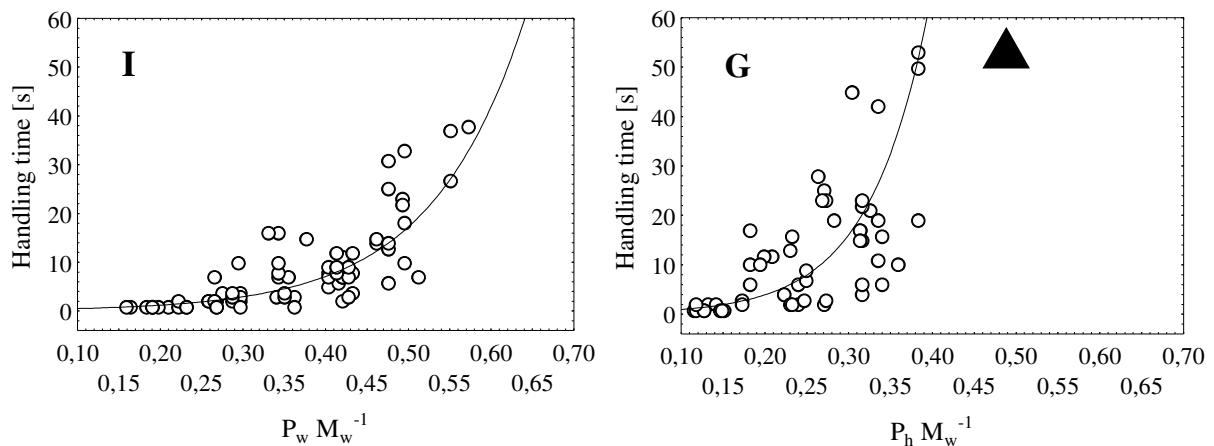

Fig. 6. Relationship between handling time (HT) of *S. spinachia* and the ratio of prey width (P_w) of *I. balthica* (I, $n=83$, $HT_I=0.2052 e^{8.8613x}$) as well as prey height (P_h) of *G. oceanicus* (G, $n=86$, $HT_G=0.2346 e^{14.0856x}$) and mouth width (M_w) of the fish. Arrowhead indicates five data points >90 s and <750 s. Exponential fits are included in the graphs

Preference

In the eelgrass meadows *S. spinachia* positively selected *I. balthica* and *M. gryllotalpa*. *J. albifrons*, *Gammarus* spp. and *Corophium* spp. were ingested approximately according to their relative abundance, whereas gastropods and *E. difformis* were selected negatively (Tab. 9).

Table 9. Chesson's index of electivity (α) and proportions of important mesograzers in the diet of *S. spinachia* and in the eelgrass meadow. Values of 0.14 indicate no preference, values <0.14 indicate avoidance and >0.14 preference

Taxon	Fish	Eelgrass	α
<u>Isopoda</u>			
<i>I. balthica</i>	0.87	0.16	0.31
<i>J. albifrons</i>	0.0009	0.0006	0.10
<u>Amphipoda</u>			
<i>Gammarus</i> spp.	0.037	0.023	0.10
<i>M. gryllotalpa</i>	0.023	0.004	0.32
<i>E. difformis</i>	0.016	0.012	0.08
<i>Corophium</i> spp.	0.029	0.017	0.10
<u>Gastropoda</u>	0.018	0.775	0.001

In each of the eight three-way combinations tested in the laboratory *S. spinachia* consistently favoured *N. integer* when compared with *I. balthica* irrespective of prey size combination. *Idotea balthica*, however, was not significantly preferred in any of the multiple-choice experiments. The comparison of *N. integer* and *G. salinus* displayed inconsistency with three cases lacking differences and five cases with significant preferences for *N. integer*. Altogether, *S. spinachia* exhibited marked preferences for *N. integer*. The comparison between *G. salinus* and *I. balthica* also showed contradictory results. Only three of five comparisons revealed significant differences, indicating positive selection for *G. salinus* compared with *I. balthica*. In three of four cases *G. salinus* was favoured when presented simultaneously with large *I. balthica* (Tab. 10). Finally the results indicated preference in the order *N. integer* > *G. salinus* > *I. balthica*.

Table 10. Multiple comparisons of food choice data (n=12 for each combination) analysed employing resampling approach using five replicate runs of 10 000 simulations (Monte Carlo analysis). *N. integer*=MYS (large) and mys (small), *G. salinus*=GAM (large) and gam (small), *I. balthica*=IDO (large) and ido (small)

Combination	Comparison	p	Preference
MYS-GAM-IDO	MYS-GAM	0.11	
	MYS-IDO	<0.001	MYS
	GAM-IDO	<0.001	GAM
mys-gam-IDO	Mys-gam	0.20	
	mys-IDO	0.002	mys
	gam-IDO	0.27	
mys-GAM-IDO	mys-GAM	0.24	
	mys-IDO	<0.001	mys
	GAM-IDO	<0.001	GAM
MYS-gam-IDO	MYS-gam	0.03	MYS
	MYS-IDO	<0.001	MYS
	gam-IDO	0.02	gam
MYS-GAM-ido	MYS-GAM	0.01	MYS
	MYS-ido	0.006	MYS
	GAM-ido	0.56	
mys-GAM-ido	mys-GAM	0.07	mys
	mys-ido	0.046	mys
	GAM-ido	0.31	
mys-gam-ido	mys-gam	0.02	mys
	mys-ido	0.003	mys
	gam-ido	0.27	
MYS-gam-ido	MYS-gam	0.004	MYS
	MYS-ido	<0.001	MYS
	gam-ido	0.10	

The above-mentioned data indicated that food preferences of *S. spinachia* found in the field differed considerably from those revealed in the laboratory food choice experiments.

Size dependent predation

The ratios between total fish length and maximum prey length ingested were significantly larger for *Gammarus* spp. (n=6, T=0.0, Z=2.2013, p=0.028) and *I. balthica* (n=7, T=0.0, Z=2.3664, p=0.018) in the laboratory feeding trials compared to values calculated for prey consumed in the natural environment (Tab. 8). The data indicated that in relation to fish length maximum prey size consumed by fish in the field was significantly larger than for fish fed in the laboratory trials.

Table 8. Differences in maximum prey size ingested by *S. spinachia* in the eelgrass bed and under laboratory conditions. Values are means (\pm SD) from the ratios of fish length (TL, mm) and maximum prey length (mm) of *Gammarus* spp. and *I. balthica*

	<i>Gammarus</i> spp.		<i>I. balthica</i>	
Eelgrass bed	10.5 \pm 1.1	n= 6	10.4 \pm 2.2	n=11
Laboratory	15.0 \pm 1.5	n=12	16.2 \pm 1.0	n= 7

The size-frequency distribution of amphipods and isopods in the fish diet and in the natural environment indicated size dependent predation of *S. spinachia*. The sticklebacks appeared to prey at medium sized *I. balthica* between 4.5 and 6.5 mm length and larger size classes of non-gammaridean amphipods up to 5.5 mm length than size classes found in the eelgrass meadow. Among the gammaridean amphipods *S. spinachia* consumed smaller individuals between 0.5 and 2.5 mm body length. Gammarids between 2.5 and 3.5 mm dominated within the eelgrass meadow but individuals exceeding 12 mm length were also found (Fig. 7).

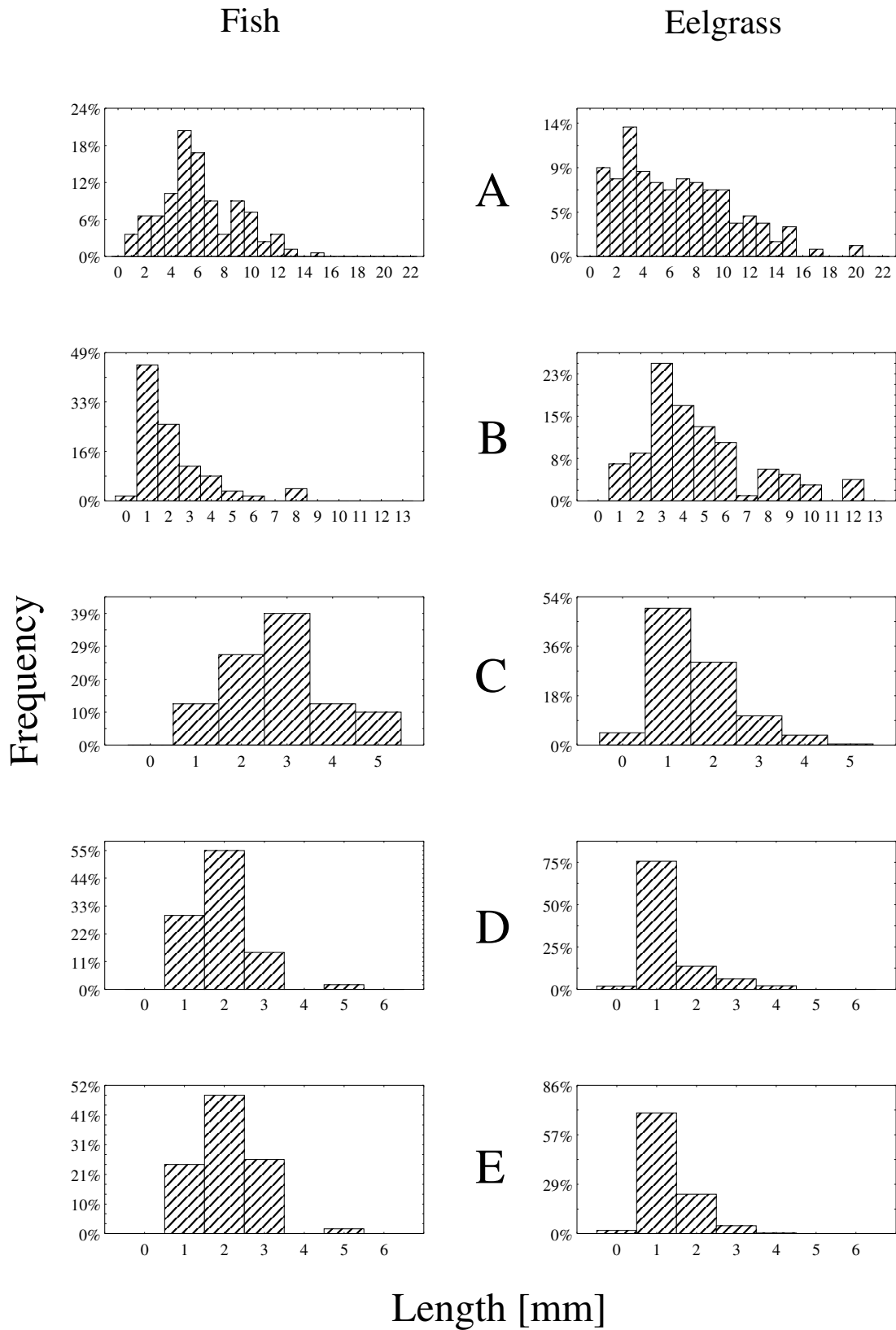

Fig. 7. Size frequency distribution of *I. balthica* (A), *Gammarus* spp (B), *M. gryllotalpa* (C), *E. difformis* (D) and *Corophium* spp. (E) in the diet of *S. spinachia* and in the eelgrass meadow

Feeding efficiency

Prey density (Exp I and II)

Increasing prey densities significantly affected ingestion rates of *S. spinachia* (Kruskal-Wallis test, $H_{(2,N=18)}=11.936$, $p=0.0026$) preying on *G. oceanicus* (Fig. 8).

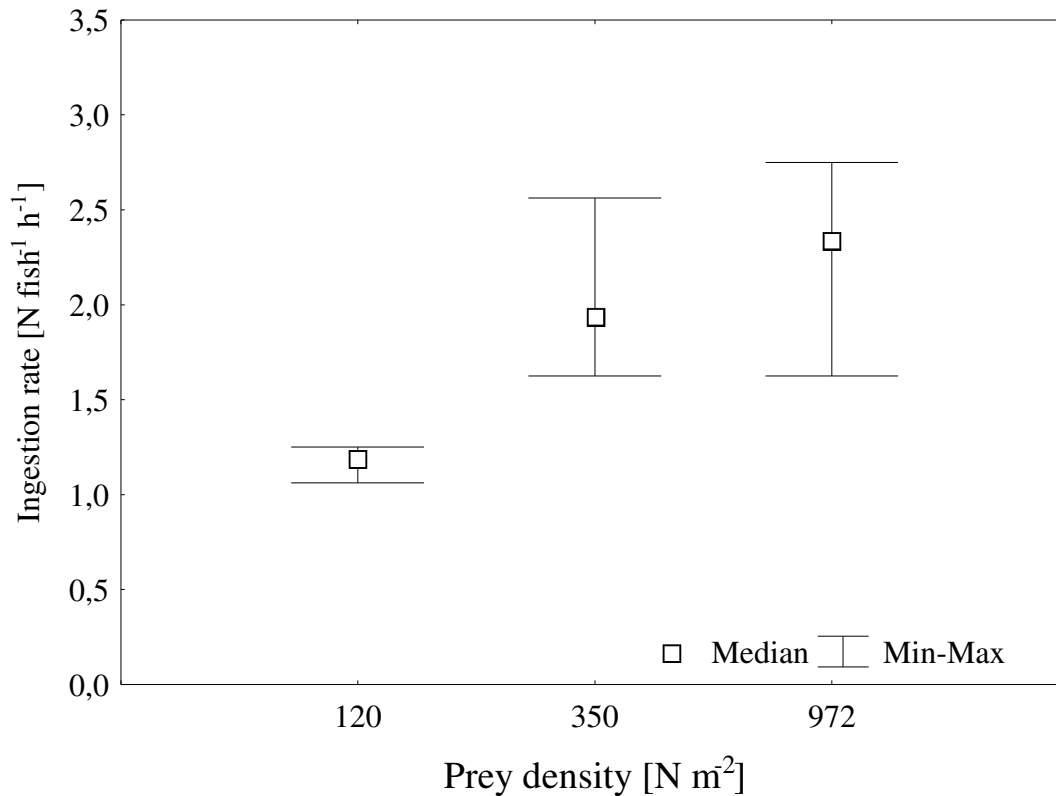

Fig. 8. Relationship between prey density of *G. oceanicus* and ingestion rates of *S. spinachia*. Number of replicated treatments $n=6$. Prey density indicates mean values of initial and final densities of the prey items

The ingestion rates increased with increasing prey density and correlated positively with prey density (Spearman rank correlation, $r_s=0.796$, $t_{(N-2)}=5.289$, $p<0.0001$, $n=18$). In general, the feeding rates of *S. spinachia* preying on *I. balthica* were significantly lower compared with feeding rates of sticklebacks foraging on *G. oceanicus* (Wilcoxon-Mann-Whitney-test, $n=18$, $Z=3.723$, $p=0.0002$).

Ingestion rates of *S. spinachia* feeding on *I. balthica* differed significantly at varying prey densities (Kruskal-Wallis test, $H_{(2,N=18)}=9.656$, $p=0.008$), but results showed no correlation ($r_s=-0.129$, $t_{(N-2)}=-0.504$, $p=0.62$) between prey density and ingestion rates (Fig. 9).

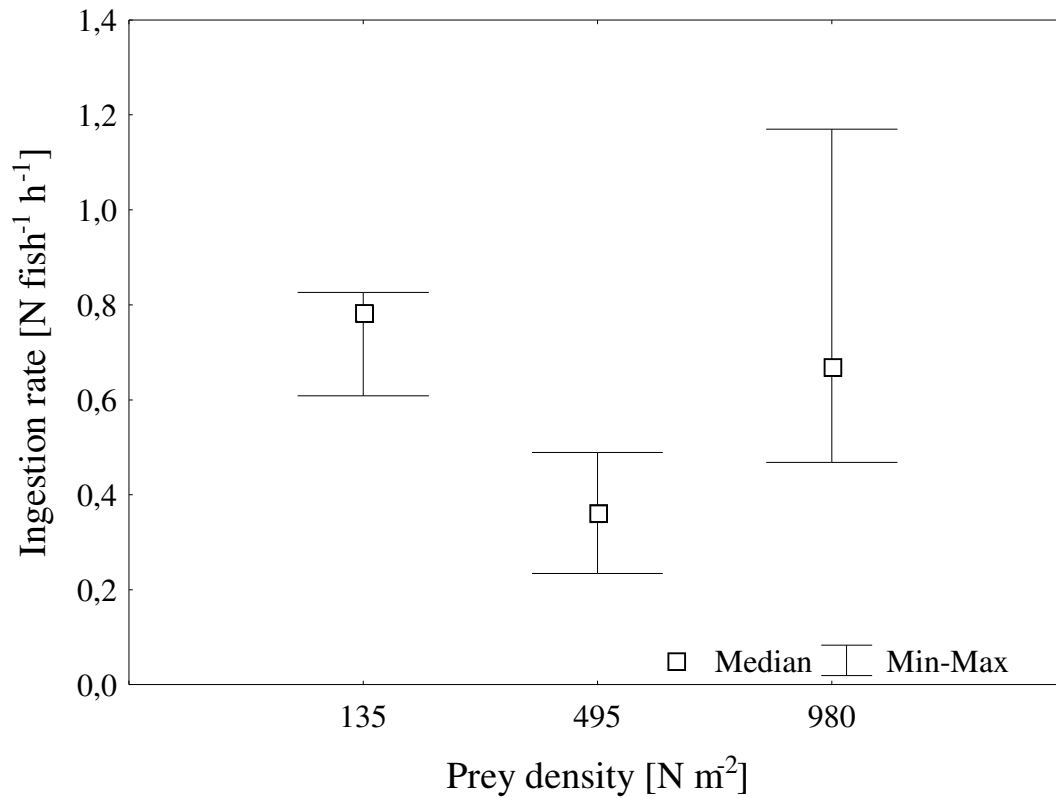

Fig. 9. Relationship between prey density of *I. balthica* and ingestion rates of *S. spinachia*. Number of replicated treatments $n=6$. Prey density indicates mean values of initial and final densities of the prey items

The ingestion rates did not increase with increasing prey density. Significant differences resulted from relatively low consumption at intermediate prey densities.

Shoot density (Exp III and IV)

The foraging efficiency of fifteen-spined sticklebacks feeding on amphipods was not significantly affected (Kruskal-Wallis test, $H_{(2,N=18)}=4.795$, $p=0.09$) by increasing *Zostera* shoot density (Fig. 10).

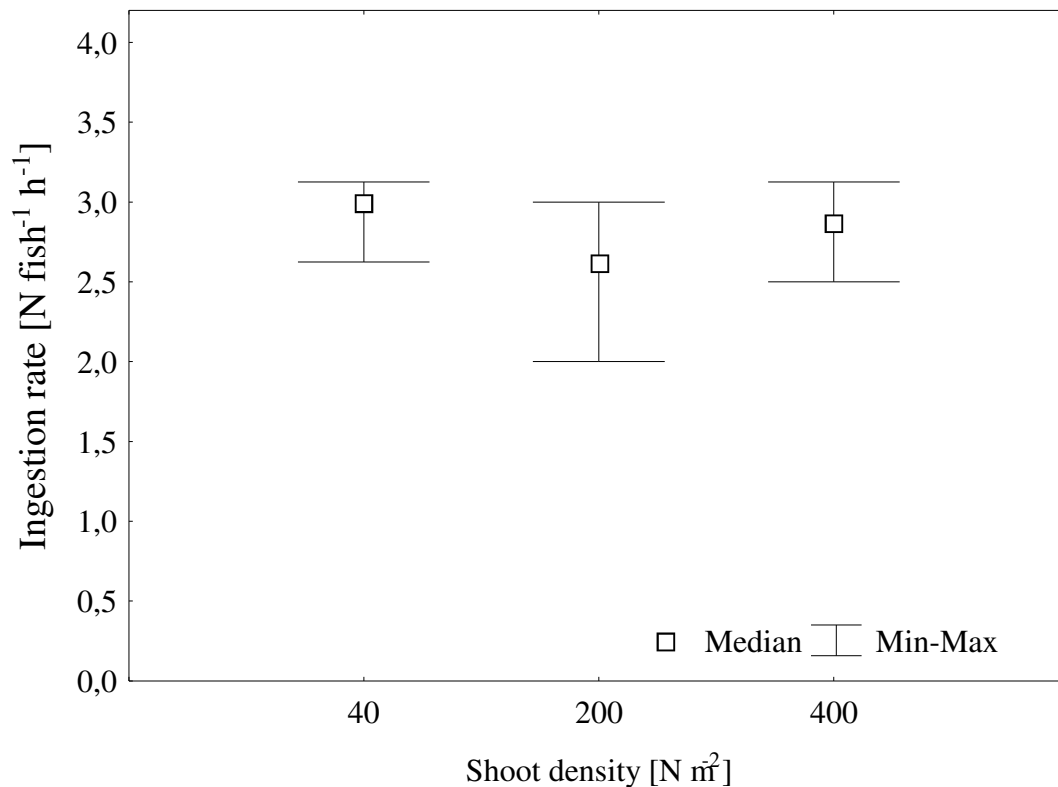

Fig. 10. Relationship between shoot density of *Zostera marina* and ingestion of *G. oceanicus* by *S. spinachia*. Number of replicated treatments $n=6$

Significant effects of *Zostera* shoot density on feeding success were observed (Kruskal-Wallis test, $H_{(2,N=18)}=11.525$, $p=0.003$) when *S. spinachia* fed on *I. balthica*. No differences between low and high shoot densities were detected, but the presence of *I. balthica* in the absence of vegetation did significantly reduce ingestion rates in comparison to treatments with low and high shoot densities (Fig. 11).

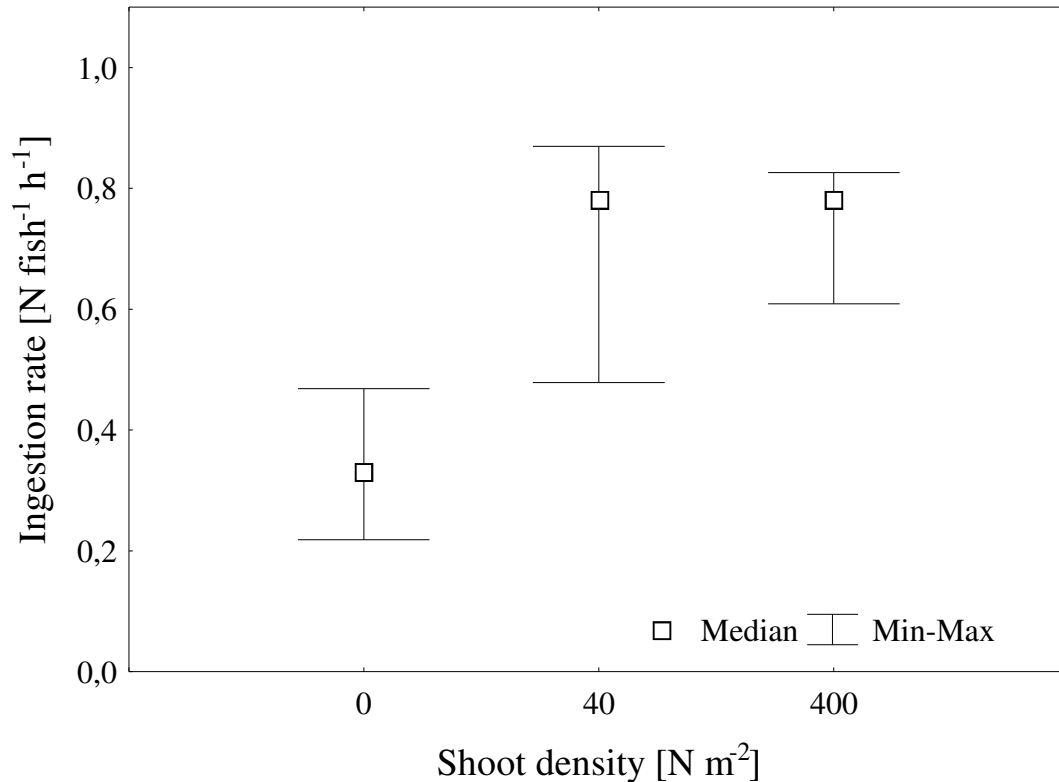

Fig. 11. Ingestion of *I. balthica* by *S. spinachia* at different shoot densities of *Z. marina*. Number of replicated treatments n=6

The proportions of exuvia to initial crustacean number ranged from 0 to 6%. Mean biases (\pm SD) due to cannibalism and detection errors are $3.2\pm 4.1\%$.

Discussion

Fifteen-spined sticklebacks represent a common and prominent component of the fish community in Falkenstein eelgrass meadow. Our study indicates that adult *S. spinachia* evolved as important predators of crustacean mesograzers such as *I. balthica* and amphipods. When compared to older data, the results of our study reflect the drastic changes in the fish community structure of shallow water ecosystems in the Baltic Sea (Winkler 1991) and call attention to the increasing ecological relevance of small fish predators in coastal eelgrass ecosystems.

Studying the fish fauna of shallow water habitats in Kiel Bight by means of beam trawl, other investigators found maximum abundances of fifteen-spined sticklebacks 6 to 25 times lower compared with the results of this examination (Niemann 1990, Thetmeyer 1998). Two reasons may be responsible for this: (a) fishing *S. spinachia* with beam trawl is less efficient than with enclosure trap (Bobsien and Brendelberger 2006), and (b) the proportion of *S. spinachia* on total fish biomass has increased heavily during the last 30

years. Worthmann (1975) calculated a summer maximum proportion of 1.3%, Niemann (1990) 21% and this investigation 36%. The relative increase of fifteen-spined sticklebacks is associated with a drastic decline of larger predatory fishes such as cod (*Gadus morhua*), perch (*Perca fluviatilis*) and plaice (*Pleuronectes platessa*). Worthmann (1975) detected *G. morhua* still as the second most numerous fish species, Niemann (1990) ranked the cod twentieth, Thetmeyer (1998) tenth (of eleven, a total of two cod specimens) and no evidence was made in this study. The stocks of cod and other commercially important species in the Baltic Sea have declined mainly because of poor recruitment and high fishing pressure during the last decades (Jonzén et al. 2002), which may have enhanced stocks of small fishes due to decreasing feeding competition and predation pressure.

Diet

Spinachia spinachia is a major predator of amphipod and isopod mesograzers in the eelgrass meadows investigated. In contrast to other investigations (Kislalioglu and Gibson 1976a, Kaiser et al. 1992), this study showed that *I. balthica* represented a key component in the diet of adult *S. spinachia* living in eelgrass beds. The diets of *S. spinachia* displayed distinct ontogenetic and seasonal variations. *I. balthica* was rarely found in fish <90 mm TL, whereas amphipods could be detected in juveniles as well as in adult fish. The proportions of *I. balthica* in the diet increased heavily during the summer months in both years of our investigation. Simultaneously the proportions of amphipods in the diet decreased. In the eelgrass meadow the abundances of *I. balthica* and amphipods, however, increased during the summer month of both years of investigation. The decrease of amphipods in the diet is directly opposed to changes in the environment and thus exclusively related to ontogenetic changes in feeding behaviour of *S. spinachia*.

Changes in predator avoidance behaviour of the prey may also lead to changes in prey availability. In contrast to *I. balthica* large amphipods were observed showing distinct escape responses and taking refuge quickly due to disturbances. Hacker and Stenek (1990) suggested that the body size of amphipods might influence their choice of habitat and shelter from predation. Anti-predator mechanisms may explain these differences. *Gammarus lacustris*, for example, reduced its time in the water column and spent more time near the bottom of the test aquarium in the presence of chemical stimuli from northern pike (*Esox lucius*) (Wudkevich et al. 1997).

Food selection

Chesson's measure of preference reflects any deviation from random sampling of the prey, including all biological factors that affect encounter rates and feeding rates. In general, food selection of fish is governed by numerous factors such as prey type (Kaiser et al. 1992), hunger (Kislalioglu and Gibson 1976b), prey size, experience, learning and memory (Croy and Hughes 1991a, b, c). The size difference of *I. balthica* and amphipods consumed by *S. spinachia* in the natural environment and the length frequency distribution of crustacean grazers in the fish diet and in the eelgrass meadow indicated size dependent prey selection (Gill and Hart 1994, Gill and Hart 1999). Differences in predator avoidance behaviour and predator defence mechanisms may also affect size selection of *S. spinachia*. Kaiser et al. (1992), for example, observed that large gammarids, when adopting a C-shape, were less likely to be eaten by *S. spinachia*. The sticklebacks used in the experiments ranged between 88 and 110 mm TL. Unfortunately, we obtained no larger individuals in the run-up to the experiments. This was possibly responsible for the pronounced preference for *N. integer* and *G. salinus* in comparison with *I. balthica*. As demonstrated in this study *S. spinachia* exhibit explicit ontogenetic changes in their diet including decreasing proportions of copepods and increasing proportion of *I. balthica* when fish size exceeds 85 mm TL.

Size relationships and handling time

Sizes of predator and prey investigated in the field and experimental results on handling time revealed strong dependence between prey size and fish size. *Spinachia spinachia* spent significantly more time capturing amphipods than isopods in the laboratory experiments. With ascending ratios of prey width to mouth width the handling time for *G. oceanicus* increased more rapidly as compared to *I. balthica*. Movements and the presence of appendages can be important stimuli to orientate the fish's attention towards potential prey (Croy and Hughes 1991a, Kaiser et al. 1992). The antennae and segmental appendages of gammarids might enhance feeding motivation of sticklebacks. The prominent appendages of amphipods however can make swallowing difficult. Croy and Hughes (1991d) observed fifteen-spined sticklebacks feeding on *Gammarus* performing complex foraging sequences including "Hold" and "Chew". Chewing and biting, also observed during this study, enabled the predator to break off segmental appendages of gammarids and therefore swallow the prey more easily and enhance stomach packing.

These complex foraging sequences may explain the pronounced differences in handling time.

Maximum prey size

For *S. spinachia*, a predator, which swallows its prey as a whole, a maximum prey size limits the ingestion of prey exceeding a certain threshold size in relation to predator size. Potential prey exceeding this upper size limit was assumed to be safe from predation even by the larger size-classes of *S. spinachia* (Olsen 1996). We have shown that *I. balthica* exceeding 15 mm and *Gammarus* spp. exceeding 8 mm in body length achieved a predator (*S. spinachia*)-invulnerable size refuge. Numerically, only 2% of the isopods and about 12% of the gammaridean amphipods thus became less vulnerable to stickleback predation. But as this size class of amphipods and isopods consists of fertile adults, their survival is of paramount importance for the persistence of these species in eelgrass habitats. The non-gammaridean amphipods do not reach an invulnerable adult stage concerning stickleback predation. The effects of *S. spinachia* on abundance and composition of epiphyte grazer communities therefore strongly depends on size distribution and the proportions of larger predator-invulnerable individuals within the grazer population.

Stomach fullness

Large *I. balthica* were often found in combination with relatively small amphipods (Fig.2) filling the stomachs of *S. spinachia*. Gill and Hart (1998) argued that large prey will contribute greatly to stomach fullness over a relatively short period, but satiation is not actually complete, as space exists in the stomach, which can be filled by smaller prey. Sticklebacks may capture large isopods and small amphipods together to reach satiation. In the stomachs large *I. balthica* were folded up with the ventral surfaces against each other and the dorsal surface facing to the stomach wall. This position may lead to efficient stomach packing (Hart and Gill 1992) and prevent injuries of mucosa caused by the acuminate claws of *I. balthica*.

General feeding behaviour

Species-specific behavioural characteristics of predator and prey may explain the general differences in feeding behaviour of *S. spinachia*. There are examples of thanatosis in the response of attacks of predatory fish (Moore and Williams 1990) and altered predator behaviour, such as a shift of foraging tactics, depending on prey abundance and vegetation density (Heck and Crowder 1991). In general foraging behaviour may deviate from those

predicted as optimal because of the influence of predators or competitors, or because resources other than energy are important (Hughes 1980).

Prey density

The ingestion rates of *S. spinachia* were positively related, but not proportional to prey density. Holling (1966) discussed the role of handling time and concluded that the rate of food consumption must eventually reach an asymptote because predators have to spend some time handling each food particle. The functional response of *S. spinachia* feeding in eelgrass (Fig. 3) is in agreement with this model.

Shoot density

Nelson (1979) and Heck and Thoman (1981) investigated the relationship between vegetation density and predation success and showed that the feeding efficiency of pinfish (*Lagodon rhomboides*) and killifish (*Fundulus heteroclitus*) preying on amphipods (*Melita appendiculata*) and grass shrimps (*Palaemonetes pugio*) respectively, was negatively related to the density of eelgrass. In both studies, however, predators that actively pursue their prey were used. In this study we tested an ambush predator, the fifteen-spined stickleback, for its feeding efficiency in habitats of different shoot densities.

The intensity of *S. spinachia* predation does not seem to be regulated by different densities of submerged vegetation. In the present study shoot densities of up to 400 shoots m⁻² did not significantly alter the predation success of *S. spinachia* feeding on *G. oceanicus* (Fig. 10). Sticklebacks feeding on *I. balthica* showed similar results (Fig. 11). Heck and Thoman (1981) and Nelson (1979) found the feeding success of killifish (*Fundulus heteroclitus*) and pinfish (*Lagodon rhomboides*) to be negatively related to eelgrass shoot densities. Nelson (1979), who investigated pinfish predation on amphipods, proposed a step function that might best describe the relationship between predation intensity and plant density. Heck and Thoman's (1981) results were consistent with Nelson's (1979) hypothesis. They found that only high densities (647 shoots m⁻²) of artificial eelgrass significantly hindered the success of killifish feeding on grass shrimp in the laboratory, in contrast to bare sand. Neither intermediate nor low densities of vegetation significantly reduced the effectiveness of killifish predation. In the present study ambush predators such as the fifteen-spined stickleback preyed successfully in dense vegetation. Habitat structure, however, appears to be of particular importance to *S. spinachia*. In contrast to the observations of Heck and Thoman (1981) and Nelson (1979), the predation success of *S. spinachia* in *I. balthica*

treatments without vegetation was significantly lower than with eelgrass treatments in the present investigation. The behaviour of predator and prey might explain these findings. Vegetation is crucial for *I. balthica*, both as a food source and location of protection from predation (Orav-Kotta and Kotta 2004). In the absence of vegetation *I. balthica* swam freely and was thereby potentially confounding the predator. In this case, the prey movements did not act in attracting predators (Croy and Hughes 1991a) but rather to confound them. *Idotea balthica* appeared not particularly influenced due to the presence of potential fish predators. In contrast to the case of the subtropical isopod *Erichsonella attenuata*, the presence of predatory fish did not alter the preference of *I. balthica* for epiphytic food sources over shelter (Boström and Mattila 1999). The present study suggests that decreasing eelgrass shoot density does not enhance the foraging efficiency of the fifteen-spined stickleback feeding on benthic crustaceans. However, the absence of eelgrass plant cover has a considerable impact on the observed predator-prey relationship (*S. spinachia* – *I. balthica*). Finally, this study stresses the importance of eelgrass beds in offering secure ambush places for predators, which forage under cover of vegetation, and provides a better understanding of predator and prey relationships between fifteen-spined sticklebacks foraging upon crustacean mesograzers in temperate eelgrass habitats.

Acknowledgements

This research was funded by the environmental foundation Deutsche Bundesstiftung Umwelt (DBU). We would like to thank the scientific assistants of our department for their help in collecting samples in the field and Claudia Scheller for performing multiple-choice feeding trials. Sandra Gohse-Reimann provided the seasonal invertebrate macrozoobenthos data.

**Behavioural responses of *Gammarus salinus* and
Spinachia spinachia to vertical oxygen gradients
in eelgrass habitats**

Abstract

Shallow coastal water ecosystems including seagrass beds are increasingly threatened by bottom hypoxia due to eutrophication. These hypoxia profoundly influence the benthic community including the habitat choice of species and their trophic interactions. We tested physiological tolerances, behavioural responses and predator-prey interactions between fifteen-spined sticklebacks *Spinachia spinachia* and the amphipod *Gammarus salinus* in vertical oxygen gradients under laboratory conditions. Different grades of bottom oxygen gradients overlaid by a well-aerated top water layer were established in simulated eelgrass habitats in order to analyse the microhabitat preference and its impact on the predator-prey relationship.

Severe oxygen gradients (3-10% and 10-40% saturation) in the eelgrass habitat expelled *S. spinachia* and *G. salinus* from their favoured locations (preferendum) but *G. salinus* responded less sensitively than *S. spinachia*. The oxygen deficiency layers did not act as a predation refuge for *G. salinus*. At severe to medium oxygen gradients (10-40%, 20-50% and 30-60% saturation) *S. spinachia* was capable of diving temporarily into the sections of lower oxygen concentrations to search for and successfully capture food. The prey masses ingested by *S. spinachia* in severe oxygen gradients were not significantly different from those observed in the normoxic controls. The swimming activity of *S. spinachia* reached its maximum at medium oxygen gradients compared to severe gradients and well-oxygenated controls. This indicates behavioural modifications for coping with oxygen deficiency in the habitat. At weaker oxygen gradients (40-70% saturation) within the eelgrass cover no differences in habitation and swimming activity of *S. spinachia* were found compared to normoxic controls. The results suggested that *S. spinachia* adapts its behaviour to the intensity of oxygen depletion in the habitat. This has little effect on the amount of prey ingested, but increases the time exposed to potential predators outside the eelgrass cover.

Introduction

Increasing eutrophication of shallow coastal waters often causes enhanced growth of filamentous macroalgae. These macroalgae, colonizing the sediment and the eelgrass leaves, can also be found as benthic mats of drifting algae on the sediment surface (Vahteri et al. 2000, Hauxwell et al. 2003). This phenomenon occurred regularly in shallow bays and eelgrass beds of the Baltic Sea (Rosenberg and Loo 1988, Boström and Bonsdorf 2000) in the past. Due to the die back and the microbial decay of such ephemeral algae, the oxygen concentration within the mats and in the overlying water column fluctuate

significantly (Krause-Jensen et al. 1996, 1999, Hauxwell et al. 2001). The effects of hypoxia in the bottom water layer can lead to shifts in the vertical distribution of benthic macroinvertebrates depending on the behavioural responses of the affected species, and may thus also influence predator-prey relationships (Baden et al. 1990). Many aquatic invertebrates are tolerant to low oxygen concentrations and use waters that are low in oxygen as a refuge from fish predation (Taleb et al. 1992, Rahel and Nutzman 1994). A major effect of low oxygen in eelgrass beds to fishes is the loss of the habitat that would otherwise be used for feeding, reproduction and shelter from predators. The extent of the habitat loss will depend on the severity of oxygen depletion, and on the physiological tolerances and behaviours of the affected fish species (Breitburg 2002).

This study examined the behavioural response and the physiological tolerance of the sea stickleback, *S. spinachia*, and the amphipod, *G. salinus* exposed to vertical oxygen gradients in the laboratory. The following hypotheses were tested:

- (1) Does the predator react more sensitively to benthic oxygen deficiencies than the prey?
- (2) Are predator-prey relationships disturbed?
- (3) Does an oxygen deficiency layer act as a predation refuge for the prey?

For this purpose, the oxygen concentrations were quantified for predator and prey where 50% of the animals moved out of their favoured location in an eelgrass habitat. Further, the swimming activities of the fish, the number of dives into oxygen depleted water layers, the maximum times spent in oxygen depleted water, and the quantities of ingested prey in different oxygen gradient conditions were compared to normoxic controls (references) in order to predict the effects of low bottom oxygen on predator-prey relationships in eelgrass meadows.

Material and Methods

Experiments were carried out using transparent flow-through cylinders (see below) to observe the behavioural responses of *S. spinachia* (predator) and *G. salinus* (prey) to declining oxygen concentrations. Oxygen gradients were established to simulate the die back of drifting algal mats in eelgrass beds where oxygen deficiency develops near the bottom and moves progressively upwards in the water column. The upper water layers of the experimental tubes were kept well oxygenated so that fish and amphipods could escape oxygen deficiency by leaving the eelgrass cover.

Experimental tubes

All experiments were run in a temperature controlled room at $10\pm 1^\circ\text{C}$ in transparent plexiglass tubes (Fig.1) filled with brackish (Baltic Sea) water. The bottom of each plexiglass tube was covered with a 5 cm layer of sand. 20 *Zostera marina* shoots (300 shoots m^{-2}) of approximately 50 cm length were planted into the sediment with short fragments of their rhizomes. Shoot density and shoot length were chosen in accordance with natural conditions occurring in eelgrass habitats of Kiel Bay. The plexiglass tubes were divided into 4 sections:

(A) Sediment and shoots with leaf sheaths (bottom section), (B) high blade density without leaf sheaths, (C) lower blade density without leaf sheaths and (D) the free water column (top section) (Fig.1).

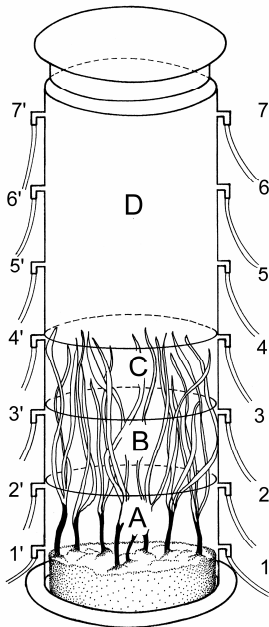

Fig. 1. Plexiglass tube (100 x 30 cm, height x width) with top cover and seven water in- and outlets on both sides. The in- (1-7) and outlets (1'-7') were numbered serially from the bottom to the top. The tubes were divided in four sections. Sections A-C simulated the eelgrass habitat with sandy sediment and natural *Zostera marina* plants. Section D represents the free water column

The tubes were centrally illuminated by fluorescent light from above and black plastic film was fixed around the outside to minimise reflections on the inner walls. Seven water in- and outlets were screwed in on opposed sides of the tubes at regular intervals of 15 cm (1-7, 1'-7' in Fig. 1). A peristaltic tubing pump (ISMATEC, VC-MS/CA8-6) was used to pump in deoxygenated water above the sediment and simultaneously drain off the same volume of water through higher placed outlets. The oxygen concentrations in the water being pumped in and that being drained off were monitored continuously with an oxygen meter (WTW, OxiControl 219) and oxygen probe (Trioxmatic 201). The maximum

delivery rate of the pump was 0.15 L min^{-1} . Salinity gradients were generated in order to produce stable stratifications in the plexiglass column. Preliminary investigations had shown stable vertical salinity gradients with limited change between the bottom and top water layers over a period of one to several hours, when the salinity difference between the water being pumped in and that being drained off was 1.0 psu. The vertical oxygen gradients established in the tubes were thus coupled with salinity gradients. The salinities in the experimental tubes were adjusted to 16.0 psu and to 17.0 psu in the introduced, deoxygenated water. Controls were run without oxygen gradients but with 1 psu salinity difference between bottom and top water layer. The preparation of the oxygen gradients took 2 to 3 hours. The oxygen was eliminated from the water by nitrogen displacement technique (Bennet and Beitinger 1995). The deoxygenated water was stored air free in collapsible water containers sealed with a rubber stopper. A flexible 4 mm drain hose passing through the stopper and into the water in the container facilitated pumping the deoxygenated water into the experimental tube without atmospheric contact. The deoxygenated water was pumped in above the sediment (in- and outlet 1, section A) and drained off above the *Z. marina* canopy (in- and outlet 4, section C). In this way the oxygen concentration in the eelgrass habitat was gradually reduced. At the end of each experiment the vertical oxygen profile was measured in order to document the established oxygen gradient in the tubes.

Oxygen gradients

Five levels of oxygen gradients, ranging from 3-10%, 10-40%, 20-50%, 30-60% and 40-70% O_2 -saturation (corresponding to 0.2-0.7, 0.7-2.8, 1.4-3.5, 2.1-4.2 and 2.8-4.9 $\text{mg O}_2 \text{ L}^{-1}$ at 10°C), expanding from section A to section C and normoxic conditions (70-98% saturation, corresponding to 4.9-6.8 $\text{mg O}_2 \text{ L}^{-1}$ at 10°C) in section D were established in the treatments. To create the 3-10% oxygen gradient, water of 3% oxygen saturation was pumped in continuously at inlet 1 until the water drained off at outlet 4' reached 10% oxygen saturation. At that moment the peristaltic pump was stopped and the experiments begun. Eight replicates were run for each level, giving a total of 40 trials (5 levels x 8 replicates). One reference was run simultaneously with two trials, amounting to 20 controls per 40 trials. Predator and prey were tested alone and in combination with each other (Tab. 1).

Tab. 1. Number of treatments and references performed to investigate *G. salinus* alone (Gs), *S. spinachia* alone (Ss) and the combination of predator and prey (Ss + Gs)

Combination	Oxygen treatments	Normoxic references
Gs	40	20
Ss	-	8
Gs + Ss	40	20

G. salinus without predator

G. salinus were caught with dip nets in shallow coastal regions of Kiel Bay and sorted by mechanical sieving to a size fraction of 7.2 ± 0.9 mm (mean \pm standard deviation) in length, measured at an aliquot of $n=40$. To examine the behavioural response and physiological tolerance of the amphipods (without predator) six *G. salinus* were released into each experimental tube and allowed to acclimate for 1 hour. Subsequently the vertical oxygen gradients were adjusted, as described above. The experiments started immediately after the desired oxygen gradients were reached: The locations of *G. salinus* within the tubes (sections A-D) were registered every 5 minutes over a 40 minute period. Each amphipod was used in one trial only. Normoxic conditions throughout the entire water column were arranged in the controls but, as in the treatments, the salinity difference between pumped-in and drained-off water was 1 psu.

Spinachia spinachia without prey

Spinachia spinachia were obtained by dredging and by means of beach seine in shallow eelgrass meadows of Kiel Bay. The mean standard length of *S. spinachia* was 87 ± 8 mm (mean \pm SD, $n=70$). Each fish was used in one trial only. The investigation of *S. spinachia* (without *G. salinus*) in five different oxygen gradients failed because most of the fish increased their swimming activity and moved permanently up and down in the plexiglass column, which made an analysis impossible. For this reason only eight references with *S. spinachia* (without *G. salinus*) under normoxic conditions were carried out (Tab. 1).

Predator and prey

Further experiments were conducted including both predator and prey. In these experiments the distribution and behaviour of *S. spinachia* (not *G. salinus*) were investigated. In the beginning 20 *G. salinus* were released into each experimental tube (equivalent to 300 amphipods m^{-2}) and allowed to settle for 1 hour. After this the oxygen concentration in tube sections A-C were gradually reduced, beginning with the 3-10% saturation gradient. Subsequently single individuals of *S. spinachia* adapted to the

experimental tubes for 24 hours and experienced with the prey were added to the tubes. All fish were starved for 24 hours prior to the experiments. Each fish was used in one trial only. The trials started after the first attack on the amphipods was observed which was always immediately upon the fish being released into the cylinders. The behavioural components registered included the swimming activity, the maximum time spent in section A, and the number of dives into section A. The location in sections A-D and the swimming activity, defined as vertical movements and expressed as the number of crossed sections, were checked minute-by-minute within 40 minute periods. The sections significantly preferred by the species in normoxic controls were termed preferendum in the following. The relationship between the oxygen concentration at outlet 4' (section C, Fig. 1) and the number of animals within the preferendum were used to calculate an average avoidance level by regression at which 50% of the animals escaped out of their preferendum. At the end of the trials 18 fish were dissected and the ingested prey quantity was determined gravimetrically. Four fishes were selected randomly from the 3-10%, 10-30% and 20-40% oxygen saturation treatments, respectively, and six fish from the reference trials (normoxic conditions).

Ethical note

We captured *S. spinachia* in eelgrass beds under a permit from the department of fisheries. The fish were kept in holding tanks equipped with stones and algae allowing the fish to hide and run for shelter. The tanks were supplied with running sea water obtained from a water treatment system. The habitation and starving in the plexiglass tubes was maximal 30 hours. We fed the fish with living amphipods and mysids. No fish died due to the reduced oxygen concentrations in the experimental treatments. The fish used for stomach analysis were anaesthetised (benzocaine) before dispatched. We kept *S. spinachia* to a maximum of 4 weeks in the laboratory and then released at the capture sites. The University of Kiel Animal Ethics Commission approved the holding and feeding experiments with *S. spinachia*.

Statistical analysis

To analyse the habitation (section A-D) for *G. salinus* and *S. spinachia* deviations from random distribution to observed distributions were compared using a resampling approach (Bärlocher 1998). Differences in distribution between treatments and controls were analysed by χ^2 -test, and Kruskal-Wallis tests were used to discriminate activity patterns in

different oxygen gradient treatments (Sokal and Rolf 1995). The comparisons in physiological tolerance of *G. salinus* and *S. spinachia* were made using regression analysis (Motulsky and Ransnas 1987) and t-tests were used to differentiate prey mass fed upon by *S. spinachia* under reduced oxygen levels compared to the normoxic controls (Sokal and Rolf 1995).

Results

Normoxic conditions

Under normoxic conditions and without a predator *G. salinus* favoured sections A and B over sections C and D (resampling approach, $p < 0.001$) within the experimental tubes. *Spinachia spinachia* preferred the sections A-C whereas section D was significantly avoided (resampling approach, $p < 0.001$) within the plexiglass tubes independent of food availability (X^2 -test, $X^2=5.47$, 3 df, $p=0.14$) (Tab. 2). The controls showed that the animals' behaviour was not influenced by the slight salinity gradient.

Table 2. Mean (\pm SD) habitation frequency [%] of *S. spinachia* (Ss) and *G. salinus* (Gs), alone and *S. spinachia* in the presence of *G. salinus* Ss (+Gs) under normoxic conditions (n=8)

Section	Gs	Ss	Ss (+Gs)
D	2 \pm 6	9 \pm 19	9 \pm 11
C	5 \pm 10	26 \pm 21	18 \pm 6
B	49 \pm 15	32 \pm 26	26 \pm 9
A	44 \pm 17	33 \pm 27	47 \pm 14

Oxygen gradients

The establishment of different oxygen gradient levels in the experimental tubes underlay some fluctuations. The percentage of standard deviation of the means of the oxygen saturation in the experiments ranged from 1.2 to 47.2%. In only two cases the standard deviation within the replicates for one level exceeded 40%. In the well-oxygenated references variation was $< 3\%$ (Tab. 3).

Table 3. Gradients in the oxygen treatments (n=8 per level) adjusted in sections A-D and the normoxic references (n=20). Values are means (\pm SD) of oxygen saturation [%] measured in the outlets (1'-7') at the end of each experiment

Section	Outlet	Oxygen gradient					Reference
		3-10%	10-40%	20-50%	30-60%	40-70%	
D	7'	89.4 \pm 4.4	91.6 \pm 3.0	91.3 \pm 7.2	90.0 \pm 3.3	92.7 \pm 1.9	91.7 \pm 2.2
	6'	88.5 \pm 5.1	91.5 \pm 3.2	90.4 \pm 8.4	89.4 \pm 3.5	92.8 \pm 1.0	91.4 \pm 2.0
	5'	85.5 \pm 7.1	90.3 \pm 4.7	90.5 \pm 8.5	88.5 \pm 4.8	92.7 \pm 1.1	91.1 \pm 2.1
C	4'	13.1 \pm 3.4	43.1 \pm 18.9	56.0 \pm 8.2	60.2 \pm 2.9	74.0 \pm 8.3	91.0 \pm 2.1
B	3'	6.1 \pm 1.6	13.7 \pm 3.0	35.8 \pm 16.9	34.0 \pm 2.8	44.0 \pm 5.6	90.8 \pm 2.4
A	2'	3.8 \pm 0.8	10.6 \pm 1.2	22.7 \pm 2.4	29.8 \pm 1.8	40.8 \pm 5.6	90.7 \pm 2.4
	1'	3.0 \pm 0.7	9.9 \pm 1.0	21.6 \pm 2.2	28.7 \pm 1.9	40.0 \pm 6.1	90.5 \pm 2.6

Behavioural response

The regression analysis indicated significant differences in the avoidance response of predator and prey to oxygen deficiencies in their preferendum (regression analysis, $F=26.79$, $F_{2,116} < 3.087$, $p < 0.01$). The predator *S. spinachia* reacted more sensitively compared to the amphipod *G. salinus*. 50% of the fish (trials with prey) had left their preferendum (section A-C) by moving up in the water column when oxygen concentration at outlet 4' was 2.2 mg L^{-1} (32% O_2 -saturation) ($y=10.715x+26.407$, $r^2 = 0.60$, $n=60$). In contrast, 50% of the amphipods (trials without predator) moved up into the free water column (section D) when oxygen concentration at outlet 4' was 1.8 mg L^{-1} (26% O_2 -saturation) ($y=11.92x+28.534$, $r^2 = 0.47$, $n=60$) (Fig. 2).

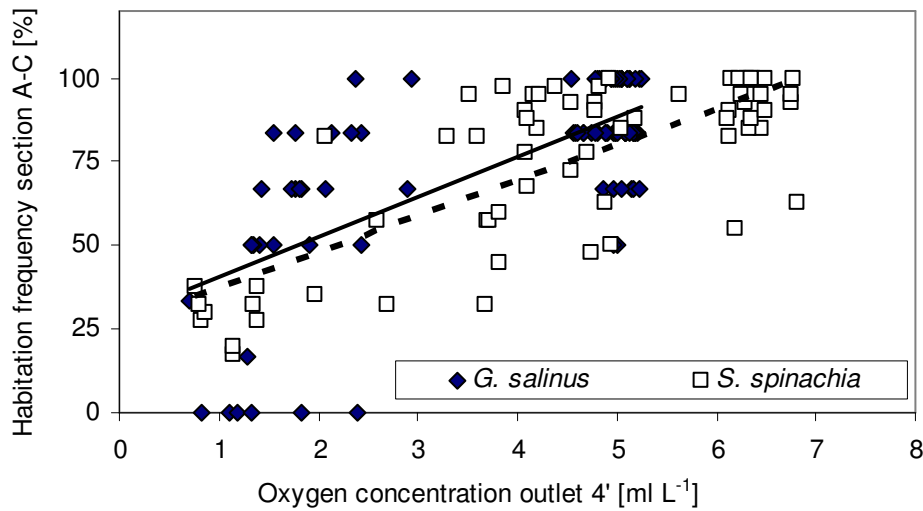

Fig. 2. Relationship between oxygen concentration in outlet 4' and the number of *S. spinachia* (n=60) and *G. salinus* (n=60) remaining in their preferendum (section A-C). Continuous and dotted line indicates linear regression. *G. salinus* — *S. spinachia* - - .

Oxygen gradients

All *S. spinachia* were able to detect and avoid unfavourable oxygen conditions. Immediately after the fish were added to the tubes (with prey) they moved slowly down in the water column. Seconds after the fish entered severe oxygen deficiency layers they increased their activity and moved promptly up in the column until they reached acceptable oxygen concentrations. The fish were not observed at rest in hypoxic water layers and no fish died during the experiments. *S. spinachia* seems rather to be able to cope with oxygen deficiencies in their habitat. The distribution of *S. spinachia* inside the experimental tubes changed significantly with different oxygen gradient levels compared to the normoxic controls (Tab. 4).

Table 4. Mean habitation frequency (\pm SD) of *S. spinachia* (with prey) within the four sections of the plexiglass tubes during the 40 minute oxygen gradient trials (n=8). X^2 and p-values of X^2 -test (3 df), where the observed frequency distributions are compared to the frequency distribution of the references

Section	Oxygen gradient						Reference
	3-10%	10-40%	20-50%	30-60%	40-70%		
D	28.5 \pm 2.9	21.5 \pm 7.0	11.4 \pm 6.2	4.0 \pm 3.4	2.6 \pm 2.3	3.7 \pm 4.5	
C	9.4 \pm 3.3	12.8 \pm 5.3	13.8 \pm 6.8	11.1 \pm 3.4	8.0 \pm 3.2	7.2 \pm 3.2	
B	1.6 \pm 1.8	4.1 \pm 2.2	7.8 \pm 3.6	12.1 \pm 1.9	10.5 \pm 1.2	10.3 \pm 3.3	
A	0.5 \pm 0.9	1.6 \pm 2.2	7.0 \pm 3.2	12.8 \pm 3.5	18.9 \pm 4.7	18.8 \pm 5.1	
X^2	506.0	285.1	75.9	11.1	0.67	0.0	
p	0.00	0.00	0.00	0.01	0.88	1.00	

The time *S. spinachia* spent in section A and the total number of dives into section A increased with increasing oxygen saturation. In severe oxygen gradients (3-10% oxygen saturation) 5 from 8 *S. spinachia* strictly avoided section A and only 3 of the 8 fish made short dips lasting 3-5 seconds into the hypoxic water layer of section A (Tab. 5). The maximum time spent in section A increased eightfold between the 20-50% and the 30-60% oxygen treatment, suggesting important limit values for avoidance reactions between 1.4 and 2.1 ml O₂ L⁻¹. The total number of dips into section A reached its maximum at 40-70% oxygen saturation and even exceeded the value of the reference.

Table 5. Maximum residence time spent in section A and total number (N) of observed dives into section A in the different oxygen gradient treatments, n = number of fishes per treatment,

	Oxygen gradient					Reference
	3-10%	10-40%	20-50%	30-60%	40-70%	
Max. time [s]	5	30	30	240	312	427
Number (N)	14	55	101	149	170	147
n	3	8	8	8	8	20

Vertical movements

The mean number of vertical movements reflected the swimming activity of *S. spinachia* at different oxygen gradients. The Kruskal-Wallis test detected significant differences in activity in the presence of different oxygen gradients ($H_{(5,N=58)}=27.75$, $p<0.001$). Minimum values occurred in the 3-10% treatment and increased in the medium oxygen gradient treatments. Within the controls the activity was again reduced compared to medium oxygen gradients (Fig. 3).

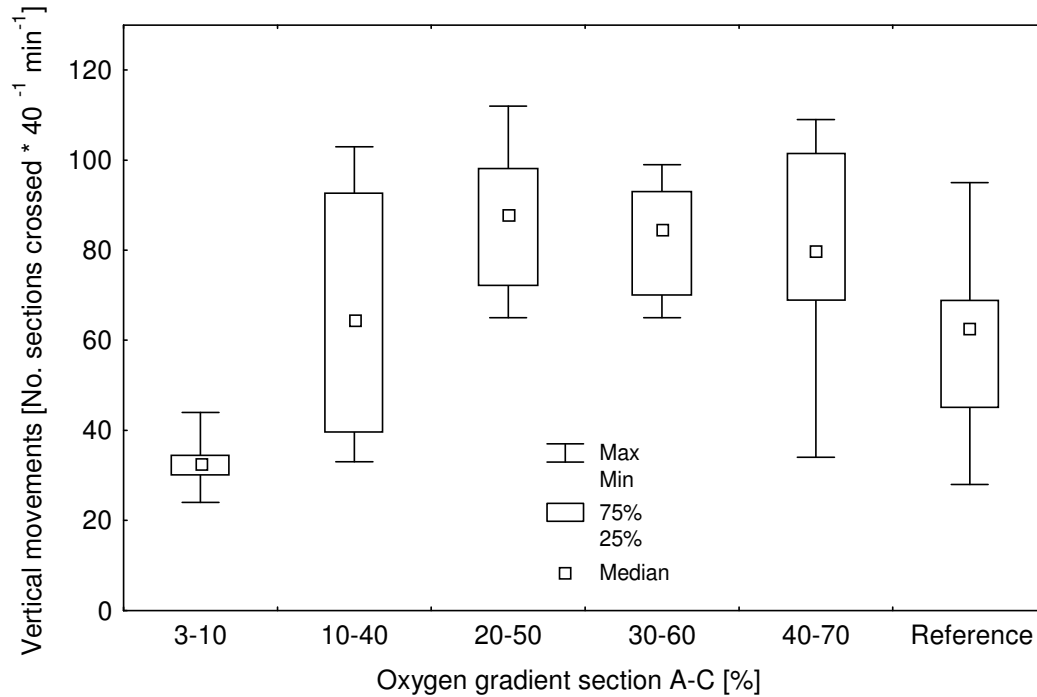

Fig. 3. Vertical movements as the median number of sections crossed during the 40 minute trials by *S. spinachia* at different levels of oxygen gradients (n=8)

The observed pattern resulted from behavioural adaptations to the different oxygen treatments. In the 3-10% oxygen gradients sections A and B were significantly avoided (resampling approach, $p < 0.001$ and $p < 0.001$) by *S. spinachia*. In the same treatments the times spent in section A and the observed numbers of dives into section A were minimal (Tab. 5). In the medium oxygen treatments activity reached maximum values as a result of an increasing number of short time dives into sections with unfavourable oxygen concentrations (Tab. 5). Due to this behaviour the oxygen deficiency layer does not provide a refuge from predation to the amphipods. The references suggested decreasing fish activity due to long-lasting residence time in section A and significant avoidance of section D (resampling approach, $p < 0.001$).

Influence on predator-prey relationship

The strength of the different oxygen gradient levels did not significantly affect the mass of prey ingested by *S. spinachia* compared to the normoxic controls ($t=1.47$, 15 df, $p=0.16$). The predator-prey relationship was sustained over the range of oxygen gradients tested. The range of ingested prey mass in the oxygen gradients was 57.7 mg (n=11) as compared to 40.4 mg (n=6) in the controls (Fig. 4).

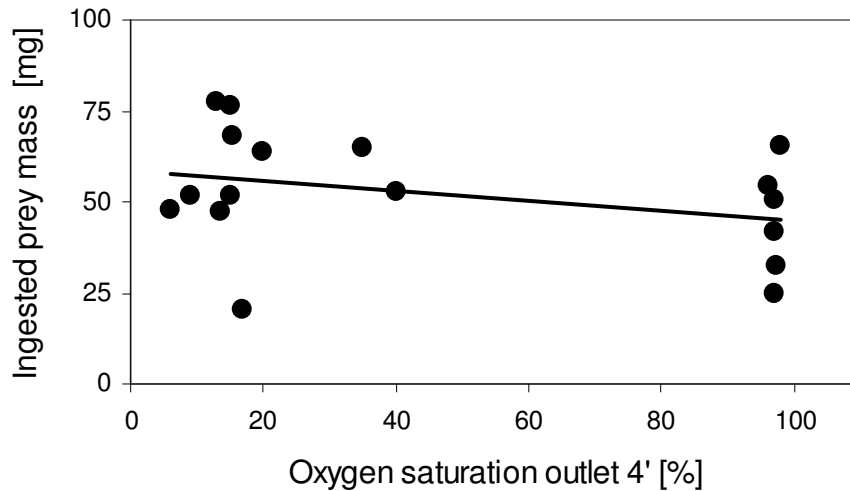

Fig. 4. Mass of *G. salinus* ingested by *S. spinachia* (n=17) in relationship to oxygen saturation in section C after 40 minute trials

In the 3-10% oxygen gradient trials up to 50% of the gammarids moved into the free water column and *S. spinachia* were observed to benefit from the food supply outside the eelgrass plants. At less severe oxygen gradients (10-40% up to 40-70% saturation) and in the controls only single gammarids were observed in the free water column. Although statistically not significant, a trend towards increased predation at low oxygen gradients is evident and indicates that benthic hypoxia can lead to increased predation risk in shallow marine areas as invertebrates increase their activity and leave the protective habitat in search of higher oxygen concentrations.

Discussion

Vertical distribution and activity

The results quantified the habitation and behaviour of *S. spinachia* and *G. salinus* in varying oxygen gradients. Significant behavioural changes appeared in the vertical distribution of predator and prey. In the normoxic references *S. spinachia* preferred all sections with eelgrass, whereas *G. salinus* favoured the sections with high leaf density and sediment with leaf sheaths. This behaviour could be explained by two general characteristics of seagrass meadows that are thought to attract invertebrates and fishes - food and shelter (Heck and Crowder 1991). *Spinachia spinachia* is regarded as an ambush predator that hunts its prey in the cover of submerged vegetation. The fact that amphipods are able to decrease their vulnerability by retreating into the spaces between structures, for example in the spaces between the grass leaves (Ryer 1988), is another reason why

G. salinus displays a preference for sections A and B. The leaf sheath offers protection to *G. salinus* on both sides.

Fish often increase their activity and the ventilation rates of the gills in unfavourable oxygen conditions. These behaviours have been interpreted as a way of withstanding and escaping from suboptimal oxygen conditions. Tolerance to oxygen deficiency can be expected to vary with life stage, habitat and typical activity level, in the presence of other stressors and with physiological differences among species. In general, fish were less tolerant of low oxygen concentrations at higher temperatures (Schurmann and Steffens 1992). In the present study *S. spinachia* and *G. salinus* were given the chance to reach well oxygenated water by moving up in the water column and thus to escape from oxygen deficiency. At severe oxygen gradients predator and prey were expelled from their preferendum. The 50% avoidance level suggested that *S. spinachia* as well as *G. salinus* do not leave their habitat until lethal oxygen concentrations occur. In a natural environment oxygen depletion initiates avoidance reactions of fishes and invertebrates. In the present investigation 50% of *S. spinachia* were banished out of their preferendum at $2.2 \text{ mg O}_2 \text{ L}^{-1}$ (32% saturation). This value is in accordance with data reviewed by Baden et al. (1990), who reported cod (*Gadus morhua*) and whiting (*Merlangius merlangus*) as the first two species that disappear from areas with oxygen concentrations below 3 ml L^{-1} followed by long rough dab (*Hippoglossoides platessoides*). At $1 \text{ ml O}_2 \text{ L}^{-1}$ or less the mean biomass of demersal fish was reduced to approximately 2% of the normal values. The reactions of the soft bottom invertebrate fauna in the southern Kattegat to decreasing oxygen concentrations in the bottom water are also described by Baden et al. (1990). For example, the norway lobster, *Nephrops norvegicus*, emerged from its burrows when oxygen saturation fell below 25%. When O_2 -saturation dropped to 15% some of the infaunal species left their protected positions in the sediment. At 5-10% O_2 -saturation most of the invertebrates died. In our study 50% of *G. salinus* escaped from their preferred habitat at $1.8 \text{ ml O}_2 \text{ L}^{-1}$ (26% saturation). The data from Baden et al. (1990) compare well with the results of this examination. The fact that *G. salinus* escaped out of the preferendum in the face of imminent predation demonstrated the threat coming from unfavourable oxygen conditions (Lima and Dill 1990, Robb and Abrahams 2002). Rahel and Kolar (1990), however, detected a lower threshold for avoidance behaviour without a predator at which 50% of mayflies (*Callibaetis montanus*) remained within a benthic refuge (i.e. within 2 cm of the tank bottom) at about 0.77 mg L^{-1} dissolved oxygen.

In general, fish respond more sensitively to reduced oxygen concentrations than crustaceans (Rosenberg et al. 1991, Nielsson and Rosenberg 1994) corresponding to the differences in sensitivity to hypoxic conditions between predator and prey found in this investigation. The 3-10% gradient ($0.2-0.7 \text{ mg O}_2 \text{ L}^{-1}$) and the 10-40% gradient ($0.7-2.8 \text{ mg O}_2 \text{ L}^{-1}$) represented oxygen conditions that could be lethal to both predator and prey tested. Most fishes show mortality at oxygen concentrations $<2 \text{ mg L}^{-1}$. The limit for avoiding acute mortality in non-salmonid freshwater fishes is assessed at $3 \text{ mg O}_2 \text{ L}^{-1}$ (USEPA 1998).

In oxygen depleted environment the general activity level of gammarids decreases, whereas the ventilation movements by the pleopods increase. Bulnheim (1979) found a mean 50% survival time for *G. salinus* of 5.9 hours (10 psu, 15°C) at $0.70 \pm 0.14 \text{ mg O}_2 \text{ L}^{-1}$, which indicates lower sensitivity to reduced oxygen conditions compared to most fishes. The results of this investigation were obtained in short-term experiments and calculated on the absence and presence of the organisms in the eelgrass habitat and do not reflect their absolute physiological capacity to withstand hypoxic conditions, but the behaviour of a species is a more realistic indication of its probable hypoxic tolerance level.

The feeding performance of *S. spinachia* seems not to be influenced by short-time exposure to varying oxygen gradient levels. The increase of vertical movements at medium oxygen gradients, however, suggested that fish had to increase their energy costs to become satiated. This argument is supported by the observation that fish perform recuperative respiration after short-time dips into this unfavourable environment. Long-term exposure, however, is assumed to have considerable impact on the predator-prey relationship between *S. spinachia* and *G. salinus* in eelgrass habitats.

The ability of fishes to detect and actively avoid areas with low oxygen saturation has been reported from field studies (Pihl et al. 1991, Wannamaker and Rice 2000) and laboratory experiments (Jones 1952, Schurmann et al. 1998). In this examination *S. spinachia* responded adequately to different grades of oxygen deficiencies in their habitat. This observation is supported by the fact that no fish died or stopped feeding during the experiments. The strict avoidance of sections with low oxygen concentrations additionally indicates the ability of *S. spinachia* to detect, move out of, and avoid hypoxic waters. *S. spinachia* seems to have immediate appreciation of water of low oxygen concentration under experimental conditions as also reported by Jones (1952) for three-spined sticklebacks, *G. aculeatus*. *Gasterosteus aculeatus* responded very promptly at 20°C and

oxygen concentrations below 2 mg L^{-1} , and the fish usually would not swim into the poorly oxygenated water.

In this investigation oxygen gradients were coupled with weak salinity gradients. *S. spinachia* (FitzGerald and Wootton 1986) and *G. salinus* (Kinne 1971), both euryhaline organisms, do tolerate minor changes in salinity. Accordingly, the salinity gradient had no influence on behaviour.

Oxygen depletion can have important effects on food webs by altering vertical or horizontal distribution and therefore encounter rates between predator and prey (Magnuson et al. 1985, Kolar and Rahel 1993, Breitburg et al. 1997). Whether predation mortality increases with a hypoxic bottom layer or the hypoxic bottom layer serves as a refuge from predation depends on the behavioural responses and physiological tolerances of the individual species involved in interactions (Rahel and Kolar 1990, Breitburg et al. 2001). In the present study *S. spinachia* was not inhibited in its predatory activities although the fish significantly avoided hypoxic bottom layers of the experimental tubes. Generally, predation increases where predator and prey crowd into a smaller volume of water, and thus encounter rates increase. At severe gradients predator and prey were concentrated in section D and feeding in the free water column tends to result in enhanced predation. Even at lethal oxygen concentrations ($0.2\text{-}0.7 \text{ mg O}_2 \text{ L}^{-1}$), *S. spinachia* dip temporarily into the oxygen deficiency layer (section A) to search for and capture food (Rahel and Nutzman 1994).

Predation can decrease in the presence of a moderately hypoxic bottom layer if predators avoid oxygen concentrations in which their prey remain, or if feeding activity of the predator decreases. In the present study the amphipods hid almost exclusively in the lower eelgrass canopy at weaker gradients and *S. spinachia* displayed behavioural adaptations to meet its food requirements in unfavourable oxygen conditions. They were frequently observed to dive temporarily into the sections of low oxygen concentrations and high prey densities to search for and capture food. *S. spinachia* often snapped the prey and swam up into sections of higher oxygen concentration. Prey handling was then completed in the well-oxygenated upper sections of the tube. After only seconds at low oxygen concentrations the fish moved quickly up into layers of higher oxygen saturation to perform recuperative respiration. This recovery lasted for 10-30 seconds and after it the fish was capable of moving down again into hypoxia to search for food.

The above results indicate that predator and prey exhibited varying responses to different grades of oxygen gradients in their habitat. Aquatic organisms may optimize trade-offs

between predator avoidance and foraging behaviour (Kerfoot and Shi 1987) and they also appear to be very flexible when making trade-offs between predation and stressful or even lethal oxygen conditions. Because marine benthic invertebrates vary in their capability to withstand unfavourable oxygen conditions (Theede et al. 1969, Rosenberg et al. 1991, Gray et al. 2002) and because they vary in their vulnerability to fish predators (Savino and Stein 1982, Kaiser et al. 1992, Gill 2003) periods of severe bottom hypoxia should lead to selective predation. Thus interactions of abiotic factors such as bottom hypoxia and biotic factors such as predation could be an important force structuring eelgrass communities during hypoxic events.

Acknowledgements

This research was funded by the environmental foundation Deutsche Bundesstiftung Umwelt (DBU). We would like to thank Sabine Geisler for the hand drawing of the plexiglas column and Kerstin Pankratz for their studies on stability of thermal and saline stratifications as well as on reactions of gammarids in vertical oxygen gradients.

Summary of the results

I. Catch efficiency

The comparison between the enclosure trap (ET) and the visual diving census technique revealed deficiencies in relative catch efficiency for both methods. Major limitations with respect to bottom dwelling forms were obvious for the ET, and with respect to the syngnathids and *Gasterosteus aculeatus* for the visual diving census. Abundance estimates for the semi-pelagic, shoaling species *Gobiusculus flavescens* were highly variable with both methods. The fish species composition obtained by the methods showed good agreement between each other, but the number of fish species was consistently higher in the ET catches. The length class frequency distributions estimated by the divers corresponded approximately with direct measurements of fish from the ET catches. The methods complemented one another and can be recommended for simultaneous deployment to obtain accurate quantitative abundance estimates of eelgrass fish populations. The capture efficiency coefficients determined for the enclosure trap, however, can be incorporated to improve abundance measurements of small fish species in *Zostera marina* beds without the help of divers.

II. Seasonal structure of vegetation and associated fish community

At Vilm, the abundances and biomasses of fishes as well as eelgrass shoot densities and above-ground biomasses indicated pronounced seasonal variations. The fish abundances peaked in spring and summer, whereas the eelgrass shoot density and biomass culminated only once a year in August. In spring, high fish abundances were caused by shoals of adult *G. aculeatus*. In summer, the abundance and biomass of small fishes culminated when eelgrass biomass were at its maximum. During the night, the total fish abundances increased heavily due to immigration of juvenile gobiids. The analysis detected significant correlations between eelgrass bed structure, fish community and abiotic parameters. Water temperature displayed significant negative correlations with secchi-depth (water transparency), and secchi-depth, in turn, correlated significantly with eelgrass biomass. Significant correlations between fish abundance and eelgrass biomass were detected, when *G. aculeatus* (and rare larger fish species) were excluded from the analysis. Water transparency, water temperature and eelgrass biomass are directly affected by the intensity of the incident solar radiation. I found variations of the fish community structure within the eelgrass meadow to be mainly regulated by fish migrations (spawning, recruitment and day-night cycles) and predation.

III. Fish community, nutrition and grazer consumption

Gobiids, syngnathids and gasterosteids dominated the eelgrass fish assemblages at both sampling sites in both years. The predation on epiphyte grazers was of minor relevance to the fishes at Vilm. Gastropods were generally of minor dietary importance at both eelgrass meadows. In contrast to Vilm, small crustacean grazers (<6mm) played a pivotal role in fish nutrition at Falkenstein. *Spinachia spinachia* and *Zoarces viviparus* represented the major consumers of grazing isopods and amphipods. During their growth, the dietary relevance of *I. balthica* increased considerably. The results indicate a pronounced predation upon small development stages of amphipods and isopods, constituting a substantial food resource for the eelgrass fish assemblage. Predation by small fishes, however, suggests only minor impacts on the crustacean grazer populations. Of all fishes, *S. spinachia* and *Z. viviparus* showed the highest potential in controlling amphipod and *I. balthica* populations in eelgrass beds of the Baltic Sea.

IV. *Spinachia spinachia* – an effective predator of small amphipods and *Idotea balthica*

I chose *S. spinachia* and crustacean grazer preys as a model system to study predator-prey relationships because of their abundance and ecological significance. *Spinachia spinachia* was a frequent element of the eelgrass fish community in terms of abundance and biomass. During ontogeny, *S. spinachia* passed through a dietary shift, and *I. balthica* became the major food. *Idotea balthica* exceeding 16 mm and *Gammarus* spp. exceeding 14 mm in body length had reached a *Spinachia*-invulnerable size refugium. Within the eelgrass meadow, *S. spinachia* actively selected *I. balthica*. The feeding preference as determined in the laboratory demonstrated distinct preferences for *G. salinus* when compared to *I. balthica*. These contradictory results may be explained by differences in prey availability between field and laboratory. Eelgrass densities of up to 400 shoots per m² did not limit ingestion rates of *S. spinachia* foraging on amphipods or isopods.

V. Bottom oxygen and fish predation

Spinachia spinachia was able to detect and avoid bottom oxygen deficiencies and to forage efficiently over a wide range of oxygen gradients in their habitat. They showed graduated behavioural responses to the intensity of the stress. Within a well-oxygenated water column, both *S. spinachia* and their prey favoured the vegetated bottom region (preferendum) within the experimental columns. At very low oxygen concentrations, both predator and prey were forced out of their preferendum and *S. spinachia* successfully

preyed upon *G. salinus* above the eelgrass canopy. *Spinachia spinachia* responded slightly less tolerant to reduced water oxygen concentrations than the prey. Thus, at less severe oxygen gradients the prey remained within the canopy while *S. spinachia* had to leave it. Even at severe oxygen gradients, the regions with reduced oxygen concentration did not provide refugium against fish predation, since *S. spinachia* dipped into the sections of lowered oxygen conditions from above the eelgrass canopy to search for, and successfully capture, prey. In between the dives, *S. spinachia* resided within the oxygen-saturated sections above the eelgrass canopy.

General discussion

The catch efficiency of a newly developed enclosure trap (ET) was compared to a visual diving census technique (VDC). The methods differed in their characterisation of the fish fauna. Differences were found with respect to the rank order of fish species but the species spectrum presented by both methods was consistent among them and with results of other comparable investigations in the Baltic Sea (Winkler and Thiel 1993, Bischoff et al. 1997, Thetmeyer 1998). The ET detected the shoaling semi-pelagic *Gobiusculus flavescens* with low relative efficiency. Enclosure traps generally underrepresent fast-swimming, pelagic, shoaling fish species (Rozas and Minello 1997). Numerous replicate hauls and observations are required to avoid this bias, although another approach is to exclude shoaling pelagic fish from the analyses because of the data distortion they cause (Edgar et al. 2001). Pipefish of the family Syngnathidae were among the most frequent species captured by the ET. Small cryptic fish can be underestimated by more than an order of magnitude by the visual diving census, even with meticulous searches of small areas (Brock 1982, Willis 2001). The fifteen-spined stickleback, *Spinachia spinachia*, was detected in similar abundances by both methods, indicating low avoidance response and good perception by the divers. By contrast, the three-spined stickleback, *Gasterosteus aculeatus*, exhibited the lowest detectability and was almost absent from the VDC counts. The ET, however, demonstrated *G. aculeatus* to be a frequent eelgrass inhabitant. Pronounced avoidance responses of *G. aculeatus* to the silhouette and the noise of divers, as noted by Jansson et al. (1985), were also observed during this study. The bottom dwelling fishes (mostly Gobiidae) and the shore crab, *C. maenas*, were caught with significantly reduced efficiency by the ET, compared to the visual census. These results are in general accordance with published data (Rozas and Minello 1997), who stated that sedentary, non-shoaling animals are generally underrepresented in enclosure trap catches. The ET represents a useful sampling device for the rapid and easy assessment of fish communities in *Zostera marina* beds. The portable trap is relatively cheap and the closing mechanism worked perfectly in dense *Zostera* vegetation. It can yield a high number of replicates and allows repeated sampling in short time intervals from relatively small areas or experimental plots essential in scientific research and coastal monitoring programs. The ET and VDC are complementary and their simultaneous use is recommended to obtain accurate quantitative estimates of eelgrass fish populations. The correction coefficients of the ET can be used to improve abundance measurements of small fishes in *Zostera marina* beds without the help of divers. The correction coefficients for different behavioural

groups and individual fish species facilitate quantitative sampling of small eelgrass nekton. These results indicate that the new ET yields consistent and adequate predictions about the fish community structure and abundance in *Zostera marina* beds. General advantages over other assessment techniques and drawbacks of the ET are summarised in Bobsien and Brendelberger (2006).

The variability in abundance, biomass and species richness of seagrass fish assemblages is governed by several factors. Faunal variability in eelgrass beds can be related to abiotic factors such as water temperature, salinity, tidal range and hydrodynamical conditions as well as diurnal or seasonal migration, predation and competition (Boström and Bonsdorff 1997). The physico-chemical environment can vary and differ substantially between different seagrass localities in the Baltic Sea (Baden and Boström 2001). At Vilm, water had a salinity of about 6, which restricts the occurrence of many marine fish species, whereas generally more limnic fish species inhabit the eelgrass meadow compared to the Falkenstein eelgrass meadow (salinity of 17). Spawning migrations (*G. aculeatus*) cause abundance maxima during spring and fish recruitment in late summer (Jönsson et al. 1998). Maximum abundances in late summer and early fall are in accordance with the seasonal abundance patterns observed in the Barther Lagoon (Thiel 1990). The sharp decline in fish biomass between September and October is explained by emigration and predation. Inconsistent information exists about the seasonal migration of *Pomatoschistus microps* and *P. minutus*. Hesthagen (1977) observed that sand gobies emigrate from the shallow coastal areas in Oslofjord during winter, whereas Nellbring (1988) detected gobies under ice in shallow parts in the northern Baltic Sea. In this study, the majority of gobies is found to migrate into deeper regions of the Greifswald Lagoon during winter months. Increasing abundances of *Perca fluviatilis*, predating the *Pomatoschistus* recruits in August, indicates increased predation pressure as a further possible reason for the decline in fish abundance in late summer. *Nerophis ophidion* occurred to be closely associated with the eelgrass and was also detected during the winter months. All other fish species showed no strict binding to eelgrass and were equally found on bare sand (Jönsson et al. 1998). The abundance of gobiids increased heavily during the night, whereas abundances of *Syngnathus typhle* decreased. Robertson (1980) suggested predation and food availability as the most likely factors influencing day-night migration of fishes in eelgrass beds in Australia. I also suggest *Pomatoschistus* spp. and *S. typhle* to

forage inside and outside the eelgrass meadow at night, respectively, either due to favoured feeding conditions and/or due to reduced predation risk.

The dominating fish families detected in both eelgrass meadows (Falkenstein, Vilm) during this study were syngnathids, gobiids and gasterosteids. The eelpout *Zoarces viviparus* was also a frequent eelgrass inhabitant of the Falkenstein eelgrass meadow in 2003. Pollard (1984) ranked syngnathids, gobiids and gasterosteids among the prominent fish families occurring in seagrass habitats at various geographical localities in the Atlantic-Mediterranean region. The general nutrition pattern observed was similar to those of other seagrass fish assemblages studied worldwide. Many of the fish species found in eelgrass beds are generalists and forage on sandy bottoms as well as in vegetated habitats. Generally, as also shown for both eelgrass locations examined, crustaceans were found to be the major food items in the fish diets (Bell and Harmelin-Vivien 1983, Pollard 1984, Edgar and Shaw 1995a). Nevertheless, the fish communities at Vilm and Falkenstein possess considerable difference with regard to their feeding habits. The proportions of copepod consumption were substantially higher in the eelgrass fish community of Vilm, when compared to Falkenstein, and only few fish species consumed notable amounts of epiphyte-grazing amphipods and isopods. By contrast, much higher proportions of amphipods, isopods and gastropods were consumed by the Falkenstein fish community, and these grazers were consumed by the majority of fishes. These findings led to the conclusion that epiphyte grazers are of minor nutritional importance for the fish assemblage of Vilm, but represent a pivotal proportion of the fish diets at Falkenstein eelgrass beds. Gastropod consumption by fishes was extremely low indicating both minor dietary importance to the fishes and only marginal structuring effects of fish predation on the gastropod population. The proportions of isopod and amphipod production consumed by fishes at the Falkenstein eelgrass bed constituted 39% and 38%, respectively. These values are similar to results obtained by Bennet and Branch (1990). They investigated a temperate estuary in South Africa and estimated the proportions of isopod and amphipod production preyed upon by fish to be 15.3 and 40.5%, respectively. The total fish predation on gastropods (*Hydrobia* spp.), however, was still higher (42%) and exceeded the values of the present study by far (<1%).

I selected *S. spinachia* to investigate feeding habits and predator-prey interactions between small fish species and epiphyte grazers in eelgrass beds. The present results characterise *S. spinachia* as a frequent eelgrass inhabitant consuming large amount of epiphyte grazers, with the exception of gastropods. Mysids play only a minor role in the nutrition of *S. spinachia*, while *I. balthica* turn out to be a key component in the diet (Kislalioglu and Gibson 1977, Kaiser et al. 1992). The differences in the sizes of amphipods and isopods ingested by *S. spinachia* in the eelgrass meadow are assumed to be related to prey availability, prey habitat choice and prey responses to the presence of a predator (Hacker and Stenek 1990, Wudkevich et al. 1997, Boström and Mattila 1999). The preference of *S. spinachia* for gammaridean amphipods against *I. balthica* in the laboratory disagrees with the findings in the eelgrass meadow. Large gammarids (>10 mm body length), however, are less abundant in the Falkenstein eelgrass bed and are suggested to be insufficiently available for the sticklebacks (Hacker and Stenek 1990). This may explain why *S. spinachia* ingested larger gammarids in the laboratory trials than in the field and spent significant more time to overcome large *G. oceanicus* than equal sized *I. balthica*.

The relationship between prey abundance and feeding efficiency of *Spinachia spinachia* showed a significant increase in feeding rates between 120 and 350 prey (*G. salinus*) individuals per m² at about 300 shoots per m². The shoot and gammarid densities adjusted in the trials were very close to the natural conditions, and therefore, I suggest major changes in feeding success of *S. spinachia* within this range of prey densities. The reason for the decreased ingestion rates of *S. Spinachia* when foraging on *I. balthica* at medium prey densities remains unclear. *Spinachia spinachia* foraged successfully within eelgrass densities of up to 400 shoots per m². The mean (\pm SD) eelgrass shoot density at Falkenstein (Jul-Oct 2002) was 330 \pm 102 shoots per m², and maximum values of more than 500 shoot per m² occur only at small patchy stands. Boström et al. (2002) found that shoot densities >150 per m² significantly reduced the predation on infauna by *Platichthys flesus*. Gotceitas and Colgan (1989) showed a non-linear relationship between stem density (artificial vegetation) and the foraging success of piscivorous large mouth bass. They estimated a threshold density of 276 stems per m². Nevertheless, restrictions to the feeding success of fishes may occur at much higher shoot densities (Heck and Thoman 1981).

The results of the present study show that motile animals leave the eelgrass habitat at a certain oxygen level and rise in the water column until they reach more favourable oxygen conditions. Montagna and Ritter (2006) observed negative direct effects of hypoxia on benthic organisms, but no indirect effect, such as increased predation pressure. *Spinachia spinachia* were found to be slightly less tolerant to reduced water oxygen concentration than the prey *G. salinus*. At low oxygen levels, both predator and prey were expelled from their preferendum, and *S. spinachia* preyed upon *G. salinus* above the eelgrass canopy. These preliminary findings suggest that *S. spinachia* benefits from oxygen deficiencies in the eelgrass habitat. At less severe oxygen gradients, however, the prey remained within the eelgrass cover and *S. spinachia* performed short-term dips into the regions of reduced oxygen levels to search for, and successfully capture, prey. In between the dives, *S. spinachia* resided above the eelgrass canopy exposed to potential predators. The results indicate strong predation effects over the entire range of oxygen gradients adjusted in the experiments. Aquatic organisms may optimize trade-offs between predator avoidance and foraging behaviour (Kerfoot and Sih 1987), and they also appear to be very flexible when making trade-offs between predation and stressful or even lethal oxygen conditions. Because marine benthic invertebrates vary in their capability of withstanding unfavourable oxygen conditions (Rosenberg et al. 1991, Gray et al. 2002), and because they vary in their vulnerability to fish predators (Gill 2003), periods of severe bottom hypoxia will lead to selective mortality and predation. Thus, interactions of abiotic factors, such as bottom hypoxia, and biotic factors, such as predation, could be an important force structuring eelgrass communities during short-term hypoxic events.

Conclusions

The present study describes the fish communities and the trophic relationships between small fish species and epiphyte-grazing invertebrates of two eelgrass beds in the Baltic Sea. Abiotic and biotic factors that influence predator-prey relationships in eelgrass beds are investigated.

The newly developed enclosure trap (ET) provides a useful mobile sampling tool that adequately reflects community structure and abundance of small fish species in vegetated habitats (**Chapter I**). The ET yields instantaneous samples and allows repeated sampling at short time intervals from relatively small areas or experimental plots essential in coastal monitoring programmes and scientific research (Edgar et al. 2001, **Chapter I**).

The fish community structure and fish feeding habits differ considerably between both sampling locations (**Chapters II and III**). At Vilm, fish predation on epiphyte grazers (amphipods, isopods, gastropods) is of minor importance (**Chapter III**), and grazer abundances are low (Munkes 2005). The eelgrass meadows in the Greifswald Lagoon are controlled mainly by abiotic determinants and biotic top-down factors, with fish predation on grazers or epiphyte-grazing invertebrates being of minor importance (Munkes 2005, **Chapter II**). The eelgrass meadows at Falkenstein contain diverse invertebrate communities and appear to be controlled by epiphyte grazers (Jaschinski, pers. comm., **Chapter II**). The crustacean grazer populations contribute largely to the diet of eelgrass-associated fish, while gastropods are generally of minor dietary importance (**Chapter III**). These results lead to the conclusion that predation by small fish species may regulate crustacean grazer abundance. Fish predation can have considerable regulative implications for ecosystem processes if grazer abundances are kept under a certain threshold level because grazing effects are often density dependant (Engkvist et al. 2000). Direct grazing on basibionts can be an important structuring factor (Fredriksen et al. 2004, Nilsson et al. 2004). The gastropod grazer population, however, is not significantly affected by fish predation (**Chapter III**). The grazing activities of gastropods may result in two different outcomes: (1) Grazing efficiently removes epiphyte cover from the leaves and recover eelgrass productivity (Jernakoff et al. 1996) while (2) heavy grazing activities of gastropods on the other hand may cause epidermal injuries resulting in deterioration of eelgrass meadows (Fredriksen et al. 2004).

Spinachia spinachia is an effective crustacean predator that efficiently forages on amphipods in dense vegetation (**Chapter IV**). These finding are in contrast to the prevailing opinion that dense eelgrass habitats primarily provide protection against visually

orientated predators (Orth et al. 1984, Heck and Crowders 1991). The relative size of predator and prey are important factors that strongly determine the effects of vegetation structure on predator-prey interactions (Stoner 1982) because at very high shoot densities the manoeuvrability of a predator also will be influenced (Nelson 1979). The effects of fish predation on crustacean grazers may vary considerably with varying fish numbers. Eelgrass fish stocks vary greatly with season and between years (**Chapters II and III**). Thus, variations in predation pressure within relatively short time intervals are expected (Nilsson 2004). Long-term variations of eelgrass and its associated fish communities are affected by several factors (e.g. eutrophication, over-fishing, climate change) and enormous fluctuations on small spatial scales are expected. These changes include drastic changes in fish species composition (Winkler 1991), oscillations in fish abundance (Niemann 1991, **Chapter III**) or a collapse of small-sized fish species populations (Rajasilta et al. 1999). Bottom hypoxia can have extensive consequences on predator-prey interactions (Breitenburg et al. 1997).

The present study shows that oxygen deficiencies near the bottom do not create a predation refugium for *G. salinus* against stickleback predation, independent of the severity of the oxygen gradients (**Chapter V**). The ability of marine fish to perform foraging trips into low oxygen water should become integrated into models describing fish distribution and production (Karim et al. 2003). Although the tolerance of aquatic organisms to hypoxia is well-known (Diaz and Rosenberg 1995, Gray et al. 2002), there is need to clarify the behavioural adaptations and skills of fish to cope with hypoxic conditions (**Chapter V**).

References

- Adams, S. M., 1976a. The ecology of eelgrass, *Zostera marina* (L.), fish communities. I. Structural analysis. *Journal of Experimental Biology and Ecology*, 22: 269-291
- Adams, S. M., 1976b. The ecology of eelgrass, *Zostera marina* (L.), fish communities. II. Functional analysis. *Journal of Experimental Biology and Ecology*, 22: 293-311
- Baden, S. P., Boström, C., 2001. The leaf canopy of seagrass beds: Faunal community structure and function in a salinity gradient along the Swedish coast. *Ecological Studies*, 151: 214-236
- Baden, S. P., Loo, L. -O., Pihl, L., Rosenberg, R., 1990. Effects of eutrophication on benthic communities including fish: Swedish west coast. *Ambio*, 19: 113-122
- Bärlocher, F., 1998. Statistical analysis of feeding experiments: a resampling approach. *Journal of Applied Statistical Reasoning*, <http://www.concentric.net/~jasrstat/jasr.html> Jan. 1998
- Bechtel, T. J., Copeland, B. J., 1970. Fish species diversity indices as indicators of pollution in Galveston Bay, Texas. *Publications of the Institute of Marine Science. The University of Texas*, 15: 103-132
- Bell, J. D., Harmelin-Vivien, M. L., 1983. Fish fauna of French Mediterranean *Posidonia oceanica* seagrass meadows. 2. Feeding habits. *Tethys*, 11: 1-14
- Bell, J. D., Pollard, D. A., 1989. Ecology of fish assemblages and fisheries associated with seagrasses. In: A. W. D. Larkum, A. J. McComb, S. A. Shepherd (eds.), *Biology of Seagrasses. A treatise on the biology of seagrasses with special reference to the Australian region*, Elsevier, p. 565-609
- Bennet, W. A., Beitinger, T. L., 1995. Overview of techniques for removing oxygen from water and a description of a new oxygen depletion system. *The Progressive Fish Culturist*, 57: 84-87
- Bennet, B. A., Branch, G. M., 1990. Relationships between production and consumption of prey species by resident fish in the Bot, a cool temperate South African estuary. *Estuarine and Coastal Shelf Science*, 31: 139-155
- Bischoff, K., Quitschau, K., Schöne, H., 1997. Zum Vorkommen ausgewählter Tierarten in den Seegrasswiesen vor Timmendorf (Insel Poel). In: *Meer und Museum. Schriftenreihe des Deutschen Museums für Meereskunde und Fischerei*, Stralsund, 13: 62-64
- Bobsien, I. C., Brendelberger, H., 2006. Comparison of an enclosure drop trap and a visual diving census technique to estimate fish populations in eelgrass beds. *Limnology and Oceanography: Methods*, (in press)
- Bobsien, I. C., Munkes, B., 2004. Seasonal variation of the fish community and habitat structure in an eelgrass bed (*Zostera marina* L.) in the southern Baltic Sea. *Rostocker Meeresbiologische Beiträge*, 12: 39-59

- Borum, J., Wium-Andersen, S., (1980). Biomass and production of epiphytes on eelgrass (*Zostera marina* L.) in the Oresund, Denmark. *Ophelia*, 1 (Supplement): 57-64
- Boström, C., Baden, S. P., Krause-Jensen, D., 2003. The seagrasses of Scandinavia and the Baltic Sea. In: Green, E. P., Short, F. T. (Eds). *The world atlas of seagrasses*. University of California press, p. 27-35
- Boström, C., Bonsdorff, E., 1997. Community structure and spatial variation of benthic invertebrates associated with *Zostera marina* (L.) beds in the northern Baltic Sea. *Journal of Sea Research*, 37: 153-166
- Boström, C., Bonsdorf, E., 2000. Zoobenthic community establishment and habitat complexity – the importance of seagrass shoot-density, morphology and physical disturbance for faunal recruitment. *Marine Ecology Progress Series*, 205: 123-138
- Boström, C., Bonsdorff, E., Kangas, P., Norrko, A., 2002. Long-term changes of a brackish water eelgrass (*Zostera marina* L.) community indicate effects of coastal eutrophication. *Estuarine and Coastal Shelf Science*, 55: 795-804
- Boström C., Mattila, J., 1999. The relative importance of food and shelter for seagrass associated invertebrates: a latitudinal comparison of habitat choice by isopod grazers. *Oecologia*, 120: 162-170
- Breitburg, D., 2002. Effects of hypoxia, and the balance between hypoxia and enrichment, on coastal fishes and fisheries. *Estuaries*, 25: 767-781
- Breitburg, D. L., Loher, T., Pacey, C. A., Gerstein, A., 1997. Varying effects of low dissolved oxygen on trophic interactions in an estuarine food web. *Ecological Monographs*, 67: 489-507
- Breitburg, D. L., Pihl, L., Kolesar, S. E., 2001. Effects of low dissolved oxygen on the behavior, ecology and harvest of fishes: a comparison of the Chesapeake Bay and Baltic-Kattegat Systems. In: N. N. Rabalais and R. E. Turner (eds.). *Coastal Hypoxia: consequences for living resources and ecosystems*. American Geophysical Union, Washington, D. C., p. 241-267
- Brock, V. E., 1954. A preliminary report on method of estimating reef fish populations. *Journal of Wildlife Management*, 18: 297-308
- Brock, V. E. 1982. A critic of the visual census method for assessing coral reef fish populations. *Bulletin of Marine Science*, 32: 269-276
- Brönmark C., Vermaat J. E., 1998. Complex fish-snail-epiphyton interactions and their effects on submerged freshwater macrophytes. In: Jeppesen E., Søndergaard Ma., Søndergaard Mo., Christoffersen K. (Eds). *The structuring role of submerged macrophytes in lakes*. Springer, New York, p. 47-68
- Bulnheim, H.-P., 1979. Comparative studies on the physiological ecology of five euryhaline *G.* species. *Oecologia (Berl.)*, 44: 88-86

- Bulthuis, D. A., (1987). Effect of temperature on photosynthesis and growth of seagrasses. *Aquatic Botany*, 27: 27-40
- Carpenter, S. R., Kitchell, J. F., Hodgson, J. R., 1985. Cascading trophic interactions and lake productivity. *Bioscience*, 35: 634-639
- Carpenter, S. R., Kitchell, J. F., Hodgson, J. R., Cochran, P. A., Elser, M. M., Lodge, D. M., Kretchmer, D., He, X., von Ende, C. N., 1987. Regulation in lake primary productivity by food-web structure. *Ecology*, 68: 1863-1867
- Chesson, J. (1983). The estimation and analysis of preference and its relationship to foraging models. *Ecology*, 64: 1297-304
- Chick, J. H., Jordan, F., Smith, J. P., McIvor, C. C., 1992. A comparison of four enclosure traps and methods used to sample fishes in aquatic macrophytes. *Journal of Freshwater Ecology*, 7: 353-361
- Connolly, R. M., 1994. Comparison of fish catches from buoyant pop net and beach seine net in a shallow seagrass habitat. *Marine Ecology Progress Series*, 109: 305-309
- Costanza, R., d'Arge, R., de Groot, R., Farber, S., Grasso, M., Hannon, B., Limburg, K., Naeem, S., O'Neill, R. V., Paruelo, J., Raskin, R. G., Sutton, P., van den Belt, M., 1997. The values of the world's ecosystem services and natural capital. *Nature*, 387: 253-260
- Croy, M. I., Hughes, R. N., 1991a. Hierarchical response to prey stimuli and associated effects of hunger and foraging experience in the fifteen-spined stickleback, *Spinachia spinachia* (L.). *Journal of Fish Biology*, 38: 599-607
- Croy, M. I., Hughes, R. N., 1991b. The influence of hunger on feeding behaviour and on the acquisition of learned foraging skills by the fifteen-spined stickleback, *Spinachia spinachia* (L.). *Animal Behaviour*, 41: 161-170
- Croy, M. I., Hughes, R. N., 1991c. Effects of food supply, hunger, danger and competition on choice of foraging location by the fifteen-spined stickleback, *Spinachia Spinachia* (L.). *Animal Behaviour*, 42: 131-139
- Croy, M. I., Hughes, R. N., 1991d. The role of learning and memory in the feeding behaviour of the fifteen-spined stickleback, *Spinachia spinachia* L. *Animal Behaviour*, 41: 149-159
- Dewey, M. R., Holland-Bartels, L. E., Zigler, S. J., 1989. Comparison of fish catches with buoyant pop nets and seines in vegetated and nonvegetated habitats. *North American Journal of Fisheries Management*, 9: 249-253
- Diaz, R. J., Rosenberg, R., 1995. Marine benthic hypoxia: A review of its ecological effects and the behavioural responses of benthic macrofauna. *Oceanography and Marine Biology: An Annual Review*, 33: 245-303
- Duffy, J. E., Harvilicz, A. M., 2001. Species specific impacts of grazing amphipods in an eelgrass-bed community. *Marine Ecology Progress Series*, 223: 201-211

- Duarte, C. M., 2002. The future of seagrass meadows. *Environmental Conservation*, 29: 193-206
- Edgar, G. J., 1990a. The use of the size structure of benthic macrofaunal communities to estimate faunal biomass and secondary production. *Journal of Experimental Marine Biology and Ecology*, 137: 195-214
- Edgar, G. J., 1990b. Population regulation, population dynamics and competition amongst mobile epifauna associated with seagrass. *Journal of Experimental Marine Biology and Ecology*, 144: 205-234
- Edgar, G. J., Barrett, N. S., Morton, A. J., 2004. Biases associated with the use of underwater visual census technique to quantify the density and size-structure of fish populations. *Journal of Experimental Marine Biology and Ecology*, 308: 269-290
- Edgar, G. J., Mukai, H., Orth R. J., 2001. Fish, drabs, shrimps and other large mobile epibenthos: measurement methods for their biomass and abundance in seagrass. In: F. T. Short and R. G. Coles [eds.], *Global Seagrass Research Methods*. Elsevier Science, p. 255-270
- Edgar, J. E., Shaw, C., 1995a. The production and trophic ecology of shallow-water fish assemblages in southern Australia I. Species richness, size structure and production of fishes in Western Port, Victoria. *Journal of Experimental Marine Biology and Ecology*, 194: 53-81
- Edgar, G. J., Shaw, C., 1995b. The production and trophic ecology of shallow-water fish assemblages in southern Australia II. Diets of fishes and trophic relationships between fishes and benthos at Western Port, Victoria. *Journal of Experimental Marine Biology and Ecology*, 194: 83-106
- Edgar, G. J., Shaw, C., 1995c. The production and trophic ecology of shallow-water fish assemblages in southern Australia III. General relationships between sediments, seagrasses, invertebrates and fishes. *Journal of Experimental Marine Biology and Ecology*, 194: 107-131
- Ellund, A. -M., Sundmark, G., Thorman S., 1980. The identification of *Pomatoschistus pictus*, *P. microps*, and *P. minutus* (Gobiidae, Pisces). *Sarsia*, 65: 239-242
- Engkvist, R., Malm, T., Nilsson, J., 2004. Interactions between isopod grazing and wave action: a structuring force in macroalgal communities in the southern Baltic Sea. *Aquatic Ecology*, 38: 403-413
- Engkvist, R., Malm, T., Tobiasson, S., 2000. Density dependent grazing effects of the isopod *Idotea batica* Pallas on *Fucus vesiculosus* L. in the Baltic Sea. *Aquatic Ecology*, 34: 253-260
- Feldner, J., 1976. Ökologische und produktionsbiologische Untersuchung am Seegrass *Zostera marina* L. in der Kieler Bucht (westliche Ostsee). PhD thesis, University of Kiel, pp. 175

- FitzGerald, G. J., Wootton, R. J., 1986. Behaviour ecology of sticklebacks. In: Pitcher, T. J. (ed.): The behaviour of teleost fishes, Croom Helm, London & Sydney, p. 409-432
- Freeman, B. J., Greening, H. S., Oliver, J. D., 1984. Comparison of three methods for sampling fishes and macroinvertebrates in a vegetated freshwater wetland. *Journal of Freshwater Ecology*, 2: 603-609
- Fredriksen, S., Christie, H., Boström, C., 2004. Deterioration of eelgrass (*Zostera marina* L.) through destructive grazing by the gastropod *Rissoa membranacea* (J. Adams). *Sarsia*, 89: 218-222
- Gill, A. B., 2003. The dynamics of prey choice in fish: the importance of prey size and satiation. *Journal of Fish Biology*, 63 (Supplement A): 105-116
- Gill, A. B., Hart, P. J. B., 1994. Feeding behaviour and prey choice of the threespine stickleback: the interacting effects of prey size, fish size and stomach fullness. *Animal Behaviour*, 4: 921-932
- Gill, A. B., Hart, P. J. B., 1998. Stomach capacity as a directing factor in prey size selection of three-spined stickleback (*Gasterosteus aculeatus*). *Journal of Fish Biology*, 53: 897-900
- Gill, A. B., Hart, P. J. B., 1999. Dynamic changes in prey choice by sticklebacks during simultaneous encounter with large prey. *Journal of Fish Biology*, 55: 1317-1327
- Gilmore, R. G., 1990. Nekton: biomass and abundance. In: R. C. Phillips and C. P. McRoy [eds], *Seagrass research methods. Monographs on oceanographic methodology*. United Nations Educational, p. 129-132
- Gilmore, R. G., Holt, J. K., Jones, R. S., Kulczycki, G. R., MacDowell III, L. G., Magley, W. C., 1978. Portable tripod drop net for estuarine fish studies. *Fisheries Bulletin*, 76: 285-289
- Gray, S. J., Wu, R. S., Or, Y. Y., 2002. Effects of hypoxia and organic enrichment on the coastal marine environment. *Marine Ecology Progress Series*, 238: 249-279
- Gründel, E. R., 1980. Ökosystem Seegrasswiese. Qualitative und quantitative Untersuchungen über Struktur und Funktion einer *Zostera*-Wiese vor Surendorf (Kieler Bucht, westliche Ostsee). PhD thesis, University of Kiel, pp. 226
- Hacker, S. D., Stenek, R. S., 1990. Habitat architecture and the abundance and body-size dependent habitat selection of a phytal amphipod. *Ecology*, 71: 2269-2285
- Harmelin-Vivien, M. L., Francour, P., 1992. Trawling or visual censuses? Methodological bias in the assessment of fish population in seagrass beds. *Marine Ecology*, 13: 41-51
- Hart, P. J. B., Gill, A. B., 1992. Constraints on prey size selection by the three-spined stickleback: energy requirements and the capacity and fullness of the gut. *Journal of Fish Biology*, 40: 205-218

- Hauxwell, J., Cebrian, J., Christopher, F., Valiela, I., 2000. Macroalgal canopies contribute to eelgrass (*Zostera marina*) decline in temperate estuarine ecosystems. *Ecology*, 82: 1007-1022
- Hauxwell, J., Cebrian, J., Valiela, I., 2003. Eelgrass *Zostera marina* loss in temperate estuaries: relationship to land-derived nitrogen loads and effect of light limitation imposed by algae. *Marine Ecology Progress Series*, 247: 59-73
- Heck, K. L., Jr., Able, K. W., Roman, C. T., Fahay, M. P., 1995. Composition, abundance, biomass, and production of macrofauna in a New England estuary: comparison among eelgrass meadows and other nursery habitats. *Estuaries*, 18: 379-389
- Heck, K. L., Jr., Crowder L. B., 1991. Habitat structure and predator-prey interactions in vegetated aquatic systems. In: S. S. Bell, E. D. McCoy and H. R. Mushinsky (eds.), *Habitat structure. The physical arrangement of objects in space*, Chapman and Hall, London, pp. 281-299
- Heck, K. L. Jr., Orth, R. J., 1980. Seagrass habitats: The roles of habitat complexity, competition and predation in structuring associated fish and motile macroinvertebrate assemblages. In: *Estuarine Perspectives*. V. S. Kennedy (Ed.), Academic Press, New York, pp. 449-464
- Heck, Jr., K. L., Pennock, L. R., Valentine, J. F., Coen, L. D., Sklenar, S. A., 2000. Effects of nutrients enrichment and small predator density on seagrass ecosystems: an experimental assessment. *Limnology and Oceanography*, 45: 1041-1057
- Heck, K. L., Jr., Thoman, T. A., 1981. Experiments on predator-prey interactions in vegetated aquatic habitats. *Journal of Experimental Marine Biology and Ecology*, 53: 125-134
- Heckscher, E., Hauxwell, J., Galán Jiménez, E., Reitsma, C., Valiela, I., 1996. Selectivity by the herbivorous amphipod *Microdeutopus gryllotalpa* among five species of macroalgae. *Biological Bulletin*, 191: 324-326
- Hellier, T. R., Jr., 1958. The drop-net quadrat, a new population sampling device. *Publications of the Institute of Marine Science, University of Texas*, 5: 165-168
- Hemminga, M. A., Duarte, C. M., 2000. *Seagrass Ecology*. Cambridge University Press, pp. 298
- Heerkloss, R., 1996. Biomassenequivalente planktischer und benthischer Organismen in Boddengewässern der südlichen Ostsee. *Rostocker Meeresbiologische Beiträge*, 4: 85-95
- Hesthagen, I. H., 1977. Migration, breeding, and growth in *Potamoschistus minutus* (Pallas) (Pisces, Gobiidae) in Oslofjorden, *Sarsia*, 63: 17-26
- Higer, A. L., Kolipinski, M. C., 1967. Pull-up trap: A quantitative device for sampling shallow water animals. *Ecology*, 48: 1008-1009

- Hoese, H. D., Copeland, B. J., Mosely, F. N., Lane, E. D., 1968. Fauna of the Aransas Pass Inlet, Texas. III. Diel and seasonal variations in trawlable organisms of the adjacent areas, *The Texas Journal of Science*, 20: 33-60
- Holling, C. S., 1966. The functional response of invertebrate predators to prey density. *Memoirs of the Entomological Society of Canada*, 48:1-86
- Hootsmans, M. J. M., Vermaat, J. E., 1985. The effect of periphyton-grazing by three epifaunal species on the growth of *Zostera marina* L. under experimental conditions. *Aquatic Botany*, 22: 83-88
- Horinouchi, M., Nakamura, Y., Sano, M., 2005. Comparative analysis of visual census using different width strip-transects for a fish assemblage in a seagrass bed. *Estuarine, Coastal and Shelf Science*, 65: 53-60
- Howard, R. K., 1982. Impact of feeding activities of epibenthic amphipods on surface fouling of eelgrass leaves. *Aquatic Botany*, 14: 91-97
- Howard, R. K., Short, F. T., 1986. Seagrass growth and survivorship under the influence of epiphyte grazers. *Aquatic Botany*, 24: 287-302
- Hughes, R. N., 1980. Optimal foraging theory in the marine context. *Oceanography and Marine Biology: an Annual Review*, Aberdeen, 18: 423-481
- Huh, S. -H., Kitting, C. L., 1985. Trophic relationships among concentrated populations of small fishes in eelgrass meadows. *Journal of Experimental Marine Biology and Ecology*, 92: 29-43
- Hunter-Thomsen, K., Hughes, J., Williams, B., 2002. Estuarine-open-water comparison of fish community structure in eelgrass (*Zostera marina* L.) habitats of Cape Cod. *Biological Bulletin*, 203: 247-248
- Hübel, H., Hübel, M., 1995. Blooms of blue-green algae in the Baltic Sea: causes dimensions – consequences. In: Actual problems of the marine environment. Lectures of the 4th International Scientific Symposium *Deutsche Hydrographische Zeitschrift*, 2 (Supplement): 151-158
- Hyndes, G., 2000. Do fish communities differ among seagrass assemblages? *Biologia Marina Mediterranea*, Genova, 7: 227-230
- Hyslop, E. J., 1980. Stomach content analysis. A review of methods and their applications. *Journal of Fish Biology*, 17: 411-429
- Jackson, J. B. C., Kirby, M. X., Berger, W. H., Bjorndal, K. A., Botsford, L. W., Bourque, B. J., Bradbury, R. H., Cooke, R., Erlandson, J., Estes, J. A., Hughes, T. P., Kidwell, S., Lange, C. B., Lenihan, H. S., Pandolfi, J. M., Peterson, C. H., Steneck, R. S., Tehner, M. J., Warner, R. R., 2001. Historical overfishing and the recent collapse of coastal ecosystems. *Science*, 293: 629-637

- Jacobsen, T., Kushlan, J. A., 1987. Sources of sampling bias in enclosure fish trapping: Effects on estimates of density and diversity. *Fisheries Research*, 5: 401-412
- Jansson, B. -O., Aneer, G., Nellbring, S., 1985. Spatial and temporal distribution of the demersal fish fauna in a Baltic archipelago as estimated by SCUBA census. *Marine Ecology Progress Series*, 23: 31-43
- Jeppesen, E., Søndergaard, Ma., Søndergaard, Mo., Christoffersen, K., 1998. The structuring role of submerged macrophytes in lakes. Springer, New York, pp. 423
- Jernakoff, P., Brearly, A., Nilsen, J., 1996. Factors affecting grazer-epiphyte interactions in temperate seagrass meadows. *Oceanography and Marine Biology: An Annual Review*, 34: 109-162
- Jones, J. R., 1952. The reactions of fish to water of low oxygen concentration. *The Journal of Experimental Biology*, 29: 403-415
- Jonzén, N., Cardinale, M., Gardemark, A., Lundberg, P., 2002. Risk of collapse in the eastern Baltic cod fishery. *Marine Ecology Progress Series*, 240: 225-233
- Jönsson, N., Bush, A., Lorenz, Th., Korth, B., 1998. Struktur und Funktion von Boddenlebensgemeinschaften im Ergebnis von Austausch- und Vermischungsprozessen. *Greifswalder Geographische Arbeiten*, 16: 250-285
- Jordan, F., Coyne, S., Trexler, J. C., 1997. Sampling fishes in vegetated habitats: Effects of habitat structure on sampling characteristics of the 1-m² throw trap. *Transactions of the American Fisheries Society*, 126: 1012-1020
- Kahl, M. P., Jr., 1963. Technique for sampling population density of small shallow-water fish. *Limnology and Oceanography*, 8: 302-304
- Kaiser, M. J., Gibson, R. N., Hughes, R. N., 1992. The effect of prey type on the predatory behaviour of the fifteen-spined stickleback, *Spinachia spinachia* (L.). *Animal Behaviour*, 43: 147-156
- Kaiser, M. J., Croy, M. I., 1991. Population structure of the fifteen-spined stickleback, *Spinachia spinachia* (L.). *Journal of Fish Biology*, 39: 129-131
- Kaiser, M. J., Westhead, A. P., Hughes, R. N., Gibson, R. N., 1992. Are digestive characteristics important contributors to the profitability of prey? *Oecologia*, 90: 61-69
- Karim, M. R., Sekine, M., Higuchi, T., Imai, T., Ukita, M., 2003. Simulation of fish behaviour and mortality in hypoxic water in an enclosed bay. *Ecological Modelling*, 159: 27-42
- Karlson, K., Rosenberg, R., Bonsdorf, E., 2002. Temporal and spatial large-scale effects of eutrophication and oxygen deficiency on benthic fauna in Scandinavian and Baltic waters – A review. *Oceanography and Marine Biology: An Annual Review*, 40: 427-489

- Kennelly, S. J., 1991. Caging experiments to examine the effects of fishes on understory species in a sublittoral kelp community. *Journal of Experimental Marine Biology and Ecology*, 147: 207-230
- Kerfoot, W. C., Sih, A., (eds.), 1987. *Predation: direct and indirect impacts on aquatic communities*. University Press of New England, Hannover and London, pp. 386
- Kikuchi, T., 1974. Japanese contributions on consumer ecology in eelgrass (*Zostera marina* L.) beds, with special reference to trophic relationships and resources in onshore fisheries. *Aquaculture*, 4: 145-160
- Kinne, O., 1971. Salinity: Animals-Invertebrates. In: Kinne, O., (ed.). *Marine Ecology*. Wiley-Interscience, London, p. 821-995
- Kislalioglu, M., Gibson, R. N., 1976a. Prey "handling time" and its importance in food selection by the 15-spined stickleback, *Spinachia spinachia* (L.). *Journal of Experimental Marine Biology and Ecology*, 25: 151-158
- Kislalioglu, M., Gibson, R. N., 1976b. Some factors governing prey selection by the 15 spined stickleback, *Spinachia spinachia* (L.). *Journal of Experimental Marine Biology and Ecology*, 25: 159-169
- Kislalioglu, M., Gibson, R. N., 1977. The feeding relationships of shallow water fishes in a Scottish sea loch. *Journal of Fish Biology*, 11: 257-266
- Kjelson, M. A., Johnson, G. N., 1978. Catch efficiencies of a 6.1-meter otter trawl for estuarine fish populations. *Transactions of the American Fisheries Society*, 107: 246-254
- Kjelson, M. A., Turner, W. R., Johnson, G. N., 1975. Description of a stationary drop-net for estimating nekton abundance in shallow waters. *Transactions of the American Fisheries Society*, 104: 46-49
- Kolar, C. S., Rahel, F. J., 1993. Interaction of a biotic factor (predator presence) and an abiotic factor (low oxygen) as an influence on benthic invertebrate communities. *Oecologia*, 95: 210-219
- Köster, F. W., Möllmann, C., 2000. Trophodynamic control by clupeid predators on recruitment success in Baltic cod? *ICES Journal of Marine Science*, 57: 310-323
- Krause-Jensen, D., Christensen, P. B., Rysgaard, S., 1999. Oxygen and nutrient dynamics within mats of the filamentous macroalgae *Chaetomorpha linum*. *Estuaries*, 22: 31-38
- Krause-Jensen, D., McGlathery, K., Rysgaard, S., Christensen, P. B., 1996. Production within dense mats of the filamentous macroalga *Chaetomorpha linum* in relation to light and nutrient availability. *Marine Ecology Progress Series*, 134: 207-216
- Krebs, C. J., 1999. *Ecological methodology*, 2nd ed. Benjamin/Cummings, Menlo Park, California, pp. 620

- Kushlan, J. A., 1974. Quantitative sampling of fish populations in shallow freshwater environments. *Transactions of the American Fisheries Society*, 103: 348-352
- Kushlan, J. A., 1981. Sampling characteristics of enclosure fish traps. *Transactions of the American Fisheries Society*, 110: 557-562
- Larson, E. W., Johnson, D. L., Lynch, W. E., 1986. A buoyant pop net for accurately sampling fish at artificial habitat structures. *Transactions of the American Fisheries Society*, 115: 351-355
- Lima, S. L., Dill, L. M., 1990. Behavioral decisions made under the risk of predation: a review and prospectus. *Canadian Journal of Zoology*, 68: 619-640
- Lubbers, L., Boynton, W. R., Kemp, W. M., 1990. Variation in structure of estuarine fish communities in relation to abundance of submerged vascular plants. *Marine Ecology Progress Series*, 65: 1-14
- Magnuson, J. J., Beckel, A. L., Mills, K., Brandt, S. D., 1985. Surviving winter hypoxia: behavioural adaptations of fishes in a northern Wisconsin lake. *Environmental Biology of Fishes*, 14: 242-250
- Martin, T. H., Crowders, L. B., Dumas, C. F., Burkholder, J. M., 1992. Indirect effects of fish on macrophytes in Bays Mountain Lake: evidence for a littoral trophic cascade. *Oecologia*, 89: 476-481
- Messner, U., von Ortzen, J. A., 1991. Long-term changes in the vertical distribution of macrophytobenthic communities in the Greifswalder Bodden. *Acta Ichthyologica et Piscatoria*, 21(Supplement): 135-143
- Montagna, P. A., Ritter, C., 2006. Direct and indirect effects of hypoxia on benthos in Corpus Christi Bay, Texas, USA. *Journal of Experimental Marine Biology and Ecology*, 330: 119-131
- Möller, H., 1984. *Daten zur Biologie der Quallen und Jungfische in der Kieler Bucht*. Verlag Heino Möller, Kiel, pp. 181
- Möller, P., Pihl, L., Rosenberg, R., 1985. Benthic faunal energy flow and biological interactions in some shallow marine soft bottoms habitats. *Marine Ecology Progress Series*, 27: 109-121
- Moore, K. A., Williams, D. D., 1990. Novel strategies in the complex defence repertoire of a stone fly (*Pteronarcys dorsata*) nymph. *Oikos*, 57: 49-56
- Mosely, F. N., Copeland, B. J., 1969. A portable drop-net for representative sampling of nekton. *Publications of the Institute of Marine Science*. University of Texas, 14: 37-45
- Motulsky, H., Ransnas, L. A., 1987. Fitting curves to data using nonlinear regression: a practical and nonmathematical review. *The Federation of American Societies for Experimental Biology Journal*, 1: 365-374

- Munkes, B., 2005. Stability of seagrass systems against anthropogenic impacts. PhD thesis, University of Kiel, pp. 110
- Murphy, M. L., Johnson, S. W., Csepp, D. J., 2000. A comparison of fish assemblages in eelgrass and adjacent subtidal habitats near Craig, Alaska. Alaska Fisheries Research Bulletin, 7: 11-21
- Nellbring, S., 1985. Abundance, biomass and seasonal variation of fish on shallow soft bottoms in the Askö area, northern Baltic proper. Sarsia, 70: 217-225
- Nellbring, S., 1988. Quantitative and qualitative studies of fish in shallow water, Northern Baltic Proper. Doctoral thesis at the University of Stockholm, Akademiförlag AB, pp. 98
- Nelson, T. A., 1997. Epiphyte-grazer interactions on *Zostera marina* (Anthophyta, monocotyledons): effects of density on community structure. Journal of Phycology, 33: 740-752
- Nelson, W. G., 1979. Experimental studies of selective predation on amphipods: consequences for amphipod distribution and abundance. Journal of Experimental Marine Biology and Ecology, 38: 225-245
- Niemann, H., 1991. Die Fischbesiedlung im Flachwasser der Kieler Bucht – Ein Vergleich der Sommer 1976 und 1990. Diploma thesis University of Kiel, pp. 73
- Nienhuis, P. H., 1983. Temporal and spatial pattern of eelgrass (*Zostera marina* L.) in a former estuary in the Netherlands, dominated by human activities. Marine Technology Society Journal, 17: 69-77
- Nilsson, J., 2004. Causes and consequences of recent changes in coastal fish and macroalgal populations in the Baltic Sea. PhD thesis, Department of Biology and Environmental Science, University of Kalmar
- Nilsson, J., Engkvist, R., 2004. Fish predation as a possible regulator of populations of the grazing isopod *Idotea baltica* in the Baltic Sea. Manuscript III. PhD thesis Department of Biology and Environmental Science University of Kalmar, Sweden
- Nilsson, J., Engkvist, R., Persson, L.-E., 2004. Long-term decline and recent recovery of *Fucus* populations along the rocky shores of southeast Sweden, Baltic Sea. Aquatic Ecology, 38: 587-598
- Nilsson, H. C., Rosenberg, R., 1994. Hypoxic response of two marine benthic communities. Marine Ecology Progress Series, 115: 209-217
- Norton, T. A., Hawkins, S. J., Manley, N. L., Williams, G. A., Watson, D. C., 1990. Scraping a living: a review of littorinid grazing. Hydrobiologia, 193: 117-138
- Olesen, B., 1999. Reproduction in Danish eelgrass (*Zostera marina* L.) stands: size dependence and biomass partitioning. Aquatic Botany, 65: 209-219

- Olsen, M. H., 1996. Predator-prey interactions in size-structured fish communities: implications on prey growth. *Oecologia*, 108: 757-763
- Orav-Kotta, H., Kotta, J., 2003. Seasonal variation in the grazing of *Gammarus oceanicus*, *Idotea baltica*, and *Palaemon adspersus* on benthic macroalgae. *Proceedings of the Estonian Academy of Science, Biology and Ecology*, 52: 141-148
- Orav-Kotta, H., Kotta, J., 2004. Food and habitat choice of the isopod *Idotea baltica* in the northeastern Baltic Sea. *Hydrobiologia*, 514: 79-85
- Orth, R. J., Heck, K. L. Jr., 1980. Structural components of eelgrass (*Zostera marina*) meadows in the lower Chesapeake Bay – fishes. *Estuaries*, 3: 278-288
- Orth, R. J., Heck, K. L., Jr., van Montfrans, J., 1984. Faunal communities in seagrass beds: a review of the influence of plant structure and prey characteristics on predator-prey relationships. *Estuaries*, 7: 339-350
- Orth, R. J., van Montfrans, J., 1984. Epiphyte-seagrass relationships with an emphasis on the role of micrograzing: A review. *Aquatic Botany*, 18: 43-69
- Paine, R. T., 1980. Food webs: linkage, interaction strength and community infrastructure. *Journal of Animal Ecology*, 49: 667-685
- Paepke, H.-J., 2001. *Gasterosteus aculeatus* Linnaeus, 1758. - In: Banarescu, P. M. & Paepke, H. -J. (eds.): *The Freshwater Fishes of Europe*. Vol. 5/III, Cyprinidae 2, Part III: Gasterosteidae, Aula-Verlag, pp. 209-276
- Parsley, M. J., Palmer, D. E., Burkhardt, R. W., 1998. Variation in capture efficiency of a beach seine for small fishes. *North American Journal of Fisheries and Management*, 9: 239-244
- Petersen, C. G. J., 1918. The sea bottom and its production as fish food. A survey of the work done in connection with evaluation of the Danish waters from 1883-1917. *Report of the Danish Biological Station to the Ministry of Fisheries*, 25: 1-82
- Philippart, C. J. M., 1995. Effect of periphyton grazing by *Hydrobia ulvae* on the growth of *Zostera noltii* on a tidal flat in the Dutch Wadden Sea. *Marine Biology*, 122:431-437
- Pierce, C. L., Rasmussen, J. B., Leggett, W. C., 1990. Sampling littoral fish with seine: Corrections for variable capture efficiency. *Canadian Journal of Fisheries and Aquatic Science*, 47: 1004-1010
- Pihl, L., Baden, S. P., Diaz, R. J., 1991. Effects of periodic hypoxia on distribution of demersal fish and crustaceans. *Marine Biology*, 108: 349-360
- Pihl Baden, S., Pihl, L., 1984. Abundance, biomass and production of mobile epibenthic fauna in *Zostera marina* (L.) meadows, Western Sweden. *Ophelia*, 23: 65-90

- Pihl, L., Baden, S., Kautsky, N., Rönnbäck, P., Söderqvist, T., Troell, M., Wennhage, H., 2006. Shift in fish assemblage structure due to loss of seagrass *Zostera marina* habitats in Sweden. *Estuarine, Coastal and Shelf Science*, 67: 123-132
- Pihl, L., Rosenberg, R., 1982. Production, abundance, and biomass of mobile epibenthic marine fauna in shallow waters, Western Sweden. *Journal of Experimental Marine Biology and Ecology*, 57: 273-301
- Pollard, D. A., 1984. A review of ecological studies on seagrass-fish communities, with particular reference to recent studies in Australia. *Aquatic Botany*, 18: 3-42
- Powers, S. P., Peterson, C. H., Christian, R. R., Sullivan, E., Powers, M. J., Bishop, M., Buzelli, C. P., 2005. Effects of eutrophication on bottom habitat and prey resources of demersal fishes. *Marine Ecology Progress Series*, 302: 233-243
- Rahel, F. J., Kolar, C. S., 1990. Trade-offs in the response of mayflies to low oxygen and fish predation. *Oecologia*, 84: 39-44
- Rahel, F. J., Nuztman, J. W., 1994. Foraging in lethal environment: fish predation in hypoxic waters of a stratified lake. *Ecology*, 75: 1246-1253
- Rajasilta, M., Mankki, J., Ranta-Aho, K., Vuorinen, I., 1999. Littoral fish communities in the Archipelago Sea, SW Finland: a preliminary study of changes over 20 years. *Hydrobiologia*, 393: 253-259
- Rasmussen, E., 1973. Systematics and ecology of the Isefjord marine fauna (Denmark). *Ophelia*, 11: 1-495
- Reusch, T. B. H., Chapman, A. R. O., Gröger, J. P., 1994. Blue mussels *Mytilus edulis* do not interfere with eelgrass *Zostera marina* but fertilize shoot growth through biodeposition. *Marine Ecology Progress Series*, 108: 265-282
- Robb, T., Abrahams, M. V., 2002. The influence of hypoxia on risk of predation and habitat choice by the fathead minnow, *Pimephales promelas*. *Behavioral Ecology and Sociobiology*, 52: 25-30
- Robertson, A. I., 1980. The structure and organisation of an eelgrass fish fauna. *Oecologia (Berl.)*, 47: 76-82
- Robertson, A. I., 1984. Trophic interactions between fish fauna and macrobenthos of an eelgrass community of in Western Port, Victoria. *Aquatic Botany*, 18: 135-153
- Rosenberg, R., Hellmann, B., Johannson, B., 1991. Hypoxic tolerance of marine benthic fauna. *Marine Ecology Progress Series*, 79: 127-131
- Rosenberg, R., Loo, L. – O., 1988. Marine eutrophication induced oxygen deficiency: effects on soft bottom fauna, Western Sweden. *Ophelia*, 29: 213-225
- Rozas, L. P., 1992. Bottomless lift net for qualitative sampling nekton on intertidal marshes. *Marine Ecology Progress Series*, 89: 287-292

- Rozas, L. P., Minello, T. J., 1997. Estimating densities of small fishes and decapod crustaceans in shallow estuarine habitats: A review of sampling design with focus on gear selection. *Estuaries*, 20: 199-213
- Ryer, C. H., 1988. Pipefish foraging: effects of fish size, prey size and altered habitat complexity. *Marine Ecology Progress Series*, 37: 37-45
- Salthaug, A., 2002. Quantitative comparison of aquatic sampling gears. *Sarsia*, 87: 128-134
- Sand-Jensen, K. & Borum, J., 1991. Interactions among phytoplankton, periphyton, and macrophytes in temperate freshwaters and estuaries. *Aquatic Botany*, 41: 137-175
- Savino, J. F., Stein, R. A., 1982: Predator-prey interactions between largemouth bass and bluegills as influenced by simulated, submerged vegetation. *Transactions of the American Fisheries Society*, 111: 255-266
- Schanz, A., Polte, P., Asmus, H., 2002. Cascading effects of hydrodynamics on an epiphyte grazer system in intertidal seagrass beds of the Wadden Sea. *Marine Biology*, 141: 287-297
- Scharf, F. S., Juanes, F., Rountree, R. A., 2000. Predator size-prey size relationships of marine fish predators: interspecific variation and effects of ontogeny and body size on trophic-niche breadth. *Marine Ecology Progress Series*, 208: 229-248
- Schurmann, H., Claireaux, G., Chartois, H., 1998. Changes in vertical distribution of sea bass (*Dicentrarchus labrax* L.) during a hypoxic episode. *Hydrobiologia*, 271: 207-213
- Schurmann, H., Steffens, J. F., 1992. Lethal oxygen levels at different temperatures and the preferred temperature during hypoxia of the Atlantic cod, *Gadus morhua* L.. *Journal of Fish Biology*, 41: 927-934
- Schwieber, U., 2001. Salzhaff, Greifswalder Bodden, Darß-Zingster Boddenkette: Gewässereutrophierung und Pufferkapazität – ein Vergleich. *Rostocker Meeresbiologische Beiträge*, 9: 5-19
- Serafy, J. E., Harrell, R. M., Stevenson, J. C., 1988. Quantitative sampling of small fishes in dense vegetation: Design and field testing of portable “pop-nets”. *Journal of Applied Ichthyology*, 4: 149-157
- Sevenson, P. A., Malm, T., Engkvist, R., 2004. Distribution and host plant preference of *Idotea baltica* (Pallas) (Crustacea: Isopoda) on shallow rocky shores in the central Baltic Sea. *Sarsia*, 89: 1-7
- Short, F. T. & Duarte, C. M., 2001. Methods for the measurement of seagrass growth and production. In: Short, F. T. & Coles, R. G. (Eds.): *Global seagrass research methods*, Chapter 8, Amsterdam, Elsevier Science B. V., pp. 155-182
- Short, F. T., Wyllie-Echeverria, S., 1996. Natural and human-induced disturbance of seagrasses. *Environmental Conservation*, 23: 17-27

- Sogard, S. M., Powell, G. V. N., Holmquist, J. G., 1989. Spatial distribution and trends in abundance of fishes residing in seagrass meadows on Florida Bay mudbanks. *Bulletin of Marine Science*, 44: 179-199
- Sokal, R. R., Rohlf, F. J., 1995. *Biometry: The principles and practice of statistics in biological research*. Third edition. Freeman & Co, New York, pp. 887
- Steneck, R. S., Watling, L., 1982. Feeding capabilities and limitation of herbivorous molluscs – a functional group approach. *Marine Biology*, 68: 299-320
- Stoner, A. W., 1983. Distribution of fishes in seagrass meadows: Role of macrophyte biomass and species composition. *Fishery Bulletin*, 81: 837-846
- Stoner, A. W., 1982. The influence of benthic macrophytes on the foraging behaviour of pinfish, *Lagodon rhomboids* (Linnaeus). *Journal of Experimental Marine Biology and Ecology*, 8: 271-284
- Taleb, H., Lair, N., Jamet, J.-J., 1992. Estival diel vertical migration of *Acanthodiptomus denticornis* (Wierzejski, 1887) (Calanoida: Copepoda) in an eutrophic lake of temperate zone. *Annales des Sciences Naturelles, Zoologie, Paris*, 13: 149-156
- Theede, H., Ponat, A., Hiroki, K., Schlieper, C., 1969. Studies on the resistance of marine bottom invertebrates to oxygen-deficiency and hydrogen sulphide. *Marine Biology*, 2: 325-337
- Thetmeyer, H., 1998. *Kleinfische der Ostsee. Umweltmonitoring in Schleswig-Holstein. Monitoring-Bericht. Landesamt für Natur und Umwelt des Landes Schleswig Holsteins, Flintbeck*, pp. 57
- Thiel, R., 1990. *Untersuchungen zur Ökologie der Jung- und Kleinfischgemeinschaften in einem Boddengewässer der südlichen Ostsee*. PhD thesis, University of Rostock, pp. 147
- Thiel, R., Sepulveda, A., Kafemann, R., Nellen, W., 1995. Environmental factors as forces structuring the fish community of the Elbe Estuary. *Journal of Fish Biology*, 46: 47-69
- Thompson, A. A., Mapstone, B. D., 1997. Observer effects and training in underwater visual surveys of reef fishes. *Marine Ecology Progress Series*, 154: 53-63
- Thorman, S., 1986. Physical factors affecting the abundance and species richness of fishes in the shallow waters of the Southern Bothnian Sea (Sweden). *Estuarine, Coastal and Shelf Science*, 22: 357-369
- Thorman, S., Fladvad, B., 1981. Growth and production of fish in river Broälven estuary on the Swedish west coast. National Swedish Environmental Protection Board. Rep.1416, pp. 112
- Thorman, S. & Wiederholm, A.-M., 1986. Food, habitat and time niches in a coastal fish species assemblage in a brackish water bay in the Bothnian Sea, Sweden. *Journal of Experimental Marine Biology and Ecology*, 95: 67-86

- Ubl, C., Lauterbach, S., Schulz, S., 2000. Ein Beitrag zur Entwicklung eines Klein- und Jungfischmonitorings an der Küste Mecklenburg-Vorpommerns. *Mitteilungen der Landesforschungsanstalt für Landwirtschaft und Fischerei*, 22: 157-165
- USEPA (United States Environmental Protection Agency), 1986. Quality criteria for water 1986. (EPA 440/5-86-001). USEPA, Washington DC, p. 209-219
- Vahteri, P., Mäkinen, A., Salovius, S., Vuorinen, I., 2000. Are drifting algal mats conquering the bottom of the archipelago sea, SW Finland. *Ambio*, 29: 338-343
- Van Montfrans, J., Orth, R. J., Vay, S. A., 1982. Preliminary studies of grazing by *Bittium varium* on eelgrass periphyton. *Aquatic Botany*, 14: 75-89
- Van Montfrans, J., Wetzel, R. L., Orth, R. J., 1984. Epiphyte-grazer relationships in seagrass meadows: consequences for seagrass growth and production. *Estuaries*, 7: 289-309
- Wannamaker, C. M., Rice, J. A., 2000. Effects of hypoxia and behaviour of selected estuarine organisms from the south-eastern United States. *Journal of Experimental Marine Biology and Ecology*, 249: 145-163
- Watson, R.A., R. G. Coles, W. L. Lee Long, 1993. Simulation estimates of annual yield and landed value for commercial penaeid prawns from a tropical seagrass habitat, Northern Queensland, Australia. *Australian Journal of Marine and Freshwater Research*, 44: 211-219
- Wennhage, H., Gibson, R. N., Robb, L., 1997. The use of drop traps to estimate the efficiency of two beam trawls commonly used for sampling juvenile flatfishes. *Journal Fish Biology*, 51: 441-445
- Willis, T. J., 2001. Visual census methods underestimate density of and diversity of cryptic reef fishes. *Journal Fish Biology*, 59: 1408-1411
- Winkler, H. M., 1991. Changes in structure and stock in exploited fish communities in estuaries of the southern Baltic coast (Mecklenburg-Vorpommern, Germany). *Internationale Revue der gesamten Hydrobiologie*, 76: 413-422
- Winkler, H. M., Thiel, R., (1993). Beobachtungen zum aktuellen Vorkommen wenig beachteter Kleinfischarten an der Ostseeküste Mecklenburgs und Vorpommerns (Nordostdeutschland). *Rostocker Meeresbiologische Beiträge*, 1: 95-104
- Worthmann, H., 1975. Die Makrozoobenthos- und Fischbesiedlung in verschiedenen Flachwassergebieten der Kieler Bucht (Westl. Ostsee). Diploma thesis, University of Kiel, pp. 141
- Wudkevich, K., Wisensen, B. D., Chivers, D. P., Smith, R. J. F., 1997. Reactions of *Gammarus lacustris* to chemical stimuli from natural predators and injured conspecifics. *Journal of Chemical Ecology*, 23: 1163-1173

Appendix

Table I. Size-wet mass (M_w , [mg]) and size-ash free dry mass (AFDM, [mg]) relationships of frequent crustacean grazers and gastropods in the Falkenstein eelgrass beds. l = body length and h = shell height [mm]. Size mass relationships of gastropods were calculated with shell

Species	Size [mm]	n	r^2	Regression equation
<i>Idotea balthica</i>	1.5-22.0	57	0.92	$M_w = 0.0700 \cdot l^{2.5736}$
			0.98	$AFDM = 0.0066 \cdot l^{2.6479}$
<i>Jaera albifrons</i>	1.9-3.5	16	0.45	$M_w = 0.1198 \cdot l^{1.7224}$
			0.37	$AFDM = 0.0141 \cdot l^{2.4194}$
<i>Gammarus salinus</i>	4.5-12.0	17	0.91	$M_w = 0.0166 \cdot l^{2.9287}$
			0.88	$AFDM = 0.0013 \cdot l^{3.2455}$
<i>Erichthonius difformis</i>	2.4-6.7	19	0.84	$M_w = 0.0279 \cdot l^{2.7405}$
			0.87	$AFDM = 0.0038 \cdot e^{0.8541l}$
<i>Microdeutopus gryllotalpa</i>	2.5-10.0	64	0.67	$M_w = 0.0506 \cdot l^{2.6435}$
			0.63	$AFDM = 0.0284 \cdot e^{0.4947l}$
<i>Corophium</i> spp	1.5-6.0	20	0.42	$M_w = 0.2404 \cdot l^{1.6966}$
			0.62	$AFDM = 0.1173 \cdot l$
Gastropoda	0.9-26.0	145	0.89	$M_w = 0.0473 \cdot h^{3.4238}$
			0.93	$AFDM = 0.0059 \cdot h^{3.3689}$

Table II. Three length classes (CL₁₋₃) of frequent eelgrass fish and number of individuals (N) investigated to calculate the “index of relative importance”. F=Falkenstein, V=Vilm

Species	Location	Length classes [mm]					
		CL ₁	N ₁	CL ₂	N ₂	CL ₃	N ₃
<i>Nerophis ophidion</i>	F	100-149	80	150-199	43	200-299	17
	V	80-149	61	150-199	44	200-310	27
<i>Syngnathus typhle</i>	F	35-90	27	91-140	32	141-240	27
	V	45-90	11	91-130	36	131-175	9
<i>Syngnathus rostellatus</i>	F	70-99	10	100-119	20	120-165	12
<i>Pomatoschistus minutus</i>	F	15-45	9	46-59	21	60-75	11
	V	20-32	12	33-42	15	43-60	17
<i>Pomatoschistus microps</i>	V	20-25	15	26-30	36	31-40	14
<i>Gobius niger</i>	F	20-34	16	35-49	22	50-85	8
<i>Gobiusculus flavescens</i>	F	15-24	12	25-34	17	35-45	34
<i>Spinachia spinachia</i>	F	27-63	19	64-100	20	101-150	37
<i>Gasterosteus aculeatus</i>	F	20-34	16	35-49	16	50-80	7
	V	19-34	4	35-49	4	50-67	29
<i>Zoarces viviparus</i>	F	40-79	25	80-129	11	130-190	7

Table III. Regression equations used to recalculate prey body length (P_L) of crustaceans and shell height (S_H) of gastropods from prey width (P_W) or shell width (S_W) and prey height (P_H) of measurable fragments found in stomachs

Species	Size [mm]	r^2	n	Regression equation
<i>Idotea balthica</i>	0.8-15.3	0.96	474	$P_L=3.4902 P_W + 0.1560$
<i>Jaera albifrons</i>	0.7-4.0	0.94	82	$P_L=1.9557 P_W + 0.2134$
<i>Gammarus</i> spp.	0.6-14.4	0.92	395	$P_L=4.1812 P_H + 0.3091$
<i>Erichthonius difformis</i>	0.2-9.2	0.86	1034	$P_L=5.5560 P_H + 0.1793$
<i>Microdeutopus gryllotalpa</i>	1.2-7.8	0.71	54	$P_L=3.8551 P_H + 1.1789$
<i>Corophium</i> spp.	0.7-5.6	0.77	437	$P_L=4.8891 P_H + 0.2136$
Gastropoda	0.1-2.5	0.95	227	$S_H=1.3113 S_W + 0.0027$

Table IV. Regression equations to calculate the total length (L_G) of *Gammarus* spp. by the distances from the anterior end of the caput to the dorsal posterior end of thoracomere four (CT_G) and maximum height (H_G) from total length

p	r^2	n	Regression equation
p<0.05	0.94	20	$L_G=2.5264 CT_G + 0.3804$
p<0.001	0.92	225	$H_G=0.238 L_G - 0.076$

Danksagung

An erster Stelle möchte ich mich bei Herrn Prof. Dr. Heinz Brendelberger für die Vergabe des Themas, die Betreuung und die Möglichkeit zur Anfertigung dieser Arbeit in der Abteilung Limnologie bedanken. Frau Geisler danke ich für die akkuraten Zeichnungen (Einschlussfalle, Plexiglaszylinder), für die Wasseranalysen und für die entspannenden Pausen mit dampfendem Tee. Der gesamten Abteilung Limnologie danke ich für die gemütliche Arbeitsatmosphäre, die anregenden Gespräche und die vielen Hilfeleistungen (besonders das Korrekturlesen von Martin Zimmer und Malte Mews).

Ganz besonders möchte ich meiner allerliebsten Lebensgefährtin Gabi und unserem Sohn Jako danken, die mich immer unterstützt, aufgemuntert und mit den essentiellen Dingen des Lebens versorgt haben. Auch danke ich ihnen für die Bereitschaft in manchen Phasen meiner Promotion meine sehr eingeschränkte Anwesenheit hinzunehmen.

Weiter danke ich Dr. von Nordheim und Dr. Knapp vom Bundesamt für Naturschutz (BfN) für die Bereitstellung eines Bootes und dafür, dass ich auf der Insel Vilm einen Teil meines Projektes durchführen konnte. Ebenso dankbar bin ich dem Nationalparkamt Rügen, dem Landesamt für Fischerei Mecklenburg-Vorpommern und dem Amt für ländliche Räume Kiel für die notwendigen Ausnahmegenehmigungen. Vielen Dank an Thomas Walter und Michael Bachmann für den Bau der Einschussfalle und an Uwe Kuchler (Rolladen-Kuchler Company) für die Rollläden. Meinem guten Freund Klaus Kreyelkamp danke ich für die maßstabsgetreue 3D-Zeichnung der Einschussfalle. Weiterer Dank gilt Kerstin Maczassek, Björn Thoma, Kerstin Pankratz und Claudia Scheller für die Ergebnisse, die sie mir durch ihre Forschungsarbeiten zur Verfügung stellten. Für ihre Taucheinsätze und die Hilfen beim Fangen von Fischen danke ich Björn Thoma, Kerstin Maczassek und Michael Teßmann. Britta Munkes und Sandra Gohse-Reimann danke ich für die Seegras- bzw. Makrozoobenthosdaten. Viele Freunde und Kollegen unterstützten mich tatkräftig bei den Arbeiten auf und am Wasser. Vielen Dank dafür! Besonderer Dank geht an Britta Munkes, die mir stets tatkräftig beim Einsatz der Einschussfalle im Greifswalder Bodden half und auch unter den widrigsten Wetterbedingungen viele Stunden mit mir auf dem Wasser verbrachte. Vielen Dank an Ralf Grunewald, bei dem ich immer einen Platz zum Übernachten fand und auch an alle anderen Schwerpunktstipendiaten. Sehr dankbar bin ich Cordula Epple, die mir problemlos ein Zimmer in Vilmnitz zur Verfügung stellte.

Die Deutsche Bundesstiftung Umwelt (DBU) finanzierte dieses Projekt im Rahmen des Stipendenschwerpunktes „Die südliche Ostsee und ihre Küsten im Wandel“. Vielen Dank dafür.

Lebenslauf

Name Bobsien
Vorname Ivo Christian

Persönliche Daten

Geburtsdatum 06.10.1963
Geburtsort Bad Schwartau
Staatsangehörigkeit deutsch

Schul-, Berufs- und Hochschulausbildung

1970-1974 Grundschule, Fleckeby
1974-1980 Gudewerdt Realschule, Eckernförde
1980-1984 Ausbildung zum Erzieher, Schleswig
1984-1986 Zivildienst, Schule für Körperbehinderte, Damp
1986-1989 Berufstätigkeit als Erzieher, Schleswig
1998-1991 Ausbildung zum Umweltschutztechnischen Assistenten,
Bückeberg
1991-1994 Allgemeine Hochschulreife, Minden
1994-2001 Biologie (Diplom), Universität Kiel, Hauptfach:
Fischereibiologie, Nebenfächer: Zoologie, Meereschemie
2001-2006 Promotion im Fach Zoologie, Thema: „The role of small fish
species in eelgrass food webs of the Baltic Sea”

Erklärung

Hiermit erkläre ich, dass ich die vorliegende Dissertation selbstständig verfasst und keine anderen als die angegebenen Hilfsmittel verwendet habe. Ebenfalls versichere ich, dass die Arbeit nach Form und Inhalt meine eigene Arbeit ist. Sie wurde keiner anderen Stelle im Rahmen eines Prüfungsverfahrens vorgelegt. Dies ist mein einziges und bisher erstes Promotionsverfahren. Des Weiteren erkläre ich, dass ich Zuhörer bei der Disputation zulasse.

Kiel, den 22.03.2006.....

Ivo Christian Bobsien