

**Hankering back to ancestral pasts:  
constraints on two pinnipeds,  
*Phoca vitulina* & *Leptonychotes weddellii*  
foraging from a central place**



**Nikolai S. Liebsch**

**Mai 2006**



**Hankering back to ancestral pasts:  
constraints on two pinnipeds,  
*Phoca vitulina* & *Leptonychotes weddellii*  
foraging from a central place**

Dissertation  
zur Erlangung des Doktorgrades  
der Mathematischen-Naturwissenschaftlichen Fakultät  
der Christian-Albrechts-Universität  
zu Kiel

Vorgelegt von

**Nikolai S. Liebsch**

Kiel / Swansea

**Mai 2006**





Referent/in: Prof. em. Dr. D. Adelung

Korreferent/in: Prof. Dr. M. Spindler

Tag der mündlichen Prüfung: 06. Juli 2006

Zum Druck genehmigt: Kiel, den .....

Der Dekan



# Table of Contents

<b><u>ABSTRACT</u></b>	<b><u>1</u></b>
<b><u>ZUSAMMENFASSUNG</u></b>	<b><u>3</u></b>
<b><u>CHAPTER 1 INTRODUCTION</u></b>	<b><u>7</u></b>
<b><u>CHAPTER 2 MATERIALS AND METHODS</u></b>	<b><u>10</u></b>
<b><u>2.1 STUDY ANIMALS, SITES &amp; PROJECTS</u></b>	<b><u>10</u></b>
2.1.1 HARBOUR SEALS - NORTH SEA – MINOS	10
2.1.2 WEDDELL SEALS - WEDDELL SEA - ANT XXI/2	12
<b><u>2.2 DEVICES</u></b>	<b><u>15</u></b>
2.2.1 THE DEAD-RECKONERS	15
2.2.2 THE SATELLITE TRANSMITTER	18
2.2.3 THE IMASEN (INTER-MANDIBULAR ANGLE SENSOR)	19
2.2.4 THE RELEASE MECHANISM	21
2.2.5 THE HOUSING AND ATTACHMENT	22
<b><u>2.3 PRELIMINARY TRIALS ON CAPTIVE ANIMALS</u></b>	<b><u>25</u></b>
2.3.1 IMASEN TRIALS	25
2.3.2 ATTACHMENT TRIALS	26
<b><u>2.4 DEPLOYMENT AND RECOVERY OF THE DEVICES IN FREE LIVING SEALS</u></b>	<b><u>28</u></b>
2.4.1 DEVICE PROGRAMMING	28
2.4.2 CAPTURE AND IMMOBILISATION	29
2.4.3 DEVICE ATTACHMENT & RECOVERY	31
<b><u>2.5 TREATMENT OF COLLECTED DATA</u></b>	<b><u>34</u></b>
2.5.1 DIVE ANALYSIS	34
2.5.2 MOVEMENT ANALYSIS	35
2.5.3 FEEDING ANALYSIS	44
2.5.4 DATA MERGING	45
2.5.5 PSEUDO- AND OVER- REPRESENTATION	45
<b><u>CHAPTER 3 RESULTS AND GENERAL INTERPRETATION</u></b>	<b><u>46</u></b>

<b>3.1 HARBOUR SEALS - NORTH SEA – MINOS</b>	<b>46</b>
3.1.1 AREA USE	47
3.1.2 BEHAVIOUR	52
3.1.3 IN SEARCH OF THE DEFINITION AND FUNCTION OF DIFFERENT DIVE TYPES	54
3.1.4 FEEDING	66
3.1.5 TORTUOSITY OF TRACKS: AREA INTEREST INDEX (AII)	70
3.1.6 DIVE TYPES ACCORDING TO PROPOSED FUNCTION	78
3.1.7 DIEL RHYTHMS IN DIVING BEHAVIOUR AND DEPTH EXPLOITATION	83
<b>3.2 WEDDELL SEALS - WEDDELL SEA - ANT XXI/2</b>	<b>86</b>
3.2.1 AREA USE	86
3.2.2 BEHAVIOUR	88
3.2.3 IN SEARCH OF THE DEFINITION AND FUNCTION OF DIFFERENT DIVE TYPES	89
3.2.4 FEEDING	96
3.2.5 TORTUOSITY OF TRACKS: AREA INTEREST INDEX (AII)	98
3.2.6 DIVE TYPES ACCORDING TO PROPOSED FUNCTION	102
3.2.7 DIEL RHYTHMS IN DIVING BEHAVIOUR AND DEPTH EXPLOITATION	107
<b>CHAPTER 4 DISCUSSION</b>	<b>108</b>
<b>4.1 DEVICE EFFECTS</b>	<b>108</b>
<b>4.2 ERRORS &amp; LIMITATIONS</b>	<b>108</b>
4.2.1 ERRORS IN DEAD-RECKONING	108
4.2.2 LIMITATIONS OF THE IMASEN	113
<b>4.3 UTILITY OF THE IMASEN</b>	<b>114</b>
<b>CHAPTER 5 SYNTHESIS</b>	<b>117</b>
<b>5.1 ECONOMIC STRATEGIES</b>	<b>118</b>
5.1.1 DIVE EFFICIENCY	118
5.1.2 FORAGING RANGE	122
5.1.3 INTEGRATED EFFICIENCY	123
<b>5.2 GENERALIZED MODEL</b>	<b>128</b>
<b>BIBLIOGRAPHY</b>	<b>133</b>
<b>TABLES</b>	<b>145</b>

**ACKNOWLEDGEMENT**

---

**149**

ERKLÄRUNG

151



# Abstract

Pinnipeds show huge inter-specific variability in the lengths of time that they spend on land and at sea over the year and consequently in the range over which they forage. The reasons for the inter- and intra-specific variability are not immediately obvious although each species-specific strategy presumably represents an idealized solution which integrates maximized energy acquisition at sea with optimized time spent at the haul-out site. Foraging behaviour, divided into transit time spent commuting between the haul-out site and foraging zone, as well as the transit between the water surface and the hunting depths once the animals are in the foraging zone, is liable to play a key role in this. This thesis examines the foraging behaviour of two pinniped species, the harbour seal *Phoca vitulina* and the Weddell seal *Leptonychotes weddellii* in order to tease out the precise factors that modulate the length and duration of foraging trips compared to haul-out periods. Methodological advances in technology are developed and tested to achieve this.

Dead-reckoning principles contained within an archival tag were used to examine the fine-scale movement of animals underwater and, via consideration of the logged parameters, to determine how animals divided their time into various activities and how these were related to locality. The location of feeding behaviour was determined by using the dead-reckoner in conjunction with an inter-mandibular angle sensor (IMASEN).

Consideration of time allocated to various phases of the dives conducted, together with the data on animal speed, pitch and roll indicated that harbour seals have specific travelling dives, prospecting dives, prey-searching dives and sleeping dives. Apart from the sleeping dives, these are also mirrored by Weddell seals. Track tortuosity, which is believed to correlate with prey searching behaviour, was highest in water deeper than 10 m and starting at distances of 20 km from the haul-out site for harbour seals. This concurred with seal density and allowed identification of the most important foraging sites for this species in the study area. Weddell seals foraged directly beneath their haul-out sites on the ice

and therefore had no variable tortuosity in their tracks that could be allocated to horizontal travel between foraging and haul-out sites.

Based on these parameters, the total time spent in a single foraging plus haul-out cycle could be subdivided into time allocated to active prey searching (which only occurs during the bottom phase of the dives) and 'other' time, which comprises time at the haul-out site plus time associated with travel between the foraging site and the haul-out site. A measure for foraging efficiency is proposed consisting of the total time allocated to searching for prey divided by the total time spent in one foraging plus haul-out cycle. Pinnipeds that are very efficient presumably need high prey densities at their foraging site so that the inverse of this efficiency gives a rough measure of a time-based 'prey- acquisition ration' (PAR). This index was modelled using data gained from the two seal species to examine how the extent of horizontal and vertical travel (representing proximity to prey and depth distribution of prey, respectively) modulates the PAR so that, ultimately, consideration of real prey density coupled with variation in PAR as a function of prey proximity determines where seals can feed. The trends illustrate that pinnipeds become most efficient when they spend as much time as possible at sea.



# Zusammenfassung

Innerhalb der Familie der Pinnipedia liegt eine große inter- und intraspezifische Variabilität bezüglich der Zeiteinteilung vor, die die Tiere im Verlaufe eines Jahres an Land bzw. auf See verbringen. Daraus ergibt sich ein breites Spektrum an Entfernungen, die einzelne Robben zum Nahrungserwerb zurücklegen. Die Gründe für diese inter- und intraspezifischen Unterschiede sind jedoch nicht sofort ersichtlich. Man kann davon ausgehen, daß es sich bei Art-spezifischen Strategien um ein angepasstes Verhalten handelt, das den Nahrungserwerb auf See bei gleichzeitiger Optimierung der Ruhezeit an Land maximiert. Betrachtet man die gesamte, für den Nahrungserwerb zur Verfügung stehende Zeit im Verhältnis zur Transitzeit zwischen Ruheplatz und Jagdgründen und der Zeit zwischen dem Aufenthalt an der Wasseroberfläche und in der Jagdtiefe, so spielen diese Beziehungen offensichtlich eine wichtige Rolle.

Die vorgelegte Arbeit untersucht das Jagdverhalten von zwei Pinnipedier-Arten, dem Seehund *Phoca vitulina* und der Weddellrobbe *Leptonychotes weddellii*, in Bezug auf Faktoren, die die zurückgelegten Strecken und die Dauer von Jagdbeutezügen im Verhältnis zu den Ruhezeiten bestimmen. Um dieser Fragestellung gerecht zu werden, wurden methodische Fortschritte in der Telemetrietechnik entwickelt und getestet.

Zur feinskaligen Analyse der Bewegungen der Tiere unter Wasser wurde das Prinzip der Koppelnavigation in einen Datenlogger (Fahrtenschreiber) inkorporiert. Anhand der aufgezeichneten Parameter galt es herauszufinden, wie viel Zeit die Tiere mit unterschiedlichen Aktivitäten verbringen und wo diese stattfinden. Um Gebiete zu identifizieren, die dem tatsächlichen Beuteerwerb dienen, wurde der Fahrtenschreiber zusammen mit einem Maul-Sensor (**Inter-Mandibular Angle SENS**or = IMASEN) verwendet.

Die zeitliche Gliederung eines Tauchganges, zusammen mit Informationen über Schwimmgeschwindigkeit als auch frontalem und lateralem Neigungswinkel, zeigten, dass Seehunde spezifische Reise-, Erkundungs-, Nahrungssuch- und Schlaftauchgänge vollziehen. Abgesehen von den

Schlaftauchgängen traten sehr ähnliche Verhaltensweisen auch bei den Weddellrobben auf.

Ein hohes Maß an gewundenen Bewegungen im Verlauf der Schwimmstrecke wird als Indiz für aktive Beutesuche angesehen und war bei den Seehunden am intensivsten in Gebieten mit einer Wassertiefe von mindestens 10 Metern und in einer Entfernung von mindestens 20 Kilometern von ihrem Ruheplatz zu finden. Dies stimmt mit der größten Aufenthaltsdichte überein, die damit auf wichtige Nahrungsgebiete für diese Spezies im Untersuchungsgebiet hinweist.

Im Gegensatz dazu nutzten die Weddellrobben zum Nahrungserwerb die Gewässer direkt unter ihrem Ruheplatz auf dem Eis und zeigten daher keine Unterschiede in der Gewundenheit ihrer Bewegungen, die mit horizontalem Transit in Verbindung gebracht werden konnten.

Basierend auf diesen Erkenntnissen kann ein Beutezugzyklus, bestehend aus einem Beutezug und nachfolgender Ruhephase, unterteilt werden in die Zeit, die mit aktiver Beutesuche verbracht wird (was nur in der Bodenphase von Jagdtauchgängen möglich ist) und ‚sonstiger‘ Zeit, die sich sowohl aus der Ruhephase an Land als auch aus horizontalem und vertikalem Transit zusammensetzt.

Als Maß für die Effizienz des Nahrungserwerbes wird der Quotient aus der Zeit, die mit der aktiven Nahrungssuche verbracht wird und der Dauer des Beutezugzyklus vorgeschlagen. Die invertierte Effizienz hingegen kann als ein Maß für ein zeit-bezogenes ‚Beute-Erwerbs-Verhältnis‘ (‚prey-acquisition ratio‘ = PAR) hergenommen werden, welches eine Aussage trifft über die nötige Beutedichte im Jagdrevier, um die in Abhängigkeit von der Entfernung zum Ruheplatz entstehenden energetischen Ausgaben zu decken. Basierend auf Daten der beiden Robbenarten wurde dieser Index (PAR) anhand eines Modells dargestellt. Untersucht wurde, in wieweit horizontaler und vertikaler Transit, der die Nähe zur Beute und deren vertikale Verteilung in der Wassersäule repräsentiert, Einfluss auf das PAR nehmen. Die Arbeit zeigt, dass effiziente Jagdgründe für Robben auf der Grundlage der tatsächlichen Beutedichte in

Abhängigkeit der Veränderung des PAR als Funktion der Nähe zur Beute bestimmt werden können. Die Ergebnisse machen deutlich, dass das effizienteste Verhalten für Robben darin besteht, so lange Zeit wie möglich am Stück auf See zu bleiben.



# Chapter 1 Introduction

An inevitable consequence of animals that favour particular areas for non-feeding activities is that they must forage within a defined radius around the location. The concept of working around a 'central place' was first formalized by Orians & Pearson (1979) and has since become a major factor that explains much of the overall foraging behaviour of offspring-provisioning by mammals and birds (e.g. Jackson et al., 2001; Leopold et al., 1996; Markman et al., 2004). More recently, it has also been applied to any situation where animals must consistently return to any one spot, such as in air-breathing, diving animals, which are tied to the water's surface, from which they make forays underwater to acquire prey (Staniland & Boyd, 2003; Page et al., 2005).

Pinnipeds, which comprise the world's true seals (phocids) and eared seals (otariids), are all central-place foragers. All species forage by diving from the water's surface, and return to a central place on land both to moult and breed, with most species regularly attending haul-outs even outside the breeding or moulting seasons for reasons that are not clear (McConnell pers. comm.). In addition, pinnipeds show huge inter-specific variability in the lengths of time that they spend on land and at sea over the year and consequently in the range over which they forage. Fur seals, for example, spend hours to days at sea between haul-outs (Goldsworthy & Shaughnessy, 1994; Kerley, 1983) while some phocid seals, such as elephant seals only come ashore twice a year, with periods at sea of more than 9 months (Hindell et al., 2002). The reasons for the inter- and intra-specific variability are not immediately obvious although it is reasonable to suppose that each species-specific strategy represents an idealized solution which integrates maximized energy acquisition at sea with optimized time spent at the haul-out site (Mueller, 2004; Wilson et al., 2005). Foraging behaviour, divided into transit time spent commuting between the haul-out site and foraging zone, as well as the transit between the water surface and the hunting depths once the animals are in the foraging zone, is liable to play a key role in this.

This thesis examines the foraging behaviour of two pinnipeds, the harbour

seal *Phoca vitulina* and the Weddell seal *Leptonychotes weddellii* in order to tease out the precise factors that modulate the length and duration of foraging trips compared to haul-out periods. Harbour seals inhabit the temperate coastal zones of the northern hemisphere (Burns, 2002) using sandbanks and islands as haul-out areas and making forays to sea lasting between 17 and 257 hours (Thompson et al., 1998), which take them tens of km away where they seldom dive to depths in excess of 100 m (Krafft et al., 2002). Weddell seals are strictly confined to the ice areas of Antarctica (Thomas, 2002) where they search for prey in the immediately-adjacent waters and during which time they commonly dive to depths in excess of 250 m (Davis et al., 2003; Watanabe et al., 2003). The central place foraging strategies of these two species are considered in detail using state-of-the-art logging technologies and, as far as possible, species-specific limitations defined before being put in a general context in an attempt to understand the factors that modulate foraging and haul-out areas in pinnipeds.

Classically, such studies are conducted using satellite-tracking technology (e.g. Weimerskirch et al., 1993) but this approach is known to present biases in time contributions to area use (e.g. Hull et al., 1997; Taillade, 1992), so the approach was to use newly-developed dead-reckoning technology to determine position. Dead-reckoning uses the vectors involved in animal movement to reconstruct the travelling routes in 3-dimensions (cf. Mitani et al., 2003; Wilson & Wilson, 1988) and therefore has no inherent bias related to satellite accessibility dependent on surface occupancy by the equipped animals (e.g. Bost et al., 1997). It is, however, subject to errors due to drift (Wilson et al., 2002) and measures, which include ground truthing from satellite-derived positions, have to be taken to mitigate against this.

For the first time in pinnipeds, the newly developed IMASEN (Inter-mandibular Angle Sensor; Wilson et al., 2002) was deployed on free-ranging animals to record actual feeding events. The system is based on a Hall sensor, perceiving magnetic field strength from a rare-earth magnet (Hall, 1879). Magnetic field strength, decreasing with increasing distance from the magnet, can therefore be used to record changes in jaw-opening angle when the sensor

and magnet are attached to the upper and lower jaw, respectively (Liebsch, 2002).

# Chapter 2 Materials and Methods

## 2.1 Study animals, sites & projects

The present study was conducted on two species of phocid seals, living in completely different environments, as part of ongoing research in food-web and ecological impact studies.

### 2.1.1 Harbour seals - North Sea – MINOS

The harbour seal, *Phoca vitulina* (Phocines, Phocidae, Pinnipedia) is the most common seal species in the north Atlantic and north Pacific (and therefore also called 'Common seal') and inhabits a variety of coastal and insular habitats such as sandbanks, beaches, estuaries and rocky or icy shores. It still depends on land to haul-out, breed and moult, like all other pinnipeds but is non-migratory. Harbour seals are generally considered to be opportunistic inshore or shallow water hunters, but can reach depths exceeding 500 m (Burns, 2002) and dive up to 31 minutes (Ries et al., 1997). Newborn pups vary in size between 70 - 90 cm and 9 - 11 kg, whereas adult males grow up to 170 cm and 120 kg and adult females grow up to 155 cm and 80 kg. The females become sexually mature between 2 - 5 years, the males between 3 - 6 years and a maximum age around 40 years (mean: 15 – 25 years) can be expected (FAO, 1979). Most of the annual births take place between May and August, depending on distribution area, after a gestation period of 10.5 - 11 months, followed by 4 - 6 weeks of lactation. The annual moult occurs over the 2 - 3 months following the pupping season. Harbour seal fur, consisting of only one layer of short hair, is usually spotted with dark brown spots on a lighter, greyish ground. But colouration and shape and size of spots can vary considerably (Bigg, 1981) (Fig. 1).

The North Sea, situated on the continental shelf of north-west Europe, is a relatively shallow Sea of the Atlantic Ocean. Especially the southern part (mainly the Southern and the German Bight) is shallower than 50 m with predominantly

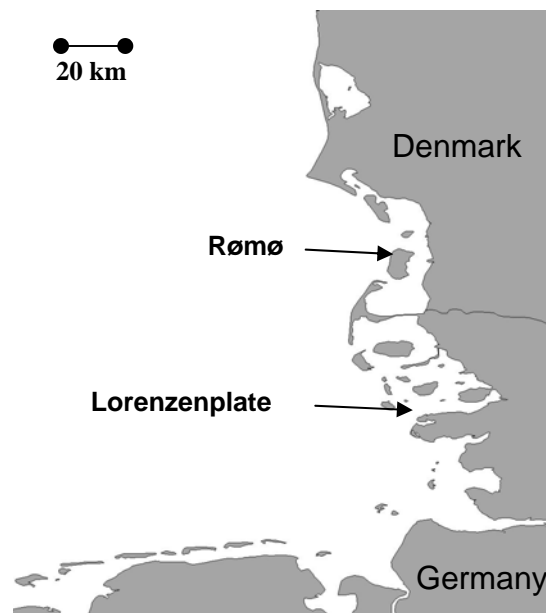




**Figure 1.** Harbour seals (*Phoca vitulina*).

muddy and sandy sediment (Ospar, 2005). A unique coastal habitat extends in the south-eastern corner of the North Sea, from Den Helder (Netherlands) until Blavandshuk (Denmark), the so-called Wadden Sea (CWWS, 2005). It is typified by extensive tidal mud flats, deeper trenches and many islands that are contained within.

The aim of the MINOS (2002 - 2004) and MINOS+ (2004 - 2007) projects is to determine the area-use by Harbour seals stemming from Helgoland (an offshore island in the German Bight; 54° 11' N, 7° 55' E), the Lorenzenplate (a sandbank north of the Eiderstedt peninsula in the German Wadden Sea; 54° 26' N, 8° 38' E) and Rømø (an island in the south-west of Denmark; 55° 12' N, 8° 31' E) (Fig. 2) using the most appropriate method possible and how this might interfere with the construction of designated



**Figure 2.** Tagging sites in the Wadden Sea during the MINOS project; the island of Rømø (55° 12' N, 8° 31' E) in south-western Denmark and the sandbank Lorenzenplate (54° 26' N, 8° 38' E) north of the Eiderstedt peninsula.

wind parks. Since standard line transects of seals at sea are subject to a large variety of errors (Kiess, 2004; Trost, 2004), the approach used was based on using animal-attached packages which enable elucidation of a number of aspects of seal foraging ecology, including area use. The analysis of seal area-use extends from simple position to determination of the various animal behaviours exhibited (as determined by the systems used, including feeding) and allocation of these behaviours to the relevant localities.

#### 2.1.2 Weddell seals - Weddell Sea - ANT XXI/2

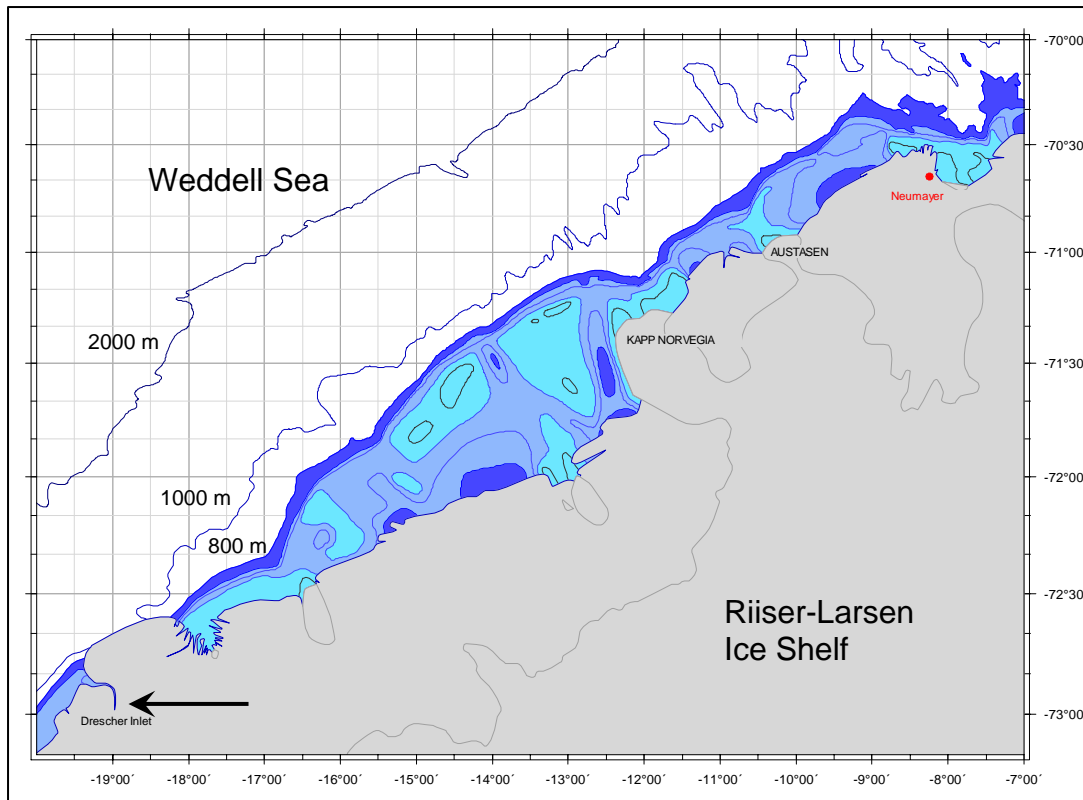
The Weddell seal, *Leptonychotes weddellii* (Lobodontines, Phocidae, Pinnipedia) is the second most abundant circumpolar seal species throughout Antarctica (Thomas, 2002). The fast-ice region they inhabit provides a secure platform to haul-out, give birth and wean. Weddell seals are extremely good divers and depths visited around 600 m (maximum depth 726 m; Schreer & Testa, 1996) are common and dives can last up to 82 minutes (Thomas, 2002). These animals predominantly prey on fish like *Pleuragramma*, but Antarctic Cod (*Dissostichus mawsoni*) and squid have also been reported (Plotz pers. comm.). Exploiting coastal shelf waters, which are largely covered by fast ice, Weddell seals follow the growth and decay of the ice during the annual cycle. Only occasionally are they seen at the sub-Antarctic islands or even further north in areas like Australia and Argentina. Weddell seals exhibit only a slight sexual dimorphism, with the males reaching 250 - 290 cm and females 260 - 330 cm and masses of up to 500 kg for pregnant females. Pups are born around 150 cm long and weigh about 22 - 29 kg. Pupping starts in late September and ends in early November, followed by a nursing period of 7 to 8 weeks. Once the pups are weaned, mating takes place, followed by the annual moult (Thomas, 2002) (Fig. 3).

The Weddell Sea, the main source of the world ocean's bottom water (AWI, 2005), forms part of the Southern and Atlantic Ocean. In the west, the Antarctic Peninsula forms one boundary, adjacent to the Filchner–Ronne Ice Shelf in the south and the Riiser–Larsen Ice Shelf at its eastern border.



**Figure 3.** Weddell seal *Leptonychotes weddellii* at the Drescher Inlet, Antarctica.

Much of the southern part is permanent ice. The Drescher Inlet ( $72^{\circ} 52' S$ ,  $19^{\circ} 26' W$ ), a 25 km long crack in the Riiser–Larsen Shelf Ice, is situated on the eastern Weddell Sea coast (Fig. 4). The water depth varies between around 400 m inside the inlet, down to below 1800 m in front of the mouth of the inlet, where



**Figure 4.** The Drescher Inlet (arrow), eastern Weddell Sea, Antarctica ( $72^{\circ} 52' S$ ,  $19^{\circ} 26' W$ ).

the continental shelf drops down (Hydrosweep ANT X/2).

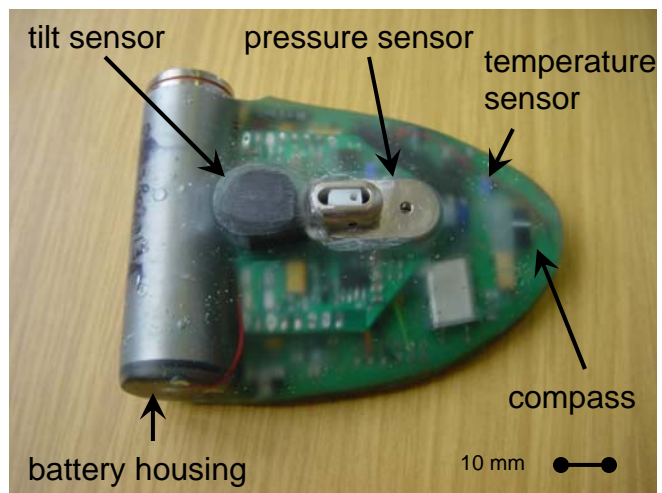
During a previous summer study (EASIZ II, Feb.1998) at the Drescher Inlet a joint seal-fisheries study showed that during a period of intensive ice break-up Weddell seals exhibited a diurnal pattern in foraging depths. Day and night trawling confirmed that in these depth layers planktivorous *Pleuragramma antarcticum* were by far the most abundant fish, even though by night its abundance was highly variable (Plotz et al., 2001). The spring campaign (4 Dec. 2003 - 3 Jan. 2004) as part of the 2003/2004 EASIZ cruise (ANT XXI/2) of the RV 'Polarstern' continued the investigations on predator-prey relationships in a season that is characterized by unbroken ice and permanent daylight. The scientific objectives were: (1) to examine the use of Weddell seals as collectors of visual information on the vertical distribution of zooplankton, krill and fish; (2) to measure the seal dive depths and feeding events simultaneously; (3) to study the relation between seal diving performance and the diurnal vertical distribution of its principal prey as well as hydrographic features in the fast-ice environment; (4) to investigate temporal changes in the local abundance of *P. antarcticum* and other fish species; (5) to characterize and quantify the role of copepods, amphipods and krill as a potential food source for planktivorous fish.

## 2.2 Devices

Even though, the two projects involved in this study wanted to answer different questions, they were using the same methodological approach by using remote sensing devices.

### 2.2.1 The dead-reckoners

The dead-reckoner (140 g, 90 x 65 x 28 mm, Fig. 5) consisted of a multi-channel logger capable of storing up to 32 mbytes of data in a flash RAM with 16 bit resolution at sampling intervals of between 1 s and 24 h (Driesen und Kern GmbH, Germany). The unit was potted in resin, which incorporated a titanium turned battery housing containing 2 X

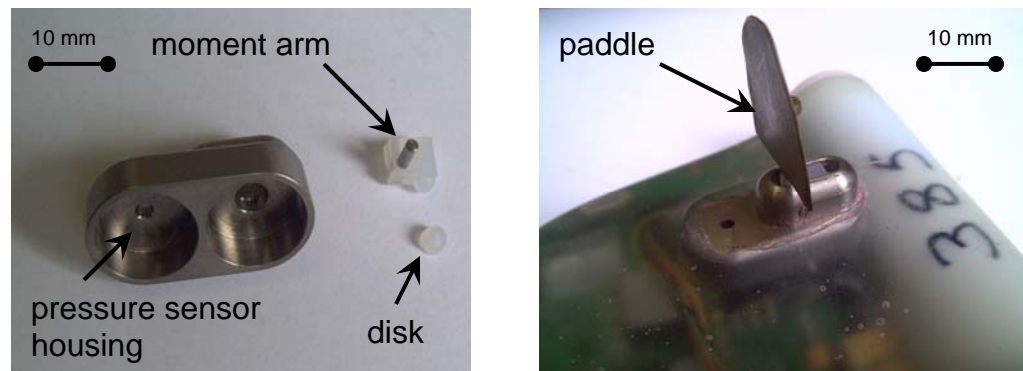


**Figure 5.** The dead-reckoner from Driesen und Kern, capable of recording 12 different channels.

3.6 V Saft Lithium cells (SAFT, Bagnole, France) as well as an infra-red interface for communication with a computer. Depending on the different configurations of the dead-reckoners (which had been further improved during this study), they could be connected to the following sensors:

- Depth (1 channel): This was sensed by a medium-separated Keller 10 bar (harbour seals) or 50 bar (Weddell seals) pressure sensor (Keller, Germany) and corrected for temperature effects via integration with a temperature sensor (see Temperature 1 internal below). Nominal accuracy gave a resolution of better than 2 cm water depth.
- Speed (1 channel): This was also sensed by a medium-separated

Keller 10 or 50 bar pressure sensor (Keller, Germany) and corrected for temperature effects via integration with a temperature sensor (see Temperature 1 internal below). However, in this application, the sensor was placed immediately adjacent to the depth sensor so that it recorded both hydrostatic pressure as well as speed. The speed component was sensed by having a paddle (~ 20 x 20 mm) protruding into the water column, leading at its proximal end to an axle, and a moment arm (~ 3 mm - leading away at 90° to the original paddle arm - Fig. 6) which terminated in a ball and socket arrangement so that the



**Figure 6.** The paddle arm system used for the speed measurement.

socket, which consisted of a small disk ( $\text{Ø } 3 \times 1.5 \text{ mm}$ ), rested on the membrane of the pressure transducer. Thus, forward speed produced a force on the paddle, which was transferred via the moment arm onto the membrane on the pressure transducer. For details of this system see Wilson et al. (2004). The transducer recorded the sum of the pressure due to hydrostatic pressure and that due to the force generated by swimming. Subtraction of the output of depth from this channel output (see above) produced an output corresponding to speed. The calibration for speed could be carried out on the animal by consideration of the sensor output in relation to speed calculated using dive (or return-to-surface) angle in relation to rate of change of depth for periods where there was an appreciable rate of change of depth (see later). This is a refinement of the method suggested by Blackwell

et al. (1999) and accords with that used by Mitani et al. (2003) and Sato et al. (2003).

- Heading (3 channels): Heading was determined using a solid-state compass (Honeywell, USA) which resolved the 3 components of the earth's magnetic field into vectors according to the known orientation of the sensor (determined by the body orientation with respect to gravity - see below). The procedure for doing this is detailed in Caruso (2000). This gives a resolution of better than 1° in animal heading.
- Body orientation with respect to gravity (2 channels): An angle-sensing system (VTI, Sweden) was used here, which was so orientated within the package that it resolved pitch and roll, both within the range +90 to -90°, to within 1° after calibration. In order to determine when the animal was swimming or lying on its back, which led to the system giving spurious results, consideration of the output of this sensor had to be combined with the mercury orientation switch (see below).
- Body position (inverted or otherwise) (1 channel): For technical reasons the pitch/roll sensors (see above) were unable to determine body angles exceeding 90° from the horizontal. Thus, an animal swimming on its back, could not be perceived as such by the sensors. For this reason a single channel was devoted to determining whether the device (seal) was inverted or not. The sensor for this was based on a mercury switch and although rather primitive (on or off) it was more than adequate for us to resolve the issue.
- Temperature 1 (internal) (1 channel): In order to correct for temperature-related inconsistencies in pressure transducer outputs, the dead-reckoner had a PT 1000 (Heraeus, Germany) temperature sensor placed directly adjacent to the pressure sensor. This sensor enables temperatures to be measured to 0.03° C accuracy. Correction of the pressure and speed values occurred in the software after the data had been accessed by the computer.
- Temperature 2 (external) (1 channel): This sensor, also a PT 1000

(Heraeus, Germany) was used to measure ambient water/air temperature. Although it measured temperature to within 0.03° C (absolute accuracy) and was placed close to the surface of the logger, it suffered considerable lag due to the thermal inertia of the logger itself. This had to be borne in mind when data were assessed.

- Light 1 (red wavelengths) (1 channel): This sensor, from Tropas (Tropas, USA) measured red light intensity within the range ca. 0.01-100,000 lux (absolute daylight wavelength values) to the nearest 2 lux. As expected, it was highly sensitive to orientation (although this could be corrected by consideration of sun angle with respect to animal/logger angle) and thus values should be taken as approximate.
- Light 2 (blue wavelengths) (1 channel): This sensor, from Tropas (Tropas, USA) was covered with a Schott blue filter (BG-28) and thus measured blue light intensity within the range ca. 0.01-100,000 lux (absolute daylight wavelength values) to the nearest 2 lux. It was highly sensitive to orientation (although this could be corrected by consideration of sun angle with respect to animal/logger angle) and thus values should be taken as approximate.

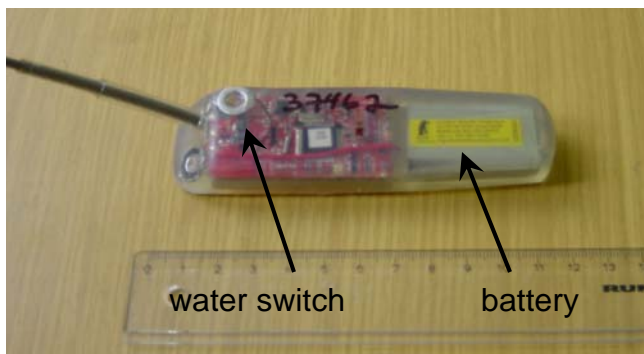
Over time, different versions of the dead-reckoner became available with different channel and memory configuration. During the first part of the MINOS project, a 12 channel logger was used with all the channels mentioned above and an 8 MB memory. Later, during the follow up project MINOS+, the channel configuration was reduced to 10 by leaving out the external temperature sensor and one light sensor. At the same time the memory capacity was increased to 32 MB. During the Antarctic cruise, a 12 channel 32 MB version was used on the Weddell seals.

### 2.2.2 The satellite transmitter

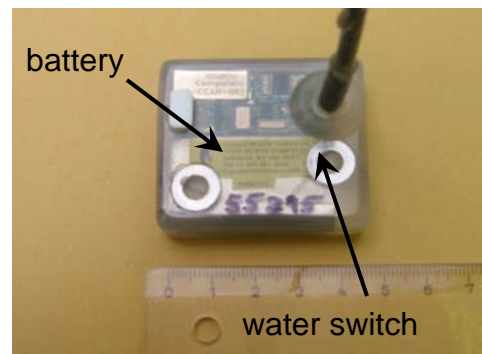
The satellite transmitters (also known as PTT - Platform Terminal Transmitters) are termed as the SPOT 2 and 3 models, produced by Wildlife



Computers (Richmond, USA). They could be programmed to send off a certain number of transmissions per day, only transmitting on certain hours, days and months during the deployment period and when the water switch was dry. Details of the system are given in ([www. Wildlifecomputers.com](http://www.Wildlifecomputers.com)).The SPOT 2 (mainly used during MINOS) weighed 85 g (110 x 32 x 15 mm) (Fig. 7) and was powered by a 3 V M3 Lithium battery, whereas the SPOT 3 (mainly used during MINOS+) weighed 45 g (48 x 42 x 14 mm) (Fig. 8) and was powered by a 3 V M1 Lithium battery.



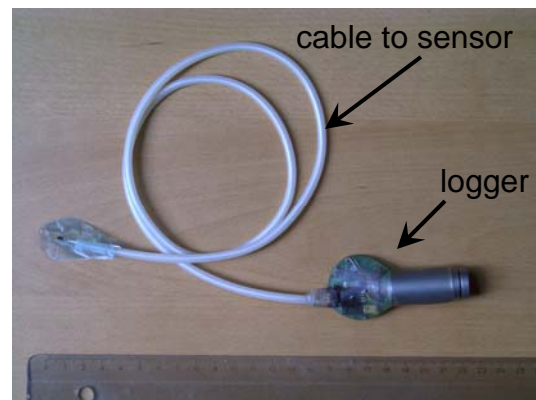
**Figure 7.** The satellite transmitter (PTT) SPOT2-tag from Wildlife Computers.



**Figure 8.** The satellite transmitter (PTT) SPOT3-tag from Wildlife Computers.

### 2.2.3 The IMASEN (Inter-mandibular Angle Sensor)

In this study, two different versions of the IMASEN (Driesen und Kern GmbH, Bad Bramstedt, Germany) were deployed. On the harbour seals, a resin-embedded single channel logger with 8 MB flash RAM, 16 bit resolution, with maximum dimensions of 73 x 33 x 19 mm and a weight of 35 g in air (Fig. 9) was used. The Hall sensor (6 x 3 x 2 mm, KSY 10, Siemens GmbH, Germany) was also coated in resin and connected to the logger by a 4-strand

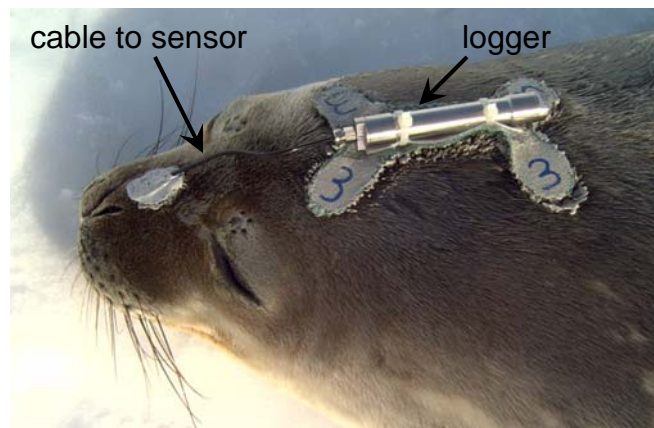


**Figure 9.** The in resin embedded Inter-Mandibular Angle Sensor (IMASEN) used on the harbour seals, showing the cable linking the Hall sensor to the logging unit.

cable and a plug (see Wilson et al., 2002 and later for details).

On the Weddell seals, a slightly different version was used where the circuit board and battery were housed in a titanium cylinder (140 x 20 mm) with the cable exiting at one end via an O-ring seal. The cylinder was filled with silicon oil to negate problems with hydrostatic pressure on air spaces via a special, O-ring-sealed opening. The logger had a 16 MB flash memory, 16 bit resolution and a weight in air of 86 g (Fig. 10). The cable and sensor were identical to the one described above.

Both IMASEN units could be set to sample at frequencies of up to 30 Hz. The Hall sensor produced an output proportional to magnetic field strength intensity so that the proximity of a magnet could be well defined. In my application, a slightly-bent neodymium boron magnet (30 x 25 x 3 mm, Vacuumschmelze GmbH and Co, Hanau, Germany) was placed under the seal's lower jaw, behind the mandibular symphysis while the Hall sensor was placed on top of the upper mandible, behind the nose (Fig. 10) so that, after suitable calibration, jaw angle could be determined to allow examination of feeding behaviour (see Liebsch, 2002; Simeone & Wilson, 2003; Wilson et al., 2002). The accuracy of the system depended critically on the placement of the magnet with respect to the sensor, but resolution of seal jaw angle to within 3 degrees was typical.



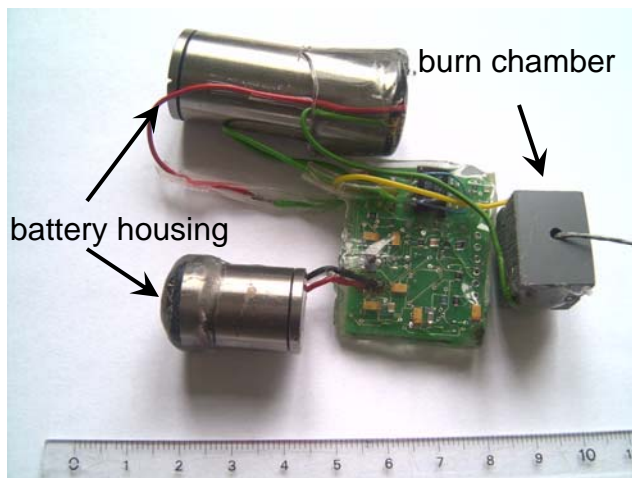
**Figure 10.** The titanium-housed Inter-Mandibular Angle Sensor (IMASEN) deployed on a Weddell seal.

## 2.2.4 The release mechanism

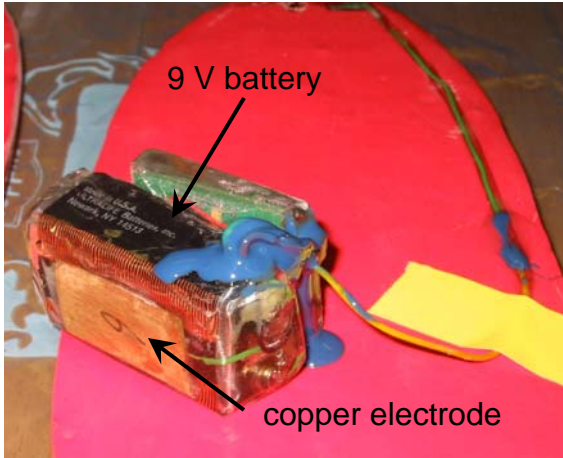
The electronic component of the release mechanism, the timer (60 g, 75 x 37 x 20 mm), consisted of a resin-encased programmable chip linked to a quartz crystal with the facility to turn on a circuit in which current flows. In an earlier version the timer was powered by a separate 3.6 V Lithium battery (in a titanium housing). A Sanyo CR123A 3 V Lithium battery (in a separate titanium housing) powered the circuit, which ultimately produced considerable heat along a defined stretch of wire inside a burn-chamber (Fig. 11). This heat was used to burn through a nylon thread holding the complete seal-attached package in place (see below) and thus release it. The unit could be programmed (via infra-red interface) to be triggered to a specified second.

To facilitate production and improve reliability, the later version of the release mechanism only had one resin-encased 9 V Lithium battery (Ultralife, USA) to power timer and circuit. Instead of the burn-chamber, the negative pole of the circuit was connected to a

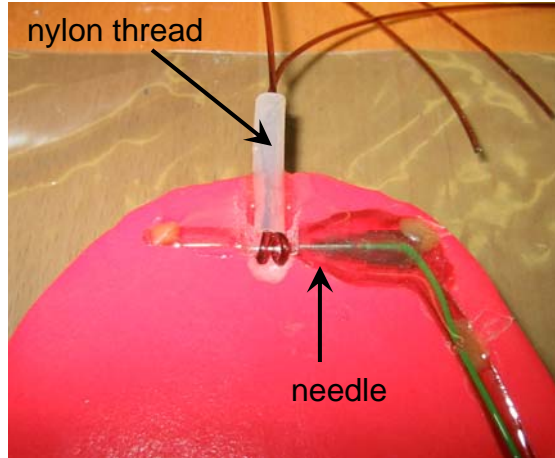
copper-electrode (attached to the side of the battery) (Fig. 12) and the positive pole to a needle, which functioned as an anchor point for the nylon thread to the package (Fig. 13). Once the circuit was closed and the seal was in the water, within 5 – 10 minutes, the needle dissolved due to electrolytic corrosion.



**Figure 11.** The timer used to release the package from the seal. The burner is shown as well as the two battery housings containing the power cells for both the burner and the timer itself.



**Figure 12.** Electronic corrosion release mechanism with copper-electrode and resin-embedded 9 V block.



**Figure 13.** Needle as an anchor point for the nylon thread to the package and the positive pole of the electronic corrosion release mechanism.

## 2.2.5 The housing and attachment

### *Floatation body & neoprene base*

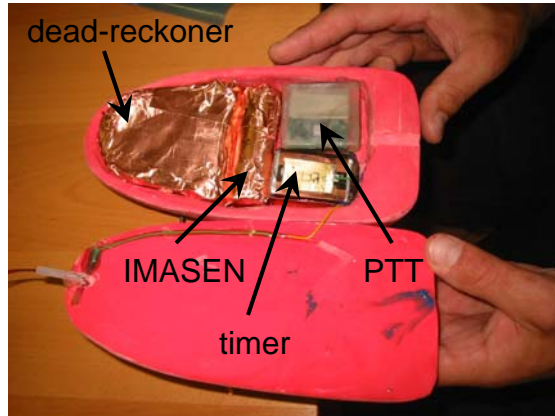
For the work carried out on Harbour seals, a method had to be used which ensured a safe attachment during long periods (of up to 3 months) and allowed self-release from the animal. As the tagged animals could not be caught a second time to retrieve the device for logistical and financial reasons, a pop-up system was used, with the devices being housed inside a positively buoyant exterior shell.

During the whole MINOS project and all autumn deployments of the MINOS+, all four elements described above were incorporated in a specially-moulded, hydro-dynamically-shaped floatation package (280 g, 210 x 90 x 65 mm) made of a 70:30 mix of resin (Glosscoat NL, VOSSCHEMIE, Germany) and glass beads (B-Spheres Gr.2, OMEGA Minerals, Norderstedt, Germany) (Fig. 14). This was slid into a neoprene pocket with 7 laterally-extending legs terminating in feet on which plastic grids (30 x 30 mm) were sewn (Fig. 15). The floatation package was held within the pocket by a nylon thread attached on one end to the anterior foot and at its other end to the timer (see above).

Due to the extended memory capacity of the devices used during MINOS+, they were able to cover the period between the spring deployments



(March – April) and the annual moult (June – August) (Burns, 2002) at a sufficient sampling frequency. Under these conditions, the release mechanism could be set aside and the flotation package shaped a little smaller (250 g, 200 x 95 x 70 mm). In addition, the neoprene base could be reduced to one layer with the 7 laterally-extending legs, attached to the underside of the package (Fig. 16).



**Figure 14.** Flotation package incorporating the dead-reckoner, IMASEN, PTT and timer.

To ensure the retrieval of the package, a label was attached to both sides of the housing with contact information and a reward note, in case it was found by beach-walkers.



**Figure 15.** The neoprene base to which the flotation body is attached. The protruding legs are stuck to the seal's fur at their ends, the contact being enhanced by grids sewn to the material.

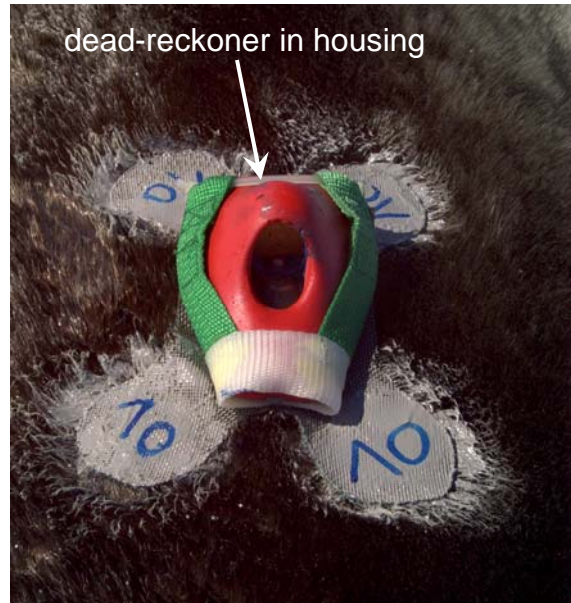


**Figure 16.** Package without release mechanism used during the spring deployments on harbour seals.

### *Gauze mat base*

Unlike the situation with the Harbour seals, the projected tagging periods for the Weddell seals were relatively short (4 - 8 days) and the animals could be recaptured to retrieve the devices. Consequently, the package needed no flotation element and single components could be attached separately on the

animals. Nevertheless, the dead-reckoners were housed in the same material described above to prevent them from mechanical damage. To attach, and easily remove, devices from the Weddell seals, a gauze mat base was used with 4 laterally-extending legs and loops into which the devices could be slid and secured with cable ties or hose clamps (Bornemann et al., 1998) (Fig. 10/17).



**Figure 17.** Dead reckoner in housing deployed on a Weddell seal with gauze mat base glued into the seal's fur at the 4 laterally-extending legs.

## 2.3 Preliminary trials on captive animals

In order to test the proper functioning of the devices itself on the animals and the way of attachment, several trials were conducted on captive harbour seals at the Seal Centre in Friedrichskoog, Germany. Under the controlled conditions there, the animals' reactions towards the devices and attachment, as well as their functioning could be observed.

### 2.3.1 IMASEN trials

The trials in July 2003 complimented previous work conducted there (Liebsch, 2002) and sought to produce a relationship between fish size and sensor output.

At the Seal Centre an adult lactating female harbour seal (*Phoca vitulina*), housed in a large pool (with ca. 280 m<sup>3</sup> of water) with underwater viewing, was trained, through the process of positive reinforcement, to be accustomed to the device-fitting process. For this the seal underwent daily training and feeding sessions, during which it learnt to position itself next to a specific target (a ball on the end of a stick) so that the technology could be attached. Attachment of the Hall sensor was complicated by seal anatomy; the head has loose jowls around the side of the mouth and the comprehensive covering of fur and generally loose skin meant that it proved difficult to select a site with minimal movement except for that involved in jaw opening. Finally, the sensor was placed on top of the nose, between nose and eyes, and the magnet under the lower jaw, behind the mandibular symphysis (Liebsch, 2002). The sites chosen were cleaned with acetone and dried off using a towel. The magnet, sensor and IMASEN (recording at 20 Hz) were glued to the fur using cyanoacrylate glue (Sekundenkleber, UHU GmbH, Germany) with the cable leading from the sensor on top of the nose between the eyes to the IMASEN which was positioned on top of the animals head.

A time check was made between the IMASEN and a digital video camera, which filmed the whole procedure, by bringing a second magnet close to the attached Hall sensor 5 times in rapid succession. This signal was recorded by the IMASEN and the camera and allowed us to ensure synchronicity between the two records. The process was repeated at the end of the experiments. Then, to allow a calibration to be constructed between jaw-opening angle and Hall sensor output, the trainer slowly opened the seal's mouth and closed it again, holding a measuring tape in front of the mouth while the process was filmed from the side.

Two separate feeding trials were conducted when herring (*Clupea harengus*) of differing sizes was fed to the seal. The size and mass of all fish were noted before single items were thrown into the water to land about 1 m away from the camera in an under-water housing, positioned in the water about 5 m away. The seal was allowed to swim to the fish to catch it, by which time the fish had generally sunk down directly in front of the camera, providing excellent side-on footage of the seal's prey handling. After ingestion, the seal turned around and returned straight to the trainer, awaiting the next event.

At the end of the trials, sensor and IMASEN were removed carefully by cutting them loose from the fur with a scalpel. The magnet came off after two days due to corrosion of the glue in salt water.

### 2.3.2 Attachment trials

After the recapture of an animal which had been tagged during a previous deployment and which was still carrying the base used to attach devices, even though it had moulted in the meantime, it became obvious, that the method described in Orthmann (2000) was inappropriate: Here, the extensive glue base had splintered and shards were perforating the seal's skin causing infection. The large glue surface (200 x 300 mm) and the inflexibility of the hardened glue caused this problem. Another material was therefore chosen (neoprene) to ensure adequate flexibility for the device housing. In addition, the glue-surface was reduced to 7 single spots, each 30 x 30 mm at the end of legs laterally-



extending from the neoprene base (see above).

A prototype of that base, with a dummy device package attached to it, was deployed on an adult male harbour seal at the Seal Centre in June 2001, well before the moult (Fig. 18). Under these controlled conditions the animal's reaction to the attachment could be observed in addition to the ease with which the unit came off within a few days, without leaving any traces.



**Figure 18.** Attachment trial of a prototype neoprene base with device dummy on a captive harbour seal at the Seal Centre in Friedrichskoog.

## **2.4 Deployment and recovery of the devices in free living seals**

### 2.4.1 Device programming

Before devices were deployed on seals the dead-reckoners were started, usually with a delayed start time, and set to record (all channels) at frequencies of once every 1 or 2 s (for the Weddell seals) and 3, 5, 15 or 20 s (for the harbour seals), depending on the memory capacity and the period over which the devices were projected to log. These recording intervals give maximum logging lives between 4 and 99 days, with the temporal resolution being directly inversely proportional to the maximum logging life.

The IMASENs have to record at minimum frequency of 5 Hz in order to be able to resolve prey ingestion events (Liebsch, 2002; Wilson et al., 2002) so all units were set to record at least at this rate which gave a maximum life of 9.3 days.

The PTTs were programmed so that they transmitted for the complete period over which the dead-reckoners were projected to log plus an additional 21 days, to allow the units to be recovered. Therefore, the allowances of maximum transmissions per day were limited between 200 and 500.

The timers were set to release at about the time the dead-reckoners were projected to be full.

Program schedules for the deployed devices are given in Table 1 (p. 145).

## 2.4.2 Capture and immobilisation

### *Harbour seals*

Seals were caught using methods described in detail by Jeffries (1993). Briefly, a small ship sailed parallel to, and about 100 m from, the coast, heading past animals lying on one side of an extensive sandbank. Bound to this ship was a smaller speed boat which, at about the time half the animals had been past,



**Figure 19.** Two boats bringing out a seine net in front of harbour seals hauling out on the sandbank Lorenzenplate.

moved quickly away in the direction it had come, dragging one end of a long seine net behind it. When the first animals encountered had been passed for the second time by the boat

moving back on its tracks, this boat moved into the sandbank (Fig. 19). At the same time the mother ship maintained its course but accelerated, dragging the other end of the net with it, and covering the second half of the animals to be captured until it then also moved quickly into the sand bank. Helpers from both craft jumped out and then pulled the net onto land, bringing the seals with it. The seals were removed from the net and put into



**Figure 20.** A harbour seal captured and restrained in a ring net.

smaller ring nets (Fig. 20) with their heads facing away from the sea awaiting attention. For the full period that the seals were on

land being treated they were continually wet with seawater to minimize thermal stress. The animals undertook a veterinary examination before being equipped with devices to ensure that they were in suitably good condition and to document their status for the records. To facilitate the attachment procedure and reduce the handling stress for the animal, they were strapped to a specially-designed bench (Fig. 21). With half the head projected over one end of the crib with the neck resting in a semi-circular hole in a slat placed in the bench, one person was sufficient to secure the animal's head while another glued the magnet and the sensor to the jaw of the animal without getting bitten. For very aggressive animals, a piece of doweling was held between the teeth of the animal and its eyes were covered with a wet towel to reduce visual stimuli (Fig. 22).



**Figure 21.** A captured harbour seal restrained on a bench with complete package glued in place.



**Figure 22.** Harbour seal restrained on a bench with doweling between its teeth and covered eyes.

### *Weddell seals*

At the time of the campaign (early spring), the inlet was completely covered with sea ice, on which the seals lay close to cracks in the ice. As they were not used to any threat while hauling out, they could be easily approached and immobilized for device attachment as described in Bornemann and Plotz

(1993) and Bornemann et al. (1998).

Briefly, from a distance, an obviously non-lactating sleeping female was chosen, with care taken not to choose an animal lying too close to the ice cracks. One person approached the animal



**Figure 23.** Darting of a Weddell seal with a blowpipe to immobilize the animal.

carefully and applied the narcotic drugs using Telinject blowpipe darts (Fig. 23). The drugs consisted of a ketamine, xylazine and hyaluronidase mixture, followed by a second shot of diazepam. Where necessary, the immobilization could be maintained, by injecting a follow-up dose of ketamine by hand. The effect of the narcotic drugs was neutralized through the antidote yohimbine (for detail see Bornemann et al., 1998).

Of the 7 animals immobilized for this work, unfortunately one animal died, presumably of asphyxia, during the procedure.

#### 2.4.3 Device attachment & recovery

##### *Harbour seals*

Initially, the site to be used for attachment of the devices was cleaned with seawater (to remove excess sand) and then cleaned and dried using acetone.



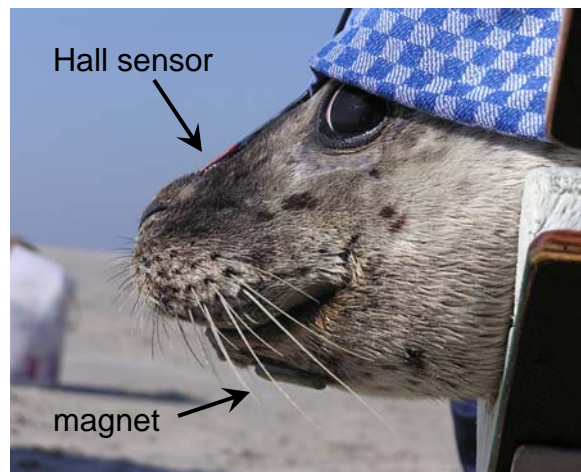
**Figure 24.** Harbour seal taking off after being equipped with the package.

The floatation body with incorporated elements was glued with Devcon epoxy (Danvers, USA). This glue was applied to the grids on the feet of the neoprene carrying pocket and the feet then held in position on the seal with the complete



package being placed on the latter third of the animal, dorsally, midline (Fig. 24) following suggestions made by Bannasch et al. (1994) to minimize hydrodynamic drag. Animals that were also to be equipped with IMASENs were held in the special bench to immobilize them (see above) and the Hall sensor glued behind the seal's nose. The connecting cable was then run directly back, between the eyes, over the back of the head and then along the length of the back to the floatation package, being glued by spots of Devcon epoxy (Danvers, USA) at intervals of about 20 cm. Finally, a single neodymium iron boron rare earth magnet (15 g, 33 x 29 x 3 mm, VACUUMSCHMELZE, Hanau, Germany) was glued to the animal's chin, approximately opposite the Hall sensor (Fig. 25).

After the release of the devices from the animals due to the annual moult or the release mechanism, the packages floated at the surface, until they were washed ashore. There, they were either located from the satellite transmissions (if the PTT was still transmitting) or they were found by people walking along the beach.



**Figure 25.** Details of the emplacement of the Hall sensor (behind the nose) and rare earth magnet (under the chin) used in the IMASEN on a harbour seals.

#### *Weddell seals*

The Hall sensors and magnets were positioned exactly as described for harbour seals (see above) while the IMASEN (set to record at either 6 or 10 Hz) was placed on top of the animals' heads by gluing the gauze mat base into the fur and attaching the loggers to it by using hose clamps. The dead-reckoners (set to record at 1 or 2 sec) were attached to the backs of the animals behind their shoulders using cable ties to bind them to the gauze mat glued into the fur. The glue used was fast-setting Araldite two-component epoxy (Ciba-Geigy

Corporation, USA) whose curing time was accelerated during cold conditions by using a hair dryer powered by a small portable generator.

To retrieve the devices, the animals were immobilized again and the IMASEN and dead-reckoner taken off by cutting the cable ties or loosening the hose clamps. As the sensor could not be removed, the cable was cut as close to the sensor as possible. Four seals were equipped more than once so, in these cases, the sensor only had to be glued on top of the previous one, while the bases could be used again to attach the IMASENs and dead-reckoners as described above. After the last deployment (a maximum of three deployments per animal) all loose parts of the bases were also removed, leaving only the epoxy in the fur, which would have been lost with the annual moult.

## 2.5 Treatment of collected data

### 2.5.1 Dive analysis

Dive analyses from serial depth data derived from pressure transducers (Time Depth Recorders - TDRs) are conventionally based on assessment of changes in depth over time (e.g. Williams et al., 2000). These data are graphically represented as depth on the y-axis versus time on the x-axis (see later). Dive analyses typically look for points of inflection in these graphical representations and quantify the change in depth and time that has occurred between them (Schreer & Testa, 1996). We used MT-DIVE (Jensen Software Systems, Laboe, Germany) to carry out these analyses. The program projects the dive data over time on the computer screen and, following defined points of inflection criteria set by the user, uses cursors to mark the putative points of inflection on a dive by dive basis. The position of these cursors can be assessed by the researcher and changed if found wanting. Three major phases during a dive are identified by the position of the cursors: the descent, the bottom phase and the ascent phase. Having ascertained that cursor position is correct for any particular dive, the program user confirms this and the dive parameters resulting from it are stored in an output ASCII file pending further analysis. Parameters identified by the program as a result of this approach are:

- Date and time of dive

- Duration of dive

- Duration, speed, angle of descent and vertical velocity of the descent phase

- Duration, speed, angle and vertical velocity of the bottom phase

- Duration, speed, angle of ascent and vertical velocity of the ascent phase

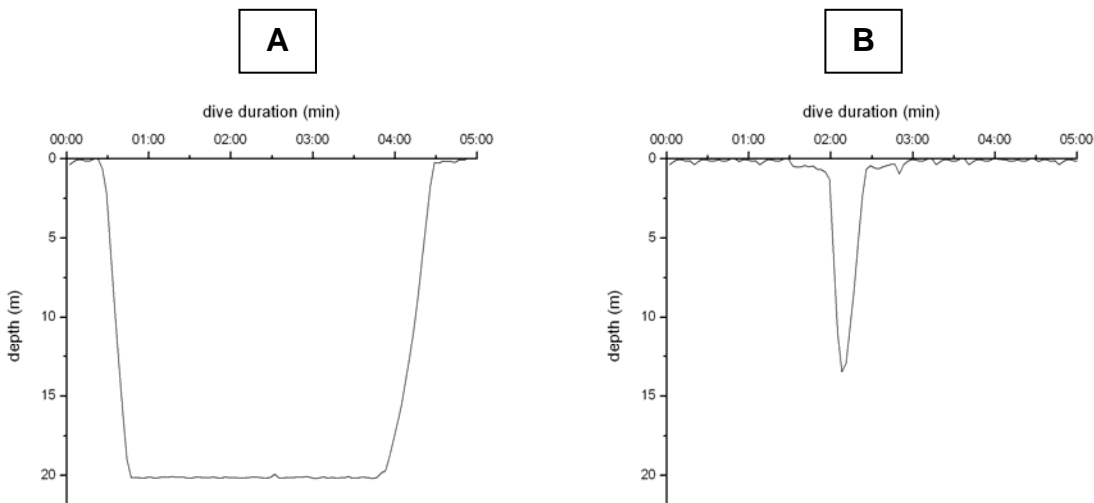
- Duration of the inter-dive phase.

- Minimum and maximum depth.



### *Initial assessment - dive profile categorization*

Dives can be broadly categorized according to definitions given by Le Boeuf et al. (2000) and Schreer & Testa (1995; 1996) and fall into one of two major categories; U- and V-dives (Fig. 26A & B), with U-dives having an



**Figure 26.** Example of a U-type (A) and V-type (B) dive executed by a harbour seal.

extended bottom phase whereas in V-dives the point of maximum depth is only briefly reached before the animal returned to the surface. All dives were ranked as either 'V-shaped' or 'U-shaped' before being treated further.

#### 2.5.2 Movement analysis

##### *PTT data*

PTT data were collected and sorted according to the ARGOS ranking: 3, 2, 1, 0, A and B (for definitions of these see Taillade, 1992). Qualities 1, 2 and 3 were used to give positions used to correct for dead-reckoner drift (see below). Otherwise, in maps constructed to show animal position, the fix qualities used are specified where appropriate. It should be noted, however, that analysis of the PTT data was further complicated by the fact that all units were programmed to release after a certain time and transmit their position while being washed ashore

(see above). In cases where PTTs were recovered together with the loggers periods and positions could be ascribed definitively to those occurring while the units were on the seals. Cases where the loggers were not recovered were more problematic since there was no independent confirmation when the PTTs were on the seals. Thus, the PTT distributional data derived from such units were treated separately, with positions being taken as those relating to seal on a 'common sense' basis (primarily based on other confirmed data). Consequently, until these positions can be independently verified, these results should be treated with caution.

#### *Dead-reckoner data and the determination of 3-d trajectories*

Data from the three compass channels, the pitch and roll channels as well as speed and depth are needed in order to reconstruct seal routes using vectors (Mitani et al., 2003; Wilson & Wilson, 1988). The seal routes were calculated using MT-ROUTE (Jensen Software Systems, Laboe, Germany) which produces ASCII output files for animal position with, and without correction for drift (see below) for every sampling interval recorded by the dead-reckoner. The compass channel data were put into perspective by defining the orientation of the unit with respect to gravity as demonstrated by the pitch and roll channels. The heading taken by the animal was then calculated according to Caruso (2000). Essentially, for a compass in a local horizontal plane, the roll and pitch angles are zero and the heading can be calculated as:

$$\text{Heading} = \text{arcTan} (Y_H/X_H) \quad (1)$$

where  $X_H$  and  $Y_H$  represent the earth's horizontal magnetic field components. As the device is rotated, the heading sweeps  $0^\circ$  to  $360^\circ$  referenced to magnetic North. Tilts in the device require that all three magnetic field components (X, Y and Z) be used to calculate heading. Tilt angles in the system deployed are determined via the body orientation sensors (pitch ( $\nu$ ) and roll ( $\theta$ ) -

see above) so that X, Y and Z magnetic readings can be transformed to the horizontal plane (X<sub>h</sub>, Y<sub>h</sub>) by applying:

$$X_H = X \cos(\nu) + Y \sin(\theta) \sin(\nu) - Z \cos(\theta) \sin(\nu) \quad (2)$$

$$Y_H = Y \cos(\theta) + Z \sin(\theta) \quad (3)$$

where  $\theta$  is the pitch angle (from the horizontal) and  $\nu$  is the roll angle (from horizontal).

Thus, once the magnetic components are found in the horizontal plane, equation (1) can be used to determine heading. To account for arcTan limits, the heading calculations must account for the sign of the X<sub>h</sub> and the Y<sub>h</sub> readings according to:

Heading for:

$(X_H < 0)$	$= 180 - \text{arcTan}(Y_H/X_H)$
$(X_H > 0, Y_H < 0)$	$= - \text{arcTan}(Y_H/X_H)$
$(X_H > 0, Y_H > 0)$	$= 360 - \text{arcTan}(Y_H/X_H)$
$(X_H = 0, Y_H < 0)$	$= 90$
$(X_H = 0, Y_H > 0)$	$= 270$

Having derived the seal heading for every measurement interval the route was reconstructed using the animal release point as the start point or any other point defined by a PTT fix of quality 1 or above (see PTT data above). The extent of horizontal movement between any one point and other between times  $t$  and  $t+1$ , where the time difference was 1 s, was given by:

$$M = \sqrt{(V^2 - (dD/dt)^2)} \quad (4)$$

where  $V$  = speed (m/s) and  $dD/dt$  = rate of change of depth (m/s).

The position at any time t+1 was given by:

$$(P_N, P_E) + (\sqrt{(V^2 - (dD/dt)^2)}) \cos(\xi), (\sqrt{(V^2 - (dD/dt)^2)}) \sin(\xi) \quad (5)$$

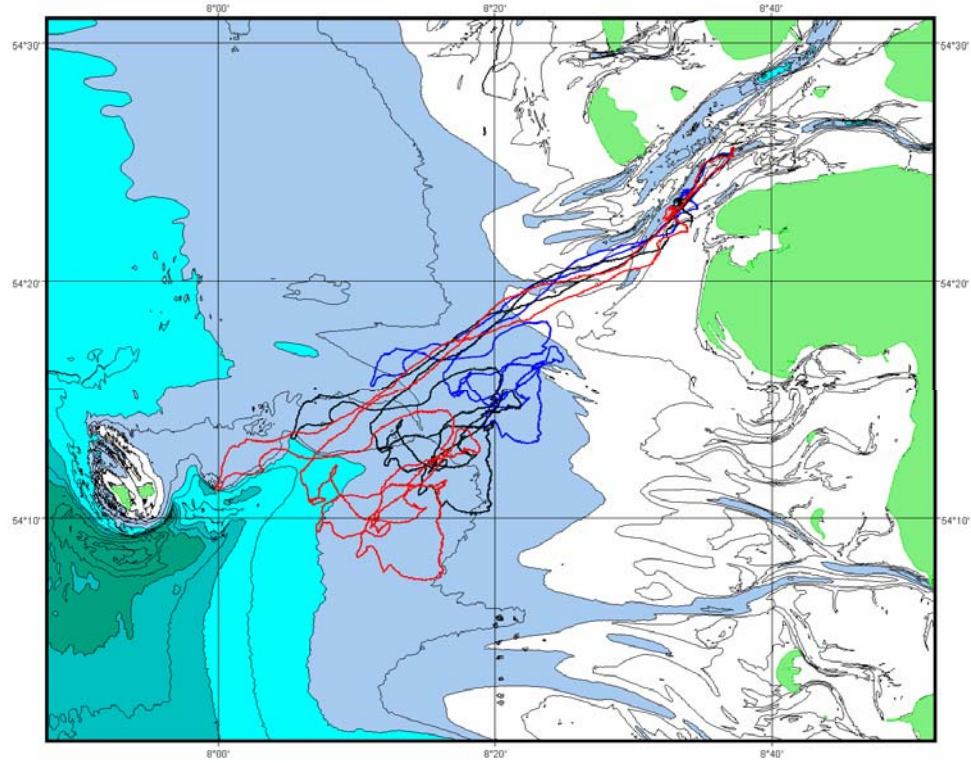
where  $P_N$  is the position from a given point in direction North at time t (m),  $P_E$  is the position from a given point in direction East (m) at time t and  $\xi$  is the heading ( $^\circ$ ) taken over the time interval t+1. As in the example for derivation of heading (above) care must be taken that the sine and cosine values are applicable according to heading angle  $\xi$ .

Problems with the determination of seal speed were encountered due to silting up of the axle used in the moment-arm arrangement of the transducer so that only higher speeds were recorded (see below). Seal swim speed could be determined at any time where there was appreciable change in depth, such as occurred during the whole of the descent and ascent phases as well as at times during the bottom phase. This was most easily resolved where sampling interval was short (Table 1; p. 145). In order to derive a value for swim speed while animals were moving along the bottom (movement, in any case, being indicated by the body orientation sensors - see above) work was specifically undertaken on the animal (A) that swam directly from the Lorenzenplate to Helgoland. This particular case was rather an exception to the central place foraging movements normally exhibited by seals (see below) and allows bottom travelling speeds to be assessed because the animal moved from one well-defined seal resting spot to another at another location. In the determination of seal speed during the bottom phase of dives, the real swim speed of the animal was calculated during all descent and ascent phases of the dive using:

$$V = (dD/dt) / \sin(\psi) \quad (6)$$

where  $V$  is the swim speed,  $dD/dt$  is the rate of change of depth and  $\psi$  is the dive angle. These swim speeds were then used in extensions of equation (1),

(4) and (5) and to calculate the fraction of the distance between the Lorenzenplate and Helgoland, according to the route taken by the animal covered during these periods. The remaining distance was then divided by the time spent underwater covering this distance to derive a mean travelling speed of 1.41 m/s. This assumes that travelling speed for animals breathing at the surface is zero. We note that this value accords closely with the mean values derived for the descent and ascent phases ( $x = 1.38$ , SD 1.38, N = 41167 &  $x = 1.28$ , SD 1.19, N = 33994, respectively) as well as that documented by Sato et al. (2003) and Williams et al. (2004) for Weddell seals. The relative invariance of these value augers for animals swimming at their lowest cost of transport, something that is expected (Culik et al., 1994; Schmidt-Nielsen, 1995; Williams, 2001; Williams et al., 2000; Williams et al., 2004). We note that construction of foraging routes with inaccurate values for the bottom speeds results in errors that are zero at the points of departure and return to the PTT-defined haul-out spot but which increase to maxima at the mid-point of the route. Confidence limits set around foraging tracks can be drawn to indicate how positional error might change over the course of route (Fig. 27). See also later for general discussion of effects of dead-reckoning-incurred errors.



**Figure 27.** A route determined by the dead reckoner with different travelling speeds during the bottom phase, considered to be at the upper and lower edge of the normal range (black: 1.4 m/s; blue: 1.0 m/s; red: 1.8 m/s).

Absolute distances moved over the sampling intervals were derived from the measurements of speed and the horizontal distance moved over any one sample interval was derived from the absolute distance  $D$  and pitch angle of  $\theta$ , (between time  $t_n$  and  $t_{n+1}$ ) according to:

$$d = D \cos(\theta) \quad (7)$$

Assuming the animal's position at  $t_n$  to be  $(x_n, y_n)$ , and its heading to be  $\xi$ , then its position at  $t_{n+1}$  was calculated via:

$$\text{Position} = (x_n + d \sin(\xi)), (y_n + d \cos(\xi)) \quad (8)$$

Substituting from (7) the position at  $t_{n+1}$

$$= (x_n + (D \cos(\theta)) \sin(\xi), y_n + (D \cos(\theta)) \cos(\xi)) \quad (9)$$

This process was carried-out starting with step one at  $t = 0$  through to the last position, with the animal's position being changed in a cumulative manner. Where the end position of the equipped animal was known, taken to be  $(x_{\text{realend}}, y_{\text{realend}})$ , the calculated position  $(x_{\text{calcend}}, y_{\text{calcend}})$  was compared to give the total positional error as;

$$= (x_{\text{realend}}, y_{\text{realend}}) - (x_{\text{calcend}}, y_{\text{calcend}}) \quad (10)$$

Assuming drift to be constant over time, the error per measurement interval is;

$$= ((x_{\text{realend}}, y_{\text{realend}}) - (x_{\text{calcend}}, y_{\text{calcend}}))/n \quad (11)$$

Using equations (9) and (11), the best estimate for animal position at any time  $t_{n+1}$  was corrected to be;

$$= ((x_n + (D \cos \theta) \sin \xi), (y_n + (D \cos \theta) \cos \xi)) + ((x_{\text{realend}}, y_{\text{realend}}) - (x_{\text{calcend}}, y_{\text{calcend}}))/n \quad (12)$$

#### Dead-reckoner and the Area Activity Index (All)

Initially a definition of 2-dimensional track tortuosity was produced based on the horizontal straight line distance travelled by an animal over a defined time period (encompassing  $m$  sampling periods) divided by the total horizontally-travelled distance calculated by summing the horizontal distance travelled during

each measurement interval from  $n$  to  $n + m$ . This process was only applied where animals were known to be travelling rather than resting in one spot. Mathematically, this is:

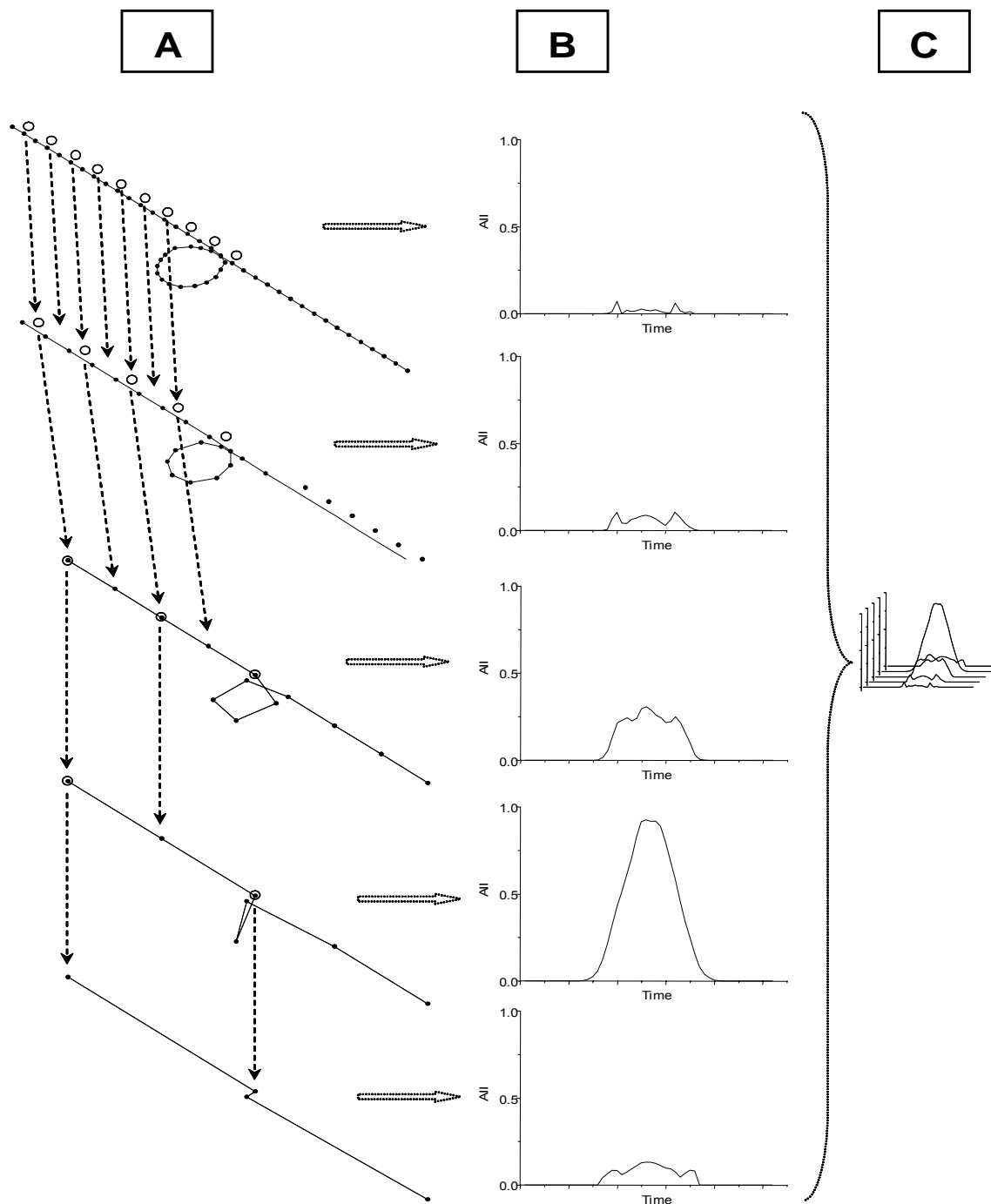
$$\frac{((x_{n^2} y) - (x_{(n+m)^2} y_{(n+m)}))}{\sum_{(x(n),y(n))}^{(x(n+m),y(n+m))} ((x + (D \cos \theta) \sin \xi), (y + (D \cos \theta) \cos \xi))} \quad (13)$$

In order to define some measure of Area Interest Index (All), this value was subtracted from 1 so that straight line travelling had values of 0 and circular movement within the specified time interval had a value of 1 (Fig. 28). Thus;

$$All = 1 - \frac{((x_{n^2} y_n) - (x_{(n+m)^2} y_{(n+m)}))}{\sum_{(x(n),y(n))}^{(x(n+m),y(n+m))} ((x + (D \cos \theta) \sin \xi), (y + (D \cos \theta) \cos \xi))} \quad (14)$$

$m$  was set equal 2 in all future calculations of All referred to in this work. This approach shows how the tortuosity of tracks varies with time but does not adequately allow the variation in tortuosity of tracks as a function of scale to be assessed if step length remains constant because high levels of small scale tortuosity impact the lower term in eqn (14) even if  $m$  is increased. To eliminate this problem  $x$ ,  $y$  positional data were run once to calculate the All before being progressively thinned to increase the step length (Fig. 28). The All calculation was then re-run while holding  $m$  constant at 2. Thus, although the absolute integer value of  $m$  remained constant, its effective value in terms of time varied, becoming larger with greater thinning. In order for the values of All from each run to be completely independent of the preceding run, the thinning out process nominally involved removing every other point at each subsequent stage. Thus, if the sample interval was  $i$ , the effective step length was  $i$ ,  $i^2$ ,  $i^3$ ,  $i^4$ ... in four runs of





**Figure 28.** (A) Theoretical path of an animal showing a loop in the overall straight course but subject to increasing thinning (top to bottom) by deletion of every other point so that small scale resolution of movement becomes increasingly filtered out. (B) shows the AII ( $m= 2$ ) for the various tracks. Note that the highest values occur when 16 points have been deleted and that the loop is composed of ca. 16 points in the finest resolution. (C) shows a 3d plot of the Area Interest Index (vertical axis) versus time and degree of data reduction (scale).

increasing scale assessment (Fig. 28). This produced the data necessary for a 3-dimensional matrix of AII against time as a function of scale and these data were

subsequently gridded using the program Surfer (Golden Software) according to the default setting using kriging as the methodology. It should be noted here that the precise method by which this gridding occurs will affect the resultant picture substantially and this should be given careful thought (although discussion here is not warranted). The subsequent plot was also undertaken using Surfer (Fig. 28) with the plots being improved by thinning data less than by simply removing half the points at each stage, although the interdependence of adjacent points on the surface must be borne in mind.

### 2.5.3 Feeding analysis

The recorded logger-data from the captive harbour seals were downloaded on a laptop computer. Subsequent inspection of the video footage allowed estimation of the distances between the jaw articulation and the magnet and sensor (from the calibration procedure) so that jaw-opening angle could be calculated using standard trigonometry. These angles were then related to sensor output using curve-fits from Tablecurve 2D (v5.00, Systat Software Inc., USA) before the whole data set was transformed into jaw-opening angle (Liebsch, 2002). The video footage also proved particularly useful in identifying feeding events and relating certain patterns in the data to specific jaw movements. The calibrated data were analyzed using MT-Beak (Jensen Software Systems, Laboe, Germany), which calculated maximum jaw-opening angle, duration and integral (under the angle-time curve) for every feeding event. These results were then compared with the measurements from the prey objects taken.

The recorded IMASEN data from free-ranging animals were processed in a manner similar to that described to the work on captive animals. The dive data were analyzed using MT-Dive (Jensen Software Systems, Laboe, Germany) and the swim routes calculated using MT-Route (Jensen Software Systems, Laboe, Germany). Based on the common time base used by both IMASENs and dead-reckoners, feeding events could be related to geographic positions, depth and

movement patterns.

#### 2.5.4 Data merging

Data derived from the various analyses (dive types, positions, AIs and feeding events) were merged together using the program KOORD2METER (Jensen Software Systems, Laboe, Germany). This program identified particular conditions (behaviours, positions etc.) from two different output files from any of the analyses according to time and date and merged them into a single file so that, for example, the geographic positions where particular types of behaviour occurred could be determined.

#### 2.5.5 Pseudo- and over- representation

##### *Positional data*

In order to correct for sample-based over-representation in the presentation of data, the positional data were treated so that all animals had a number of positional fixes from the dead-reckoners equal to the minimum number recorded on any foraging trip. This amounted to around 50,000 points and necessitated that the data from animals be thinned according to the conditions set out in Table 1 (p. 145).

##### *Dive data*

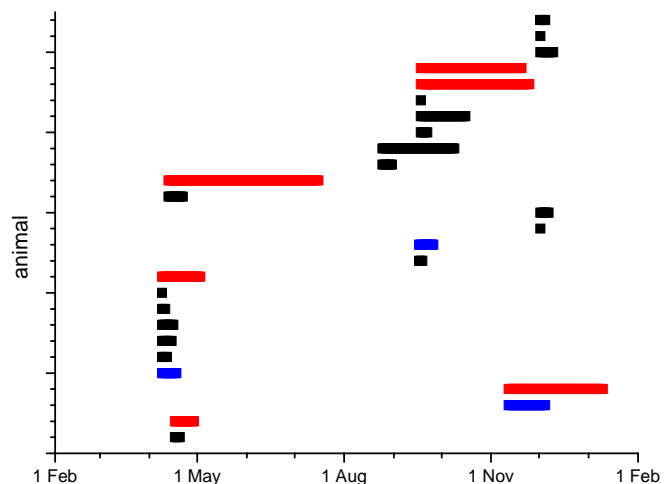
In presentation of the dive parameters, all data from each animal were graphed out together, irrespective of the number of foraging trips, to derive general relationships (primarily parameters such as dive duration in relation to maximum dive depth - see later). These relationships were determined by standard regression procedures before means per maximum depth interval from all animals were compiled to derive a grand mean of them to eliminate errors due to pseudoreplication. When not stated explicitly, dive data are presented according to this scenario.

# Chapter 3 Results and general interpretation

## 3.1 Harbour seals - North Sea – MINOS

Of the 39 devices deployed between April 2002 and December 2004, 27 were recovered by mid 2005. Two were recovered by people specifically seeking the packages following data generated from the PTT giving the position of units that had drifted to land while 25 were found by passers-by. The periods logged by any of the devices ranged from just a few hours to 94.1 days (Table 1; p. 145). For further analysis, in this thesis only 9 of the recorded datasets were used, with the shortest being 9.4 days and altogether adding up to a total of 363.3 days of data (more than 4.9 million recordings), during which the seals performed 104,285 dives. Three animals had been equipped on Rømø, contributing 64,911 dives to the dataset while the other 6 animals from the Lorenzenplate performed altogether 39,374 dives (Fig. 29). All other datasets were too short to document proper diving activity from at least one complete foraging trip and were therefore neglected due to the biases

that they might generate. For 3 out of the 6 animals from the Lorenzenplate no geographic positions were calculated due to device malfunctions in the compass channels or missing satellite positions during the deployment period (necessary for correction of drift – see earlier). From the remaining 6 datasets, movement from



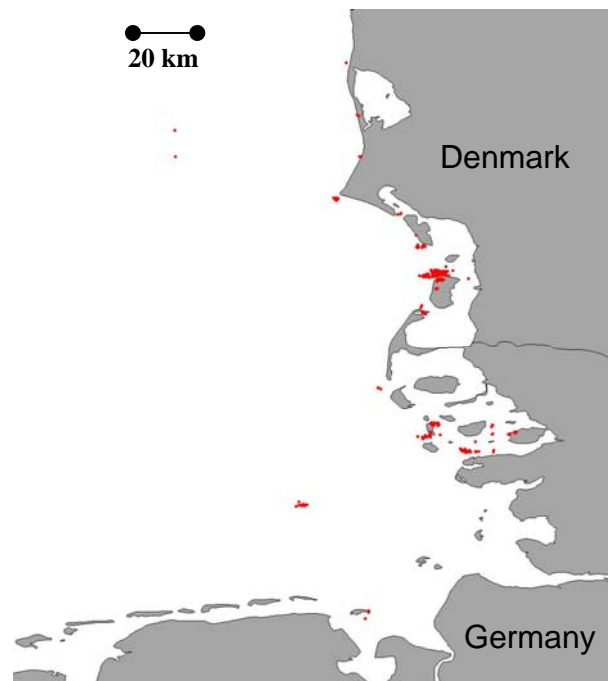
**Figure 29.** Schematic diagram to show periods when harbour seals were successfully equipped providing data for the periods shown (red: route and dive data; blue: dive data only; black: data neglected in this study). Note that a successful equipment requires that the logger be deployed, recovered and contain viable data.

48 Harbour seal foraging trips could be calculated. Between 1 and 12 trips were made by each animal, lasting between 13.6 and 363.6 h (mean: 109.3 h; SD: 84.3). The deployments allowed us to cover a substantial proportion of the year although there are still periods where seal foraging behaviour was not documented.

### 3.1.1 Area Use

#### *Seal area use as determined by PTTs*

The satellite tracking systems showed considerable error in positional estimates, even if only data with fixes of quality 1-3 were used (Fig. 30). This was apparent by the relatively large number of fixes on land. Erroneous fixes that occurred at sea cannot readily be identified as such although the error may be equivalent to that of the land fixes. The PTT data are likely to be highly biased towards fixes in the vicinity of the haul-out site due primarily to area-dependent differences in the proportion of satellite uplinks stemming from particular diving behaviour (see below, Trost, 2004). The methodology is partially to blame for this. Following suggestions in Bannasch et al. (1994b) based on considerations of hydrodynamics, the recording package was attached to the seals' lower backs. While this reduces drag enormously (Bannasch et al., 1994; Obrecht et al., 1988), thereby minimizing deleterious package-induced behaviour (see Culik et al., 1994a; Wilson & Culik, 1992; for a discussion of these in



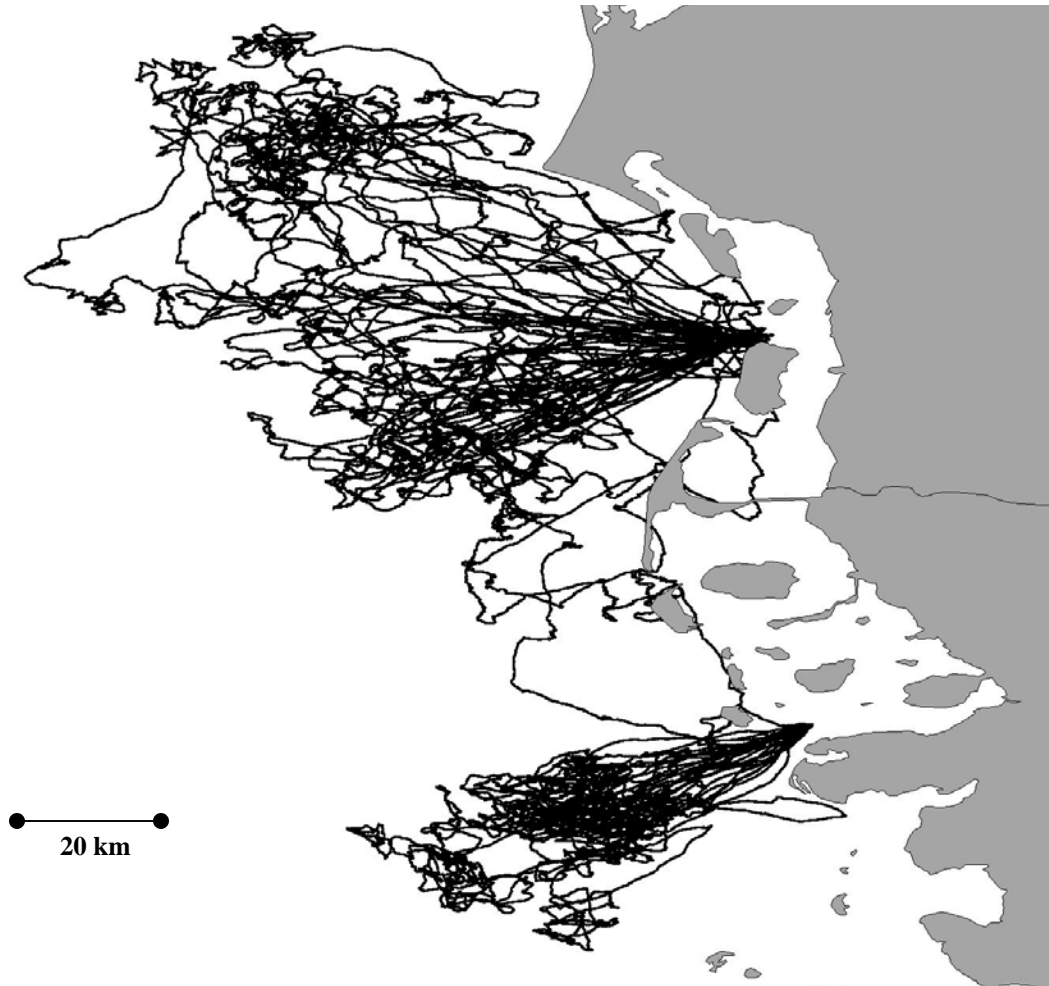
**Figure 30.** All PTT fixes with LC > 0 from all equipped harbour seals during the study period.

penguins), it means that the PTT is submerged for most of the time that the animal is in the water so that no link with the satellite is possible. Submergences which involve the animal rolling with the back out of the water facilitate links since the water switch on the tag allows transmission at the exact time the antenna is in the air. However, the percentage of such 'rolling' dives appears extremely low during normal foraging compared to behaviour around the colony. Other workers have reported a much higher percentage of fixes by attaching PTTs to the animals' heads (B.McConnell pers.comm). Although this will help define foraging areas better, the genuine quality of the derived data is questionable due to device effects (Ellwodd et al., in press). Thus, head-mounted PTTs are unacceptable but back-mounted PTTs produce serious biases in area use (see later). Nonetheless, occasional good quality fixes from back-mounted PTTs are important for correction for drift in vectorial calculations of animal position derived from dead-reckoning. It is thus informative to note the distributions of area use by the animals here as elucidated by the PTTs but it will not be discussed further.

#### *Seal area use as determined by dead-reckoners (All data)*

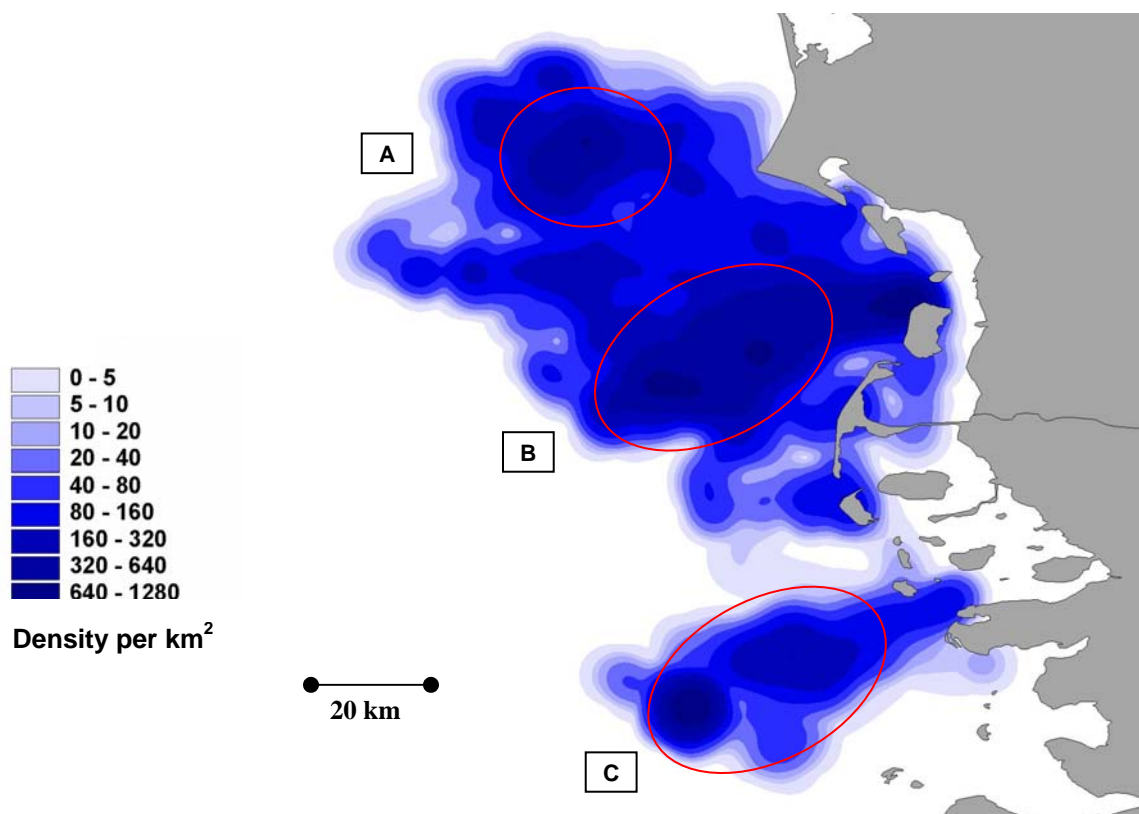
The dead-reckoning technology allowed us to quantify the routes taken over 48 foraging trips from 6 animals (Fig. 31). Analyses (see later) indicates that time spent in the Wadden Sea area is, however, not specifically associated with foraging. Details of the various routes taken and the behaviour that occurred on these routes are presented below. Here, the data are simply compiled to show the time-dependent area use for all animals (Fig. 32) although these data are subject to pseudoreplication. This procedure is avoided in the section below but, in the interests of maximizing the data set, all data are briefly considered here.

Tracks displayed a clear base pattern from both tagging sites, where animals were mainly heading for the open North Sea in a west-south-westerly direction. This 'transit channel' is very distinct, especially at the Lorenzenplate, whereas it is much wider around Rømø, extending fatherly in a west-north-westerly direction. The area where the seals spent most time (B and C in Fig. 32) reached about 70 km into the North Sea, with a higher density in the outer 2



**Figure 31.** Examples of 48 foraging trips made by 3 seals from Rømø and 3 seals from the Lorenzenplate showing variability in the degree of meandering. Note that the outward and return legs show much straighter travel than the centre sections of the traces and that there are instances where the animals apparently swam over land. This occurs due to inaccuracies (due to e.g. drift - see methods) in the dead reckoning procedure.

thirds, where they are about 35 km wide. Animals from the Lorenzenplate were fairly restricted in movement at sea, and only haul-out sites in the close vicinity were used. Also, during one trip a seal travelled as far north as the island of Sylt, linking up with the area used mainly by the 'Danish' seals. This track went along the outer islands of the Wadden Sea, but did not reach further than 30 km into the North Sea, still well within the 20 m depth contour line. The seals from Rømø exhibited a much wider variance in area use, covering about 3 times the area used by the seals from the Lorenzenplate. Beside the area mentioned above, where tracks from both sites overlapped, another 'hotspot' with a high time



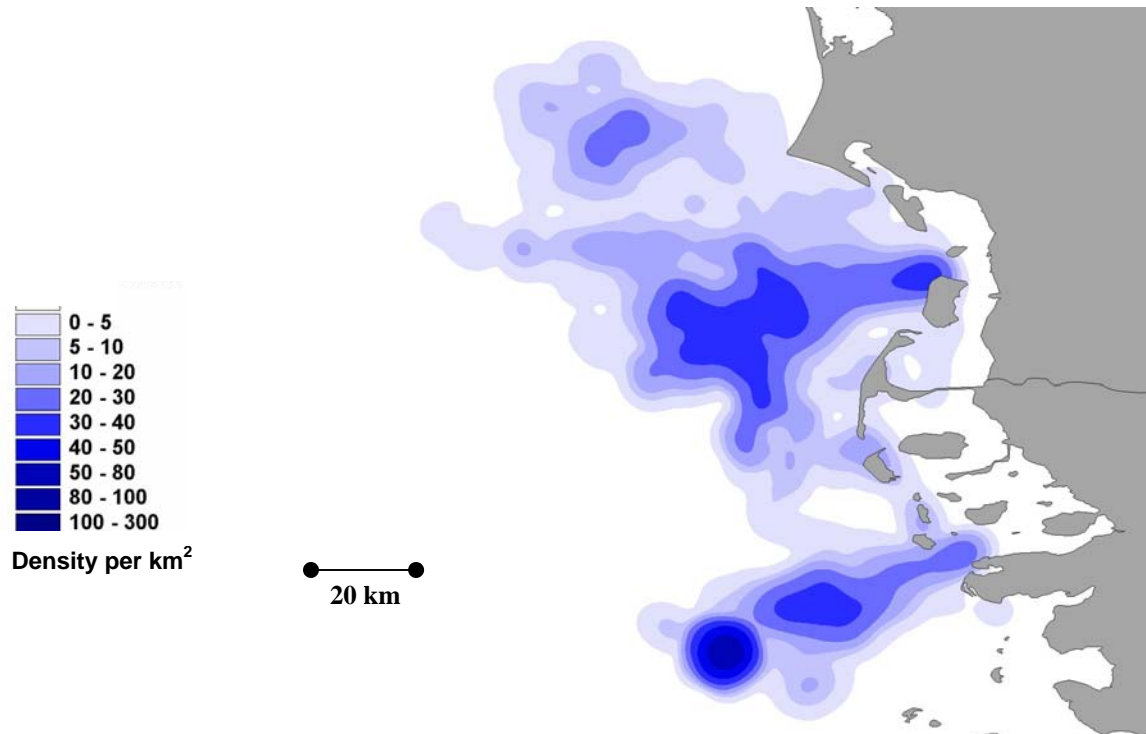
**Figure 32.** Kernel analysis of all positional data derived from dead reckoners deployed on harbour seals for the study period. Reference to areas marked A-C is made in the text. Data corrected for pseudoreplication are shown in Fig. 33.

density and a diameter of about 60 km occurred west-north-west of Blavandshuk reaching about 100 km into the North Sea from the tagging site (A in Fig. 32). Between these three main spots, the area was used with a fairly uniform high density. Even though the ‘Danish’ seals returned to Rømø between most trips, they used different haul-out sites on the island and even the mainland north of Rømø several times.

#### *Pseudoreplication-corrected data*

The pseudoreplication-corrected data for area use of the seals (Fig. 33) showed a similar, but clearer, pattern to that obtained using all data although the distribution of time within these limits differed. In particular, the area around Helgoland gained substantially in apparent importance although this was due to a single animal foraging in a very limited area around the island. Other animals,

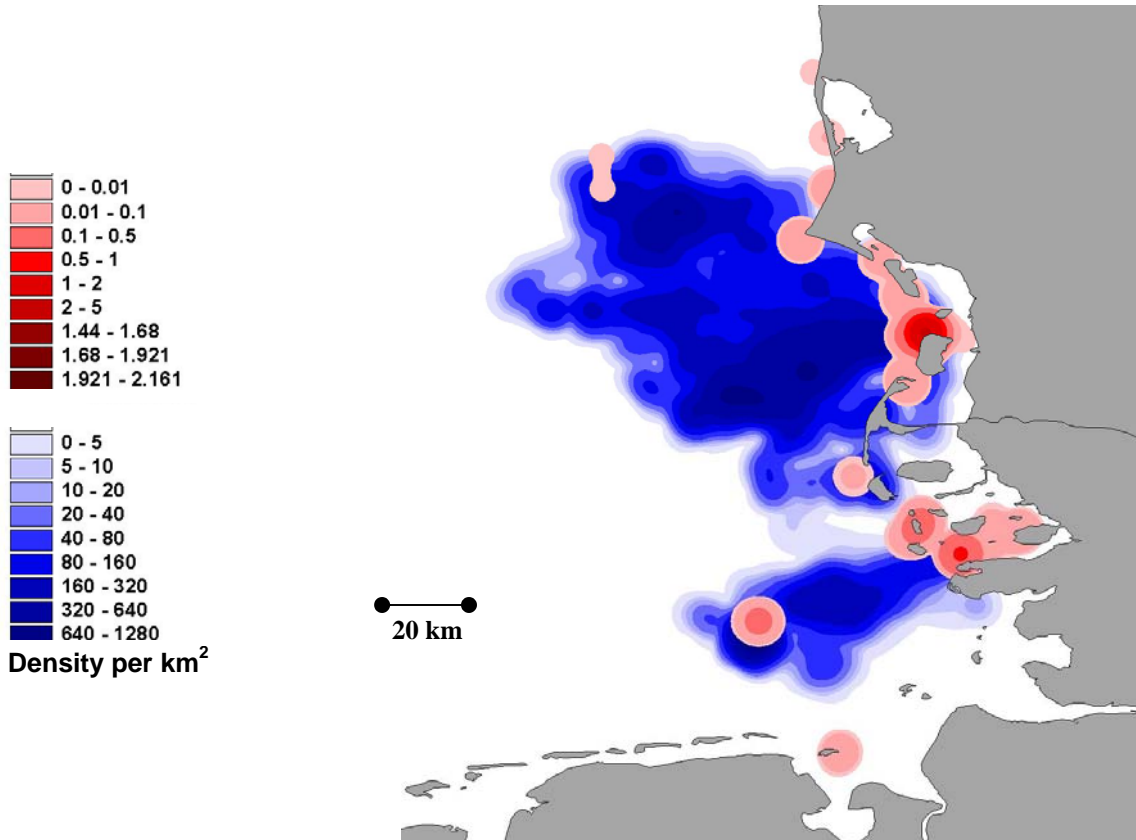




**Figure 33.** Kernel analysis of positional data derived from dead reckoners deployed on harbour seals for the study period. These data are corrected for pseudoreplication and are so presented that all animals are represented equally, irrespective of how many foraging trips they undertook.

being ascribed the same number of points, but moving over a much greater area, could not achieve an area density equivalent and appear under-represented (cf. Fig. 32 & 33). Both the pseudoreplication-corrected, and the complete data set show that all equipped seals occupied areas within ~ 100 km off the coast and ~ 80 km off the nearest land in water between 0 and 40 m deep although there is a clear bias to water between 10 and 20 m depth. Although the representation of time spent in the various areas is useful in a general sense, it is advantageous to detail the various behaviours observed by the seals before ascribing them to particular positions and then consider the importance of specific areas.

Before doing this, however, it is instructive to highlight the substantial differences that there are between the PTT-derived positional data and those taken from the dead-reckoners for all data (irrespective of activity) associated with the position (Fig. 34). It is important to note that PTT-derived data imply an area usage that is much more coastal than the dead-reckoners and cognisance of this is critical with regard to any data gathered in the future using satellite



**Figure 34.** Kernel analysis of positional data derived from dead reckoners (blue) and PTTs (red) to demonstrate differences in apparent area use according to methodology.

telemetry. Reasons for this have already been discussed above.

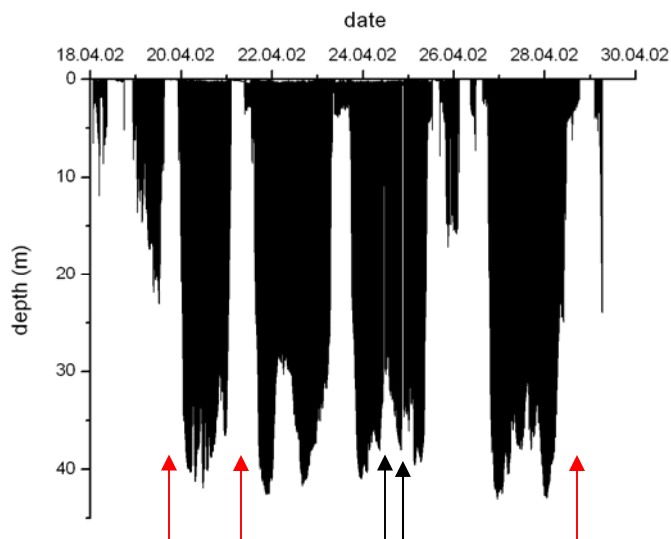
### 3.1.2 Behaviour

#### *Behaviour on land*

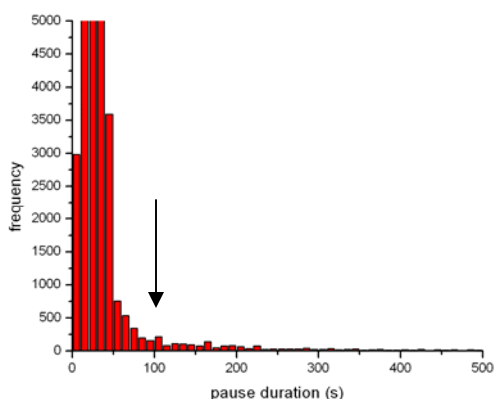
It is not the object of this study to examine the behaviour of harbour seals on land in detail. Haul-out sites in the North Sea area are well known and documented by NPA (1998). Presence of the animals on land was indicated clearly by the loggers where the pressure sensor never deviated from a value of 0 m, temperature was highly variable and the pitch-roll and compass sensors did not change for extended periods. All equipped animals spent 19 % of their time on land, with the mean time per haul-out being 6.2 h (SD: 4.6; N = 117 from 13 animals; (Troost, 2004).

## Behaviour at sea

Seal diving behaviour was superficially similar across animals. Dives occurred in discrete bouts (as defined by Kooyman, 1989) with most bouts separated by periods on land (see above) although some inter-bout periods clearly occurred at sea (Fig. 35). Various authors have used bout-ending criteria to determine which periods constitute proper bouts so that the intervals between dives can be appropriately allocated to gas exchange rather than any other process (e.g. Williams et al., 2004). A plot of the frequency of occurrence of all inter-dive durations from all seals (Fig. 36) determined the upper point



**Figure 35.** Example of changes in depth use by a seal ‘A’ over 6 foraging trips lasting about 12 days. Note that the periods on land are shown (red arrows) and that shorter inter-bout periods at the sea surface (black arrows) also occur between extended periods during which diving was continuous.



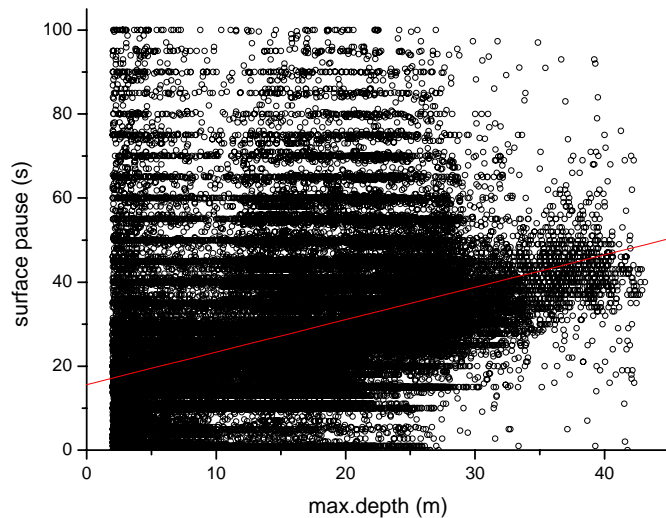
**Figure 36.** Frequency distribution of the surface pause durations of 9 harbour seals in 10 s intervals. An expanded view with a reduced maximum y-axis is shown to facilitate visualization of the point of inflection used as a bout-ending criterion (arrow - see text).

of inflection in this so as to define a specific surface interval which could be used as a bout-ending criterion. This point of inflection occurred at about 100 s so that in discussion of surface intervals between dives within a bout values are only used up to, and including, this length of time. Periods within bouts at the sea surface (nominally termed ‘surface intervals’ - see Kooyman, 1989), used for acquisition of oxygen and elimination of carbon dioxide, were related to the length

of the dive according to:

Surface interval (s) =  $0.772 \cdot \text{Depth} + 15.62918$  ( $r = 0.38801$ ;  $P < 0.0001$ ;  $N = 98805$ ; Fig. 37).

The extent of the time spent at the surface is relevant in this type of study with regard to; (i) the percentage time at sea that a seal may be considered visible by observers conducting line transects (Kieess, 2004) and (ii) the likelihood that a head-mounted PTT will be able to transmit.



**Figure 37.** Relationship between surface pause < 100s and maximum dive depth for 9 harbour seals conducting a total of 98805 dives. Given the large variance in the data from any individual animal, data from all animals have simply been pooled for this without attention to pseudoreplication effects. Note also that the surface pause durations were not grouped according to preceding or following dive type.

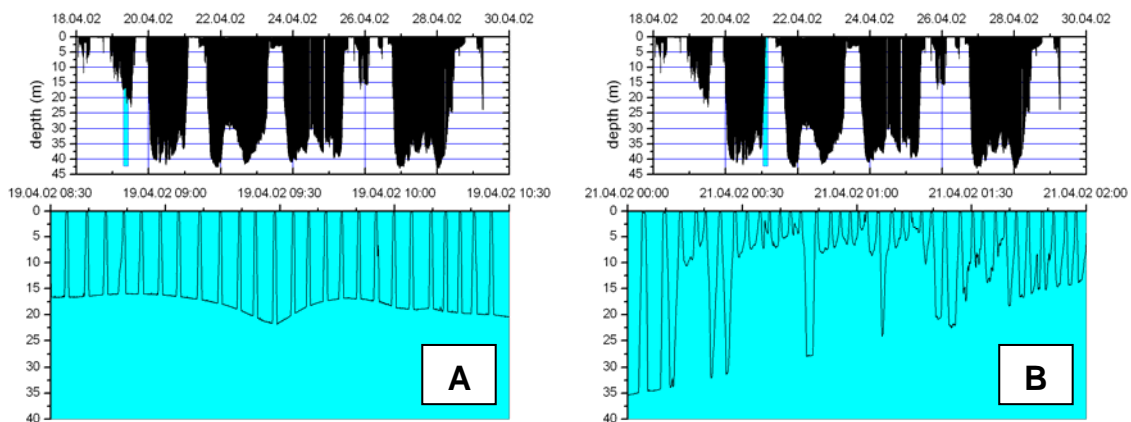
### 3.1.3 In search of the definition and function of different dive types

Based on this study, harbour seals spend 81 % of their lives at sea and 72 % of that time underwater, it can be assumed that their diving behaviour must show a large number of patterns which relate to the particular behaviour engaged in at any particular time. In the interests of defining the importance of regions visited by these animals an attempt will be made to determine dive function, which can then be subsequently related to locality. This requires systematic categorization of dives into types based on the parameters that the dead-reckoners recorded for us. Classic studies examining dive types are based almost exclusively on change in depth over time from TDR studies (Baechler et al., 2002; Krafft et al., 2002). It is thus appropriate that assessment of the dive

types using changes in depth over time begins with this so as to equate the data with published work. However, this will be later enhanced by considering other sensors to refine the dive function analysis when appropriate (cf. Davis et al., 2003). Specifically, dives will be further differentiated according to changes in the horizontal dimension using changes in heading, overall AII's (for definition see methods) as well as considering rates of change of depth during the descent and ascent (vertical velocities) and changes in pitch and roll.

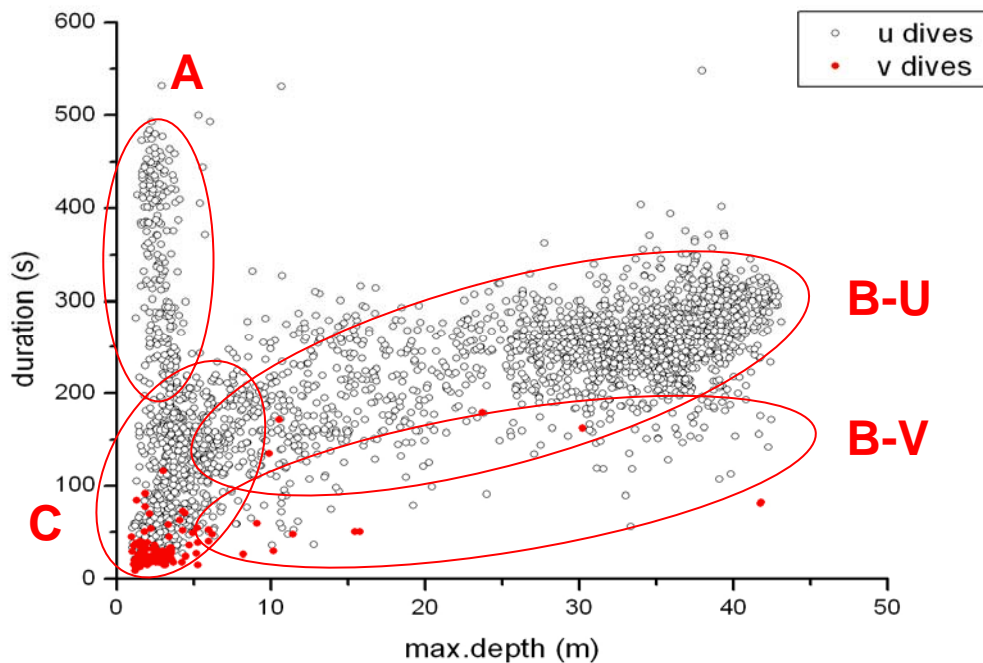
### *Dive shape and duration*

Of the 2 major dive shapes, U- and V-, U-dives usually occurred serially in sequences with changes in the bottom depth of adjacent dives varying little (Fig. 38A) (see Wilson et al., 1996). This is almost certainly because the point of maximum depth concurred with the depth of their 'feeding-horizon', the seabed. There was no such concurrence in the maximum depth achieved during V-dives to imply that seals executing these dives descended to the seabed. In fact, adjacent, deeper U-dives auger strongly for such V-dives being primarily pelagic in nature with animals rarely, if ever, descending to the sea floor (Fig. 38B).



**Figure 38.** Top: Overview over a 12 day dataset of a harbour seal. Bottom: Enlargement of the blue section marked above. (A) Example of a series of U-dives executed by the seal showing the concurrence of the depths of the bottom phases between adjacent dives. (B) Examples of V-dives conducted together with U-dives showing how the maximum depth achieved during the V-dive does not concur with projected water depth as indicated by the depths of the bottom phase of U-

In regressions of total dive duration for all dives, whether U or V-shape, against maximum depth for any particular animal (Fig. 39), 3 different populations of dives became apparent, with a fourth grouping that was difficult to assign to any particular group although it was unlikely to represent a distinct population in itself.



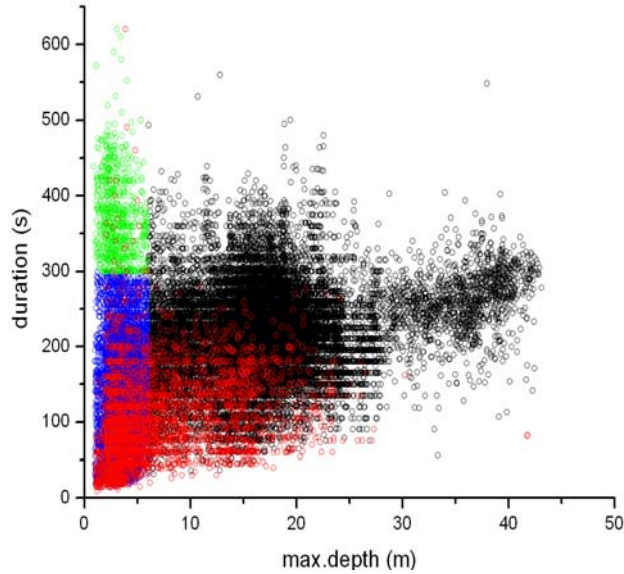
**Figure 39.** Maximum dive duration vs maximum dive depth for a single individual seal and irrespective of dive type (see text). V-dives are shown in red while U-dives are depicted in black. Different populations of dives are apparent.

- One population of dives ('B-U', incorporating only the U-shaped dives, and shown in black in Fig. 39) showed a general increase in dive duration with increasing depth for dives in excess of ca. 6 m.
- A second, and related, group ('B-V', incorporating only the V-shaped dives, and shown in red in Fig. 39) showed a similar trend although the points ran parallel to those of the 'B-U' group and were closer to the x-axis.
- A third group ('A' in Fig. 39) incorporated dives to less than about 6 m and had excessively long durations in relation to

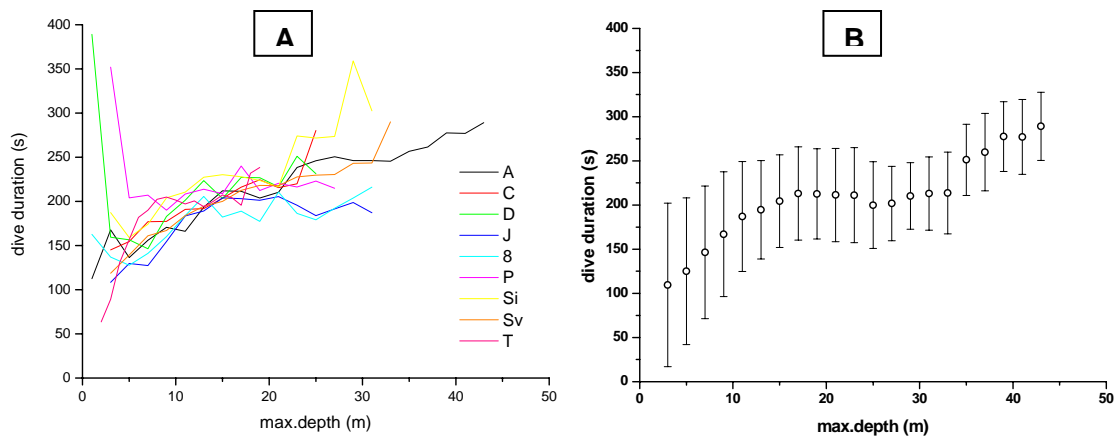
dive depth. All these dives were U-shaped and within the depth range represented there was no significant relationship between duration and depth for any animal.

- A fourth group ('C' in Fig. 39) were dives to depths less than 6 m but were not excessively long. On this basis alone, these could not be ascribed to either the population of 'B' or 'A' dives.

Consideration of all data points (Fig. 40) from all animals showed some blurring in the trends described above but this was primarily due to inter-individual variance in the critical depth between 'A' and 'B' dives and variance in the precise relationship between duration and depth for the 'B' dives as Fig. 41A makes apparent. In fact,



**Figure 40.** Maximum dive duration vs. maximum dive depth for all dives (N = 104285) from all equipped seals irrespective of dive type (see text). V-dives are shown in red and the separation of U-dive populations into 'A', 'B' and 'C' (cf. Fig. 40) is shown by colour-coding ('A'-type dives are green, 'B'-type dives are black or red and 'C'-type dives are blue).

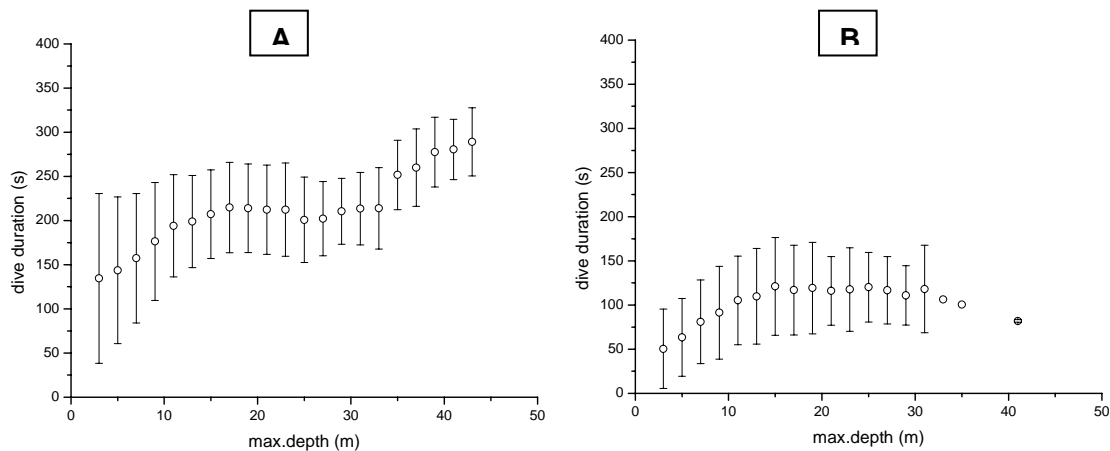


**Figure 41.** Relationship between mean dive duration and depth for (A) each of the equipped harbour seals (lines show means for each animal) and (B) all animals together. This diagram shows the mean of the means in (A) and bars show standard deviations of those means.



overall means of dive duration (for particular depth categories), derived from all the individual animal means regressed against depth (Fig. 41B) shows an overall increasing dive duration with depth over virtually the whole depth range with a larger variance for smaller maximum depths. The longest dives recorded (over 800 s) come from this category.

If dives are split according to U- and V-types and overall dive durations regressed against maximum depth it becomes clear that the increased mean duration and large variance in the duration of shallow dives (< 6 m) is due exclusively to the U-dives, V-dives showing a completely different character in this region (Fig. 42). The regression of dive duration against depth for the two dive groups both show a significant increase in duration with depth (U-dives:  $r^2 = 0.80$ ;  $F = 23.26$ ;  $N = 22$ ; V-dives:  $r^2 = 0.93$ ;  $F = 48.99$ ;  $N = 21$ ; points taken from means for the relevant depth ranges) and had significantly different intercepts but not significantly different gradients from each other (Table 2; p. 146).

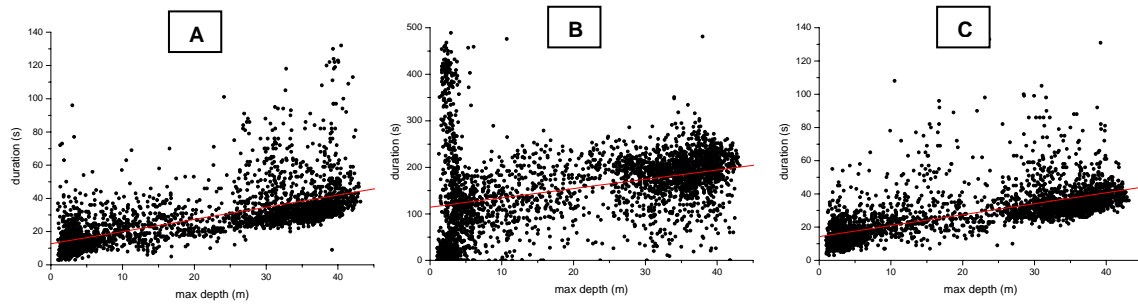


**Figure 42.** Overall mean dive duration (taken as a mean from all animal means for each depth category) plus standard deviations in relation to maximum dive depth for (A) U-dives and (B) V-dives.

### *Descent, bottom and ascent durations and velocities*

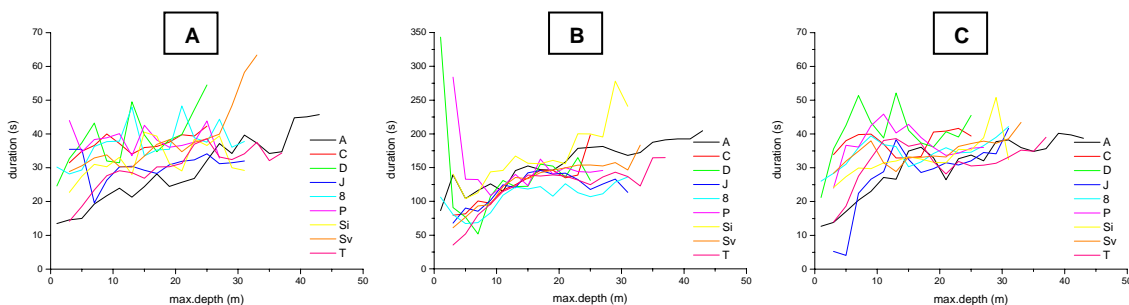
The various dive types discussed above can be further defined by separating out the major phases of the dive, the descent, bottom (where it exists) and the ascent phases. In all dives observed with a bottom phase (U-dives) the duration of the descent and ascent phases formed only a small fraction of the





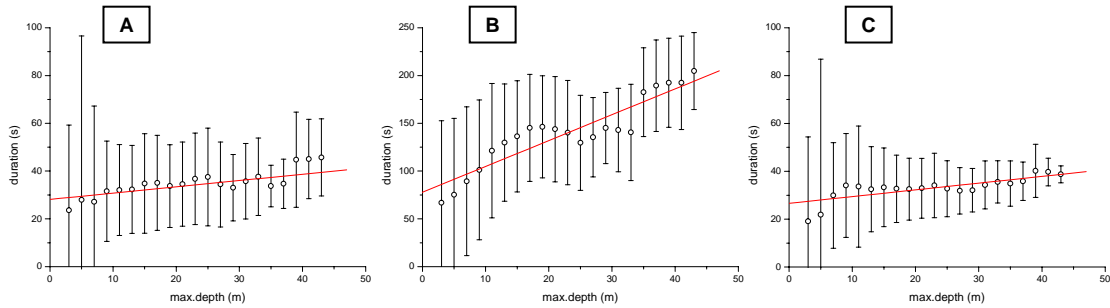
**Figure 43.** Example of the duration of the various phases of dives in relation to maximum dive depth for a single seal “A” for the (A) Descent phase (B) Bottom phase (C) Ascent phase.

total dive duration (Fig. 43). What is very apparent from the data is that the fraction of dives with extended durations to depths < 6 m (‘A’ type dives) derives these extended periods almost entirely from the duration of the bottom phase. Otherwise, the descent durations ( $y = 28.17147 + 0.26283 \cdot \text{depth}$ ;  $r = 0.63$ ;  $P = 0.0022$ ), bottom durations ( $y = 77.92619 + 2.70249 \cdot \text{depth}$ ;  $r = 0.90$ ;  $P < 0.0001$ ) and ascent durations ( $y = 26.59882 + 0.28169 \cdot \text{depth}$ ;  $r = 0.87$ ;  $P < 0.0001$ ) all increased significantly with increasing maximum dive depth for all animals (Fig. 44) so that the overall mean of the individual mean values for the duration of these activities also increased with increasing dive depth (Fig. 45).



**Figure 44.** Means for the duration of the various phases of dives in relation to maximum dive depth for all equipped seals (each line depicts an individual) for the (A) Descent phase (B) Bottom phase (C) Ascent phase.

The systematic increase in descent and ascent duration with increasing dive depth might imply a constant descent rate. This is, however, not the case. The vertical velocity (rate of change of depth) for both the descent and ascent phases increases significantly with increasing maximum dive depth (Fig. 46).

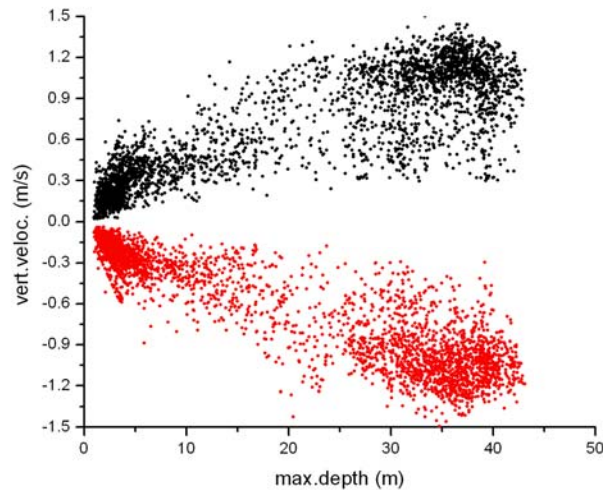


**Figure 45.** Overall mean (mean of the individual animal means) and SD of those means of the various phases of dives in relation to maximum dive depth for all equipped seals (taken from the data presented in Fig. 44 for the (A) Descent phase (B) Bottom phase (C) Ascent phase).

This trend is clear for all individuals (Fig. 47) and is strikingly obvious if the overall mean (of individual animal means) is calculated (Fig. 48).

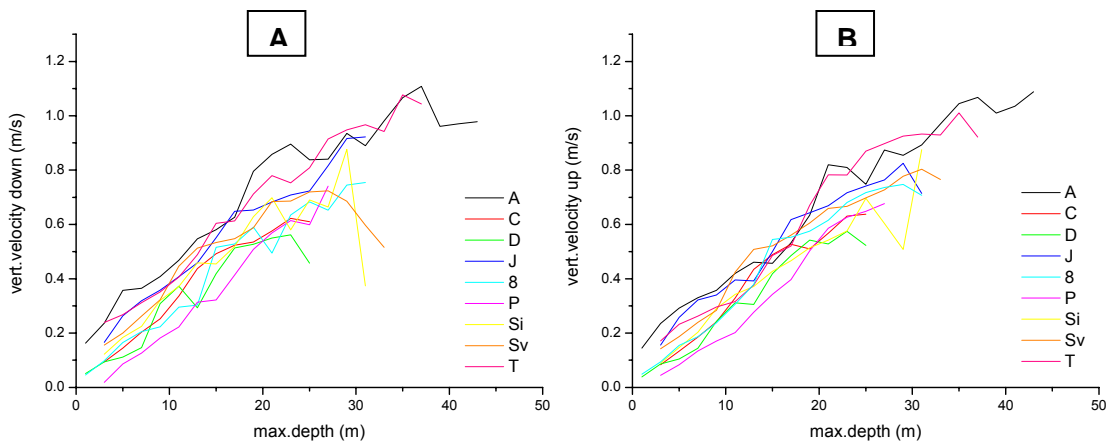
If dives are separated according to whether they have a U- or V-profile, marked differences become apparent in the duration of the descent phases between

the two types. Both types showed significantly increased duration with increasing maximum depth down to 30 m (U-dives:  $r^2 = 0.67$ ;  $F = 40.178$ ;  $N = 22$ ; V-dives:  $r^2 = 0.93$ ;  $F = 50.417$ ;  $N = 21$ ) but are significantly different from each other (Table 2) (Fig. 49A & D). Aside from the initially large bottom duration at shallow depths, bottom duration increased slightly, but significantly, with increasing maximum dive depth ( $r^2 = 0.70$ ;  $F = 9.410$ ;  $N = 22$ ) (Fig. 49B). Comparison of this with the same relationship from all dives (which includes V-dives with no bottom phase) (Fig. 45) illustrates the extent of V-dives in the diving repertoire of the seals. As in the descent phase, ascent duration increased significantly with increasing maximum dive depth for both U- and V-dives (U-dives:  $r^2 = 0.78$ ;  $F = 69.758$ ;  $N =$

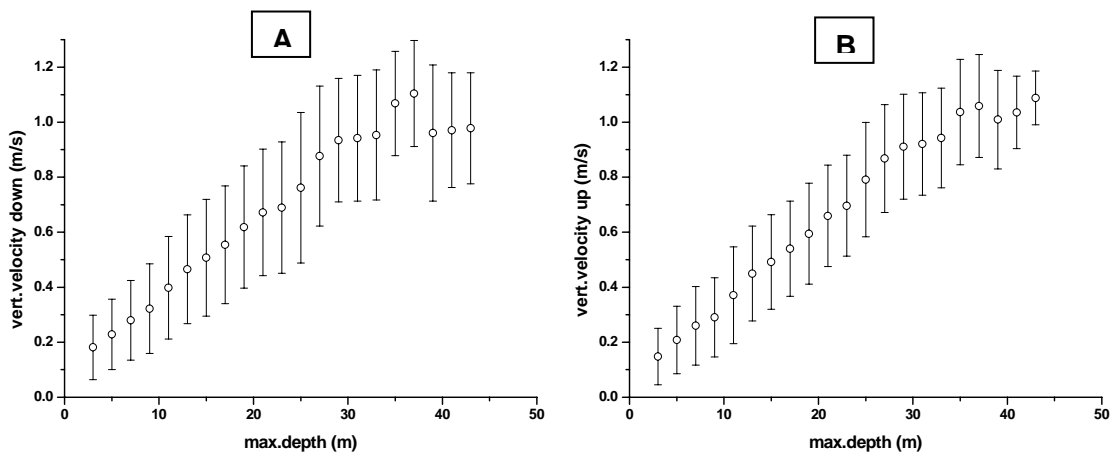


**Figure 46.** Rate of change of depth during the descent (black points) and ascent (red points) for all dives analysed (irrespective of dive type) from a single individual animal 'A'.

22; V-dives:  $r^2 = 0.83$ ;  $F = 19.608$ ;  $N = 21$ ) although the two dive types were significantly different from each other (Table 2; p. 146) (Fig. 49C & E).



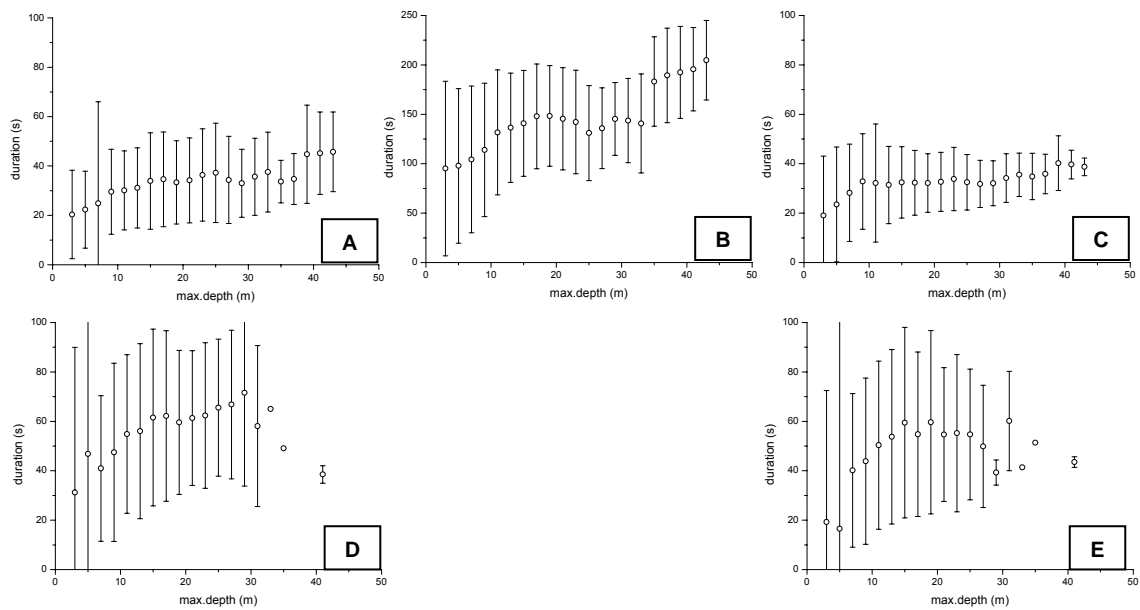
**Figure 47.** Mean rate of change of depth during (A) the descent and (B) the ascent for all dives analysed (irrespective of dive type) from all animals. Each line depicts a single individual.



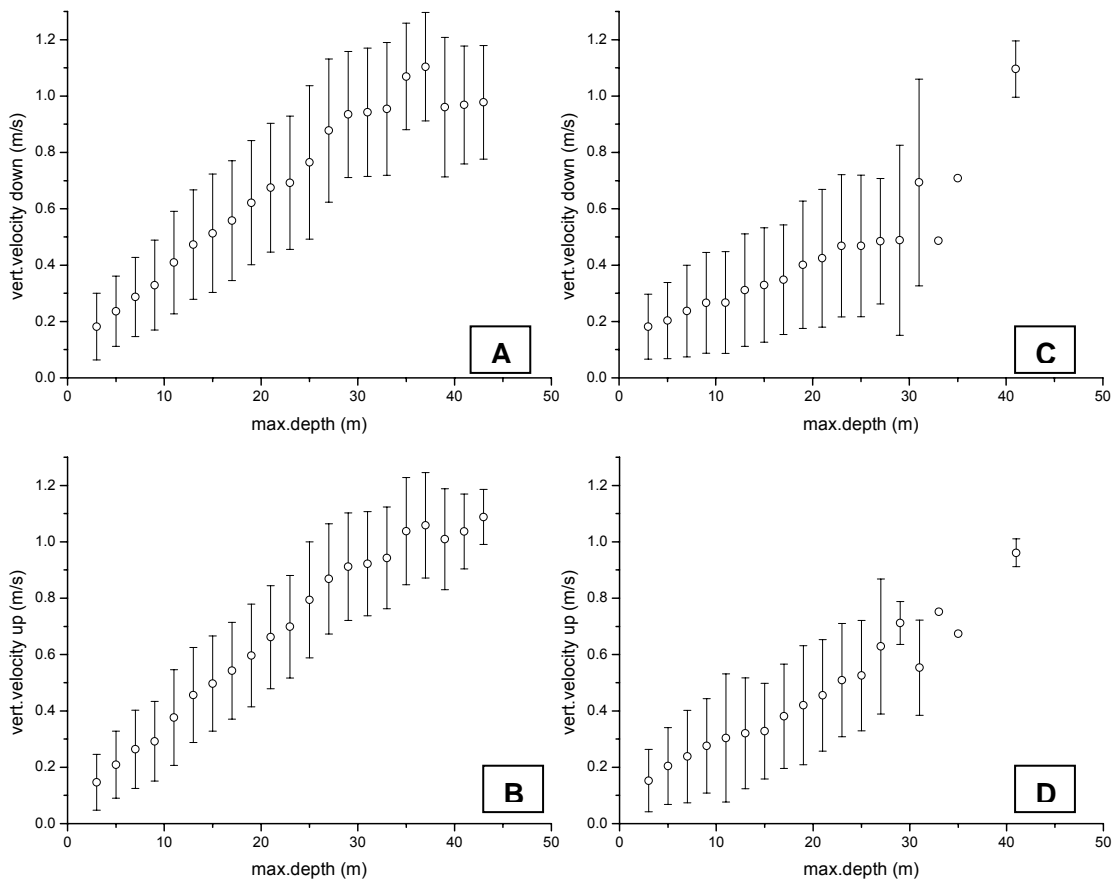
**Figure 48.** Overall mean rate of change of depth (the mean of all animal means) with SD during (A) the descent and (B) the ascent for all dives analysed (irrespective of dive type) from all animals.

In accordance with this, the vertical velocity for the descent and ascent phases of both U- and V-dives increased significantly with increasing maximum dive depth (U-dives:  $r^2 = 0.93$ ;  $F = 59.440$ ;  $N = 22$  and V-dives:  $r^2 = 0.99$ ;  $F = 516.231$ ;  $N = 21$  for the descent and U-dives:  $r^2 = 0.98$ ;  $F = 228.933$ ;  $N = 22$  and V-dives:  $r^2 = 0.98$ ;  $F = 122.646$ ;  $N = 21$  for the ascent) although there were significant differences between the two groups (Table 2; p.146) with both rates of descent and ascent being markedly lower in V-dives than in U-dives (Fig. 50). If the mean dive durations and vertical velocities are considered for each of the

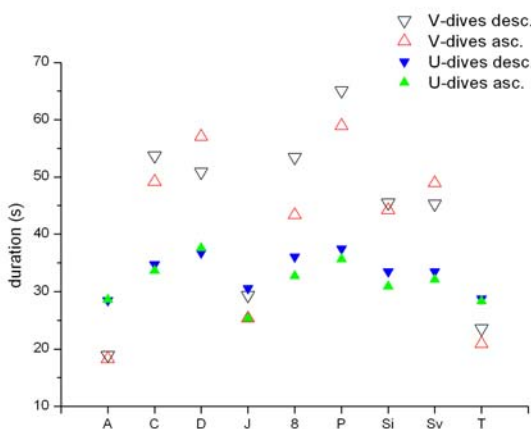
individual seals it is apparent that the durations of the ascent and descent phases are systematically longer in V-dives than in U-dives (6 of 9 animals;  $\chi^2_5 = 6.2$ ;  $P < 0.05$ ; Fig. 51) and that the vertical velocities are systematically lower in V-dives than in U-dives (all 9 of 9 animals;  $\chi^2_5 = 13.0$ ;  $P < 0.01$ ; Fig. 52). This is due to the difference in the gradient of the regressions shown in Fig. 50 but also due to the fact that V-dives, not reaching the seabed (cf. Fig. 38), tended to be shallower than U-dives anyway.



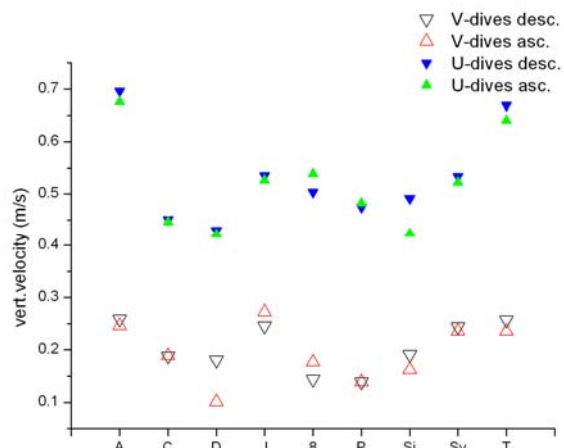
**Figure 49.** Overall durations (means of the individual animal means) with SD of these means for harbour seals for the various phases of the dive separated into U- and V-dives. Graphs (A), (B) and (C) show the durations of the descent, bottom and ascent phases for U-dives while graphs (D) and (E) show the durations of the descent and ascent phases for V-dives.



**Figure 50.** Overall vertical velocities (rates of change of depth) (means of the individual animal means) with SD of these means for harbour seals for the various phases of the dive separated into U- and V-dives. Graphs (A) and (B) show the values for the descent and ascent phases for U-dives while graphs (C) and (D) show equivalent values for V-dives.



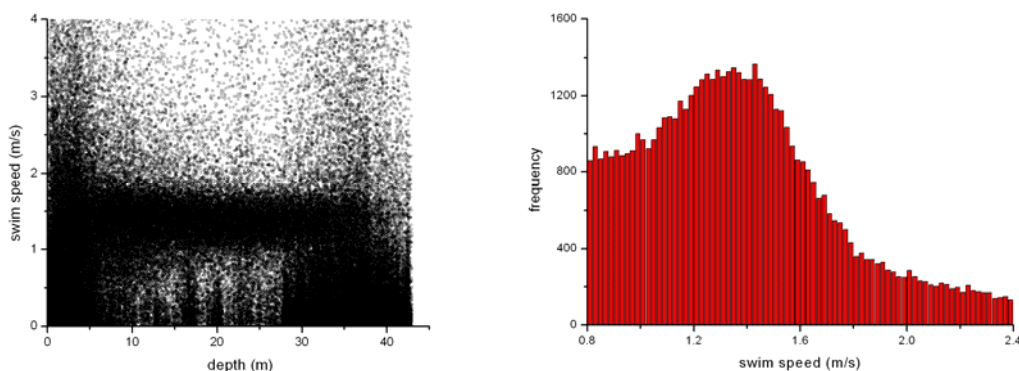
**Figure 51.** Mean durations for the descent and ascent phases for all harbour seals, U- and V-dives according to individual animal.



**Figure 52.** Mean vertical velocities for the descent and ascent phases for all harbour seals, U- and V-dives according to individual animal.

### *Swim speeds and pitch angles during dives*

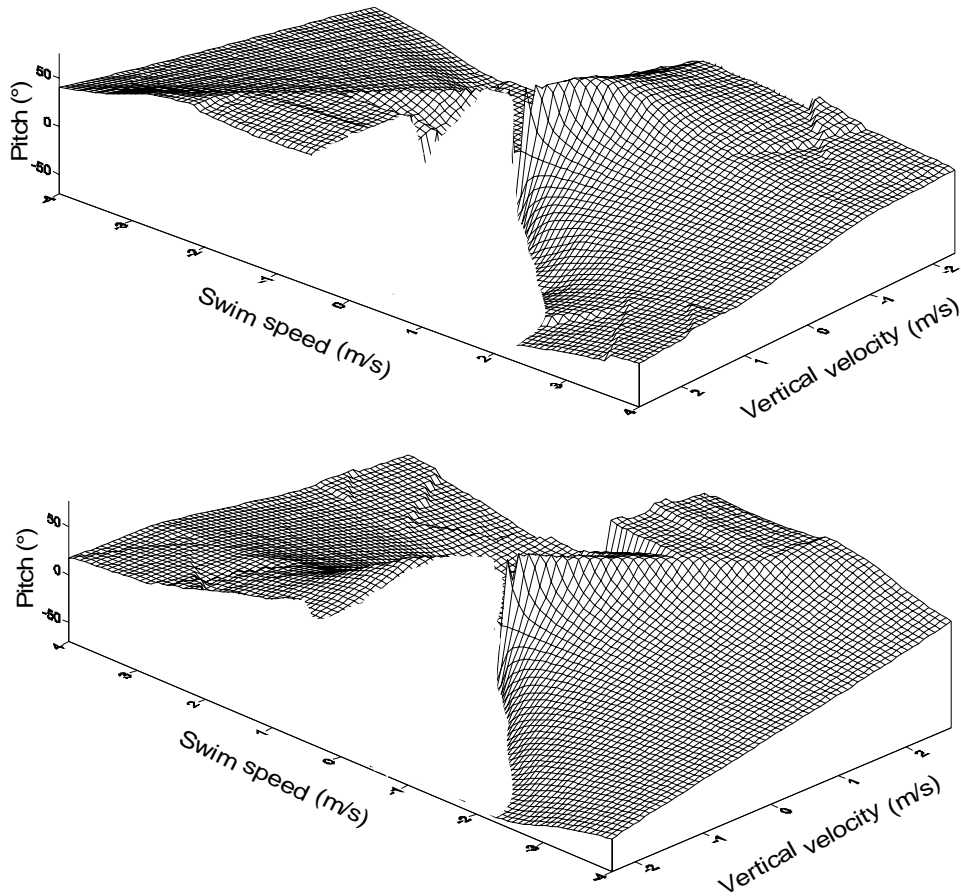
The swim speed sensors used during the study did not function well at low speeds, primarily because the axle about the moment arm did not rotate freely, possibly due to sand impeding it (see methods). However, speed could always be calculated for any period where there was a substantial change in depth over the recording period by using the descent/ascent angles from the pitch sensor and simple trigonometry (see methods). This approach showed that the equipped seals appear to have an optimum speed of travel which is of the order of 1.41 m/s (Fig. 53/54). It should be noted, however, that the best data in this regard came from animals where the recording frequencies were 3 s. In view of the



**Figure 53/54.** All swim speeds recorded from a single harbour seal ‘A’ as a function of the depth at which they were measured during a 12-day equipment period during which 6 foraging trips were undertaken. Speed was calculated by consideration of descent/ascent angles with respect to the rate of change of depth (see text). Each point shows a single measurement and measurements were made once every 3 s. The most commonly used speeds are apparent by the density of the points. (54) Frequency distribution of the swim speeds recorded in (53) above.

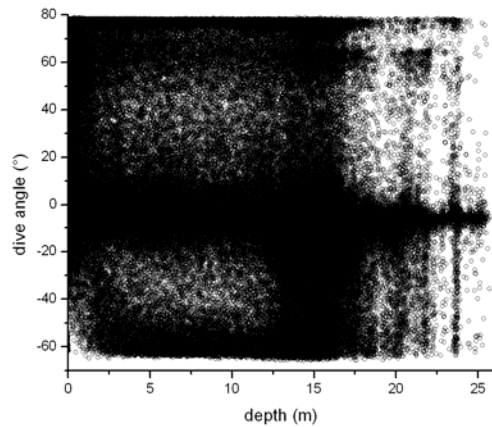
errors that are incurred with increasing sampling periods, particularly in view of the shallow depths to which these animals are constrained to dive in their foraging area, it is unwise to present systematic data for speed from all individuals.

The calculation of swim speed using rates of change in depth and descent/ascent angles produces a clear pattern of how these three parameters

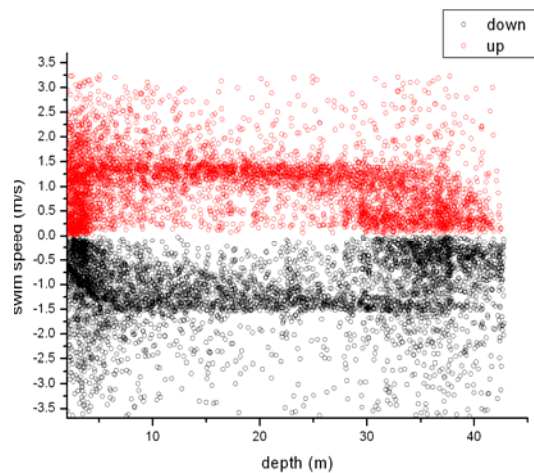


**Figure 55.** Surface plot showing the relationship between swim speed, pitch angle and rate of change of depth (vertical velocity) in a diving harbour seal (A). Data compiled from 3015 dives. Note negative values refer to the ascent- while positive values to the descent-phase.

are integrated together in diving harbour seals (Fig. 55). This representation does not, however, indicate the preferred pitch angles used during the descent and ascent. Most descent and ascent angles were relatively steep (Fig. 56) which, after equating with the rates of change of depth (Fig. 50), translates into well-defined, and relatively constant (and independent of maximum depth) swim speeds during the transitions between the sea surface and the seabed (Fig. 57).



**Figure 56.** Instantaneous dive angle (descent and ascent) as a function of the depth at which it occurred for all measurements made in an individual seal (C) where the sampling rate was 15 sec. Note the increased density (incidence) of descent and ascent angles around 80° and -60°, respectively, as well as the large number of points around 0°. The points around 0° apply to periods where the animal was swimming along in the bottom phase.



**Figure 57.** Instantaneous swim speed as a function of the depth (black = descent; red = ascent) at which it occurred for measurements made in an individual seal (A) where the sample rate was 3 seconds. The data from this animal have been trimmed from 338,602 points to 5000 so as to highlight changes in density.

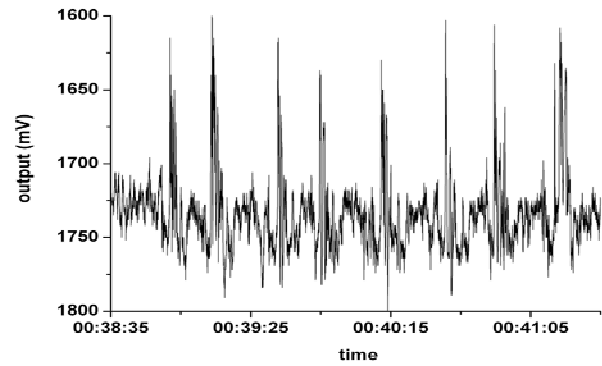
### 3.1.4 Feeding

#### *Captive harbour seal feeding on dead prey*

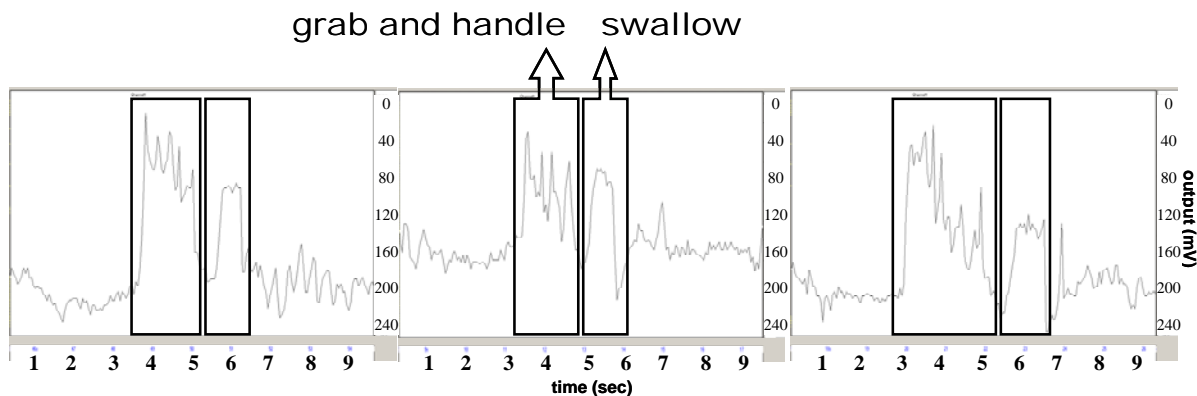
During the two trials, where a total of five feeding sessions were conducted, 61 dead Herring were fed to the seal. Their length ranged from 13 – 25 cm (mean: 20.7 cm; SD: 2.36) and their weight from 20 – 117 g (mean: 68.3 g; SD: 22.1; sum: 4.166 kg). Between 10 and 19 prey items (mean: 12.2) were given to the animal during each session, which lasted between 8 and 15 minutes (mean: 11 min; sum: 55 min). All feeding events were clearly distinguishable in the recorded data (Fig. 58). Each prey handling event resulted in a specific pattern of jaw-opening angle over time (Fig. 59) consisting of two phases; a grab and handling phase followed by a swallowing phase. The first phase started with an initial, fast and extensive jaw-opening, producing the greatest angle for most of the feeding events, followed by a cascade of smaller, rapid peaks with



decreasing maximum values and concomitant decreasing minimum angles in the troughs. The event ended after the jaw angle returned to the baseline representing a closed mouth. These signals related first to the initial snap of the seal to secure its prey before subsequent manipulation before the prey was swallowed head first. The swallowing phase consisted of a relatively slow jaw-opening and closing, producing a flat plateau in the jaw angle data whose maximum value was usually less than that recorded during the previous phases (Fig. 59).

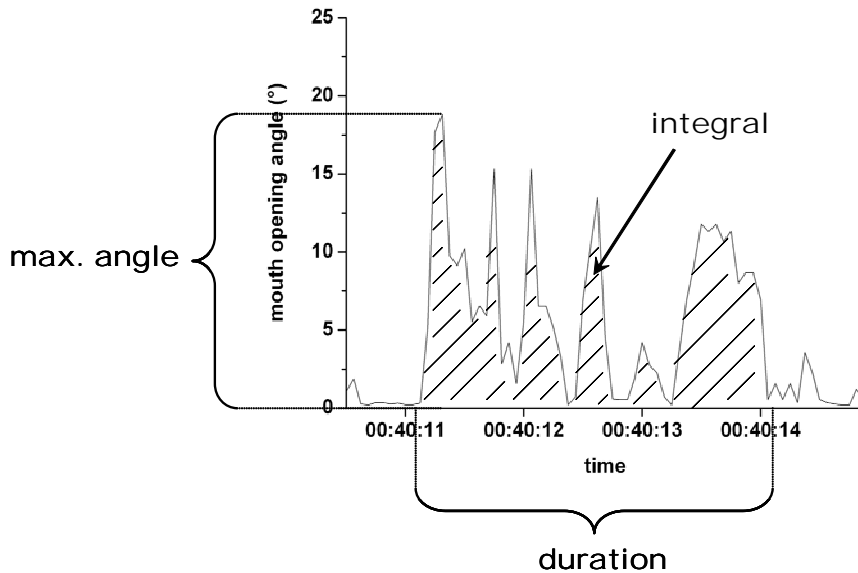


**Figure 58.** Example of recorded magnetic field strength over time. Eight feeding events of a captive harbour seal feeding on dead herring are shown, where changes in jaw angle are represented by the variation in magnetic field strength.



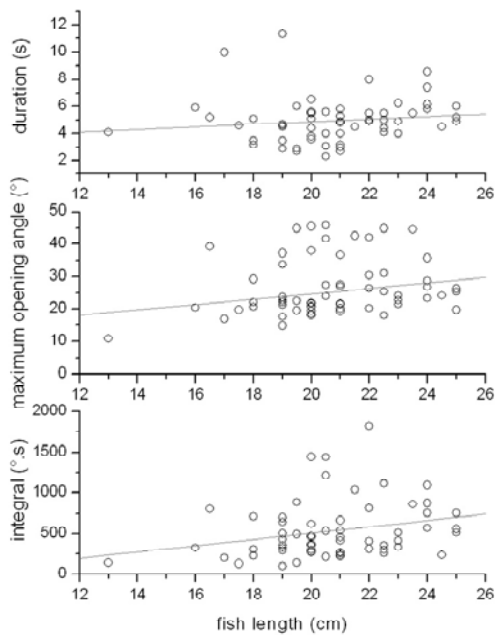
**Figure 59.** Three examples of feeding events of a captive harbour seal feeding on dead herring, where the different phases of the events are marked in the logger-output data over time. The ‘grab and handling’ phase starts with an initial, fast and extensive jaw-opening followed by a cascade of smaller, rapid peaks with decreasing maximum values and concomitant decreasing minimum angles in the troughs. The ‘swallowing’ phase consisted of a relatively slow jaw-opening and closing, producing a flat plateau in the jaw angle data.

The program MT-Beak calculated duration, maximum angle and integral (Fig. 60) of the jaw angle data over time for each feeding event, these being the main parameters defining feeding events (Wilson et al., 2002). The events lasted between 2.3 s and 11.3 s (mean: 4.9 s; SD: 1.7). The mean maximum mouth opening angle was 26.7 ° (SD: 8.8) ranging from 10.8 ° to 45.8 °. Values for the integral of the mouth opening angle curve over time ranged from 98.7 °.s to

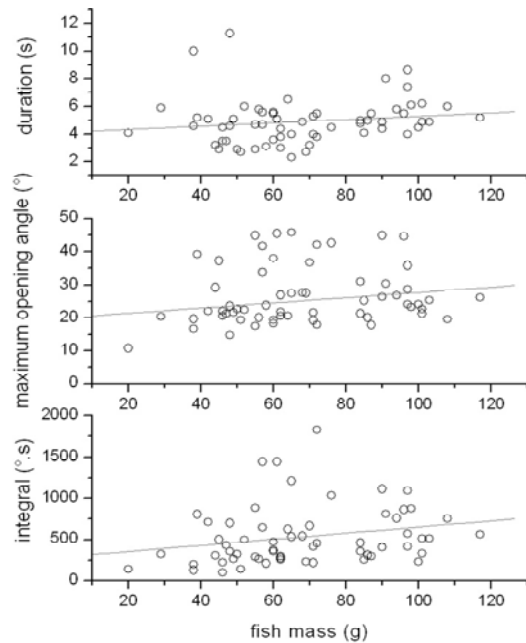


**Figure 60.** Mouth opening angle curve over time of one feeding event of a captive harbour seal feeding on a dead herring. The parameters calculated by the analyses software, by which feeding events can be defined (duration, maximum opening angle and integral), are marked.

1824.4 °.s, with a mean value of 534.0 °.s (SD: 356.7 °.s). Plots of all calculated parameters (duration, maximum angle and integral) against the measurements obtained from the prey items (weight and length) (Fig. 61/62) together with linear regressions (STATEasy 2000 - J.L.Lozań, Germany) showed that the only significant relationship was that between fish length and integral and the



**Figure 61.** Relationship between feeding event parameters (duration, maximum opening angle and integral) and fish length.

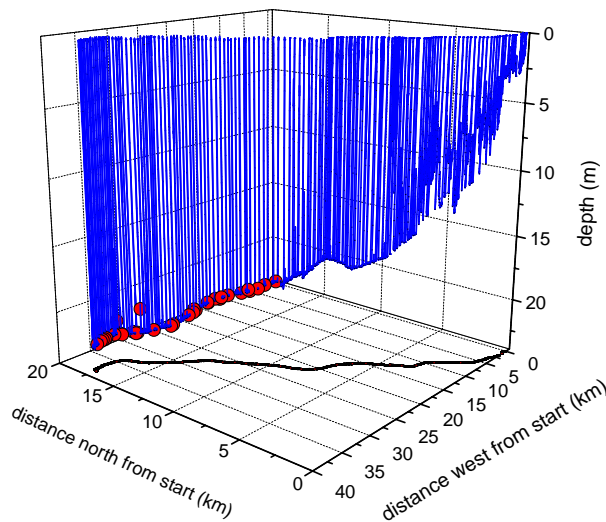


**Figure 62.** Relationship between feeding event parameters (duration, maximum opening angle and integral) and fish mass.

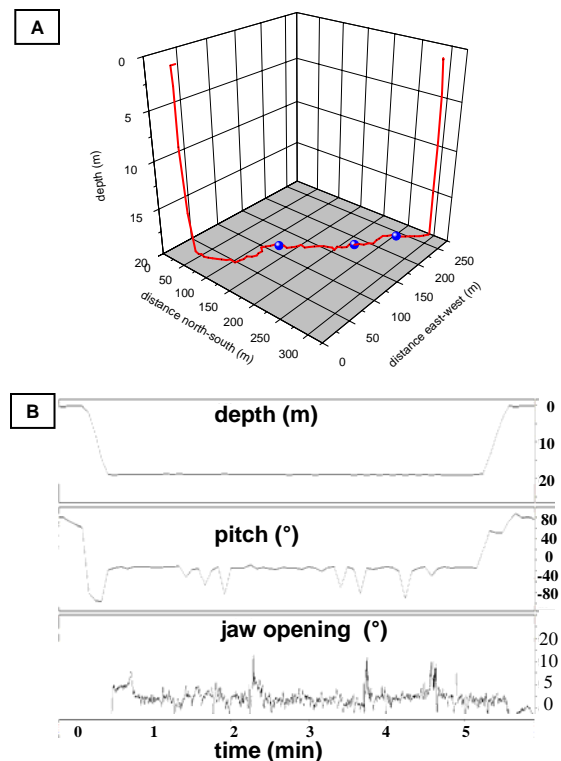
correlation coefficient was low (Table 3; p. 147).

### *Data from free-ranging harbour seals*

Few IMASEN data had been recovered from harbour seals foraging in the wild up to the point of submitting this thesis. The main reasons for this were device failures primarily due to leakage in the battery housing or animals not foraging during the short period of recording (animal 'C' (33.67 h) and 'Sv' (3 d 21.27 h), which stayed around the haul-out site in shallow waters). Only the IMASEN on seal 'Sv' was still recording when the animal started a foraging trip, covering the first 14.04 h while the animal was travelling to its foraging grounds. During this period, 34 feeding events could be identified, all of which occurred after the water depth had exceeded 15 m (Fig. 63). Despite prey encounters, the seal maintained its travel direction (Fig. 63/64), indicating that such encounters



**Figure 63.** 3-dimensional view of the first 14.04 h of a foraging trip undertaken by a seal (Sv) with feeding events (red spots) and 2-dimensional projection of the track (red line).

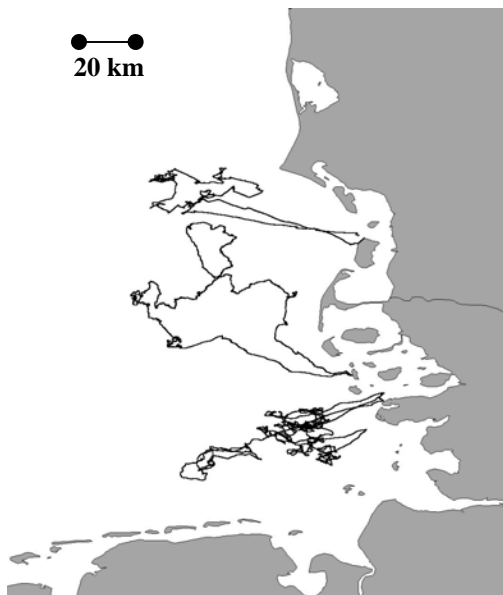


**Figure 64.** Example of a dive during the transit phase of seal 'Sv', which maintained its travel direction despite prey encounter; (A) 3-dimensional view with prey-encounters marked as blue spots; (B) depth, pitch and jaw opening movements over time during the dive.

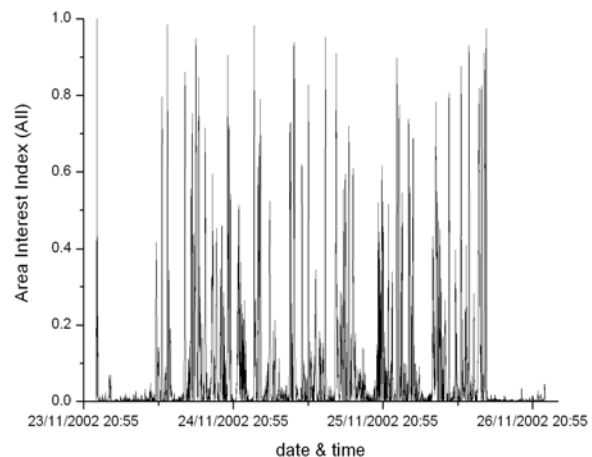
during transit phases of foraging trips were not sufficient to trigger meandering, typical of foraging behaviour in the target foraging site (see later).

### 3.1.5 Tortuosity of tracks: Area Interest Index (AII)

Consideration of the horizontal component of the movement of seals during the foraging trips shows that there was a great degree of variability in the extent of meandering during the course of any particular foray (Fig. 65). In general, however, movement to and from the haul-out site is highly directional with extreme meandering only being apparent during the central phase of the foray. Changes in the degree of meander of the swim course can be conveniently examined using the Area Interest Index (AII) (see methods) (Fig. 66). Consideration of individual tracks shows a fairly standard pattern with a fairly high incidence of values around 0, particularly at the beginning and end of foraging trips (aside from a short period of orientation/play or equivalent immediately adjacent to the colony) although values around 1 may occur at any time. During the central part of the foraging trips the AII rises periodically to values around 1, although all values between 1 and 0 occur. Oscillations

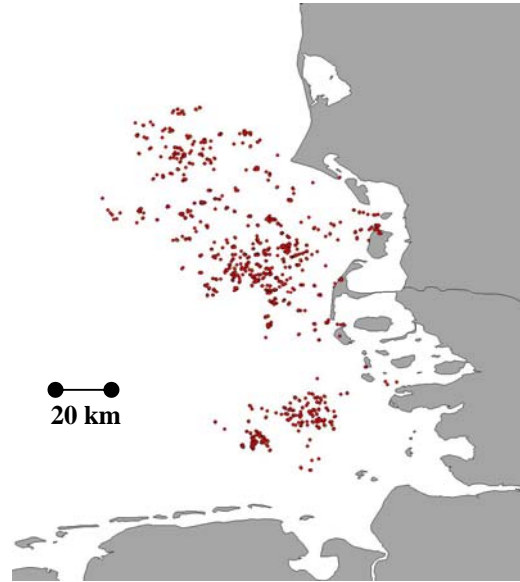


**Figure 65.** Examples of foraging trips from different harbour seals showing the degree of variability in the extend of meandering.



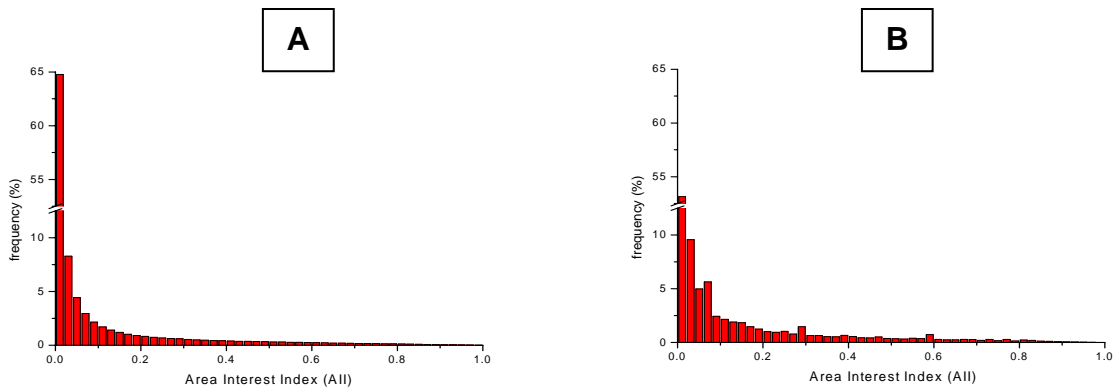
**Figure 66.** Typical pattern of the AII (calculated over 1200 s intervals) during one foraging trip with high incidence of values around 0, particularly at the beginning and end of foraging trips representing the transit phase, whereas values around 1 only occur in the foraging area and around the haul-out site (see text).

between 1 and 0 during this period (Fig. 66) are probably due to the patchiness of prey distribution. It is likely that the seals exhibit a high incidence of turning in profitable areas but travel rapidly (with well-defined directionality) between them (Wilson et al., in press). This behaviour has been well defined for a large variety of animals (cf. Samietz & Berger, 1997 and refs therein) but has not been described for seals, primarily because of the technical difficulties of quantifying movement in these animals. Consideration of areas where the AII is around 1 should help define localities which are considered to be particularly profitable, and therefore important to seals (Fig. 67). Location-dependent AII's will be considered in more detail below.



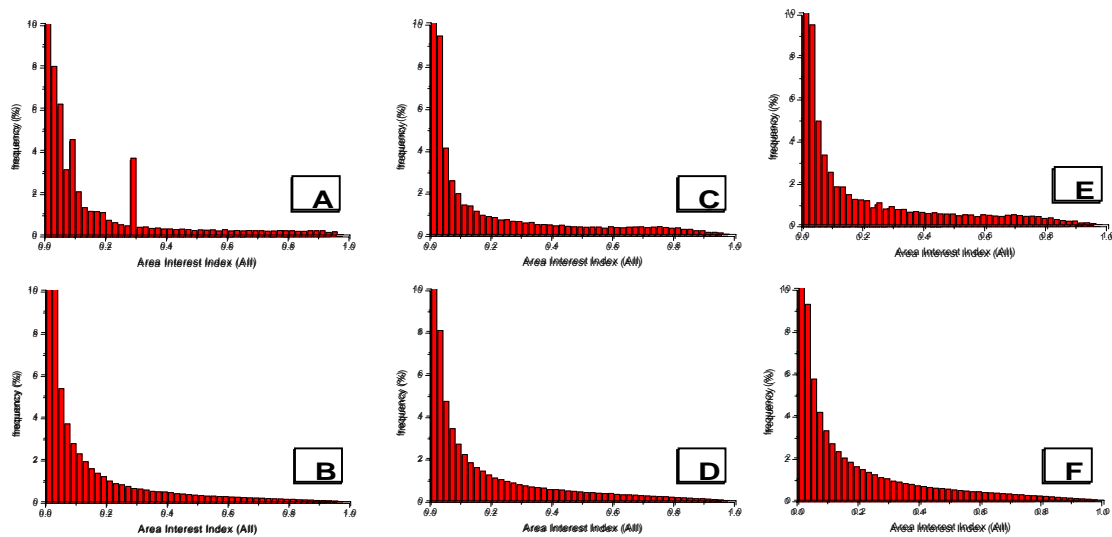
**Figure 67.** Locations with AII greater than 0.9 from all harbour seals.

Consideration of the frequency of occurrence of all AII's for all animals shows that there is a well-defined maximum around 0 (Fig. 68A). This presumably represents travel between zones of interest. The frequency of occurrence is represented by an exponential drop, with increasing AII. The



**Figure 68.** Frequency distribution of AII's from all harbour seals calculated over 1200 s intervals (A) and 30 s intervals (B).

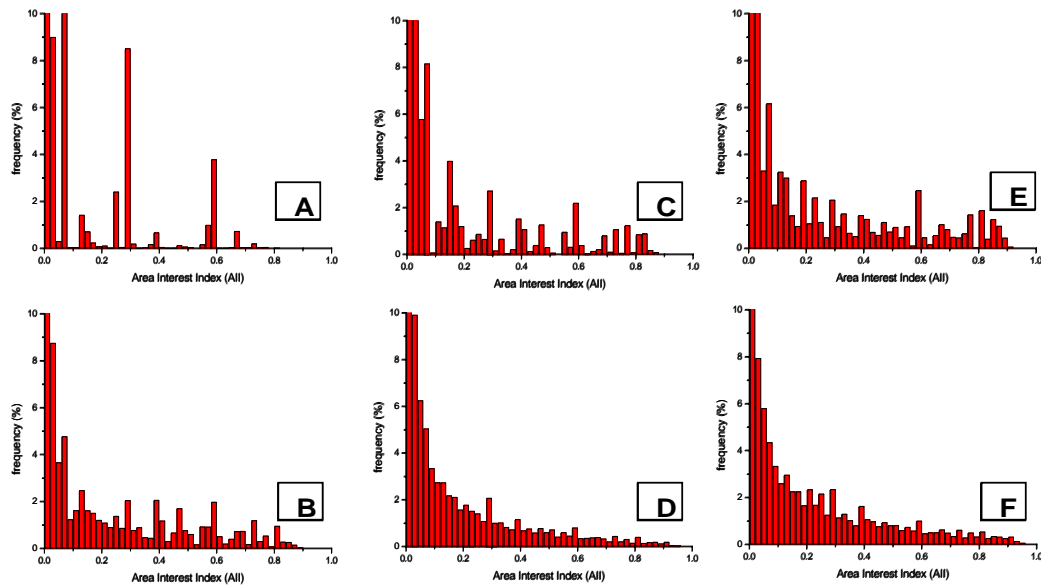
consistency of this curve can be related to the relatively coarse temporal scale with the All being calculated over 1200 s intervals (Fig. 68A). Consideration of the frequency of occurrence of all Alls for all animals at intervals of 30 s still shows the same basic exponential drop but it is more irregular, with small peaks around values of 0.07, 0.29 and 0.59 (Fig. 68B). Calculation of the All over different temporal intervals for different animal shows some degree of variation as well as the general trend of smoother declines at longer All intervals (Fig. 68). Comparison of individuals from the two colonies, Rømø (Fig. 69) and



**Figure 69.** Frequency distribution of Alls for different animals from Rømø calculated over different intervals; (A) animals ‘Sv’ over 10 s; (B) animal ‘Sv’ over 30 s; (C) animal ‘J’ over 10 s; (D) animal ‘J’ over 30 s; (E) animal ‘T’ over 10 s; (F) animal ‘T’ over 30 s.

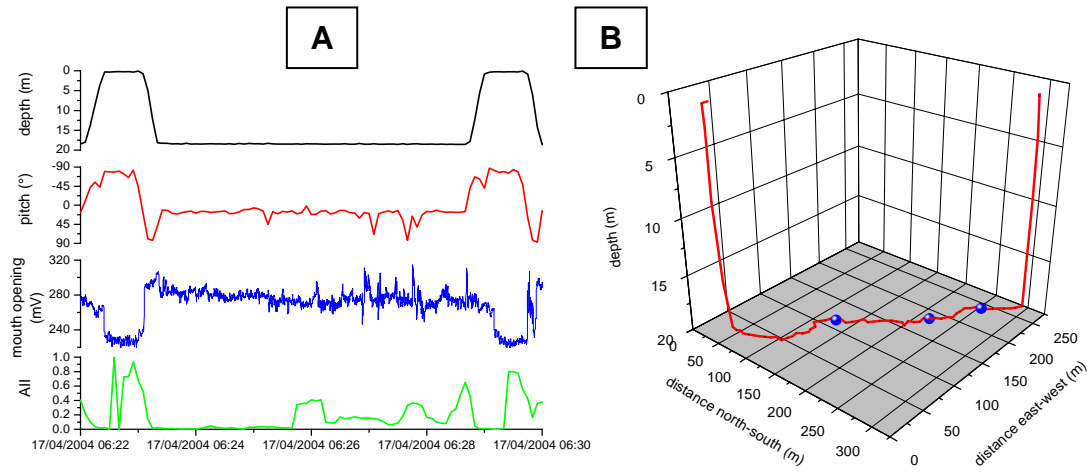
Lorenzenplate (Fig. 70), indicates that there are different patterns between the colonies as well as between animals from the same colony although the low sample size precludes robust statistical tests.

In essence, the ‘Danish’ animals had a much more regular decrease in incidence of Alls with increasing All than the ‘German’ animals for the same temporal All interval (cf. Fig. 69/70). Peaks occurred apparently irregularly although it was striking that the seals from the Lorenzenplate had a substantial peak at an All of 0.6, and further ones around 0.3 and 0.05 (see 30 and 40 s interval in Fig. 70). The 0.3 All peak was only apparent in the ‘Danish’ animals at an All interval of 10 s (Fig. 69). The peaks essentially highlight a frequently-



**Figure 70.** Frequency distribution of AII for different animals from Lorenzenplate calculated over different intervals; (A) animals 'A' over 30 s; (B) animal 'A' over 90 s; (C) animal 'C' over 30 s; (D) animal 'C' over 90 s; (E) animal 'P' over 40 s; (F) animal 'P' over 80 s.

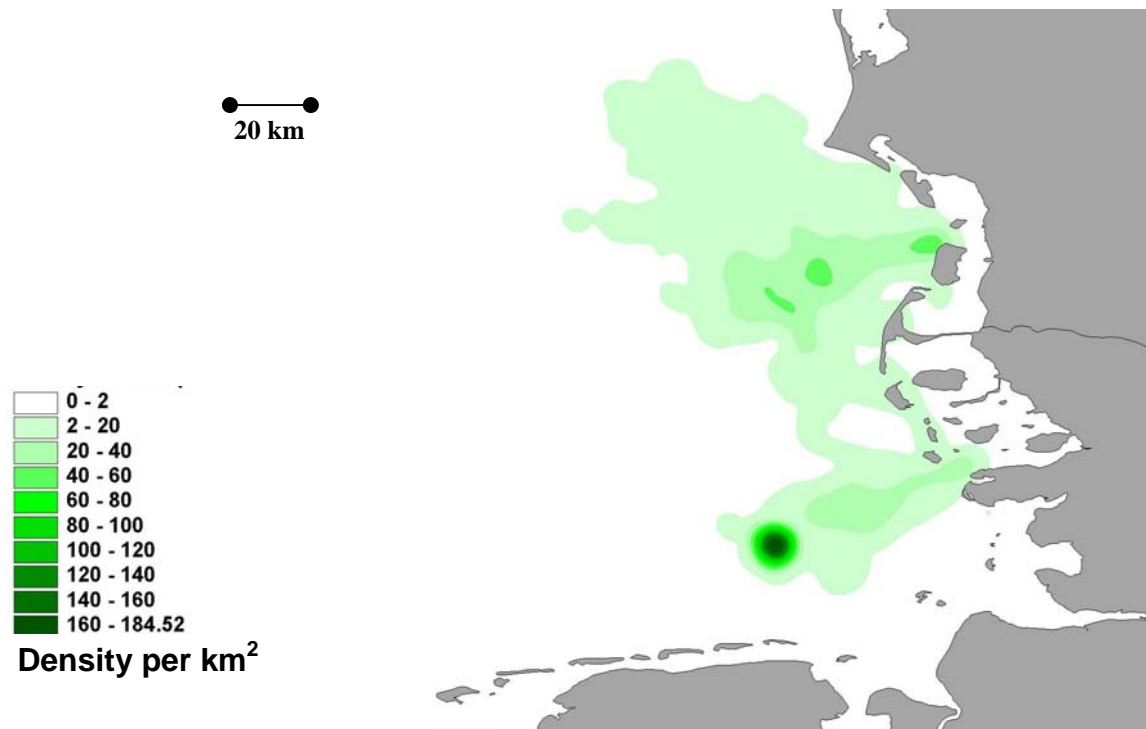
executed particular pattern of tortuosity. This, in turn, corresponds to a particular manner of moving through the environment. Given that harbour seals are known to be able to locate their prey by using their whiskers, which are sensitive to 'turbulent trails' left by fish in the water (Dehnhardt et al., 1998; Dehnhardt et al., 2001), it seems likely that at least one of the peaks may be due to that; the particular tortuosity in the tracks of harbour seals locating prey may be likened to a dog sniffing out a reward (Dehnhardt pers.comm.) so higher incidences of particular AII-values occurring with a specific higher frequency, however, foraging theory predicts that generally higher degrees of tortuosity (or AII-values) should relate to higher prey density because this results in area-restricted search (Bailey & Thompson, 2006). Thus, inspection of AII-values with respect to locality should help to allude to areas which are lucrative for seal foraging.



**Figure 71.** Graphic representation of the changes in recorded parameters associated with the dive type believed to feeding (A) changes in depth, pitch and jaw opening and (B) a 3-d diagram of the movement of an animal during such dives (blue spots represent feeding events).

*Travelling/commuting. (horizontal)*

Consideration of the highly directional movement (All <0.1) shows, if all trips from all seals are compared (corrected for pseudoreplication) (Fig. 72), that, although harbour seals may travel at any time during their foraging trips, particularly high incidences occur between the haul-out spots and the main



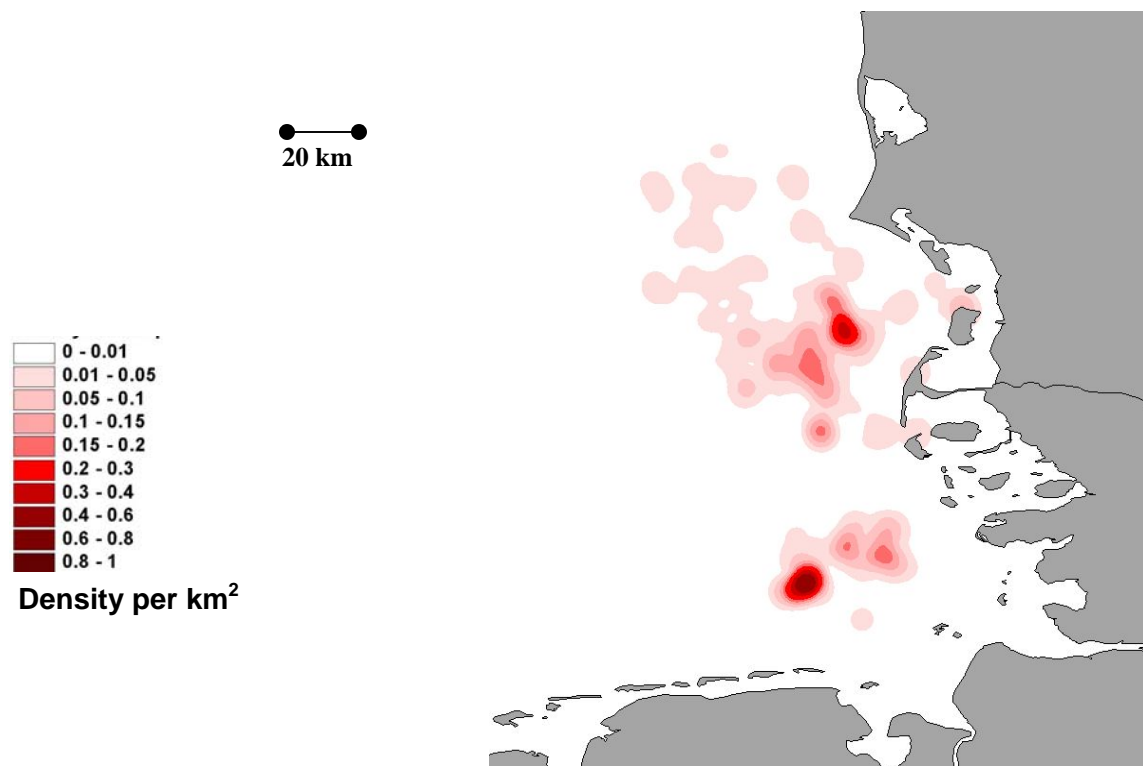
**Figure 72.** Area interest index-dependent area usage for AII values < 0.05 (animals exhibiting highly directional travelling). Corrected for pseudoreplication.



foraging spots (see below) with track taking a predominantly West-South-West: East-North-East orientation (Fig. 72). The circle (of radius ca. 10 km) immediately South of Helgoland is due to the use of the area by one animal (A), which discontinued the use of the Lorenzenplate as a haul-out spot and foraged within a very small area adjacent to Helgoland, thus increasing the density of points in that area.

*Foraging/non-directional movement.*

Consideration of the area-dependent distribution of AIIIs with values greater than 0.9 from all data (corrected for pseudoreplication), which are likely to be associated with foraging, shows several clusters (Fig. 73) lying within the areas with the highest distribution density (see B and C in Fig. 32). The greatest



**Figure 73.** Area interest index-dependent area usage for AII values > 0.9 (animals exhibiting intense area searching (likely feeding)). Corrected for pseudoreplication.

density of the distribution lies south-west of Helgoland. As with the travelling behaviour, this is due to a single animal foraging from Helgoland in a very limited area. Although it highlights the importance of the area in a general sense,

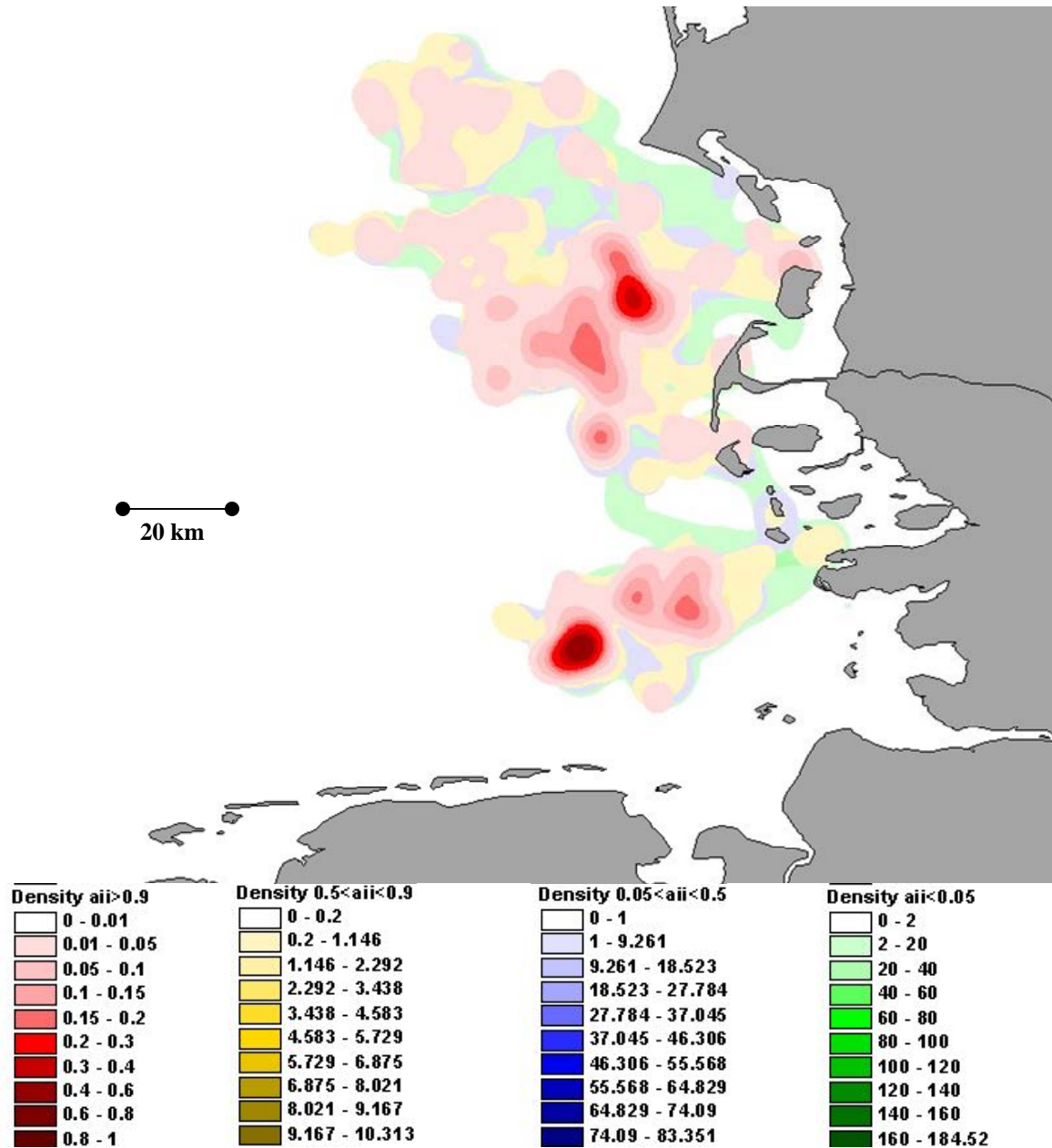
particularly for seals using Helgoland as a haul-out spot, it does not constitute an area of importance for animals commuting to and from the Wadden Sea. The areas likely to be used by harbour seals for foraging from the Wadden Sea are located in water ca. 10-20 m deep up to 80 km from the coast. The single point of higher AI Indices at the northern coast of Rømø stems almost certainly from behaviour representing milling around the colony since IMASEN data show no feeding for locations in shallow water within the Wadden Sea (see later, cf. Fig. 63/64/71).

#### *Area use for different AIs*

Fig. 74 shows a composite highlighting the main zones of importance according to the incidence of different AIs of all seals (corrected for pseudoreplication). The green shows behaviour interpreted as travelling ( $AI < 0.05$ ; where animals hardly deviate from a straight-line course), linking the different main foraging grounds and the haul-out sites with one another. If the small red and yellow distributions immediately around the Lorenzenplate and Rømø are ignored (as being due to milling around in the vicinity of the haul-out spot), this indicates that seals apparently do not begin to search for prey until they reach water that is at least 10 m deep. Aside from the odd prey item that might be opportunistically taken, the coastal areas, therefore, appear to play no role in feeding, apparently being primarily used for resting at most times. Whether this situation is applicable for the whole year will have to be determined by further research with, in particular, animals being equipped with devices for the summer period.

Blue and yellow, respectively, in Fig. 74 show an increasingly meandering course by seals approaching the main feeding areas (marked in red). This accords with general foraging theory where central place foragers (sensu Orians & Pearson, 1979) should minimize the distance travelled away from their central spot; the increasingly meandering behaviour allows animals to sample their environment ever more intensively while still maintaining a net movement away from the haul-out spot.

The red sections in Fig. 74 are likely to be areas in which feeding occurred (see also below) because the directionality of horizontal movement is reduced to less than 10 % of that possible.



**Figure 74.** Area-dependent AII for all animals and corrected for pseudoreplication. The diagram shows areas likely to be used in feeding (red:  $AII > 0.9$  - note that the red around the haul-out sites is likely to be milling behaviour) and transit (green:  $AII < 0.05$ ) as well as those used for less directional travelling (blue:  $0.05 < AII < 0.5$ ) and substantially meandering movement (yellow:  $0.5 < AII < 0.9$ ).

### 3.1.6 Dive types according to proposed function

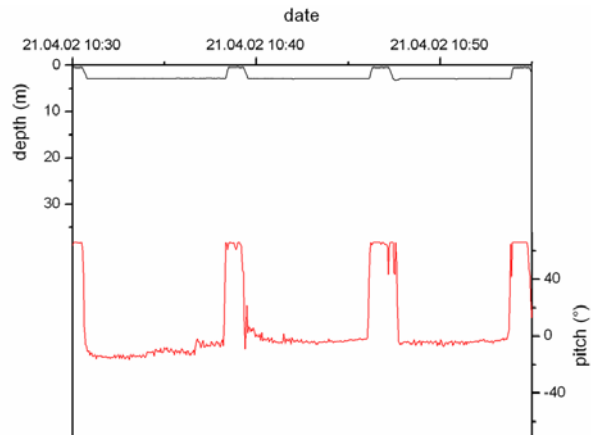
Consideration of the systematic changes in dive parameters (above) may be used to propose five major behaviours;

#### *Sleep*

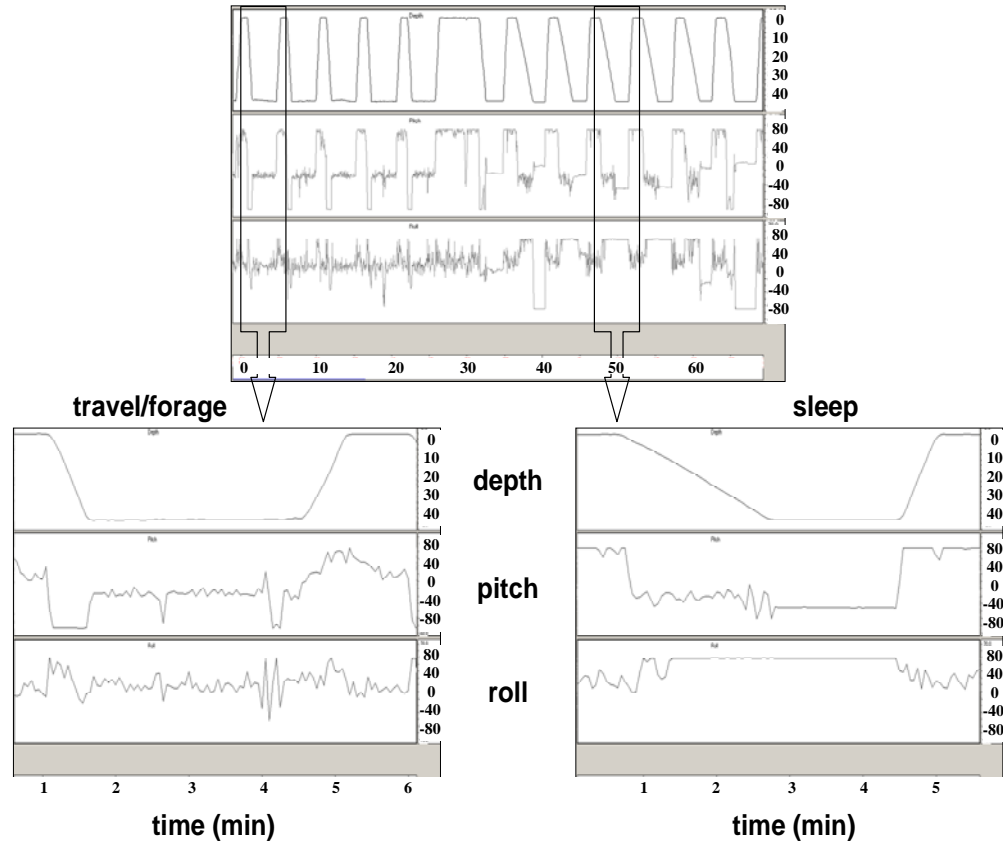
These dives are generally characterized by dive depths that do not exceed 8 m (and are generally to less than 5 m) with extended bottom durations (up to 8 minutes). Such extended periods are presumably possible as a result of reduced metabolic rate (and consequent oxygen use) associated with sleep. There is no relationship between dive duration and dive depth. Body pitch angle during the descent shows that the animal tends to point up, slowly sinking with the body moving to the horizontal position by the time the seabed is reached (Fig. 75). Descent rates are slow and are presumably passive. The bottom phase of the dive is typified by no change in heading or pitch but occasional slight rolling (Fig. 76).

There is indication that rest/sleep in harbour seals may take another form other than that described above, occurring during foraging trips. Here, the animals may remain vertical, motionless at the water surface for periods up to 45 min, often followed by dives where they sink slowly to the bottom (at vertical descent rates of *ca.*

0.33 m/s) up to depths of 40 m where they lie horizontal (see pitch sensor) motionless, often on one side (indicated by the roll sensor) for periods around 1.5 min before returning to the surface to breathe (Fig. 76).



**Figure 75.** Graphic representation of the changes in recorded parameters associated with the dive type believed to constitute sleep.

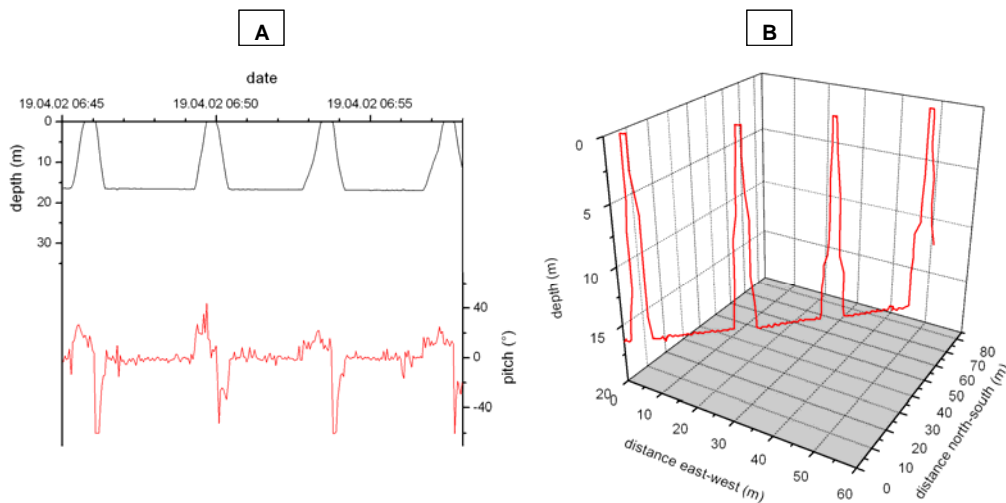


**Figure 76.** Graphic representation of changes in depth, pitch and roll of a seal exhibiting a transition from normal searching/foraging (see Fig. 79/80) to deep-water sleep. The upper graph shows a section of the data comprising 12 dives. The first 5 dives involve searching/foraging where the rates of descent are high, as is pitch at this time. The bottom phase of dives shows variability in pitch and roll values, both oscillating around 0°. This searching/foraging dives are followed by some 5 min rest at the surface before the animal engages in a single dive of intermediate function before undertaking 6 ‘sleep’ dives.

### *Travel*

These dives are executed to the seabed with descent and ascent angles, and vertical velocities, that increase with increasing maximum dive depth. Descent and ascent angles are steep ( $>70^\circ$ ) and swim speeds are approximately constant at this time, being of the order of 1.4 m/s and 1.3 m/s respectively. There is an extended bottom phase to the dive and descent, bottom and ascent durations are all positively, linearly correlated with maximum depth. Swim speed along the bottom is approximately 1.4 m/s and heading at this time is approximately constant, as it is during both the descent and ascent phases of the dive. Area interest indices are rarely greater than 0.05 for the whole dive (Fig.

77). It is primarily the invariance of the heading over extended time scales that results in this dive type being ascribed to travelling. It certainly results in very efficient, rapid movement of seals from one area to another. There are potentially four possible reasons why animals might dive to the bottom during such dives: (i) this removes them from the surface where turbulence effects increase drag and therefore energy expenditure although it is acknowledged that this effect is only important up to depths of three body diameters (Fish, 1998), (ii) travel along the bottom might allow animals to assess prey density along the way so that fortuitous zones can be exploited, (iii) travel along the seabed may help the animals with orientation by providing, for example, visual or olfactory landmarks and (iv) seals may be less exposed to predation (sharks, killer whales) or general disturbance (boat traffic).

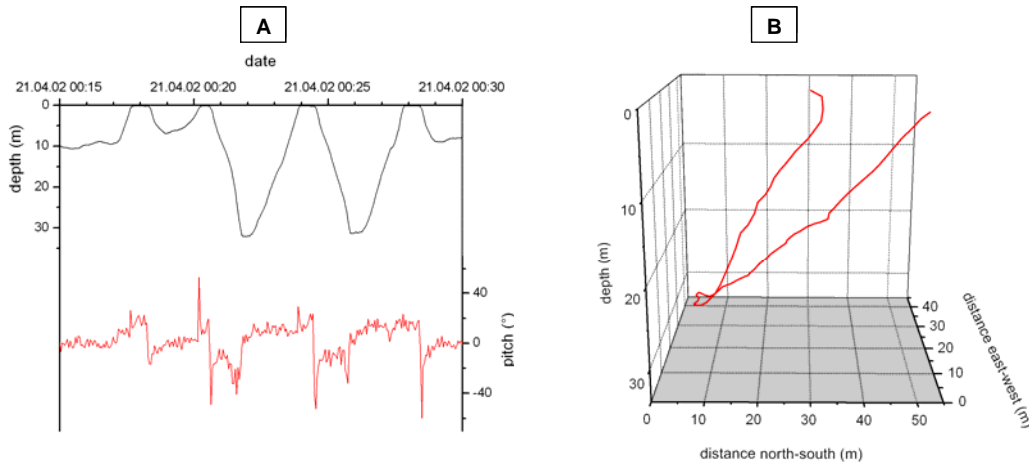


**Figure 77.** Graphic representation of the changes in recorded parameters associated with the dive type believed to constitute travelling (A) changes in depth and pitch and (B) a 3-d diagram of the movement of an animal during such dives.

### *Prospecting*

These dives have a V-shaped profile (no bottom phase) and descent and ascent angles that are markedly shallower than those during travel, searching or feeding dives, although angles during both descent and ascent correlate positively with maximum depth reached. In keeping with the dive angles, which accord with animal pitch, vertical velocities are lower than in all other dives

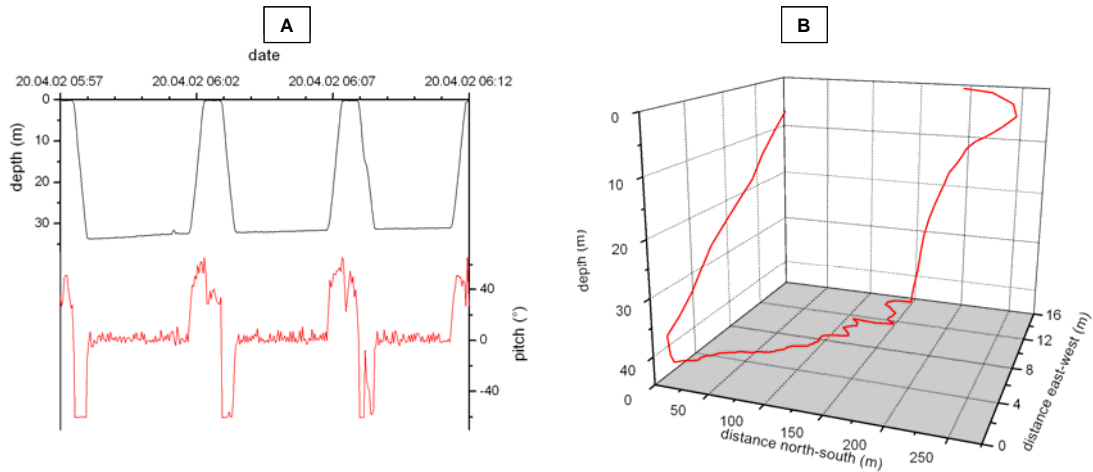
except sleep (Fig. 78). The function of this dive remains speculative. However, the characteristics lead to relatively efficient travel from one area to another while sampling the water column. This type of dive might be instigated under particular conditions, such as when pelagic fish are in the vicinity. In this respect it should be noted that 13.8 % of the diet of harbour seals might be composed of pelagic fish (Brown & Pierce, 1997; Brown & Pierce, 1998; Pierce & Santos, 2003).



**Figure 78.** Graphic representation of the changes in recorded parameters associated with the dive type believed to constitute prospecting (A) changes in depth and pitch and (B) a 3-d diagram of the movement of an animal during such dives.

### Search

These dives are executed to the seabed with descent and ascent angles, and vertical velocities, that increase with increasing maximum dive depth. Descent and ascent angles are steep ( $> 70^\circ$ ) and swim speed is approximately constant at this time, being about 1.4 m/s. There is an extended bottom phase to the dive and descent, bottom and ascent durations are all positively, linearly correlated with maximum depth. Swim heading along the bottom is variable, but pitch along the bottom remains relatively constant around zero (Fig. 79).

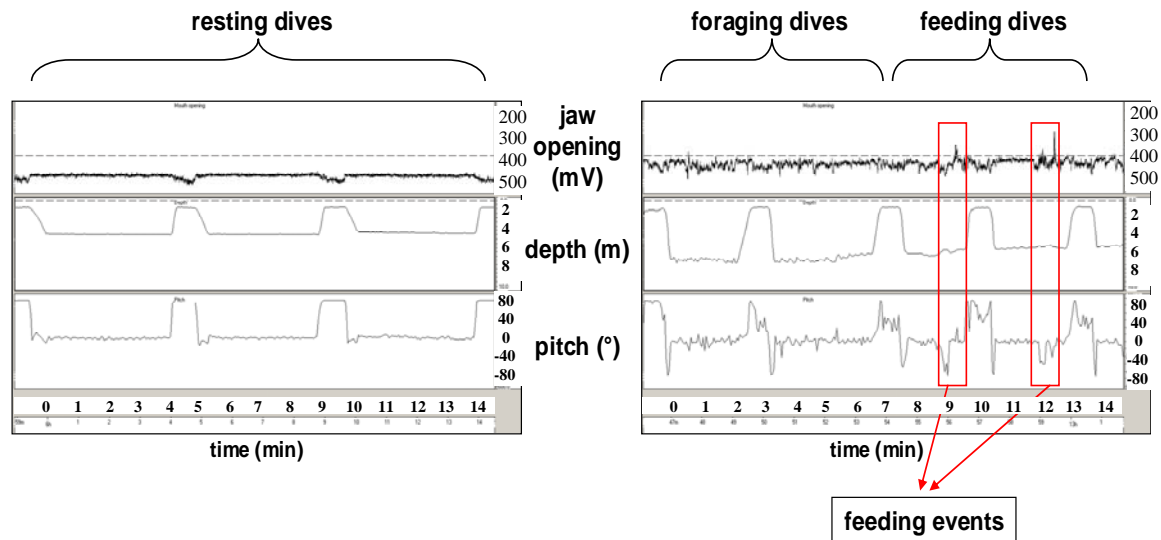


**Figure 79.** Graphic representation of the changes in recorded parameters associated with the dive type believed to foraging (A) changes in depth and pitch and (B) a 3-d diagram of the movement of an animal during such dives.

### *Feeding*

These dives are similar to ‘search’ dives but differ in that prey is believed ingested. Thus, ‘search’ dives become ‘feeding’ dives when prey is encountered. Typically, prey encounter results in animal body pitch changing radically as the seal adopts the nose down position. The decrease in depth recorded by the pressure transducer is due to the posterior-mounted device rising temporarily in the water column. The IMASEN data recorded from the seals ‘C’ and ‘S’ shows that this ‘up-ending’ behaviour is related to clear changes in mouth opening and therefore stems from seals removing prey from the sea bed (Fig. 80). Such changes in body pitch occur quickly (within 3 s) before the seal re-adopts the normal horizontal body posture typical of searching behaviour. As with search dives, swim heading along the bottom is variable, with area activity indices rarely exceeding 0.5 (Fig. 71).



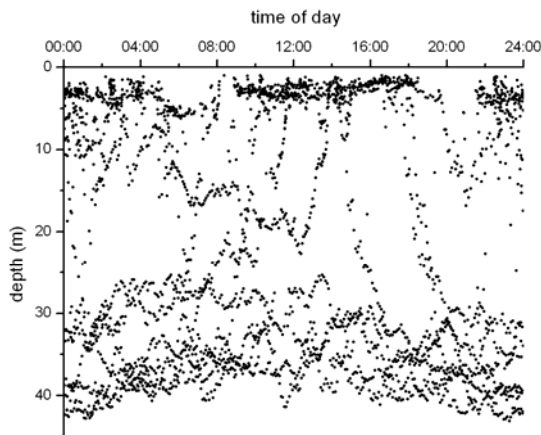


**Figure 80.** IMASEN and dead reckoner data from one harbour seal (C) showing typical patterns of different activities. Note that ‘up-ending’ behaviour during the bottom phase of U-dives occurred simultaneously with clear changes in mouth opening and are therefore considered to be feeding events.

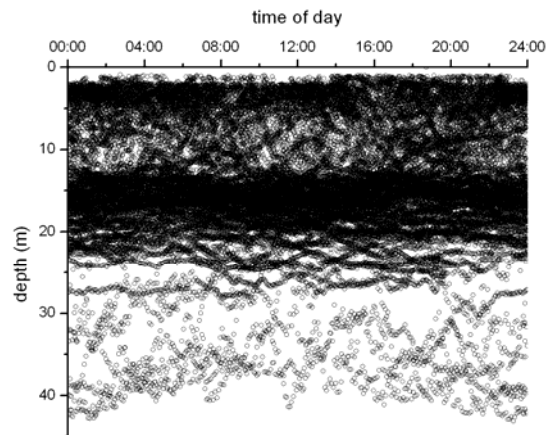
### 3.1.7 Diel rhythms in diving behaviour and depth exploitation

Since the maximum depth reached during the dive is the primary element determining other dive parameters (see earlier) it is appropriate that evidence of diel rhythms in dive behaviour be examined by assessing the distribution of the maximum dive depths before determining the overall distribution of selected depths. In this, it should be noted that clear patterns in depth use according to time of day have been demonstrated for many penguins (Wilson et al., 1993), fur seals (Croxall et al., 1985; Gentry & Kooyman, 1992) and elephant seals (Le Boeuf et al., 1988) with animals diving deeper during daylight than during the night. The two explanations offered for this are that some species limited to hunting by using light cannot see their prey at greater depths after sunset (Wilson et al., 1993) and that many prey species show diel vertical migration, moving closer to the surface at night (Hays, 2003 and references therein). It is thus somewhat surprising to see that harbour seals show no apparent trend in their use of depths as a function of time of day, either on an individual animal basis (Fig 81) or when all animals are considered together (Fig. 82). This implies that harbour seals neither rely extensively on vision to locate or capture their prey nor

do their prey exhibit diel vertical migration. Three things back these hypotheses up: (i) most of the identified prey of these animals are benthic (Brown & Pierce, 1998; Hall et al., 1998; Tollit et al., 1998), consisting of species that do not show diel vertical migration (ii) seals spend such a large percentage of their time close to the seabed (Fig. 38A) and (iii) it has been demonstrated that harbour seals can use their whiskers to track objects simply by following the turbulent plumes



**Figure 81.** Distribution of maximum depths reached during the dive as a function of time of day for an individual harbour seal (A) (N = 3015 dives).



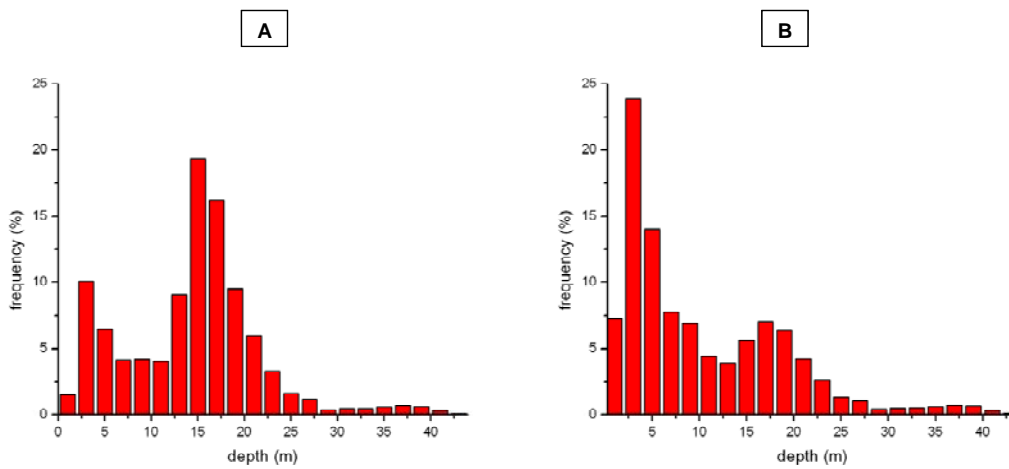
**Figure 82.** Distribution of maximum depths reached during dives as a function of time of day for all dives from all harbour seals (N = 104285 dives). Note that the increases in density at different depths indicates preferred maximum depth ranges (cf. Fig. 83A).

generated by their movement (Dehnhardt et al., 2001).

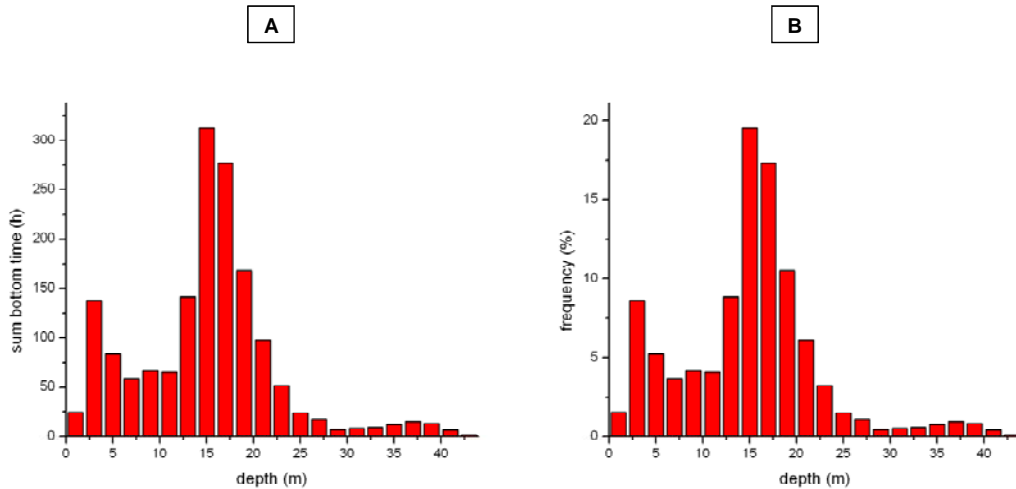
Density changes in the graph of depth use over the 24 h cycle (Fig. 82) indicate the extent to which particular depths are preferred. More rigorous assessment of this shows that seals had bimodality in preferred depths (Fig. 83). This bimodality is not due to a bimodality in the distribution of the sea depths between foraging sites and haul-out spots because water depth increases gradually as the animals move offshore (Fig. 27). Thus the pattern displayed by the equipped harbour seals appears primarily due to extended time spend in particular regions.

It has been pointed out that in marine endotherms that forage benthically, consideration of the bottom phase of the dive is particularly critical for assessing

the importance of depths to the animals (e.g. Costa & Gales, 2003). This is because overall time-at-depth analyses include the transit between the surface and the seabed which tends to overemphasize the importance of the mid- and upper water layers even though these regions are not used for foraging. In fact, the approximately linear increase in bottom duration with increasing depth (Fig. 45B) means that assessment of the importance of particular depths with respect to the time spent during the bottom phase of the dive (Fig. 84) differs little from that alluded to in the frequency distribution of maximum depths (cf. Fig 83).



**Figure 83.** Frequency of the maximum depths reached by (A) All animals during all foraging trips (B) All animals during all foraging trips but corrected for pseudoreplication by calculating percentages for each individual before summing percentages and calculating a new overall percentage.



**Figure 84.** Sum of the bottom duration as a function of depth for (A) All animals during all foraging trips (B) All animals during all foraging trips but corrected for pseudoreplication by calculating percentages for each individual before summing percentages and calculating a new overall percentage.

## 3.2 Weddell seals - Weddell Sea - ANT XXI/2

Altogether 13 deployments were conducted, during which two sets of devices got lost and in three cases either the IMASEN or the dead-reckoner malfunctioned due to battery failure or leakage of water into the battery housing. Nevertheless, a total of 22.92 days of simultaneous IMASEN and dead-reckoner data from 8 different animals was recorded. Data set duration ranged from 0.35 days to 6.09 days (mean: 2.87 days; SD: 2.12; N = 8) depending on device functioning and time of recapture. Altogether four more data sets were excluded from further analyses, two because of their short duration (0.35 days and 0.43 days) and because no feeding was observed, one dead-reckoner was incidentally programmed to record at two min intervals instead of two s intervals and gave therefore unacceptably poor temporal resolution while another IMASEN produced too much 'noise' in the recorded data to analyze it properly. In the remaining four data sets, 429 feeding events were recorded over a total of 11.51 days.

For only two of these four data sets, geographic positions could be calculated due to malfunctioning of single channels within the other two devices, such as the pitch or speed sensors. Ultimately, only 4.14 days of 3-dimensional dive data and simultaneous feeding activity could be used for further analyses of the All.

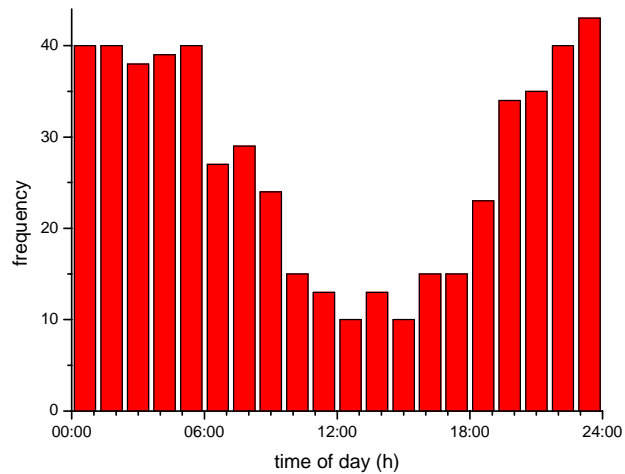
### 3.2.1 Area Use

#### *Seal area use as determined by dead-reckoners*

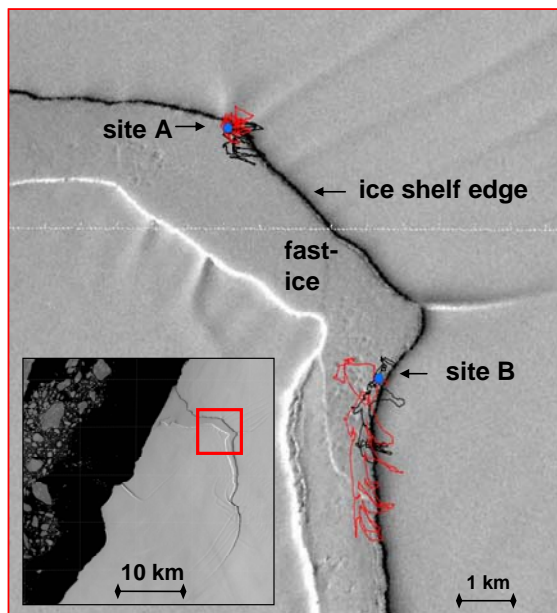
As the Weddell seals were not equipped with any tracking devices to give geographic position, the location at the time of deployment and sightings during the daily surveys through the inlet (during which time the seals were mainly hauled-out on the ice; Fig. 85) (Lake et al., 1997) were used as start- and end-points to calculate the routes of the animals. To surface for breathing and haul-

out seals were limited to tidal cracks in the fast-ice within the Drescher Inlet, which facilitated their observation. In addition, Weddell seals tend not to leave the inlet at the time of the year the study was conducted (before the ice breaks up), which reduced the risk of losing devices.

The data recorded by the dead-reckoners allowed us to calculate two foraging trips for each of the two animals. Trip duration was on average 10.67 hours (SD: 2.74 hours; N = 4), during which time the seals did not move further than three km from their favourite haul-out site (Fig. 86). The Weddell seal '2.2' which was tagged at site A mainly dived in an easterly direction, but did not move further away than about



**Figure 85.** Frequency distribution of number of dives in relation to time of day from 4 Weddell seals.



**Figure 86.** Satellite map of the Drescher Inlet with enlarged section showing the tagging sites (blue spots) and 4 calculated routes from 2 Weddell seals (red and black lines).

500 m. The animal stayed close to its breathing hole at the edge of the ice shelf during trips, apparently always using the same hole for breathing. Seal '7.1', equipped at site B, a crack in the fast-ice fairly close to the edge of the shelf ice, used a much larger area during its trips. This animal clearly used also other breathing holes further south along the shelf ice edge, orienting the direction of its dives in an easterly direction under the shelf ice.

### 3.2.2 Behaviour

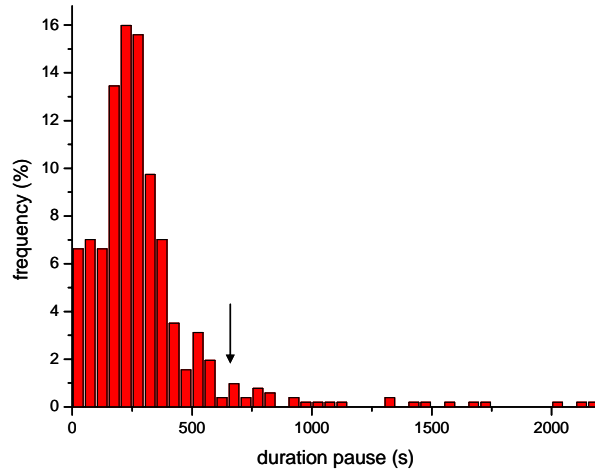
#### *Behaviour on ice*

A haul-out was defined as a period with no diving activity for more than 700 s (Fig. 87). The equipped animals spent 35 % of their time on the ice, with a mean haul-out time of 2.6 h (SD: 4.0; N = 32 from four animals).

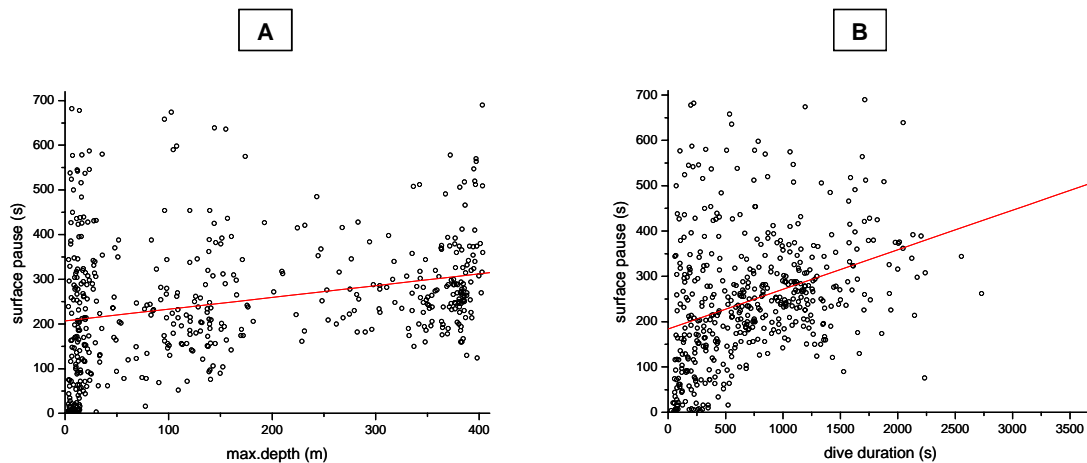
#### *Behaviour at sea*

During the spring conditions, when the data were recorded, Weddell seals dived for 50 % of the total time, spending only 15 % at the surface between dives (when not hauled-out).

Average dive duration was 12.2 min (SD: 9.5; N = 480;  $y = 206.76071 + 0.26346 \cdot \text{max.depth}$ ;  $r = 0.28287$ ;  $P < 0.0001$ ; Fig. 88A) and average inter-dive duration was 4.4 min (SD: 2.7; N = 480;  $y = 183.76276 + 0.08744 \cdot \text{dive duration}$ ;  $r$



**Figure 87.** Frequency distribution of the surface pause durations of 4 Weddell seals visualizing the point of inflection used as a bout-ending criterion (arrow - see text).



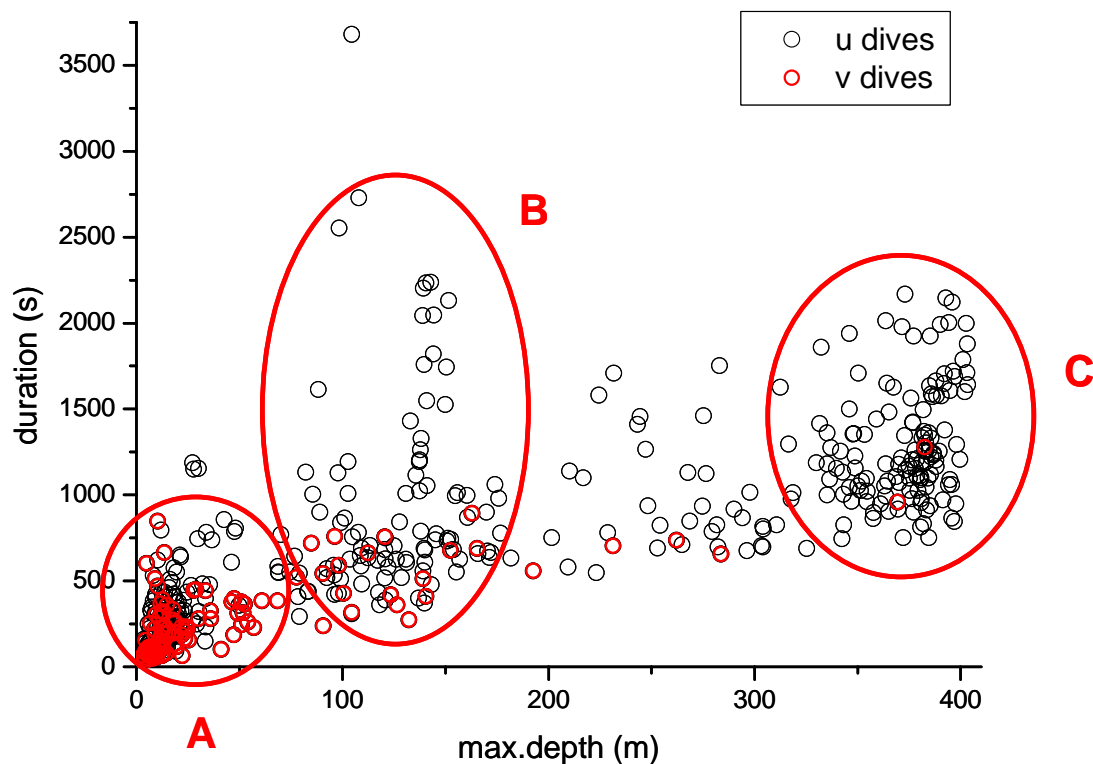
**Figure 88.** Relationship between surface pause < 700 s and maximum dive depth (A) and dive duration (B) for 4 Weddell seals conducting 480 dives.

= 0.35;  $P < 0.0001$ ; Fig. 88B). The longest dive took 61.7 min while the deepest dive went to 403.3 m.

### 3.2.3 In search of the definition and function of different dive types

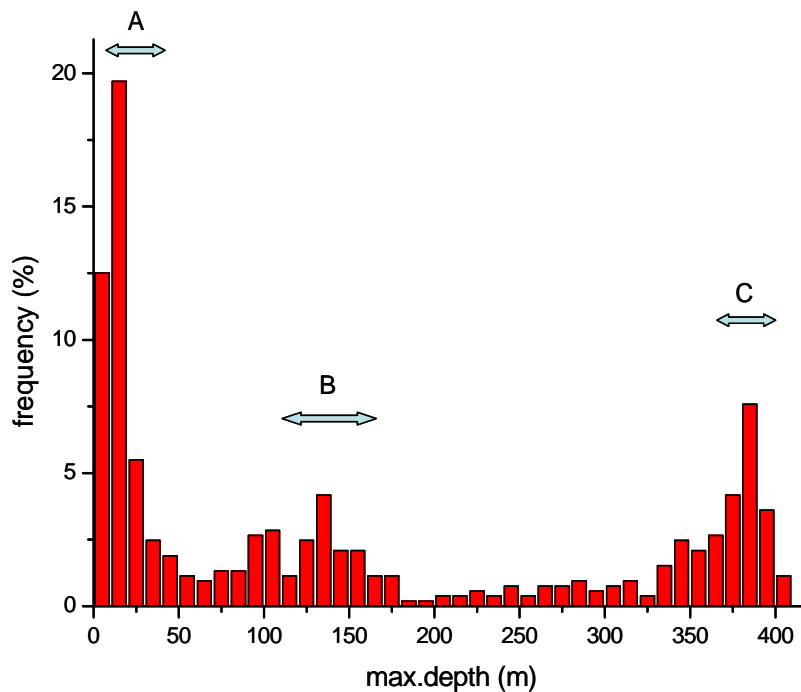
#### *Dive durations as a function of depth*

Of the 528 analysed dives, 78.6 % were U-shaped whereas the remaining 21.4 % were V-shaped. In regressions of total dive duration for all dives, whether U- or V-shaped, against maximum depth (Fig. 89), three different clusterings of dives became apparent.



**Figure 89.** Maximum dive duration vs maximum dive depth for 4 Weddell seals irrespective of dive type (see text). V-dives are shown in red while U-dives are depicted in black. Different populations of dives are apparent. Dives grouped under 'A' had a relatively short duration, rarely exceeding 500 s and not reaching much deeper than 40 m, those in 'B' included the longest dives and the greatest duration range from 250 s up to 3700 s, to depths between 90 m and about 160 m and those in 'C' almost exclusively U-shaped dives must have been to the sea bed between 330 m and 400 m and had mainly durations between about 800 s and 2000 s (see Fig. 90).

- One clustering ('A', incorporating U- and most V-shaped dives) had a relatively short duration, rarely exceeding 500 s and not reaching much deeper than 40 m. Most dives occurred in this group (Fig. 90), which were presumably related to milling around in the vicinity of the breathing hole or diving from one hole to the next under the fast-ice.
- A second group ('B', incorporating mainly U-shaped dives; Fig. 89) including the longest dives and the greatest duration range from 250 s up to 3700 s, to depths between 90 m and about 160 m. Fewest dives belonged to this population of pelagic dives (Fig. 90) which mainly reached under the ice shelf (see above; Watanabe et al., 2006).
- A third group ('C' in Fig. 89) incorporated the deepest dives, to depths between 330 m and 400 m. These almost exclusively U-shaped dives must have been to the sea bed and had mainly durations between about 800 s and 2000 s.

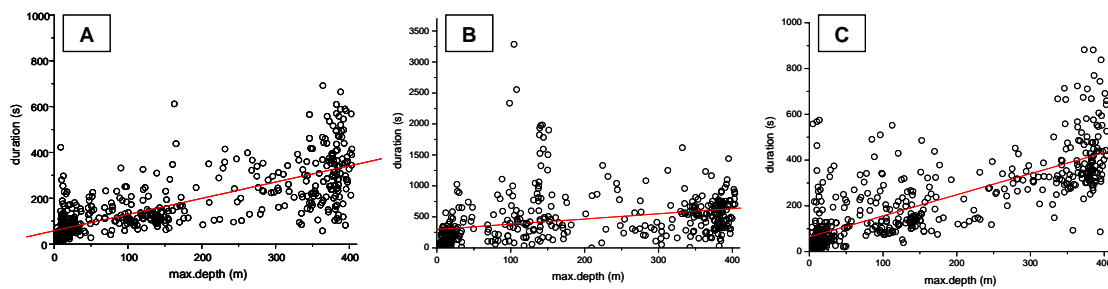


**Figure 90.** Frequency distribution of the maximum dive depth of 4 free-ranging Weddell seals. A, B and C refer to the clusters in Fig. 89.



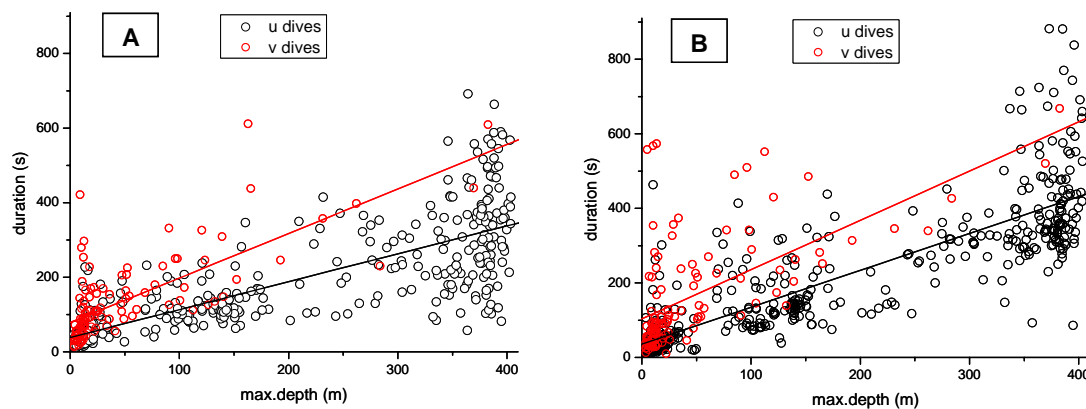
### Descent, bottom and ascent durations and velocities

Separating dives into their major phases; the descent, the bottom (for U-dives) and the ascent phase, allows further definition of different dive types. Descent duration ( $y = 57.78242 + 0.70814x$ ;  $r = 0.7623$ ;  $P < 0.0001$ ), bottom duration ( $y = 298.47307 + 0.83781x$ ;  $r = 0.31056$ ;  $P < 0.0001$ ) and ascent duration ( $y = 63.91696 + 0.92232x$ ;  $r = 0.78096$ ;  $P < 0.0001$ ) all increased significantly with increasing maximum dive depth (Fig. 91). In U-dives (with a



**Figure 91.** Relationship between the duration of the various phases of dives and maximum dive depth for the (A) Descent phase (B) Bottom phase and (C) Ascent phase

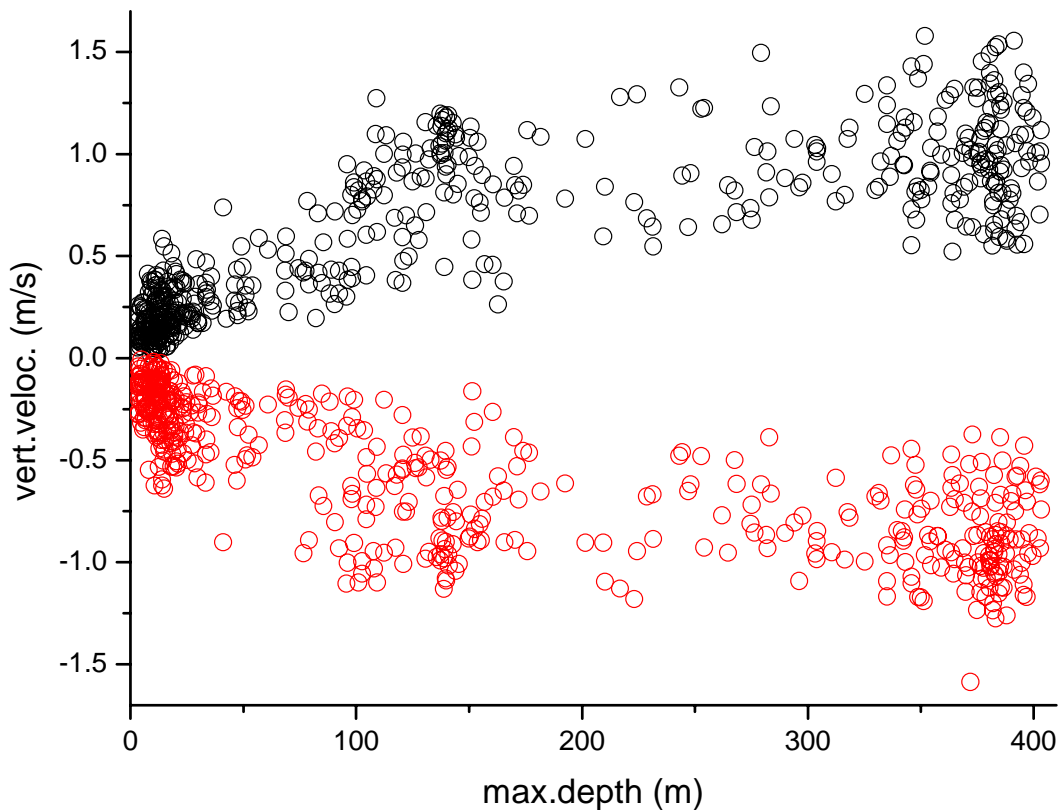
bottom phase), the duration of the descent and the ascent phase formed only a small fraction of the total dive duration, with the ascent taking usually longer than the descent. By comparison of the duration of the descent and ascent phase of U- and V-shaped dives (Fig. 92), clear differences become apparent with the



**Figure 92.** Relationship between the duration of the descent and ascent phases of U- (black points) and V-shaped (red Points) dives and maximum dive depth for the (A) Descent phase (B) Ascent phase.

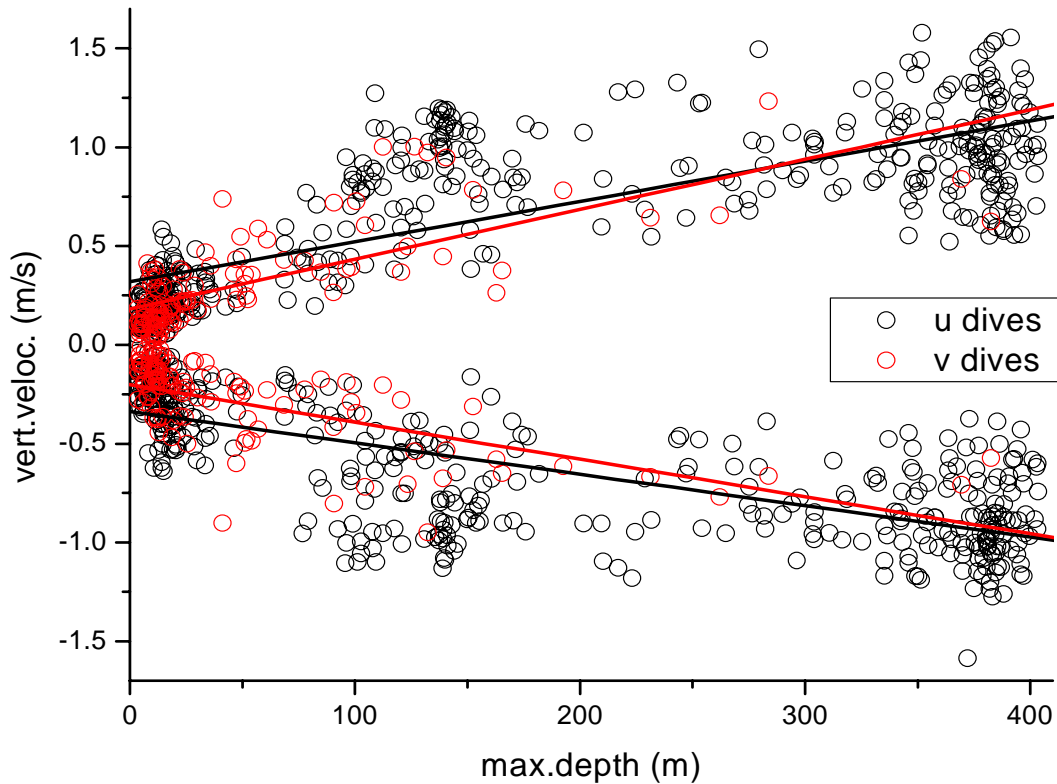
seals spending significantly shorter time in these phases during U-dives (descent:  $F = 14.7$ ,  $P < 0.01$ ,  $N = 528$ ; ascent:  $F = 5.4$ ,  $P < 0.01$ ,  $N = 528$ ) (Table 2; p. 146).

Like the harbour seals (see above), the increase in descent and ascent duration with increasing depth is not based on a constant descent or ascent rate. The vertical velocity (rate of change of depth) for both phases increased significantly with increasing maximum dive depth (Fig. 93). There were no significant differences between the V- and U-dives in this (descent:  $F = 2.2$ ,  $P < 0.01$ ,  $N = 528$ ; ascent:  $F = 0.9$ ,  $P < 0.01$ ,  $N = 528$ ) (Table 2; p. 146), with the



**Figure 93.** Rate of change of depth during the descent (black points) and ascent (red points) for all dives analysed (irrespective of dive type) from 4 Weddell seals.

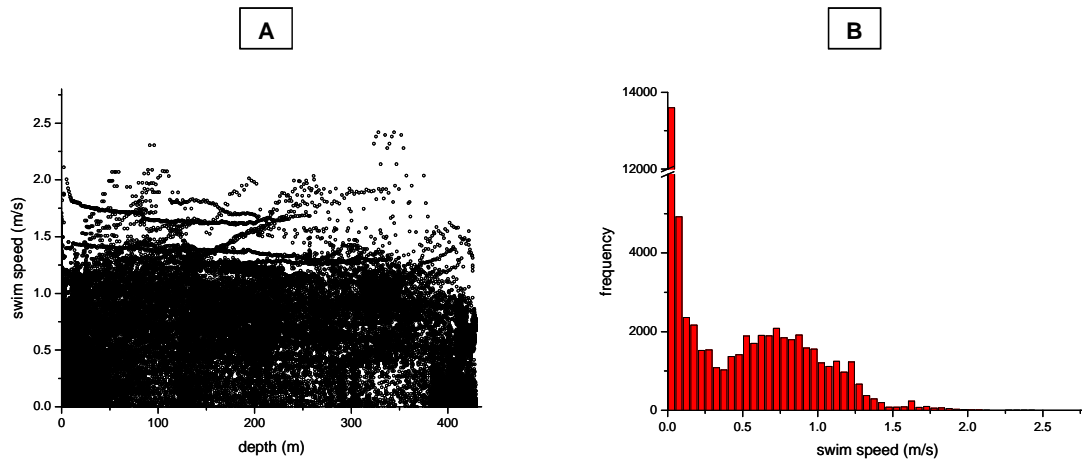
vertical velocity in V-dives starting at slower speeds and increasing slightly more with increasing depth than in U-dives (Fig. 94).



**Figure 94.** Rate of change of depth during the descent (positive values) and ascent (negative values) for U- (black points) and V-shaped (red points) dives analysed (irrespective of dive type), from 4 Weddell seals.

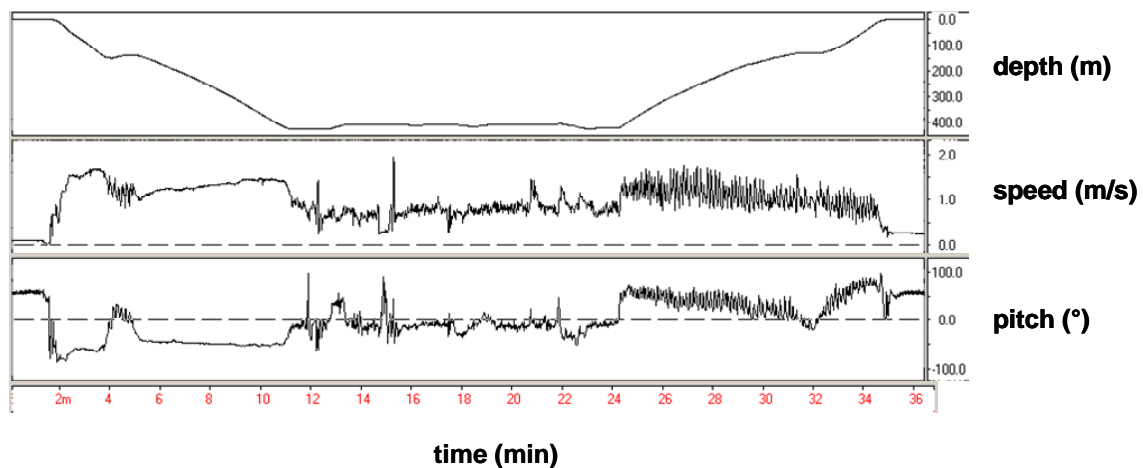
### *Swim speeds and pitch angles during dives*

Compared to the harbour seal study, the speed sensor worked well in the polar environment, where no sand could impede the paddle. The readings were calibrated by calculating the swim speeds during phases with a substantial change in depth, based on the pitch angle and simple trigonometry (see earlier). A peak in the frequency of speed of travel by the equipped seals occurred around 0.75 m/s (Fig. 95). During the descent phase, swim speeds were usually highest (especially over the first 100 m depth) reaching up to almost 2 m/s (Fig. 96). The ascent phase was slightly slower but steadier. During the bottom phase of dives, the animals moved much slower (Fig. 96).

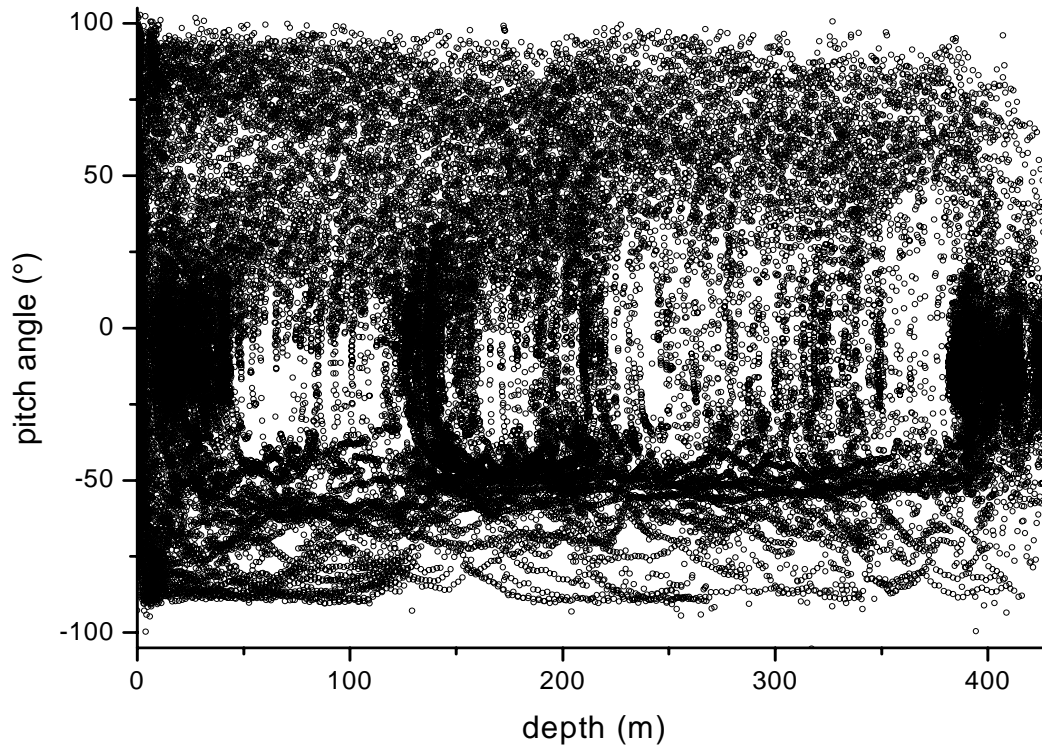


**Figure 95.** (A) All swim speeds recorded from 4 free-ranging Weddell seals as a function of the depth at which they were measured during the study period. Measured speed was calibrated by consideration of descent/ascent angles with respect to the rate of change of depth (see text). Each point shows a single measurement and measurements were made once every 1 or 2 s. The most commonly used speeds are apparent by the density of the points. (B) Frequency distribution of the swim speeds recorded in (A) above.

Most pitch angles during the vertical transit phases were relatively steep, with descent (head down = negative) angles being shallower than ascent (head up = positive) angles (Fig. 96/97). Furthermore, dive angles for the descents to about 120 m were steeper than to greater depth. During the ascent, the dive angles were fairly evenly distributed but more variable, with a greater range in shallower dives (Fig. 96/97). The frequency distribution of pitch angles showed a maximum peak around  $0^\circ$ , representing the time when the seals were hauled-out

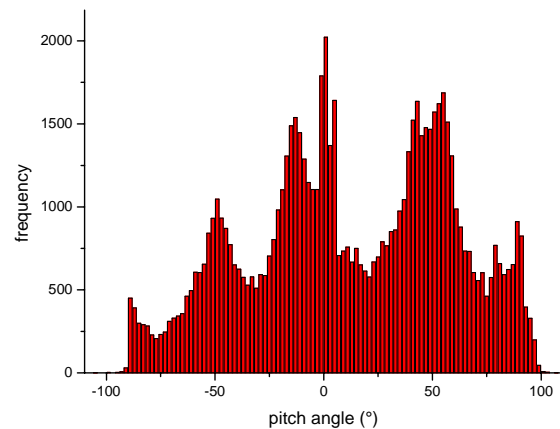


**Figure 96.** Graphic representation of the changes in recorded parameters (depth, swim speed and pitch angle) as an example of a benthic dive performed by a Weddell seal.



**Figure 97.** Animal pitch angle as a function of the depth at which it occurred for all measurements made in 4 Weddell seals where the sampling rate was 1 or 2 s. Note: negative values refer to a downward tilt of the head (e.g. during the descent), whereas positive values refer to an upward tilt of the head (e.g. during the ascent).

or swimming along in most part of the bottom phase of dives (Fig. 98). Descent (negative) and ascent (positive) angles showed both a bimodal pattern where ascent angles always occurred with higher frequencies. The peaks around  $-50^{\circ}$  and  $50^{\circ}$  can be derived for a great extend from the descent and ascent phases. Values around  $50^{\circ}$  also often occur while the animal is breathing at the surface (see Fig. 109-113). The minimum value around  $-85^{\circ}$  can be related to the steep angles during especially the first part of the

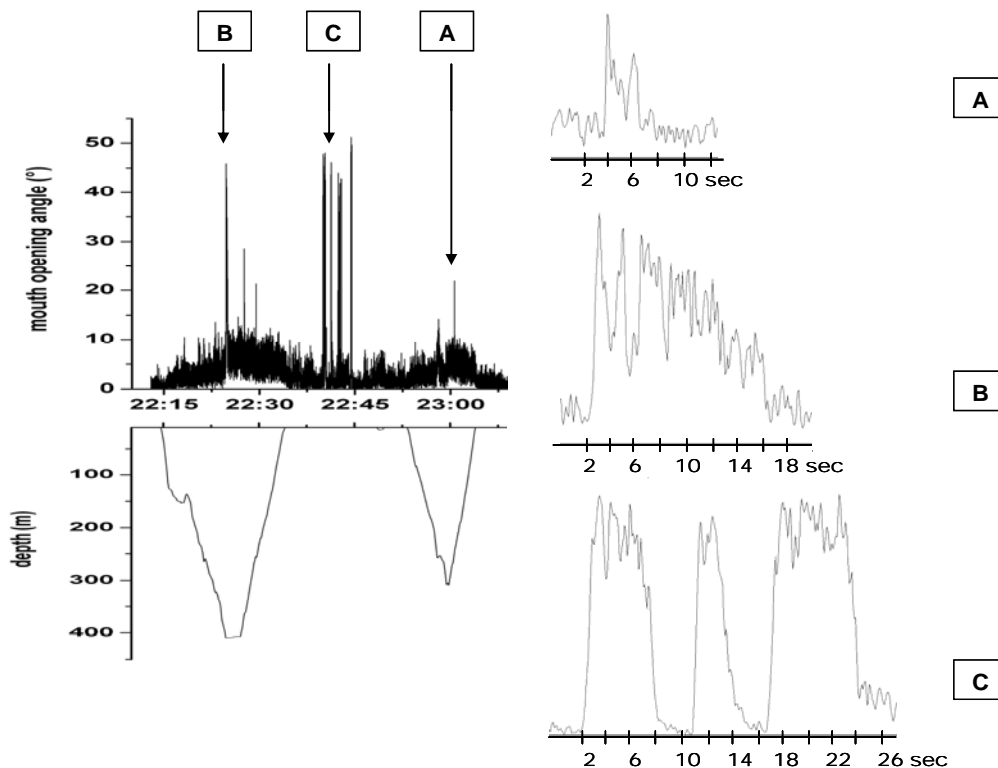


**Figure 98.** Frequency distribution of animal pitch angles. Note: negative values refer to a downward tilt of the head (e.g. during the descent), whereas positive values refer to an upward tilt of the head (e.g. during the ascent).

descent (Fig. 96/97), whereas the maximum value around 90° also represents the animal in a vertical position at the surface (Fig. 96/97).

### 3.2.4 Feeding

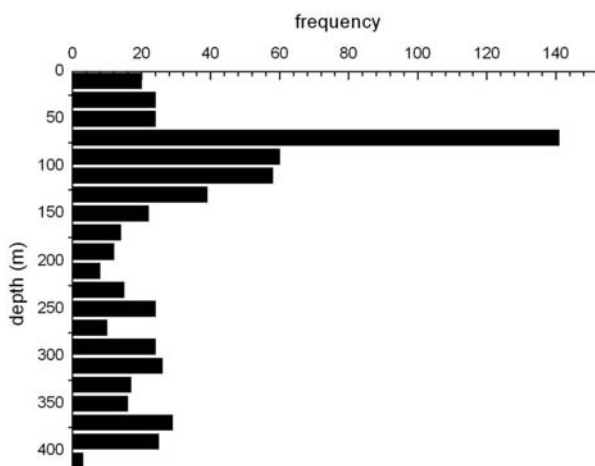
The events classified as feeding were identified mainly as a result of the patterns recorded from the captive harbour seal (see above). However, the typical initial large, rapid peak in jaw angle, followed by a cascade of smaller ones until the mouth opening angle returned to values around zero were sometimes less clear, probably due to the lower temporal resolution of the system used in the wild (Ropert-Coudert et al., 2004). Overall though, there was a strikingly similar apparent ‘grab and handling phase’ without the subsequent ‘swallowing phase’ as seen in the harbour seal (Fig. 99A & B). Jaw opening data had to be considered parallel with the dive data so as to be able to distinguish between putative feeding events (which only occurred underwater) (Fig. 99A & B)



**Figure 99.** Different patterns of mouth opening angle over time in relation to dive depth, representing different types of prey and other activities other than foraging: (A) Antarctic silverfish, (B) Antarctic cod, (C) ice-reaming.

and other jaw activities such as ice reaming, vocalizing or yawning which occurring above the water. It is notable, however, that these other activities produced patterns that were quite distinct from those that occurred underwater (Fig. 99C).

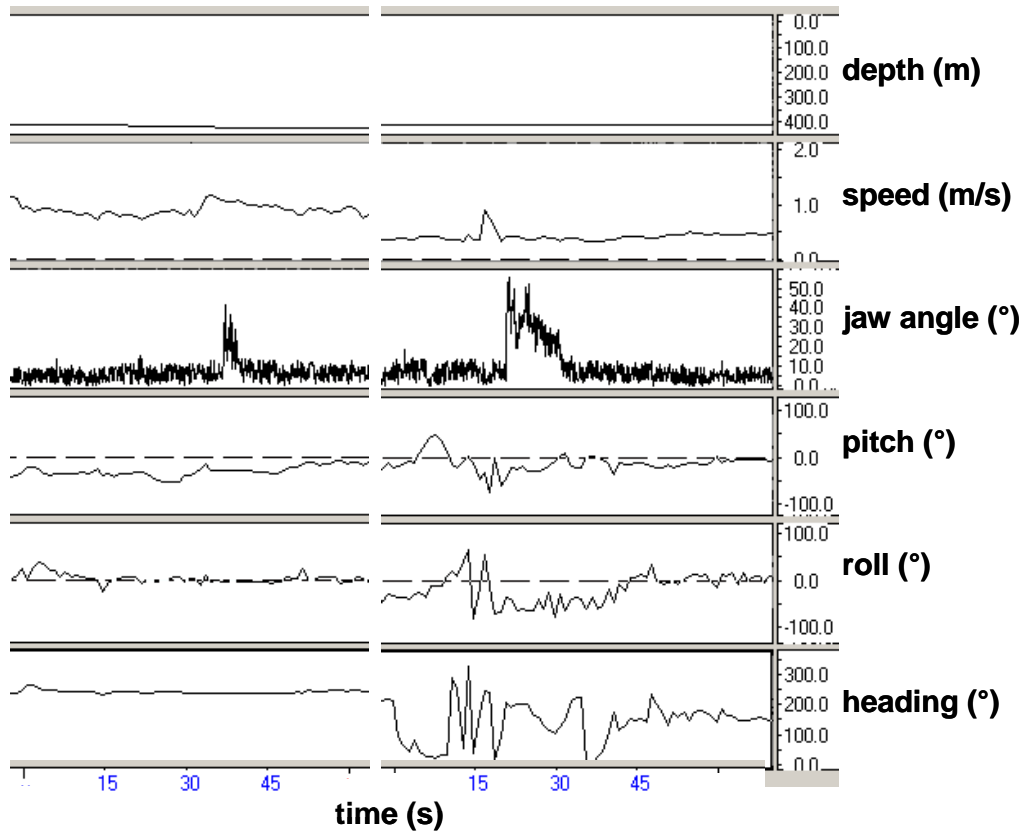
The variation in duration, maximum opening angle and integral was much greater than that encountered in the trials with the captive harbour seal. Events lasted between 0.6 s and 30.7 s (mean: 2.8 s; SD: 3.1; N = 508) and the maximum mouth opening angle ranged between 12.7 ° and 94.9 ° (mean: 37.9 °; SD: 16.1; N = 508) while values for the integral of the mouth opening angle curve over time ranged from 16.8 °.s to 7431.6 °.s, with a mean value of 431.5 °.s (SD: 639.4; N = 508). An average of 2.8 feeding events were recorded per dive (SD: 3.1) with a range from 1 to 20. Most feeding events occurred between 60 m and 140 m with a clear peak around 70 m (Fig. 100). The fewest number of events was recorded around 210 m and three small peaks seemed to occur around 250 m, 300 m and 380 m, respectively. The feeding dives could be classified in most cases as either ‘pelagic’ (between 60 m and 140 m) or more ‘benthic’ (below 300 m), with prey encounters mainly occurring during the bottom phase of these predominantly U-shaped dives. The majority of the feeding events showed a pattern consisting of only a few peaks (Fig. 99A) and occurred throughout the



**Figure 100.** Frequency distribution of feeding events over depth as recorded on 4 free-ranging Weddell seals (N = 429).

range of recorded water depth. A second pattern, which occurred 12 times of 508 supposed ingested prey items, was only observed during benthic diving, showed the same basic structure of a cascade of peaks but started with greater amplitude and had much longer durations (Fig. 99B).

Small events in most cases followed short periods of increased swim speed and sometimes clear changes in tilt angle and heading (Fig. 101) whereas before large events hardly any indication of that kind was visible although they were systematically followed by a clear drop in velocity and considerable changes in tilt angle and heading (Fig. 102).

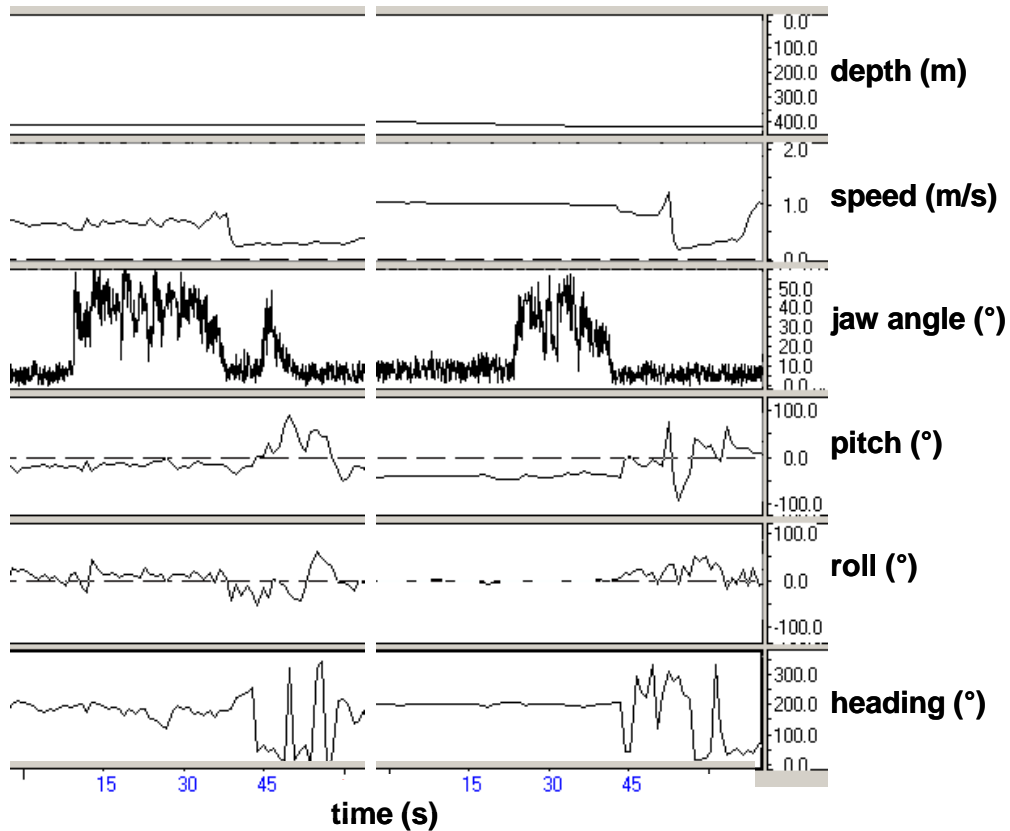


**Figure 101.** Two examples for small feeding events (presumably Antarctic silverfish) together with dive depth, swim speed and three dimensional movement patterns recorded on a free-ranging Weddell seal.

### 3.2.5 Tortuosity of tracks: Area Interest Index (All)

As the Weddell seals in this study were hauled-out directly over their foraging grounds and hardly moved around inside the Drescher Inlet, the variability in the extent of meandering was fairly consistent from dive to dive (Fig. 103). At the surface the All was always 1, as the animals were limited in their movements to the breathing holes. During the vertical phases of the dive, the All





**Figure 102.** Two examples for small feeding events (presumably Antarctic cod) together with dive depth, swim speed and three dimensional movement patterns recorded on a free-ranging Weddell seal.

could oscillate between 0 and 1 depending on the steepness of the dive angle

and therefore the

horizontal

displacement of the

seal. In the middle

of the bottom phase,

the return point of

the dive, the All

showed a rise from

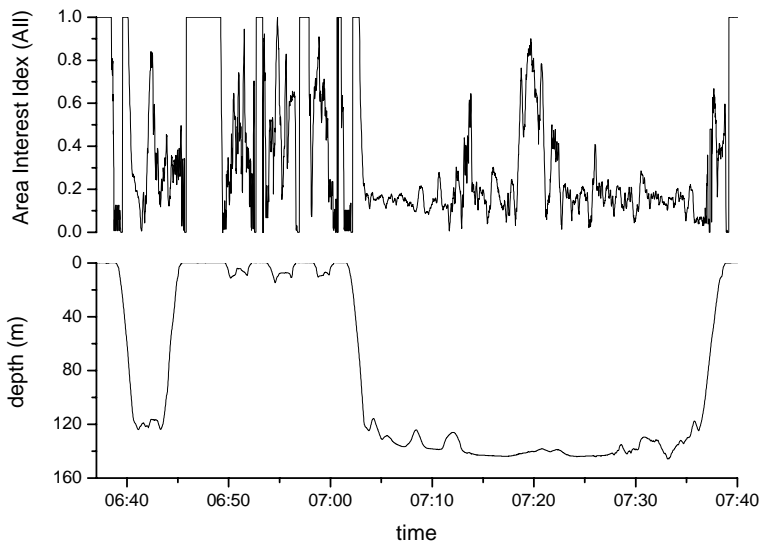
values around 0.2 to

0.8 because the

animal had to turn

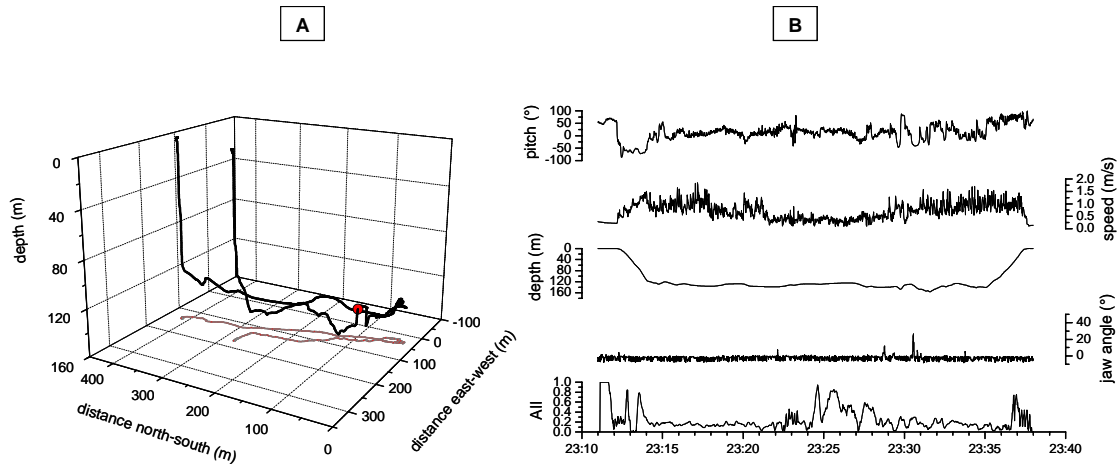
around and swim

back more or less



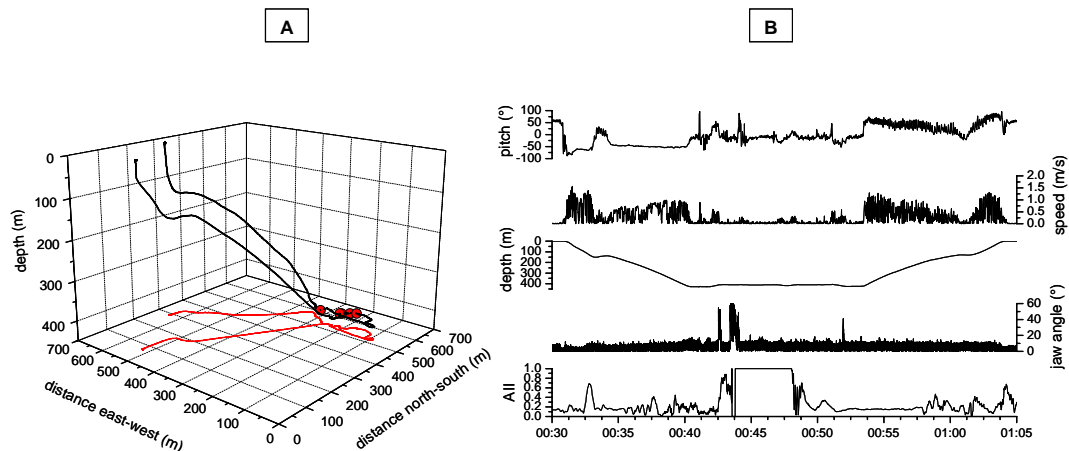
**Figure 103.** Example of the relative similar change of the AII during several dives of a free-ranging Weddell seal, representing the variability in the extend of meandering.

the same way it came (Fig. 104/105) and also had slower swim speeds during that time (Fig. 104/105). During most of the bottom phase, the AII's were around 0.2, meandering more with higher variations in pitch angles or when prey was encountered (Fig. 104B).



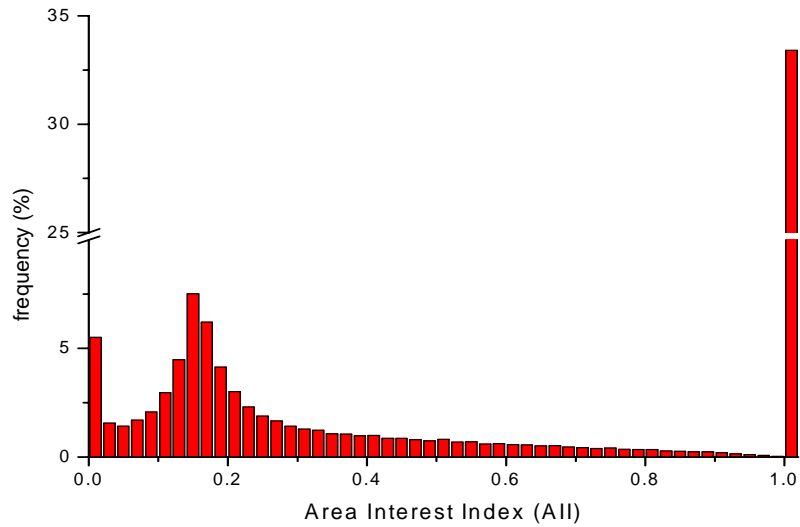
**Figure 104.** Example of a pelagic dive performed by a free-ranging Weddell seal during which prey was encountered and ingested (A) a 3-d diagram of the movement of the seal during the dive (red spot = feeding event) and (B) changes in depth, speed, pitch, jaw angle and AII.

Consideration of the frequency of occurrence of all AII's shows that there was a clear maximum at 1 (Fig. 106). This mainly represents the inter-dive periods spent at the breathing holes. A much smaller, but still clear peak was around 0.17, the most common AII during the bottom phase. There was an exponential drop from this value upwards until the minimum value at 0.98 is



**Figure 105.** Example of a benthic dive performed by a free-ranging Weddell seal during which prey was encountered and ingested (A) a 3-d diagram of the movement of the seal during the dive (red spot = feeding event) and (B) changes in depth, speed, pitch, jaw angle and AII.

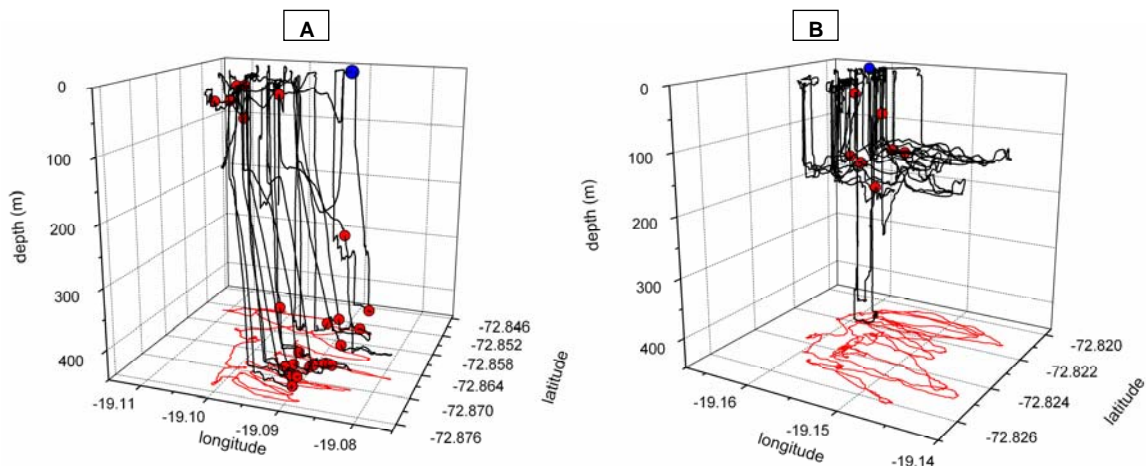
reached.  
 Below 0.17  
 values also  
 dropped but  
 ended in  
 another peak  
 at 0 (Fig.  
 106).



**Figure 106.** Frequency distribution of AII's from 2 free-ranging Weddell seals.

*Travelling/commuting. (vertical)*

In order to access their prey, Weddell seals have to cover the vertical distance down to the sea floor or the 'inverted floor' under the shelf or fast ice (Davis et al., 1999; Watanabe et al., 2006). During the first part of the descent (down to 100 – 150 m) they therefore go down at very steep angles, resulting in often low AII's, presumably orienting themselves along the edge of the shelf ice (Fig. 104/105). For benthic dives, descending further down to around 400 m, the seals can cover a substantial horizontal distance during the rest of the descent at lower dive angles (Fig. 107A). In 'pelagic' dives under the shelf ice the animals



**Figure 107.** Example of a benthic (A) and a pelagic (B) dive bout from 2 free-ranging Weddell seals. 3-d view of the bouts with start points marked blue and feeding events red. The red line represents the 2-d projection of the track.

kept swimming at a relatively high speed during the first and last third of the bottom phase producing relatively low AIs (Fig. 104B).

*Foraging/non-directional movement.*

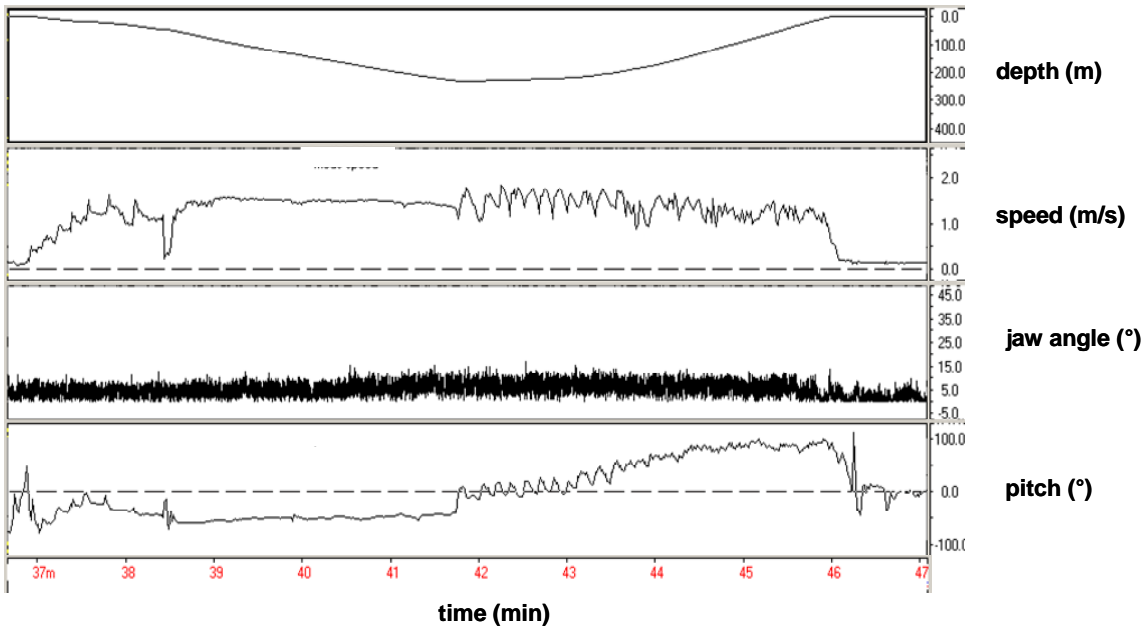
Prey encounter is most likely during the bottom phase of a dive, and was indeed observed at this time (Fig. 101/102/107). With swim speeds being lower during the whole bottom phase for benthic dives (Fig. 105) and during the central third of pelagic dives (Fig. 104), higher AIs likely to be due to particular patterns related to searching for, or ambushing prey.

### 3.2.6 Dive types according to proposed function

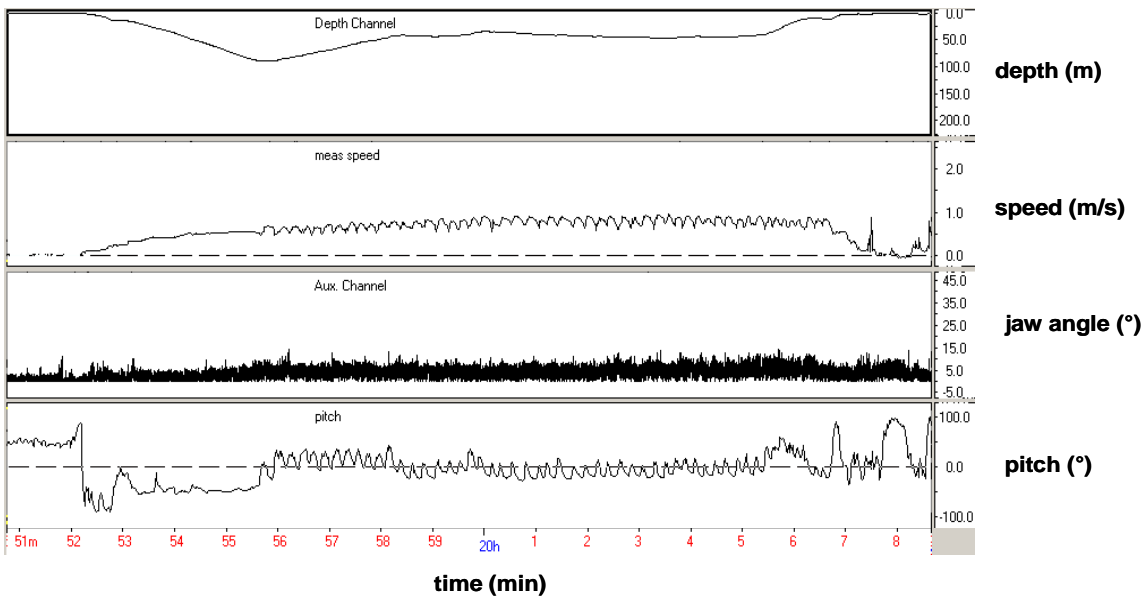
Considering the conditions at the study site and the systematic changes in the recorded parameters (above), three primary behaviours are proposed;

*Prospecting*

These dives are characterized by a variety of utilized dive depths and dive shapes, with deeper dives tending to be more V-shaped (Fig. 108) and shallower dives more U-shaped (Fig. 109). Descent and ascent angles are markedly shallower than during other dives, combined with usually slower (but fairly constant) swim speeds resulting in lower vertical velocities. The function of these dives remains speculative. However, the characteristics especially of the shallow dives suggests that such dives are used to explore the surrounding of the breathing hole or other holes in the vicinity (Davis et al., 1999).



**Figure 108.** Example of a V-shaped dive with changes in depth, speed, jaw angle and pitch performed by a free-ranging Weddell seal, presumably to explore the water column.

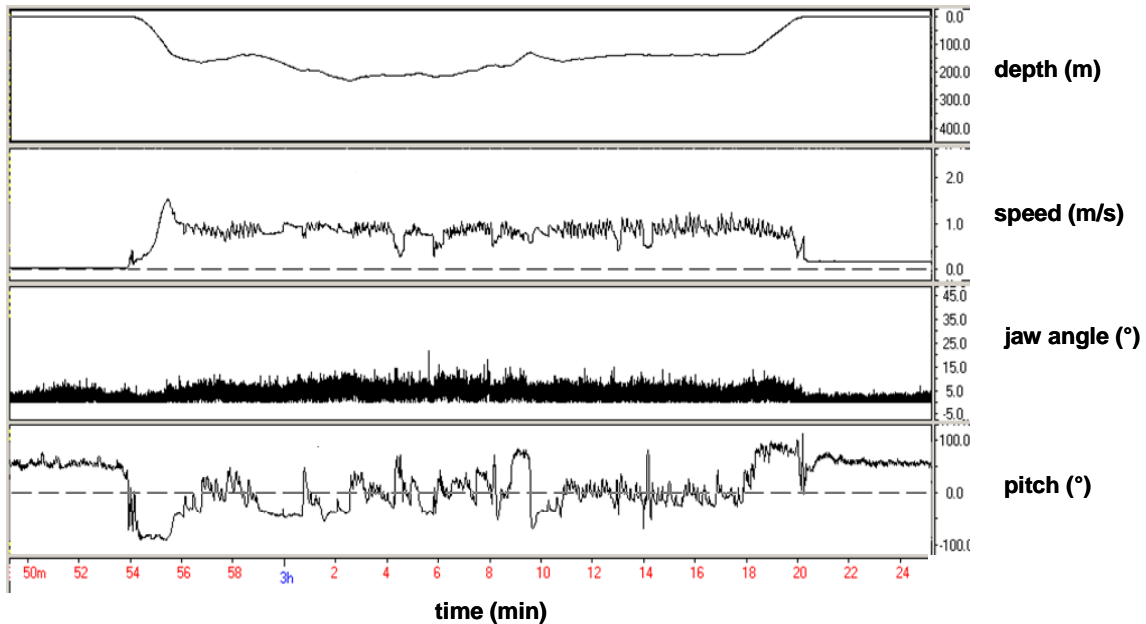


**Figure 109.** Example of a U-shaped dive with changes in depth, speed, jaw angle and pitch performed by a free-ranging Weddell seal, presumably to explore the surrounding of the breathing hole.

### *Search (pelagic / benthic)*

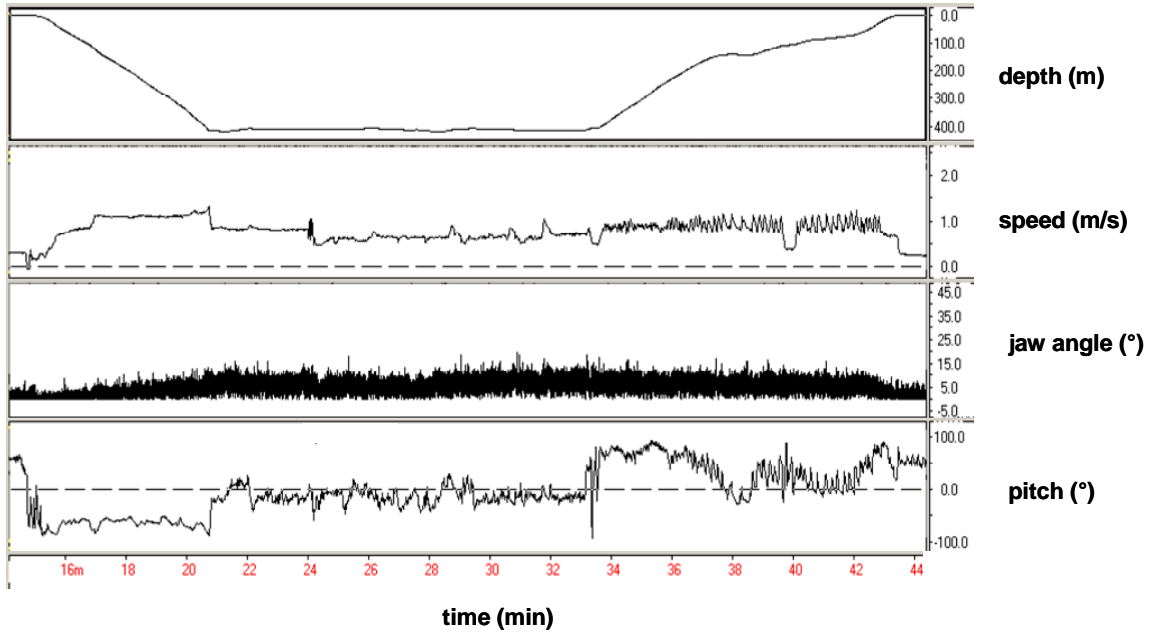
Search dives are always U-shaped and either pelagic (between 90 m and 160 m) or benthic (between 330 m and 400 m) (Fig. 90). Most of the pelagic

dives were apparently executed along the underside of the shelf ice, following its contours and therefore producing a unique pattern in dive depth during the



**Figure 110.** Example of a pelagic U-shaped search dive with changes in depth, speed, jaw angle and pitch performed by a free-ranging Weddell seal.

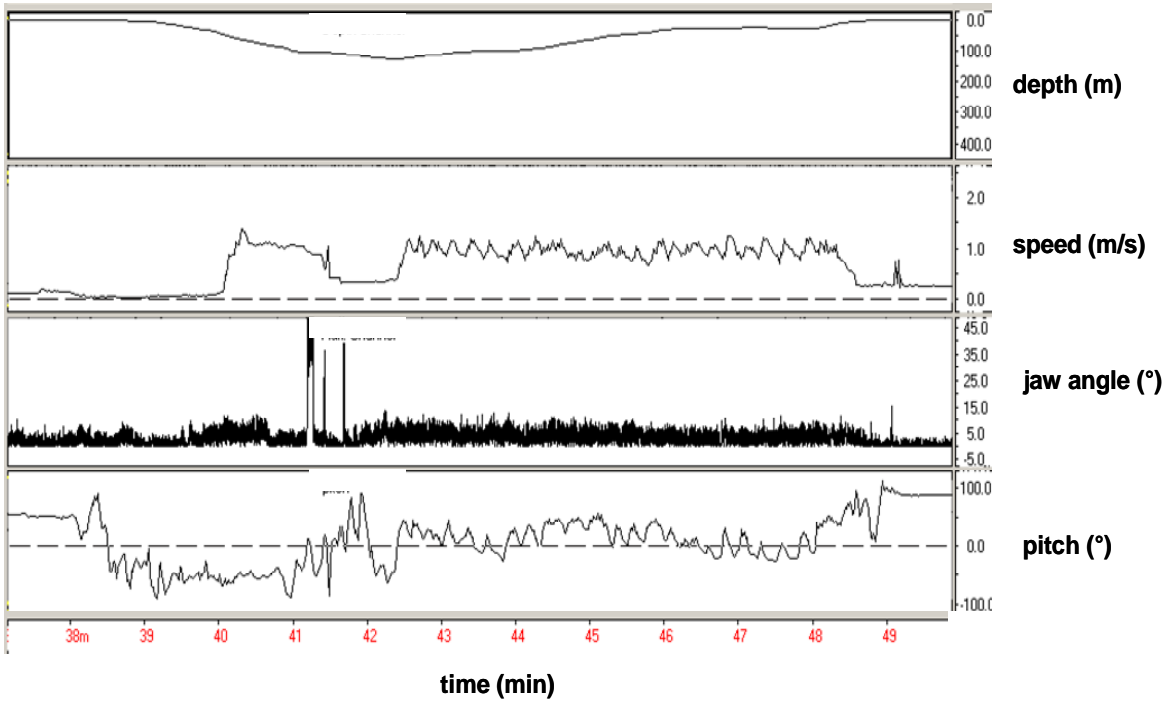
bottom phase (Fig. 110). Swim speeds during that phase are fairly constant, with changes often occurring simultaneously with changes in pitch angle. Benthic dives had a fairly constant bottom phase with far less change in depth than pelagic dives (Fig. 111). Pitch angles also showed less variability and swim speeds were slower and steadier. During all dives, descent and ascent angles decrease (Fig. 97), while vertical velocities increased (Fig. 94) and descent and ascent duration increased (Fig. 92) with increasing dive depth.



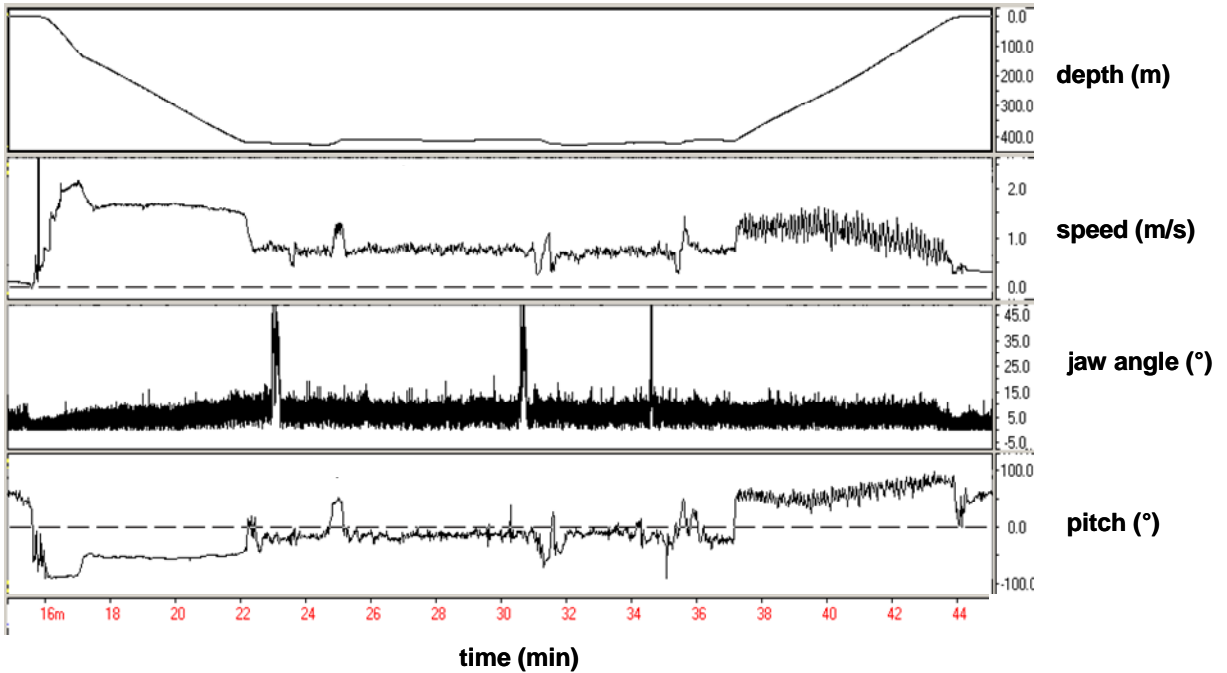
**Figure 111.** Example of a benthic U-shaped search dive with changes in depth, speed, jaw angle and pitch performed by a free-ranging Weddell seal.

### *Feeding (pelagic / benthic)*

Feeding dives were similar to search dives. However, when prey was encountered and ingested, sudden changes in various parameters such as swim speed, pitch angle and, of course, jaw opening angle appeared (Fig. 112/113). The reaction of the seal upon prey encounter is likely to differ depending on the type of prey (see above; Fig. 101/102). Although, theoretically prey could be encountered any time of the dive, it was most likely and indeed most common during the bottom phase of a dive.



**Figure 112.** Example of a pelagic U-shaped feeding dive with changes in depth, speed, jaw angle and pitch performed by a free-ranging Weddell seal.

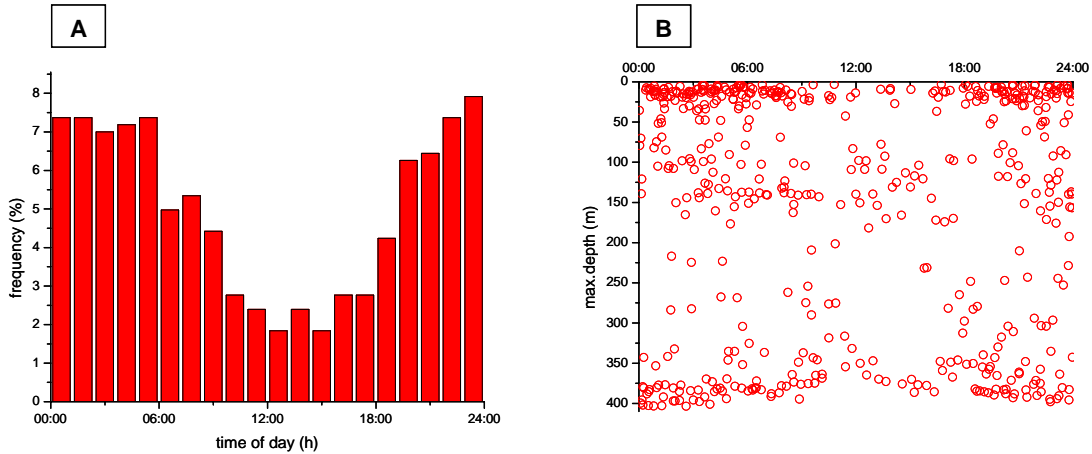


**Figure 113.** Example of a benthic U-shaped feeding dive with changes in depth, speed, jaw angle and pitch performed by a free-ranging Weddell seal.

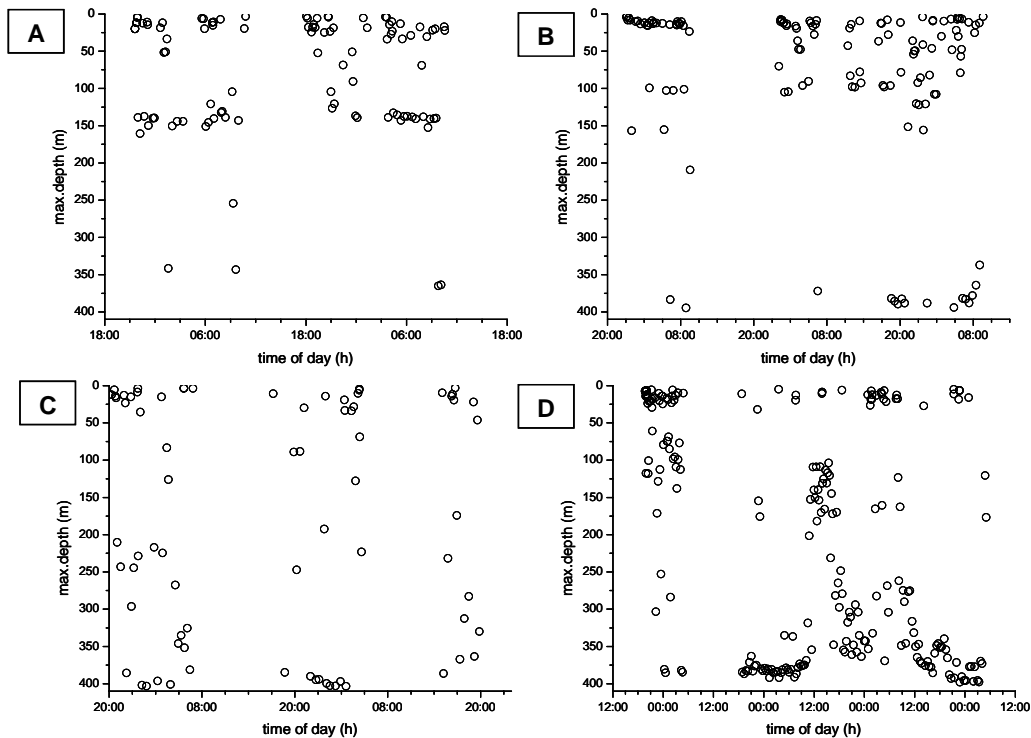


### 3.2.7 Diel rhythms in diving behaviour and depth exploitation

For the Weddell seals during this study, a clear diel rhythm in diving behaviour was apparent with most dives taking place between 18:00 in the afternoon and 9:00 in the morning (Fig. 114/115A-D) could be found. But no clear pattern in depth use according to time of day was noted.



**Figure 114.** (A) Frequency distribution of percentage of dives in relation to time of day from 4 Weddell seals. (B) Relationship between maximum dive depth and time of day for 4 free-ranging Weddell seals.



**Figure 115.** Diel rhythms in diving behaviour and depth exploitation of four free-ranging Weddell seals. (A) animal # '2'. (B) animal # '4'. (C) animal # '7'. (D) animal # '11'.

# Chapter 4 Discussion

## 4.1 Device effects

Observations during the feeding trials and resightings of the equipped free-ranging seals during the deployment period, showed no obvious impact on their behaviour. In the captive animals this might be because they were trained, and accustomed, to carry all sorts of equipment. After the Weddell seals were equipped and the antidote had been applied, it took around 15 minutes until the first signs of activity were observed. Between 20 min and 60 min after the immobilization, the first noticeable jaw movements appeared in the records of all but one animal. This period, lasting between 30 min and 120 min, was characterized by a series of peaks with varying amplitude and duration, representing jaw movements of unknown function possibly due to the animal being temporally irritated by the devices, although it might have been attributable to the anaesthesia. This behaviour was only observed at the beginning of a dataset. One of the two seals equipped twice, displayed this behaviour each time, whereas the other did not show it during the second deployment. This may have been due to the animals adapting differently towards the impact of carrying devices or possibly to the anaesthesia. Overall, however, neither seemed to have a lasting influence on the animals nor hinder their performance.

## 4.2 Errors & limitations

### 4.2.1 Errors in dead-reckoning

Dead-reckoning for animals necessitates that three elements be recorded; animal speed, animal heading and animal position in the vertical axis. In addition, the animal's position must be known at least once during the period when its movement is being monitored so that relative calculated co-ordinates can be ascribed to position. Typically, the animal's position is known at the moment the

animal is equipped and released into the wild at time  $t = 0$  so that the position at  $t = 1$  is given by consideration of this start position modified by the distance vectors derived from animal speed between  $t = 0$  and  $t = 1$  and the heading and pitch angle (this latter being derived from the change in animal depth between  $t = 0$  and  $t = 1$ ). A primary element in determining overall route calculations in dead-reckoning resides with the accuracy of the primary logged parameters of speed, depth and heading.

### *Speed*

The accurate measurement of speed is a critical element in determination of routes determined using dead-reckoning. Systematic under-, or over-estimation leads to reduced or expanded moved ranges/distances which leads to incorrect absolute positions although it does not affect elements such as the tortuosity of tracks. There is remarkable variation in the types of speed sensors used by different groups working on marine animals and options include paddle wheels (Ponganis et al., 1990; Sundstrom & Gruber, 1998), propellers (Ropert-Coudert et al., 2002; Yoda et al., 2001), turbines (Eckert, 2002), differential pressure sensors (including those using Prandl tubes, Wilson et al., 2002b) and absolute pressure sensors (Adelung, 2004), Hall effect magnetometers (Kreye, 2003) and piezo-resistive sensors (unpubl. data). All methods that involve moving parts have a stall speed, below which they do not work and this is typically 0.3 m/s so errors can be substantial. A suggested alternative that does away with this would use the Doppler shift (Kreye, 2003) although this principle has not yet been used on animals. Probably the most serious error in measurement of speed stems from inappropriate calibration. The speed of water flow over an animal varies with animal size and shape and position of the speed sensor (Culik et al., 1994) so transducers that measure speed should be calibrated on life-size models. Even so, water flow may differ to that over real animals (Carpenter et al., 2000). This problem can be negated by having loggers with high resolution tilt sensors (e.g. Mitani et al., 2003) and pressure transducers so that the speed component of a dive can be calculated by equating

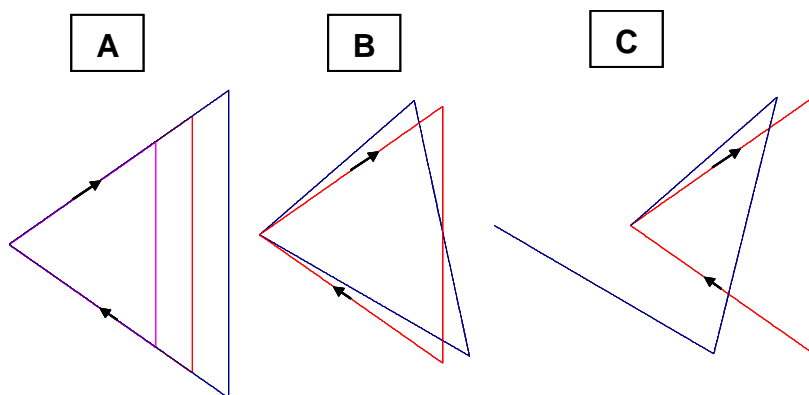
the rate of change of depth with dive angle and this can be regressed against the value recorded for speed to produce a relationship between speed sensor output and real speed (see section 2.5.2). The value of this approach is that the process can be used at any time when the animal is ascending or descending the water column (i.e. there is potential from every dive, Blackwell et al., 1999) and the process can be repeated at intervals through the logged period to ascertain that there is no change in the calibration.

### *Depth & pitch*

Errors in depth are of little concern in dead-reckoning because depth transducers tend to be highly accurate (usually accurate to within a fraction of a metre Hays et al., 2004). Moreover, every depth reading can be taken as an independent event, a mono-dimensional equivalent of a GPS fix. The greatest consequence of inaccurate depth measurement relates to determination of speed (in calibrations for speed sensors where the change in depth over time is related to body angle - see above). In fact, values for speed taken from a calibration can be used in tandem with recorded data on pitch as well as rate of change of depth in a triangle of elements to examine variance and consistency in all three parameters. Perhaps one of the greatest errors in this approach lies in apparent inconsistencies between body pitch angles and rate of change of depth at a given speed because the device actually only measures device pitch angles rather than animal pitch angles and if device orientation does not represent the true longitudinal axis of the animal, errors will arise. A way around this problem is to look for sections of the data where there is no depth change between two consecutive readings before examining the pitch recorded from the instrument at this time. The difference in the recorded pitch from the device and the actual pitch of the animal represents the offset with which all pitch measurements must be corrected so that device data truly represent the animal pitch (Sato et al., 2003; Watanuki et al., 2005).

### Compass heading

The manufacturers of solid-state compasses state that their systems can resolve heading to within  $1^\circ$ . This assumes virtually perfect information on compass orientation (pitch and roll) because solid state compasses record tri-axial magnetic field intensity which is then put into perspective by consideration of compass sensor orientation with respect to gravity and magnetic declination (see section 2.5.2). Implicit in this is that both the compass sensor and the body orientation sensor are perfectly aligned on the circuit board, which can be achieved with careful engineering. However, the ability of the compass sensor to provide a true animal heading also depends on the extent to which device orientation reflects animal orientation. In fact, it is not a trivial matter to fix a device to an animal so that it faces exactly forward. While errors in device pitch can be corrected, problems with device heading not representing those of the



**Figure 116.** A theoretical route calculated for an animal based on dead-reckoning (swim speed 1 m/s), shown in red in all figures, has been subject to errors to show the effect on route calculations. (A) Inaccurately estimated speed, with blue showing over-estimated ( $v = 1.2$  m/s), and pink under-estimated ( $v = 0.8$  m/s), speeds. (B) Heading misrepresented by 5 degrees due to skew device attachment to the animal. (C) Drift due to a transverse current flowing at 0.1 m/s from East to West.

animal are more difficult to assess (Fig. 116) but can be alluded to by careful observation of the way the device sits on the animal after it has been released.

### Drift & start-/end-positions

Errors in the accuracy of any of the sensors described above are most serious if they are systematic although if the extent of sensor error is known most problems can be resolved by appropriate modified calibrations (cf. Fig 116).

However, the environment also acts to produce systematic errors. Thus, seals operating in currents can drift off calculated positions. This occurs when two defined, and known, points on the track (such as start and end points) do not coincide with the calculated positions. The problem can then be reduced by determining the difference in space between the defined points and correcting the points between to accord.

This process assumes linear drift over time, though, which may not be the case. Knowledge of local current conditions may help here (cf. Gaspard et al., 2005) although an increased number of independent true fixes, such as via GPS would provide the ideal solution although PTT-fixes may also help in this regard. Where this is not possible, consideration of the depths reached by equipped diving animals may help refine estimates of position if the bathymetry is accurately known (working on the principal that no animal can dive deeper than the bottom).

The considerations above are most important with respect to absolute animal position. However, even when long deployments of dead-reckoners result in so much error (e.g. via differential drift) that accurate true positions cannot be resolved, the relative movement displayed by the animal for periods during that deployment can still be usefully assessed in a behavioural context (see e.g. All below) provided the time interval over which the analysis is conducted is not excessive.

Overall, dead-reckoning appears to be a very promising approach for determination of animal movements, for elucidating habitat preferences and, with its high spatial- and temporal resolution, a powerful methodology for highlighting particular movement patterns which are indicative of behavioural processes (Viswanathan et al., 1999; Viswanathan et al., 1996; Frair et al., 2005; Benhamou, 2004 such as specific tracks resulting from tracking prey via scent). The ability of researchers to recognise these latter elements, however, necessitates an analytically robust approach so that the behavioural elements in movement become apparent irrespective of the scale over which they occur. This is where the proposed All analysis could play a useful role.

#### 4.2.2 Limitations of the IMASEN

The trials using animals in captivity ended being rather less successful than anticipated. Four factors contributed to this;

- Animals in captivity were always fed on dead prey. Even though the seals were highly motivated, they may not feed in a manner similar to animals found in the wild. In particular, captive animals may manipulate food much more than wild congeners which makes captivity/wild cross-border comparisons difficult.
- The conditions under which the harbour seal was fed mirrored those to which it was accustomed in captivity, namely of it being fed on a single prey species (herring) within a rather narrow size range. This leaves little room for prey-dependent variance in the jaw angle response over time which may explain why attempted correlations were weak or non-existent. It should be noted that in the first presentation of this method on penguins, the size range of prey presented varied (in mass) by a factor of more than 250 (Wilson et al., 2002a).
- It was difficult to obtain a large sample size of captive animals. The reluctance of many zoos to participate in this type of work coupled with uncooperative (and powerful) animals means that studies of this type on pinnipeds will almost always be carried out on just a few individuals.
- This situation is exacerbated by the amount of work that needs to be carried out to actually equip animals under these conditions. Issues such as device attachment, which would be relatively trivial in land animals, become comparatively time-consuming because the IMASEN has to be attached to surfaces that are normally wet, with all the problems that this entails.

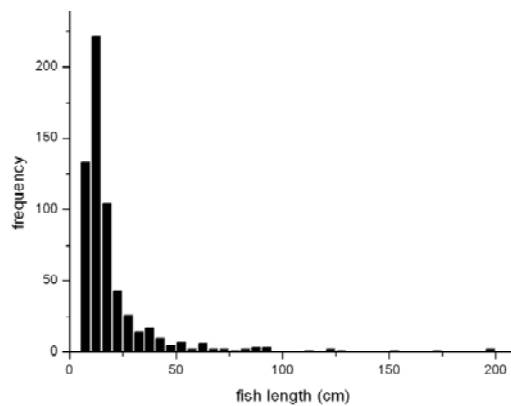
### 4.3 Utility of the IMASEN

Despite the limitations mentioned above, there are a number of levels indicative of prey ingestion which have been clarified by this study.

- Firstly, prey cannot be ingested without it being registered by the IMASEN. Thus, the most primitive condition is that the units will always signal that the jaw has opened, a necessary pre-requisite for feeding.
- Secondly, jaw openings associated with ingestion are almost certain to be discernable from jaw openings where prey was not ingested. This is indicated by signatures in the jaw-opening angle over time indicative of an initial snap followed by manipulating and/or chewing before the prey was ingested. Additional information from other sensors, such as depth transducers may help in this matter.
- A further stage involves determination of the mass of the prey ingested. This has proved equivocal in the captive study for reasons stated above. Indeed, the variance in the response shown by the harbour seal (Fig. 61/62) indicates that prey mass estimations may have considerable error. Nonetheless, there is little doubt that larger prey will generally result in a larger integral of jaw angle over time and more data are required on motivated animals fed on prey of a larger size range to clarify the matter.
- Finally, the work done in captivity has not helped elucidate whether different prey types may result in a different signature in jaw angle over time during handling and ingestion. This is a particularly exciting aspect of the work that also requires a good deal more work. There are, however, indications from the studies done on the free-living Weddell seals that there are some cues that might be used to help differentiate prey types. Assuming that the identification of feeding events in Weddell seals can be based upon the patterns found in harbour seals (because both species are true seals with very similar anatomic features), the size range and morphology of herring fed to



the captive animals corresponds closely with the predominant size of Antarctic silverfish (Fishbase, 2006), a primary food source for Weddell seals in the study area (Plotz et al., 2001). Estimates of fish size (length) of the Weddell seals' prey, based on the calculated integral and the relation between integral and fish length acquired from the harbour seal, shows a clear peak in the frequency distribution between 10 cm and 15 cm (Fig. 117). Indeed, most estimated fish sizes were not bigger than 25 cm, which accords with the maximum size for Antarctic silverfish (Fishbase, 2006) (cf. Fig. 99A). However, use of the



**Figure 117.** Diel rhythms in diving behaviour and depth exploitation of four free-ranging Weddell seals. (A) animal # '2'. (B) animal # '4'. (C) animal # '7'. (D) animal # '11'.

same procedure and regression equation for some prey caught by the Weddell seals indicates a maximum fish length of 195 cm! Although this is obviously extremely unlikely (but see Davis et al., 2003) it

highlights a dichotomy in prey types (see Fig. 117). Indeed, the overall form of the jaw angle over time (Fig. 99), the location of prey capture in the water column and the different behaviour of animals feeding on such large prey (Fig. 102) augurs very strongly for a species other than *Pleuragramma antarcticum*. The most likely candidate is Antarctic cod (*Dissostichus mawsoni*) which is a species also consumed by Weddell seals (Davis et al., 1999). Definitive proof is lacking and, given the problems of working in captivity, may be hard to acquire. Perhaps short-term equipment of animals with video cameras (Davis et al., 2003) could be used to calibrate IMASEN signals with particular prey

types in wild animals. Subsequently, the IMASENs could be used alone, presumably having much less impact on the animals (Walker & Boveng, 1995) and being able to be deployed for much longer periods.

Overall, therefore, the IMASEN system shows great promise for use on pinnipeds. It can identify prey ingestion events with reasonable certainty and larger prey items are likely to produce more dramatic jaw movements. Further, it could be suggested that much more information on feeding could be obtained if the Hall sensor was also bound to a tri-axial accelerometer (cf. Wilson et al., 2005) so that head and jaw movements associated with prey capture could be used to build up a species-, or size-specific key. Although trials with animals in captivity are clearly useful, researchers need to be aware of their drawbacks. An alternative, albeit an onerous one, might be to equip free-living animals with IMASENs for foraging trips and undertake stomach sampling (Antonelis et al., 1987; Boness et al., 1994) immediately after they return to the colony. The most recently-ingested prey will presumably be the least digested and it might be possible to work back through time in both prey swallowed and the IMASEN signals.

To date, the IMASEN system has been tried on 14 species of animal (Ropert-Coudert, 2002; Ropert-Coudert et al., 2004; Takahashi, in press (2005); Wilson et al., 2002a) and it would probably be fair to say that the marine mammals are the most difficult to equip and interpret of the species thus far equipped. Part of this stems from the habitat in which they live, which does not lend itself to easy study by man. However, the rewards for successful deployment are correspondingly greater and this should be reason enough for continued efforts to define and refine the IMASEN in this field.

## Chapter 5 Synthesis

The previous sections of this thesis have examined the foraging behaviour of two seal species in detail, using state-of-the-art technologies attached to the free-living animals so as to define, as properly as possible, how these two species allocate their time into behaviours during 'foraging'. The general term 'foraging' is often poorly defined. Here, it is taken to mean 'behaviour directed to acquiring food'. For seals, it can be broken down into 'transit', 'searching' and 'acquisition'. 'Transit' is where the animal moves from one site of low (or no) prey density to another of high density and thus refers both to animals moving to and from their haul-outs (in the horizontal plane) and animals moving from the water surface to depth (in the vertical plane). 'Searching' behaviour constitutes an attempt by the animal to locate prey not yet perceived and only occurs when the zone is appropriate. An appropriate zone may have been identified by the animal in a previous foray or may be identified by cues for prey densities high enough to warrant search behaviour (cf. Bailey & Thompson, 2006). 'Acquisition' occurs after perception and terminates with ingestion. A major part of this thesis is concerned with 'transit', although for this to be defined it is obviously necessary to define the other two elements to foraging. Air-breathing marine animals that repeatedly return to land and dive for food necessarily spend appreciable time in transit in both the horizontal and the vertical planes. As Orians and Pearson (1979) in their seminal work point out, transit time is not, in itself profitable so there is selection pressure for it to be generally minimized. But the condition is complex because, as many authors have recognized since the publication of the central-place foraging work by Orians and Pearson (1979), increases in transit time and energy are defensible if the rewards are appropriate (Brodin & Jonsson, 2003; Diaz et al., 1998; Korpimake et al., 1994).

This work notes that all pinnipeds are central place foragers but that the variance in strategies is huge, ranging from the elephant seal, which ranges up to 5000 km over 6 months absence at sea (Hindell, 2002) while diving to depths in excess of 1500 m (Hindell, 2002; Le Boeuf et al., 1988) to the harbour seal,

which usually forages within 60 km of the colony during trips lasting a few hours and diving rarely to depths in excess of 50 m (Krafft et al., 2002; Thompson et al., 1996; Tollit et al., 1998). Although this sort of information allows the build-up of a general picture, a major difficulty in previous studies of pinniped foraging, has been the allocation of the foraging period to 'transit', a critical concept to understanding the strategy of central place foragers. This has come about because the researchers involved have not had access to the necessary technology, unlike the work in this thesis.

This final section, therefore, will attempt to put the foraging strategies of two pinnipeds living in quite different conditions (Jonsson, 1997; Jonsson et al., 1999) into perspective by examining their strategies with respect to the 'central place' approach. The specifics of these two species will, however, be broadened in an attempt to encompass other pinnipeds so as to define which features limit species to their ranges and define their habitats.

The time away from the central place is initially treated separately according to dimension, with consideration given to (i) depth and (ii) horizontal displacement. The central premise behind them is the same; that increasing time away from the central place results in an increasing disadvantage (Leopold et al., 1996; Markman et al., 2004). Subsequent consideration of both elements together, however, should give an overview of how animal phenotype coupled with the spacing of prey within the environment determines species-specific optimum foraging strategies.

## **5.1 Economic Strategies**

### **5.1.1 Dive efficiency**

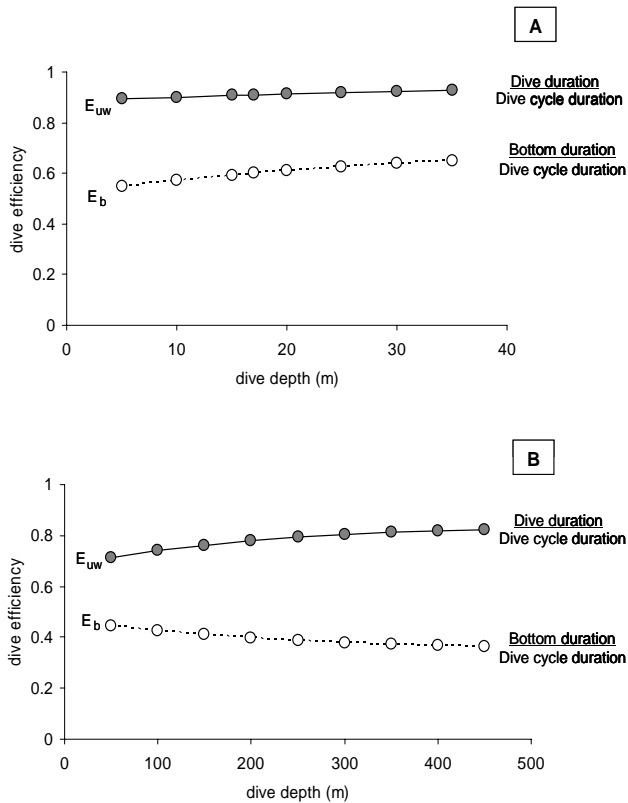
During foraging, marine mammals can increase foraging efficiency by increasing the relative proportion of time spent underwater compared to that spent at the surface because it is only by being underwater that prey can be encountered, the period at the surface serving uniquely to replenish body oxygen stores and eliminate carbon dioxide (Butler & Jones, 1997). Thus, the primary

disadvantage to spending time underwater is that subsequently time must be spent at the surface recovering. This time is not expected to be linearly related to the time underwater, however, because, all other things being equal, the rate of oxygen acquisition by the body is proportional to the difference in partial pressure between oxygen in the body and that of the air (Butler & Jones, 1997; cf. Wilson & Quintana, 2004). This situation is complicated by animal physiology and body reaction to oxygen deficit, manifest in features such as variation in heart stroke volume, tachycardia (Butler & Woakes, 1979), hyperventilation (Gehr et al., 1981) and changes in blood shunting around the body (Butler & Jones, 1997; Costa & Gales, 2003). It can, however, be conveniently expressed by the surface duration with respect to the time spent underwater and this can be examined for varying dive durations (Kooyman, 1989).

Assuming that all diving executed by the Weddell seals were foraging dives (section 3.2.4) and that the dives executed by harbour seals could be divided into foraging/travelling and ‘other’ such as sleep (see section 3.1.6), the apparent underwater efficiency  $E_{uw}$ , is defined by;

$$E_{uw} = \frac{\text{dive duration}}{\text{dive cycle duration}} \quad (15)$$

For foraging dives for both Weddell and Harbour seals from this study, the underwater efficiency appears to remain approximately stable for dives of duration ca. 2-6 min for harbour seals and 9-25 min for Weddell seals (Fig. 117 - compiled using data presented in sections 3.1.3 and 3.2.3), although there is evidence for a marginal increase with depth. This latter may be due to animals attaining close to neutral buoyancy during the deeper dives, which results in energy saving during swimming (Sato et al., 2003; Williams et al., 2000). However, neither the Harbour seal nor the Weddell seal data derived from this study had animals diving close to their apparent maxima (ca. 500 m Burns, 2002) and lasting 31 min for harbour seals (Ries et al., 1997) and 726 m (Schreer & Testa, 1996) and lasting 82 min for Weddell seals (Thomas, 2002). Incorporation



**Figure 117.** Dive efficiency of harbour (A) and Weddell seals (B) according to definition and as a function of dive depth. The upper (continuous) line in both graphs (filled circles) shows the efficiency based on the time spent underwater,  $E_{uw}$ , relative to the full dive cycle duration, the lower (dotted line with open circles) indicates the efficiency based on the time spent in the bottom phase of the dive,  $E_b$ , relative to the full dive cycle duration (see text).

of such data from the literature shows, as expected, that efficiency overall decreases substantially with depth due to the accelerating nature of the pause duration with respect to dive duration (cf. Fig. 118). Thus, the general trend from both animals concurs with that predicted based on rates of replenishment of body oxygen stores and tends to make deep dives inefficient (Kramer, 1988).

Kooyman et al. (1992)

point out, however, that true definition of dive efficiency must take into account the periods when the animal can effectively search versus the total period involved in the

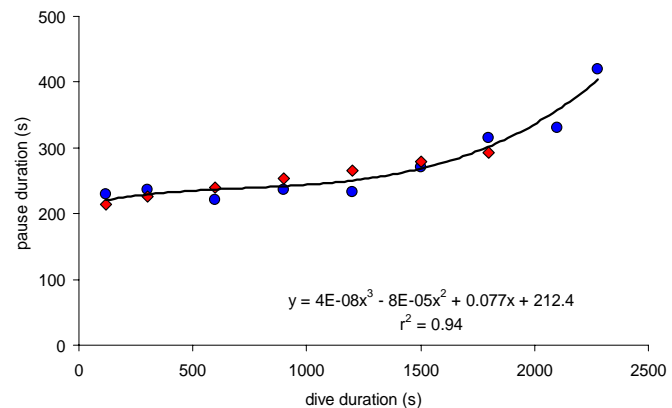
dive cycle, which includes transit time between the surface and the foraging depth as well as the recovery time at the surface (cf. Halsey et al., 2003). The time underwater during a dive can be further broken down into that time where prey are most likely to be encountered and that time involving transit. The harbour seals in this study had dive profiles that indicated that prey were sought at the sea bed (section 3.1.3); all data derived from the IMASEN indicated prey caught on the sea bed, and the diet of this species, both in the North Sea and the other areas of the world, consists primarily of demersal prey such as cephalopods, gadoids and flatfish (Pierce & Santos, 2003; Berg et al., 2002; Wilson et al., 2002). Thus, the real time-based efficiency of the animal is the

efficiency for the time spent during the search, or bottom phase of the dives,  $E_b$ , best determined by dividing the duration of the bottom phase of the dive by the dive cycle duration so that;

$$E_b = \frac{\text{bottomduration}}{\text{surfaceduration} + \text{descentduration} + \text{bottomduration} + \text{ascentduration}} \quad (16)$$

(Kooyman et al., 1992). The case of the Weddell seal appears less clear-cut since this animal feeds both on pelagic prey (such as *Pleuragramma antarcticum*) as well as benthic species such as Antarctic cod (*Dissostichus mawsoni*) (Davis et al., 1999). However, the vertical distribution of the primary pelagic prey is highly stratified due either to the association of species with the underside of the ice (Watanabe et al., 2006) or with particular physical strata in the water column. Thus, dive profiles of Weddell seals (Chapter 3) are very similar to those typical of predators that exploit the seabed (Davis et al., 1999) except that the depth of the bottom phase is more variable. As such, the formula proposed for foraging efficiency by Kooyman et al. (1992) (eqn. 2) can be applied in a similar manner to that of the harbour seal (Fig. 117).

Application of this shows a similar trend to that observed in efficiency based on simple pause and dive durations (see above) for presumably similar reasons (see above), although the overall efficiency tends to be

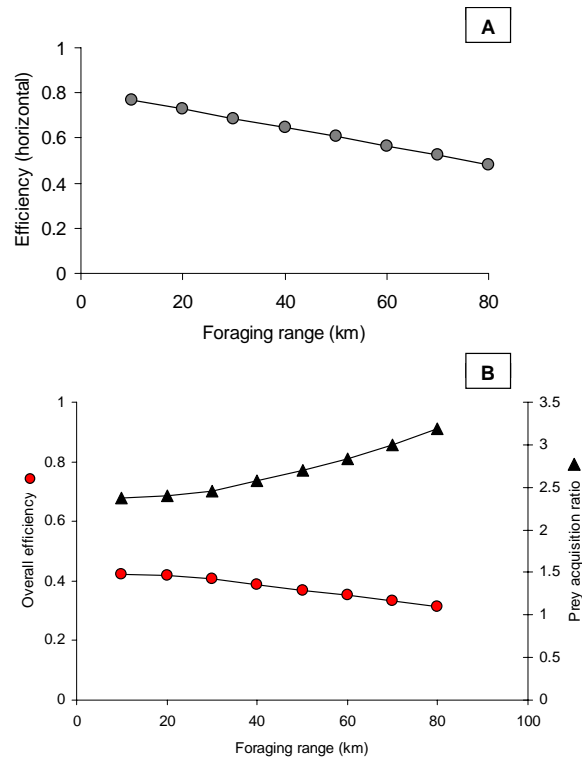


**Figure 118.** Relationship between pause duration and dive duration for Weddell seals using data derived from this thesis (red rhomboids - see section 3.2.2) and data presented by Burns (1999) (blue circles). The line of best fit was used for both data sets. The Burns et al. data were included because they represent instances where the seals dived deeper and for considerably longer than was experienced during this study and for considerably longer than was experienced during this study which expands the range and emphasises the accelerating nature of the relationship at extended dive durations.

lower (see upper and lower lines in both Fig. 117A and Fig. 117B) due to the time taken for transit being factored into the definition.

### 5.1.2 Foraging range

The effect that variability in foraging range has on foraging efficiency has been highlighted in recent studies by Wilson et al. (2005) (for penguins) and Müller et al. (2004) (for sea lions). As in the case for efficiency during dives, derivation of efficiency as a function of foraging range can be alluded to by simply considering the time spent in the area used for hunting divided by the total time used for one foraging plus haul-out cycle (itself being made up of the sum of the time spent in the hunting area, the time at the haul-out site, and the time spent in transit between the haul-out site and the hunting area). This approach for the data derived from Harbour seals shows that, as expected, efficiency decreases with increasing distance between foraging- and haul-out sites (Fig. 119) as the transit time impinges increasingly



**Figure 119.** (A) The foraging efficiency of harbour seals as a function of distance from the haul-out site based on the time at sea not involved in transit to and from the foraging site relative to the total time involved in a full foraging plus haul-out cycle. (B) The overall efficiency of harbour seals as a function of distance from the Lorenzenplate, including both vertical and horizontal components (cf. Fig 117 & 119A - line denoted by red circles). Here, the water depth at various distances from the haul-out sandbank along the main axis of travel (Fig. 32) has been taken from contour maps and these serve as depths for which the dive efficiency can be calculated. Thus, the overall efficiency is the ratio of the total time spent during the bottom phase of the dive (for the relevant depth) compared to the total time spent for a complete foraging plus haul-out cycle. The inverse of this is also shown (line with black triangles), labelled as the ‘prey acquisition ratio’ since it is a measure of the amount of prey that must be acquired in the time actually spent foraging in order to cover for the energetic costs incurred during a normal foraging plus haul-out cycle.



on the time available for hunting. All other things being equal, such an approach indicates that harbour seals foraging 10 km from their haul-out site are some 60% more efficient than if they range to 80 km. This procedure could not be carried out for the Weddell seal data since the animals were actually foraging in the water just under their haul-out sites on the ice (Fig. 86).

### 5.1.3 Integrated efficiency

A true measure of the foraging efficiency of pinnipeds, however, can only be derived by consideration of both the vertical and horizontal elements of the foraging cycle. Combination of these to produce an overall efficiency value,  $E_o$ , for harbour seals is:

$$E_o = \frac{\textit{searchduration}}{(\textit{foraging} - \textit{haul} - \textit{out} - \textit{cycleduration})} \quad (17)$$

To access this from the data it is necessary to define how each of the above terms is made up from the data collected. Since the descent, bottom, and ascent durations are all dependent on maximum depth reached during the dive, their values can be described by;

Descent duration =  $f1 (D_p)$ ,

Bottom duration =  $f2 (D_p)$ ,

Ascent duration =  $f3 (D_p)$ ,

where  $f$  plus the integer describes a particular function and  $D_p$  is the maximum depth reached during any given dive (Table 4; p. 148). Pause duration at the surface can also be defined in this manner although, for reasons explained later related to the accelerating pause duration with dive duration (cf. Fig. 118, Kramer, 1988), it is more convenient to express the surface pause duration as a function of the total dive duration (with which it correlates) so that;

$$Pauseduration = f4[f1(D_p) + f2(D_p)f3(D_p)] \quad (18)$$

where  $f4$  represents a function of the terms within the brackets (Table 4; p. 148). During travelling to the search zone, harbour seals swim at a horizontal speed,  $v$ , which is derived from the normal swim speed (Crocker et al., 2001) multiplied by the fraction of the travel time spent underwater because seals do not travel appreciably at the water surface. If the foraging range is described by  $F$ , the time spent commuting is therefore;

$$T_C = 2F/v \quad (19)$$

because the animals have to swim out to the search zone and back to the haul-out site again.

If the total time at sea during foraging is  $T_s$ , the time spent in the search zone is;

$$T_{SZ} = T_s - 2F/v \quad (20)$$

and the total number of dives conducted;

$$N = (T_s - 2F/v) / (f1(D_p) + f2(D_p) + f3(D_p)) + f4(f1(D_p) + f2(D_p) + f3(D_p)) \quad (21)$$

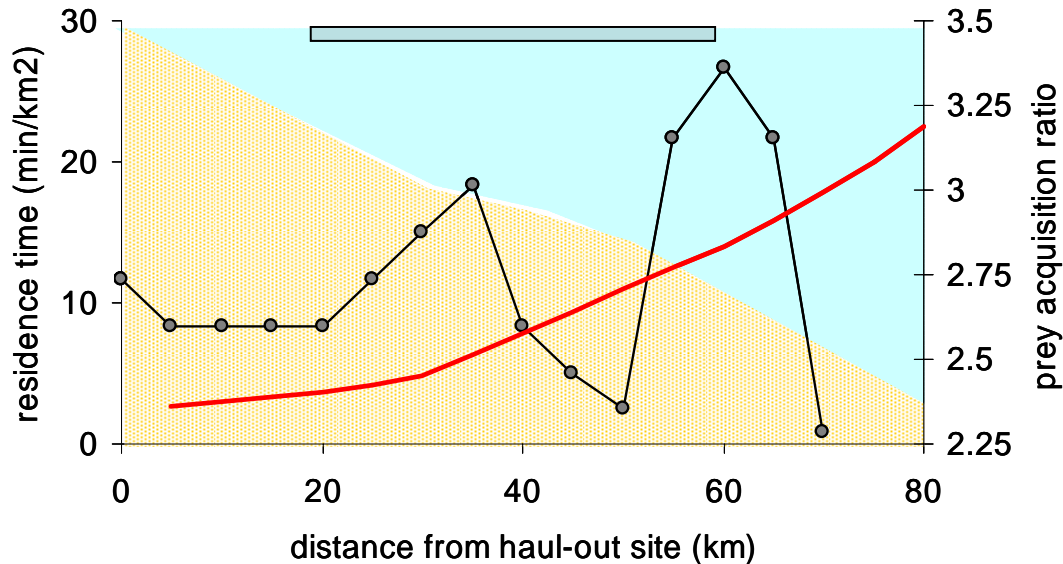
If the time on land =  $T_l$ , the efficiency is described by;

$$E_o = Nf2(D_p) / (T_s + T_l) \quad (22)$$

Using data from this study (Table 4; p. 148), it becomes clear that efficiencies for harbour seals are highest closer to the haul-out site, at around 0.42, decreasing to 0.31 for foraging ranges of 80 km (Fig. 119B). Importantly, if the foraging strategies indicated are to be tenable, the farther away from the haul-out site the animals forage, and/or the deeper the dives, the higher the rate of prey acquisition during searching must be to correct for the decreased efficiencies (cf. Maxwell & Calver, 1998). In fact, inversion of the efficiency values gives a measure of the rate at which prey need to be encountered for the specific strategies to be tenable. This value, which can be termed the 'prey acquisition ratio' (PAR), indicates the number of hours that seals can spend engaged in any (unspecified) activity for every hour they spend searching for prey. The higher the ratio, the higher the prey ingestion rate must be during foraging. Although the PAR will not equate completely linearly with energy (Ydenberg & Hurd, 1998), because the various time phases of the foraging cycle correspond to different energy expenditures (Costa & Gales, 2003; Sparling & Fedak, 2004), its broad, strictly time-based, approach means that it can be applied to any pinniped, or to generate a 'model' pinniped without having to worry about the paucity of data on activity-specific metabolic rate for differing species.

Central place foragers, in general, should attempt to forage under conditions which maximize the PAR (cf. Markman et al., 2004). However, the specific site at which pinnipeds choose to forage (cf. Waugh & Weimerskirch, 2003) will represent a balance between the constraints of animal phenotype (dive capacities, rate of oxygen use underwater, rate of accumulation of oxygen during the surface pauses etc.), which ultimately dictate overall efficiency with respect to access of the searching zone, and real prey abundance, which will vary with both depth and distance from the haul-out site. The harbour seal data for animals foraging from the Lorenzenplate indicate that the prey acquisition ratio at distances of less than 18 km (in water depths of less than 15 m) (Fig. 120) are inadequate to initiate searching behaviour, perhaps due to Ashmole's halo (Birt et al., 1987), even though prey may be found in that region (cf. Fig. 63). Apparently, the prey density increases enough at ca. 20 km from the haul-out site

at 15 m depth to make foraging tenable at PAR-values of around 2.4 as evidenced by All-values and seal residence times. The increases in PAR with



**Figure 120.** Prey acquisition ratio (red line) for harbour seals foraging from the Lorenzenplate and following an approximately West-South-West trajectory. The black line shows the residence duration derived from all equipped harbour seals per km<sup>2</sup> along the defined transect line while the yellow shading denotes water depth (no scale is shown but the minimum is 0 m at the haul-out site and the maximum 37 m at 80 km). The horizontal bar denotes Alls of predominantly > 0.9 which indicates active prey searching. Note that there are two peaks in residence duration, one at almost 40 km, and another at just after 60 km. The second of these is exclusively due to the animal that moved from the Lorenzenplate to Helgoland (see results) from which point multiple foraging trips were conducted. Note also that the PAR for this animal would not be the value shown in red since it is commuting a much shorter distance than the seals from the Lorenzenplate.

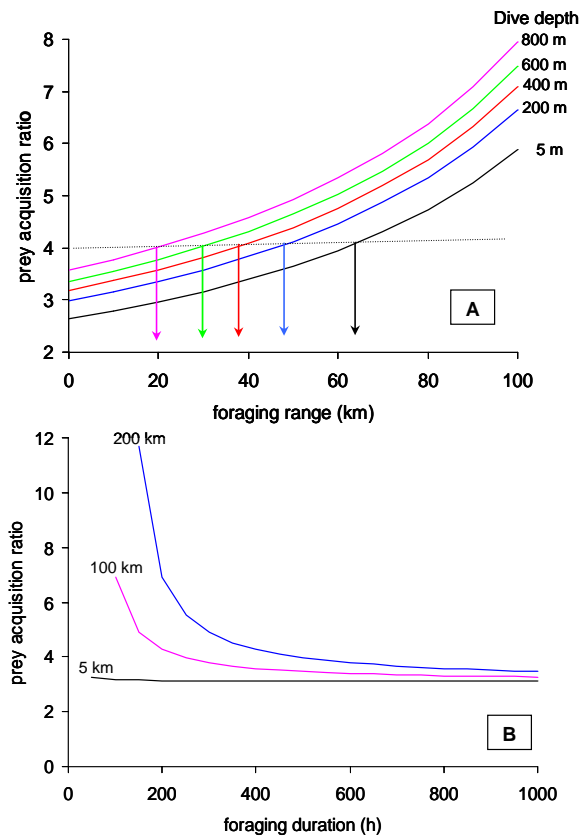
increasing distance from the haul-out site in Fig. 120 do not apply to the second peak in seal residence times at ca. 60 km from the haul-out site because these residence times are derived from an animal that had Helgoland as its central place and would therefore have a different PAR, increasing with distance from its own central place. The degree to which the PAR changes with increasing distance, and depth, from the haul-out sites would make a fascinating subject for further study: Future work could gather data from a number of different, but adjacent, haul-out sites used by harbour seals to see the extent to which foraging areas overlapped, how the PARs changed with increasing distance and what putative PARs were in the areas of overlap. Such work may prove particularly

valuable for identifying 'hot-spots' in prey densities, at least as far as the seals are concerned.

## 5.2 Generalized model

The model of prey acquisition ratios presented above can be generalized in order to examine how pinnipeds are to be expected to forage under particular circumstances. The problem with this thesis is that it involves a species that travels quite far (up to 70 km) but does not dive deep in the study area (the harbour seal) and another species that dives deep (up to 400 m) but does not travel far (the Weddell seal). In order to illustrate trends, however, it is legitimate to combine data to produce a model seal that can both dive deep and swim far. For this, the travelling speeds and percent time spent underwater during travelling are taken from the harbour seal (Table 4; p. 148) while the characteristics of the long, deep searching dives (descent-, bottom- and ascent duration as well as pause duration) are taken from the Weddell seals (Table 4; p. 148). As mentioned above, there are good reasons why the diving behaviour of pinnipeds adhere to the patterns observed (Kramer, 1988; Wilson & Quintana, 2004). Combination of the harbour seal travelling data with the Weddell seal deep-diving behaviour might produce a model for an animal that does not actually exist, but it will show broad pinniped trends in efficiency (or necessary PARs) in relation to depth, distance of the foraging site from the haul-out site, and time spent at sea during the foraging cycle (cf. Arnould & Hindell, 2001; Beck et al., 2003; Boyd, 2000). In order to make the model as proper as possible, however, a further data set is included. This stems from Burns et al. (1999) and details the relationship between surface pause duration and duration of the preceding dive in Weddell seals. This is pertinent because the Burns et al. (1999) data set incorporates much longer dives to much deeper depths than occurred during the Weddell seal study documented here. Thus, data from Burns et al. (1999) are added to data derived from this study (Fig. 118) and a polynomial curve fitted through the data to derive the relationship used for the model (Table 4; p. 148).

The model shows that, for a constant foraging duration, and in an



**Figure 121.** (A) Prey acquisition ratio of a pinniped (adhering to a harbour seal travelling scenario and Weddell seal foraging scenario - see text) as a function of foraging range for different foraging depths. The length of the foraging period at sea was held constant at 100 h, with the haul-out period also being constant at 20 h. The horizontal line at a prey acquisition ratio of 4.0 indicates how animals diving deeper, closer to the haul-out site may have the same prey acquisition ratio of animals diving more shallowly but at greater distances from the haul-out site. (B) Prey acquisition ratio of a pinniped (adhering to a harbour seal travelling scenario and Weddell seal foraging scenario - see text) as a function of total time available for the foraging trip for different foraging ranges. Foraging depth was held constant at 300 and the haul-out duration was taken to be 20% that of the foraging duration.

al., 2004; Wilson et al., 1993), judicious selection for foraging time may allow some pinnipeds easier access to prey if foraging takes place when the prey are closer to the surface (Croxall et al., 1985; Wilson et al., 1993).

The situation is changed substantially if seals change the duration of the

environment where the seabed does not limit water depth within the diving capacities of the seals, prey accessibility (indicated by PAR) must increase as the animal forages farther from the haul-out site (Fig. 121A) if the seal is to survive. In addition, if animals forage at any given distance from the haul-out site, prey accessibility must increase with increasing depth (Fig. 121). If the PAR is assumed to be constant at all distances from the haul-out site (see horizontal line in Fig. 121A), animals can survive by foraging close to the haul-out site if the prey are deep but have to have access to prey closer to the surface as the foraging range increases (Fig.121). Note that this model describes a general scenario with regard to depth and distance with no provision for potential changes that prey might undergo with respect to depth distribution over the course of the 24 h cycle (cf. Davoren et al., 2003). Since many pinnipeds prey exhibit diel vertical migration (Brodeur & Wilson, 1996; Jansen et al., 1998; Watanabe et

foraging phase. For prey at any given depth, increases in foraging phase duration change the necessary PAR little if the prey are located close to the haul-out site (Fig. 121B) but make an increasingly greater difference for prey stocks that are located farther away from the rest site (Fig. 121B). Thus, it would seem that pinnipeds foraging close to the haul-out sites gain little by spending extended periods at sea; indeed whatever advantage it is that obliges them to return to their haul-out site would presumably act against longer periods at sea. Contrarily, species that exploit distant prey resources need to spend longer periods at sea so that the PAR needed by them ties in with the availability of prey at the appropriate distance. This latter strategy has two disadvantages; (1) that the advantages accrued by being at the haul-out site are diminished (although these could be partially negated by extending the haul-out duration) and (2) that long periods travelling (and long periods at the haul-out site) require appropriate body reserves. It is to be expected, therefore, that any pinnipeds that range widely in search of food have morphological features that allow them to withstand the extended famine and feast regime that such a strategy entails (cf. Robin et al., 2001).

Body mass will be a primary driver in this because mass-specific metabolic rate decreases with overall body mass (Peters, 1983) while body food stores scale approximately linearly with mass (Peters, 1983). It is thus little surprising to discover that the most widely-ranging pinnipeds, the elephant seals (2 species - *Mirounga leonina* and *Mirounga angustirostris*), are those that spend longest at sea and are also the largest (Hindell, 2002). Conversely, the smaller phocids such as ringed seals and otarids, such as Galapagos fur seals, generally forage within 50 km of their haul-out sites during trips that last a few hours (Robinson et al., 2002). Large body mass also confers greater diving capacity on animals (Boyd & Croxall, 1996; Burger, 1991; Schreer & Kovacs, 1997; Schreer et al., 2001), again apparently, because mass-specific metabolic rate decreases with body mass and body oxygen stores scale linearly with mass. Thus, larger animals use their oxygen stores relatively slower than smaller ones, which extends the time that they can spend underwater, which, in turn, allows them to



dive deeper if necessary (Halsey et al., 2006). Seabed topography around the haul-out sites, however, will determine the extent to which deep dives can be performed (e.g. Werner & Campagna, 1995). Thus, many species with short foraging ranges will not have the opportunity to dive deeply, even if they are massive (cf. Mueller, 2004) so it is unreasonable to expect all large pinnipeds to dive deeply at all times (Costa & Gales, 2003; Merrick & Loughlin, 1997). In addition, work on territoriality in pinnipeds has shown that some species experience severe selection pressures for large size (Modig, 1996) related to harem acquisition. Overall though, clearly the viability of any site for hauling-out for pinnipeds will depend on a complex interacting web of proximity to defined prey densities (both in the vertical and horizontal dimensions), animal phenotype and the advantages to be gained by extended (and frequent) time spent at the haul-out site. I would like to think that this thesis has shed some light on the mechanisms driving some pinnipeds strategies for foraging at sea. Paradoxically, the period on land when these animals are most easily studied, appears to hold the key that ultimately binds the various species to the manners they display.



# Bibliography

- Adelung, D., Wilson, R.P., Liebsch, N. 2004. MINOS – Marine warm-blooded animals in the North and Baltic Seas: Foundations for assessment of offshore wind farms. Summary on subproject 6 – harbour seal telemetry: WWW Page, [http://www.wattenmeer-nationalpark.de/themen/minos/minos2\\_download\\_rep.htm](http://www.wattenmeer-nationalpark.de/themen/minos/minos2_download_rep.htm).
- Antonelis, G. A., M. S. Lowry, D. P. Demaster, and C. H. Fiscus. 1987. Assessing Northern Elephant Seal Feeding-Habits by Stomach Lavage. *Marine Mammal Science* 3:308-322.
- Arnould, J. P. Y., and M. A. Hindell. 2001. Dive behaviour, foraging locations, and maternal-attendance patterns of Australian fur seals (*Arctocephalus pusillus doriferus*). *Canadian Journal of Zoology-Revue Canadienne De Zoologie* 79:35-48.
- AWI. 2005. <http://www.awi-bremerhaven.de/Climate/rndweddell.html>.
- Baechler, J., C. A. Beck, and W. E. Bowen. 2002. Dive shapes reveal temporal changes in the foraging behaviour of different age and sex classes of harbour seals (*Phoca vitulina*). *Canadian Journal of Zoology-Revue Canadienne De Zoologie* 80:1569-1577.
- Bailey, H., and P. Thompson. 2006. Quantitative analysis of bottlenose dolphin movement patterns and their relationship with foraging. *Journal of Animal Ecology* 75:456-465.
- Bannasch, R., R. P. Wilson, and B. Culik. 1994. Hydrodynamic Aspects of Design and Attachment of a Back-Mounted Device in Penguins. *Journal of Experimental Biology* 194:83-96.
- Baylis, A. M. M., B. Page, K. Peters, R. McIntosh, J. McKenzie, and S. Goldsworthy. 2005. The ontogeny of diving behaviour in New Zealand fur seal pups (*Arctocephalus forsteri*). *Canadian Journal of Zoology-Revue Canadienne De Zoologie* 83:1149-1161.
- Beck, C. A., W. D. Bowen, and S. J. Iverson. 2003. Sex differences in the seasonal patterns of energy storage and expenditure in a phocid seal. *Journal of Animal Ecology* 72:280-291.
- Benhamou, S. 2004. How to reliably estimate the tortuosity of an animal's path: straightness, sinuosity, or fractal dimension? *Journal Of Theoretical Biology* 229:209-220.

- Berg, I., T. Haug, and K. T. Nilssen. 2002. Harbour seal (*Phoca vitulina*) diet in Vesteralen, north Norway. *Sarsia* 87:451-461.
- Bigg, M. A. 1981. Handbook of Marine Mammals by Ridgway SH and Harrison RJ. . Academic Press London 2: Seals:1-27.
- Birt, V. L., T. P. Birt, D. Goulet, D. K. Cairns, and W. A. Montevecchi. 1987. Ashmole Halo - Direct Evidence For Prey Depletion By A Seabird. *Marine Ecology-Progress Series* 40:205-208.
- Blackwell, S. B., C. A. Haverl, B. J. Le Boeuf, and D. P. Costa. 1999. A method for calibrating swim-speed recorders. *Marine Mammal Science* 15:894-905.
- Boness, D. J., W. D. Bowen, and O. T. Oftedal. 1994. Evidence of a Maternal Foraging Cycle Resembling That of Otariid Seals in a Small Phocid, the Harbor Seal. *Behavioral Ecology and Sociobiology* 34:95-104.
- Bornemann, H., E. Mohr, J. Plotz, and G. Krause. 1998. The tide as zeitgeber for Weddell seals. *Polar Biology* 20:396-403.
- Bornemann, H., and J. Plotz. 1993. A Field Method for Immobilizing Weddell Seals. *Wildlife Society Bulletin* 21:437-441.
- Bost, C. A., J. Y. Georges, C. Guinet, Y. Cherel, K. Putz, J. B. Charrassin, Y. Handrich et al. 1997. Foraging habitat and food intake of satellite-tracked king penguins during the austral summer at Crozet Archipelago. *Marine Ecology-Progress Series* 150:21-33.
- Boyd, I. L. 2000. State-dependent fertility in pinnipeds: contrasting capital and income breeders. *Functional Ecology* 14:623-630.
- Boyd, I. L., and J. P. Croxall. 1996. Dive durations in pinnipeds and seabirds. *Canadian Journal of Zoology-Revue Canadienne De Zoologie* 74:1696-1705.
- Brodeur, R. D., and M. T. Wilson. 1996. A review of the distribution, ecology and population dynamics of age-0 walleye pollock in the Gulf of Alaska. *Fisheries Oceanography* 5:148-166.
- Brodin, A., and K. I. Jonsson. 2003. Optimal energy allocation and behaviour in female raptorial birds during the nestling period. *Ecoscience* 10:140-150.
- Brown, E. G., and G. J. Pierce. 1997. Diet of harbour seals at Mousa, Shetland, during the third quarter of 1994. *Journal of the Marine Biological Association of the United Kingdom* 77:539-555.
- Brown, E. G., and G. J. Pierce. 1998. Monthly variation in the diet of harbour seals in inshore waters along the southeast Shetland (UK) coastline. *Marine Ecology-Progress Series* 167:275-289.

- Burger, A. E. 1991. Maximum diving depths and underwater foraging in alcids and penguins. Canadian Wildlife Service Occasional Paper 68:9-15.
- Burns, J. J. 2002. Harbor Seal and Spotted Seal in W. F. Perring, B. Wuersig, and J. G. M. Thewissen, eds. Encyclopedia of Marine Mammals. San Diego, Academic Press.
- Burns, J. M. 1999. The development of diving behavior in juvenile Weddell seals: pushing physiological limits in order to survive. Canadian Journal of Zoology- Revue Canadienne De Zoologie 77:737-747.
- Butler, P. J., and D. R. Jones. 1997. Physiology of diving of birds and mammals. Physiological Reviews 77:837-899.
- Butler, P. J., and A. J. Woakes. 1979. Changes in Heart-Rate and Respiratory Frequency During Natural Behavior of Ducks, with Particular Reference to Diving. Journal of Experimental Biology 79:283-300.
- Carpenter, P. W., C. Davies, and A. D. Lucey. 2000. Hydrodynamics and compliant walls: Does the dolphin have a secret? Current Science 79:758-765.
- Caruso, M. J. 2000. Applications of Magnetic Sensors for low cost compass systems. Honeywell SSEC:8.
- Costa, D. P., and N. J. Gales. 2003. Energetics of a benthic diver: Seasonal foraging ecology of the Australian sea lion, *Neophoca cinerea*. Ecological Monographs 73:27-43.
- Crocker, D. E., N. J. Gales, and D. P. Costa. 2001. Swimming speed and foraging strategies of New Zealand sea lions (*Phocarctos hookeri*). Journal of Zoology 254:267-277.
- Croxall, J. P., I. Everson, G. L. Kooyman, C. Ricketts, and R. W. Davis. 1985. Fur-Seal Diving Behavior in Relation to Vertical-Distribution of Krill. Journal of Animal Ecology 54:1-8.
- Culik, B. M., R. Bannasch, and R. P. Wilson. 1994a. External Devices on Penguins - How Important Is Shape. Marine Biology 118:353-357.
- Culik, B. M., R. P. Wilson, and R. Bannasch. 1994b. Underwater Swimming at Low Energetic Cost by Pygoscelid Penguins. Journal of Experimental Biology 197:65-78.
- CWWS. 2005. <http://www.Waddensea-secretariat.org/index.html>
- Davis, R. W., L. A. Fuiman, T. M. Williams, S. O. Collier, W. P. Hagey, S. B. Kanatous, S. Kohin et al. 1999. Hunting behavior of a marine mammal beneath the Antarctic fast ice. Science 283:993-996.

- Davis, R. W., L. A. Fuiman, T. M. Williams, M. Horning, and W. Hagey. 2003. Classification of Weddell seal dives based on 3-dimensional movements and video-recorded observations. *Marine Ecology-Progress Series* 264:109-122.
- Davoren, G. K., W. A. Montevecchi, and J. T. Anderson. 2003. Search strategies of a pursuit-diving marine bird and the persistence of prey patches. *Ecological Monographs* 73:463-481.
- Dehnhardt, G., B. Mauck, and H. Bleckmann. 1998. Seal whiskers detect water movements. *Nature* 394:235-236.
- Dehnhardt, G., B. Mauck, W. Hanke, and H. Bleckmann. 2001. Hydrodynamic trail-following in harbor seals (*Phoca vitulina*). *Science* 293:102-104.
- Diaz, M., J. C. Illera, and J. C. Atienza. 1998. Food resource matching by foraging tits *Parus* spp. during spring-summer in a Mediterranean mixed forest; evidence for an ideal free distribution. *Ibis* 140:654-660.
- Eckert, S. A. 2002. Swim speed and movement patterns of gravid leatherback sea turtles (*Dermochelys coriacea*) at St Croix, US Virgin Islands. *J Exp Biol* 205:3689-3697.
- Ellwodd, S., R. P. Wilson, and D. Lon. in press. Do gadgets work? in D. MacDonald, and K. Service, eds. *Hot topics, serious conservation.*, Blackwell Scientific Publications.
- FAO. 1979. Mammals in the seas, Pinniped Species Summaries and Report on Sirenians; Being the Annex B Appendixes VI and VII of the Report of the FAO Advisory Committee on Marine Resources Research Working Party on Marine Mammals with the cooperation of the United Nations Environment Programme, Food and agriculture Organization of the United Nations. Rome 1979. Fisheries Series 2.
- Fish, F. E. 1998. Comparative kinematics and hydrodynamics of odontocete cetaceans: Morphological and ecological correlates with swimming performance. *Journal of Experimental Biology* 201:2867-2877.
- Fishbase. 2006. [www.fishbase.org](http://www.fishbase.org).
- Frair, J. L., E. H. Merrill, D. R. Visscher, D. Fortin, H. L. Beyer, and J. M. Morales. 2005. Scales of movement by elk (*Cervus elaphus*) in response to heterogeneity in forage resources and predation risk. *Landscape Ecology* 20:273-287.
- Gaspard, P., J. Y. Georges, G. C. Hays, and Y. Le Maho. 2005. Coupling satellite oceanography and satellite tracking to analyze navigation skills of leatherback turtles. 2. International Bio-Logging Symposium in St. Andrews, June 2005.

- Gehr, P., D. K. Mwangi, A. Ammann, G. M. O. Maloiy, C. R. Taylor, and E. R. Weibel. 1981. Design of the Mammalian Respiratory System .5. Scaling Morphometric Pulmonary Diffusing-Capacity to Body-Mass - Wild and Domestic Mammals. *Respiration Physiology* 44:61-86.
- Gentry, R., and G. L. Kooyman. 1992. *Fur seals; Maternal strategies on land and at sea.* Princeton, Princeton University Press.
- Goldsworthy, S. D., and P. D. Shaughnessy. 1994. Breeding Biology and Haul-out Pattern of the New-Zealand Fur-Seal, *Arctocephalus forsteri*, at Cape-Gantheaume, South Australia. *Wildlife Research* 21:365-376.
- Hall, A. J., J. Watkins, and P. S. Hammond. 1998. Seasonal variation in the diet of harbour seals in the south-western North Sea. *Marine Ecology-Progress Series* 170:269-281.
- Hall, E. H. 1879. On a New Action of the Magnet on Electric Currents. *Am. J. Math* 2:287.
- Halsey, L., A. Woakes, and P. Butler. 2003. Testing optimal foraging models for air-breathing divers. *Animal Behaviour* 65:641-653.
- Halsey, L. G., P. J. Butler, and T. M. Blackburn. 2006. A phylogenetic analysis of the allometry of diving. *American Naturalist* 167:276-287.
- Hays, G. C. 2003. A review of the adaptive significance and ecosystem consequences of zooplankton diel vertical migrations. *Hydrobiologia* 503:163-170.
- Hays, G. C., J. D. Metcalfe, A. W. Walne, and R. P. Wilson. 2004. First records of flipper beat frequency during sea turtle diving. *Journal of Experimental Marine Biology and Ecology* 303:243-260.
- Hindell, M. A. 2002. Elephant Seals in W. F. Perring, B. Wuersig, and J. G. M. Thewissen, eds. *Encyclopedia of Marine Mammals.* San Diego, Academic Press.
- Hindell, M. A., R. Harcourt, J. R. Waas, and D. Thompson. 2002. Fine-scale three-dimensional spatial use by diving, lactating female Weddell seals *Leptonychotes weddellii*. *Marine Ecology-Progress Series* 242:275-284.
- Hull, C. L., M. A. Hindell, and K. Michael. 1997. Foraging zones of royal penguins during the breeding season, and their association with oceanographic features. *Marine Ecology-Progress Series* 153:217-228.
- Jackson, J. B. C., M. X. Kirby, W. H. Berger, K. A. Bjorndal, L. W. Botsford, B. J. Bourque, R. H. Bradbury et al. 2001. Historical overfishing and the recent collapse of coastal ecosystems. *Science* 293:629-638.

- Jansen, J. K., P. L. Boveng, and J. L. Bengtson. 1998. Foraging modes of chinstrap penguins: contrasts between day and night. *Marine Ecology-Progress Series* 165:161-172.
- Jeffries, S. J., R. F. Brown, and J. T. Harvey. 1993. Techniques for capturing, handling and marking harbour seals. *Aquatic mammals* 19:21-25.
- Jonsson, K. I. 1997. Capital and income breeding as alternative tactics of resource use in reproduction. *Oikos* 78:57-66.
- Jonsson, K. I., J. Wiehn, and E. Korpimake. 1999. Body reserves and unpredictable breeding conditions in the Eurasian kestrel, *Falco tinnunculus*. *Journal of Zoology* 255:15-23.
- Kerley, G. I. H. 1983. Comparison of Seasonal Haul-out Patterns of Fur Seals *Arctocephalus tropicalis* and *Arctocephalus gazella* on Sub-Antarctic Marion-Island. *South African Journal of Wildlife Research* 13:71-77.
- Kiess, N. 2004. Sichtbarkeit auftauchender mariner Warmblueter in Abhaengigkeit von exogenen Faktoren. Diploma thesis, Christian-Albrechts-University Kiel, Germany. .
- Kooyman, G. L. 1989, *Diverse Divers*. San Diego, Academic Press.
- Kooyman, G. L., Y. Cherel, Y. Lemaho, J. P. Croxall, P. H. Thorson, and V. Ridoux. 1992. Diving Behavior and Energetics During Foraging Cycles in King Penguins. *Ecological Monographs* 62:143-163.
- Korpimake, E., P. Tolonen, and J. Valkama. 1994. Functional-responses and load size effect in central place foragers - data from the kestrel and some comments. *Oikos*:504-510.
- Krafft, B. A., C. Lydersen, I. Gjertz, and K. M. Kovacs. 2002. Diving behaviour of sub-adult harbour seals (*Phoca vitulina*) at Prins Karls Forland, Svalbard. *Polar Biology* 25:230-234.
- Kramer, D. L. 1988. The Behavioral Ecology Of Air Breathing By Aquatic Animals. *Canadian Journal Of Zoology-Revue Canadienne De Zoologie* 66:89-94.
- Kreye, J. M. 2003. Messung der Schwimmgeschwindigkeit und deren Konsequenz fuer luftatmende marine Vertebraten am Beispiel des Maggellanpinguins (*Spheniscus magellanicus*). Diploma thesis, Christian-Albrechts-University Kiel, Germany. .
- Lake, S. E., H. R. Burton, and M. A. Hindell. 1997. Influence of time of day and month on Weddell seal haul-out patterns at the Vestfold Hills, Antarctica. *Polar Biology* 18:319-324.



- Le Boeuf, B. J., D. P. Costa, A. C. Huntley, and S. D. Feldkamp. 1988. Continuous, deep diving in female northern elephant seals, *Mirounga angustirostris*. *Canadian Journal of Zoology* 66:446-458.
- Leopold, M. F., J. F. VanElk, and Y. M. VanHeezik. 1996. Central place foraging in Oystercatchers *Haematopus ostralegus*: Can parents that transport Mussels *Mytilus edulis* to their young profit from size selection? *Ardea* 84A:311-325.
- Liebsch, N. 2002. Measurement of feeding and activity in air-breathing marine vertebrates using the Hall effect. Diploma thesis, Christian-Albrechts-University Kiel, Germany. .
- Markman, S., B. Pinshow, J. Wright, and B. P. Kotler. 2004. Food patch use by parent birds: to gather food for themselves or for their chicks? *Journal of Animal Ecology* 73:747-755.
- Maxwell, M., and M. C. Calver. 1998. Bringing home the bacon: Potential energy return from prey and central place foraging in a Willie wagtail *Rhipidura leucophrys*. *Emu* 98:62-65.
- Merrick, R. L., and T. R. Loughlin. 1997. Foraging behavior of adult female and young-of-the-year Steller sea lions in Alaskan waters. *Canadian Journal of Zoology- Revue Canadienne De Zoologie* 75:776-786.
- Mitani, Y., K. Sato, S. Ito, M. F. Cameron, D. B. Siniff, and Y. Naito. 2003. A method for reconstructing three-dimensional dive profiles of marine mammals using geomagnetic intensity data: results from two lactating Weddell seals. *Polar Biology* 26:311-317.
- Modig, A. O. 1996. Effects of body size and harem size on male reproductive behaviour in the southern elephant seal. *Animal Behaviour* 51:1295-1306.
- Mueller, G. 2004. The Foraging Ecology of South American Sea Lions (*Otaria flavescens*) on the Patagonian Shelf. PhD Thesis, Christian-Albrechts-Universitaet zu Kiel, Germany.
- NPA. 1998. Umweltatlas Wattenmeer. Landesamt fuer den Nationalpark Schleswig-Holsteinisches Wattenmeer. Eugen Ulmer GmbH:133.
- Obrecht, H. H., C. J. Pennycuik, and M. R. Fuller. 1988. Wind-Tunnel Experiments to Assess the Effect of Back-Mounted Radio Transmitters on Bird Body Drag. *Journal of Experimental Biology* 135:265-273.
- Orians, G. H., and N. E. Pearson. 1979. On the theory of central place foraging. Pages 155-177 in D. J. Horn, R. Mitchell, and G. R. Stair, eds. *Analysis of Ecological Systems*. Columbus, Ohio State University Press.

- Orthmann, T. 2000. Telemetrische Untersuchungen zur Verbreitung, zum Tauchverhalten und zur Tauchphysiologie von Seehunden (*Phoca vitulina vitulina*) des Schleswig-Holsteinischen Wattenmeeres. PhD Thesis, Christian-Albrechts-Universitaet zu Kiel, Germany.
- Ospar. 2005. <http://www.ospar.org/eng/doc/pdfs/R2C2.pdf>.
- Page, B., J. McKenzie, and S. D. Goldsworthy. 2005. Inter-sexual differences in New Zealand fur seal diving behaviour. *Marine Ecology-Progress Series* 304:249-264.
- Peters, R. H. 1983, The ecological implication of body size. Cambridge, Cambridge University Press.
- Pierce, G. J., and M. B. Santos. 2003. Diet of harbour seals (*Phoca vitulina*) in Mull and Skye (Inner Hebrides, western Scotland). *Journal of the Marine Biological Association of the United Kingdom* 83:647-650.
- Plotz, J., H. Bornemann, R. Knust, A. Schroder, and M. Bester. 2001. Foraging behaviour of Weddell seals, and its ecological implications. *Polar Biology* 24:901-909.
- Ponganis, P. J., G. L. Kooyman, M. H. Zornow, M. A. Castellini, and D. A. Croll. 1990. Cardiac output and stroke volume in swimming harbour seals. *Journal of Comparative Physiology* 160B:473-482.
- Ries, E. H., I. M. Traut, P. Paffen, and P. W. Goedhart. 1997. Giving patterns of harbour seals (*Phoca vitulina*) in the Wadden Sea, the Netherlands and Germany, as indicated by VHF telemetry. *Canadian Journal of Zoology-Revue Canadienne De Zoologie* 75:2063-2068.
- Robin, J. P., C. Fayolle, F. Decrock, M. A. Thil, S. D. Cote, S. Bernard, and R. Groscolas. 2001. Restoration of body mass in King Penguins after egg abandonment at a critical energy depletion stage: early vs late breeders. *Journal of Avian Biology* 32:303-310.
- Robinson, S. A., S. G. Goldsworthy, J. van den Hoff, and M. A. Hindell. 2002. The foraging ecology of two sympatric fur seal species, *Arctocephalus gazella* and *Arctocephalus tropicalis*, at Macquarie Island during the austral summer. *Marine and Freshwater Research* 53:1071-1082.
- Ropert-Coudert, Y., A. Kato, N. Liebsch, R. P. Wilson, G. Muller, and E. Baubert. 2004a. Monitoring jaw movements: a cue to feeding activity. *Game and Wildlife Science* 20:1-19.
- Ropert-Coudert, Y., A. Kato, K. Sato, Y. Naito, J. Baudat, C. A. Bost, and Y. Le Maho. 2002. Swim speed of free-ranging Adelie penguins *Pygoscelis adeliae* and its relation to the maximum depth of dives. *Journal of Avian Biology* 33:94-99.

- Ropert-Coudert, Y., Liebsch, N., Kato, A., Bedford, G., Leroy, M., Wilson, R.P., 2002. Mouth opening in dolphins as revealed by magnetic sensors. *Isana* (in Japanese) 36:72-74.
- Ropert-Coudert, Y., R. P. Wilson, F. Daunt, and A. Kato. 2004b. Patterns of energy acquisition by a central place forager: benefits of alternating short and long foraging trips. *Behavioral Ecology* 15:824-830.
- Samietz, J., and U. Berger. 1997. Evaluation of movement parameters in insects - bias and robustness with regard to resight numbers. *Oecologia* 110:40-49.
- Sato, K., Y. Mitani, M. F. Cameron, D. B. Siniff, and Y. Naito. 2003. Factors affecting stroking patterns and body angle in diving Weddell seals under natural conditions. *Journal of Experimental Biology* 206:1461-1470.
- Schmidt-Nielsen, K. 1995, *Animal Physiology*. Cambridge, Cambridge University Press.
- Schreer, J. F., and K. M. Kovacs. 1997. Allometry of diving capacity in air-breathing vertebrates. *Canadian Journal of Zoology-Revue Canadienne De Zoologie* 75:339-358.
- Schreer, J. F., K. M. Kovacs, and R. J. O. Hines. 2001. Comparative diving patterns of pinnipeds and seabirds. *Ecological Monographs* 71:137-162.
- Schreer, J. F., and J. W. Testa. 1995. Statistical Classification of Diving Behavior. *Marine Mammal Science* 11:85-93.
- Schreer, J. F. , and J. W. Testa. 1996. Classification of Weddell seal diving behavior. *Marine Mammal Science* 12:227-250.
- Simeone, A., and R. P. Wilson. 2003. In-depth studies of Magellanic penguin (*Spheniscus magellanicus*) foraging: can we estimate prey consumption by perturbations in the dive profile? *Marine Biology* 143:825-831.
- Sparling, C. E., and M. A. Fedak. 2004. Metabolic rates of captive grey seals during voluntary diving. *Journal of Experimental Biology* 207:1615-1624.
- Staniland, I. J., and I. L. Boyd. 2003. Variation in the foraging location of Antarctic fur seals (*Arctocephalus gazella*) and the effects on diving behavior. *Marine Mammal Science* 19:331-343.
- Sundstrom, L. F., and S. H. Gruber. 1998. Using speed-sensing transmitters to construct a bioenergetics model for subadult lemon sharks, *Negaprion brevirostris* (Poey), in the field. *Hydrobiologia* 372:241-247.
- Taillade, M. 1992. Animal tracking by satellite. Pages 149-160 in I. M. Priede, and S. M. Swift, eds. *Wildlife Telemetry: Remote monitoring and Tracking of Animals*. Chichester, Ellis Horwood.

- Takahashi, A., Dunn, M.J., Trathan, P.N., Croxall, J.P., Wilson, R.P., Sato, K., Naito, Y., in press (2005). Krill-feeding behaviour in chinstrap penguin compared to fish-eating Magellanic penguins: a pilot study. *Mar. Orn.*
- Thomas, J. A. 2002. Weddell Seal in W. F. Perring, B. Wuersig, and J. G. M. Thewissen, eds. *Encyclopedia of Marine Mammals*. San Diego, Academic Press.
- Thompson, D., C. D. Duck, B. J. McConnell, and J. Garrett. 1998. Foraging behaviour and diet of lactating female southern sea lions (*Otaria flavescens*) in the Falkland Islands. *Journal of Zoology* 246:135-146.
- Thompson, P. M., B. J. McConnell, D. J. Tollit, A. Mackay, C. Hunter, and P. A. Racey. 1996. Comparative distribution, movements and diet of harbour and grey seals from the Moray Firth, NE Scotland. *Journal of Applied Ecology* 33:1572-1584.
- Tollit, D. J., A. D. Black, P. M. Thompson, A. Mackay, H. M. Corpe, B. Wilson, S. M. Van Parijs et al. 1998. Variations in harbour seal *Phoca vitulina* diet and dive-depths in relation to foraging habitat. *Journal of Zoology* 244:209-222.
- Trost, F. 2004. Analyse des Schwimm- und Tauchverhaltens von Seehunden zur Korrektur von Flugzaehlungen auf See. Diploma thesis, Christian-Albrechts-University Kiel, Germany. .
- Viswanathan, G. M., V. Afanasyev, S. V. Buldyrev, E. J. Murphy, P. A. Prince, and H. E. Stanley. 1996. Levy flight search patterns of wandering albatrosses. *Nature* 381:413-415.
- Viswanathan, G. M., S. V. Buldyrev, S. Havlin, M. G. E. da Luz, E. P. Raposo, and H. E. Stanley. 1999. Optimizing the success of random searches. *Nature* 401:911-914.
- Walker, B. G., and P. L. Boveng. 1995. Effects of Time-Depth Recorders on Maternal Foraging and Attendance Behavior of Antarctic Fur Seals (*Arctocephalus gazella*). *Canadian Journal of Zoology-Revue Canadienne De Zoologie* 73:1538-1544.
- Watanabe, Y., E. A. Baranov, K. Sato, Y. Naito, and N. Miyazaki. 2004. Foraging tactics of Baikal seals differ between day and night. *Marine Ecology-Progress Series* 279:283-289.
- Watanabe, Y., H. Bornemann, N. Liebsch, J. Plotz, K. Sato, Y. Naito, and N. Miyazaki. 2006. Seal-mounted cameras detect invertebrate fauna on the underside of an Antarctic ice shelf. *Marine Ecology-Progress Series* 309:297-300.
- Watanabe, Y., Y. Mitani, K. Sato, M. F. Cameron, and Y. Naito. 2003. Dive depths of Weddell seals in relation to vertical prey distribution as estimated by image data. *Marine Ecology-Progress Series* 252:283-288.

- Watanuki, Y., A. Takahashi, F. Daunt, S. Wanless, M. Harris, K. Sato, and Y. Naito. 2005. Regulation of stroke and glide in a foot-propelled avian diver. *Journal of Experimental Biology* 208:2207-2216.
- Waugh, S. M., and H. Weimerskirch. 2003. Environmental heterogeneity and the evolution of foraging behaviour in long ranging greater albatrosses. *Oikos* 103:374-384.
- Werner, R., and C. Campagna. 1995. Diving behaviour of lactating southern sea lions (*Otaria flavescens*) in Patagonia. *Canadian Journal of Zoology-Revue Canadienne De Zoologie* 73:1975-1982.
- Williams, T. M. 2001. Intermittent swimming by mammals: A strategy for increasing energetic efficiency during diving. *American Zoologist* 41:166-176.
- Williams, T. M., R. W. Davis, L. A. Fuiman, J. Francis, B. L. Le Boeuf, M. Horning, J. Calambokidis et al. 2000. Sink or swim: Strategies for cost-efficient diving by marine mammals. *Science* 288:133-136.
- Williams, T. M., L. A. Fuiman, M. Horning, and R. W. Davis. 2004. The cost of foraging by a marine predator, the Weddell seal *Leptonychotes weddellii*: pricing by the stroke. *Journal of Experimental Biology* 207:973-982.
- Wilson, R. P., and B. Culik. 1992. Packages on penguins and device-induced data. Pages 573-580 in I. M. Priede, and S. M. Swift, eds. *Wildlife Telemetry: Remote monitoring and tracking of animals*. Chichester, Ellis Horward.
- Wilson, R. P., B. M. Culik, G. Peters, and R. Bannasch. 1996. Diving behaviour of Gentoo penguins, *Pygoscelis papua*; Factors keeping dive profiles in shape. *Marine Biology* 126:153-162.
- Wilson, R. P., J. A. Kreye, K. Lucke, and H. Urquhart. 2004. Antennae on transmitters on penguins: balancing energy budgets on the high wire. *Journal Of Experimental Biology* 207:2649-2662.
- Wilson, R. P., N. Liebsch, F. Quintana, H. Weimerskirch, S. Storch, K. Lucke, U. Siebert et al. 2005. All at sea with animal tracks; methodological and analytical solutions for the resolution of movement. *Proceedings of the 2. International Bio-Logging Symposium in St. Andrews, June 2005. Deep Sea Research II*.
- Wilson, R. P., K. Puetz, C. A. Bost, B. M. Culik, R. Bannasch, T. Reins, and D. Adelung. 1993. Diel Dive Depth in Penguins in Relation to Diel Vertical Migration of Prey - Whose Dinner by Candlelight. *Marine Ecology-Progress Series* 94:101-104.
- Wilson, R. P., and F. Quintana. 2004. Surface pauses in relation to dive duration in imperial cormorants; how much time for a breather? *Journal Of Experimental Biology* 207:1789-1796.

- Wilson, R. P., J. A. Scolaro, D. Gremillet, M. A. M. Kierspel, S. Laurenti, J. Upton, H. Gallelli et al. 2005b. How do Magellanic Penguins cope with variability in their access to prey? *Ecological Monographs* 75:379-401.
- Wilson, R. P., A. Steinfurth, Y. Ropert-Coudert, A. Kato, and M. Kurita. 2002a. Lip-reading in remote subjects: an attempt to quantify and separate ingestion, breathing and vocalisation in free-living animals using penguins as a model. *Marine Biology* 140:17-27.
- Wilson, R. P., and M. P. Wilson. 1988. Dead Reckoning - a New Technique for Determining Penguin Movements at Sea. *Meeresforschung-Reports on Marine Research* 32:155-158.
- Wilson, S. C., G. J. Pierce, C. M. Higgins, and M. Armstrong. 2002b. Diet of the harbour seals *Phoca vitulina* of Dundrum Bay, north-east Ireland. *Journal of the Marine Biological Association of the United Kingdom* 82:1009-1018.
- Ydenberg, R., and P. Hurd. 1998. Simple models of feeding with time and energy constraints. *Behavioral Ecology* 9:49-53.
- Yoda, K., Y. Naito, K. Sato, A. Takahashi, J. Nishikawa, Y. Ropert-Coudert, M. Kurita et al. 2001. A new technique for monitoring the behaviour of free-ranging Adelie penguins. *Journal Of Experimental Biology* 204:685-690.

**Table 1.** Program schedules and sampling periods of all devices.

<b>animal ID</b>	<b>A</b>	<b>C</b>	<b>Si</b>	<b>Di</b>	<b>P</b>	<b>#8</b>	<b>Sv</b>	<b>T</b>	<b>J</b>	<b># 2.2</b>	<b># 4.1</b>	<b># 7.1</b>	<b># 11</b>
<b>animal species</b>	harbour seal	harbour seal	harbour seal	harbour seal	harbour seal	harbour seal	harbour seal	harbour seal	harbour seal	Weddell seal	Weddell seal	Weddell seal	Weddell seal
<b>date of deployment</b>	17.04.02	12.11.02	12.11.02	09.04.03	09.04.03	17.09.03	13.04.04	18.09.04	18.09.04	18.12.03	13.12.03	17.12.03	30.12.03
<b>timer ID</b>	proto 1	30005	30009	30013	815	3005	-	30034	30016	-	-	-	-
<b>release date</b>	29.04.02	09.01.03	09.01.03	06.06.03	25.06.03	12.11.03	-	21.12.04	21.12.04	-	-	-	--
<b>release time</b>	12:00:00	04:00:00	04:00:00	07:20:00	14:15:00	23:00:00	-	12:00:00	12:00:00	-	-	-	-
<b>dead reckoner ID</b>	116	131	134	135	125	127	376	375	385	166	168	167	165
<b>start date</b>	17.04.02	12.11.02	12.11.02	09.04.03	09.04.03	17.09.03	13.04.04	18.09.04	18.09.04	18.12.03	13.12.03	17.12.03	30.12.03
<b>start time</b>	12:26:00	10:00:00	10:00:00	10:30:00	10:30:00	10:00:00	14:00:00	11:00:00	11:00:00	12:00:00	12:00:00	12:00:00	12:00:00
<b>sampling interval</b>	3 sec	15 sec	15 sec	15 sec	20 sec	15 sec	5 sec	5 sec	5 sec	1 sec	2 sec	1 sec	2 sec
<b>stop date</b>	29.04.02	10.01.03	10.01.03	21.04.03	10.05.03	26.09.03	16.07.04	25.11.04	20.11.04	20.12.03	18.12.03	19.12.03	03.01.04
<b>stop time</b>	06:36:10	04:50:15	04:50:15	00:04:15	05:35:40	18:46:45	15:21:00	01:48:36	04:46:00	13:17:13	19:07:54	20:31:16	20:17:24
<b>sampling duration</b>	10d 12h	58d 16h	23d 1h	9d 9h	24d 7h	9d 2h	94d 1h	67d 13h	62d 18h	2d 1h	5d 1h	2d 8h	3d 17h
<b># of dives</b>	3015	19382	5964	1936	5504	3573	23322	23285	18304	105	130	75	231
<b># of datapoints</b>	338688	338602	132773	66617	105307	53947	1625292	1168430	1084147	176400	217800	201600	160200
<b># of U-dives</b>	2899	18148	5778	1718	4327	3292	21858	20487	18152		415		
<b># of V-dives</b>	117	1235	186	215	1178	282	1457	2795	152		113		
<b>time @ sea</b>	168 h	1223 h	-	-	279 h	-	1540 h	1049 h	988 h	-	-	-	-
<b>IMASEN ID</b>	83	143	-	145	-	113	152	165	169	3976	3080	3075	3075
<b>start date</b>	17.04.02	12.11.02	-	09.04.03	-	17.09.03	13.04.04	18.09.04	18.09.04	18.12.03	13.12.03	17.12.03	30.12.03
<b>start time</b>	11:00:00	10:00:00	-	10:30:00	-	10:00:00	14:00:00	11:00:00	11:00:00	12:00:00	12:00:00	12:00:00	12:00:00
<b>sampling interval</b>	5 Hz	5 Hz	-	5 Hz	-	5 Hz	6 Hz	5 Hz	5 Hz	10 Hz	6 Hz	10 Hz	6 Hz
<b>stop date</b>	-	10.04.03	-	-	-	-	18.04.04	18.09.04	18.09.04	20.12.03	18.12.03	20.12.03	04.01.04
<b>stop time</b>	-	13:45:00	-	-	-	-	17:34:02	12:49:13	14:56:58	08:45:26	18:34:51	11:54:27	06:41:16
<b>sampling duration</b>	no data	33.67 h	-	no data	-	no data	3 d 21 h	1.8 h	4 h	1d 18h	4d 23h	3d 23h	2d 9h
<b>PTT ID</b>	8141	37457	37463	37458	39476	37461	47759	-	-	-	-	-	-
<b>remark</b>	-	-	early release	early release	early release	early release	-	-	-	-	-	-	-

**Table 2.** Dive statistics of Weddell and harbour seals.

		<i>Test</i>	<i>N</i>	<i>F<sub>crit</sub></i>	<i>F-value</i>	<i>P-value</i>
<b>Weddell seal</b>	Depth vs.	<i>gradient</i>	525	3.86	14.71	< 0.001
	descent duration	<i>intercept</i>	526	3.86	44.55	< 0.001
	Depth vs. ascent	<i>gradient</i>	525	3.86	5.44	0.202
	duration	<i>intercept</i>	526	3.86	52.33	< 0.001
	Depth vs. vert.	<i>gradient</i>	525	3.86	2.21	0.138
	vel. desc.	<i>intercept</i>	526	3.86	16.16	< 0.001
<b>Harbour seal</b>	Depth vs. vert.	<i>gradient</i>	525	3.86	0.87	0.351
	vel. asc.	<i>intercept</i>	526	3.86	20.15	< 0.001
	Depth vs.	<i>gradient</i>	40	4.1	0.008	> 0.05
	descent duration	<i>intercept</i>	41	14.4	54.8	< 0.001
	Depth vs. ascent	<i>gradient</i>	40	4.1	2.2	> 0.05
	duration	<i>intercept</i>	41	14.4	47.5	< 0.001
	Depth vs. vert.	<i>gradient</i>	40	4.1	0.8	> 0.05
	vel. desc.	<i>intercept</i>	41	14.4	28.6	< 0.001
	Depth vs. vert.	<i>gradient</i>	40	4.1	14.4	> 0.05
	vel. asc.	<i>intercept</i>	41	14.4	51.8	< 0.001
Depth vs. dive	<i>gradient</i>	40	4.1	3.7	> 0.05	
duration	<i>intercept</i>	41	14.4	192.2	< 0.001	



**Table 3.** Linear regressions ( $y = a + bx$ ) with statistic parameters obtained from STATeasy, for all calculated parameters (duration, maximum angle and integral) versus the measurements obtained from the prey items (weight and length).

<b>Parameter</b>	<b>a</b>	<b>b</b>	<b>F</b>	<b>r</b>	<b>Level of significance</b>
<b>Mass vs. duration</b>	4.12	0.01	1.52	0.16	4.00
<b>Mass vs. angle</b>	19.91	0.08	2.20	0.19	4.00
<b>Mass vs. integral</b>	279.79	3.72	3.38	0.23	4.00
<b>Length vs. duration</b>	2.96	0.10	1.12	0.14	4.00
<b>Length vs. angle</b>	7.94	0.84	2.87	0.21	4.00
<b>Length vs. integral</b>	-280.38	39.36	4.38	0.27	4.00

**Table 4.** List of parameters used in the model.

		<i>harbour seal</i>	<i>Weddell seal</i>	<i>model seal</i>
<b>Maximum depth (m)</b>	= Dp	n/a	n/a	n/a
<b>Dive duration (s)</b>	= Dd	n/a	n/a	n/a
<b>Descent duration (s)</b>	= f1(Dp)	= 0.26(Dp)+28	= 0.71(Dp)+58	= 0.71(Dp)+58
<b>Bottom duration (s)</b>	= f2(Dp)	= 2.70(Dp)+78	= 0.84(Dp)+298	= 0.84(Dp)+298
<b>Ascent duration (s)</b>	= f3(Dp)	= 0.28(Dp)+27	= 0.92(Dp)+64	= 0.92(Dp)+64
<b>Pause duration (s)</b>	= f4(Dd)	n/a	n/a	= 4E-8(Dd^3)-8E-5(Dd^2)+7.7E-2(Dd)+212
<b>Travel speed (m/s)</b>	= v	1.4	n/a	1.4
<b>% time underwater</b>		72	n/a	72
<b>Time at sea (s)</b>	= Ts	392400	43000	variable
<b>Time on land (s)</b>	= Tl	91800	n/a	variable
<b>Commuting duration (s)</b>	= Tc	derived	derived	derived
<b>Duration in search zone (s)</b>	= Tsz	derived	derived	derived
<b>Foraging range (m)</b>	= F	variable	n/a	variable
<b>Number of search dives</b>	= N	derived	n/a	derived

# Acknowledgements

Looking back on the last 4 years, I first of all have to thank Rory Wilson, who has not only guided me through those years, but also provided me with great opportunities for my future and most importantly he and his family have become dear friends.

This work also would not have been possible without Dieter Adelung and his constant cheerful appearance. Special thanks go to Jochen Plötz and Horst Bornemann, with whom I shared a very special, memorable experience – a great trip to Antarctica. I am also very grateful to Mandy Kierspel, Jens-Uwe Voigt, Tanja Rosenberger and Gabi Müller for their enthusiastic support. The help from Ursula Siebert, Kai Abt, Gerd Mörs and the field crews during the various stages of this work was greatly appreciated.

Grateful thanks are also extended to the Leibniz Institute of Marine Science in Kiel, the Alfred-Wegener-Institute in Bremerhaven including the Crew onboard the RV 'Polarstern' during the ANT XXI/2-cruise, the Seehundstation in Friedrichskoog, the University of Wales Swansea, the Forschungs und Technologiezentrum Westküste in Büsum, Driesen und Kern GmbH, Vacuumschmelze in Hanau, the Nationalpark Amt in Tönning and the Amt für Ländliche Räume in Husum.

And last but not least of course my family, who gave me great backing for whatever I came up with.



## Erklärung

Hiermit erkläre ich, das die vorliegende Dissertation nach Inhalt und Form – abgesehen von der Beratung durch meine wissenschaftlichen Lehrer – meine eigene Arbeit ist. Es wurden keine anderen als die angegebenen Hilfsmittel verwendet.

Die Arbeit hat weder ganz noch zum Teil zuvor einer anderen Stelle im Rahmen eines Prüfungsverfahrens vorgelegen.

Swansea, den 26. Mai 2006