

Hydrochory, seed availability and species diversity in riparian landscapes

Dissertation

zur Erlangung des Doktorgrades

der Mathematisch-Naturwissenschaftlichen Fakultät

der Christian-Albrechts-Universität zu Kiel

vorgelegt von

Kati Vogt

Kiel, April 2006

Prodekan: Prof. Dr. Frank Kemken
Referent: Prof. Dr. Klaus Dierßen
Korreferent: Prof. Dr. Kai Jensen
Tag der mündlichen Prüfung: 06.06.2006

Gedruckt mit Genehmigung der Mathematisch-Naturwissenschaftlichen Fakultät der
Christian-Albrechts-Universität zu Kiel.

Contents

Chapter 1	General introduction	1
Chapter 2	Water-borne seed transport and seed deposition during flooding in a small river-valley in Northern Germany (Vogt, K., Rasran, L. & Jensen, K. <i>Flora</i> 199: 377-388)	7
Chapter 3	Temporal variation and species composition of hydrochorous seed transport: environmental factors vs. species traits (Vogt, K., Rasran, L. & Jensen, K. <i>J. Veg. Sci.</i> , in review)	25
Chapter 4	Seed deposition in drift lines: chance or hazard for species establishment? (Vogt, K., Rasran, L. & Jensen, K. <i>Aquat. Bot.</i> , in review)	45
Chapter 5	Seed deposition in drift lines during an extreme flooding event – evidence for hydrochorous dispersal? (Vogt, K., Rasran, L. & Jensen, K. <i>Basic. Appl. Ecol.</i> 7: 422-432)	59
Chapter 6	General conclusions	75
References		77
Summary		87
Zusammenfassung		91
Danksagung		97

Pictures

Plate I (between Chapter 2 and 3)

Picture 1. Aquatic seed trap used for the investigation of water-borne seed transport.

Picture 2. Investigation of laminar seed deposition: sedimentation mats freely exposed to flooding (A) and with exclusion of water-borne seed transport (B; February 2002, before flooding).

Plate II (between Chapter 3 and 4)

Picture 3. Aquatic seed traps exposed at a bridge crossing the Upper Eider River at the study site "Eiderheim" (February 2002).

Picture 4. Seeds sampled in the Upper Eider river using aquatic seed traps in December 2001 (e.g. A: *Alnus glutinosa*, B: *Iris pseudacorus*, C: *Fraxinus excelsior*, D: *Rumex hydrolapathum*, E: *Ranunculus repens*, F: *Angelica sylvestris*).

Plate III (between Chapter 4 and 5)

Picture 5. Summer flood at the Upper Eider River in August 2002.

Picture 6. Seed-rich drift litter at the Upper Eider River in March 2002.

Plate IV (between Chapter 5 and 6)

Picture 7. Drift litter deposited during the heavy Elbe flood in August 2002.

Picture 8. Seedling recruitment at a site affected by flooding of the Middle Elbe River in September 2002.

Plate V (after Summary)

Picture 9. Upper Eider River near Grevenkrug (February 2002).

Picture 10. Moderately grazed fen area in the Upper Eider Valley during flooding in April 2002.

General Introduction

IMPACT OF SEED DISPERSAL ON SPECIES DIVERSITY

Unlike most animal species, plants are sessile organisms and as those they can not actively reach or colonise their habitats. For this reason plants developed adaptations in the course of evolution, which allow to passively spread their diaspores over large distances and thus to reach new habitats. The term “diaspores” includes here all types of vegetative and generative plant units relevant for dispersal. Dispersal processes can be classified and described with respect to the involved dispersal vectors (agencies). The main passive dispersal modes are anemochory (dispersal by wind), zoochory (dispersal by animals) and hydrochory (dispersal by water).

Dispersal is one of the main factors affecting species composition and diversity of local communities. According to the species-pool concept (e.g. Zobel 1997, Zobel et al. 1998), species richness on small spatial scales is determined by the availability of propagules of species, present on the next larger scale (Zobel & Kalamees 2005). The dispersal ability is a crucial factor, determining within- and between-community species mobility (Van der Maarel & Sykes 1993, Van der Maarel 1997). Also, rarity of some plant species is thought to be dependent on their dispersal ability (Ozinga et al. 2005).

Changes in landuse (intensification as well as abandonment) and accompanied changes of site conditions (e.g. eutrophication, drainage) have led to a decrease of the abundance of many plant and animal species in Central Europe during the last 50 to 100 years (e.g. Eriksson et al. 2002). An increasing habitat fragmentation caused a reduced exchange between populations of many species. Especially if natural dispersal vectors do not function any more due to human impact, this can lead to the reduction or even extinction of populations (Settele et al. 1996). Thus, restoration of species diversity should include measures aiming to restore natural dispersal vectors.

In general, dispersal is a stochastic process, and the probability of diaspores to reach a new site for germination and establishment declines with distance (e.g. Portnoy & Willson 1993, Jongejans & Schippers 1999, Nathan & Casagrandi 2004). In contrast to anemochory,

hydrochorous seed dispersal at least in non-tidal ecosystems can be seen as more or less (uni-)directional due to the flow direction of the river. As consequence of hydrochorous seed dispersal seeds of riparian wetland species, which are assumed to be dispersed by water mostly remain within their favoured habitats in the floodplain. Furthermore, rivers as linear structures in the landscape promote dispersal even over hundreds of kilometres (e.g. Danvind & Nilsson 1997). They can function as corridors between otherwise separated habitats in the nowadays fragmented landscape (Johansson et al. 1996), if a sufficient connection between the ecosystems is given (e.g. by regular flooding). The importance of rivers as corridors for past and present propagule dispersal and resulting distribution patterns was proven by studies on the distribution of river corridor plants ("Stromtalpflanzen", e.g. *Gratiola officinalis* L., see Burkhart 2001) and invasive plant species (e.g. *Impatiens glandulifera* Royle, see Pyšek & Prach 1993, Dawson & Holland 1999).

HYDROCHOROUS SEED DISPERSAL

In its broadest sense, hydrochory includes the dispersal of seeds with rain drops (ombrochory), attached to water surface (nautochory) and together with sediments under water (bythisochory; see e.g. Bonn & Poschlod). In the following text the term hydrochory is used for seed dispersal via river water to simplify matters.

Hydrochorous dispersal processes can be divided into different subprocesses starting with the production of seeds (I, see Fig. 1). Then the seeds have to reach the water (II), be transported with it (III) and be deposited at a suitable site (IV). There, the seeds have to germinate (V) and establish and develop into mature plants (VI). During all these steps, the seeds and/or seedlings are exposed to partially severe abiotic and biotic conditions which reduce the number of viable individuals. Thus, the differentiated subprocesses of hydrochory can be seen as ecological filters (see e.g. Middleton 1999).

Early studies to hydrochory dealt besides pure observations (e.g. Guppy 1891, McAtee 1925, Ridley 1930) mainly with seed morphology (e.g. Hildebrand 1873, Ohlendorf 1907, Ulbrich 1928). In these studies, morphological adaptations leading to increased seed buoyancy (e.g. water-proofed cuticulae or air-filled tissues) had been assumed to be prerequisites for hydrochorous seed dispersal. In the following, seed buoyancy of different plants was tested experimentally (e.g. Guppy 1906, Praeger 1913, Romell 1938, but see also Andersson et al. 2000a) and the ability of tested species to hydrochorous dispersal was concluded out of the results of these experiments. Nowadays, the results of buoyancy tests should be seen critically, as data mostly gathered in the laboratory can not adequately reproduce natural conditions in the river (perturbation, predation by aquatic organisms).

Additionally, even seeds with a low buoyancy can be transported with running water attached to plant litter (see e.g. Andersson et al. 2000a). Indirect studies on hydrochorous seed dispersal were carried out by analysing the species composition of riparian vegetation (Nilsson et al. 1994, Prach et al. 1996, Mitsch et al. 1998). In the recent years evidence for hydrochorous dispersal was also obtained by genetic methods (e.g. Kudoh & Whigham 2001, Lundqvist & Andersson 2001).

The direct process of waterborne seed transport was first analysed via seed traps by Ryvarden (1971) in a small alpine river in Norway. Since that, further studies in different river systems were carried out (channelised lowland stream: Boedeltje et al. 2003, 2004; plugged river channel: Cellot et al. 1998; rapid-flowing mountain stream: Bill et al. 1999, Merritt & Wohl 2006; small boreal rivers: Andersson & Nilsson 2002; small lowland river: Staniforth & Cavers 1976; swamp forest: Schneider & Sharitz 1988, Middleton 1995, 2000; tropical floodplain forest: Kubitzki & Ziburski 1994). Most of these studies have shown high species diversity of transported seeds and, as far as the studies took place over longer time periods, also a large temporal fluctuation of seed transport. The exact mechanisms, causing these fluctuations are still poorly studied. Hydrological processes as well as the phenology of species are supposed to be of relevance.

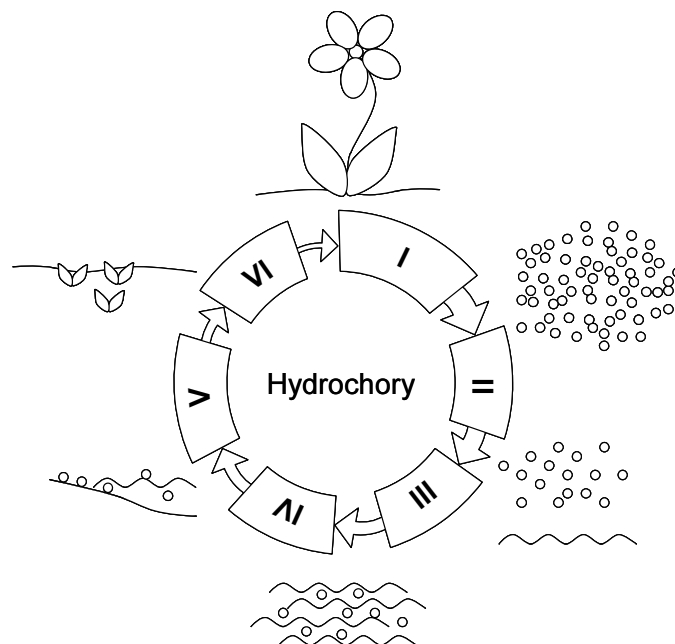

Figure 1. Processes of hydrochory: I. Seed release, II. Entering the water, III. Transport with running water, IV. Seed deposition at a safe site, V. Germination and VI. Establishment.

As another subprocess of hydrochory the deposition of seeds has also repeatedly been analysed. Both studies of seed deposition with mineral sediments (e.g. Dierschke 1984,

Schwabe 1991, Brandes 1999, Goodson et al. 2003) and investigations of deposition with drift litter (McAtee 1925, Stopp 1956, Nilsson & Grelsson 1990, Katenhusen 2001, Neff & Baldwin 2005) have been applied. The direct effect of seeds deposited together with sediments and drift line material on vegetation composition and species abundance was analysed by e.g. Schwabe (1991) and Leck & Simpson (1993) for sediments and by Nilsson & Grelsson (1990) and Xiong & Nilsson (1997) for drift lines. Further studies on the impact of drift line material on species diversity are rare and mostly face negative consequences of litter accumulation on e.g. light availability for plant species (e.g. Nilsson et al. 1999, Xiong et al. 2001). The potential role of drift litter as seed source has often been neglected.

The growing awareness for (negative) effects of invasive plant species on native vegetation, and the fact that many of these species were observed first along larger rivers has stimulated further investigations on hydrochorous seed dispersal (e.g. Planty-Tabacchi et al. 2001, Renöfält et al. 2005). During the last years, studies on hydrochory focussed more and more on its value for restoration of aquatic and semi-terrestrial habitats. This can be seen in connection with management projects aiming the restoration of species diversity (e.g. Berendse et al. 1992 for wet meadows, Grootjans et al. 1993 for small stream valleys, Härdtle et al. 2006 for floodplain grasslands). Such projects focussed mainly on the improvement of site conditions and did not always consider the obstacle of seed limitation for restoration success (but see Mitsch et al. 1998).

A further aspect of studying hydrochory is the impact of extreme flooding events on vegetation along river systems. Large floods, which have increased in number, frequency and extant during the last decades in Central Europe (e.g. Rhine River 1995, Oder River 1997, Danube River 2002, Elbe River 2002), raised the attention of both public and the scientific community on consequences of such events. The importance of natural or semi-natural floodplains for water retention to avoid further catastrophes became more and more obvious. After long years of river regulation (e.g. dyking, excavation of the river bed, river straightening) this change in peoples way of thinking could be a chance for the restoration of riparian landscapes.

OUTLINE OF THE THESIS

The aim of the present thesis was to study hydrochorous seed dispersal including its main subprocesses and their relevance for species diversity and restoration in riparian landscapes. Most studies were carried out in the Upper Eider Valley, a small river valley in the weichselian landscape of Northern Germany. It is dominated by species poor eutrophic fen- and forage-grasslands (Jensen et al. 2001). The flowing regime of the river Eider has

been strongly transformed due to river management (e.g. drainage, flow and flooding regulation) during the last decades. Since 1999 a restoration project is carried out in the river valley. This project aims on the one hand to increase nutrient retention in the fens via rewetting (e.g. ditch-clogging) and on the other hand to increase species diversity in the surrounding landscape via the establishment of large-scale moderate cattle grazing. As consequences of this project, flooding events are expected to increase in frequency and extant and site conditions for rare and regionally endangered species of fen grassland communities will hopefully be improved in the future. Thus, hydrochorous seed dispersal is supposed to become a more important dispersal mode in the river valley: The assumed larger extension of floods increases the area, which can potentially be reached by drifted seeds and improved site conditions lead to a higher number of "safe sites" for successful establishment of these riparian wetland species.

Additionally to the investigations in the Upper Eider Valley the impact of hydrochorous seed dispersal was studied following an extreme flooding event at the Middle Elbe River in Central Germany in September 2002. Compared to other large rivers in Central Europe, the Middle Elbe is less regulated even though approx. 80% of the floodplains of the river are affected by dyking and weirs. Due to dyke breaches occurring during the heavy flood, parts of the fossil flood plain were reactivated and thus involved in seed exchange via hydrochory.

The single studies included in this thesis focussed mainly on seed transport, seed deposition, germination and establishment of hydrochorous dispersed seeds.

In chapter two methods for studying seed transport in the river (aquatic seed traps) and for studying seed deposition with sediments (sedimentation mats) are presented. Trapping ability of the used aquatic seed traps was tested by a re-capture experiment with marked seeds. The sedimentation mats were used to analyse the laminar deposition of seeds together with alluvial sediments within riparian floodplains.

Chapter three contains the results of a two-year study of riparian seed transport in the Upper Eider). This study focussed on the quality, quantity and temporal variation of seed transport in relation to abiotic conditions (e.g. mean discharge of the river) and riparian vegetation. Furthermore, water transported species were compared with the local species pool with respect to different species traits (e.g. seed buoyancy, species phenology, Ellenberg Moisture Values), to detect prerequisites for the ability to hydrochorous seed dispersal.

In chapter four seed deposition with drift litter and its impact on species diversity was studied in the Upper Eider Valley. The function of drift lines in the landscape was investigated both regarding their role as source for viable seeds and their role as seed sink due to unfavourable site conditions in drift litter. Furthermore, the importance of increased

seed availability by applying drift litter and effects of microsite availability on species diversity were analysed in a two-factorial field experiment.

In chapter five seed content of drift litter deposited during an extreme flooding event was analysed for studying hydrochory at the Middle Elbe River in September 2002. For that purpose drift line samples of different habitats were collected at five locations along a transect of about 400 river-kilometres. Species composition and diversity of drift litter material and of floodplain vegetation was compared and conclusions about the influence of extreme floods on the seed exchange between habitats and locations in the floodplain were drawn.

Water-borne seed transport and seed deposition during flooding in a small river-valley in Northern Germany

Methods for studying hydrochory

INTRODUCTION

Although hydrochory is an important dispersal vector especially for species occurring in temporally flooded habitats, surprisingly little attention has been given to this dispersal process in comparison to e.g. anemochory and zoochory. So far hydrochorous dispersal processes have been analysed only exemplarily in a few rivers in different geographical regions and climatic zones (e.g. Kubitzki & Ziburski 1994, tropical flood plain forests of Amazonia; Bill et al. 1999, clear water stream in an alpine region; Andersson & Nilsson 2002, boreal river in N-Sweden; Boedeltje et al. 2003, small lowland river).

Hydrochory can either be analysed by direct sampling of the water body (Ryvarden 1971, Staniforth & Cavers 1976, Schneider & Sharitz 1988, Huiskes et al. 1995, Middleton 1995, Bill et al. 1999, Katenhusen 2001, Andersson & Nilsson 2002) or by examining the seed content of drift litter material or riverbank sediments after floods (Dierschke 1984, Nilsson & Grelsson 1990, Skoglund 1990, Schwabe 1991, Kleinschmidt & Rosenthal 1995, Brandes 1999, Katenhusen 2001).

In spite of the work performed until now, there are still many open questions concerning the individual processes of hydrochory (reaching of the water body by the seeds, water-borne seed transport, deposition at a suitable micro-site, germination and establishment; see Staniforth & Cavers 1976). In addition long-term dynamics of water-borne seed transport has hardly been examined so far (but see: Middleton 2000, Andersson & Nilsson 2002). Both long-term studies and investigations of the abovementioned different processes of hydrochory require well-suited sampling devices. One single seed trap type might not be suitable for studying hydrochory in watercourses differing in velocity conditions, sediment

loads or current flows. Thus, aquatic seed traps have to be adopted to the abiotic conditions of the studied river.

We analysed traps described in the literature (Staniforth & Cavers 1976, Schneider & Sharitz 1988, Huiskes et al. 1995, Middleton 1995) and constructed an aquatic seed trap which should be able to deal with the conditions of nutrient-rich small lowland rivers. We tested this trap type by using it over a period of 20 weeks in the river Eider in Northern Germany. Furthermore, we carried out a recapture experiment with colour-marked *Helianthus* seeds in order to quantify the capture rate of the used seed traps.

Beside the transport of seeds in the water body their sedimentation during floods is essential for the establishment of individuals and populations. While the deposition of seeds in drift lines (which accumulate during floods) has been investigated by several authors (see references above), almost no information is available on the area-related seed deposition during flooding. However, this form of seed deposition might be of greater ecological significance than seed accumulation in drift lines as requirements for germination and establishment (especially of small-seeded wet grassland species) are hardly met beneath large litter (drift-line) layers (see e.g. Jensen & Gutekunst 2003). We investigated seed sedimentation during flooding by excluding experimentally the water-borne seed transport from some flooded areas and studying seed sedimentation within and outside of these exclosures.

Our study aims in answering the following specific questions:

- Are the used aquatic seed traps suited for studying hydrochory in small and nutrient-rich lowland rivers and which percentage of dispersed seeds is trapped by them?
- How many seeds of which species are transported in the river Eider and how does the seed transport vary temporally and spatially?
- How many seeds of which species are deposited during flooding and where do the deposited seeds come from?

METHODS

Study site

The study was conducted in the Upper Eider, a river in Northern Germany with a catchment area of 135 km² upstream to the study site. The river has strongly been influenced by human activities like river regulation, drainage, mowing of the macrophytes each year in summer and mowing and/or grazing of the adjacent fen grasslands. In the study area the river is approx. 8 m broad with a mean discharge of 1.51 m³/s. Flooding of the adjacent fen grasslands frequently occurs during the winter months and sometimes also in summer. Due to rewetting measures in the river valley (e.g. clogging of ditches, abandonment of macrophyte mowing) flooding events are expected to increase in frequency in the future.

Seed transport in the river

Sampling device: design and construction

The aquatic seed traps were constructed by using a plastic ring (16 cm diameter, 5 cm deep), a plastic tube (7 cm diameter, 10 cm long), a funnel-like and a cap-like cloth. All components of the trap were attached to each other with the help of metallic clips or cable ties as shown in Fig. 1 A. The funnel-like cloth (Fig. 1 B) and the outer part of the cap-like cloth (Fig. 1 C) were made up of synthetic fibre gauze with a mesh size of 0.4 mm, while the inner part (Fig. C) consisted of gauze with a mesh size of 0.1 mm. All cloth components were sewn by using a sewing machine. After assembling, the several parts of the construction were additionally fixed with claimable elastic bands.

The traps were exposed at a bridge crossing the river. Two ropes mounted on the plastic rings were used to tie the traps to the bridge. Alternatively the traps can be fixed to bars in the riverbed or on a rope spanned across the river. Based on the assumption that the main proportion of seeds is dispersed adhering to the water surface (Staniforth & Cavers 1976, Bill et al. 1999), the best trapping position of the sampling devices in water is reached, if the diameter of the plastic ring coincides with the water surface. The traps usually do not need additional floating devices to reach their optimal position in water due to the buoyancy of the used materials and the current velocity of the river. Only generative dispersules of vascular plants were studied. We used the term “seed” in a broader sense and synonymous to “dispersule” including seeds and different forms of fruits.

Analysing spatial and temporal variation of water-born seed transport

Four aquatic seed traps (t1 – t4) were exposed from a bridge across the river Eider [54°13'03''N, 10°02'08''E] in July 2000. To analyse the spatial variation of the water-borne

seed transport, the traps were equally arranged across the river profile (Fig. 2). Once a week the accumulated material in the traps was collected by removing the funnel-like cloth (completely with tube and cap-like cloth). Trapping took place over a period of 20 weeks until December of the same year.

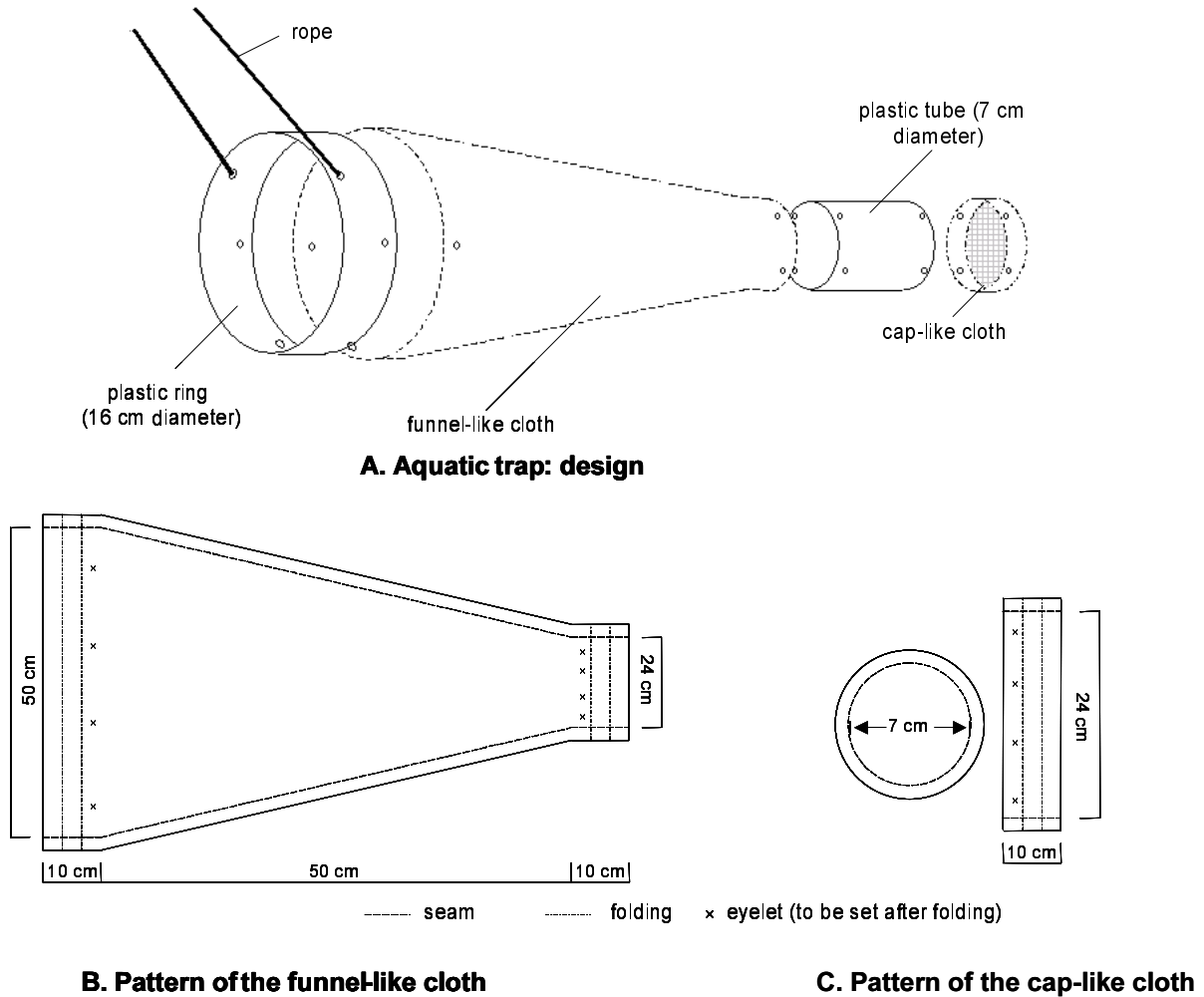

Figure 1. Aquatic seed trap designed for capturing seeds floating in running water. A. Design of the whole trap, B. Detailed pattern of the funnel-like cloth, C. Detailed pattern of the cap-like cloth.

The traps were rinsed and the trapped material was retained and filtered using a filter with a mesh size of 0.1 mm. After drying, the material was scanned for seeds under a stereolens. The species determination of seeds followed Bertsch (1941), Brouwer & Stählin (1955), Heinisch (1955), Kiffmann (1960), Nilsson & Hjelmquist (1967), Berggren (1969, 1981), Schoch et al. (1988), Hanf (1990) and Anderberg (1994). Furthermore, a seed collection was used for species determination. The nomenclature of species follows Wisskirchen & Haeupler (1998).

This investigation was carried out within the context of a more comprehensive research project, which includes seed sampling using aquatic seed traps during a period of two years. The viability of half of the sampled seeds which were trapped in the second year of this period was tested. The thus obtained data was compared with species composition of the vegetation along the riverbanks two kilometres upstream the site where the traps have been installed. These data will be published elsewhere in the nearby future.

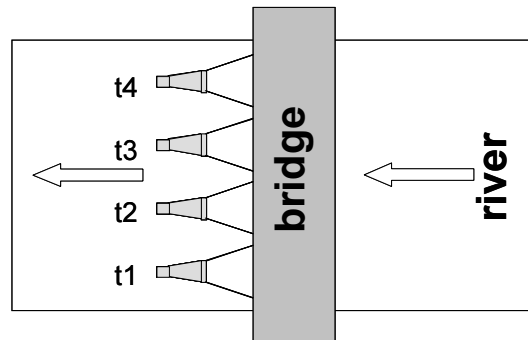

Figure 2. Spatial allocation of the aquatic seed traps (t1, t2, t3, t4) across the profile of the river Eider. The breadth of the river at the study site is about 8 m. The arrows indicate the direction of water flow.

Recapture experiment, capture rate and riverine seed transport

Colour-marked seeds of the sunflower (*Helianthus annuus* L.) were used to analyse the actual capture rate (ACR) of the traps. 100,000 seeds (about 7 kg) were marked with five different colours by using aerosols. Prior to the experiment, all seeds were kept in a compartment drier for three hours at 80 °C to prevent later germination in the field.

To test the buoyancy of marked (coloured) and unmarked (non-coloured) seeds we put 50 seeds each into six glasses filled with 80 ml of purified water. One half of the glasses was kept on a shaker at 175 rpm to simulate current conditions in a river, while the other half was kept motionless. All seeds (of $n = 50$) which were still floating after 24 and 48 hours were counted.

To analyse how the length of exposition influences the actual capture rate of the traps, two traps (t1, t2, Fig. 2) were exposed on 6th December 2002 and two others (t3, t4) four days later on the 10th December from a bridge across the Eider. On the same day (10th December) five different coloured seed batches (20,000 each) of *Helianthus annuus* were released in the river at 50 m, 500 m, 2.5 km, 5 km and 12 km upstream the bridge where the traps were exposed. Three days later all traps were collected and their contents were searched for marked *Helianthus* seeds.

ACR per trap was calculated as the percentage of trapped *Helianthus* seeds in relation to the number of seeds which had been released 50 m upstream of the bridge at which the traps

were exposed. Presuming a spatially even distribution of transported seeds at the water surface the hypothetical capture rate of each single trap is supposed to be 2 %, as one trap (diameter: 16 cm) samples 2 % of the whole river breadth (8 m).

We estimated the rivers seed transport (RST) by calculating the total number of seeds passing the study site in one week as $RST = (MS \times 100) / ACR$ where MS is the mean number of captured seeds per trap and week and ACR is the actual capture rate. The calculation of RST is based on the assumption that the ratio of the mean number of recaptured *Helianthus* seeds per trap to the number of released seeds (recapture experiment) is equal to the ratio of the mean number of captured seeds per trap and week to the total amount of transported seeds per week in the 20 weeks investigation of water-borne seed dispersal.

Sedimentation of seeds during flooding events

To analyse seed-sedimentation during flooding we used 40 x 60 cm sized PVC-mats with 2 cm high bristles on the surface. This mat-type was formerly used by Schwartz et al. (1997) to investigate the sediment deposition during floods in the floodplains of the river Elbe. In order to close punched out holes in the mats, they were glued to a foil.

In February 2002 (short time before the fen grasslands were flooded), 20 of these mats were fixed to the soil surface with nails (diameter: 0.5 cm, length: 20 cm) on a moderately grazed grassland near the river Eider. 10 mats were situated inside of 4 m² sized exclosures fenced by a woven fabric of 50 cm height which was permeable for water but not for floating seeds. The bottom of the woven fabric was buried 5 cm deep in the ground. The other 10 mats were exposed outside (Fig. 3) the exclosures.

After a flooding period of about 22 days the mats were transferred to the laboratory and the deposited material was washed out and laid out in a thin layer (approx. 0.5 cm) above commercial garden soil (type TKS 2, FloragardTM) in plastic trays which were exposed in a greenhouse. The samples were watered regularly and all occurring seedlings were determined, counted and removed during a period of 10 month.

Statistical Analyses

Spatial variation in seed transport was analysed by calculating the percentage of trapped seeds per week for each single trap. We used ANOVA procedures followed by Tukeys HSD post-hoc tests to look for significant differences in the percentage of trapped seeds per week between the four aquatic traps. The 20 sampling dates (weeks) were treated as replicates.

ANOVA procedures were also used to analyse the effects of seed colouring and water movement on the buoyancy of *Helianthus* seeds.

Differences in the number of deposited seeds and species between the two treatments of the sedimentation experiment (with and without hydrochory exclusion) were tested by Mann-Whitney U-tests, as the assumptions for parametric statistics were violated even after data transformation.

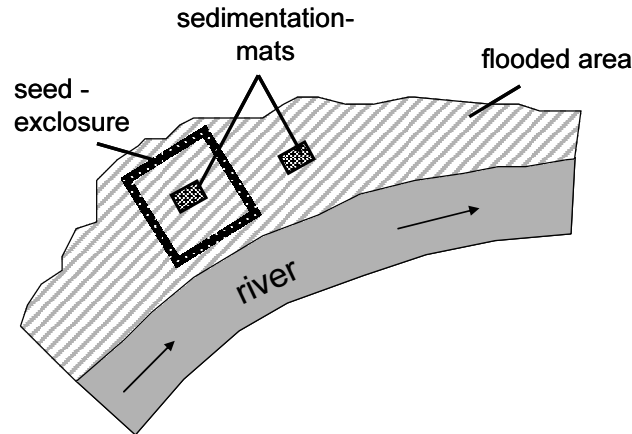

Figure 3. Outline of the design of the sedimentation experiment. 20 sedimentation mats were fixed to the soil surface shortly before flooding occurred nearby the river Eider. Water-borne seed transport by flooding water was excluded from one half of the mats by fencing them with a woven fabric which was permeable for water but not for floating seeds.

As seed weight is an important trait affecting different aspects of the regeneration niche of grassland species (seed bank, requirements for germination and establishment, see Leishman et al. 2000), the frequency distribution of seed weights was used to compare species composition of the water-borne seed transport and seed sedimentation during flooding. All occurring species were assigned to seed weight classes according to Grime et al. (1988) and own (unpublished) data. Differences in the frequency distribution of seed weight classes between the water-borne seed transport and seed deposition during flooding were tested by a Mann-Whitney U-test. The pc-package Statistica (Statsoft 1998) was used for all statistical analyses.

RESULTS

Seed transport in the river

Species composition and temporal and spatial variation in water-borne seed transport

Altogether 9008 seeds of 66 species and nine further taxa (which could not be determined to species level), were trapped during the sampling period of 20 weeks (Tab. 1).

Table 1. Taxa found in the Upper Eider river using four aquatic seed traps during a sampling period of 20 weeks (July to December 2000, sampling on a weekly basis), number and percentage of seeds (in relation to the total number trapped seeds) and the frequency of appearance during the sampling period (number of weeks in which a species appeared).

Species	Number of seeds	Percentage	Frequency
<i>Acer platanoides</i> L.	7	0.08	1
<i>Acer pseudoplatanus</i> L.	6	0.07	1
<i>Achillea millefolium</i> L.	1	0.01	1
<i>Aegopodium podagraria</i> L.	1	0.01	1
<i>Agrostis stolonifera</i> agg.	1	0.01	1
<i>Alnus glutinosa</i> (L.) P. Gaertn.	5013	55.65	19
<i>Alopecurus geniculatus</i> L.	2	0.02	2
<i>Alopecurus pratensis</i> L.	4	0.04	3
<i>Angelica sylvestris</i> L.	8	0.09	3
<i>Barbarea vulgaris</i> R. Br.	6	0.07	4
<i>Berula erecta</i> (Huds.) Coville	14	0.16	3
<i>Betula pubescens</i> Ehrh. s. l.	266	2.95	16
<i>Bidens cernua</i> L.	3	0.03	3
<i>Bidens tripartita</i> L.	3	0.03	3
<i>Calamagrostis canescens</i> (Weber) Roth	23	0.26	9
<i>Caltha palustris</i> L.	4	0.04	1
<i>Capsella bursa-pastoris</i> (L.) Med.	1	0.01	1
<i>Carex acutiformis</i> Ehrh.	21	0.23	9
<i>Carex cespitosa</i> L.	2	0.02	2
<i>Carex paniculata</i> L.	131	1.45	16
<i>Carex pseudocyperus</i> L.	2	0.02	2
<i>Carex rostrata</i> Stokes	1	0.01	1
<i>Carpinus betulus</i> L.	3	0.03	2
<i>Cerastium holosteoides</i> Fr.	1	0.01	1
<i>Cicuta virosa</i> L.	2	0.02	1
<i>Cirsium palustre</i> (L.) Scop.	6	0.07	2
<i>Cirsium vulgare</i> (Savi.) Ten.	4	0.04	2
<i>Crataegus monogyna</i> Jack. s. l.	2	0.02	1
<i>Dactylis glomerata</i> agg.	1	0.01	1
<i>Eupatorium cannabinum</i> L.	8	0.09	3
<i>Fagus sylvatica</i> L.	1	0.01	1
<i>Festuca pratensis</i> Huds. s. l.	2	0.02	1
<i>Filipendula ulmaria</i> (L.) Maxim.	61	0.68	11
<i>Galeopsis tetrahit</i> agg.	3	0.03	3
<i>Galinsoga parviflora</i> Cav.	1	0.01	1
<i>Galium aparine</i> agg.	9	0.1	5
<i>Glyceria maxima</i> (Hartm.) Holmb.	8	0.09	4
<i>Holcus lanatus</i> L.	4	0.04	3
<i>Iris pseudacorus</i> L.	10	0.11	6
<i>Lapsana communis</i> L.	1	0.01	1
<i>Lycopus europaeus</i> L.	133	1.48	7
<i>Mentha aquatica</i> L.	1	0.01	1
<i>Menyanthes trifoliata</i> L.	2	0.02	1
<i>Myosotis scorpioides</i> agg.	1	0.01	1
<i>Persicaria hydropiper</i> (L.) Delarb.	9	0.1	4
<i>Phalaris arundinacea</i> L.	616	6.84	20
<i>Phleum pratense</i> agg.	1	0.01	1
<i>Phragmites australis</i> (Cav.) Trin. ex Steud.	240	2.66	4
<i>Picea abies</i> (L.) H. Karst.	5	0.06	3

<i>Poa pratensis</i> agg.	1	0.01	1
<i>Potentilla palustris</i> (L.) Scop.	1	0.01	1
<i>Prunella vulgaris</i> L.	1	0.01	1
<i>Prunus avium</i> L.	1	0.01	1
<i>Quercus robur</i> L.	1	0.01	1
<i>Ranunculus repens</i> L.	25	0.28	9
<i>Ranunculus sceleratus</i> L.	57	0.63	13
<i>Rorippa palustris</i> (L.) Besser	1	0.01	1
<i>Rumex hydrolapathum</i> Huds.	50	0.56	9
<i>Sambucus nigra</i> L.	19	0.21	5
<i>Scirpus sylvaticus</i> L.	3	0.03	3
<i>Scutellaria galericulata</i> L.	4	0.04	3
<i>Stachys palustris</i> L.	1	0.01	1
<i>Silene flos-cuculi</i> (L.) Clairv.	1	0.01	1
<i>Urtica dioica</i> L. s. l.	1749	19.42	18
<i>Valeriana officinalis</i> agg.	9	0.1	5
<i>Veronica hederifolia</i> agg.	1	0.01	1
<i>Atriplex patula</i> vel <i>prostrata</i>	8	0.09	2
<i>Carex</i> spec.	10	0.11	6
<i>Epilobium</i> spec.	228	2.53	9
<i>Juncus</i> spec.	1	0.01	1
<i>Rubus</i> spec.	3	0.03	3
<i>Rumex obtusifolius</i> vel <i>crispus</i>	128	1.42	13
Caryophyllaceae	2	0.02	1
Fabaceae	1	0.01	1
Poaceae	2	0.02	2
unknown	45	0.5	12
Total no. of seeds	9008	100	

Common species occurring also in the vegetation of the river bank (*Alnus glutinosa*, *Urtica dioica*, *Phalaris arundinacea*) dominated the water-borne seed transport. However, we trapped also seeds of common (e.g. *Filipendula ulmaria*, *Silene flos-cuculi*, *Cirsium palustre*) and regionally endangered (*Menyanthes trifoliata* and *Carex cespitosa*) fen-grassland species although only in low quantities.

The mean number of captured seeds per week and trap (MS) was 115.5 ± 44.4 (standard error). We found significant spatial variation in the percentage of trapped seeds between the four traps ($p < 0.001$, $F = 7.04$). The highest number of seeds was found in trap 3. A Tukeys HSD post hoc-test revealed significant differences between trap 2 and trap 4 ($p < 0.01$) as well as between trap 3 and trap 4 ($p < 0.01$, Fig. 4).

We found a high temporal variation in the number of trapped seeds. While the seed content in the river was rather low (approx. 12 seeds per trap and week) during the first 12 weeks (July – start of October) it increased sharply during the following weeks (more than 1000 seeds per trap and week, Fig. 5).

The number of seeds was especially high at the beginning of August and November as well as at the end of November.

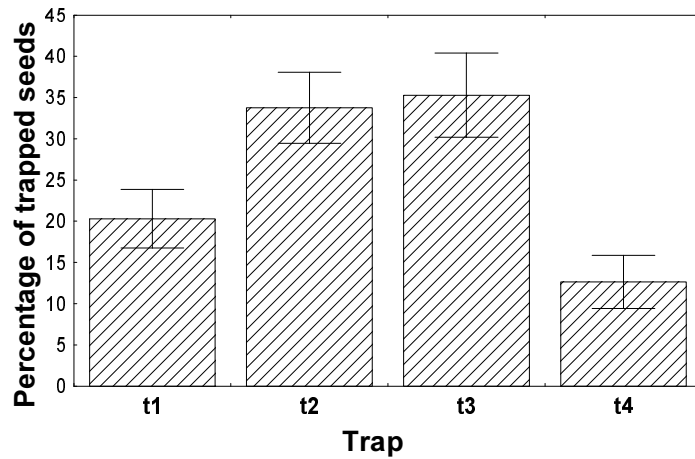

Figure 4. Spatial variation in water-borne seed transport across the river profile. The percentage of captured seeds per trap and week is presented. The entire number of seeds found in all four traps during one week was summed up (100 %) and the proportion of each trap was calculated. The 20 weeks of sampling were treated as replicates. Mean and standard error is shown.

Recapture experiment, capture rate and riverine seed transport

Seed buoyancy:

After 24 hrs more than 40 of 50 seeds were still swimming at the water surface under unmoved conditions while a mean of 7 (unmarked) and 17 (marked) of 50 seeds swam still at the water surface under moved conditions (Tab. 2). After 48 hrs, about 30 of 50 seeds were still buoyant under unmoved conditions but only 0 to 3 seeds under moved conditions (Tab. 2). The floating ability of the seeds was significantly higher under unmoved than under moved conditions ($F = 248.1$, $p < 0.001$ for 24 hrs, $F = 273.0$, $p < 0.001$ for 48 hrs).

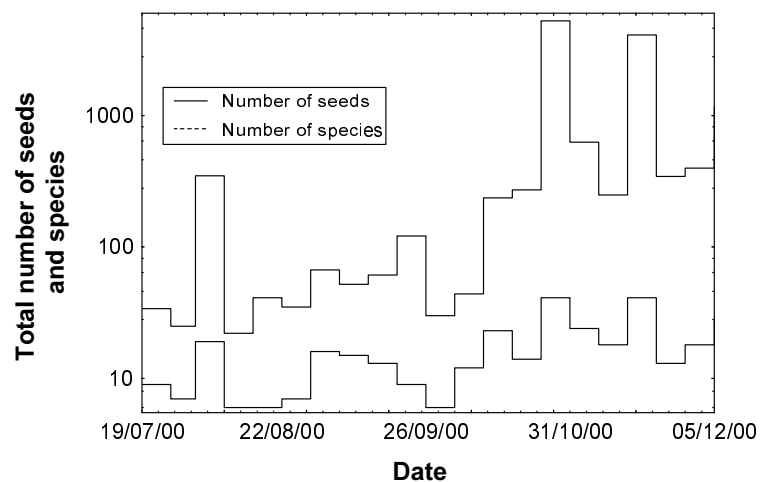

Figure 5. Temporal variation of the number of trapped seeds and species during a period of 20 weeks from mid of July 2000 until the start of December 2000. Four aquatic seed traps were exposed from a bridge across the river Eider and their seed content was analysed weekly.

Seed colouring had no effect on the buoyancy of the *Helianthus* seeds after 48 hrs, whereas seed buoyancy of marked seeds under moved conditions after 24 hrs was significantly higher than those of the unmarked seeds ($F = 5.7$, $p < 0.05$). The results of the buoyancy test showed that colour marking did not decrease the floating ability of the *Helianthus* seeds. Thus, the marked seeds could be used for the recapture experiment.

Table 2. Effects of seed-colouring and water movement on the buoyancy of *Helianthus* seeds. The number of seeds still swimming after 24 and 48 hrs is presented ($n = 50$, means and standard deviations of 3 replicates).

	24 h		48 h	
	unmoved	moved	unmoved	moved
unmarked	$\mu = 45.0$ ± 3.0	$\mu = 6.7$ ± 2.5	$\mu = 30.3$ ± 4.0	$\mu = 0.3$ ± 0.6
marked	$\mu = 44.3$ ± 3.8	$\mu = 16.7$ ± 4.0	$\mu = 33.3$ ± 4.7	$\mu = 3.0$ ± 1.0

Recapture:

Altogether 546 marked seeds were recaptured. This was 0.55 % of the total number of 100,000 marked *Helianthus* seeds. In traps 1 and 2, (exposed four days before *Helianthus*-seeds were released in the river), 0.02 % of the seeds were recaptured. In traps 3 and 4, however, (exposed for one day prior to seed release) 0.53 % of the seeds (27 times more than in traps 1 and 2) were found. The majority of the seeds (528) occurred in trap 3 (Fig. 6).

The number of recaptured *Helianthus* seeds decreased exponentially with increasing distance (Fig. 7). Thus, the percentage of recaptured seeds which were dispersed over a distance of 50 m was higher than the percentage of the total number of recaptured seeds of all other analysed distances.

Actual capture rate and riverine seed transport

369 seeds i.e. 1.85 % of the 20,000 marked seeds which had been released at a distance of 50 m were recaptured. The mean number of recaptured seeds per trap was 92.25. The calculated actual capture rate (ACR) of 0.46 % per trap was much lower than the expected hypothetical capture rate of 2 % per trap.

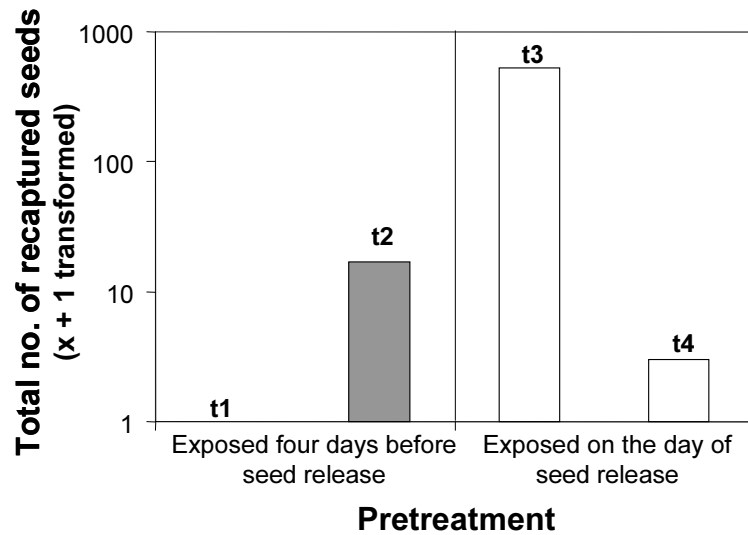

Figure 6. Results of the recapture experiment: Total number of coloured marked *Helianthus* seeds (released at 50, 500, 2500, 5000 and 12000 m upstream of the site where the seed traps were exposed) trapped in the aquatic seed traps t1 and t2 (exposed four days before seed release) and t3 and t4 (exposed one day before seed release). The number of released marked *Helianthus* seeds per distance was 20,000, the total number of released seeds was 100,000.

However, we found a high spatial variation in ACR between the individual traps. No marked *Helianthus*-seeds dispersed from 50 m upstream were found in traps 1 and 4 (ACR: 0 %) whereas seven seeds were captured in trap 2 (ACR: 0.04 %) and 362 marked seeds in trap 3. Thus at least the ACR of trap 3 (1.8 %) almost reached the hypothetical capture rate of 2 %.

The rivers' seed transport calculated as the total number of seeds passing the study site in one week (RST) was 25109.

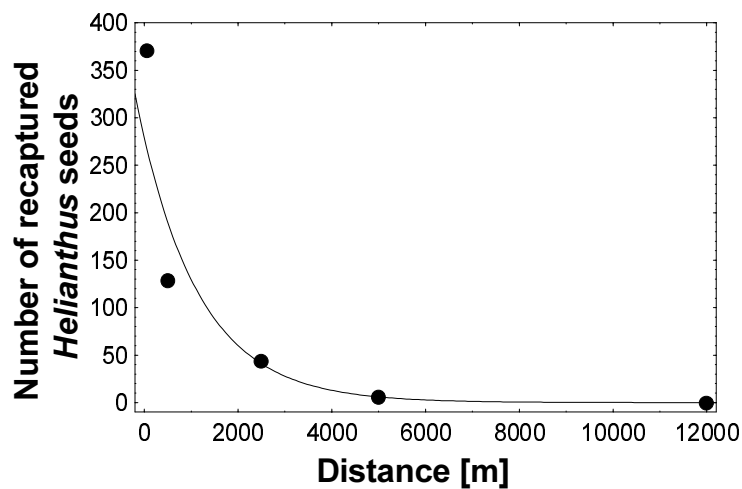

Figure 7. Results of the recapture experiment: Total number of captured coloured marked *Helianthus*-seeds per distance (50, 500, 2500, 5000 and 12000 m). The number of released marked *Helianthus* seeds per distance was 20,000, the total number of released seeds was 100,000.

Sedimentation experiment

Altogether 153 seedlings of 26 species emerged from the sedimentation mats (Tab. 3). Only one seedling was found in samples of mats inside the enclosures.

Table 3. Seedlings germinated from material adhered to 20 sedimentation mats (Schwartz et al. 1997) used to investigate the seed deposition during a winter flood in the Upper Eider Valley in February 2002. Ten of the mats were excluded from riverine seed transport using enclosures made of a woven fabric. The only seedling germinated within an enclosure is marked with an asterisk (*).

Species	No. of seedlings	Percentage
<i>Agrostis stolonifera</i> agg.	1	0.65
<i>Alnus glutinosa</i> (L.) P. Gaertn.	1	0.65
<i>Berula erecta</i> (Huds.) Coville	1	0.65
<i>Carex</i> spec.	3	1.96
<i>Epilobium ciliatum</i> Raf.	1	0.65
<i>Epilobium hirsutum</i> L.	3	1.96
<i>Eupatorium cannabinum</i> L.	1	0.65
<i>Glyceria fluitans</i> (L.) R. Br.	1	0.65
<i>Gnaphalium uliginosum</i> L.	1	0.65
<i>Hypericum tetrapterum</i> Fr.	1	0.65
<i>Juncus articulatus</i> L.	52	33.99
<i>Juncus bufonius</i> L.	1	0.65
<i>Juncus effusus</i> L.	51/1*	33.33/0.65*
<i>Juncus inflexus</i> L.	4	2.61
<i>Juncus ranarius</i> Perr. & Song.	1	0.65
<i>Mentha aquatica</i> L.	1	0.65
<i>Poa annua</i> agg.	1	0.65
<i>Poa</i> spec.	1	0.65
<i>Poa trivialis</i> L. s. l.	2	1.31
<i>Ranunculus sceleratus</i> L.	2	1.31
<i>Rorippa palustris</i> (L.) Besser	2	1.31
<i>Sagina apetala</i> agg.	4	2.61
<i>Sparganium erectum</i> agg.	2	1.31
<i>Typha angustifolia</i> L.	1	0.65
<i>Urtica dioica</i> L. s. l.	9	5.88
<i>Veronica anagallis-aquatica</i> L.	1	0.65
<i>Veronica beccabunga</i> L.	3	1.96
Total no. of seedlings	153	100

This led to significant differences in the number of seedlings ($U = 16.5$, $p < 0.05$) and the number of species ($U = 17.0$, $p < 0.05$) between sedimentation mats with and without the exclusion of hydrochory (Fig. 8). The mean number of deposited seeds per m^2 was 63.3.

Seed weight classes of captured and deposited seeds

Seeds which were deposited during flooding were predominantly very small. 17 of 26 species trapped with the sedimentation mats belonged to seed weight class 1 (< 0.21 mg), whereas

the seed weight of the species found in the aquatic traps were evenly distributed over all classes.

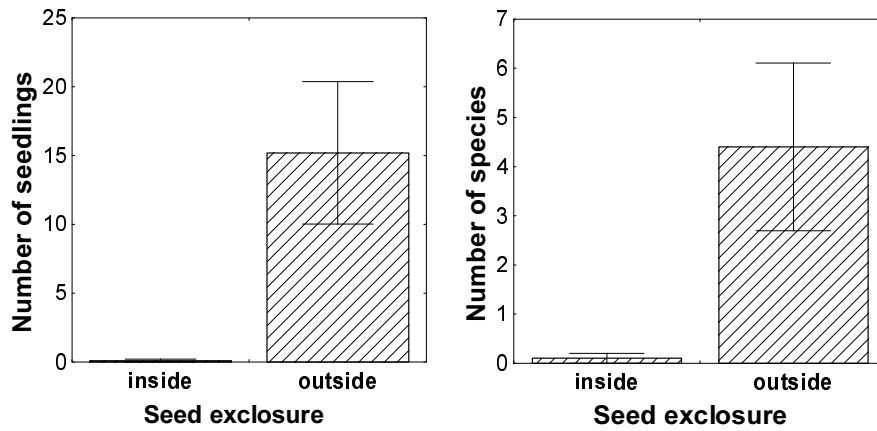

Figure 8. Sedimentation experiment: Effects of excluding water-borne seed transport on the sedimentation of seeds during flooding. Numbers of germinated seeds (A.) and species (B.) captured by 20 sedimentation mats during a flooding period of 21 days are presented.

The frequency distributions of the seed weight classes of the species captured by the aquatic traps and the sedimentation mats, respectively, differed significantly ($U = 391.5$, $p < 0.001$, Fig. 9).

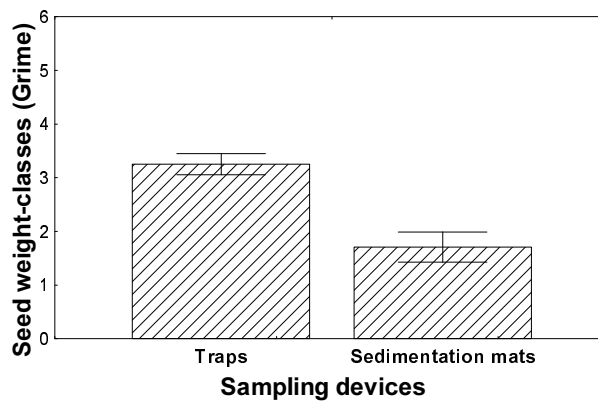

Figure 9. Seed weight class distribution of species found as seeds during 20 weeks of sampling of the water-borne seed transport or in the sedimentation experiment. Seed weight classes according to Grime et al. 1988: 1 < 0.21 mg, 2 = 0.21 - 0.5 mg, 3 = 0.51 - 1 mg, 4 = 1.01 - 2 mg, 5 = 0.21 - 10 mg and 6 > 10 mg. Means and standard errors are presented.

DISCUSSION

Species composition and temporal and spatial variation of water-borne seed transport

During the investigation period of 20 weeks seeds of 26 % of the species occurring in the vegetation of the Upper Eider Valley (according to a local species list, Jensen unpubl.) were trapped within the river. Considering that the riverine seed transport was dominated by species which frequently grow along the riverbank of the Eider as e.g. species of alder carrs (*Alnus glutinosa*), reed banks (*Phalaris arundinacea*) and ruderal vegetation (*Urtica dioica*) the importance of hydrochory for conservation and restoration measures could be questioned. However, as also some seeds of rare or endangered fen-grassland species were occasionally trapped during the comparatively short investigation period of 20 weeks, hydrochory nevertheless should be taken into account planning nature conservation measurements.

We found large spatial and temporal variation in the number of transported seeds in the river Eider. The fact that the highest number of seeds was trapped in the centre of the river is probably the result of spatial differences in current velocity across the river breadth with the highest velocity in the centre of the river (see Trepel et al. 2003).

Temporal variation in the seed transport in rivers was also shown by other authors (e.g. Schneider & Sharitz 1988, Middleton 2000, Andersson & Nilsson 2002). Variation within years can mostly be attributed to seasonal patterns of seed release of different species (e.g. Middleton 2000) whereas variation of hydrochorous seed dispersal between years might be the consequence of differences in weather conditions and flow characteristics (Andersson & Nilsson 2002). The three distinct maxima in the number of trapped seeds in our study (Fig. 5) coincide with the mowing of the macrophytes (end of August) and stormy weather during autumn (start and end of November). The mowing of the macrophytes leads to a sharp increase in current velocity (Trepel et al. 2003) and to a large amount of litter (dead plant material to which seeds can be attached) transported by the river. Stormy weather in autumn increases the litter content of the river, too, and additionally ripe seeds of different species in the rivers' surrounding might have been released and reached the river Eider by anemochory.

Recapture experiment, capture rate and riverine seed transport

We found an exponential decrease of recaptured seeds with increasing dispersal distance of *Helianthus* seeds. Causes of seed loss after seed release could be seed deposition at the river bank, sedimentation to the river bottom and seed predation. Although we have not quantified these factors it can be assumed that seed deposition at the river bank might be of major importance as the river Eider meanders at least along some stretches

upstream of the site where the seed traps were exposed and seed deposition at the river bank is known to occur mainly at barriers like logs or knees (Schneider & Sharitz 1988). Seed sedimentation to the bottom of the river bed might account for additional seed loss, at least for the distance of 12 km, since 66.6 % of the marked seeds ($n = 50$) had already sunken to the ground under moved conditions in the buoyancy experiment after 24 hrs. Furthermore, we observed predation of *Helianthus*- seeds by mallard ducks.

The maximum dispersal distance which we recorded by the recapture experiment was 5 km and thus it can be argued that hydrochory by running water is an effective agent which may connect otherwise fragmented wetland habitats along small rivers. Skoglund (1990) pointed out that the distribution of wet grassland species in periodically flooded wetlands is not limited by dispersal and also Kleinschmidt & Rosenthal (1995) showed that seeds of wet grasslands species can be dispersed over several kilometres during flooding.

We found that the mean actual capture rate (ACR) per trap (0.46 %) was much lower than the hypothetical capture rate of 2 % per trap and that only the trap t3 (which had been exposed immediately before *Helianthus*-seed release in the centre of the river Eider) almost (1.85 %) reached the hypothetical value. Thus both the exposition period and the exposition location affect the ACR of the traps. As a consequence of low current velocity near the river bank, the peripheral traps sampled a smaller water amount than the traps in the centre and generally reached a lower ACR. Furthermore, the capture ability of the traps decreased with the period of exposition as accumulating drift material clogged the traps. We are aware of only two other studies in which the capture ability of the used aquatic traps have been tested. In contrast to our results, Middleton (1995) found that a long exposure (one month) of her traps increased their trapping efficiency which might be explained by the very low litter and seed content of her study river. Bill et al. (1999) carried out a recapture experiment with fresh seeds of three species in an alpine river and trapped about 0.2 to 0.4 % 1 km downstream by aquatic seed traps. These values are somewhat lower than the recapture percentage we observed for *Helianthus*-seeds released 50 and 500 m upstream (1.9 and 0.6 %, respectively) in the present study.

For an estimation of the riverine seed transport (RST) it is of great importance to consider both the large temporal and spatial variation in the number of trapped seeds and the changes of ACR with the length of exposition. So far the calculated RST (25109 seeds per week or 3139 seeds per metre river profile and week) is only based on the investigation period of 20 weeks and the exposition of four traps. The precision of the RST estimation could be further increased by enlarging the investigation period and exposing more traps. Estimations of RST which do not consider spatial and temporal variation of the water-borne seed transport at all have to be interpreted with caution (e.g. Bill et al. 1999, Katenhusen 2001).

Sedimentation experiment

Many investigations have shown, that large amounts of drift line material accumulate during flooding events and that many seeds of several species can be found in drift lines (Dierschke 1984, Nilsson & Grelsson 1990, Skoglund 1990, Schwabe 1991, Kleinschmidt & Rosenthal 1995, Brandes 1999, Katenhusen 2001). Generally it is concluded by these studies that hydrochory is an effective dispersal agent as seeds can be transported by water over large distances. However, the deposition of seeds along drift lines might be an ecological “sink” for many species as requirements for germination and establishment especially of small-seeded grassland species are hardly met below litter layers (Jensen & Gutekunst 2003). Nilsson & Grelsson (1990) reported the highest number of low-growing species at sites with intermediate litter accumulation along a Swedish river. Thus, it is obvious that the overall seed deposition pattern (see Merrit & Wohl 2002) and the amount of area-related seed deposition during flooding might be of great ecological significance. However, area-related seed deposition had not been quantified so far. We tested sedimentation mats to quantify area-related seed sedimentation during flooding. By excluding water-borne seed input from some sites we were additionally able to differentiate between seed rearrangement within small patches and seed dispersal into patches from outside. The calculated mean seed deposition of 63.3 seeds per m² during flooding is very low compared to seed densities of the seed bank (15,000 – 60,000 seeds/m²) or the aerial seed rain of the vegetation (18,000 – 75,000 seeds/m²) of wet grasslands of the study site (Jensen 1998). However, the total area sampled by the sedimentation mats was small and further investigations of area-related seed deposition during flooding are urgently needed.

As nearly all seedlings germinated in samples of freely exposed sedimentation mats, we expect them to come from outside the nearby area with flood water. Thus, hydrochorous seed input seemed to be of greater importance than hydrochorous seed rearrangement within small patches (see also Craddock & Huennecke 1997).

Seed weight classes of captured and deposited seeds

The differences between the distribution of seed weight classes of the 20 weeks of seed trapping and the sedimentation experiment could be explained by the sedimentation behaviour of the seeds and by the structure of the sedimentation mats, which trapped predominantly fine particulate matter. Dierschke (1984), Schwabe (1991) and Katenhusen (2001) found, that species with a high specific weight of their seeds, which are mainly transported under the water surface are often found in sediments of river banks after floods. Species of the genus *Juncus* are generally transported under water (Bonn & Poschlod 1998) and deposited with river sediments (Ridley 1930, Schwabe 1991). As 72 % of the seedlings

in the sedimentation experiment belonged to the genus *Juncus* (seed weight class 1), these observations can be confirmed.

CONCLUSIONS

As we trapped a large number of seeds and species in the river Eider during 20 weeks of sampling, it can be concluded that the constructed seed traps are suited for studying hydrochory in small and nutrient-rich lowland rivers. To maximize the capture rate, the exposition period of the aquatic traps should be adopted to the sediment and litter load of the river. Due to large temporal and spatial variations in riverine seed transport, especially long-term studies with a high temporal and spatial resolution of sampling are strongly recommended for the future.

Seed deposition patterns during flooding are still poorly understood. Our results indicate, that beside the main deposition of seeds in drift-line material a minor quantity of seeds is also deposited directly in the flooded areas and that most of these seeds are rather dispersed into patches from outside than only rearranged within patches. Both further measurements of this form of seed deposition and experimental trials in flumes (see Merrit & Wohl 2002) are needed to quantify the amount of area-related seed deposition and its ecological significance for the establishment of populations.

According to the presented results it can be concluded that hydrochory is an important dispersal way for many wetland plant species which possibly affects species composition and diversity of the vegetation. As also some rare and endangered species were found in the traps, hydrochory is supposed to be an effective dispersal agent connecting otherwise fragmented plant populations.

Plate I

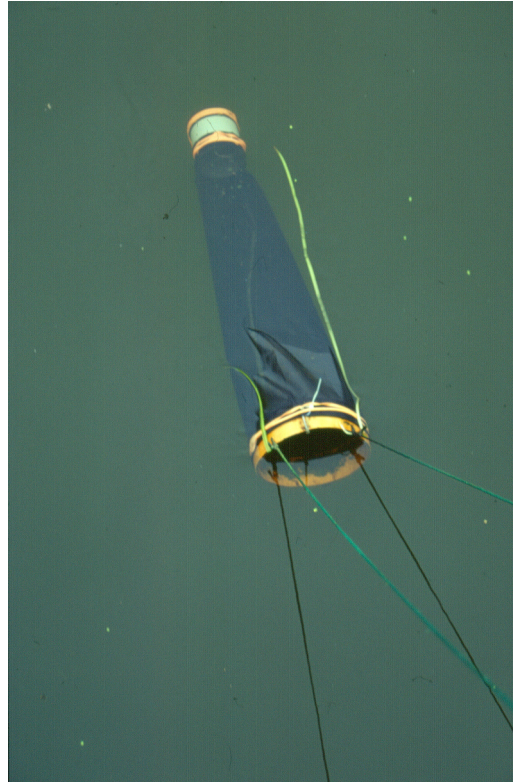

Picture 1. Aquatic seed trap used for the investigation of water-borne seed transport.

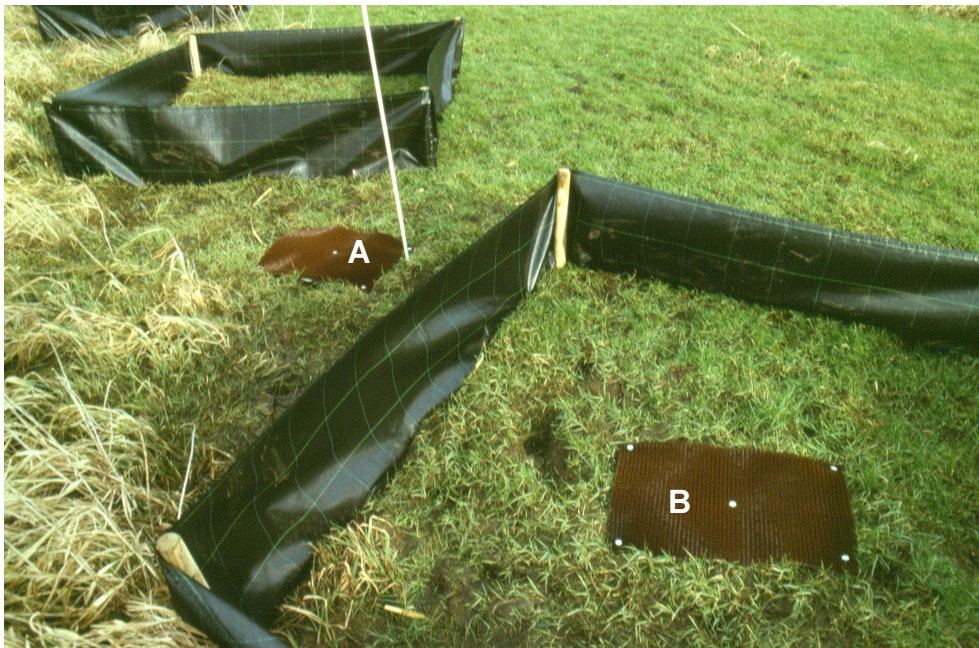

Picture 2. Investigation of laminar seed deposition: sedimentation mats freely exposed to flooding (A) and with exclusion of water-borne seed transport (B; February 2002, before flooding).

Temporal variation and species composition of hydrochorous seed transport: environmental factors vs. species traits

INTRODUCTION

Single aspects of hydrochory, the dispersal of seeds via running water, have been studied already at the beginning of the last century (e.g. Guppy 1891, Praeger 1913, McAtee 1925, Ridley 1930). Even though, there is still lack of knowledge about the entire dispersal process, especially as conditions have changed through increasing human impact in the landscape. Hydrochory can be of major importance for species diversity in riparian landscapes (e.g. Nilsson et al. 1991, Cellot et al. 1998, Middleton 2000), because rivers can function as corridors between fragmented populations (Johansson et al. 1996). Otherwise, most of the rivers in central Europe are regulated, and flooding frequency and extension are often reduced due to flooding management (e.g. Petts et al. 1989). As many riparian plant species need extensive flooding for dispersal on the one hand and are dependent on disturbed soil patches created by flooding on the other hand, the function of rivers as plant dispersal corridors decreases with their regulation (e.g. Nilsson et al. 1997, Merritt & Wohl 2002, Merritt & Wohl 2006). So, the importance of hydrochory for species diversity in riparian landscapes might be reconsidered critically. Therefore, and because the number of seeds transported in the river varies strongly with time (Schneider & Scharitz 1988, Bill et al. 1999, Middleton 2000, Andersson & Nilsson 2002, Boedeltje et al. 2003, 2004, Vogt et al. 2004), more long-term studies are required for the understanding of dispersal processes in riparian landscapes.

Since the first studies of hydrochorous dispersal, a relation between morphological adaptations of seeds to water transport (seed buoyancy) and the realised dispersal ability of the species has been assumed (e.g. Praeger 1913, Ridley 1930). We hypothesize that adaptations to hydrochorous dispersal may be important factors for the occurrence of riparian plant species in their habitats.

For analysing water-borne seed transport in the Upper Eider River in Northern Germany, we sampled the river for a period of two years (summer 2000 – summer 2002). The species composition of the samples was compared with the vegetation and analysed regarding different species traits (e.g. seed buoyancy, dispersal type, seed weight). To explain the temporal heterogeneity in seed transport, the transported seeds were related to environmental parameters (water discharge, wind velocity, precipitation).

The aim of this study was (i) to estimate the abundance and species composition of seeds dispersed in a small lowland river and (ii) to compare the waterborne seed transport with the riparian vegetation and the local species pool. Additionally we were interested in (iii) the impact of different environmental factors and (iv) species traits on hydrochorous seed transport.

METHODS

Study site

The study was conducted in the Upper Eider, a river in Northern Germany with a catchment area of 135 km² upstream to the study site. The river has strongly been influenced by human activities like river regulation, drainage, mowing of the macrophytes each year in summer and mowing and/or grazing of the adjacent fen grasslands. In the study area the river is approx. 8 m broad with a mean discharge of 1.51 m³/s. Flooding of the adjacent fen grasslands frequently occurs during the winter months and sometimes also in summer. Due to rewetting measures in the river valley (e.g. ditch-clogging) flooding events are expected to increase in frequency and extant in the future.

The Upper Eider Valley is a small river valley of approx. 400 ha including both fen areas and mineral slopes and is dominated by species poor eutrophic fen and forage grasslands (Jensen et al. 2001).

Seed sampling

Waterborne seed transport was studied using aquatic seed traps (type: Vogt et al. 2004). In July 2000 each of four aquatic seed traps were exposed evenly distributed over the river diameter from two bridges (“study sites”) separated from each other by approx. three river kilometres (“Grevenkrug”: 54° 13′ 03″ N, 10° 02′ 08″ E; “Eiderheim: 54° 13′ 59″ N, 10° 02′ 17″ E) for sampling seeds transported at the water surface of the river. The traps were sampled regularly every week until July 2002. The samples were washed out in the laboratory over a 0.1 mm filter to reduce sample volume. All visible vegetative propagules

were removed manually during this process and not considered in this study. Afterwards, the sampled material of the first study year was dried and all containing generative propagules were counted under a stereolens and identified using a seed collection and literature (e.g. Berggren 1969, 1981, Anderberg 1994). The term “seeds” will be used in a broader sense and synonymous to generative propagules, including seeds and different forms of fruits in the further text.

The nomenclature followed Wisskirchen & Haeupler (1998).

The sampled material from two traps of each study site in the second year was freshly deposited on sterilized soil in an experimental garden for germination, while samples from the other two traps per study site were treated in the same way as in the first study year. To prevent external seed input, the samples were covered with a translucent gauze. All plants that germinated from the fresh samples were determined and counted until September 2003. *Carex* seedlings that could not be determined up to species level were transferred to a greenhouse for later determination until summer 2005.

Vegetation transects and local species pool

Species composition of 32 vegetation transects were recorded in May/June 2002 along the Upper Eider River: Starting from each trapping bridge 16 transects (8 at each riverside) of 10 m width and 50 m length were laid out at intervals of 250 m upstream. On these transects all species occurring up to 2, 10 and 50 metres distance from the river were recorded.

We defined the local species pool for this investigation as all spermatophyte species recorded in the 400 ha large area of the Upper Eider Valley between 1999 and 2005 (Jensen unpublished).

Environmental parameters

Maximum wind velocity [km/h] in 39 m height a. s. l. during the sampling period was taken for each sampling week out of 180 records per day. Precipitation [mm] was recorded daily and the sum for each week was taken as precipitation value for further analyses. Both abovementioned parameters had been recorded at the weather station of the Institute for Marine Research of the University of Kiel (approx. 12 km NE from the study sites).

Maximum water level [m above sea level] and discharge [m³/s] of the Eider River has been taken each week out of 180 records per day. Water level and discharge were measured by the State Office for Nature and Environment (LANU - Landesamt für Natur und Umwelt) at Flintbek, approx. 5 km downstream of the sampling bridge “Eiderheim”. During the investigation period, the water level differed between 13.24 and 14.02 m above sea level.

With water levels of 13.55 and more, the river exceeded its banks at our study sites. This was the case in September-October 2001, January till March 2002 and in July 2002.

Species traits

Species composition of the seed and seedling samples, vegetation transects and the local species pool were analysed with respect to species traits (seed dispersal type, seed buoyancy, mean plant shoot height, seed weight, fruit production, main dispersal time and Ellenbergs Moisture Value [EMV]; data from Grime et al. 1988, Rothmaler 1994, Kleyer 1995, Ellenberg 2001, Boedeltje et al. 2003, Boedeltje et al. 2004, Flynn et al. 2004, Fitter et al. 2002). For this purpose, the percentage of species belonging to each particular class of the traits was calculated for the species of every sampling week respectively vegetation transect.

For seed dispersal, the classes hydrochory, anemochory and epizoochory were considered, as they are supposed to be relevant for hydrochorous seed dispersal (e.g. Ridley 1930). Species classified to more than one of these three classes were counted once for the class that was mentioned to be most important for the respective species. Seed buoyancy was described by three classes based on t_{50} , i.e. the period (in days) after which 50 % of the seeds had sunk (< 1 day, 1 to < 7 days, > 7 days). Plants with a mean shoot height of < 0.61 m were considered as a first, 0.61 – 3.00 m as a second and > 3.00 m as a third class. Seed weight classes after Grime et al. (1988) were condensed to three classes per 1000 seeds (< 0.51 g, 0.51 – 2.00 g and > 2.00 g). Fruit production per plant was described by three classes (< 1001, 1001 – 10 000, > 10 000 seeds per plant). The main dispersal time has been divided into four classes: spring-summer, summer-autumn, autumn-winter and a group of species which are indifferent in their time of seed dispersal. To simplify matters, EMV's were grouped to three classes containing EMV 2 - 5, 6 - 8 and 9 - 12.

Species missing classification of these traits had not been considered in further analyses.

Data analysis

Due to only minor differences in numbers and species composition of trapped seeds between the two study sites, the results of both bridges were summed up for further analyses. For all analyses sums of trapped seeds per week were considered. We avoided to compare single traps, as they represent different locations across the river diameter with different water velocity and thus differ strongly in waterborne seed transport (see Vogt et al. 2004).

To analyse differences in the number of seeds/seedlings and species between seed determination and germination trials in the second investigation year, a Kruskal-Wallis Test with the single sampling weeks as replicats were carried out.

Temporal variation of seed transport for some representative species with a distinct phenological pattern has been plotted in TGView version 2.0.2 (Grimm 2004).

The effects of environmental parameters (discharge, precipitation, water level, wind velocity) on the seed transport during the investigation period were analysed using forward stepwise multiple regressions (FSMR) with the mean number of seeds sampled per week in all traps (mean of eight traps for the first study year and mean of four for the second study year). Before starting the analysis all variables had been $\ln(x+1)$ transformed to meet the normality assumption of the residuals. After calculating a correlation matrix for testing collinearity, the factor " $\ln(x+1)$ maximum water level" was excluded from the FSMR. Three FSMR were calculated: for the entire dataset (103 weeks) and for the data of the first and the second investigation year separately (51 and 52 weeks).

Furthermore differences in the mean number of transported seeds between weeks with and without flooding were analysed using a Kruskal-Wallis Test.

For analysing differences in the percentage of species traits between the different investigations (trapped seeds, germination trials with trapped seeds, vegetation transects) Kruskal-Wallis tests had been performed with sampling weeks and vegetation transects as replicats.

All statistical analyses were carried out with Statistica version 6.1 (Statsoft 2004).

RESULTS

In total we trapped about 280 000 seeds of 192 species and 51 further taxa at both bridges during two years of investigation (list of species see Appendix). More than 75% of the species were registered in samples of the first 30 weeks (Fig. 1). After 72 (78) weeks, 90% (95%) of species were trapped (Fig. 1).

About 19 500 seedlings of 105 species and 14 further taxa emerged from the samples of the second study year (July 2001-July 2002). In comparison, about 130 000 seeds of 168 species and 40 further taxa could be found in the dried samples of the same sampling period. Except of the period from March to April the numbers of seedlings were on average tenfold lower than the numbers of seeds found in the same weeks.

More than 49 % of all trapped seeds were seeds of *Alnus glutinosa*, while seeds of *Urtica dioica* amounted to more than 9%, and seeds of *Phalaris arundinacea* to almost 7%. Aquatic macrophytes made less than 0.01% of the trapped species.

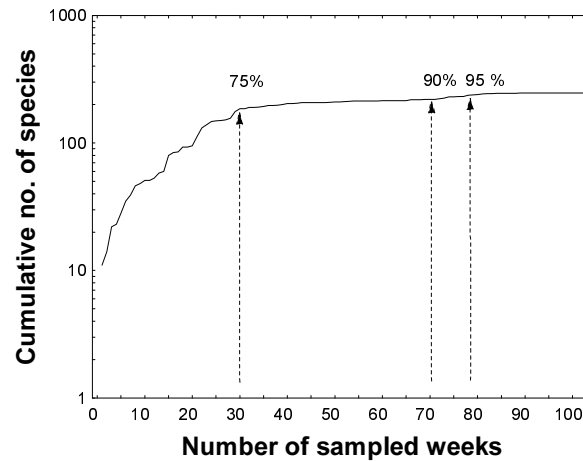

Figure 1. Cumulative number of species (log-scale) against number of sampled weeks. The arrows mark the number of weeks, where 75%, 90% and 95% of the total number of species are present.

More than 95% of the species and further taxa were represented with less than 1% of the total number of trapped seeds. Almost all trapped species are common in the investigation area. Nonetheless, a few seeds of eight regionally rare and endangered species could be found (e.g. *Menyanthes trifoliata*; see Appendix).

The most common species in the germination trial was *Urtica dioica* with almost 53%, while *Rumex obtusifolius vel crispus* amounted to 6% and *Poa trivialis* to about 5%. Seedlings of *Alnus glutinosa* occurred with less than 2%.

The number of seedlings per week was significantly lower than the total number of seeds found in the visually analysed samples of the same period (KW-Test: $H=51.16$, $p < 0.001$). This was also the case for the number of species ($H=15.78$, $p < 0.001$).

Vegetation comparison

Species composition of vegetation at both study sites was similar and was dominated in more than 50% of the transects by *Phalaris arundinacea* and in almost 25% by *Carex acutiformis*. Three regionally rare and endangered species occurred on the transects: *Carex cespitosa*, *Scrophularia umbrosa* and *Viola palustris*.

More than 75% of species of the vegetation transects and nearly 50% of the local species pool was found transported in the Upper Eider River (seed trapping investigation; Tab. 1). For the germination trial these values were lower (vegetation transects: ~60%, local species pool: ~25%; Tab. 1).

Additionally, seeds of 31 species (14%) detected in the river water were absent in the local species pool.

Table 1. Percentage of species of vegetation transects (2, 10 and 50 m distance from the river) and local species pool, that were trapped as seeds in the river (seed trapping investigation and germination trial).

	No. Taxa	Percentage of species of vegetation, represented as seeds in the river	
		Seed trapping	Germination trial
≤ 2 m distance from river	84	82.1	67.9
≤ 10 m distance from river	116	80.2	61.2
≤ 50 m distance from river	136	75.7	58.1
Local species pool	382	49.2	26.4

Temporal variation

The numbers of transported seeds and species per week differed strongly (from less than 100 to up to 25 000 seeds) during the investigation period (Fig. 2 A and B). In both study years the highest amount of seeds was found in winter (from November till March). In the second study year an additional peak of seed transport was reached in June-July (Fig. 2 B.), while from August to October and March to May comparatively low numbers of seeds were trapped. In comparison the number of seeds trapped from March to May 2001 remained on the high level of the months before (Fig. 2 A).

The mean number of seeds per week of both study years was significantly affected by the maximum discharge (24.5% of the variance), while maximum wind velocity did not enter the model ($p > 0.05$; Tab. 2).

Table 2. Results of the forward stepwise multiple regression analyses. Dependent variable was mean number of seeds trapped per week. All variables were $\ln(x+1)$ transformed prior to the analyses.

	Maximum discharge		Maximum wind velocity		Model statistics			
	β	p	β	p	F	df	$R^2_{\text{adjust.}}$	p
Entire investigation period (n=103)	0.447	< 0.001		n.s.	17.61	1	0.246	< 0.001
First study year (n=51)	0.617	< 0.001	0.243	< 0.05	27.65	2	0.516	< 0.001
Second study year (n=52)	0.440	< 0.01		n.s.	6.59	1	0.180	< 0.01

For the first study year (51 weeks), maximum discharge explained 47.2% of the regression model, while wind velocity explained additional 4.4 %. For the second study year (52 weeks), maximum discharge explained 18% of the model (Tab. 2), while maximum wind

velocity did not enter the model. This was also the case for the sum of precipitation for all regressions.

The Kruskal-Wallis Test between weeks with and without flooding revealed, that significant more seeds were found in the river in weeks when flooding occurred ($H = 4.46$, $p < 0.05$).

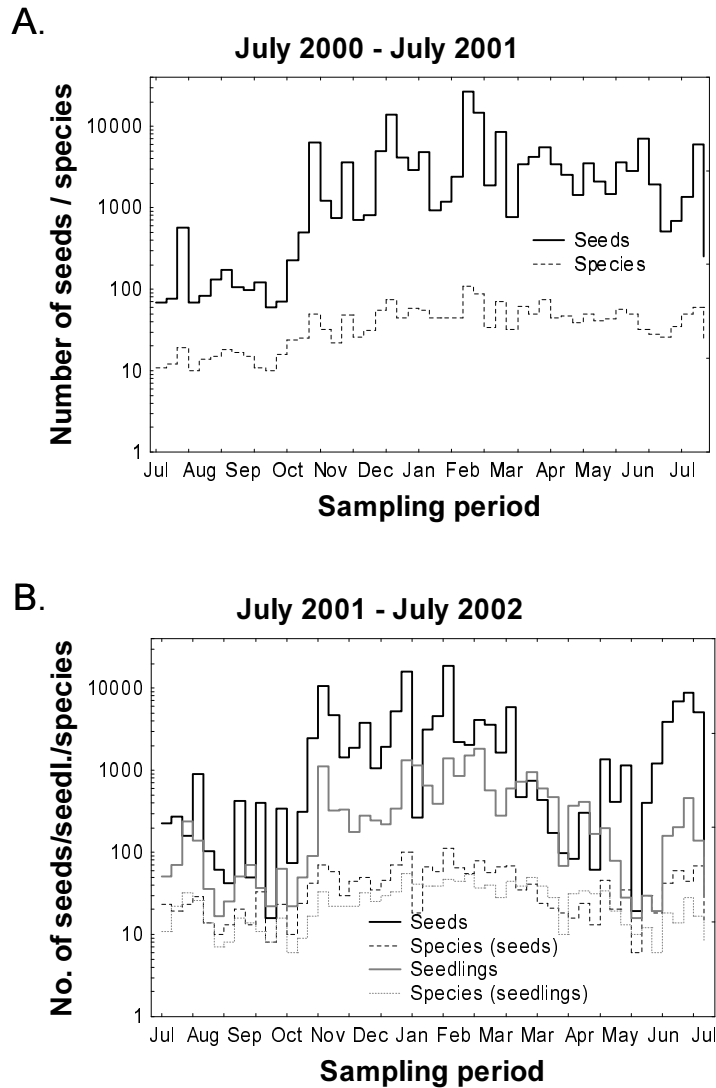

Figure 2. Temporal variation of the total number of seeds and species trapped in July 2000 - July 2001 based on the visual determination of seed content of eight aquatic traps (A.) and in July 2001 – July 2002 based on the visual determination out of four traps in comparison to germination trials with the content of four further traps (B.).

The temporal variation of seed transport differed between species. Based on the occurrence of the most common species in the traps several phenological groups could be distinguished (see Fig. 3 for examples):

- I. *Taraxacum*-type: species, releasing their seeds in late spring, directly after flowering. Seeds of these species were only found in the river during this short period of time.

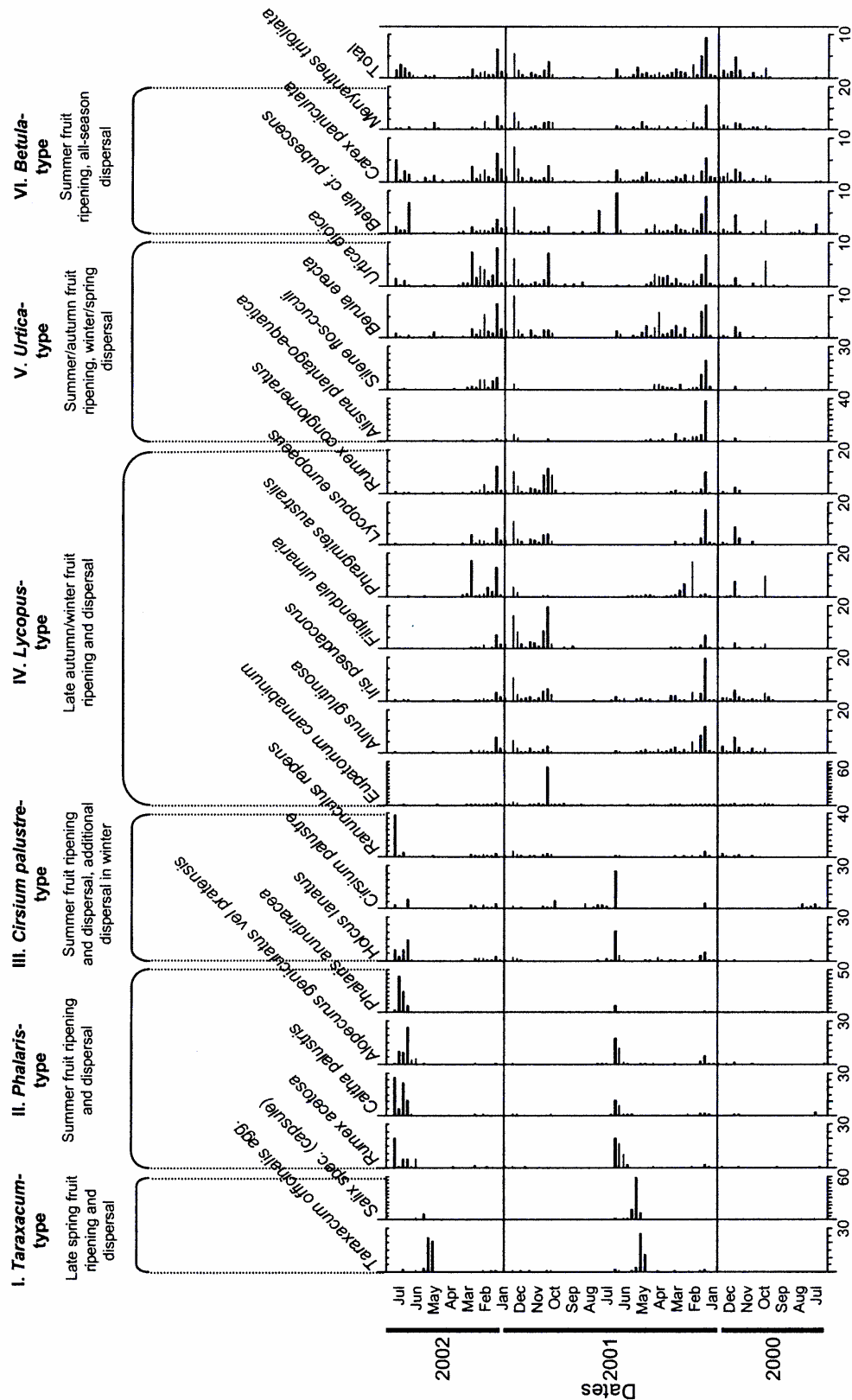

Figure 3. Temporal and phenological patterns of water borne seed dispersal exemplary for some frequently occurring species trapped with aquatic seed traps in the Upper Eider Valley from July 2000 until July 2002. For each species the percentage of trapped seeds per week are shown. The total amount of trapped seeds is shown in the last column.

- II. *Phalaris*-type: species, releasing their seeds in summer and the main riparian transport takes place short time after fruiting.
- III. *Cirsium palustre*-type: seeds are ripening and dispersed mainly in summer, but additional transport takes place in late autumn and winter after the seeds were washed out of the area by precipitation or inundation.
- IV. *Lycopus europaeus*-type: seeds ripening in late autumn and released in winter and transported simultaneously.
- V. *Urtica*-type: seeds ripening in summer/autumn but released and transported later, in spring of the following year.
- VI. *Betula*-type: seeds transported throughout the year in similar amounts.

Most of the species, which occurred frequently in the samples of the aquatic seed traps, can be dedicated to one of the abovementioned groups.

Species traits

Species that were found as trapped seeds, in the germination trials or in vegetation transects differed significantly for almost all analysed species traits (Tab. 3).

Table 3. Differences in percentages of species with particular categories of species traits between seeds trapped in the river, seedlings emerged from the germination trials and species found in the vegetation transects. Results of Kruskal-Wallis Tests.

Species trait	H	p
Seed weight 1-2	105.47	< 0.001
Seed weight 3-4	48.29	< 0.001
Seed weight 5-6	97.99	< 0.001
Shoot height < 0.61 m	32.42	< 0.001
Shoot height 0.61-3.00 m	67.12	< 0.001
Shoot height > 3.00 m	205.68	< 0.001
EMV 2-5	7.66	< 0.05
EMV 6-8	58.01	< 0.001
EMV 9-12	38.15	< 0.001
Fruit production 1	41.90	< 0.001
Fruit production 2	12.06	< 0.01
Fruit production 3	127.85	< 0.001
Seed buoyancy 1	0.93	n.s.
Seed buoyancy 2	20.55	< 0.001
Seed buoyancy 3	98.17	< 0.001
Dispersal - anemochory	119.07	< 0.001
Dispersal - epizoochory	81.52	< 0.001
Dispersal - hydrochory	33.75	< 0.001
Seed release - unspecific	20.40	< 0.001
Seed release - spring/summer	57.72	< 0.001
Seed release - summer/autumn	71.41	< 0.001
Seed release - autumn/winter	92.96	< 0.001

Only for the percentage of species of seed buoyancy class one no significant differences between seeds, seedlings and vegetation was detected. Species classified as hydrochorous occurred more frequently in the traps (seeds and seedlings) and in vegetation than in the local species pool (Fig. 4 A). This was also the case for species with high seed buoyancy (Fig. 4 B). Species with a shoot height of more than 3 m were most frequent in the seed trapping investigation (Fig. 4 C), while species with the highest seed weights occurred least in the germination trial. Instead of that, species with a low seed weight were most frequent there (Fig. 4 D). Although species with the highest fruit production category were more common in the seed trapping investigation, the distribution of different fruit production categories was comparatively similar for seeds, seedlings and vegetation and for the local species pool (Fig. 4 E). This was also the case for the seed release period (Fig. 4 F). In the seed trapping investigation the percentage of species with autumn-winter seed release was highest. For Ellenberg Moisture Values species with EMV 2 - 5 were more common in the species pool than in our investigations. In the seed trapping investigation the percentage of species of EMV 6 - 8 and EMV 9 - 12 were almost equal, while in the germination trial more species of EMV 6 - 8 germinated (Fig. 4 G). For the germination trials the distribution of different groups of EMVs was similar to that of the vegetation transects.

DISCUSSION

Visually determined seeds and germination trials

The comparison of visually determined seeds and seedlings of germination trials from samples of aquatic seed traps showed, that a minor part of seeds in the samples germinated in the germination trials. This result must be seen critically due to the fact that the conditions for germination might not be optimal for all species in our germination trial (see also Merritt & Wohl 2006). Especially some hydrophytes are known to need waterlogged conditions for germination (e.g. Boedeltje et al. 2002). In our trials, the seedlings were watered regularly but did not stay waterlogged.

For *Alnus glutinosa*, the species with the highest abundance in our visually determined samples, the low number of seedlings in the germination trials can be explained by the high amount of empty nutlets, typically produced by this species (McVean 1955).

In contrast, the great majority of seeds of *Urtica dioica* germinated in the trials. In March and April 2002 seeds of this species dominated the samples. Thus, the numbers of seeds and seedlings were almost similar for this period of time. Šrútek & Hara (1996) found, that this species tend to dominate floodplains due to its high amount of seeds, ability to hydrochorous seed dispersal and high percentage of germination.

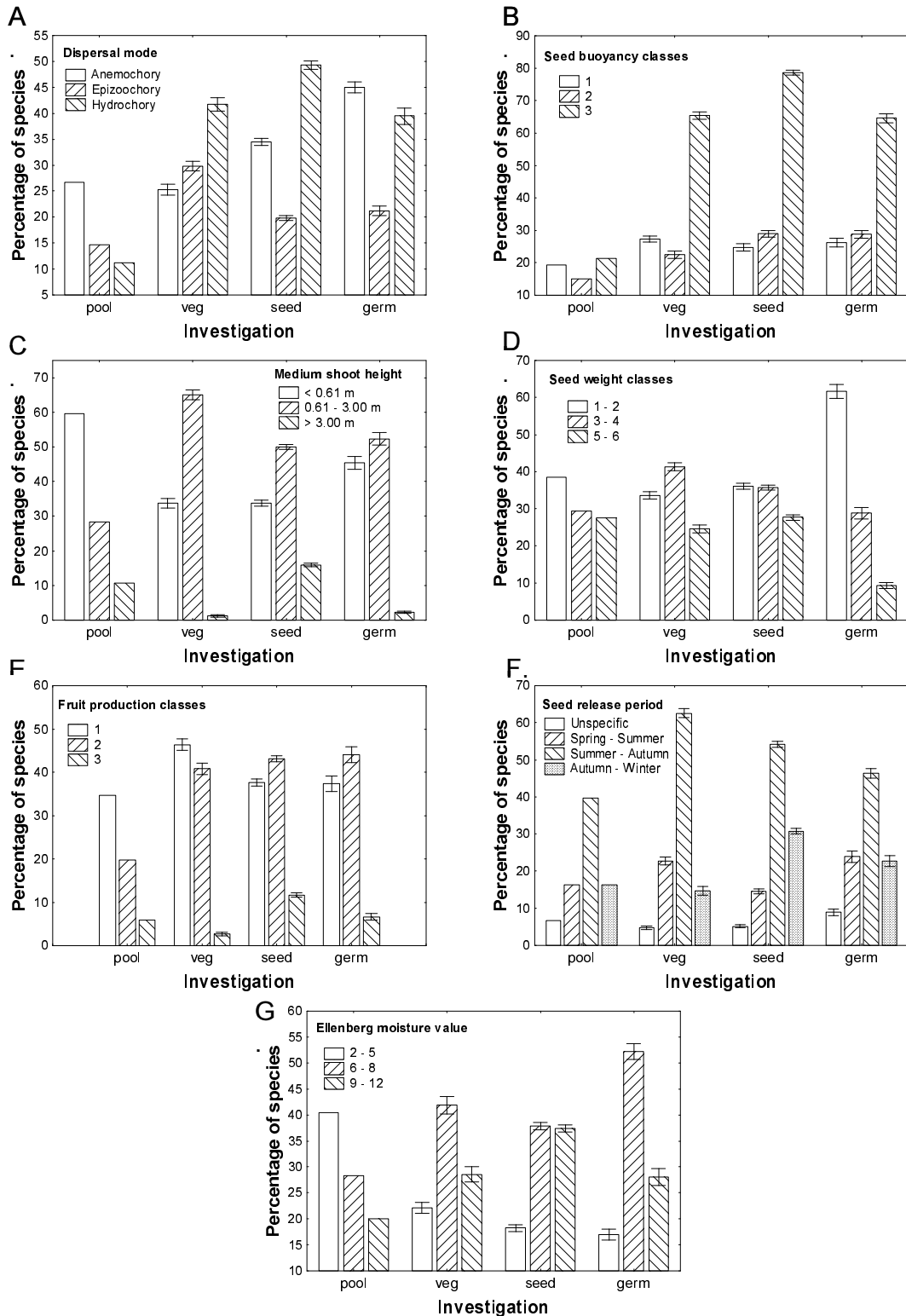

Figure 4. Comparison of different investigations (seed trapping: visually determined seeds [seed] and seedlings occurring in the germination trials [germ], and vegetation transects [veg]) with respect to species traits: A. Dispersal mode, B. Seed buoyancy, C. Medium shoot height, D. Seed weight, E. Fruit production, F. Seed release period and G. Ellenberg Moisture Values (EMV). Means and standard errors are shown. Species for which no data for the specific species traits were available are not shown in the diagram but counted for the total number of species. For further comparison, the percentage of species belonging to the respective species trait is shown for the local species pool of the investigation area (pool).

Furthermore, in the visually determined samples we found less seeds of aquatic macrophytes than we had expected to be transported in a river. This may be caused by the fact that we only sampled the water surface with the aquatic seed traps we used. It is known that some macrophytes are dispersed submerged together with sediments near the ground of the river (e.g. Van der Pijl 1972, Smits et al. 1989). With our investigation those species could not be recorded adequately.

A further explanation for the low numbers of seedlings in the germination trial compared to the number of visually determined seeds may be the conditions during water-borne seed transport itself: Dispersal processes of plant propagules can be seen as filters, reducing viability of seeds in steps from seed release till the arrival at a potential "safe site" (Edwards et al. 1994, Bonn & Poschlod 1998). Mechanical erosion, seed predation or infection by bacteria and fungi are the main obstacles causing this reduction (e.g. Janzen 1971, Xiong & Nilsson 1997). The process of transport via running water may additionally affect the viability of seeds negatively, due to an early germination caused by moistening. For non-hydrophytic species an early germination under unfavourable conditions in the river can lead to a high mortality of seedlings.

Nevertheless, many seeds can survive these processes and the fact that we also found seeds of species which are very rare or absent in our study area can give an impression of the importance of hydrochory for species diversity. Beside dispersal itself, also the availability of safe sites for germination and establishment may be crucial for species diversity in riparian vegetation (e.g. Bischoff 2002, Donath et al. 2003).

Temporal variation

Rivers usually are dynamic systems with variable flowing regimes. These dynamics also influence the seed transport in the river (see e.g. Merritt & Wohl 2002, Nilsson et al. 2002). Temporal variations in seed transport of rivers due to different environmental conditions have already been mentioned by several authors (Bill et al. 1999, Middleton 2000, Andersson & Nilsson 2002, Boedeltje et al. 2003).

In our study especially high numbers of seeds were trapped after minor snow melt events (in February 2001, January and February 2002; personal observations) and after storms in late autumn (November-December 2000, 2001). Additionally, high water levels associated with the inundation of riparian fens increased the seed transport significantly. Both leaf fall and storms in autumn and inundations lead to the transport of large amounts of drift litter in rivers (Andersson & Nilsson 2002), which also increases the number of transported propagules. Especially during these periods also species with low seed

buoyancy can be dispersed attached to drift litter over longer distances (McAtee 1925, Andersson et al. 2000a).

Also the period of seed release of some species can determine their occurrence in river water (Schneider & Sharitz 1988, Merritt & Wohl 2002, Boedeltje et al. 2004). In our investigation this was the case e.g. for *Taraxacum officinale* agg. (see Fig. 3). Nonetheless, for most species a specific time of seed release can not be seen as important factor for hydrochorous dispersal as seeds of most species can be washed out from the soil surface of the catchment area of the river by precipitation, snow-melt or flood independently of the time of their release from the parental plant (Ryvarden 1971, Hampe 2004).

Beside variation within sampling years we also observed differences between them: although in the second study year the content of only two traps per study site had been scanned for seeds, the number of seeds was only about 15% lower than in the first investigation year, where seeds were counted from samples of four traps per bridge. As mentioned above, possible reasons for this could be differences in fruit production of dominant plant species ("mast year") and differences in environmental conditions, especially river dynamics. Evidence for this are the differences in the impact of maximum discharge on mean seed transport between both investigation years. The results that seed transport was positively affected by flooding and that during our investigations inundations only occurred after August 2001 in the second study year could be a further explanation for the comparatively high number of transported seeds in the second investigation year. Middleton (2000) as well as Andersson & Nilsson (2002) found differences in propagule transport between years in their study systems (bald cypress swamp of the Cache River in Illinois, US; Vindel River, Sweden) affected by environmental conditions.

In our investigation the number of trapped species increased almost exponentially until the 30th week of sampling, where 75% of the species has been detected (Fig.1). Thus, we strongly recommend long-term investigations of hydrochorous dispersal particularly with regard to the high temporal variability of seed transport (Fig. 2). Further, some species were transported in the river within a very short period of time after their seed release (Fig. 3).

Seed transport and vegetation

Although the probability of species to be transported in the river is higher for species from the near surrounding of the river, we still observed almost 50% of the species from the local species pool as seeds in our aquatic seed traps (compare Tab. 1). This can be seen as evidence for the importance of hydrochory on species diversity in the small river valley we analysed.

The fact, that 14% of the taxa trapped in the river did not occur in the local species pool argues for long-distance dispersal. This offers possibilities to enhance species diversity in the river valley. We found e.g. seeds of *Pedicularis palustris* in the river water, although no population of this regionally rare and endangered species is known in the river valley.

The transport of species in a river not present in the local vegetation was also found by other authors (e.g. Nilsson & Grelsson 1990, Tabacchi et al. 2005). However, some of the species Tabacchi et al. (2005) found in their study system, were species from agricultural plains or gardens etc., which was also the case for some of the species we found in our aquatic seed traps (e.g. for *Actinidia chinensis*, *Capsicum annum*, see Appendix).

Species traits

The importance of species traits for species dispersal, colonization ability and frequency in the landscape has often been discussed in recent years (e.g. Nilsson et al. 2002, Boedeltje et al. 2003, Lamb & Mallik 2003, Ozinga et al. 2005, Merritt & Wohl 2006). Especially the relation between seed buoyancy and hydrochorous dispersal was subject of several studies (e.g. Schneider & Sharitz 1988, Andersson et al. 2000a, Boedeltje et al. 2003, van den Broek et al. 2005). The results of these studies were not always clear, as also species with low seed buoyancy (< 1 week), were successfully transported during flooding (Andersson et al. 2000a). It also has been noticed, that many species without adaptations to hydrochory can be dispersed with running water (e.g. Hampe 2004, Merritt & Wohl 2006).

In our study, the percentage of species with high seed buoyancy was high in the seed trapping investigation and the riparian vegetation. Thus, we assume that adaptation to hydrochory and seed buoyancy is important for the success of hydrochorous seed dispersal. The high percentage of species classified as dispersed via hydrochory in the seed trapping investigation and in the riparian vegetation can be seen as evidence for the close connection between the river and its surrounding. Nonetheless, we also detected various species without any morphological adaptations to hydrochory and with low seed buoyancy in our traps. Presence of such species in the river argues for a high stochasticity of dispersal processes in general and of hydrochory in particular.

Regarding the entire species pool of the river valley including species of mineral slopes and woods, hydrochory plays a minor role as dispersal vector in comparison to e.g. anemochory.

Successful hydrochorous dispersal includes reaching a suitable habitat for germination and establishment. Thus, species of moist and wet habitats are more likely to be dispersed via hydrochory. Skoglund (1990) found, that most of the species trapped in a small river in Sweden were species of wet meadows. In our investigation, the fact, that the percentage of

species of moist and wet habitats (EMV 6-8) was much higher in aquatic traps than in the local species pool confirms this observation. Important hydrological events like regular floods, snow-melts and storms, which promote seed dispersal in rivers (Middleton 1999, 2002, Merritt & Wohl 2002, Goodson et al. 2003), occur in our study area usually in the winter months. Plant species releasing their seeds in winter are more likely to be found in the river water and thus such species were overrepresented in the aquatic seed traps.

The other analysed species traits (seed weight, fruit production, shoot height) seem to have no specific effect on the ability of species to hydrochorous dispersal.

CONCLUSIONS

We found a large number of species transported in the river. Species composition of seed transport was closely related to riparian vegetation and nearly half of the species of the local species pool were found as seeds in the river. Thus, we assume, that hydrochory is an important dispersal vector in riparian landscapes. Furthermore we observed that the amount of seeds, transported in the river is mainly dependent on hydrological events (e.g. flooding). We conclude, that an increase of frequency and extant of flooding events (e.g. due to rewetting measures) will promote hydrochorous seed dispersal.

Finally we found that species with morphological adaptations to hydrochory and high seed buoyancy were preferably transported in the river. As the amount of such species in our germination trials as well as in the riparian vegetation and the local species pool was lower, we conclude, that adaptations to only one process of hydrochorous dispersal (transport in the river) does not guarantee a successful dispersal.

Appendix. Total number of seeds trapped in the Upper Eider River, summed up for both study sites and 103 sampling dates (July 2000 - July 2002) and seedlings germinated from the germination trial, summed up for both study sites and 52 sampling dates (July 2001-July 2002). Additionally the frequency of species within the sampling periods is shown. Species that are rare or endangered in the study area are marked with an asterisk.

Species	Seeds		Seedlings		Species	Seeds		Seedlings	
	Sum	Frequ.	Sum	Frequ.		Sum	Frequ.	Sum	Frequ.
<i>Acer campestre</i> L.	22	10	.	.	<i>Carex remota</i> L.	.	.	2	2
<i>Acer platanoides</i> L.	37	17	.	.	<i>Carex riparia</i> Curtis	2	2	.	.
<i>Acer pseudoplatanus</i> L.	35	18	.	.	<i>Carex rostrata</i> Stokes	13	8	.	.
<i>Achillea millefolium</i> L.	2	2	.	.	<i>Carex vesicaria</i> L.	2	1	.	.
<i>Actinidia chinensis</i> Planchon	15	12	.	.	<i>Carpinus betulus</i> L.	139	15	.	.
<i>Aegopodium podagraria</i> L.	1	1	2	2	<i>Centaurea jacea</i> L. s. l.	1	1	.	.
<i>Agrimonia eupatoria</i> L.	10	8	.	.	<i>Cerastium holosteoides</i> Fr.	30	16	5	5
<i>Agrostis capillaris</i> L.	.	.	1	1	<i>Chaerophyllum temulum</i> L.	5	3	.	.
<i>Agrostis stolonifera</i> agg.	.	.	555	26	<i>Chamaezyce nutans</i> (Lag.) Small	1	1	.	.
<i>Ajuga reptans</i> L.	21	14	.	.	<i>Chelidonium majus</i> L.	2	2	.	.
<i>Alchemilla vulgaris</i> agg.	7	6	.	.	<i>Chenopodium album</i> agg.	.	.	4	3
<i>Alisma plantago-aquatica</i> agg.	85	24	.	.	<i>Cicuta virosa</i> L.	158	43	5	4
<i>Alliaria petiolata</i> (M. Bieb.) C. Avara & Grande	3	3	.	.	<i>Cirsium arvense</i> (L.) Scop.	12	6	9	5
<i>Alnus glutinosa</i> (L.) P. Gaertn.	138737	103	384	26	<i>Cirsium oleraceum</i> (L.) Scop.	32	11	7	5
<i>Alopecurus geniculatus</i> L.	141	29	48	19	<i>Cirsium palustre</i> (L.) Scop.	312	52	65	16
<i>Alopecurus pratensis</i> L.	521	34	25	14	<i>Cirsium vulgare</i> (Savi.) Ten.	28	12	.	.
<i>Anagallis arvensis</i> L.	1	1	.	.	<i>Conyza canadensis</i> (L.) Cronquist	.	.	12	8
<i>Angelica sylvestris</i> L.	292	49	49	21	<i>Claytonia perfoliata</i> Donn ex. Willd.	1	1	.	.
<i>Anthoxanthum odoratum</i> agg.	5	4	.	.	<i>Conium maculatum</i> L.	6	4	.	.
<i>Anthriscus sylvestris</i> (L.) Hoffm.	22	15	1	1	<i>Coryllus avellana</i> L.	7	6	.	.
<i>Aphanes arvensis</i> L.	5	4	.	.	<i>Cotula coronopifolia</i> L.	7	3	.	.
<i>Arenaria serpyllifolia</i> agg.	1	1	.	.	<i>Crataegus laevigata</i> agg.	2	2	.	.
<i>Arrhenatherum elatius</i> (L.) Beauv. ex Presl & Presl	30	14	.	.	<i>Crataegus monogyna</i> Jack. s. l.	103	37	.	.
<i>Artemisia vulgaris</i> L.	26	7	4	3	<i>Cynosurus cristatus</i> L.	38	6	.	.
<i>Atriplex prostrata</i> agg.	.	.	7	5	<i>Dactylis glomerata</i> agg.	452	48	24	8
<i>Avena sativa</i> L.	3852	21	.	.	<i>Deschampsia cespitosa</i> agg.	83	20	35	11
<i>Barbarea vulgaris</i> R. Br.	236	55	14	11	<i>Echinochloa crus-galli</i> (L.) P. Beauv.	1	1	.	.
<i>Bellis perennis</i> L.	.	.	1	1	<i>Eleocharis palustris</i> agg.	2	1	.	.
<i>Berula erecta</i> (Huds.) Coville	3243	83	107	27	<i>Elymus repens</i> (L.) Gould s. str.	104	25	.	.
<i>Bidens cernua</i> L.	38	20	1	1	<i>Epilobium hirsutum</i> L.	.	.	658	35
<i>Bidens tripartita</i> L.	9	9	.	.	<i>Epilobium tetragonum</i> subsp. <i>lamyi</i> (Schultz) Nym.	4	3	253	35
<i>Brassica napus</i> L.	5	4	.	.	<i>Epilobium palustre</i> L.	.	.	330	36
<i>Bromus hordeaceus</i> L.	1	1	.	.	<i>Epilobium roseum</i> Schreb.	.	.	3	1
<i>Calamagrostis canescens</i> (Weber) Roth	88	20	20	8	<i>Euonymus europaea</i> L.	2	1	.	.
<i>Caltha palustris</i> L.	158	23	.	.	<i>Eupatorium cannabinum</i> L.	828	49	180	29
<i>Capsella bursa-pastoris</i> (L.) Med.	3	3	2	2	<i>Euphorbia peplus</i> L.	6	6	2	2
<i>Capsicum annuum</i> L.	1	1	.	.	<i>Fagopyrum esculentum</i> Moench	3	2	.	.
<i>Cardamine amara</i> L.	.	.	15	7	<i>Fagus sylvatica</i> L.	13	9	.	.
<i>Cardamine pratensis</i> agg.	.	.	60	23	<i>Fallopia convolvulus</i> (L.) Å. Löve	7	5	.	.
<i>Carex acuta</i> L.	57	21	.	.	<i>Festuca arundinacea</i> Schreb.	16	4	.	.
<i>Carex acutiformis</i> Ehrh.	1543	83	.	.	<i>Festuca pratensis</i> Huds. s. l.	131	18	.	.
<i>Carex canescens</i> L.	29	14	.	.	<i>Festuca rubra</i> agg.	16	10	8	4
<i>Carex cespitosa</i> L. *	53	20	.	.	<i>Filago vulgaris</i> Lam. *	1	1	.	.
<i>Carex disticha</i> Huds.	12	6	1	1	<i>Filipendula ulmaria</i> (L.) Maxim.	2374	75	538	36
<i>Carex elata</i> All.	11	7	.	.	<i>Frangula alnus</i> Mill.	4	4	.	.
<i>Carex elongata</i> L.	11	6	.	.	<i>Fraxinus excelsior</i> L.	378	40	25	7
<i>Carex flava</i> agg.*	1	1	.	.	<i>Fumaria officinalis</i> L. s. l.	4	4	1	1
<i>Carex hirta</i> L.	7	6	.	.	<i>Galeopsis tetrahit</i> agg.	353	64	.	.
<i>Carex muricata</i> agg.	.	.	1	1	<i>Galinsoga parviflora</i> Cav.	2	2	.	.
<i>Carex nigra</i> (L.) Reichard	28	12	2	2	<i>Galium aparine</i> agg.	94	45	23	14
<i>Carex ovalis</i> Good.	16	10	.	.	<i>Galium palustre</i> L. s. l.	305	31	3	2
<i>Carex panicea</i> L. *	3	3	.	.	<i>Geranium robertianum</i> agg.	2	1	.	.
<i>Carex paniculata</i> L.	10047	100	113	28	<i>Geum urbanum</i> L.	4	4	.	.
<i>Carex pseudocyperus</i> L.	36	16	2	2	<i>Glechoma hederacea</i> L.	1	1	1	1

Appendix (continued).

Species	Seeds		Seedlings		Species	Seeds		Seedlings	
	Sum	Frequ.	Sum	Frequ.		Sum	Frequ.	Sum	Frequ.
<i>Glyceria fluitans</i> agg.	133	30	8	5	<i>Prunus cerasus</i> L.	16	12	.	.
<i>Glyceria maxima</i> (Hartm.) Holmb.	218	44	.	.	<i>Prunus domestica</i> L. s. l.	6	6	.	.
<i>Gnaphalium uliginosum</i> L.	.	.	7	6	<i>Prunus padus</i> L.	10	7	.	.
<i>Helianthus annuus</i> L.	1	1	.	.	<i>Prunus spinosa</i> agg.	7	4	.	.
<i>Heracleum mantegazzianum</i> Sommier & Levier	11	6	.	.	<i>Quercus robur</i> L.	11	10	.	.
<i>Holcus lanatus</i> L.	891	69	145	25	<i>Ranunculus aquatilis</i> agg.	34	16	.	.
<i>Hordeum vulgare</i> L.	1	1	.	.	<i>Ranunculus ficaria</i> L.	.	.	2	2
<i>Hydrocotyle vulgaris</i>	21	15	.	.	<i>Ranunculus repens</i> L.	2706	84	278	43
<i>Hypericum perforatum</i> L.	.	.	2	2	<i>Ranunculus sceleratus</i> L.	4315	96	634	39
<i>Hypericum tetrapterum</i> Fr.	.	.	12	11	<i>Rorippa nasturtium-aquaticum</i>	1	1	16	10
<i>Hypochaeris radicata</i> L.	1	1	.	.	<i>Rorippa palustris</i> (L.) Besser	178	38	12	5
<i>Iris pseudacorus</i> L.	432	58	12	9	<i>Rumex acetosa</i> L.	142	24	6	3
<i>Juncus articulatus</i> L.	.	.	31	12	<i>Rumex acetosella</i> L. s. l.	29	14	.	.
<i>Juncus bufonius</i> agg.	.	.	7	4	<i>Rumex conglomeratus</i> Murray	9225	75	.	.
<i>Juncus effusus</i> L.	.	.	287	28	<i>Rumex crispus</i> L.	.	.	11	6
<i>Juncus inflexus</i> L.	.	.	1	2	<i>Rumex hydrolypatham</i> Huds.	1381	74	.	.
<i>Lapsana communis</i> L.	10	8	3	3	<i>Rumex obtusifolius</i> L.	.	.	75	17
<i>Lemna minor</i> L.	13	10	.	.	<i>Rumex maritimus</i> L.	17	10	.	.
<i>Linum usitatissimum</i> L.	4	3	.	.	<i>Sagina apetala</i> agg.	.	.	84	16
<i>Lolium perenne</i> L.	151	35	4	3	<i>Sambucus nigra</i> L.	547	70	.	.
<i>Lotus pedunculatus</i> Cav.	4	2	.	.	<i>Schoenoplectus lacustris</i> (L.) Palla	2	2	.	.
<i>Lycopus europaeus</i> L.	7442	78	287	36	<i>Scirpus sylvaticus</i> L.	400	54	3	2
<i>Lysimachia vulgaris</i> L.	269	20	29	8	<i>Scrophularia nodosa</i> L.	64	6	18	12
<i>Lythrum salicaria</i> L.	52	8	.	.	<i>Scrophularia umbrosa</i> Dumort.*	84	5	1	1
<i>Matricaria discoidea</i> D.C.	.	.	1	1	<i>Scutellaria galericulata</i> L.	116	35	30	10
<i>Mentha aquatica</i> L.	725	50	64	19	<i>Silene flos-cuculi</i> (L.) Clairv.	.	.	4	4
<i>Menyanthes trifoliata</i> L.*	177	53	.	.	<i>Silene dioica</i> (L.) Clairv.	39	16	.	.
<i>Moehringia trinervia</i> (L.) Clairv.	67	25	.	.	<i>Silene flos-cuculi</i> (L.) Clairv.	121	28	1	1
<i>Montia fontana</i> L. s. str.*	8	5	.	.	<i>Silene vulgaris</i> (Moench) Garcke	15	7	.	.
<i>Nasturtium microphyllum</i> Boenn. ex. Rchb.	1	1	.	.	<i>Sisymbrium officinale</i> (L.) Scop.	1	1	.	.
<i>Nuphar lutea</i> (L.) Sibth. & Sm.	13	10	.	.	<i>Sium latifolium</i> L.	2	2	.	.
<i>Nymphaea alba</i> L.	11	9	.	.	<i>Solanum dulcamara</i> L.	13	12	.	.
<i>Odontites vernus</i> agg.	1	1	.	.	<i>Sonchus asper</i> (L.) Hill	35	22	312	46
<i>Oenanthe aquatica</i> (L.) Poir.	12	6	.	.	<i>Sonchus oleraceus</i> L.	17	9	8	6
<i>Oxalis acetosella</i> L.	1	1	.	.	<i>Sorbus aucuparia</i> L.	24	12	.	.
<i>Papaver somniferum</i> L.	31	8	.	.	<i>Stachys palustris</i> L.	.	.	50	13
<i>Pedicularis palustris</i> L.*	8	7	.	.	<i>Stellaria alsine</i> Grimm	12	7	37	13
<i>Persicaria amphibia</i> (L.) Delarbré	6	3	.	.	<i>Stellaria aquatica</i> (=Mysoton)	37	14	1	1
<i>Persicaria hydropiper</i> (L.) Delarbré	253	52	4	4	<i>Stellaria graminea</i> L.	20	14	.	.
<i>Persicaria lapathifolia</i> (L.) Delarbré s. l.	56	24	1	1	<i>Stellaria holostea</i> L.	6	5	.	.
<i>Persicaria minor</i> (Huds.) Opiz	17	10	4	4	<i>Stellaria media</i> agg.	71	26	2	2
<i>Phalaris arundinacea</i> L.	18848	92	123	19	<i>Taraxacum officinale</i> agg.	685	45	156	32
<i>Phleum pratense</i> agg.	19	7	.	.	<i>Thalictrum flavum</i> L.*	2	2	.	.
<i>Phragmites australis</i> (Cav.) Trin. Ex Steud.	2441	59	.	.	<i>Tilia cordata</i> Mill.	25	13	.	.
<i>Picea abies</i> (L.) H. Karst.	423	49	.	.	<i>Tilia platyphyllos</i> Scop.	6	6	.	.
<i>Plantago lanceolata</i> L.	.	.	2	2	<i>Trifolium repens</i> L.	.	.	2	2
<i>Plantago major</i> L. s. l.	9	2	57	5	<i>Tripleurospermum perforatum</i> (Mérat) Lainz	1	1	.	.
<i>Poa annua</i> L.	15	10	10	7	<i>Triticum aestivum</i> L.	1	1	.	.
<i>Poa nemoralis</i> L.	1	1	.	.	<i>Tussilago farfara</i> L.	.	.	1	1
<i>Poa palustris</i> L.	1	1	.	.	<i>Urtica dioica</i> L. s. l.	25875	101	10412	50
<i>Poa pratensis</i> agg.	2	2	14	10	<i>Valeriana officinalis</i> agg.	368	56	61	26
<i>Poa trivialis</i> L. s. l.	.	.	930	47	<i>Valerianella locusta</i> (L.) Laterr.	1	1	.	.
<i>Polygonum aviculare</i> agg.	110	32	.	.	<i>Veronica anagallis-aquatica</i> L.	2	1	80	18
<i>Potentilla anserina</i> L.	1	1	.	.	<i>Veronica arvensis</i> L.	.	.	13	8
<i>Potentilla argentea</i> agg.	1	1	.	.	<i>Veronica beccabunga</i> L.	.	.	83	20
<i>Potentilla erecta</i> (L.) Raeusch.	2	2	.	.	<i>Veronica hederifolia</i> agg.	18	9	.	.
<i>Potentilla palustris</i> (L.) Scop.	14	12	.	.	<i>Veronica serpyllifolia</i> L.	.	.	2	1
<i>Prunella vulgaris</i> L.	47	6	1	1	<i>Viburnum opulus</i> L.	2	2	.	.
<i>Prunus avium</i> L.	32	19	.	.	<i>Vicia hirsuta</i> (L.) Gray	10	2	.	.

Appendix (continued).

Species	Seeds		Seedlings		Species	Seeds		Seedlings	
	Sum	Frequ.	Sum	Frequ.		Sum	Frequ.	Sum	Frequ.
<i>Vitis vinifera</i> L. s. l.	5	5	.	.	<i>Pinus</i> spec.	1	1	.	.
Further taxa:	<i>Poa</i> cf. <i>trivialis</i>	1900	50	.	.
<i>Acer</i> spec.	9	7	.	.	<i>Poa</i> spec.	151	15	.	.
<i>Agrostis capillaris</i> vel <i>stolonifera</i>	40	13	.	.	<i>Populus</i> spec. (Kapsel)	4	1	.	.
<i>Amaranthus</i> spec.	2	2	.	.	<i>Potamogeton</i> spec.	35	15	.	.
<i>Arctium minor</i> vel <i>tomentosum</i>	1	1	.	.	<i>Potentilla</i> spec.	95	35	.	.
<i>Atriplex</i> spec.	140	34	.	.	<i>Prunus</i> spec.	14	11	.	.
<i>Betula</i> cf. <i>pubescens</i>	12680	100	.	.	<i>Reseda</i> spec.	1	1	.	.
<i>Callitriche</i> spec.	50	1	163	27	<i>Rosa</i> spec.	26	14	.	.
<i>Campanula</i> spec.	1	1	.	.	<i>Rubus</i> spec.	112	40	.	.
<i>Carex</i> cf. <i>acutiformis</i>	.	.	22	16	<i>Rumex obtusifolius</i> vel <i>crispus</i>	1078	71	1190	40
<i>Carex</i> cf. <i>cespitosa</i>	.	.	1	1	<i>Rumex</i> spec.	78	22	4	2
<i>Carex</i> spec.	581	58	89	22	<i>Sagina</i> spec.	.	.	7	3
<i>Chara</i> spec. (oogonium)	5	4	.	.	<i>Salix</i> spec. (capsule)	10502	43	5	4
<i>Chenopodium</i> spec.	127	38	.	.	<i>Salvia</i> spec.	1	1	.	.
<i>Cirsium</i> spec.	10	7	.	.	<i>Setaria</i> spec.	1	1	.	.
<i>Cynoglossum</i> spec.	2	2	.	.	<i>Silene</i> spec.	2	2	.	.
<i>Epilobium</i> spec.	1902	64	.	.	<i>Sonchus</i> spec.	1	1	.	.
<i>Festuca</i> spec.	2	2	.	.	<i>Sorbus</i> c.f. <i>aria</i>	1	1	.	.
<i>Galium</i> spec.	1	1	.	.	<i>Sparganium</i> spec.	9	5	.	.
<i>Geranium</i> spec.	2	2	.	.	<i>Stachys</i> c.f. <i>palustris</i>	277	44	.	.
<i>Hypericum</i> spec.	4	4	.	.	<i>Stellaria</i> spec.	3	1	.	.
<i>Juncus</i> cf. <i>effusus</i>	6952	53	.	.	<i>Thymus</i> spec.	1	1	.	.
<i>Lamium</i> spec.	106	31	.	.	<i>Typha</i> spec.	23	8	.	.
<i>Larix</i> spec.	42	22	.	.	<i>Vicia</i> spec.	1	1	.	.
<i>Myosotis</i> cf. <i>scorpioides</i> agg.	88	21	161	25	<i>Viola</i> spec.	18	10	.	.
<i>Papaver</i> spec.	1	1	.	.	Unknown	474	62	21	12
<i>Persicaria</i> spec.	15	8	.	.	Total sum	282685	103	19713	52
<i>Picris</i> spec.	1	1	.	.					

Plate II



Picture 3. Aquatic seed traps exposed at a bridge crossing the Upper Eider River at the study site "Eiderheim" (February 2002).



Picture 4. Seeds sampled in the Upper Eider river using aquatic seed traps in December 2001 (e.g. A: *Alnus glutinosa*, B: *Iris pseudacorus*, C: *Fraxinus excelsior*, D: *Rumex hydrolapathum*, E: *Ranunculus repens*, F: *Angelica sylvestris*).

Seed deposition in drift lines: chance or hazard for species establishment?

INTRODUCTION

In riparian wetlands flooding is a main factor affecting vegetation composition and structure (e.g. Bornette and Amoros 1996, Middleton 1999, Nilsson 1999). River management during the last century has led to the reduction of flooding frequency, extension and duration and thus to changes in plant species composition and dominance in riparian vegetation (e.g. Petts et al. 1989, Marston et al. 1995, Poff et al. 1997, Bunn & Arthington 2002). Nevertheless, dispersal processes via river water still take place and should be considered also regarding the restoration of river dynamics and vegetation of riparian wetlands.

Dispersal can only be seen as successful, if the dispersed propagules survive the transport, are deposited at an appropriate safe site for germination and establishment and develop to a mature plant (Webb 1966, see Bonn & Poschlod 1998). The single steps of dispersal are ecological filters, reducing the number of viable propagules (Middleton 1999). Several studies have already investigated water-borne seed transport in different river systems (e.g. Skoglund 1990, Kleinschmidt & Rosenthal 1995, Bill et al. 1999, Middleton 2000, Andersson & Nilsson 2002, Boedeltje et al. 2003, Vogt et al. 2004, Tabacchi et al. 2005). In addition, the deposition of hydrochorous transported seeds in drift lines (McAtee 1925, Stopp 1956, Nilsson & Grelsson 1990, Katenhusen 2001, Neff & Baldwin 2005), as well as in mostly mineral sediments (e.g. Dierschke 1984, Schwabe 1991, Brandes 1999, Goodson et al. 2003) was analysed. Formation of drift lines can be observed in riparian systems after fluctuations of water level, especially after seasonal floods. The pattern in deposition of the drift lines is dependent on the physical properties of the river, the geometry of the riverbank and occurrence of hindrances (Merritt & Wohl 2002).

In the present paper, we focus on the role of drift line material for plant species diversity in riparian landscapes. Although, drift litter material may contain vast numbers of plant propagules (see e.g. Nilsson & Grelsson 1990, Katenhusen 2001, Neff & Baldwin 2005), litter layers (which can reach considerable quantities), might act as mechanical barriers and thus

hamper germination and establishment of plants (Nilsson et al. 1999, Xiong et al. 2003). Additionally, drift line deposition and favourable climatic conditions for germination of most species does not always take place at the same time and longer periods of exposition are ineluctable. Considering the fact that concentration of seeds in drift lines makes them especially attractive for predators and a high moisture content sensitive to fungal infections (see e.g. Xiong & Nilsson 1997), we assume that number of viable seeds in drift lines decreases within time.

Also the question of the origin of seeds in drift lines is of ecological relevance. We assume that, if seeds deposited with drift line are transported above the borders of the site of deposition, they can potentially enhance species diversity of the local community. In case of the mere rearrangement of seeds within the same site, species composition of drift line would mainly reflect the species composition of the local community and drift lines of separate sites would strongly differ between each other. In contrast, in case of seed transport above the border of the site, species in drift line would reflect the regional species pool and a high similarity between species composition of drift lines of different sites should be observed.

Our main question was, if drift lines can be seen as sink or source for species diversity in riparian fen grasslands. To answer this question, we analysed:

- The seed content in riparian drift litter of five fen grassland sites differing in vegetation and management to estimate whether species composition in drift litter rather reflects the local community or the regional species pool (germination trial with drift-litter).
- Effects of naturally deposited drift lines on germination and establishment
- Effects of time between drift litter deposition (mainly in winter) and the main germination period of seeds (April-May) on the amount of viable propagules in drift lines ("Aging" of drift lines)
- Effects of experimental disturbance and drift litter addition on seedling emergence

METHODS

Study sites

The study was conducted in the Upper Eider Valley, a river valley in Northern Germany with a catchment area of 135 km² upstream to the study sites. The Upper Eider River has strongly been influenced by human activities like river regulation, drainage, mowing of the macrophytes each year in summer and mowing and/or grazing of the adjacent fen grasslands. In the study area the river is approx. 8 m broad with a mean discharge of 1.51

m³/s. Flooding of the adjacent fen grasslands frequently occurs during the winter months and sometimes also in summer. Due to rewetting measures in the river valley (e.g. clogging of ditches, abandonment of macrophyte mowing) flooding events are expected to increase in frequency in the future. During our investigations winter floods occurred in February/March 2000, 2002 and 2004. The river valley is dominated by grazed, mown and abandoned species poor eutrophic fen- and forage-grasslands (Jensen et al. 2001). Drift lines, accumulated during floods, consist mainly of leafs and stems of herbs and grasses (e.g. *Phalaris arundinacea* and *Phragmites australis*) as well as of small woody pieces and remnants of aquatic macrophytes (e.g. *Lemna* spp. and *Sparganium emersum*).

Germination trial with drift-litter

The sampling of drift line material in the Upper Eider Valley took place in March/April 2000. We collected each 1 l of drift line material per sample after the regular flood has declined. 140 samples of drift line material were collected from five sites along the river representing typical fen grassland vegetation and management types (fen meadow, moderately and heavily grazed fen grasslands, abandoned fen grasslands) in the Upper Eider Valley (54°16' N, 10°5' E and 54°11' N, 10°2' E).

After chilling (four weeks at 4°C) the drift line samples were exposed in a thin layer on sterilized soil in an experimental garden for a period of at least seven months. The trays were covered with a translucent gauze to prevent external seed input and were watered regularly. All seedlings, which occurred during this period were determined, counted and removed.

The nomenclature of species follows Wisskirchen & Haeupler (1998).

Effects of naturally deposited drift lines on germination and establishment

At an abandoned and a moderately grazed site (54°16' N, 10°5' E) we marked areas with and without natural drift line deposition after flooding in April 2000. Within these areas we chose and marked each six plots á one m² (altogether 24 plots). Species composition and abundance of emerging seedlings was registered monthly from May till September.

“Aging” of drift lines

Drift line material was collected at a moderately grazed fen grassland site in the Upper Eider Valley (54°16' N, 10°5' E) after flooding in March 2002. 60 samples á one litre were laid out in form of marked little heaps in the near surrounding of the sampling site without apparent natural drift lines. Ten samples were recollected the same day and transferred to germination trays filled with sterilised soil in an experimental garden. The trays were covered

with a translucent gauze to prevent external seed input and were watered regularly. In the following weeks, ten further samples per week were recollected and treated in the same way. Seedlings emerging from the samples were identified, counted and removed during summer 2002 and 2003.

Experimental disturbance, drift litter addition and seedling emergence

To analyse the effects of disturbance and drift line material on seedling emergence, we carried out a field experiment with the factors drift-litter addition (yes/no) and disturbance (mowing/small gaps/large gaps/undisturbed control) at an abandoned fen grassland site in the Upper Eider Valley (54°12' N, 10°2' E) in 2004. 16 blocks á one m² including the different disturbance treatments were installed in April 2004 (Fig. 1).

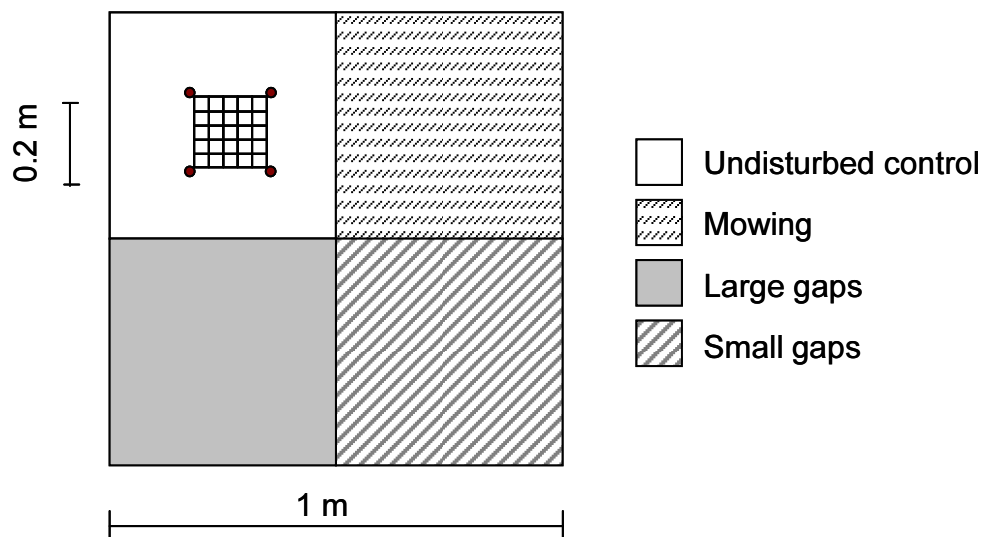

Figure 1. Design of the two-factorial field experiment with the factors drift-litter addition (yes; no) and disturbance (mowing; small gaps; large gaps; undisturbed control). One of 16 blocks is shown exemplary. Half of the blocks were covered with a thin layer of freshly deposited drift litter. Emerging seedlings were counted in a 0.2 m x 0.2 m grid in the middle of each subplot.

Freshly deposited drift-litter, collected after the decline of the winter flood in March/April 2004, was added in a thin layer (~ 1 cm) to eight of the blocks. All newly emerging seedlings were registered in a 20 x 20 cm grid at all subplots four times during the vegetation period in 2004 (Fig. 1) and summed up for further analyses.

Statistical analyses

For the following statistical analyses Statistica 6.1 (Statsoft Inc. 2004) was used, except for the NMS for the germination trial with drift litter. For this analysis we used PC-ORD (McCune and Mefford, 1999), as the number of variables for NMS is restricted to 90 for Statistica 6.1.

We analysed differences in species composition between drift line samples of different sampling sites using Nonmetric Multidimensional Scaling (NMS). The NMS was accomplished with two dimensions, Jaccard distance measure, and ten iterations in the final solution. To test whether samples of different sites significantly differ with respect to species composition, nonparametric tests (Kruskal-Wallis tests) on axis scores of the NMS were performed, as ANOVA assumptions were not fulfilled.

For analysing the effects of naturally deposited drift lines on germination and establishment of species at sites differing in management, two-factorial ANOVAs with the factor drift line nested in the factor management were carried out with the total number of seedlings and species. Additionally, comparable analyses were used to test whether the number of seedlings of the three most common species, was affected by drift line deposition and management. The numbers of seedlings of these species were square root transformed to fulfil the ANOVA-assumptions.

To compare species composition of emerged seedlings of the single plots of the investigation with naturally deposited drift lines, we used a Nonmetric Multidimensional Scaling (NMS). The NMS was accomplished with two dimensions using standard starting configurations of Statistica 6.1 and 15 iterations in the final solution. To test, whether plots differed significantly in the diagram, we performed a two-factorial ANOVA on the axis-scores of the NMS.

The effect of time on the mean number of emerging seedlings and species in the investigation of “aging” of drift lines was tested with linear regressions after $\log_{10}(x)$ transformation of the independent variable (date of recollection).

Effects of the factors drift-litter addition and disturbance on seedling emergence were analysed using two-way ANOVAs with $\ln(x+1)$ transformed sums of seedlings and species to fulfil the ANOVA-assumptions.

RESULTS

Germination trial with drift-litter

About 2100 seedlings with a mean of 14 (± 15 , standard deviation) seedlings per sample (1 l drift line material) germinated from the drift line samples (Appendix). The total number of species was 37 (and six further taxa, which could not be identified up to species level). The

species composition of the drift line samples differed significantly with respect to sampling site (Fig. 2; Kruskal-Wallis tests: axis 1: $H = 63.56$, $p < 0.001$; axis 2: $H = 37.49$, $p < 0.001$).

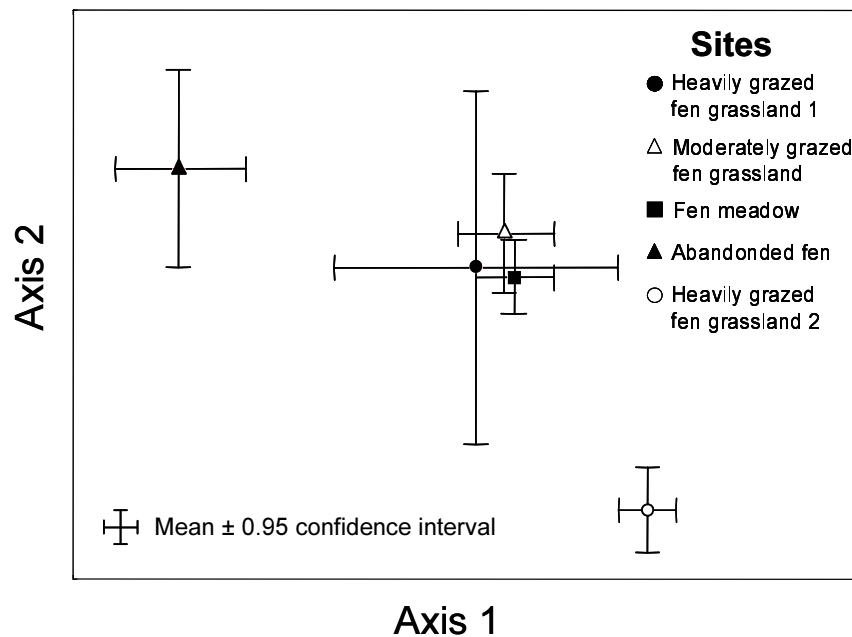

Figure 2. Comparison of drift line samples from different sampling sites with respect to species composition (Nonmetric multidimensional Scaling).

The most common species at the abandoned site was *Lycopus europaeus* (~80% of the total number of seedlings recruited at this site), while it was *Ranunculus repens* for the moderately grazed fen grassland (~55%) and one of the heavily grazed fen grasslands (~66%). The most common species at the other heavily grazed fen grassland site as well as for the fen meadow was *Rumex obtusifolius* vel *crispus* (with ~37% respectively ~41%). *Scrophularia umbrosa* was the only regionally endangered species which emerged from the drift line material.

Effects of naturally deposited drift lines on germination and establishment

In total about 4800 seedlings of 28 species and further taxa were registered (~ 200 seedlings/m²; see Appendix for species list) on the 24 one m² plots. The most common species were *Galium palustre* (31%), *Urtica dioica* (20%) and *Ranunculus repens* (16%). The occurrence of drift litter significantly increased the number of seedlings recruited both in abandoned and grazed sites (Tab. 1, Fig. 3). This was also the case for the number of species.

Table 1. Effects of naturally deposited drift lines on germination and establishment: Effects of management (moderate grazing, abandonment) and occurrence of drift line (yes, no) on the number of seedlings and species, on the total number of seedlings of *Galium palustre*, *Urtica dioica* and *Ranunculus repens* and on species composition of the analysed plots. Results of nested two-factorial ANOVAS are shown. Numbers of seedlings of the single species were square root transformed.

Effects	FG	MQ	F	p
<i>Total no. of seedlings</i>				
Management	1	4056	0.16	n.s.
Drift line (Management)	2	122907	4.77	< 0.05
Error	20	25750		
<i>Total no. of species</i>				
Management	1	26.042	5.71	< 0.05
Drift line (Management)	2	54.21	11.89	< 0.001
Error	20	4.56		
<i>No. of seedlings of Galium palustre</i>				
Management	1	5.85	0.24	n.s.
Drift line (Management)	2	30.52	1.25	n.s.
Error	20	24.46		
<i>No. of seedlings of Urtica dioica</i>				
Management	1	602.04	35.63	< 0.001
Drift line (Management)	2	25.35	1.50	n.s.
Error	20	16.89		
<i>No. of seedlings of Ranunculus repens</i>				
Management	1	63.95	8.89	< 0.01
Drift line (Management)	2	77.46	10.77	< 0.001
Error	20	7.19		
<i>Species composition (NMS axis scores, axis 1)</i>				
Management	1	5.61	13.22	< 0.01
Drift line (Management)	2	0.14	0.33	n.s.
Error	20	0.42		
<i>Species composition (NMS axis scores, axis 2)</i>				
Management	1	1.03	2.67	n.s.
Drift line (Management)	2	0.42	1.09	n.s.
Error	20	0.39		

The number of species emerging was significantly higher in moderate grazed plots than in abandoned plots (Tab. 1, Fig. 3). Seedlings of *Urtica dioica* occurred significantly more often in plots at the abandoned site independent of drift line, while seedlings of *Ranunculus repens* occurred significantly more often in plots at the grazed site with drift line (Tab. 1). No effects of naturally deposited drift lines and management were found for the numbers of seedlings of *Galium palustre* (Tab. 1). Plots of abandoned and moderately grazed areas

differed significantly regarding species composition of seedlings (Fig. 4; Tab. 1), while no clear effects of drift line were observed (Fig. 4, Tab. 1).

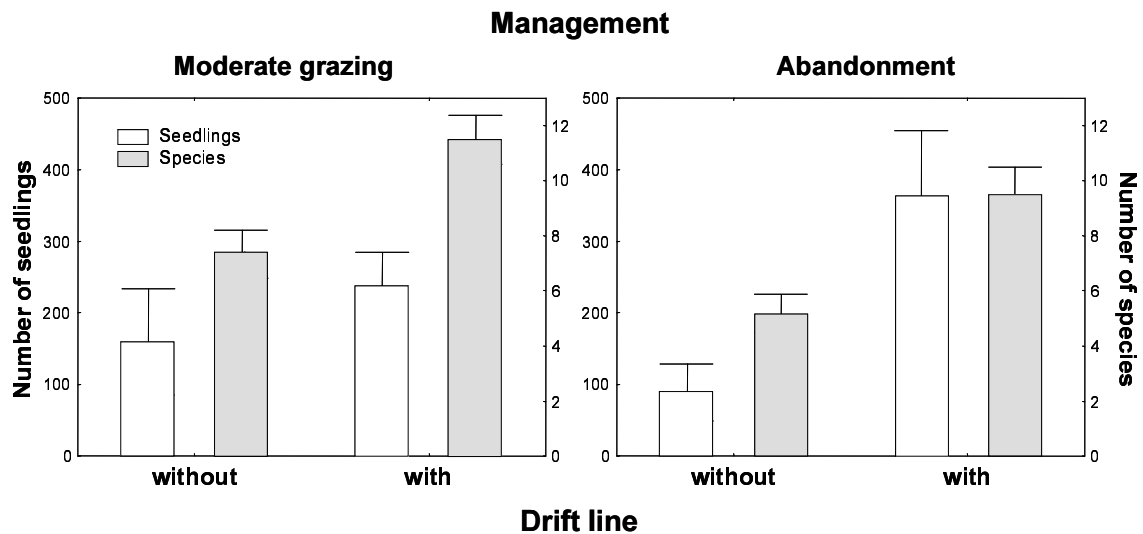

Figure 3. Effects of naturally deposited drift lines on germination and establishment: Number of seedlings and species germinated from plots with and without naturally deposited drift lines differing in management (moderate grazing, abandonment). Mean and standard error are shown.

“Aging” of drift lines

About 2500 seedlings of 42 species and further taxa emerged from the drift line samples of different “age” (see Appendix for species list). The most common species were *Lycopus europaeus* (25%), *Rumex crispus vel obtusifolius* (21%) and *Berula erecta* (19%).

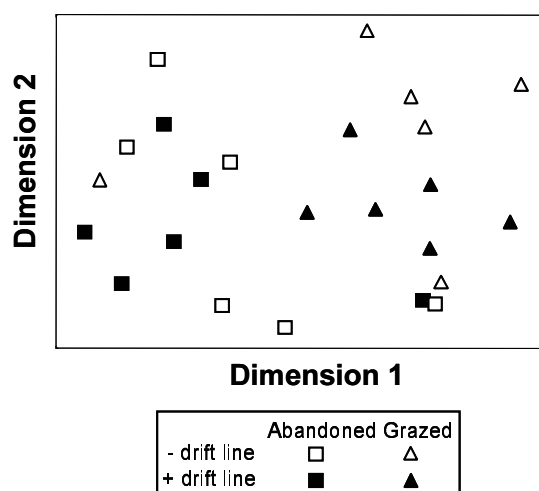

Figure 4. Analysis of the effects of naturally deposited drift lines on germination and establishment: Comparison of seedlings emerged from plots with and without drift line at grazed and abandoned plots regarding species composition: NMS results.

The number of seedlings was reduced to about 55% compared to the freshly deposited drift line material already after two weeks. In the following three weeks no further reduction in the number of seedlings was observed. For the number of species no such tendencies were observed. These observations could be proved statistically as well: we found a weak but significant relation between the time before recollection and the mean number of seedlings emerging from the samples ($n = 6$; $r = -0.8379$, $p < 0.05$; Fig. 5). For the mean number of species no significant relation was observed (data not shown).

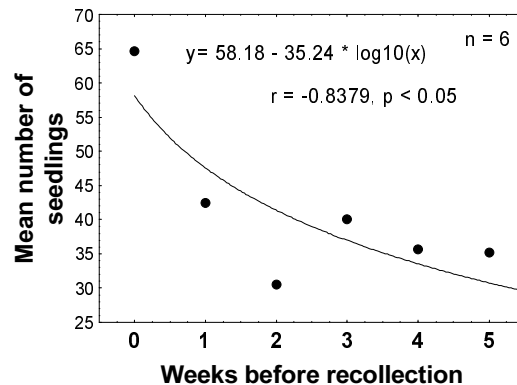

Figure 5. Linear regression of the mean number of seedlings emerged from recollected drift line samples on the time before recollection (investigation of “aging” of drift lines).

Experimental disturbance, drift litter addition and seedling emergence

The addition of drift line material had significant negative effects both on the number of seedlings and species, while the number of seedlings and species significantly increased with increasing disturbance intensity (Tab. 2, Fig. 6). The interaction of both factors was only significant for the number of seedlings (Tab. 2). From about 3500 seedlings of 19 species and further taxa registered in the field experiment only about 400 seedlings germinated in plots with drift line material. The average seedling density in plots without disturbance was with 75 and 90 seedlings/m² similar for plots with and without drift line material. Seedlings recruitment increased with increasing disturbance intensity up to an average of ~ 6 500 seedlings/m² without and 500 seedlings/m² with drift line material at plots with large gaps.

DISCUSSION

Seed content of riparian drift line material is usually high (McAtee 1925, Stopp 1956, Nilsson & Grelsson 1990). However, an essential part of the species occurring in drift lines might be only occasionally transported and deposited and their propagules might already have lost their germination ability during the waterborne transport. Studies analysing species

Table 2. Effects of drift litter and disturbance on the number of seedlings and species. Results of two-factorial ANOVAs.

Effect	FG	MQ	F	p
<i>No. of seedlings</i>				
Drift litter	1	43.77	52.45	< 0.001
Disturbance	3	30.27	36.27	< 0.001
Drift litter*Disturbance	3	4.65	5.58	< 0.01
Error	56	0.83		
<i>No. of species</i>				
Drift litter	1	3.05	11.15	< 0.01
Disturbance	3	4.76	17.39	< 0.001
Drift litter*Disturbance	3	0.60	2.21	n.s.
Error	56	0.27		

content in litter with both visual sorting and germination trials (Katenhusen 2001, Vogt et al. 2006) confirm this assumption. For the present study, we selected the method of germination trials for the analysis of seed content of drift litter, as we were interested in effects of drift litter on species diversity of the vegetation.

Differences in species composition of drift line samples from the regarded sites in the germination trial with drift litter indicate, that seeds deposited with drift litter originated mainly from the nearby surrounding of the deposition area. This argues for seed rearrangement within the area of deposition and not for seed transport over longer distances via river water.

Also the presence of viable propagules of several plant species which usually are not considered to be dispersed via water (e.g. grass species like *Poa trivialis*) confirm this assumption. Though, these species could be transported attached to drift litter material, which can enhance seed buoyancy (e.g. Bonn & Poschlod 1998, Andersson et al. 2000a). The results of the analysis of the effects of naturally exposed drift lines on germination and establishment have shown, that drift lines had a positive influence on seedling recruitment. This could argue for the role of drift litter as seed source, though this effect could not be observed for all species (e.g. for *Galium palustre*, the most common species). For other species even the effect of current management of the sites seemed to be predominant compared to the presence of drift litter (e.g. for *Urtica dioica*). Such species could originate from the sites where the drift litter was deposited similar to our assumptions about the origin of seeds in the germination trial (see introduction).

The analysis of "aging" of drift lines revealed that the content of viable seeds in drift litter decreased with time. We suppose two possible reasons for this decrease: I. transfer of seeds to the soil seed bank and II. seed mortality. Seeds deposited with drift lines can either germinate and establish in case of fitting site conditions or be incorporated in the soil seed bank via different processes (e.g. bioturbation, gravity or precipitation; e.g. Thompson et al.

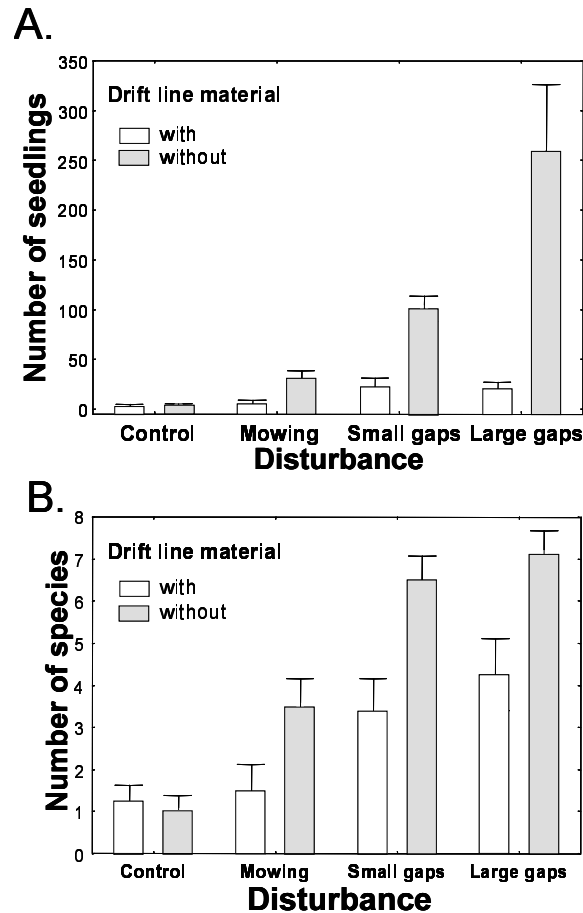

Figure 6. Numbers of seedlings (A.) and species (B.) emerged from plots of a two-factorial field experiment with the factors drift line material (with, without) and disturbance (control, mowing, small gaps, large gaps). Mean and standard error are shown.

1993, Grime 2002) and persist in the seed bank over longer periods of time. Seeds remained in drift lines are exposed to predation and decomposition (Anderson & Sedell 1979, Merritt & Lawson 1979, Petersen et al. 1989). The rapid decomposition of drift litter in riparian ecosystems was observed by e.g. Malanson (1993) and Akanil & Middleton (1997). Moisture together with the concentration of high amounts of organic matter makes drift lines attractive for bacterial and fungal decomposers and predators (see e.g. Facelli & Pickett 1991a, Schafer and Kotanen 2003). Various invertebrate species complete their life cycle in drift lines (Merritt & Lawson 1979) and also birds and small mammals feed on drift litter (Hole 1981). Thus, seeds in drift litter are especially threatened by predation. We observed a reduction of the number of viable seeds in drift litter in the first two weeks after the deposition. This reduces the function of drift lines as seed source, especially considering the temporal postponement of the deposition (regular floods in winter) and climatic conditions favourable for germination of most species (April - May). Whether or not some seed had

been transferred to the soil seed bank via the abovementioned processes remains unclear and needs further investigations (compare Kollman 1994).

Several studies in the recent time have shown that germination and establishment of plant species at fen sites might be limited by seed availability and by the availability of gaps (e.g. Kotorová & Lepš 1999, Ramseier 2000, Overbeck et al. 2003). Especially in eutrophic fens with dense grass sods the importance of patches of bare soil and reduced competition for light are prerequisites for seedling recruitment. Our results of the two-factorial field experiment in an abandoned fen grassland dominated by tall-growing herbs and sedges confirmed the major importance of gaps for species recruitment. Here, the vast majority of seedlings germinated out of the soil seed bank in disturbed plots with patches of bare soil. Densities of the soil seed bank and the amount of diaspores in the seed rain in the fen grasslands of the Upper Eider valley were much higher (seedbank: about 15.000 seeds/m², seed rain: 57.000 seeds/m²; Jensen 1998) than the numbers of viable seeds, which were added to the experimental plots with drift litter (about 100 seeds/m², see germination trial with drift litter). We found that the addition of drift material had even negative effects on seedling recruitment as the additional litter layer hampered germination and/or establishment. Negative effects of litter layers on seedling recruitment were also observed by other authors (e.g. Facelli & Pickett 1991b, Xiong et al. 2003, Jensen & Gutekunst 2003). Our results indicate, that the importance of drift litter as seed source might be higher in river systems with a high species diversity and/or a low productivity (low vegetation density) and/or some kind of soil disturbance. Investigations within a species-rich riparian system with natural flooding regime in the Soomaa National Park in Estonia (Wanner & Jensen, unpublished) documented the high potential of drift litter material as seed source (more than 1000 viable seeds per 1 l of drift litter). Their accomplishment of a two-factorial field experiment similar to the one presented in this paper, showed that besides disturbance drift litter addition had a significant positive effect on seedling recruitment. Nilsson & Grelsson (1990) showed that 28% of the propagules found in their drift line samples were absent in the surrounding vegetation. They concluded that drift lines have at least the potential to enhance species diversity at the site where they are deposited.

CONCLUSIONS

We conclude that the role of propagules in drift line for species diversity in riparian landscapes is ambiguous. The occurrence of viable seeds in the drift line material argues for the function of drift lines as seed source, while the rapid decrease of viability of seeds after deposition indicates that drift lines might be unfavourable sites for seed survival and thus

function as seed sink. Compared to seed input via drift litter, the availability of appropriate microsites for germination and establishment as well as the local seed rain were of predominant importance in our study system (comparatively species-poor river valley, strongly altered by human influence). Nevertheless, we hypothesize, that the positive role of drift lines as seed source could predominate negative effects of drift litter in river systems with natural flooding regime and higher species diversity.

Appendix. Total numbers (and frequency) of seedlings germinated from different investigations for analysing riparian drift line material and its influence on species diversity in riparian landscapes.

Species	Investigation: Germination trial with drift-litter		Naturally exposed drift line	"Aging" of drift-lines	Drift litter and disturbance
	Total no. of seedlings	Frequency of species in %	Total no. of seedlings	Total no. of seedlings	Total no. of seedlings
<i>Agrostis stolonifera</i> agg.	59	8.1	.	8	.
<i>Alopecurus geniculatus</i> L.	.	.	.	9	.
<i>Alopecurus pratensis</i> L.	1	0.7	.	.	.
<i>Barbarea vulgaris</i> R. Br.	.	.	.	1	.
<i>Berula erecta</i> (Huds.) Coville	5	1.3	.	483	.
<i>Betula pubescens</i> Ehrh. s.l.	1	0.7	.	.	.
<i>Bidens cernua</i> L.	4	2.7	1	.	.
<i>Cardamine amara</i> L.	.	.	4	.	.
<i>Cardamine pratensis</i> L. s.str.	108	43.0	320	74	4
<i>Cerastium holosteoides</i> Fr.	.	.	.	1	4
<i>Chenopodium album</i> agg.	6	4.0	4	.	.
<i>Cicuta virosa</i> L.	3	1.3	18	.	.
<i>Cirsium arvense</i> (L.) Scop.	.	.	.	1	.
<i>Cirsium oleraceum</i> (L.) Scop.	28	13.4	.	.	2
<i>Cirsium palustre</i> (L.) Scop.	.	.	.	1	310
<i>Crataegus monogyna</i> Jacq. s.l.	1	0.7	1	.	.
<i>Epilobium palustre</i> L.	.	.	.	1	.
<i>Eupatorium cannabinum</i> L.	.	.	3	4	.
<i>Filipendula ulmaria</i> (L.) Maxim.	.	.	5	3	.
<i>Galeopsis tetrahit</i> L.	2	1.3	84	.	1
<i>Galium aparine</i> L.	9
<i>Galium palustre</i> L. s.l.	15	9.4	1565	26	1
<i>Glyceria fluitans</i> (L.) R. Br.	2	1.3	.	.	.
<i>Glyceria maxima</i> (Hartm.) Holmb.	2	1.3	.	.	.
<i>Gnaphalium uliginosum</i> L.	.	.	.	1	.
<i>Holcus lanatus</i> L.	3	2.0	.	5	.
<i>Hydrocotyle vulgaris</i> L.	1	0.7	.	.	.
<i>Hypochaeris radicata</i> L.	1	0.7	.	.	.
<i>Iris pseudacorus</i> L.	.	.	.	1	.
<i>Juncus effusus</i> L.	.	.	.	5	.
<i>Lolium perenne</i> L.	1	0.7	.	2	.
<i>Lotus pedunculatus</i> Cav.	.	.	.	1	.
<i>Lycopus europaeus</i> L.	305	51.7	88	609	1
<i>Lysimachia vulgaris</i> L.	.	.	31	.	.
<i>Lythrum salicaria</i> L.	.	.	1	.	.
<i>Mentha aquatica</i> L.	23	12.1	93	61	.
<i>Mentha arvensis</i> L.	17	6.0	1	.	.
<i>Myosotis scorpioides</i> L.	2	1.3	434	2	.
<i>Persicaria hydropiper</i> (L.) Delarbre	.	.	100	.	.
<i>Phalaris arundinacea</i> (L.)	2	0.7	.	3	.

Appendix. (continued)

Investigation:	Germination trial with drift-litter		Naturally exposed drift line	"Aging" of drift-lines	Drift litter and disturbance
Species	Total no. of seedlings	Frequency of species in %	Total no. of seedlings	Total no. of seedlings	Total no. of seedlings
<i>Plantago lanceolata</i> L.	.	.	1	.	.
<i>Plantago major</i> L. s.l.	2	1.3	.	.	.
<i>Poa trivialis</i> L. s.l.	11	3.4	.	24	14
<i>Prunella vulgaris</i> L.	4	1.3	.	.	.
<i>Ranunculus repens</i> L.	925	59.1	809	29	323
<i>Ranunculus sceleratus</i> L.	40	17.4	.	38	.
<i>Rorippa palustris</i> (L.) Besser	91	14.1	11	.	.
<i>Rumex crispus</i> L.	.	.	.	75	.
<i>Rumex (obtusifolius x crispus)</i>	333	48.3	30	534	.
<i>Rumex acetosa</i> L.	.	.	.	2	29
<i>Rumex acetosella</i> L. s.l.	4	2.7	.	.	.
<i>Rumex hydrolapathum</i> Huds.	5	0.7	.	.	.
<i>Rumex obtusifolius</i> L.	.	.	.	58	18
<i>Sagina apetala</i> agg.	.	.	.	1	.
<i>Scirpus sylvaticus</i> L.	1	0.7	.	.	.
<i>Scrophularia umbrosa</i> Dumort.	2	1.3	.	.	.
<i>Scutellaria galericulata</i> L.	.	.	.	41	.
<i>Senecio vulgaris</i> L.	10	5.4	.	5	.
<i>Silene flos-cuculi</i> (L.) Clairv.	.	.	4	1	.
<i>Sonchus asper</i> (L.) Hill	.	.	.	49	.
<i>Sonchus oleraceus</i> L.	.	.	.	6	.
<i>Stachys palustris</i> L.	1	0.7	.	7	.
<i>Stellaria alsine</i> Grimm	.	.	.	2	1
<i>Stellaria media</i> agg.	.	.	47	.	.
<i>Taraxacum officinale</i> agg.	13	6.7	1	23	2
<i>Urtica dioica</i> L. s.l.	44	9.4	1031	38	503
<i>Valeriana officinalis</i> agg.	.	.	.	4	.
<i>Veronica beccabunga</i> L.	.	.	115	.	2
<i>Veronica montana</i> L.	.	.	.	1	.
<i>Brassica</i> spec.	10	4.7	.	.	.
<i>Carex</i> spec.	3	1.3	.	.	4
<i>Cirsium</i> spec.	.	.	25	.	.
<i>Epilobium</i> spec.	.	.	10	.	486
<i>Potentilla</i> spec.	2	1.3	.	.	.
<i>Rumex</i> spec.	32
<i>Salix</i> spec.	2	1.3	.	10	.
<i>Veronica</i> spec.	2	1.3	.	.	.
unknown dicotylous seedlings	550
unknown monotylous seedlings	1269
unknown	4	2.7	.	277	.
Total no.	2101		4837	2527	3565

Plate III



Picture 5. Summer flood at the Upper Eider River in August 2002.



Picture 6. Seed-rich drift litter at the Upper Eider River in March 2002.

Seed deposition in drift lines during an extreme flooding event – evidence for hydrochorous dispersal?

INTRODUCTION

Although seed dispersal via running water is known as an important factor for plant populations occurring near rivers (e.g. Andersson et al. 2000b, Goodson et al. 2001) it is usually confined to the river bed and the nearby surroundings. However, Schwabe (1991) found seedlings of plant species which are usually absent from floodplains in samples of freshly deposited riverbank sediments following an extreme flooding event. These species came from arable fields, grasslands and other habitats near the floodplain. Also Hughes & Cass (1997) found more than 20 herbaceous species in flood debris which did not occur in their studied habitat. Thus, hydrochory can give even terrestrial plant species an opportunity to expand their range rapidly, providing that safe sites are reached (e.g. Pyšek & Prach 1994 for invasive species, Boedeltje et al. 2003).

Today, almost all of Europe's large floodplains are altered due to river straightening and the construction of dykes. These landscape changes have reduced the area of characteristic floodplain plant communities during the last decades and have led to an increasing level of fragmentation of the remaining habitats. As dykes prevent water-borne seeds from dispersing beyond their walls, hydrochorous seeds cannot disperse among these fragmented habitats during regular flooding events. Extremely rare events of extraordinary floods causing breaching of dykes may increase the chances of seed dispersal by flooding water between otherwise fragmented habitats (compare Nilsson et al. 2005). Following major floods, water-borne seed dispersal may also be of importance for the re-establishment of vegetation in areas which are further away from the river bed. According to the flood pulse concept (e.g.

Junk et al. 1989, Tockner et al. 2000), extreme floods may especially increase long-distance seed dispersal.

In summer 2002 a very large area of approx. 600 km² had been flooded during an extreme flood of the Elbe River. The flood followed an extended cyclone with high precipitation both in the Czech Republic and Eastern Germany. After the flood had declined we collected drift line samples from three habitat types (arable field, floodplain grassland, river bank) at each of five different locations along a 400 km transect at mid-river. Using multivariate statistics, we compared species composition of drift line samples of the different habitats and locations with those of the principal vegetation types occurring in the floodplain. The main aim of the present study is to analyse long- and short-distance seed dispersal and seed re-arrangement during extreme flooding events. We define "long-distance seed dispersal" as a transport of seeds between the studied locations, which were separated from each other by at least 70 kilometres. "Short-distance dispersal" is defined as seed transport between habitats within these locations (less than one kilometre), whereas seed movement within a single habitat is considered as "seed re-arrangement". Furthermore, the importance of species traits for hydrochorous seed dispersal was evaluated by comparing the relative proportion of species with specific traits in drift line samples and the vegetation. At the end of the paper, mortality factors affecting water-transported seeds and the relevance of extreme flooding events for nature conservation and restoration are discussed.

METHODS

Study site

The Elbe River is 1090 km long, has a catchment area of about 148,000 km² and a mean discharge of 327 m³/s in Dresden (up to 4580 m³/s during flooding in summer 2002). It originates in the Erz Mountains in the Czech Republic (at 1393 m a.s.l.). The flooding duration in the recent floodplains lasts for about 35 days per year. During regular flooding the dyked floodplains are inundated only through subirrigation via groundwater as they are hydrologically disconnected from surface waters of the river (so-called "fossil floodplains"). Although approx. 80% of the floodplains of the Elbe River are affected by dyking and weirs, the Middle and Lower Elbe River is moderately regulated in comparison to other streams in Germany and its flood dynamic is hardly restricted (IKSE 1999).

In summer 2002 an extended cyclone caused unusual high precipitation in the Erz Mountains in the Czech Republic and Eastern Germany. This led to water levels up to 9.5 m higher than average of the Elbe and its tributaries. Many dykes did not withstand the enormous water volumes (BfG 2002). We studied seed dispersal following this flood by

collecting drift line material at five different locations at the river along a transect of approx. 400 km. Location I was located at Nünchritz near Riesa (Saxony; Figure 1), location II near the Elster/Elbe-confluence (Saxony-Anhalt), location III at Dornburg near Magdeburg (Saxony-Anhalt), location IV at the Havel/Elbe-confluence (Saxony-Anhalt), and location V at Privelack (Lower Saxony).

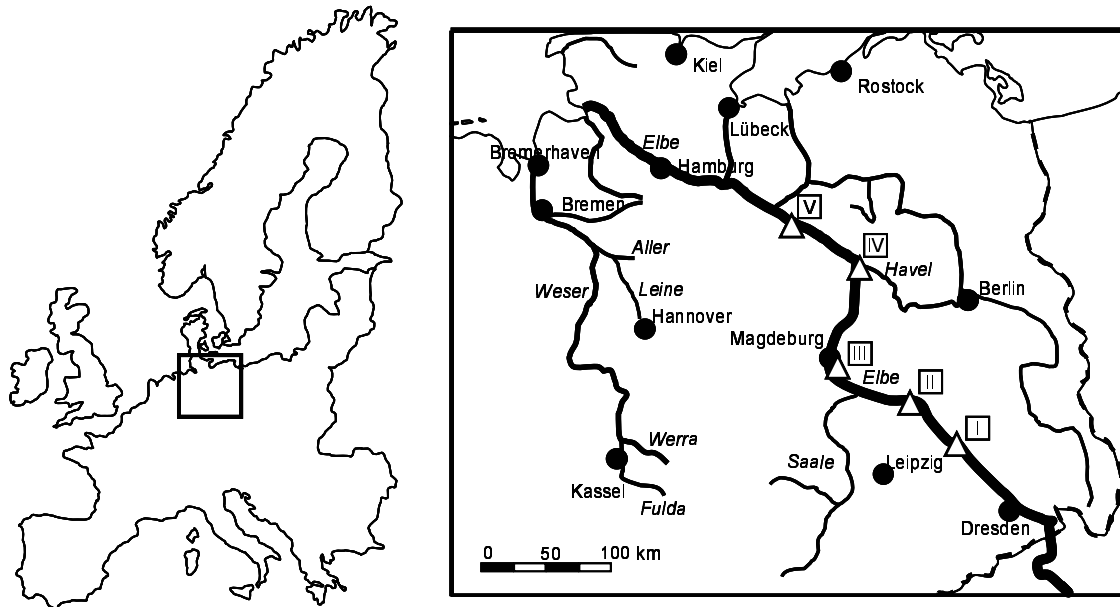

Figure 1. Geographical location of the study sites at the Middle Elbe River: samples of drift line material were collected in September 2002 at the five marked locations after the heavy Elbe flood declined. Location I: Nünchritz near Riesa (Saxony); location II: near Elster/Elbe-confluence (Saxony-Anhalt); location III: Dornburg near Magdeburg (Saxony-Anhalt); location IV: Havel/Elbe-confluence (Saxony-Anhalt); location V: Privelack (Lower Saxony).

Sampling

At each location, we took samples of drift line material (1.5 l each; three replicates) from three different habitats which had been flooded until approx. 14 days before sampling: (i) the river bank of the Elbe, (ii) an arable field and (iii) a floodplain grassland. At location V (Privelack) only samples of the river bank and floodplain grassland were collected, because no suitable arable field was available.

Arable fields and floodplain grasslands sampled at locations I-IV were situated behind the dykes and can be considered fossil floodplains. At location V the grassland habitat was situated in front of the dyke and thus belonged to the recent floodplain, which is regularly flooded also during moderate floodings.

During summer 2002 arable fields and floodplain grasslands of location I-III were flooded as a consequence of breaching dykes, while near location IV and V no breaching of the

dykes occurred. Thus the fossil floodplain grassland and arable field at location IV were not flooded by river water but by subirrigation via groundwater, while the recent floodplain grassland at location V was flooded by river water.

Seedling emergence and seed separation from drift line samples

Approx. 1 l of each drift line sample was exposed in plastic trays with sterilized soil in an experimental garden for germination. A translucent gauze was used to prevent external seed input. Emerging seedlings were counted and identified regularly over a period of one year.

The remaining drift line material (about 0.5 l per sample) of the three replicates was combined to form one bulk sample. This was dried at 40 °C until constant weight was reached. The dried samples were divided into two fractions using a 2 mm mesh sieve. Ten grams dry weight of the coarse fraction and one gram dry weight of the fine fraction of each bulk sample were scanned for seeds under a dissecting microscope. Only generative dispersules of vascular plants were considered. During identification all seeds were differentiated into externally intact seeds and seed fragments.

The nomenclature of species follows Wisskirchen & Haeupler (1998).

Relation between floodplain vegetation and species composition of drift line samples

Species composition of the drift line samples was compared with those of vegetation relevés (Hellwig 2000, Baufeld et al. 2001 and Leyer 2002) from the floodplain of the Middle Elbe River. Although the vegetation relevés did not originate from the same locations at which the drift material was collected, they represent the principle vegetation communities of the Middle Elbe floodplain. We considered relevés from arable fields (n=7), therophyte-rich pioneer communities of river banks (n=17), reeds and sedge swamps (n=94) and different forage grassland types (hay and litter meadows, n=108; see Ellenberg 1988 for more details).

Furthermore, drift line samples and vegetation relevés were compared with respect to species traits (seed dispersal type, seed buoyancy and Ellenbergs moisture values [EMV]; Grime et al. 1988, Ellenberg 2001, Boedeltje et al. 2003, Boedeltje et al. 2004). For this purpose, the percentage of species belonging to each particular category of these traits was calculated for all drift line samples and vegetation relevés. For seed dispersal, the categories hydrochory, anemochory and exozoochory were considered as they are supposed to be relevant for hydrochorous seed dispersal (e.g. Ridley 1930). Species classified to more than one of these three categories were counted once for the category that was mentioned first. Seed buoyancy was described by four categories based on t_{50} , i.e. the period (in days) after which 50% of the seeds had sunk (< 1, 1 - < 10, 10 - < 100 and > 100). To simplify matters,

EMV's were grouped to 5 categories combining original EMV 2 & 3, 4 & 5, 6 & 7, 8 & 9 and 10 & 11, respectively. Species lacking classifications of these traits were not considered in further analyses.

Statistical analysis

We analysed whether the number of habitat-specific species differed between the drift line samples. For this purpose, species of the *Bidentetea* (Bur Marigold mud banks; BI) and *Phragmitetea* (Reeds and Tall Sedge swamp; PH) were considered to be habitat-specific for river banks, species of the *Molinio-Arrhenatheretea* (forage grasslands; MA) to be habitat-specific for floodplain grasslands and species of *Stellarietea mediae* (arable weeds; SM) as well as crop species to be habitat-specific for arable fields (see Ellenberg 1988 for description of classes).

Non-parametric tests (Kruskal-Wallis-test / Mann-Whitney U-test) were used to analyse whether drift samples differed (i) in total species number and the number of seeds/seedlings, (ii) in the number of seedlings of single species, and (iii) in the number of habitat-specific species and/or seeds/seedlings. Furthermore, overall differences in species composition of seedlings and seeds/fragments found in the samples were examined by Nonmetric Multidimensional Scaling (NMS), which is well suited for data sets that are nonnormal or on arbitrary or discontinuous scales (McCune & Grace 2002). To create distance-matrices for analysing differences in species composition of seedlings and seeds/fragments, the Jaccard distance was calculated. The NMS was accomplished with two dimensions using Guttman-Lingoes starting configurations. Considering the differences in species composition of seedlings, 16 iterations were used in the final solution, while 19 iterations were used considering differences in species composition between seeds and seed fragments and 44 iterations considering the differences in species composition between seedlings, seeds and seed fragments. To test whether species composition of the samples significantly differed between locations and/or habitats and between seedlings, seeds and seed fragments, non-parametric tests (Kruskal-Wallis-tests, pairwise Mann-Whitney U-tests) were carried out using the axis scores of the NMS's.

Afterwards, a power test based on axis scores of the NMS was calculated to test, whether differences in species composition between habitats and/or locations could have been overlooked. Power values of at least 0.8 were interpreted as evidence supporting the alternative hypothesis (i.e. no differences between habitat types and locations, respectively).

To analyse differences in species composition of drift line samples and vegetation relevés a further NMS was carried out. In order to avoid large distances between drift line samples and vegetation relevés as a result of higher species numbers in the vegetation

relevés, all species of drift line samples were considered, while species of vegetation relevés, which occurred in less than 15 % of each habitat (“uncommon species”) were excluded from the analysis. After transforming the dataset using Beals Smoothing (McCune 1994), the NMS was accomplished with two dimensions using Euclidean distance measure. Ten iterations were used in the final solution. To test whether there were significant differences between species composition of drift line samples and vegetation relevés nonparametric tests (Kruskal-Wallis-tests) were carried out based on the axis scores of the NMS. For testing which habitats and locations differed significantly pairwise Mann-Whitney U-tests were used on axis scores.

Frequency distributions of species traits (dispersal type, seed buoyancy and Ellenberg’s moisture values) in drift line samples and vegetation relevés were compared by Kruskal-Wallis- and Mann-Whitney U-tests.

Statistica 6.1 (Statsoft Inc 2003) was used for all statistical analyses except for the NMS regarding species composition of the drift line samples and the vegetation relevés, which was performed using PC-ORD (McCune & Mefford 1999).

For all ordination techniques, the data sets were transformed to presence/absence data (1/0 matrices). For pairwise statistical analyses (Mann-Whitney U-tests) p-values were Bonferroni-adjusted. For all other analyses p-values < 0.05 were considered to be significant.

RESULTS

Seedling emergence from drift line samples

A total of 1594 seedlings of 72 species and 18 further taxa, which could not be determined to species level, emerged from the samples (Appendix 1). The mean number of seedlings per 1 l sample was 32 ± 5 (standard error). The most common species were *Deschampsia cespitosa*, *Urtica dioica*, *Ranunculus repens* and *Lycopus europaeus* with 12.6, 9.1, 5.8 and 5.5 % of the total number of emerged seedlings, respectively. There were neither significant differences between the five locations nor between the three habitat types concerning overall seedling and species number. *Echinochloa crus-galli* and *Triticum aestivum* were significantly associated with arable fields (Kruskal-Wallis-test: $H = 10.52$, $p < 0.01$ and $H = 13.95$, $p < 0.001$, respectively).

Considering species composition of drift line material, there were only marginal differences between the three habitats and locations (Fig. 2). The results of the Kruskal-Wallis-test on axis scores showed that habitats did not differ significantly according to neither 1st nor 2nd NMS axis, but that locations differed according to the second dimension ($H = 25.06$, $p < 0.001$; for further details see Table 1). Samples of location IV and V are separated

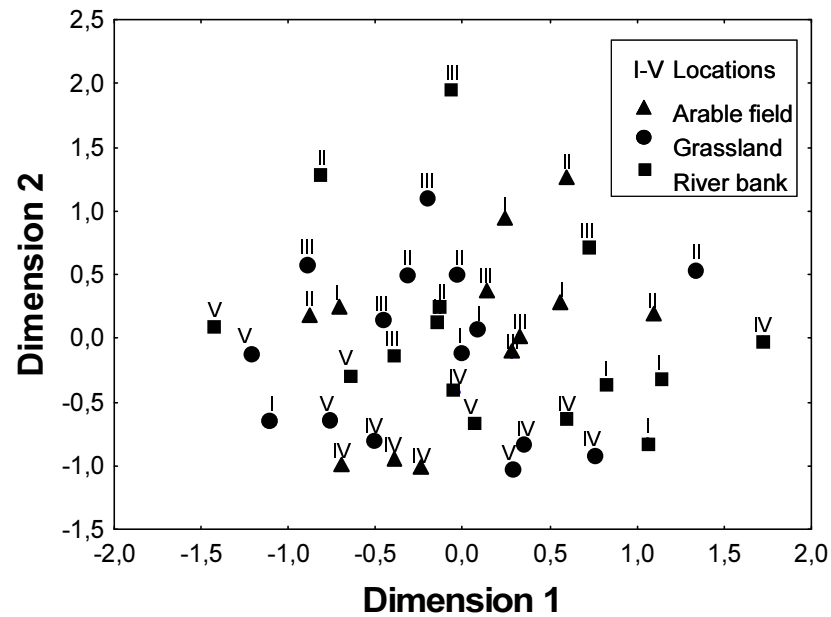

Figure 2. Comparison of species composition of seedlings which emerged from drift line samples (Nonmetric Multidimensional Scaling = NMS). The three different habitat types are marked by different symbols. The five locations are indicated by Roman numerals (compare Fig. 1). Each sample is represented by one dot.

from the others in the ordination diagram along the 2nd axis (Fig. 2). It can also be seen that location V is less different from locations I to III than location IV (see Tab. 1).

Table 1. Comparison of species composition of drift line samples from different locations: pairwise Mann-Whitney U-tests on NMS (Nonmetric Multidimensional Scaling) -axis-scores (significant p-value following Bonferroni adjustment < 0.005).

Location	U	p*
I - II	14	n.s.
I - III	20	n.s.
I - IV	9	n.s. (< 0.01)
I - V	17	n.s.
II - III	35	n.s.
II - IV	0	< 0.001
II - V	0	< 0.005
III - IV	2	< 0.001
III - V	5	n.s. (< 0.01)
IV - V	15	n.s.

The differences in species composition between samples of different locations are mainly caused by *Filipendula ulmaria* ($H = 15.83$, $p < 0.01$), *Valerianella locusta* ($H = 23.54$, $p < 0.001$) and *Agrostis stolonifera* ($H = 15.03$, $p < 0.01$). *Valerianella locusta* was significantly more frequent at location IV than at location II ($U = 6.5$; $p < 0.005$) and location V ($U = 0.0$; p

< 0.001). *Agrostis stolonifera* occurred exclusively at location IV and V, and *Filipendula ulmaria* at location I and II.

Supposing that the 1st axis corresponds to the habitats and the 2nd axis corresponds to the locations a power analysis revealed that the power of the Kruskal-Wallis-tests was sufficient for “grasslands” (*Power* \approx 0.83) and “riverbanks” (*Power* \approx 0.81) as well as for locations II (*Power* \approx 0.99), III (*Power* \approx 0.99), IV (*Power* \approx 0.999) and V (*Power* \approx 0.93), but not for “arable fields” (*Power* \approx 0.58) and location I (*Power* \approx 0.61).

Considering the occurrence of habitat-specific species, no significant differences in the number of species per group and habitat were found. For the number of seedlings, significant differences between habitats were detected for weed species, which germinated significantly more often from samples of arable fields than from samples of the river bank ($U = 29$; $p < 0.01$).

Seed separation from drift line samples

In total 4659 “intact” seeds and 1660 “seed fragments” (belonging to 106 species and 36 further taxa) were found in the drift line samples (Appendix 1). Based on the fact that the 11 g of drift line material which was scanned for seeds per habitat in average is equal to 10 % of the 1.5 l bulk sample, this is about 2070 ± 930 (standard error) seeds calculated to a sample volume of 1 l. The most common species were *Chenopodium* type *alba* with 45.1%, *Urtica dioica* with 7.1% and *Alnus glutinosa* with 4.3%. Seeds and seed fragments of nine regionally endangered species were found (Appendix 1).

There were pronounced differences in species composition between the detected seeds and seed fragments (NMS; Fig. 3; Kruskal-Wallis-test on axis-scores of the NMS: $H = 16.35$, $p < 0.001$ for dimension 1; $H = 4.09$, $p < 0.05$ for dimension 2). Furthermore, seeds and seed fragments are clearly separated from seedlings (Kruskal-Wallis-test: $H = 49.70$, $p < 0.001$ for dimension 1; Fig. 3).

Based on the calculated number of seeds per litre only 1.5 % of the seeds recruited (32 ± 5 , standard error) in our germination trials. Seed germination rates (and thus presumably also viability) differed strongly between species (e.g., from 0% for *Amaranthus* spec. to 33% for *Ranunculus repens* and *Valerianella locusta*).

Relation between floodplain vegetation and species composition of drift line samples

A NMS revealed that species composition of seedlings occurring in drift line samples differed from that of the vegetation relevés (Fig. 4). The samples of the different habitats were not clearly associated with any of the considered vegetation communities. A Kruskal-Wallis-test on the axis-scores of the NMS revealed significant differences between vegetation relevés

and drift line samples for both axes (axis 1: $H = 50.71$, $p < 0.001$; axis 2: $H = 3.96$, $p < 0.05$). While we found no significant differences between samples of the three habitat types for drift line samples, vegetation relevés of different habitats differed significantly (axis 1: $H = 20.52$, $p < 0.001$; axis 2: $H = 147.44$, $p < 0.001$).

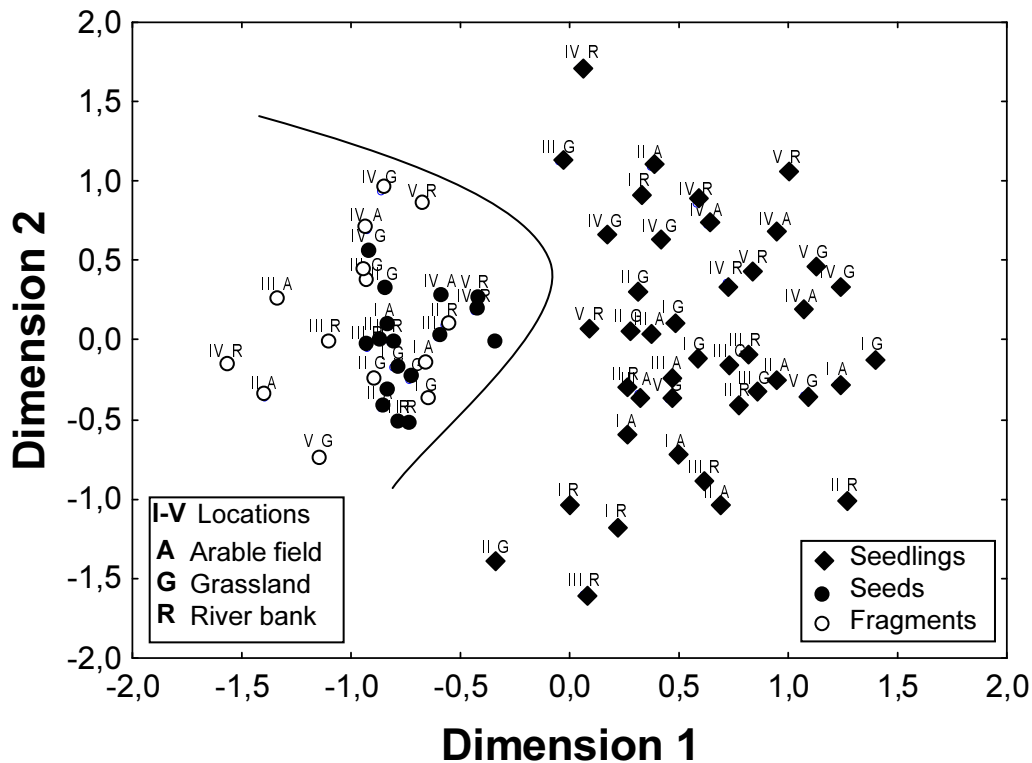

Figure 3. Comparison of species composition (Nonmetric Multidimensional Scaling = NMS) of seeds, seed fragments, and seedlings from drift line material sampled after the Elbe flood in summer 2002.

After Bonferroni adjustment, no significant differences remained between habitats with respect to the analysed plant species traits in drift line samples (Table 2). In contrast, the vegetation relevés of the different habitats differed significantly with respect to all considered species trait categories (Tab. 2). For example, the percentage of species with higher seed buoyancy was significantly higher in vegetation relevés from the river bank than from arable fields or grasslands (Tab. 2). This was also the case for species with hydrochorous seed dispersal and high Ellenberg moisture values (Tab. 2; for more details see Appendix 2).

DISCUSSION

Short- and long-distance dispersal

The fact that some species in the drift line samples were associated with one specific habitat or location argues for seed re-arrangement in the nearby surrounding of the seed

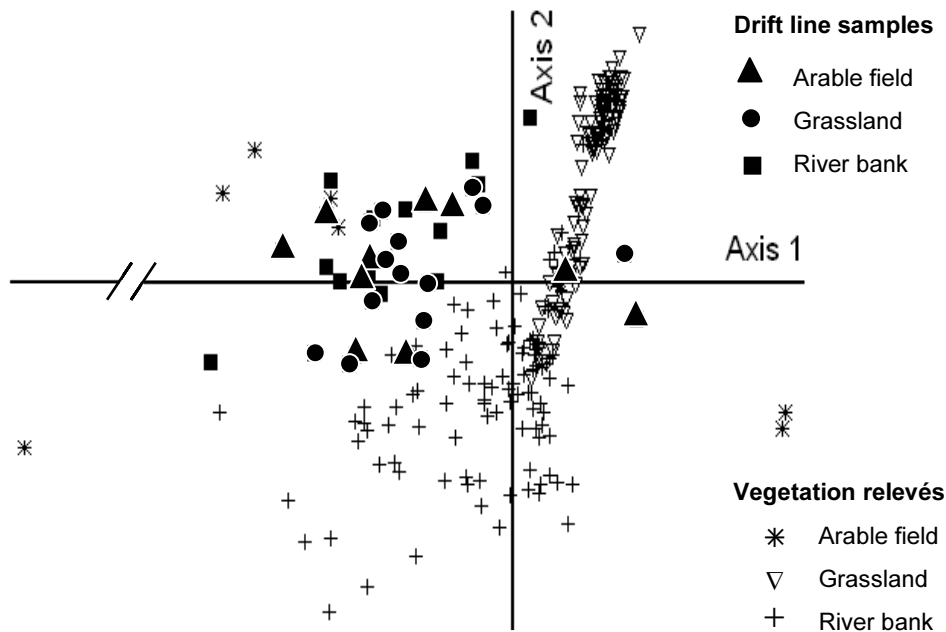

Figure 4. Comparison of species composition (Nonmetric Multidimensional Scaling = NMS) of vegetation (relevés from arable fields (*), floodplain grasslands (∇) and river banks (+)) and drift line-samples (from arable fields (\blacktriangle), floodplain grasslands (\bullet) and river banks (\blacksquare); only emerged seedlings were included). Each drift line sample and vegetation relevé is represented by one dot, respectively.

source or for short-distance dispersal within locations, but does not provide evidence for long-distance dispersal. However, seed re-arrangement within a habitat of a specific location can not explain the origin of seeds of habitat-specific species in drift lines from other habitats (e.g. the occurrence of *Filipendula ulmaria*-seedlings in samples from arable fields or of *Triticum aestivum* in those from floodplain grasslands). Furthermore, no differences between the habitats concerning species composition of drift line samples were found and no association of the drift line samples to the clearly differentiated vegetation types was possible. Power tests indicated that sample size was sufficient to detect differences had they existed. All this argues for (at least) short-distance dispersal between habitats. Hydrochorous short-distance dispersal was also observed by Dierschke (1984), Schwabe (1991) and Brandes (1999).

Considering species composition of the different locations, the separation of locations IV and V from the other locations might be explained by flooding intensity. At locations I, II and III large areas were flooded after dyke breach. To reduce flood intensity and avoid further damage downstreams, water retention areas at the Havel confluence were opened to retain flooding water. As a consequence of this, no dykes broke downstreams at locations IV and V (BfG 2002). Consequently, the fossil floodplain of location IV was flooded via subirrigation

only while the recent floodplain of location V was flooded by river water. The fact that location V and I showed more similarities in species composition than location IV and I could be explained by the presence of seeds in the river water and thus could be seen as evidence for long-distance dispersal. This conclusion must be treated with caution, because the described effect can also be an artefact due to missing drift line samples from arable fields at location V.

It should also be mentioned, that hydrochorous seed dispersal is of course limited to one direction at the scale of the landscape due to water flow, even though Brandes (1999) detected upstream dispersal via currents caused by spur dykes at the Elbe River.

Table 2. Comparison of the three analysed habitat types (arable fields = A, grasslands = G, river banks = R) of drift line samples and vegetation relevés with respect to the percentage of species belonging to different categories of species traits “seed dispersal type”, “seed buoyancy” and “Ellenberg’s moisture value”. Results of non-parametric multiple analyses (Kruskal-Wallis-test) and non-parametric pairwise analyses (Mann-Whitney U-test) are shown. For the Mann-Whitney U-tests a significant effect was considered for $p < 0.017$ after Bonferroni-adjustment: $p < 0.017 = *$. $p < 0.05$ but > 0.017 is not significant but shown here for further discussion labeled as (*). ** = $p < 0.01$; *** = $p < 0.001$.

	Drift line samples		Vegetation relevés		Significant pairwise comparisons	
	H	p	H	p	Drift line samples	Vegetation relevés
Dispersal type						
Anemochory	3.98	n.s.	30.13	***	-	G > R ***
Exozoochory	1.13	n.s.	59.05	***	-	A > R (*); G > R ***
Hydrochory	0.74	n.s.	125.15	***	-	A > R ***; G > A *; G > R ***
Seed buoyancy (t_{50} [d])						
< 1	3.25	n.s.	65.35	***	-	G > R ***
1 - < 10	0.71	n.s.	13.08	**	-	G > A ***; G > R (*); R > A (*)
10 - < 100	0.95	n.s.	64.75	***	-	G > A ***; R > A ***; R > G ***
> 100	0.11	n.s.	34.57	***	-	G > A **; R > A **; R > G ***
Ellenberg moisture values						
2 - 3	0.62	n.s.	56.19	***	-	A > R (*); G > R ***
4 - 5	0.48	n.s.	27.01	***	-	G > R ***
6 - 7	1.17	n.s.	65.60	***	-	A > G *; A > R ***; G > R ***
8 - 9	5.80	n.s.	118.63	***	-	R > A **; R > G ***
10 - 11	6.14	< 0.05	70.54	***	A > R (*)	G > A ***; G > R ***

Effects of species traits on hydrochorous dispersal

Vegetation relevés from river banks contained higher amounts of species with high Ellenberg moisture values, high seed buoyancy and adaptations to hydrochorous seed dispersal than vegetation relevés from floodplain grasslands and arable fields. As riverbanks are regularly flooded also during moderate floods, this overrepresentation of species adapted to hydrochory could be expected. Considering the fact, that we did not find any differences between drift line samples from the investigated habitat types with respect to these plant

traits, there is further support for different origins of seeds within a single drift line sample and for at least short-distance dispersal between habitats.

Many species with low seed buoyancy can be transported via water while being attached to drift line material (e.g. Xiong & Nilsson 1997). As especially during heavy flooding high amounts of drift line material are transported in rivers, seed buoyancy might be of minor importance for hydrochorous seed dispersal during these extreme events.

Seed survival and mortality

The differences between species composition of the seedlings on the one hand and seeds/seed fragments on the other hand as well as between seeds and seed fragments (Fig. 3) might be caused by the selective loss of certain species due to seed mortality during water dispersal. As in the present study, Katenhusen (2001) compared seeds found in samples of drift line material with seedlings germinated from the same samples. He found that only a small part of the seeds deposited in drift lines were still viable. The mechanical erosion during the flood, toxic substances in the water as well as water logging may cause a reduction of the viability of seeds during dispersal. However, according to our knowledge factors leading to mortality during water dispersal have not been analysed so far.

Another explanation for the obvious differences in species composition between seedlings germinating from drift line samples and seeds collected might be that the seeds differ in their requirements of chilling, light and/or moisture conditions, and that only those seeds germinated whose requirements were fulfilled (see also Andersson & Nilsson 2002). Schmitz (2002) analysed germination of different *Amaranthus* and *Chenopodium* species under varying conditions (temperature, light, water) and found that some species (especially neophytes) had specific germination requirements. As we observed high numbers of Chenopodiaceae and Amaranthaceae seeds in the drift line, but hardly any emergence of seedlings of these species, germination requirements of some of these species might not have been fulfilled.

In addition to seed viability, the deposition of seeds at “safe sites” is essential for effective seed dispersal. On the one hand, flooding water may create gaps for germination and establishment and may increase seed availability within gaps (Naiman & Décamps 1997). On the other hand, seeds are mostly deposited at drift lines together with plant litter and other material, while only a few seeds of small-seeded species (mainly *Juncus*) are evenly deposited in an area during flooding (Vogt et al. 2004). As litter layers suppress seed germination, especially of many grassland species (e.g. Jensen & Gutekunst 2003), drift lines may be a “sink-habitat” for germination and establishment of many plant species. Xiong & Nilsson (1997) reported that the negative effects of water-born litter (germination

suppression) outweigh the positive effects (protection from predation, conserving water during dry conditions).

Implications for nature conservation and restoration

The restoration of floodplain vegetation is a major aim of nature conservation at the Middle Elbe River (Middle Elbe Biosphere Reserve). Water-born seed transport during floods is one requirement for successful restoration, provided that seed sources are available upstream within the recent floodplain and that restoration sites are flooded at least occasionally.

As floods with high energy flows mobilize more seeds than floods of low energy (Merritt & Wohl 2002), heavy floods like the Elbe flood in summer 2002, are expected to possess high seed dispersal potentials.

Mitsch et al. (1998) considered hydrochory to be the main mechanism by which species were introduced into a restored wetland site (see also Neff & Baldwin 2005). Nevertheless, in this case, no competing vegetation restricted germination and establishment of the freshly dispersed seeds. Establishment of seeds in dense vegetation is often hampered (e.g. Bischoff 2002) and thus restoration success of regularly flooded grassland sites along rivers might be rather limited by establishment than by seed availability. Here additional restoration measures providing gaps for germination and establishment (e.g. raking, burning, sod cutting) are needed.

We conclude that seeds from different habitats and locations are transported together during heavy flooding and thus flooding might expand the usual dispersal ranges of plant species. Although most seedlings found in drift line samples belonged to common species, some seedlings of rare and endangered species were also found, which further stresses the importance of flooding for nature conservation and restoration.

Appendix 1. Total number of seedlings, seeds and seed fragments from drift line material which was deposited during the heavy Elbe flood in summer 2002. Drift line samples (1.5 l each) were collected from three different habitats (arable fields, floodplain grasslands, river banks) at five locations at the Elbe River between Riesa (Saxony) and Privelack (Lower Saxony). One litre of the drift line material was laid out for germination, while 11 g (dry weight) from the remaining 0.5 l of drift line material (10 g of the coarse and 1 g of the fine fraction after division through a 2 mm meshed sieve) of 15 bulk samples (three different habitats from five locations) were scanned visually. Species which are listed in the Red Data book of the different federal states are marked as follows: * = Saxony; § = Saxony-Anhalt; # = Lower Saxony. Furthermore the species are grouped according to phyto-sociological criteria: BI = Bidentetea, MA = Molinio-Arrhenatheretea, PH = Phragmitetea, SM = Stellarietea mediae, W = woody species; species belonging to other communities were not signed.

Species	Species group		Total no.		Total no.		Species	Species group		Total no.		Total no.	
	seedlings	seeds	seedlings	seeds	seedlings	seeds		seedlings	seeds	seedlings	seeds	seedlings	seeds
<i>Acer platanoides</i> L.	W	3						MA	2				
<i>Achillea millefolium</i> L.	MA	5	1					MA	32				
<i>Aegopodium podagraria</i> L.	MA	22						SM	2	90			11
<i>Agrostis capillaris</i> L.	MA	6						W		3			3
<i>Agrostis stolonifera</i> agg.	MA	31						W		1			
<i>Alchemilla vulgaris</i> agg.	MA	2	1					W		3			1
<i>Alisma plantago-aquatica</i> agg.	PH	1						W		1			
<i>Alnus glutinosa</i> (L.) P. Gaertn.	W	198	57					MA	92	14			20
<i>Alopecurus geniculatus</i> L.	MA	4	4					BI	67	20			4
<i>Alopecurus pratensis</i> L.	MA	4	8					W		2			1
<i>Angelica archangelica</i> L.	MA	2						PH	3	4			1
<i>Anthoxanthum odoratum</i> agg.	MA	2						MA	10				1
<i>Anthriscus sylvestris</i> (L.) Hoffm.	MA	1						MA		10			
<i>Aphanes arvensis</i> L.	SM	6						MA	6	6			1
<i>Arabisopsis thaliana</i> (L.) Heynh.	SM	1						PH	25	13			
<i>Arenaria serpyllifolia</i> agg.	SM	4	1					BI	13	89			16
<i>Arrhenatherum elatius</i> (L.) Beauv. ex Presl & Presl	MA	1	5					MA	31	70			
<i>Avena sativa</i> L.	SM	14	14					PH		1			
<i>Barbarea vulgaris</i> R. Br.	SM	4	2					W	5	76			
<i>Berula erecta</i> (Huds.) Coville	PH	1						W	2	5			
<i>Betula pubescens</i> Ehrh. s. l.	W	8	7					PH	3				1
<i>Bidens cernua</i> L.	BI	1						SM	1				
<i>Bidens frondosa</i> L.	BI	8	14					SM		1			
<i>Calamagrostis canescens</i> (Weber) Roth	PH	4	7					SM		1			
<i>Calamagrostis epigejos</i> (L.) Roth	PH	8	7					PH		3			
<i>Calystegia sepium</i> agg.	SM	1						PH		1			
<i>Capsella bursa-pastoris</i> (L.) Med.	SM	1						PH		1			
<i>Carex acuta</i> L.	PH	4						SM		1			
<i>Carex acutiformis</i> Ehrh.	PH	1						PH	8	2			1
<i>Carex canescens</i> L.	PH	1						MA		2			1
<i>Carex cespitosa</i> L. * § #	PH	1	1					SM		82			4
<i>Carex disticha</i> Huds. *	PH	1						MA	2	13			8
<i>Carex hirta</i> L.	MA	2	2					SM	1	10			
<i>Carex otrubae</i> Poep. * §	PH	1						W		3			
<i>Carex paniculata</i> L.	PH	3	4					MA	4				
<i>Carex pseudocyperus</i> L.	PH	4	4					SM		14			1
<i>Carex remota</i> L.	PH	1						SM	35	77			12
<i>Carex riparia</i> Curtis *	PH	3	1					SM	145	331			45
<i>Carex vulpina</i> L. * § #	PH	40	2					SM		2			
<i>Carpinus betulus</i> L.	W	2	5					SM	81	12			
<i>Cerastium holosteoides</i> Fr.	MA	1	4					SM	1				
<i>Cheilidonium majus</i> L.	MA	2	2					SM		22			
<i>Chenopodium album</i> agg.	W	7						MA		1			

Appendix 1. (continued)

Species	Species group	Total no. seedlings	Total no. seeds	Total no. fragments	Species	Species group	Total no. seedlings	Total no. seeds	Total no. fragments
<i>Cicuta virosa</i> L. * \$ #	PH	.	.	1	<i>Vitis vinifera</i> L. s. l.		.	3	.
<i>Cirsium arvense</i> (L.) Scop.	MA	.	2	1	<i>Atriplex patula</i> vel <i>prostrata</i>		.	24	7
<i>Cirsium oleraceum</i> (L.) Scop.	MA	.	11	15	<i>Carex type acuta</i>		23	.	.
<i>Cirsium palustre</i> (L.) Scop.	MA	3	.	.	<i>Carex type paniculata</i>		88	.	.
<i>Cirsium vulgare</i> (Savi.) Ten.		.	1	.	<i>Chenopodium type alba</i>		.	2101	749
<i>Citrullus lanatus</i> (Thunb.) Matsum. & Nakai		3	4	15	<i>Chenopodium type polysperma</i>		.	34	5
<i>Conyza canadensis</i> (L.) Cronquist	W	.	2	2	<i>Rumex acetosa</i> vel <i>thysiflorus</i>		.	18	2
<i>Crataegus monogyna</i> Jack. s. l.		11	5	18	<i>Amaranthus spec.</i>		.	190	43
<i>Cynoglossum officinale</i> L. #	MA	1	.	.	<i>Arctium spec.</i>		.	12	1
<i>Dactylis glomerata</i> agg.	MA	200	52	.	<i>Cardamine spec.</i>		1	65	1
<i>Daucus carota</i> L.	MA	84	.	17	<i>Carex spec.</i>		1	22	21
<i>Deschampsia cespitosa</i> agg.	SM	5	.	.	<i>Centaurea spec.</i>		.	.	1
<i>Echinochloa crus-galli</i> (L.) P. Beauv.		6	.	.	<i>Cirsium spec.</i>		.	.	1
<i>Elymus repens</i> (L.) Gould s. str.		5	.	.	<i>Cuscuta spec.</i>		4	3	.
<i>Epilobium hirsutum</i> L.	MA	1	1	.	<i>Festuca spec.</i>		.	1	.
<i>Epilobium palustre</i> L.	MA	1	1	.	<i>Geleopsis spec.</i>		.	22	2
<i>Epilobium tetragonum</i> subsp. <i>lamyi</i> (Schultz) Nym.	SM	1	.	.	<i>Lamium spec.</i>		.	1	.
<i>Erophila verna</i> agg.	PH	5	1	.	<i>Larix spec.</i>		.	2	6
<i>Eupatorium cannabinum</i> L.	SM	1	.	.	<i>Myosotis spec.</i>		1	1	.
<i>Fallopia convolvulus</i> (L.) A. Löve	MA	6	5	.	<i>Oenothera spec.</i>		7	6	.
<i>Festuca rubra</i> agg.	MA	58	1	1	<i>Papaver spec.</i>		1	2	5
<i>Filipendula ulmaria</i> (L.) Maxim.	W	.	3	.	<i>Poa spec.</i>		1	3	1
<i>Frangula alnus</i> Mill.	W	4	.	.	<i>Potentilla spec.</i>		1	20	8
<i>Fraxinus excelsior</i> L.	W	3	.	.	<i>Prunus spec.</i>	W	1	1	.
<i>Galium aparine</i> agg.	MA	3	27	.	<i>Rosa spec.</i>	W	6	3	5
<i>Galium mollugo</i> agg. *	PH	7	1	.	<i>Rubus spec.</i>		37	64	9
<i>Galium palustre</i> L. s. l.	MA	11	5	.	<i>Salix spec.</i>	W	2	3	30
<i>Heracleum sphondylium</i> L.	MA	18	5	11	<i>Scirpus spec.</i>		1	2	1
<i>Holcus lanatus</i> L.	PH	.	2	.	<i>Stachys spec.</i>		.	21	2
<i>Iris pseudacorus</i> L.	PH	.	3	.	<i>Stellaria spec.</i>		.	2	2
<i>Lapsana communis</i> L.	MA	22	9	48	<i>Tripleurospermum spec.</i>		21	.	.
<i>Leontodon hispidus</i> L.	MA	88	132	59	<i>Thalictrum spec.</i>		1	2	2
<i>Lolium perenne</i> L.	PH	2	4	.	<i>Veronica spec.</i>		1	69	32
<i>Lycopus europaeus</i> L.	PH	1	11	3	<i>Viola spec.</i>		.	.	1
<i>Lysimachia vulgaris</i> L.	PH	31	18	2	<i>Xanthium spec.</i>		23	.	.
<i>Mentha aquatica</i> L.	PH	2	1	.	<i>Apiaceae</i>		58	2	.
<i>Moehringia trinervia</i> (L.) Clairv.	PH	19	1	.	<i>Asteraceae</i>		.	2	.
<i>Myosurus minimus</i> L. * #	PH	2	1	2	<i>Brassicaceae</i>		.	2	.
<i>Oenanthe aquatica</i> (L.) Poir.	PH	1	1	.	<i>Fabaceae</i>		.	2	.
<i>Oxalis acetosella</i> L.	BI	1	65	3	<i>Lamiaceae</i>		.	8	.
<i>Persicaria amphibia</i> (L.) Delarbre	BI	1	7	45	<i>Poaceae</i>		24	.	14
<i>Persicaria hydropiper</i> (L.) Delarbre	PH	5	.	.	unspecified		8	85	186
<i>Persicaria lapathifolia</i> (L.) Delarbre s. l.	MA	9	.	.	Total no.		714	4659	1660
<i>Phalaris arundinacea</i> L.	MA	1	.	.					
<i>Plantago lanceolata</i> L.	MA	1	.	.					
<i>Plantago major</i> L. s. l.	MA	1	.	.					
<i>Poa annua</i> L.	MA	1	.	.					

Appendix 2. Comparison of the three analysed habitats (arable fields, grasslands, river banks) of drift line samples and vegetation relevés with respect to the percentage of species belonging to different categories of species traits “seed dispersal type”, “seed buoyancy” and “Ellenberg’s moisture value”; Detailed results of nonparametric pairwise analyses (Mann-Whitney U-tests).

Species traits	Habitats	Drift line samples		Vegetation relevés	
		U	p*	U	p*
Dispersal type					
Anemochory	A - G	-	-	339.5	n.s.
	A - R	-	-	304.5	n.s.
	G - R	-	-	3463.0	< 0.001
Exozoochory	A - G	-	-	346.5	n.s.
	A - R	-	-	210.5	n.s. (< 0.031)
	G - R	-	-	2444.0	< 0.001
Hydrochory	A - G	-	-	105.0	< 0.017
	A - R	-	-	0.0	< 0.001
	G - R	-	-	987.0	< 0.001
Seed buoyancy (t_{50} [d])					
< 1	A - G	-	-	233.0	n.s.
	A - R	-	-	222.5	n.s.
	G - R	-	-	2296.0	< 0.001
1 - < 10	A - G	-	-	90.0	< 0.001
	A - R	-	-	216.0	n.s. (< 0.049)
	G - R	-	-	4903.5	n.s. (< 0.020)
10 - < 100	A - G	-	-	38.0	< 0.001
	A - R	-	-	20.0	< 0.001
	G - R	-	-	2674.5	< 0.001
> 100	A - G	-	-	108.5	< 0.01
	A - R	-	-	112.0	< 0.01
	G - R	-	-	3661.0	< 0.001
Ellenberg moisture values					
2 - 3	A - G	-	-	358.0	n.s.
	A - R	-	-	203.0	n.s. (< 0.035)
	G - R	-	-	2611.0	< 0.001
4 - 5	A - G	-	-	329.5	n.s.
	A - R	-	-	219.0	n.s.
	G - R	-	-	3613.5	< 0.001
6 - 7	A - G	-	-	163.5	< 0.017
	A - R	-	-	58.5	< 0.001
	G - R	-	-	2455.5	< 0.001
8 - 9	A - G	-	-	319.0	n.s.
	A - R	-	-	108.0	< 0.01
	G - R	-	-	932.5	< 0.001
10 - 11	A - G	53.0	n.s.	86.0	< 0.001
	A - R	47.0	n.s. (< 0.036)	355.0	n.s.
	G - R	91.5	n.s.	2425.0	< 0.001

Plate IV



Picture 7. Drift litter deposited during the heavy Elbe flood in August 2002.



Picture 8. Seedling recruitment at a site affected by flooding of the Middle Elbe River in September 2002.

General conclusions

In this thesis different subprocesses of hydrochorous seed dispersal in river systems were analysed. These subprocesses comprise seed release and entering the water, seed transport in the river, seed deposition with drift lines and alluvial sediments, seed germination and establishment. The results demonstrate that hydrochorous events in temperate river valleys are characterised by a high complexity and a high temporal and spatial variability. Furthermore, it was shown that each of the single subprocesses functioned as “ecological filter” reducing the number of viable seeds and/or seedlings. Thus we conclude that all subprocesses of hydrochory have to be considered for meaningful predictions about the impact of this dispersal process on species diversity of riparian ecosystems and about the importance of hydrochory for the restoration of riparian landscapes.

Seed transport by running water is highly dependent on specific hydrological events (e.g. flooding). Thus, it can be concluded that an increase of frequency and extent of flooding events (e. g. due to rewetting measures) will promote hydrochorous seed dispersal. In addition some species-specific traits (e.g. high seed buoyancy) promote the probability of being transported in the river.

The importance of hydrochory as dispersal mode can be stressed by the fact that seeds of a large amount of species of the riparian vegetation were found transported in the river. Thus, hydrochory may increase species diversity of riparian ecosystems at least at the local scale.

Nevertheless, we found, that most seeds transported with the river water belonged to only a few common or even dominant species of the shore-line vegetation. Additionally, the reduction of seed and/or seedling viability during the single subprocesses of dispersal lead to the conclusion that the impact of hydrochorous seed dispersal on species diversity is restricted, at least in river systems characterized by low flood dynamics due to river management and species poor vegetation.

By an experimental investigation of the effects of seed containing drift line material and disturbance on seedling recruitment it could be shown, that the availability of gaps for germination and establishment was more important for species diversity than the input of

seeds via drift line material. Hydrochory might be of greater importance in river systems with a natural flooding regime or during extreme flooding events. Here, gaps for germination and establishment are created due to the high energy of water-flow and due to the higher frequency, duration and extension of floods, and thus these gaps are available for germination of seeds transported with flooding water. To confirm this assumption studies comparing hydrochory in (semi-)natural river systems with those strongly altered by human impact are recommended. Furthermore the high spatial and temporal variability in seed transport as well as the reduction of viable seeds and/or seedlings during hydrochorous dispersal stresses the necessity of further investigations. Also the question about the distance covered by hydrochorous dispersed seeds in rivers has not been analysed adequately till now.

The fact that seeds of some rare and regionally endangered species were found transported in the river even in the comparatively species poor river system studied in this thesis, shows the potential of hydrochory for restoration projects in riparian ecosystems. Measures promoting the efficiency of hydrochorous dispersal processes (e.g. restoration of natural flood dynamics) should be taken into account for further restoration projects in riparian landscapes.

References

- Akanil, N., Middleton, B. 1997. Leaf litter decomposition along the Porsuk River, Eskisehir, Turkey. *Can. J. Bot.* 75: 1394-1397.
- Anderberg, A.-L. 1994. *Atlas of seeds and small fruits of Northwest-European plant species*. Part 4. Swedish Museum of Natural History, Stockholm, SE.
- Anderson, N.H., Sedell, J.R. 1979. Detritus processing by macroinvertebrates in stream ecosystems. *Ann. Rev. Entomol.* 24: 476-487.
- Andersson, E. & Nilsson, C. 2002. Temporal variation in the drift of plant litter and propagules in a small boreal river. *Freshwat. Biol.* 47: 1674-1684.
- Andersson, E., Nilsson, C. & Johansson, M.E. 2000a. Plant dispersal along boreal rivers and its relation to the riparian flora. *J. Biogeogr.* 27(5): 1095-1106.
- Andersson, E., Nilsson, C. & Johansson, M.E. 2000b. Effects of river fragmentation on plant dispersal and riparian flora. *Reg. Riv.* 16 (1): 83-89.
- Baufeld, R., Pfau, J., Walger, U., Weide, A., Dreetz, H., Wollschläger, A., God, P. & Schellack, A. 2001. BMBF-Projekt „Rückgewinnung von Retentionsflächen und Altauenreaktivierung an der Mittleren Elbe in Sachsen-Anhalt“ (FKZ: 0339576), Teilprojekt 2: Bodenkunde und Ökologie. Teilbereich „Ökologische Auswirkungen/Terrestrische Ökologie“, Teil 2: Vegetation/Flora. Göttingen/Halle (Saale). http://elise.bafg.de/servlet/is/3939/TP_Elbe_Vegetation.pdf.
- Berendse, F., Oomes, M.J.M., Altena, H.J. & Elberse, W.Th. 1992. Experiments on the restoration of species-rich meadows in The Netherlands. *Biol. Conserv.* 62: 59-65.
- Berggren, G. 1969. *Atlas of seeds and small fruits of Northwest-European plant species*. Part 2. Swedish Museum of Natural History, Stockholm, SE.
- Berggren, G. 1981. *Atlas of seeds and small fruits of Northwest-European plant species*. Part 3. Swedish Museum of Natural History, Stockholm, SE.
- Bertsch, K. 1941. *Früchte und Samen – Ein Bestimmungsbuch zur Pflanzenkunde der vorgeschichtlichen Zeit*. Handbuch der praktischen Vorgeschichtsforschung. Band 1. Reinherdt, H. (ed.), Berlin, DE.
- BfG 2002. *Das Augsthochwasser 2002 im Elbegebiet*. Online Publikation: <http://www.bafg.de/html/projekte/hydro/engel/elbe2002.pdf>. Bundesanstalt für Gewässerkunde, Koblenz, DE.
- Bill, H.-C., Poschlod, P., Reich, M. & Plachter, H. 1999. Experiments and observations on seed dispersal by running water in an alpine floodplain. *Bull. Geobot. Inst. ETH* 65: 13-28.

- Bischoff, A. 2002. Dispersal and establishment of floodplain grassland species as limiting factors in restoration. *Biol. Conserv.* 104: 25-33.
- Boedeltje, G., Ter Heerdt, G.N.J. & Bakker, J.P. 2002. Applying the seedling-emergence method under waterlogged conditions to detect the seed bank of aquatic plants in submerged sediments. *Aquatic Botany* 72: 121-128.
- Boedeltje, G., Bakker, J. P., Bekker, R.M., van Groenendael, J. M. & Soesbergen, M. 2003. Plant dispersal in a lowland stream in relation to occurrence and three specific life-history traits of the species in the species pool. *J. Ecol.* 91: 855-866.
- Boedeltje, G., Bakker, J.P., Ten Brinke, A., van Groenendael, J.M. & Soesbergen, M. 2004. Dispersal phenology of hydrochorous plants in relation to discharge, seed release time and buoyancy of seeds: the flood pulse concept supported. *J. Ecol.* 92: 786–796.
- Bonn, S. & Poschlod, P. 1998. *Ausbreitungsbiologie der Pflanzen Mitteleuropas*. Quelle & Meyer, Wiesbaden, DE.
- Bornette, G., Amoros, C. 1996. Disturbance regimes and vegetation dynamics: role of floods in riverine wetlands. *J. Veg. Sci.* 7: 615-622.
- Brandes, D. 1999. Bidentetea-Arten an der mittleren Elbe – Dynamik, räumliche Verbreitung und Soziologie. Species of the class Bidentetea on river banks in the middle course of the river Elbe, Germany – Dynamics, spatial distribution, and community ecology . *Braunschw. Naturkundl. Schr.* 54: 781-809.
- Brouwer, W. & Stählin, A. 1955. *Handbuch der Samenkunde für Landwirtschaft, Gartenbau und Forstwirtschaft*. DLG-Verlags-GMBH, Frankfurt am Main, DE.
- Bunn, S.E., Arthington, A.H. 2002. Basic principles and ecological consequences of altered flow regimes for aquatic biodiversity. *Envir. Manage.* 30(4): 492-507.
- Burkhart, M. 2001. River corridor plants (Stromtalpflanzen) in Central European lowland: a review of a poorly understood plant distribution pattern. *Global Ecol. Biogeogr.* 10: 449-468.
- Cellot, B., Mouillot, F. & Henry, C.P. 1998. Flood drift and propagule bank of aquatic macrophytes in a riverine wetland. *J. Veg. Sci.* 9: 631-640.
- Craddock, C.L. & Huenneke, L.F. 1997. Aquatic seed dispersal and its implications in *Cirsium vinaceum*, a threatened endemic thistle of New Mexico. *Am. Midl. Nat.* 138(1): 215-219.
- Danvind, M. & Nilsson, C. 1997. Seed floating ability and distribution of alpine plants along a northern Swedish river. *J. Veg. Sci.* 8: 271-276.
- Dawson, F.H. & Holland, D. 1999. The distribution in bankside habitats of three alien invasive plants in the U.K. in relation to the development of control strategies. *Hydrobiologia* 415: 193-201.
- Dierschke, H. 1984. Auswirkungen des Frühjahrshochwasser 1981 auf die Ufervegetation im südwestlichen Harzvorland mit besonderer Berücksichtigung kurzlebiger Pioniergesellschaften. - Effects of the spring flooding of 1981 on the river-bank vegetation in the southwestern foothills of

- the Harz mountains, with particular consideration of short-lived pioneer communities. *Braunschw. Naturkundl. Schr.* 21: 19-39.
- Donath, T.W., Hölzel, N. & Otte, A. 2003. The impact of site conditions and seed dispersal on restoration success in alluvial meadows. *Appl. Veg. Sci.* 6: 13-22.
- Edwards, A.L., Wyatt, R. & Sharitz, R.R. 1994. Seed buoyancy and viability of the wetland milkweed *Asclepias perennis* and upland milkweed *Asclepias exaltata*. *Bul. Torrey Bot. Club* 121(2): 160-169.
- Ellenberg, H. 1988. *Vegetation ecology of central Europe*. 4th ed.. University Press, Cambridge, UK. First published in German as "Vegetation Mitteleuropas mit den Alpen". Ulmer, Stuttgart, DE.
- Ellenberg, H. 2001. *Zeigerwerte von Pflanzen in Mitteleuropa*. Goltze, Göttingen, DE.
- Eriksson, O., Cousins, S.A.O. & Bruun, H.H. 2002. Land-use history and fragmentation of traditionally managed grasslands in Scandinavia. *J. Veg. Sci.* 13: 743-748.
- Facelli, J.M., Pickett, S.T.A. 1991a. Plant litter: its dynamics and effects on plant community structure. *Bot. Rev.* 57: 1-32.
- Facelli, J.M., Pickett, S.T.A. 1991b. Plant litter: light interception and effects on an old-field plant community. *Ecology* 72(3): 1024-1031.
- Fitter, A., Peat, H. & Ford, H. 2002. *Ecological Database of the British Isles*. University of York, UK. <http://www.york.ac.uk/res/ecoflora/cfm/ecofl/index.cfm>.
- Flynn, S., Turner, R.M. & Dickie, J.B. 2004. *Seed Information Database* (release 6.0, October 2004). <http://www.rbgekew.org.uk/data/sid>.
- Goodson, J.M., Gurnell, A.M., Angold, P.G. & Morrissey, I.P. 2001. Riparian seed banks: structure, process and implications for riparian management. *Prog. Phys. Geogr.* 25 (3): 301-325.
- Goodson, J.M., Gurnell, A.M., Angold, P.G. & Morrissey, I.P. 2003. Evidence for hydrochory and the deposition of viable seeds with winter flow-deposited sediments: The River Dove, Derbyshire, UK. *River Res. Applic.* 19: 317-334.
- Grime, J.P. 2002. *Plant strategies, vegetation processes, and ecosystem properties*. 2nd ed., repr. Wiley, Chichester [et al.], UK.
- Grime, J.P., Hodgson, J.P. & Hunt, R. 1988. *Comparative plant ecology*. University press, Cambridge, UK.
- Grimm, E.C. 2004. TGView version 2.0.2. Illinois State Museum, Research and Collection Center. Springfield, USA.
- Grootjans, A.P., van Diggelen, R., Everts, H.F., Schipper, P.C., Streefkerk, J., De Vries, N.P.J. & Wierda, A. 1993. Linking ecological patterns to hydrological conditions on various spatial scales: case study of small stream valleys. In: Vos, C.C. & Opdam, P. (eds.) *Landscape ecology of a stressed environment*, pp. 60-77. Chapman & Hall, London [et al.], UK.
- Guppy, H.B. 1891. The river Thames as an agent in plant dispersal. *J. Linn. Soc. London* 29: 333-346.

- Guppy, H.B. 1906. *Observations of a Naturalist in the Pacific between 1896 and 1899*. Vol. 2 : Plant Dispersal. Macmillan & Co, London, UK.
- Hampe, A. 2004. Extensive hydrochory uncouples spatiotemporal patterns of seedfall and seedling recruitment in a "bird-dispersed" riparian tree. *J. Ecol.* 92: 797-807.
- Hanf, M. 1990. *Ackerunkräuter Europas mit ihren Keimlingen und Samen*. Verlagsunion Agrar, München, DE.
- Härdtle, W., Redecker, B., Assmann, T. & Meyer, H. 2006. Vegetation responses to environmental conditions in floodplain grasslands: Prerequisites for preserving plant species diversity. *Basic Appl. Ecol.* 7: 280-288.
- Heinisch, O. 1955. *Samenatlas der wichtigsten Futterpflanzen und ihrer Unkräuter*. Deutsche Akademie der Landwirtschaftswissenschaften, Berlin, DE.
- Hellwig, M. 2000. *Auenregeneration an der Elbe, Untersuchungen zur Syndynamik und Bioindikation von Pflanzengesellschaften an der Unteren Elbe bei Lenzen*. Ph.D.-thesis at the University Hannover, DE.
- Hildebrand, F. 1873. *Die Verbreitungsmittel der Pflanzen*. Engelmann, Leipzig, DE.
- Hole, F.D. 1981. Effects of animals on soil. *Geoderma* 25: 75-112.
- Hughes, J.W. & Cass, W.B. 1997. Pattern and process of a floodplain forest, Vermont, USA: predicted response of vegetation to perturbation. *J. Appl. Ecol.* 34: 594-612.
- Huiskes, A.H., Koutstaal, B.P., Herman, P.M.J., Beefink, W.G., Markusse, M.M. & de Munck, W. 1995. Seed dispersal of halophytes in tidal salt marshes. *J. Ecol.* 83: 559-567.
- IKSE. 1999. *Die Elbe – Erhaltenswertes Kleinod in Europa*. 2nd ed. Internationale Kommission zum Schutz der Elbe (ed.). DE.
- Janzen, D.H. 1971. Seed predation by animals. *Annu. Rev. Ecol. Syst.* 2: 465-492.
- Jensen, K. 1998. Species composition of soil seed bank and seed rain of abandoned wet meadows and their relation to aboveground vegetation. *Flora* 139: 345-359.
- Jensen, K. & Gutekunst, K. 2003. Effects of litter on establishment of grassland plant species: the role of seed size and successional status. *Basic Appl. Ecol.* 4: 579-587.
- Jensen, K., Granke, O., Hoppe, B., Kieckbusch, J., Trepel, M., & Leiner, U. 2001. Weidelandschaft Eidertal - Naturschutz durch extensive Beweidung und Wiedervernässung. *Petermanns Geographische Mitteilungen* 145(1): 38–49.
- Johansson, M.E., Nilsson, C. & Nilsson, E. 1996. Do rivers function as corridors for plant dispersal? *J. Veg. Sci.* 7: 593-598.
- Jongejans, E. & Schippers, P. 1999. Modeling seed dispersal by wind in herbaceous species. *Oikos* 87: 362-372.

- Junk, W.J., Bayley, P.B. & Sparks, R.E. 1989. The flood pulse concept in river-floodplain systems. In: D.P. Dodge (ed.) Proc. Internatl. Large River Symp., 14–21 Sept. 1986, Ontario, Canada, Department of Fisheries and Oceans, Ottawa. *Special publication, Fisheries and Aquatic Sciences* 106: 110–127.
- Katenhusen, O. 2001. Die Ausbreitung von Pflanzen durch Hochwasser in norddeutschen Flusslandschaften. *Z. Ökologie u. Naturschutz* 94(4): 225-236.
- Kiffmann, R. 1960. *Bestimmungsatlas für Sämereien der Wiesen- und Weidepflanzen des mitteleuropäischen Flachlandes*. Teil A und B., Selbstverlag, Freising-Weihenstephan, DE.
- Kleinschmidt, C. & Rosenthal, G. 1995. Samenbankpotential und Diasporenverdriftung in überschwemmten Feuchtwiesen. *Kieler Notizen* 23: 40-44 .
- Kleyer, M. 1995. Biological traits of vascular plants. A database. Arbeitsberichte Inst. f. Landschaftsplanung u. Ökologie Univ. Stuttgart, N.F. Vol. 2.
- Kollmann, J. 1994. *Ausbreitungsökologie endozoochorer Gehölzarten*. Veröffentlichungen Projekt "Angewandte Ökologie", Band 9. Landesanstalt für Umweltschutz Baden-Württemberg, Karlsruhe, DE.
- Kotorová, I., Lepš, J. 1999. Comparative ecology of seedling recruitment in an oligotrophic wet meadow. *J. Veg. Sci.* 10: 175-186.
- Kubitzki, K. & Ziburski, A. 1994. Seed Dispersal in Flood Plain Forests of Amazonia. *Biotropica* 26(1): 30-43.
- Kudoh, H. & Whigham, D.F. 2001. A genetic analysis of hydrologically dispersed seeds of *Hibiscus moscheutos* (Malvaceae). *American J. Bot.* 88: 588-593.
- Lamb, E.G. & Mallik, A.U. 2003. Plant species traits across a riparian-zone/forest ecotone. *J. Veg. Sci.* 14(6): 853-858.
- Leck, M.A. & Simpson, R.L. 1993. Seeds and seedlings of the Hamilton marshes, a Delaware river tidal freshwater wetland. *Proc. Acad. Nat. Sci. Philadelphia* 144: 267-281.
- Leishman, M.R., Wright, I.J., Moles, A.T. & Westoby, M. 2000. The evolutionary ecology of seed size. In: M. Fenner (ed.) *Seeds. The ecology of regeneration in plant communities*. 2nd ed. CABI, Wallingford, UK.
- Leyer, I. 2002. *Auengrünland der Mittel- und Oberrhein-Niederung*. Dissertationes Botanicae 363. Cramer, Berlin [et al.], DE.
- Lundqvist, E. & Andersson, E. 2001. Genetic diversity in populations of plants with different breeding and dispersal strategies in free-flowing boreal river system. *Hereditas* 135: 75-83.
- Malanson, G.P. 1993. *Riparian Landscapes*. Cambridge University Press, Cambridge, UK.

- Marston, R.A., Girel, J.G., Pautou, G., Piegay, H., Bravard, J.-P., Arneson, C. 1995. Channel metamorphosis, floodplain disturbance, and vegetation development: Ain River, France. *Geomorphology* 13: 121-131.
- McAtee, W.L. 1925. Notes on drift, vegetable balls, and aquatic insects as a food product of inland waters. *Ecology* 6(3): 288-302.
- McCune, B. 1994. Improving community analysis with the Beals smoothing function. *Ecoscience* 1: 82-86.
- McCune, B. & Mefford, M.J. 1999. *PC-ORD. Multivariate Analysis of Ecological Data, Version 4*. MjM Software Design, Gleneden Beach, Oregon, USA.
- McCune, B. & Grace, J.B. 2002. *Analysis of Ecological Communities*. MjM Software Design, Gleneden Beach, Oregon, USA.
- McVean, D.N. 1955. Ecology of *Alnus glutinosa* (L.) Gaertn. Part 1 + 2. *J. Ecol.* 43: 46-71.
- Merritt, D.M. & Wohl, E.E. 2002. Processes governing hydrochory along rivers: hydraulics, hydrology, and dispersal phenology. *Ecol. Appl.* 12(4): 1071-1087.
- Merritt, D.M. & Wohl, E.E. 2006. Plant dispersal along rivers fragmented by dams. *Riv. Res. Applic.* 22: 1-26.
- Merritt, R.W., Lawson, D.L. 1979. Leaf litter processing in floodplain and stream communities. In: Johnson, R.R., McCormick, J.F. (eds.) *Strategies for protection and management of floodplain wetlands and other riparian ecosystems*. Proc. Symp. Dec. 11-13, 1978, Callaway Gardens, Georgia. General technical Report WO-12, pp. 93-105. U.S. Department of Agriculture, Forest Service, Washington, D.C., USA.
- Middleton, B.A. 1995. Sampling devices for the measurement of seed rain and hydrochory in rivers. *Bull. Torrey Bot. Club* 122(2): 152-155.
- Middleton, B.A. 1999. *Wetland restoration, flood pulsing, and disturbance dynamics*. J. Wiley & Sons, Inc., New York [et al.], USA.
- Middleton, B.A. 2000. Hydrochory, seed banks, and regeneration dynamics along the landscape boundaries of a forested wetland. *Plant Ecol.* 146: 169-184.
- Middleton, B.A. 2002. *Flood pulsing in wetlands: restoring the natural hydrological balance*. J. Wiley & Sons, Inc., New York, US.
- Mitsch, W.J., Wu, X., Nairn, R.W., Weihe, P.E., Wang, N., Deal, R. & Boucher, C.E. 1998. Creating and restoring wetlands. A whole-ecosystem experiment in self-design. *Bioscience* 48(12): 1019-1030.
- Naiman, R.J. & Décamps, H. 1997. The ecology of interfaces: Riparian zones. *Annual Review of Ecol. Syst.* 28: 621-658.
- Nathan, R. & Casagrandi, R. 2004. A simple mechanistic model of seed dispersal, predation and plant establishment: Janzen-Connell and beyond. *J. Ecol.* 92: 733-746.

- Neff, K.P. & Baldwin, A.H. 2005. Seed dispersal into wetlands: techniques and results for a restored tidal freshwater marsh. *Wetlands* 25(2): 392-404.
- Nilsson, C. 1999. Rivers and Streams. In: Rydin, H. (ed.) *Acta Phytogeogr. Suec.* 84: 135-148.
- Nilsson, C. & Grelsson, G. 1990. The effects of litter displacement on riverbank vegetation. *Can. J. Bot.* 68: 735-741.
- Nilsson, C., Gardfjell, M. & Grelsson, G. 1991. Importance of hydrochory in structuring plant communities along rivers. *Can. J. Bot.* 69: 2631-2633.
- Nilsson, C., Jansson, R. & Zinko, U. 1997. Long-term responses of river-margin vegetation to water-level regulation. *Science* 276: 798-800.
- Nilsson, C., Xiong, S., Johansson, M.E. & Vought, L.B.-M. 1999. Effects of leaf-litter accumulation on riparian plant diversity across Europe. *Ecology* 80(5): 1770-1775.
- Nilsson, C., Andersson, E., Merritt, D. & Johansson, M.E. 2002. Differences in riparian flora between riverbanks and river lakeshores explained by dispersal traits. *Ecology* 83(10): 2878-2887.
- Nilsson, C., Reidy, C.A., Dynesius, M. & Revenga, C. 2005. Fragmentation and Flow Regulation of the World's Large River Systems. *Science* 308: 405-408.
- Nilsson, C., Ekblad, A., Dynesius, M., Backe, S., Gardfjell, M., Carlberg, B., Hellqvist, S. & Jansson, R. 1994. A comparison of species richness and traits of riparian plants between a main river channel and its tributaries. *J. Ecol.* 82: 281-295.
- Nilsson, Ö. & Hjelmqvist, H. 1967. Studies on the nutlet structure of South Scandinavian species of *Carex*. *Bot. Notiser* 120: 460-485.
- Ohlendorf, O. 1907. *Beiträge zur Anatomie und Biologie der Früchte und Samen einheimischer Sumpf- und Wasserpflanzen*. Unpublished dissertation at the Friedrich-Alexander-University of Erlangen.
- Overbeck, G., Kiehl, K., Abs, C. 2003. Seedling recruitment of *Succisella inflexa* in fen meadows: Importance of seed and microsite availability. *Appl. Veg. Sci.* 6: 97-104.
- Ozinga, W.A., Schaminée, J.H.J., Bekker, R.M., Bonn, S., Poschlod, P., Tackenberg, O., Bakker, J. & van Groenendael, J.M. 2005. Predictability of plant species composition from environmental conditions is constrained by dispersal limitation. *Oikos* 108: 555-561.
- Petersen, R.C., Cummins, K.W., Ward, G.M., 1989. Microbial and animal processing of detritus in a woodland stream. *Ecol. Monogr.* 59: 21-39.
- Petts, G.E., Möller, H. & Roux, A.L. (eds.) 1989. *Historical change of large alluvial rivers: Western Europe*. J. Wiley & Sons Ltd., Chichester, UK.
- Planty-Tabacchi, A.-M., Tabacchi, E. & Bonillo, M.J.S. 2001. Invasions of river corridors by exotic plant species: patterns and causes. In: Brundu, G., Brock, J., Camarda, I., Child, L. & Wade, M. (eds.) *Plant invasions: Species Ecology and Ecosystem Management*, pp. 221-234. Backhuys Publishers, Leyden, NL.

- Poff, N.L., Allan, J.D., Bain, M.B., Karr, J.R., Prestegard, K.L., Richter, B.D., Sparks, R.E., Stromberg, J.C. 1997. The natural flow regime. A paradigm for river conservation and restoration. *BioScience* 47(11): 769-784.
- Portnoy, S. & Willson, M. F. 1993. Seed dispersal curves: behaviour of the tail of the distribution. *Evol. Ecol.* 7:25-44.
- Prach, K., Husák, S., Cerný, R., Kucera, S., Guth, J., Rydlo, J. & Klimesová, J. 1996. Species and vegetation diversity along the river. In: Prach, K., Jenik, J., Large, A.R.G. (eds.) *Floodplain Ecology and Management*, pp. 62-80. SFB Academic Publishing, Amsterdam, NL.
- Praeger, R.L. 1913. On the buoyancy of the seeds of some britannic plants. *Sci. Proc. Roy. Dub. Soc.* 143: 13-62.
- Pyšek, P. & Prach, K. 1993. Plant invasions and the role of riparian habitats: a comparison of four species alien to central Europe. *J. Biogeogr.* 20: 413-420.
- Pyšek, P. & Prach, K. 1994. How important are rivers for supporting plant invasions? In: de Waal, L.C., Child, L.E., Wade, P.M. & Brock, J.H. (eds.) *Ecology and Management of Invasive Riverside Plants*, pp. 19-26. John Wiley & Sons Ltd, Chichester, UK.
- Ramseier, D. 2000. Why remove the topsoil for fen restoration? – Influence of water table, nutrients and competitors on the establishment of four selected plant species. *Bull. Geobot. Inst. ETH* 66: 25-35.
- Renöfält, B.M., Jansson, R. & Nilsson, C. 2005. Spatial patterns of plant invasiveness in a riparian corridor. *Landscape Ecol.* 20: 165-176.
- Ridley, H.N. 1930. *The dispersal of plants throughout the world*. L. Reeve & Co., Ashford, UK.
- Romell, L.G. 1938. Växternas spridningsmöjligheter. In: Skottsberg, C. (ed.) *Växternas liv IV*, pp. 279-488. Nordisk Familjeboks Förlag AB, Stockholm, SE.
- Rothmaler, W. 1994. *Exkursionsflora von Deutschland*. Band 4. Gefäßpflanzen: Kritischer Band, 8th ed., Schubert, R. & Vent, W. (eds.). Gustav Fischer Verlag, Jena – Stuttgart, DE.
- Ryvarden, L. 1971. Studies in seed dispersal I. Trapping of diaspores in the alpine zone at Finse, Norway. *Norw. J. Bot.* 18: 215-226.
- Schafer, M., Kotanen, P.M. 2003. The influence of soil moisture on losses of buried seeds to fungi. *Acta Oecol.* 24: 255-263.
- Schmitz, U. 2002. *Untersuchungen zum Vorkommen und zur Ökologie neophythischer Amaranthaceae und Chenopodiaceae in der Ufervegetation des Niederrheins*. Dissertationes Botanicae 364. Cramer, Berlin [et al.], DE.
- Schneider, R.L. & Sharitz, R.R. 1988. Hydrochory and regeneration in a bald cypress-water tupelo swamp forest. *Ecology* 69: 1055-1063.
- Schoch, W.H., Pawlik, B. & Schweingruber, F.H. 1988. *Botanische Makroreste – Atlas zur Bestimmung häufig gefundener und ökologisch wichtiger Pflanzensamen*. *Botanical macro-remains – An atlas*

- for the determination of frequently encountered and ecologically important plant seeds. Verlag Paul Haupt, Bern [et al.], CH.
- Schwabe, A. 1991. Zur Wiederbesiedlung von Auenwald-Vegetationskomplexen nach Hochwasser-Ereignissen: Bedeutung der Diasporen-Verdriftung, der generativen und vegetativen Etablierung. Re-colonization of vegetation complexes built up by riparian forests after flooding: importance of seed drifting, generative and vegetative strategies of establishment. *Phytocoenologia* 201: 65-94.
- Schwartz, R., Duwe, J. & Gröngröft, A. 1997. Einsatz von Kunstrasenmatten als Sedimentfallen zur Bestimmung des partikulären Stoffeintrages in Auen und Marschen. *Mitt. Dtsch. Bodenkdl. Ges.* 85 (I): 353-356.
- Settele, J., Margules, C.R., Poschlod, P. & Henle, K. (eds.). 1996. *Species survival in fragmented landscapes*. Kluwer Academic Publishers, Dordrecht, NL.
- Skoglund, S.J. 1990. Seed dispersing agents in two regularly flooded river sites. *Can. J. Bot.* 68: 754-760.
- Smits, A.J.M., van Ruremonde, R. & van der Velde, G. 1989. Seed dispersal of three nymphaeid macrophytes. *Aquatic Botany* 35: 167-180.
- Šrútek, M. & Hara, T. 1996. *Urtica dioica* L. A dominant plant of abandoned floodplains. In: Prach, K., Jenik, J. & Large, A. R. G. (eds.): *Floodplain Ecology and Management*, pp. 147-153. SPB Academic Publishing, Amsterdam, NL.
- Staniforth, R.J. & Cavers, P.B. 1976. An experimental study of water dispersal in *Polygonum* spp.. *Can. J. Bot.* 54: 2587-2596.
- Statsoft. 1998. *Statistica für Windows*, version 5.0. Tulsa, USA.
- Statsoft Inc. 2003. *Statistica for Windows*, version 6.0. Tulsa, USA.
- Statsoft Inc. 2004. *Statistica for Windows*, version 6.1. www.statsoft.com. Tulsa, USA.
- Stopp, K. 1956. Botanische Analyse des Driftgutes vom Mittellauf des Kongoflusses, mit kritischen Bemerkungen über die Bedeutung fluviatiler Hydrochorie. *Beitr. Biol. Pfl.* 32(3): 427-449.
- Tabacchi, E., Planty-Tabacchi, A.M., Roques, L. & Nadal, E. 2005. Seed inputs in riparian zones: Implications for plant invasion. *River Res. Applic.* 21: 299-313.
- Thompson, L., Thomas, C.D., Radley, J.M.A., Williamson, S., Lawton, J.H. 1993. The effect of earthworms and snails in a simple plant community. *Oecologia* 95: 171-178.
- Tockner, K., Malard, F. & Ward, J.V. 2000. An extension of the flood pulse concept. *Hydr. Proces.* 14: 2861-2883.
- Trepel, M., Holsten, B., Kieckbusch, J., Otten, I. & Pieper, F. 2003. Influence of macrophytes on water level and flood dynamics in a riverine wetland in Northern Germany. Proc. Warsaw Conf. Ecoflood – towards natural flood reduction strategies. CD-version.
- Ulbrich, E. 1928. *Biologie der Früchte und Samen – Karpobiologie*. Springer, Berlin, DE.

- Van den Broek, T., van Diggelen, R. & Bobbink, R. 2005. Variation in seed buoyancy of species in wetland ecosystems with different flooding dynamics. *J. Veg. Sci.* 16: 579-586.
- Van der Maarel, E. & Sykes, M.T. 1993. Small-scale plant species turnover in a limestone grassland: the carousel model and some comments on the niche concept. *J. Veg. Sci.* 4: 179-188.
- Van der Maarel, E. 1997. *Biodiversity: from babel to biosphere management*. Special Feature in Biosystem. *Biodivers.* 2: 1-60.
- Van der Pijl, L. 1972. *Principles of Dispersal in Higher Plants*. 2nd edition, Springer-Verlag, Berlin, DE.
- Vogt, K., Rasran, L. & Jensen, K. 2004. Water-borne seed transport and seed deposition during flooding in a small river-valley in Northern Germany. *Flora* 199: 377-388.
- Vogt, K., Rasran, L., Jensen, K. 2006. Seed deposition in drift lines during an extreme flooding event – evidence for hydrochorous dispersal? *Basic Appl. Ecol.* 7(5): 422-432.
- Webb, D.A. 1966. Dispersal and establishment: what do we really know? In: Hawkes, J.G. (ed.) *Reproductive biology and taxonomy of vascular plants: the report of the conference of the Botanical Society of the British Isles*. Conference report 9: 93-102.
- Wisskirchen, R. & Haeupler, H. 1998. Standardliste der Farn- und Blütenpflanzen Deutschlands. Bundesamt für Naturschutz (ed.). Verlag Eugen Ulmer, Stuttgart, DE.
- Xiong, S. & Nilsson, C. 1997. Dynamics of leaf litter accumulation and its effects on riparian vegetation: a review. *Bot. Rev.* 63(3): 240-264.
- Xiong, S., Nilsson, C. & Johansson, M.E. 2001. Effects of litter accumulation on riparian vegetation: importance of particle size. *J. Veg. Sci.* 12: 231-236.
- Xiong, S., Johansson, M.E., Hughes, F.M.R. Hayes, A., Richards, K.S., Nilsson, C. 2003. Interactive effects of soil moisture, vegetation canopy, plant litter and seed addition on plant diversity in a wetland community. *J. Ecol.* 91: 976-986.
- Zobel, M. 1997. The relative role of species pool in determining plant species richness: an alternative explanation of species coexistence? *Trends Ecol. Evol.* 12(7): 266-269.
- Zobel, M. & Kalamees, R. 2005. Diversity and dispersal - can the link be approached experimentally? *Folia Geobot.* 40: 3-11.
- Zobel, M., Van der Maarel, E. & Dupré, C. 1998. Species pool: the concept, its determination and significance for community restoration. *Appl. Veg. Sci.* 1: 55-66.

Summary

Aim of the present thesis was to analyse hydrochory (dispersal by water), its partial processes and their effects on species diversity in riparian landscapes. Single steps of hydrochorous dispersal (seed transport, deposition, germination and establishment) were regarded for the colonisation of riparian habitats with respect to their function as seed source as well as ecological filter. Quality, quantity and germination ability of seeds transported in the river or deposited with sediments or drift lines took centre stage in the investigations.

Also the seasonal dynamic of hydrochorous transport and coherences with (extreme) flooding events as well as (morphological and ecological) species traits, which are assumed to enhance species ability for hydrochorous seed dispersal, were investigated.

METHODS FOR STUDYING HYDROCHORY

Water-borne seed transport and seed deposition during flooding were studied in the Upper Eider river (N-Germany) by direct sampling of the rivers seed content with aquatic seed traps and by analysing the number of deposited seeds on sedimentation mats which were exposed near the river on the soil surface during a flooding period of approx. three weeks.

The number of seeds which were transported at the surface of the river Eider was continuously analysed by four aquatic seed traps for a period of 20 weeks (July – December 2000). To test the capture rate of these traps, a recapture experiment with colour marked seeds of *Helianthus annuus* L. was carried out. During the investigation period approx. 9 000 seeds of 76 species were captured by the four aquatic seed traps. The number of trapped seeds varied both spatially (across the river profile) and temporally. Considering this variation and the capture rate of the traps, the water-borne seed transport was estimated to be 3 139 seeds per week and meter of the river profile.

The seed deposition during a flood in early spring 2002 was analysed by using 20 sedimentation mats. To distinguish effects of seed dispersal into patches from outside from seed rearrangement within patches, the water-borne seed transport was excluded from one half of the mats by fencing them with a woven fabric which was permeable for water but not for floating seeds. Outside of the exclosures 152 viable seeds of 26 species were deposited on the sedimentation mats while only one single seedling was found on mats from which water-borne seed transport was excluded.

The results demonstrate that hydrochorous dispersal processes might play an important role in connecting otherwise fragmented populations in periodically flooded habitats along rivers.

HYDROCHOROUS SEED TRANSPORT

The main question of this investigation was how environmental factors and species traits influence temporal variation and species composition in hydrochorous seed transport.

For answering this question we analysed waterborne seed transport by using aquatic seed traps. The river water was sampled weekly during a period of two years (July 2000 - June 2002). The sampled material of the first study year was dried and all containing plant seeds were identified and counted. In the second study year half of the samples were freshly deposited on sterilized soil for germination. We compared the species composition of transported seeds with the riparian vegetation and the local species pool with respect to species traits. Multiple regressions were used to relate temporal variation of seed transport to different environmental factors.

About 280 000 seeds of 243 taxa including 50 % of the species from the local species pool were trapped in the river. The waterborne seed transport varied strongly both within and between the two study years and was affected by discharge and hydrological events like e.g. flooding. Species with high seed buoyancy, morphological adaptations to hydrochory, and high Ellenberg Moisture Values were more common in the aquatic samples than in the riparian vegetation and the local species pool.

We conclude that hydrochory is an important dispersal vector in riparian landscapes. The overall amount of transported seeds is positively affected by increasing discharge and flooding. Among the analysed species traits seed buoyancy and morphological adaptations to hydrochory influenced the occurrence of seeds in the river water.

SEED DEPOSITION IN DRIFT LINES

One crucial point for hydrochorous dispersed plants is their arrival at suitable sites for germination and establishment. Deposition of hydrochorous transported seeds in riparian landscapes occurs mainly together with other (dead plant) material in form of drift lines. Our question was, if the conditions within drift lines are suitable for seed survival and germination and if drift lines can be seen as seed source or sink for species diversity in riparian fen grasslands.

We analysed drift line material in a small river valley in Northern Germany, after the regular floods in late winters 2000, 2002 and 2004. The content of viable seeds in drift lines was studied via a germination trial with drift litter samples, taken from five fen grassland sites representative for the floodplain of the river. Further, vegetation of both abandoned and moderately grazed fen grasslands affected by drift line deposition was compared with equivalent sites without drift lines. Additionally, the decline of seed viability after the deposition of drift litter material was studied. Finally, the relative importance of seed-containing drift litter material and microsite availability for seedling recruitment was investigated in a two-factorial field experiment with the factors disturbance (mowing, large gaps, small gaps, undisturbed control) and addition of (seed-containing) drift line material (yes, no) in an abandoned riparian fen.

Seedlings recruited out of drift litter samples collected at different sites differed in their species composition. A nearly 50 % reduction of the number of viable seeds in drift litter was observed already during two weeks after deposition. The effect of drift line as seed source was significant for the number of seedlings in the analysis of naturally deposited drift lines, although an increase of seedling recruitment in areas with drift line material was only observed at grazed site. In the factorial field experiment drift litter addition had a negative effect on the number of seedlings, while gap creation enhanced seedling recruitment.

These results indicate that the impact of drift-line material on species diversity in riparian fen grasslands can be either negative (hampering germination and/or establishment by thick litter layers) or positive (increasing seed availability). However, the studied river system is comparatively species poor and flooding extension is limited. Thus, the role of drift lines as seed source might be of minor importance in the region. Effects of hydrochorous dispersal on species diversity are expected to be enhanced by the restoration of a natural flooding regime.

HYDROCHORY DURING EXTREME FLOODS

Extreme flooding events can be of major importance for dispersal processes in today's fragmented landscape. We studied long- and short-distance seed dispersal during an extraordinary flooding of the Elbe River in summer 2002. In addition we evaluated the effect of different species traits (seed buoyancy, dispersal type, Ellenberg moisture values) on dispersal and discussed the relevance of hydrochorous dispersal during extreme flooding events for nature conservation and restoration. Along a transect of 400 km of the Middle Elbe River (Eastern Germany) drift line material from three habitats (arable field, grassland, river bank) was collected at five locations. Its seed content was analysed and compared with vegetation communities of the same region with respect to species composition. One part of the drift line samples was scanned for seeds and seed fragments visually, while the other

part was exposed for germination. A total of approx. 1500 seedlings of about 70 species emerged from the samples. The most frequent species were *Deschampsia cespitosa*, *Urtica dioica*, *Ranunculus repens* and *Lycopus europaeus*. Hand-sorting of drift-line material revealed that only 1.5 % of the seeds occurring in the samples recruited in the germination trials. Although most seeds and seedlings from the drift line samples belonged to common species, some seeds of rare and endangered species were found. Species composition of the drift line samples differed only marginally between the studied habitats and locations, which is interpreted as evidence for short- and long-distance seed dispersal. In contrast, the vegetation of the analysed habitats differed significantly. The studied species traits did not differ between drift-line material from different habitats, but rather between the differentiated vegetation communities. We conclude that seeds from different habitats and locations are transported together during heavy flooding and that these floodings might thus expand the usual dispersal ranges of plant species.

Plate V



Picture 9. Upper Eider River near Grevenkrug (February 2002).



Picture 10. Moderately grazed fen area in the Upper Eider Valley during flooding in April 2002.

Zusammenfassung

Ziel der vorliegenden Arbeit ist es, Hydrochorie und ihre Teilprozesse zu untersuchen und deren Effekte auf die Artendiversität in Flusstallandschaften herauszufinden. Dabei wurden die einzelnen Schritte der hydrochoren Ausbreitung (Verdriftung der Diasporen, Anlandung, Keimung und Etablierung) im Hinblick auf ihrer Funktion als Diasporenquellen, aber auch als ökologische Filter bei der Besiedlung flussnaher Habitats betrachtet. Qualität, Quantität und Keimfähigkeit im Gewässer verdrifteter und in Form von Sedimenten oder Spülsäumen abgelagerter Diasporen standen im Mittelpunkt der Untersuchungen. Auch die jahreszeitliche Dynamik hydrochorer Prozesse und Zusammenhänge mit (Extrem-) Überflutungsereignissen sowie (morphologischen und ökologischen) Besonderheiten der Pflanzenarten, die eine potentielle Fähigkeit zur hydrochoren Ausbreitung annehmen lassen, wurden betrachtet.

METHODEN ZUR UNTERSUCHUNG HYDROCHORER PROZESSE

Mit Hilfe aquatischer Diasporenfallen und Sedimentationsmatten wurde der hydrochore Diasporentransport im Fließgewässer und die Diasporensedimentation während einer Überflutung im Oberen Eidertal (N-Deutschland) untersucht. Die Anzahl der an der Wasseroberfläche der Eider transportierten Diasporen wurde kontinuierlich über einen Zeitraum von 20 Wochen (Juli - Dezember 2000) mit vier aquatischen Diasporenfallen analysiert. Um die Fangraten der Diasporenfallen zu bestimmen, wurde ein Wiederfang-Experiment mit farblich markierten *Helianthus* Achänen durchgeführt. Während des Untersuchungszeitraumes konnten ca. 9 000 Diasporen von 76 Arten mit Hilfe der vier aquatischen Diasporenfallen nachgewiesen werden. Die Anzahl der gefangenen Diasporen variierte sowohl räumlich (entlang des Gewässerquerschnitts) als auch zeitlich. Unter Berücksichtigung der räumlichen und zeitlichen Variabilität und der Fangrate der Fallen wurde ein hydrochorer Diasporentransport von etwa 3 139 Diasporen pro Woche und Meter des Flussquerschnitts ermittelt.

Die Sedimentation von Diasporen wurde während einer Überflutung im zeitigen Frühjahr 2002 mittels 20 Sedimentationsmatten untersucht. Um zwischen dem Eintrag von Diasporen in ein Gebiet und der Umlagerung innerhalb kleinerer Flächen (4 m²) zu differenzieren, wurde der hydrochore Diasporeneintrag von der Hälfte der Matten mit Hilfe von Zäunen aus Bändchengewebe ausgeschlossen, die permeabel für Wasser, aber nicht für darin treibende

Diasporen waren. Außerhalb dieser Exclosures sedimentierten 152 Diasporen von 26 Arten, während auf den Matten mit Hydrochorieausschluss nur ein einziger Keimling gefunden wurde.

Die Ergebnisse zeigen, dass hydrochore Ausbreitungsprozesse eine wichtige Rolle für ansonsten fragmentierte Populationen in periodisch überfluteten Habitaten entlang von Fließgewässern spielen können.

HYDROCHORER DIASPORENTTRANSPORT

Im Mittelpunkt dieser Untersuchung stand die Frage, wie sich unterschiedliche Umweltfaktoren und artspezifische Charakteristika auf die zeitliche Variabilität des hydrochoren Diasporentransports auswirken.

Zur Beantwortung dieser Frage wurde der hydrochore Diasporentransport der oberen Eider untersucht. Der Fluss wurde über einen Zeitraum von zwei Jahren kontinuierlich beprobt. Die Proben des ersten Untersuchungsjahres wurden getrocknet und die in den Proben des ersten Jahres enthaltenen Diasporen bestimmt und gezählt. Die Proben des zweiten Jahres wurden zur Hälfte zur Keimung auf steriler Erde ausgebracht, während die andere Hälfte wie im Vorjahr behandelt wurde. Dann erfolgte eine vergleichende Analyse der Artenzusammensetzung der im Fluss transportierten Diasporen mit der Ufervegetation und dem lokalen Artenpool im Hinblick auf verschiedene artspezifische Charakteristika. Mit Hilfe multipler Regressionen wurden Beziehungen der zeitlichen Variabilität des Diasporentransports und unterschiedlichen Umweltfaktoren analysiert.

Insgesamt wurden über 280 000 Diasporen von 243 Taxa im Flusswasser nachgewiesen. Dies macht ca. 50% der im Untersuchungsgebiet vorkommenden Arten aus. Der hydrochore Diasporentransport variierte sowohl innerhalb als auch zwischen den beiden Untersuchungsjahren stark und wurde vom Abfluss der Eider und hydrologischen Ereignissen wie z.B. Überflutungen beeinflusst. Arten mit einer hohen Diasporenschwimmfähigkeit, morphologischen Anpassungen an Hydrochorie und hohen Ellenberg Feuchtwerten kamen häufiger in den aquatischen Diasporenproben als in der Ufervegetation und im lokalen Artenpool vor.

Wir schließen daraus, dass Hydrochorie ein wichtiger Ausbreitungsvektor in Flusslandschaften sein kann. Die Anzahl im Gewässer transportierter Diasporen steigt bei steigendem Abfluss und bei Überflutungen. Von den analysierten artspezifischen Charakteristika hatten die Diasporenschwimmfähigkeit und das Vorhandensein morphologischer Anpassungen an Hydrochorie einen Einfluss auf das Vorkommen von Diasporen dieser Arten im Flusswasser.

DIASPORENABLAGERUNG IN SPÜLSÄUMEN

Ein entscheidender Punkt für hydrochor ausgebreitete Pflanzen ist ihre Ankunft an für Keimung und Etablierung geeigneten Standorten. Die Ablagerung mit strömendem Wasser transportierter Diasporen in Flusstal-Landschaften erfolgt hauptsächlich zusammen mit anderem (vorwiegend pflanzlichem) Material in Form von Spülsäumen. Hauptfrage bei dieser Untersuchung war, ob die in Spülsäumen vorherrschenden Bedingungen für Überdauerung und Keimung von Diasporen geeignet sind und ob Spülsäume als Diasporenquellen oder -senken für die Artendiversität in Flusstal-Niedermooren fungieren.

Dazu wurden im Oberen Eidertal nach Abklingen der regulären Winterüberflutung in den Jahren 2000, 2002 und 2004 Spülsäume untersucht. Anzahl und Art der im Spülsaummaterial enthaltenen Diasporen wurden mit Hilfe einer Keimungsuntersuchung mit Spülsaumproben von fünf für die Flussaue repräsentativen Grünlandstandorten analysiert. Weiter wurde die Vegetationsentwicklung einer extensiv beweideten Fläche und einer Brache mit Spülsaumeinfluss mit äquivalenten Flächen ohne sichtbare Spülsäume verglichen. Zusätzlich wurde der Verlust lebensfähiger Diasporen nach der Ablagerung von Spülsäumen untersucht. Schließlich wurde in einem zweifaktoriellen Freilandexperiment mit den Faktoren Störung (Mahd, kleine und große Störstellen, ungestörte Kontrolle) und der Zugabe (diasporenhaltigen) Spülsaummaterials (ja, nein) der relative Einfluss des Vorhandenseins von Spülsaummaterial und Mikrohabitaten auf die Artendiversität in einer Feuchtgrünlandbrache analysiert.

Die aus den von unterschiedlichen Standorten gesammelten Spülsaumproben unterschieden sich hinsichtlich ihrer Artenzusammensetzung. Bereits zwei Wochen nach Ablagerung des Spülsaums wurde ein fast 50%iger Rückgang der Anzahl lebensfähiger Diasporen festgestellt. Die Auswirkung von Spülsäumen als Diasporenquelle war in der Analyse von natürlich abgelagertem Spülsäumen für die Anzahl an Keimlingen signifikant, auch wenn ein Anstieg der Keimlingsanzahlen in Bereichen mit Spülsaummaterial nur auf Flächen mit extensiver Beweidung beobachtet wurde. Im faktoriellen Freilandexperiment hatte die Zugabe von Spülsaummaterial einen negativen Effekt auf die Anzahl der auflaufenden Keimlinge, während die Schaffung von Störstellen zu einer vermehrten Keimung führte.

Diese Ergebnisse weisen darauf hin, dass der Einfluss von Spülsaummaterial auf die Artendiversität in Flusstallandschaften sowohl negativ (keimungs- und/oder etablierungshemmend durch dicke Streuschichten) als auch positiv (Diasporenverfügbarkeit erhöhend) gesehen werden kann. Allerdings ist das untersuchte Flusssystem vergleichsweise artenarm und die Ausdehnung der dort vorkommenden Überflutungen ist nur gering. Somit war die Rolle von Spülsäumen als Diasporenquelle für die Artendiversität in der Region von nur

geringer Bedeutung. Der Einfluss hydrochorer Ausbreitungsprozesse auf die Artendiversität könnte aber durch die Renaturierung des natürlichen Überflutungsregimes verstärkt werden.

HYDROCHORIE WÄHREND EXTREMER ÜBERFLUTUNGSEREIGNISSE

Extreme Überflutungsereignisse können in unserer heutigen fragmentierten Landschaft von großer Bedeutung sein. Im Sommer 2002 haben wir nach Rückgang der „Jahrhundert-Flut“ der Elbe hydrochore Nah- und Fernausbreitung pflanzlicher Diasporen untersucht. Zusätzlich wurde der Einfluss unterschiedlicher artspezifischer Charakteristika (Schwimmfähigkeit der Diasporen, Ausbreitungs-Typ, Ellenberg Feuchte-Werte) auf die Ausbreitung analysiert und die Relevanz hydrochorer Ausbreitung während extremer Überflutungen für den Naturschutz diskutiert. Entlang eines Transekts von insgesamt ca. 400 Flusskilometern der Mittleren Elbe (Ost-Deutschland) haben wir von jeweils drei Habitaten (Acker, Auen-Grünland, Flussufer der Elbe) an fünf Lokalitäten Spülsaummaterial entnommen. Wir untersuchten dessen Diasporengelalt und verglichen die Artenzusammensetzung des Spülsaums mit derjenigen charakteristischer Vegetationstypen derselben Region. Ein Teil der Spülsaumproben wurde visuell auf Diasporen durchsucht, während der übrige Teil zur Keimung ausgebracht wurde. Insgesamt liefen ca. 1500 Keimlinge von mehr als 70 Arten aus den Proben auf. Am häufigsten kamen *Deschampsia cespitosa*, *Urtica dioica*, *Ranunculus repens* und *Lycopus europaeus* vor. Das manuelle Sortieren des Spülsaummaterials ergab, dass nur ca. 1.5 % der in den Proben enthaltenen Diasporen in den Keimungsuntersuchungen aufliefen. Obwohl die meisten Diasporen und Keimlinge aus den Spülsaumproben zu weit verbreiteten Arten gehörten, wurden einige Diasporen seltener und gefährdeter Arten gefunden. Die Artenzusammensetzung der Spülsaumproben unterschied sich nur geringfügig zwischen den untersuchten Habitaten und Lokalitäten, was als Hinweis sowohl auf Nah- als auch Fernausbreitungsprozesse gewertet wird. Im Gegensatz dazu unterschied sich die Vegetation der untersuchten Habitate signifikant. Die analysierten artspezifischen Charakteristika unterschieden sich nicht signifikant zwischen Spülsaummaterial verschiedener Habitate wohl aber zwischen den betrachteten Vegetationstypen. Wir schließen aus den Ergebnissen, dass während extremer Überflutungen Diasporen von Arten unterschiedlicher Habitate und Lokalitäten zusammen transportiert werden und dass derartige Überflutungen den normalen Ausbreitungsradius von Pflanzenarten ausweiten können.

Danksagung

Ganz besonders herzlich möchte ich mich bei Kai Jensen, dem Initiator und Betreuer dieser Arbeit bedanken. Er hat die Arbeit in jeder Phase intensiv begleitet und stets ein offenes Ohr für Fragen und Probleme gehabt. Klaus Dierßen möchte ich dafür danken, dass er mich als Doktorandin angenommen hat und dafür, dass ich eine so schöne Zeit in der Fachabteilung Geobotanik am Ökologie-Zentrum in Kiel verbringen konnte.

Ohne die Unterstützung von Leonid Rasran sowohl bei der Arbeit als auch privat, wäre diese Arbeit wohl niemals zu Stande gekommen. Leo, ich danke Dir ganz herzlich dafür!

Weiter möchte ich mich bei allen Mitgliedern der Fachabteilung bedanken sowie auch den anderen Kolleginnen und Kollegen, mit denen ich in der Mittagspause und auch dann und wann zwischendurch angeregte Gespräche geführt habe. Vielen Dank besonders an Bettina, Michael, Astrid, Kirsten, Björn und Anne!

Die vorliegende Arbeit wurde im Rahmen des mit Mitteln der Deutschen Forschungsgemeinschaft finanzierten Projektes AuDiD – Ausbreitungsprozesse, Diasporenverfügbarkeit und Diversität in Flusstal-Landschaften (Di 206/15) durchgeführt.

Ebenfalls bedanken möchte ich mich bei Knut Krzywinski und seinen Kollegen von der Universität Bergen, insbesondere Peter Emil Kaland, Mary H. Losvik, Vigdis Vandvik and Hilary H. Birks, die es mir neben der wunderschönen Zeit, die ich dort verbringen konnte, ermöglicht haben, im Rahmen einer Marie-Curie Fellowship weitere Auslandserfahrungen zu sammeln und Doktorandenkurse zu besuchen, aus denen ich viele anregende Ideen für diese Arbeit mitgenommen habe.

Danken möchte ich insbesondere auch Britta Witt und Elsbe Bruhn, für Ihre Geduld mit mir und dafür, dass alles Organisatorische immer so gut geklappt hat.

Frau Herden möchte ich dafür danken, dass sie immer ein offenes Ohr für alle Sorgen hatte, die ein Doktorand so haben kann.

Weiterhin danken möchte ich Jutta Krüger von der Abteilung Pflanzenökologie und Nutzpflanzenbiologie der Universität Hamburg für ihre außerordentliche Hilfe beim Zählen und Bestimmen von (Un-)Mengen im Fluss transportierter Diasporen, Christiana Anagnostou für hilfreiche Kommentare und Korrektur eines der Kapitel dieser Arbeit sowie für ihre Freundschaft, Franziska Trost, Ulrike Fohgrob und Stephanie Otten für das fleißige Heraussortieren von Diasporen aus nicht immer appetitlichen Treibselproben, nochmals Hilary Birks vom Botanischen Institut der Universität Bergen für die Möglichkeit ihre (mehrere Schränke) umfassende Diasporensammlung zu nutzen, für viele interessante Gespräche und für die Teilnahme an ihrem Kurs "Plant macrofossils", Ilona Leyer und Ralf Baufeld für die freundliche Bereitstellung von Vegetationsaufnahmen der Mittleren Elbe, Michael Breuer für Hilfe bei den statistischen Analysen (insbesondere der Ordinationen), Paulette Clowes für die Korrektur eines der Kapitel dieser Arbeit, David Merritt für seine konstruktiven und hilfreichen Anmerkungen zu einem Kapitel dieser Arbeit sowie den anonymen Referenten, die dabei geholfen haben, einzelne Teile dieser Arbeit zu überarbeiten.

Zum Schluss möchte ich noch allen meinen Freunden und meinen Eltern und Geschwistern für ihre rückhaltlose Unterstützung in allen wichtigen und weniger wichtigen Dingen des Lebens danken.