



Institut für Theoretische Physik und Astrophysik  
Christian-Albrechts-Universität zu Kiel

A BRAIDED QUASI QUANTUM GROUP FROM  
STRINGS IN A MAGNETIC FIELD

&

TWO APPLICATIONS OF NONCOMMUTATIVE GEOMETRY

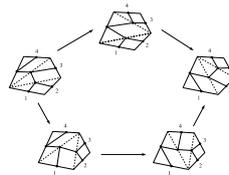

Dissertation

zur Erlangung des Doktorgrades  
der Mathematisch-Naturwissenschaftlichen Fakultät  
der Christian-Albrechts-Universität zu Kiel

vorgelegt von

Jan-Hendrik Jureit

Mai 2007

Referent: Prof. Dr. G. Gensing  
Korreferent: Prof. Dr. H. G. Schuster  
Dritter Gutachter: Prof. Dr. R. Wulkenhaar  
Tag der mündlichen Prüfung: 10.07.2007  
Zum Druck genehmigt: Kiel, 18.07.2007

Der Dekan  
Prof. Dr. J. Grotemeyer

*Für meine geliebten Eltern.*



*Sie drückten einander die Hände.  
"Du wirst mir fehlen".  
Und Plinio reiste ab.*



---

**ABSTRACT I:** The operators that realize a discrete symmetry group on a physical system describing a particle in a magnetic field furnish a projective representation of the group on the particle states. Promoting the magnetic background to a topologically non trivial field, one can still derive the magnetic translation operators from the path integral approach in their general form. For that, one has to introduce some basic differential geometrical techniques, for example the concept of a complex line bundle with connection, the wave functions seen as sections thereof as well as holonomies along trajectories. It is interesting to ask whether such a construction can be extended to the case of a propagating string, making use of similar geometrical techniques. In the higher dimensional string case, the magnetic field is a 3-form, the so called Kalb-Ramond field strength. To derive the operators that lift the group action to the states, one has to construct the magnetic amplitudes in terms of the locally given fields. Once constructed, the translation operators turn out to generate a braided quasi quantum group which is the twisted version of the Drinfel'd quantum double of a finite group algebra. The 3-cocycle providing the twist is related to the Kalb-Ramond field by a series of de Rham, Čech and group cohomological equations finding their natural framework in a tricomplex. As a Hopf algebra, the algebra generated by the magnetic translations comes equipped with some algebraic ingredients, that find their physical counterpart in operations on magnetic amplitudes. For example, the coproduct provides the representation of a string interaction process given by a world-sheet having the shape of a pair of pants. A braided Hopf algebra allows for a representation of the braid group on the tensor category of its modules, which becomes as such a braided monoidal category. This allows to identify the Hilbert spaces of string states with objects of the category. It is rather amazing that such a non-trivial algebraic structure pops up almost automatically by the requirement of gauge invariance and the commutation of translations with propagation.

**ABSTRACT II:** Quantum field theory lies at the root of our current understanding of elementary particles. A more general formulation of perturbative QFT on projective modules over noncommutative algebras is proposed. In noncommutative geometry, projective modules are the noncommutative analogues of vector bundles being the natural receptacles for matter fields. This leads to the construction of a field theory on a Heisenberg module over noncommutative tori. It is proven to be 1-loop renormalizable and highly sensitive to the number-theoretical aspect of the deformation parameter. The problem of UV/IR mixing is encountered which can be cured at the price of introducing a non-local counter-term which is acceptable in NCQFT.

**ABSTRACT III:** One of many applications of noncommutative geometry is the construction of the standard model of particle physics. The so called almost commutative standard model uses spectral triples as its appropriate description. The finite part of such a triple consists of a direct sum of matrix algebras leading to their classification in terms of Krajewski diagrams. One can investigate whether the standard model takes a prominent position within all irreducible Krajewski diagrams which are classified using an algorithm implemented on a computer. It is shown that this is indeed the case.



**KURZFASSUNG I:** Diskrete Translationen des quantenmechanischen Systems eines Teilchens im magnetischen Feld können nur durch projektiv wirkende Operatoren auf den Zuständen dargestellt werden. Die allgemeine Form dieser Operatoren kann mit Hilfe des Pfadintegralformalismus hergeleitet werden, selbst wenn das Hintergrundfeld topologisch als nicht-trivial angenommen wird. Dafür sind Grundkonzepte der Differentialgeometrie erforderlich, wie das des komplexen Linienbündels mit Zusammenhang, Wellenfunktionen als Schnitte darüber oder Holonomien entlang von Trajektorien. Es stellt sich die Frage, ob derlei geometrische Techniken auch auf einen propagierenden String übertragen werden können. In diesem Fall nämlich, ist das Magnetfeld eine 3-Form; das so genannte Kalb-Ramond-Feld. Um die Operatoren herzuleiten, die die Gruppenwirkung auf die Zustände liften, muß die magnetische Amplitude mit Hilfe der lokal gegebenen Eichfelder konstruiert werden. Die konstruierten Operatoren erweisen sich als Generatoren einer gezopften Quasiquantengruppe: die getwistete Version des Drinfel'd'schen Quantendoppels einer endlichen Gruppenalgebra. Das den Twist verursachende 3-Kozykel ist durch eine Reihe von De Rham-, Čech- und gruppenkohomologischen Gleichungen, die auf natürliche Weise einem Trikomplex entspringen, mit dem Kalb-Ramond-Feld verknüpft. Bestimmte Elemente der konstruierten Hopfalgebra spiegeln sich in Operationen auf magnetischen Amplituden wider; zum Beispiel stellt ihr Koprodukt die korrekte Darstellung auf Weltlaken in Form einer Hose dar. Als gezopfte Hopfalgebra erlaubt sie zusätzlich die Konstruktion einer Darstellung der Zopfgruppe auf der Tensorategorie ihrer Moduln, womit diese Kategorie eine Zopfung erhält. Die Hilberträume der Stringzustände können mit Objekten der Kategorie identifiziert werden. Es ist erstaunlich, daß eine solch nicht-triviale algebraische Struktur allein durch die Forderung der Eichinvarianz und der Vertauschbarkeit von Translationen und Propagationen zum Vorschein kommt.

**KURZFASSUNG II:** Quantenfeldtheorie liegt unserem momentanen Verständnis der Elementarteilchenphysik zu Grunde. Hier wird eine verallgemeinerte Formulierung von perturbativer QFT auf projektiven Moduln über nicht-kommutativen Algebren vorgestellt. In der nicht-kommutativen Geometrie finden Vektorbündel ihre Entsprechung in projektiven Moduln, wobei die Materiefelder als wertig im Modul angesehen werden. Als Beispiel führt dies zu einer Quantenfeldtheorie auf einem Heisenberg-Modul über nicht-kommutativen Tori. Es wird gezeigt, daß die so erhaltene Theorie bis einschließlich zur ersten Schleifenordnung renormierbar ist, wobei sich eine interessante Sensitivität bezüglich des Deformationsparameters herausstellt. Das auftretende Problem der UV/IR-Mischung kann durch die Einführung eines in der nicht-kommutativen Feldtheorie durchaus erlaubten nicht-lokalen Gegenterms behoben werden.

**KURZFASSUNG III:** Eine Anwendung der nicht-kommutativen Geometrie ist die Konstruktion des Standardmodells der Elementarteilchenphysik. Das fast-kommutative Standardmodell basiert auf spektralen Tripeln. Der endliche Teil eines solchen Tripels besteht aus einer direkten Summe von Matrixalgebren, was zu ihrer Klassifizierung mit Hilfe von Krajewski-Diagrammen führt. Die Klassifizierung von Krajewski-Diagrammen entspricht der Suche nach irreduziblen Diagrammen und beruht auf einem Algorithmus, der rechnerunterstützt ablaufen kann. Es stellt sich heraus, daß das zum Standardmodell zugehörige Krajewski-Diagramm eine ausgezeichnete Position in der Menge aller Irreduziblen einnimmt.



---

**RÉSUMÉ I:** Les translations d'un système quantique décrivant une particule dans un champ magnétique peuvent être représentées sur les états par des opérateurs qui forment une représentation projective. La forme générale de ces opérateurs s'obtient en utilisant le formalisme des intégrales fonctionnelles, même si le champ de fond est topologiquement non-trivial. La construction nécessite des concepts basiques de géométrie différentielle, par exemple le concept de fibré en droite complexe avec connexion et également l'interprétation des fonctions d'ondes comme des sections de fibré. On peut se poser la question de savoir si de telles techniques géométriques peuvent être transférées au problème d'une corde qui se propage. Dans ce cas là, le champ magnétique devient une 3-forme nommée champ de Kalb-Ramond. Pour la construction des opérateurs de translations, il faut construire l'amplitude magnétique en termes des champs de jauge locaux. Il se trouve qu'ils engendrent un groupe quantique tressé : C'est la version twistée du double de Drinfel'd d'une algèbre d'un groupe fini. Le 3-cocycle causant le twist est relié aux champs de Kalb-Ramond par une série d'équations cohomologiques de De Rham et Čech et des relations de la cohomologie des groupes, les trois cohomologies se combinent naturellement dans un tricomplexe. Quelques éléments de cette algèbre de Hopf peuvent être compris par certaines opérations sur les amplitudes magnétiques. Par exemple, le coproduit représente les translations magnétiques des surfaces de type 'pantalon'. Comme l'algèbre de Hopf est tressée, elle permet de représenter aussi le groupe des tresses sur la catégorie des modules. Par conséquent la catégorie est équipée d'un 'tressage' et les espaces de Hilbert des états de cordes peuvent être identifiés avec des objets de la catégorie. C'est très étonnant qu'une telle structure apparaît simplement en demandant l'invariance de jauge et la commutativité des translations avec la propagation.

**RÉSUMÉ II:** La description et la compréhension de la physique des particules élémentaires repose sur la théorie des champs quantiques. Ici, une généralisation de la théorie des champs quantiques dans des modules projectives sur des algèbres non-commutatives est présentée. En utilisant la géométrie non-commutative, un fibré vectorielle peut être décrit par un module projectif, dans lequel les champs prennent leurs valeurs. L'exemple présenté est une théorie dans un module de Heisenberg sur le tore non-commutatif. Il est montré que cette théorie est renormalisable à une boucle, rendant visible une sensibilité intéressante au sujet du paramètre de déformation. Le problème de la présence du mélange UV/IR peut être empêché en introduisant un contre-terme non local qui est acceptable pour la théorie des champs non-commutative.

**RÉSUMÉ III:** La construction du modèle standard des particules élémentaires représente une application de la géométrie non-commutative. Le modèle presque-commutatif est basé sur les triplets spectraux. La partie finie d'un tel triplet consiste en une somme directe d'algèbres matricielles, rendant possible la classification des triplets finis par l'utilisation des diagrammes de Krajewski. Cette classification est équivalente à l'analyse des diagrammes de Krajewski irréductibles et est basée sur un algorithme qui peut être implémenté sur un ordinateur. En effet il se trouve que le diagramme représentant le modèle standard occupe une place distinguée parmi l'ensemble des diagrammes irréductibles.



---

# CONTENTS

<b>I</b>	<b>A BRAIDED QUASI QUANTUM GROUP FROM KALB-RAMOND FIELDS AND MAGNETIC AMPLITUDES FOR STRINGS ON ORBIFOLDS</b>	<b>1</b>
<b>1</b>	<b>Introduction</b>	<b>3</b>
<b>2</b>	<b>A particle in a magnetic field</b>	<b>7</b>
2.1	Path integral and topology . . . . .	7
2.2	Globally exact magnetic translations . . . . .	13
2.3	Some remarks about bundles and some cohomology . . . . .	14
2.4	Local construction of the magnetic amplitude . . . . .	17
2.5	Projective group action on particle states . . . . .	19
<b>3</b>	<b>Magnetic translations for strings</b>	<b>25</b>
3.1	String action and CFT . . . . .	26
3.2	Tricomplex . . . . .	28
3.3	String propagation and states . . . . .	38
3.4	String magnetic amplitude . . . . .	39
3.5	Transition functions . . . . .	42
3.6	Gauge transformations . . . . .	45
3.7	Stringy magnetic translations . . . . .	46
<b>4</b>	<b>Hopf algebras, categories and braids</b>	<b>55</b>
4.1	Algebras and coalgebras . . . . .	55
4.2	Bialgebras and Hopf algebras . . . . .	57
4.3	Braided bialgebras . . . . .	58
4.4	Quasi bialgebras and braided quasi bialgebras . . . . .	60
4.5	The Drinfel'd quantum double . . . . .	62
4.6	Modules as tensor categories . . . . .	66
4.7	Quasitensor or braided monoidal categories . . . . .	68

---

4.8	Appendix: Higher coproducts of $\mathcal{R}$ . . . . .	70
<b>5</b>	<b>Interacting strings and the quasi Hopf structure</b>	<b>73</b>
5.1	Stoke's law in Deligne language . . . . .	73
5.2	Derivation of the coproduct from the pair of pants . . . . .	74
5.3	Transgression and twist . . . . .	79
5.4	Quasi coassociativity . . . . .	80
5.5	Large diffeomorphisms and mapping class group . . . . .	83
5.6	Loop amplitudes and modular invariance of the torus . . . . .	88
5.7	Discrete torsion and Drinfel'd twist . . . . .	90
5.8	Antipode and counit . . . . .	91
<b>6</b>	<b>Conclusions and Outlook</b>	<b>97</b>
<b>II</b>	<b>QUANTUM FIELD THEORY ON PROJECTIVE MODULES</b>	<b>105</b>
<b>7</b>	<b>Introduction: Why noncommutative field theory?</b>	<b>107</b>
7.1	Noncommutative spaces . . . . .	107
7.2	Field theory . . . . .	108
7.3	Field theory on projective modules . . . . .	111
7.4	Heisenberg module over the NCT as an example . . . . .	112
<b>8</b>	<b>Publication</b>	<b>115</b>
<b>III</b>	<b>CLASSIFICATION OF ALMOST-COMMUTATIVE GEOMETRIES</b>	<b>171</b>
<b>9</b>	<b>Introduction: The almost-commutative standard model</b>	<b>173</b>
9.1	Unification idea . . . . .	173
9.2	Spectral triples . . . . .	175
9.3	Almost commutative geometry . . . . .	176
9.4	Krajewski diagrams . . . . .	177
9.5	Classification . . . . .	178
<b>10</b>	<b>Publications</b>	<b>179</b>

# Part I

## A BRAIDED QUASI QUANTUM GROUP FROM KALB-RAMOND FIELDS AND MAGNETIC AMPLITUDES FOR STRINGS ON ORBIFOLDS



---

---

## CHAPTER 1

---

### INTRODUCTION

In most physical situations classical and quantum mechanical problems are modelled taking for granted topologically trivial configuration spaces, for example a particle in  $\mathbb{R}^3$  or harmonic oscillators. Classical symmetries of the system under consideration are then naively expected to be left unbroken in the quantum regime. Generally, symmetries of a classical system are groups  $G$  of transformations of the underlying space which have to be lifted to the quantum Hilbert space, i.e. by a representation of  $G$  in terms of operators acting unitarily on the quantum states. In some situations, however, the procedure of finding an adequate Hilbert space and the corresponding algebra of self-adjoint operators represented on the Hilbert space is not unique, but suffers from the appearance of ambiguities which parametrize inequivalent quantization schemes. This effect can always be observed, if the configuration space under consideration is no longer simply connected, i.e. it has a non-trivial first homotopy group. Such problems are normally attacked using the formalism of geometric quantization [1] (GQ) which provides one of the most rigorous quantization prescriptions. Especially the link between classical mechanics and quantum mechanics is made clear, because it uses the language of symplectic geometry, the underlying geometry of classical mechanics. Geometrically, GQ uses the concept of complex line bundles with connection, the symplectic form being a not necessarily globally exact 2-form on phase space  $\mathcal{M}$ . As a consequence, the prequantum line bundle must be taken to be non-trivial as well, leading to the famous quantization ambiguities such as  $\theta$ -vacua. The existence itself of such a bundle with curvature resides on the integrability condition for the symplectic form, that is, it must belong to the integral cohomology group  $H^2(\mathcal{M}, 2\pi\mathbb{Z})$  and equivalence classes of local data defining the bundle turn out to be a  $H^1(\mathcal{M}, U(1))$ -torsor.

In geometrical terms something similar happens if one is interested in topologically non-trivial background fields. Probably one of the first examples is that of the motion of a particle in the field of a magnetic monopole of Dirac. In this case it is not natural to regard wave functions merely as functions over the configuration space but to interpret them as being section of a complex line bundle with connection. The magnetic field is then the 2-form curvature of such a bundle equipped with a connection 1-form giving rise to the background

field only locally. As a consequence, the magnetic background is globally defined but not exact. Thus, topologically non-trivial background fields require the application of differential geometry. In lack of a globally exact 2-form, the passage to quantum mechanics via Feynman's path integral formalism leads to complications due to the non-existence of a global action which should be summed over all trajectories yielding the probability amplitude. However, this problem can be overcome by interpreting transition amplitudes no more as complex numbers but rather as linear maps between the fibres of the line bundle. Topological terms in the action are then simply obtained by parallel transport along the paths. In this context a classical symmetry is realized as diffeomorphisms acting on the base manifold  $\mathcal{M}$  leaving the background field invariant. However, this does not have to give rise to a symmetry of quantum mechanics. Since the object under consideration is a bundle with connection, a diffeomorphism on  $\mathcal{M}$  should be liftable to an isomorphism between the respective line bundle and its pull-back. This may fail, for example, if the space is multiply connected, i.e.  $H^1(\mathcal{M}, U(1)) \neq 1$ . But even if  $G$  is liftable to the bundle and  $H^1(\mathcal{M}, U(1))$  is trivial, in general one obtains an action of a central extension of  $G$  by  $U(1)$ , that is, a projective representation of  $G$  on the space of quantum states.

The problem of a globally ill defined action also exist in two-dimensional topological field theory [2]. Here, closed but not exact 3-forms play the rôle of the magnetic field described above and the holonomies are integrals over a 2-form potential along a surface. This is the adequate framework to study the propagation of a string coupled to this 'magnetic background', which is now called Kalb-Ramond field. Since the string is a higher-dimensional object it is quite natural to increase the degree of the involved differential forms. Geometrically, however, the question is to find the corresponding mathematical object which is capable of arranging the local field components, as is the case for a bundle with connection. It turns out that this is the concept of gerbes [3]. The task is thus to combine these ideas and to try to define magnetic translation operators acting on string states. Since in the particle's case these operators form a projective representation and generate a twisted group algebra, one is interested in a similar construction for strings and, as such, one aims at analyzing the algebraic structure that arises from 'stringy magnetic translations'. This part of the thesis is devoted to filling this gap.

Inspired by string compactifications on orbifolds  $\mathcal{M}/G$ , the operators of magnetic translations will be derived for open string states that close up to an element of  $G$ , the so called twisted sectors. Orbifolds arose in string theory out of the desire to find realistic models of compactification that are still exactly solvable in contrast to the much more complicated case of Calabi-Yau internal manifolds [4]. However, the construction of a real orbifold theory in terms of projecting to the  $G$ -invariant sub-Hilbert space is not what is targeted, but the aim is rather to find field relations and group actions on the fields to construct a valid action for twisted sectors. As it turns out, these relations can be found solving cohomological equations which makes it possible to adapt the well known local construction of the two-dimensional holonomies to the twisted sectors.

As a matter of fact, the construction of stringy magnetic translations  $T$  is quite straight-

forward. As a guiding principle, their derivation is obtained using their commutation with propagation,

$$T \text{ (cylinder) } = \text{ (cylinder) } T.$$

Much more impressive is the result of the analysis of the algebraic structure they generate if string interaction are taken into account. Schematically, this starts with a basic interaction process,

$$T \text{ (trifurcation) } = \text{ (trifurcation) } \Delta(T),$$

where  $\Delta$  stands for the most important part of a coalgebra structure, the coproduct. It is generally believed that quantum groups play an important rôle as generalized symmetries of quantum systems. Following [5, 6] quantum groups, or special kinds of Hopf algebras, give rise to more general transformation laws of states of a physical system, incorporating rather 'exotic' features like non-associativity or braided statistics. Although this arises in a different context here, it is what is met in a quite distinct manner: The magnetic translations of the twisted string states generate a braided quasi Hopf algebra, or quasi-triangular quasi Hopf algebra. The advantage of the construction presented here is indeed its geometrical origin. All algebraic components have their counterpart in certain operations on string amplitudes, introducing the product, coproduct as well as the braiding and quasi-associativity. This is due to the fact that the Hilbert spaces of string states carry a representation of the underlying algebra  $\mathcal{A}$  and can be identified as  $\mathcal{A}$ -modules. Such modules generally represent the objects of a tensor category, which becomes braided monoidal in the quasi quantum group case.

The first part of this thesis is organized as follows:

CHAPTER TWO: This chapter shall serve as a preparation for the constructions to be applied to strings. More precisely, the operators realizing magnetic translations on the particle states are derived both in the canonical and the path integral formalism. In the canonical formalism, the extra phases that accompany magnetic translations due to the appearance of a 2-cocycle are identified with isomorphisms between equivalent line bundles with connection. For the path integral approach, the magnetic amplitude is constructed out of the local data of the complex line bundle with connection. The assumed translation symmetry of the physical system translates into the commutation of translation with propagation. The techniques to be introduced here will be directly carried over to the next chapter dealing with the propagation of strings.

CHAPTER THREE: In order to implement the group action on the gauge field components of the Kalb-Ramond potential appearing in the topological term of the string action, a tricomplex is introduced as a general tool. It provides a convenient method to generate cohomological field equations relating equivalence classes of local data of gerbes by combining Čech/De Rham cohomology with group cohomology. Gerbes are introduced because their local data is necessary to construct the magnetic amplitude for a propagating string, in analogy to what has been done for the particle. This gives rise to the operators of stringy magnetic

translations represented on string states. The operators turn out to fulfill a projective multiplication law similar to the particle's case. However, string amplitudes are described by Riemannian surfaces and permit to encode interactions. It is therefore expected that the constructed operators of stringy magnetic translations respect a richer algebraic structure. It turns out that this algebraic structure is that of a twisted Drinfel'd quantum double of a finite group algebra which is a braided quasi Hopf algebra.

CHAPTER FOUR: This chapter is devoted to a short survey of Hopf algebras. As a mathematical interlude, it should be understood as providing the necessary mathematical background in order to fully appreciate the structure that has been found to arise solely from analyzing magnetic amplitudes together with some physical requirements, for example gauge invariance. Basically, this chapter gives a list of some techniques and definitions appearing in the context of Hopf algebras particularly suited for the understanding of the twisted quantum double. The notations introduced here will be used in the succeeding chapter.

CHAPTER FIVE: The geometrical nature of string amplitudes allows for the description of string interactions encoded by the topology of the associated Riemannian surfaces. To begin with, the simplest interaction is analyzed which corresponds to a world-sheet with the shape of a pair of pants. This gives rise to an additional algebraic structure, namely the coproduct. Again it pops up solely by the asking for gauge invariance and the dynamical invariance with respect to the group action. Making contact with the representation theory of this Hopf algebra in the context of monoidal categories, one can translate the defining features of the algebra to operations on string states. Quasi coassociativity leads to a non-associative behavior of string disintegrations related by the Drinfel'd associator on the level of amplitudes. Further, it is shown that the algebra generates the mapping class group of an arbitrary surface by Dehn twists and a representation of the braid group. Finally, the antipode and the counit take their rôle as trivial representation on vacuum states and reinterpretations of propagators by orientation reversing operations on the boundary of the string world-sheet. Discrete torsion turns out to be a Drinfel'd twist.

CHAPTER SIX closes with some concluding remarks.

This first part of the thesis to be presented bases upon a collaboration with Dr. Thomas Krajewski from the Centre de Physique Théorique (CPT) in Marseille. A shorter version is publicly available [7] and is going to be submitted to the Journal of High Energy Physics (JHEP).

---

---

## CHAPTER 2

---

### A PARTICLE IN A MAGNETIC FIELD

The purpose of this chapter is the explicit construction of the magnetic amplitude of a particle in a topologically non-trivial background magnetic field. This will serve as a preparation for the case of a string, which turns out to have a much richer structure, caused by the involved differential forms of higher degree. For the particle, we analyze the local data of a complex Hermitian line bundle with connection which serves as the point of departure for the construction of the operators of magnetic translations. The magnetic translations are derived from the magnetic amplitude entering the path integral formula of the propagator.

#### § 2.1 PATH INTEGRAL AND TOPOLOGY

In quantum mechanics, the transition amplitude for a physical system is governed by the unitary evolution operator  $e^{\frac{i}{\hbar}\hat{H}t}$ , where  $\hat{H}$  is the self adjoint Hamiltonian describing the dynamics of the system. According to the standard path integral formulation, the transition amplitude to find the system at a given (final) time  $t'$  in the state  $|y, t'\rangle$  if it has been in the state  $|x, t\rangle$  at (initial) time  $t$  is given by the kernel

$$K(y, t'; x, t) = \int [\mathcal{D}\varphi(\tau)] e^{\frac{i}{\hbar} \int_t^{t'} d\tau L(\varphi(\tau), \dot{\varphi}(\tau))}, \quad (2.1)$$

where  $L(\varphi, \dot{\varphi})$  is the Lagrangian and the (suitably normalized) integration measure  $[\mathcal{D}\varphi]$  is conventionally understood as the (infinite) summation over all possible paths with  $\varphi(t) \equiv x$  and  $\varphi(t') \equiv y$ . (Note, that even for a free particle,  $L = \frac{1}{2}m\dot{\varphi}^2$  the exact calculation of the path integral (2.1) is technically rather involved. Practically this is done by taking the discretized version and solving the appearing Gaussian integrals. Difficulties enter mainly because, for Gaussian integrals, one has to compute the determinant of the matrix in the quadratic term, which becomes (in the limit) an infinite dimensional tri-diagonal matrix [8].) From now on, let  $\mathcal{M}$  denote the configuration space. The kernel  $K(y, t'; x, t)$  evolves a wave function  $\Psi(x, t)$  according to

$$\Psi(y, t') = \int_{\mathcal{M}} dx K(y, t'; x, t) \Psi(x, t) \quad (2.2)$$

and conservation of probability can be understood as the 'gluing' of propagators

$$K(z, t''; x, t) = \int_{\mathcal{M}} dy K(z, t''; y, t') K(y, t'; x, t) \quad (2.3)$$

with a fixed intermediate time  $t'' > t' > t$ .

Throughout this thesis, a path shall be denoted by a map  $\varphi : [a, b] \rightarrow \mathcal{M}$  from a fixed interval  $[a, b]$  into the manifold  $\mathcal{M}$ . Furthermore, the *Euclidean* propagator will be worked with, conveniently written as ( $\hbar = 1$ )

$$K(y, x) = \int_{\substack{\varphi(a) \equiv x \\ \varphi(b) \equiv y}} [\mathcal{D}\varphi] e^{-S[\varphi]}, \quad (2.4)$$

with the measure  $[\mathcal{D}\varphi]$  respecting the indicated boundary conditions of the map  $\varphi$ . The Euclidean action functional is represented by  $S[\varphi]$ . Most of the time, time parameters will be omitted, but one should keep in mind the quantum mechanical causal meaning of a propagator.

The previous well known definitions are applicable only for topologically trivial configuration spaces. There are interesting phenomena arising from configuration spaces which are not so simple in the topological sense. Generally, these cases can be treated if one dares to apply the concept of line bundles and geometric quantization (GQ) [1, 9, 10]. A possible non-triviality of the underlying space translates into the non-triviality of the constructed line bundle and as a characteristic feature, all objects including derivations, fields and operators are well defined only *locally*. For example, wave functions are bundle valued, i.e. they are sections over the corresponding bundle instead of being merely functions on  $\mathcal{M}$ . Furthermore, if elements of an action functional are defined only locally, it is hard to write down a transition amplitude in the path integral formalism. In this case,  $K(y, x)$  can only be interpreted as a map between the fibre at  $x$  and the fibre at  $y$  of the bundle [2], and as such it carries Čech indices pertaining to the open sets used to cover  $x$  and  $y$ . This is particularly important if the Lagrangian contains the coupling to a (possibly only locally defined) magnetic vector potential, since one has to calculate the holonomy along the path to write down the action. This is one of the main aspects to be considered in the sequel.

## NON-SIMPLY CONNECTED SPACES

To give an example, depending on the topological structure of the space, one can understand one of the first important results in geometric (pre-)quantization by path integral considerations. The result is that in GQ, one finds inequivalent quantizations of the same theory which are identified mathematically with inequivalent Hermitian complex line bundles. Those are classified by flat line bundles representing elements of the cohomology group  $H^1(\mathcal{M}, U(1))$ . The latter group may be viewed as that of characters of the fundamental group  $\pi_1(\mathcal{M})$  of  $\mathcal{M}$ . In one of the subsequent sections, this fact will be derived from the local data of a line bundle.

In a simple path integral approach, suppose  $\mathcal{M}$  is multiply connected\*. The set of all paths between two arbitrary fixed points  $x, y \in \mathcal{M}$  can be reorganized into equivalence classes

---

\*Simply connected: Every closed curve can be contracted to a point,  $H^1(\mathcal{M}, U(1))$  is trivial.

of homotopic paths. It is this structure which is reflected by the first homotopy group. To maintain the picture of the path integral, one is then tempted to carry it out separately in each homotopy class. It was shown by Schulman [11], that if the fundamental group is not trivial, the kernel  $K(y, t'; x, t)$  can be decomposed into a complex-weighted sum of sub-amplitudes  $K_\gamma(y, t'; x, t)$  indexed by an element  $\gamma \in \pi_1(\mathcal{M})$ ,

$$K(y, t'; x, t) = \sum_{\gamma \in \pi_1(\mathcal{M})} \chi(\gamma) K_\gamma(y, t'; x, t), \quad (2.5)$$

with  $\chi(\gamma)$  some complex weights. Each  $K_\gamma$  is given by (2.1) but with a measure  $[\mathcal{D}\varphi]_\gamma$  taking only paths from the class labeled by  $\gamma$ . Then, (2.3) requires that the  $\chi(\gamma)$  be phases [12],

$$\chi(\gamma)\chi(\gamma') = \chi(\gamma' + \gamma), \quad |\chi(\gamma)| = 1. \quad (2.6)$$

In other words,  $\chi(\gamma)$  must furnish a one-dimensional representation of the fundamental group  $\pi_1(\mathcal{M})$ . The problem is the ambiguity in the quantization process, since *a priori*, there are infinitely many inequivalent one-dimensional representations of  $\pi_1(\mathcal{M})$ . For example, on a 2-torus  $\mathbb{T}^2 = S^1 \times S^1$ , the fundamental group is  $\pi_1(\mathbb{T}^2) = \mathbb{Z}^2$ , and  $\chi$  will map an element  $n \in \mathbb{Z}^2$  to  $e^{2\pi i \theta \cdot n}$ , with  $\theta \in [0, 1] \times [0, 1] \subset \mathbb{R}^2$  being completely arbitrary.

This is a general result and always appears if the configuration space of a system is no longer simply connected. Thus it turns out that the inequivalent quantizations are classified by

$$\text{Hom}(\pi_1(\mathcal{M}), U(1)) \quad (\simeq H^1(\mathcal{M}, U(1))), \quad (2.7)$$

i.e. the set of unitary equivalence classes of one dimensional representations of the fundamental group (or the equivalent classes of flat line bundles with connection). This structure is also known as  $\theta$ -angles or *vacuum-angles* and lies at the origin of various physical phenomena like statistics of identical particles, the Aharonov-Bohm effect or the QCD vacuum angle.

### PERIODICITY CONDITIONS

Quantum mechanically, the complex ambiguity from (2.5) can be viewed as a choice for boundary conditions of the wave function. For that, consider the simple example of the quantization of a particle ( $m = 1$ ) confined to  $S^1$  (i.e. the circle). With the simple Hamiltonian  $\hat{H} = -\frac{\hbar}{2}\partial_\varphi^2$  one can directly calculate the kernel:

$$K(\varphi_1, t_1; \varphi_0, t_0) = \langle \varphi_1 | e^{-\frac{i}{\hbar}\hat{H}(t_1-t_0)} | \varphi_0 \rangle = \sum_n \Psi_n(\varphi_1) \Psi_n^*(\varphi_0) e^{-\frac{i}{\hbar}E_n(t_1-t_0)}, \quad (2.8)$$

by insertion of a complete set of energy eigenstates, which are given by  $\Psi_n(\varphi) = \frac{1}{\sqrt{2\pi}} e^{in\varphi}$  with energy eigenvalues  $E_n = \frac{\hbar^2 n^2}{2}$ . These eigenfunctions are *periodic*, i.e.  $\Psi_n(0) = \Psi_n(2\pi)$ . Using Poisson resummation  $\sum_n f(n) = \sum_k \hat{f}(k)$  with the Fourier transform  $\hat{f}(k) = \int dn e^{-2\pi i n k} f(n)$ , one can directly perform the sum (2.8). The result is

$$K(\varphi_1, t_1; \varphi_0, t_0) = \sum_k \chi(k) \frac{1}{\sqrt{2\pi i \hbar (t_1 - t_0)}} \exp \left\{ \frac{i}{2\hbar} \frac{((\varphi_1 + 2\pi k) - \varphi_0)^2}{(t_1 - t_0)} \right\}. \quad (2.9)$$

With  $\chi(k) = 1, \forall k$ , introduced for convenience, this is nothing but the sum over  $\tilde{K}((\varphi_1 + 2\pi k), t_1; \varphi_0, t_0)$ , i.e.  $\tilde{K}$  is exactly the solution of (2.1) for a free particle on  $\mathbb{R}$ . The tilde notation shall indicate that it is the free propagator on the universal covering space of  $S^1$ , that is,  $\mathbb{R}$ . Clearly, this is a decomposition into homotopic equivalence classes of paths, since for each  $k \in \mathbb{Z}$ , the end point  $(\varphi_1 + 2\pi k)$  is shifted by an element of the fundamental group, which is, for the circle,  $\pi_1(S^1) = \mathbb{Z}$ . We can thus identify  $K_\gamma$  and  $\gamma \in \pi_1(\mathcal{M})$  in (2.5) with  $\tilde{K}((\varphi_1 + 2\pi k), t_1; \varphi_0, t_0) \equiv \tilde{K}_k$  and  $k \in \pi_1(S^1)$ .

But what about the weights  $\chi(\gamma)$  all equal to one? For that, simply recalculate the kernel (2.8), but this time with *quasi-periodic* boundary conditions for the energy eigenfunctions, i.e.  $\Psi_n(0) = e^{2\pi i \theta} \Psi_n(2\pi)$ , where  $\theta$  is an arbitrary parameter. The appropriate states are  $\Psi_n(\varphi) = \frac{1}{\sqrt{2\pi}} e^{i(n-\theta)\varphi}$  with energies  $E_n = \frac{\hbar^2}{2}(n-\theta)^2$ . Inserting this data into the sum in (2.8) yields

$$K(\varphi_1, t_1; \varphi_0, t_0) = \frac{1}{2\pi} \sum_n \exp \left\{ -i(n-\theta)(\varphi_1 - \varphi_0) - \frac{i\hbar}{2}(n-\theta)^2(t_1 - t_0) \right\}. \quad (2.10)$$

This sum is (after Poisson resummation) equal to (2.9) for  $\chi(k) = e^{2\pi i \theta k}$ . The quasi-periodicity is an arbitrary parameter, since  $|\Psi_n|^2$  stays periodic. Nonetheless, different values of  $\theta$  correspond to different energy spectra, i.e. different physics. The mathematical quantization procedure itself is consistent in each case, but the experiment has to decide which version is realized by nature.

## INDISTINGUISHABLE PARTICLES

The configuration space can even be more abstract and generally needs not to be interpreted as a real space where a particle is moving in. The path integral approach, however, stays valid and there are more bizarre topological phenomena. For example, consider a system of  $N$  indistinguishable identical particles moving on  $\mathbb{R}^d$ . The configuration space  $\mathcal{M}_N$  will be different from  $(\mathbb{R}^d)^N$ , since one should identify configurations which differ only by the order of the particles. Furthermore, there are never 2 particles at the same place, so one has to remove the diagonal. Generally, then, the configuration space is

$$\mathcal{M}_N = ((\mathbb{R}^d)^N - \Delta) / \Sigma_N, \quad (2.11)$$

with

$$\Delta = \left\{ (r_1, \dots, r_N) \in (\mathbb{R}^d)^N \mid r_i = r_j \text{ whenever } i \neq j \right\}, \quad (2.12)$$

where the quotient with respect to the permutation group  $\Sigma_N$  was taken as well. It turns out that the fundamental group of  $\mathcal{M}_N$  is given [13] by

$$\pi_1(\mathcal{M}_N) = \begin{cases} \Sigma_N & \text{if } d \geq 3 \\ \mathcal{B}_N & \text{if } d = 2 \end{cases} \quad (2.13)$$

with  $\mathcal{B}_N$  being the Artin braid group. Such considerations (which I will not follow here) lead to anyonic behavior, for example the anyonic statistics of particles confined to a two-dimensional surface in the quantum Hall regime. The braid group becomes important when magnetic translations for strings will be analyzed.

### TOPOLOGICALLY NON TRIVIAL BACKGROUND FIELDS

The path integral formulation of the transition amplitude is very convenient if one is interested in, say, a charged particle in a magnetic field  $\vec{B}$ . In this case, the effect of a magnetic field is to replace the integrand in (2.4) by

$$e^{-S[\varphi]} \xrightarrow{B\text{-field}} e^{-S[\varphi]} \mathcal{A}[\varphi], \quad (2.14)$$

where  $\mathcal{A}[\varphi]$  shall be referred to as the *magnetic amplitude*. It contains the vector potential  $\vec{A}$  integrated along the chosen paths. As a consequence, a quantum mechanical particle moving inside a magnetic field along a path  $\varphi$  from  $x$  to  $y$  picks up a phase

$$\mathcal{A}[\varphi] = \exp\left\{\frac{ie}{\hbar c} \int_{\varphi} \vec{A} \cdot d\vec{x}\right\} \quad (2.15)$$

which is nothing but the 'holonomy' of  $\vec{A}$  along  $\varphi$ .

However, there is a type of topological configurations that might pose quantization problems, namely background fields that are given only *locally*. A prominent example is a particle moving in the field of Dirac's magnetic monopole [14] which casts light on the fascinating relationship between physics and geometry. Dirac ignored the divergence-free magnetic field and thus one of Maxwell's equations by assuming

$$\vec{\nabla} \cdot \vec{B} = \varrho_M \neq 0 \quad (2.16)$$

because he felt that such an object is worth thinking about anyway. His Gedankenexperiment opened the door for differential geometry to enter physics. The problem is, even if there is a well defined magnetic field everywhere on

$$\mathcal{M} = \mathbb{R}^3 \setminus \{0\}, \quad (2.17)$$

there is no globally non-singular vector potential such that  $\vec{B} = \vec{\nabla} \times \vec{A}$ . One says that  $\vec{B}$  is *not globally exact*. The topology of the problem is that of a sphere  $S^2$  with the monopole located at the origin  $\varrho_M(\vec{x}) = 4\pi g \delta^3(\vec{x})$ , and calculating

$$\int_{S^2} \vec{B} \cdot d\vec{S} = \int_V \varrho_M(\vec{x}) d^3\vec{x} = 4\pi g \neq 0 \quad (2.18)$$

as well as

$$\int_{S^2} \vec{B} \cdot d\vec{S} = \int_{\partial S} \vec{A} \cdot d\vec{x} = 0 \quad (2.19)$$

leads to a contradiction. The solution is to choose at least two vector potentials  $\vec{A}_+$  and  $\vec{A}_-$  on different domains  $\mathcal{U}_+$  and  $\mathcal{U}_-$  covering the upper and lower hemisphere of  $S^2$  with a non-vanishing intersection  $\mathcal{U}_+ \cap \mathcal{U}_-$ . Since  $\vec{B} = \nabla \times \vec{A}_{\pm}$ , both vector potentials must differ on the intersection by a gauge transformation

$$\vec{A}_- - \vec{A}_+ = \vec{\nabla} \Lambda. \quad (2.20)$$

Without going into the computational details<sup>†</sup>, an appropriate choice would be in spherical coordinates  $(r, \phi, \theta)$

$$\begin{aligned}\vec{A}_+ &= g \frac{1-\cos\theta}{r \sin\theta} \hat{\phi} & \text{on } \mathcal{U}_+ \\ \vec{A}_- &= -g \frac{1+\cos\theta}{r \sin\theta} \hat{\phi} & \text{on } \mathcal{U}_-\end{aligned}\quad (2.21)$$

such that one can find  $\Lambda(\phi) = -2g\phi$ . Since a gauge transformation also involves the wave functions,

$$\psi_- = \exp\left\{\frac{ie}{\hbar c}\Lambda\right\}\psi_+, \quad (2.22)$$

consistency at the coordinates  $\phi = 0 \leftrightarrow \phi = 2\pi$  leads to the quantization of the monopole charge, i.e.

$$g = \frac{\hbar c}{2|e|}n, \quad n \in \mathbb{N}. \quad (2.23)$$

The natural mathematical object is thus given by a manifold  $\mathcal{M}$  which has to be covered with open sets  $\{\mathcal{U}_i\}$ . For background fields, on each such open set  $\mathcal{U}_i$  there is defined a vector potential  $A_i$  and on every intersection  $\mathcal{U}_i \cap \mathcal{U}_j$ , the two vector potentials  $A_i$  and  $A_j$  are related by a gauge transformation. This leads automatically to the concept of line bundles with connection, where the transition functions play the role of gauge transformations and the sections over the bundle represent the wave functions. All these geometrical relations will be specified in more detail in one of the following sections. Dirac's flux quantization can then be understood as  $B$  (viewed as the curvature of the respective line bundle) belonging to a certain cohomology group  $H^2(\mathcal{M}, 2\pi\mathbb{Z})$ .

In that case, the action functional  $S[\varphi]$  appearing in the path integral formula (2.4) must be constructed from the local data of the line bundle, leading to the interpretation of the propagator as a linear map between fibres.

### AHARONOV-BOHM EFFECT

In 1959 the 'significance of electromagnetic potentials in quantum theory' [15] was not so clear as for us, for we already know that the experiments were quite successful. It is the vector potential that becomes important because of (2.15), at least quantum mechanically. In Aharonov's and Bohm's experiment the phase shift

$$\Delta S = \exp\left\{\frac{ie}{\hbar c} \oint \vec{A} \cdot d\vec{x}\right\} \quad (2.24)$$

appears even in the case  $\vec{B} = 0$ . The phase difference can be interpreted as a pure topological phase. Indeed, *the solenoid placed between the two slits removes a point from the configuration space*, thus changing the topology to

$$\mathcal{M} = \mathbb{R}^2 \setminus \{0\} \quad (2.25)$$

with the solenoid located at the origin. There are then (among all the others) two paths from different homotopy classes: The path that passes the first slit, and the path that goes through

---

<sup>†</sup>This example is the most basic one and appears in almost every textbook about topology and gauge fields.

the second one. They cannot be deformed continuously into each other, because the electrons are excluded from the point where the solenoid is located. Topologically, the vector potential  $\vec{A}$  is not globally exact, since this would mean the existence of a continuous and differentiable function  $f \in C^\infty(\mathcal{M})$  such that  $\vec{A} = \vec{\nabla}f$  which is not the case because otherwise  $\Delta S$  would be zero due to Stoke's law.

## § 2.2 GLOBALLY EXACT MAGNETIC TRANSLATIONS

As a preparation for the derivation of magnetic translations in the topologically non-trivial case, let us recall their appearance for a charged particle moving on the plane  $\mathbb{R}^2$  from quantum mechanics. As the lattice group, we take  $G = \mathbb{Z}^2$ . The constant magnetic field shall point perpendicularly to the plane, i.e.  $\vec{B} = (0, 0, B)$ , and is of course invariant under lattice translations. One can choose a magnetic potential in the symmetric gauge  $\vec{A} = \frac{1}{2}\vec{B} \times \vec{x} = \frac{1}{2}(-By, Bx, 0)$  such that  $\vec{B} = \text{rot } \vec{A}$ . For such a system, the Hamilton operator is given by

$$\hat{H}_L = \frac{1}{2m}(\hat{p} - \frac{e}{c}\vec{A})^2 = -\frac{\hbar^2}{2m} \left[ \left( \frac{\partial}{\partial x} + \frac{ieB}{2\hbar c}y \right)^2 + \left( \frac{\partial}{\partial y} - \frac{ieB}{2\hbar c}x \right)^2 \right] \quad (2.26)$$

and has the Landau levels as energy eigenstates. Because of the magnetic field, the usual translation symmetry by a lattice vector  $\vec{g}$  is broken, unless the group of translations is replaced by the magnetic translation group (MTG) [16] whose elements  $T_{\vec{g}}$  act as

$$(T_{\vec{g}}\psi)(\vec{x}) = e^{\frac{ie}{2\hbar c}\vec{B}\cdot(\vec{x}\times\vec{g})} \psi(\vec{x} + \vec{g}). \quad (2.27)$$

These operators commute with the Hamiltonian and are the usual translations followed by a gauge transformation of  $\psi$  due to the additional phase. Let us give a name to that phase,

$$\phi_{\vec{g}}(\vec{x}) := e^{\frac{ie}{2\hbar c}\vec{B}\cdot(\vec{x}\times\vec{g})}. \quad (2.28)$$

The operators  $T_{\vec{g}}, \vec{g} \in \mathbb{Z}^2$ , form a *projective* representation of translations [17] and generate an algebra which is no longer commutative. Indeed, it is instructive to compare two successive translations  $T_{\vec{g}}T_{\vec{h}}$  with the application of  $T_{\vec{g}+\vec{h}}$ . There is a phase mismatch,

$$T_{\vec{g}}T_{\vec{h}} = e^{\frac{ie}{2\hbar c}\vec{B}\cdot(\vec{g}\times\vec{h})} T_{\vec{g}+\vec{h}} \quad (2.29)$$

which depends only on the lattice vectors  $\vec{g}$  and  $\vec{h}$ . Let us give a name to that phase,

$$\omega_{\vec{g},\vec{h}} := e^{\frac{ie}{2\hbar c}\vec{B}\cdot(\vec{g}\times\vec{h})}. \quad (2.30)$$

The phase  $\omega_{\vec{g},\vec{h}}$  is called a *2-cocycle*. This stems from the fact that the operators  $T_{\vec{g}}$  acting on wave functions should form an associative algebra, i.e.

$$T_{\vec{g}}(T_{\vec{h}}T_{\vec{k}}) = (T_{\vec{g}}T_{\vec{h}})T_{\vec{k}} \quad , \quad \forall g, h, k \in \mathbb{Z}^2, \quad (2.31)$$

and an explicit computation yields a relation for the phase  $\omega_{\vec{g},\vec{h}}$ ,

$$\omega_{\vec{h},\vec{k}}\omega_{\vec{g},\vec{h}+\vec{k}} = \omega_{\vec{g},\vec{h}}\omega_{\vec{g}+\vec{h},\vec{k}}. \quad (2.32)$$

Thus (2.32) defines what a 2-cocycle is. Physically,  $\omega_{\vec{g},\vec{h}}$  represents the exponential of the magnetic flux through the surface spanned by  $\vec{g}$  and  $\vec{h}$ . Notice that  $\omega_{\vec{g},\vec{h}}$  can be written as

$$\omega_{\vec{g},\vec{h}} = \vec{g}^* \phi_{\vec{h}} (\phi_{\vec{g}+\vec{h}})^{-1} \phi_{\vec{g}} \quad (2.33)$$

for reasons that will concern us later. Here, the 'pull-back'

$$\vec{g}^* \phi(\vec{x}) := \phi(\vec{x} + \vec{g}) \quad (2.34)$$

is introduced because  $\omega$  is constant and the  $\vec{x}$ -dependence of  $\phi$  has been dropped.

The operators  $T_{\vec{g}}$  are considered to be a symmetry of the system (they commute with the Hamiltonian) and should therefore commute with the propagator. This means that, in principle, the information about the phase  $\phi$  which accompanies the magnetic translations, could be extracted from the path-integral's magnetic amplitude. From equation (2.15), a path  $\varphi$  from  $\vec{x}$  to  $\vec{y}$  gives the amplitude

$$\mathcal{A}[\varphi] = e^{\frac{ie}{\hbar c} \int_{\varphi} \vec{A} \cdot d\vec{x}}. \quad (2.35)$$

Now simply compare this amplitude with the 'translated' amplitude

$$\mathcal{A}[\varphi \cdot \vec{g}] = e^{\frac{ie}{\hbar c} \int_{\varphi} \vec{g}^* \vec{A} \cdot d\vec{x}} \quad (2.36)$$

where  $\varphi \cdot \vec{g}$  stands for the path but shifted by the lattice vector  $\vec{g}$ . For their ratio, one finds

$$\frac{\mathcal{A}[\varphi \cdot \vec{g}]}{\mathcal{A}[\varphi]} = \left[ e^{\frac{ie}{2\hbar c} \vec{B} \cdot (\vec{x} \times \vec{g})} \right] \left[ e^{-\frac{ie}{2\hbar c} \vec{B} \cdot (\vec{y} \times \vec{g})} \right] = \phi_{\vec{g}}(\vec{x}) \phi_{\vec{g}}^{-1}(\vec{y}), \quad (2.37)$$

which corresponds to the phases that appear if one acts on the 'incoming'  $\psi(\vec{x})$  and 'outgoing'  $\psi(\vec{y})$  with magnetic translations.

The aim of the next sections is to derive these magnetic translations in cases, where the fields are not globally exact. Although all this is in principle well known<sup>†</sup> some basic facts about the local constructions [2] have to be recalled. As we want to apply the path integral method just used to derive the phases  $\phi_{\vec{g}}$ , we have to construct the action (at least the magnetic part) from the local data of the associated line bundle. Magnetic fields and vector potentials will be described by differential forms carrying their local index of the open set  $\mathcal{U}$  they are defined on. Let us start with some remarks about bundles. From now on,  $m = e = c = \hbar = 1$ .

### § 2.3 SOME REMARKS ABOUT BUNDLES AND SOME COHOMOLOGY

To start with, consider a quantum mechanical particle propagating on a manifold  $\mathcal{M}$  in the presence of a magnetic field  $B$ , which is a 2-form on  $\mathcal{M}$ , denoted  $B \in \Omega^2(\mathcal{M})$ . In general  $B$  is not globally exact ( $B \neq dA$ ). It is, however, closed, i.e. it is assumed that the Bianchi

---

<sup>†</sup>Well, in principle.

identity  $dB = 0$  is fulfilled. Let  $\{\mathcal{U}_i\}$  denote a sufficiently fine open covering of  $\mathcal{M}$ . For technical reasons, it is assumed that  $\{\mathcal{U}_i\}$  is a contractible open cover, that is, every open set as well as any non-empty finite multiple intersection of these is contractible to a point.

By Poincaré's lemma, on each open chart  $\mathcal{U}_i$ , one finds  $B_i \equiv B|_{\mathcal{U}_i}$  to be exact, i.e.  $\exists A_i \in \Omega^1(\mathcal{U}_i)$  such that  $dA_i = B_i$ . For the consistent construction of a complex (Hermitian) line bundle  $\mathcal{L}$  [18, 19], it is required to have well defined  $U(1)$ -valued transition functions  $f_{ij}$ , relating the connection 1-forms  $A_i$  on double intersections  $\mathcal{U}_i \cap \mathcal{U}_j$ . The full local data of the bundle with connection is then given by the defining equations

$$\begin{cases} B_i = dA_i & \text{on } \mathcal{U}_i \\ A_j - A_i = i \, d \log f_{ij} & \text{on } \mathcal{U}_i \cap \mathcal{U}_j \\ f_{ik} f_{kj} f_{ji} = 1 & \text{on } \mathcal{U}_i \cap \mathcal{U}_j \cap \mathcal{U}_k \end{cases}, \quad (2.38)$$

where the last equation is equivalent to the statement, that the de Rham cohomology class  $[B]$  belongs to  $H^2(\mathcal{M}, 2\pi\mathbb{Z})$ , which is due to the de Rham isomorphism between Čech- and de Rham cohomology [20]. For differential forms,  $H^p(\mathcal{M})$  denotes the  $p^{\text{th}}$  de Rham cohomology group, which is the space of equivalence classes of closed real  $p$ -forms  $\in \Omega^p(\mathcal{M})$ , with two forms regarded as equivalent if they differ by an exact form. Analogously, Čech  $q$ -cocycles are elements in  $H^q(\mathcal{M}, \mathcal{G}(\{\mathcal{U}_i\}))$ , where  $\mathcal{G}(\{\mathcal{U}_i\})$  denotes the sheaf  $C^\infty(\mathcal{M}, U(1))$  or  $\Omega^p(\mathcal{M})$  subordinate to the open covering  $\{\mathcal{U}_i\}$ .

The transition functions  $f_{ij} = f_{ji}^{-1}$  relate sections defined locally by complex valued functions  $\psi_i$  on twofold overlappings, i.e.  $\psi_i = f_{ij} \psi_j$  on  $\mathcal{U}_i \cap \mathcal{U}_j$ . The de Rham differential  $d$  together with the 1-forms  $A_i$  define a connection with globally defined curvature  $B$ . Here,  $\nabla_i = d - iA_i$ , which is the covariant derivative that results from the minimal coupling prescription. Generally, a connection  $\nabla$  is an operator that assigns a 1-form with values in  $\mathcal{L}$  to each section,

$$\nabla : \Gamma(\mathcal{M}, \mathcal{L}) \rightarrow \Gamma(\mathcal{M}, \mathcal{L}) \otimes \Omega^1(\mathcal{M}) \quad (2.39)$$

such that  $\nabla(f\psi) = (df)\psi + f\nabla\psi$  for any  $f \in C^\infty(\mathcal{M})$ . Furthermore, the transition functions 'glue' together the local pieces, i.e.

$$\begin{aligned} f_{ij}(\nabla\psi)_j &= f_{ij}(d - iA_j)\psi_j \\ &= f_{ij}(d - iA_i + f_{ij}^{-1}df_{ij})\psi_j \\ &= (d - iA_i)\psi_i \\ &= (\nabla\psi)_i. \end{aligned} \quad (2.40)$$

As in GQ, the sections are interpreted as the quantum mechanical wave functions building up the Hilbert space of states of the system. For that,  $\mathcal{L}$  must be equipped with an Hermitian pairing (compatible with the connection in the usual sense [1]) defining a scalar product.

## INTEGRABILITY AND CLASSIFICATION

Complex line bundles with connection  $(\mathcal{L}, \nabla)$  are classified by their first Chern class [19], which is an element of  $H^2(\mathcal{M}, 2\pi\mathbb{Z})$ . Indeed, their very existence *requires* the integrality condition

to be valid for the curvature, i.e.  $[B] \in H^2(\mathcal{M}, 2\pi\mathbb{Z})$ . To understand why this is related to the third relation of (2.38), write the transition functions as  $f_{ij} = e^{iu_{ij}}$ . For the real-valued functions  $u_{ij}$ , it is necessary to fulfill  $z_{ijk} := u_{ik} + u_{kj} + u_{ji} \in 2\pi\mathbb{Z}$ . Thus, there is an integral Čech 2-cocycle  $z_{ijk}$ , since  $(\check{\delta}z)_{ijkl} := z_{jkl} - z_{ikl} + z_{ijl} - z_{ijk} = 0$  on  $\mathcal{U}_i \cap \mathcal{U}_j \cap \mathcal{U}_k \cap \mathcal{U}_l$ . It is this Čech 2-cocycle whose class is in  $H^2(\mathcal{M}, 2\pi\mathbb{Z})$  (with coefficients in the sheaf of constant functions) and coincides by de Rham's isomorphism with the class defined by  $[B]$ . The Čech coboundary operator  $\check{\delta}$  is taken to be the standard one, and will be given explicitly in the sequel when we start calculations.

More down-to-earth, all this means that the integral of  $B$  over any closed 2-dimensional submanifold must be an integral multiple of  $2\pi$ . This is nothing but Dirac's quantization of the magnetic monopole charge. By Stoke's theorem, the holonomy for any closed curve  $\gamma$  in  $\mathcal{M}$  with respect to  $\nabla$  is equal to the integral of  $B$  over a surface  $\Sigma$  with  $\partial\Sigma = \gamma$ . Since one can choose *any* such surface, the integral over a *closed* surface must<sup>§</sup> [21] be a multiple of  $2\pi$ . For trivial bundles, if  $B$  is globally exact, the integrality condition is always true.

Apart from the usual gauge ambiguity, which replaces  $A_i$  by  $A_i + i \log \eta_i$ , the transition functions  $f_{ij}$  by  $\eta_i^{-1} f_{ij} \eta_j$  and the sections  $\psi_i$  by  $\eta_i^{-1} \psi_i$ , there is an ambiguity in the definition of the transition functions  $f_{ij}$  themselves. One can replace  $f_{ij}$  by  $f_{ij} \cdot c_{ij}$ , where  $c_{ij}$  are *constants* such that  $c_{ij} = c_{ji}^{-1}$  and  $c_{ik} c_{kj} c_{ji} = 1$ , while the potentials are left unchanged. The net effect is that one obtains another bundle with connection  $(\mathcal{L}', \nabla')$  which has the same curvature. A bundle with constant transition functions has a vanishing curvature and the replacement  $f_{ij} \rightarrow f_{ij} \cdot c_{ij}$  is equivalent to tensoring  $(\mathcal{L}, \nabla)$  with a flat line bundle  $(\mathcal{F}, \nabla_{\mathcal{F}})$ , since  $\mathcal{L} \otimes \mathcal{F}$  has transition functions  $f_{ij} \cdot c_{ij}$  while the potentials are added. Conversely, taking any two bundles with connection and identical curvature, their difference (in the sense of tensoring the first with the dual of the second) will yield a flat line bundle. Up to constant gauge transformations, this degree of freedom lies exactly in the constant Čech-1-cocycle  $c_{ij}$ , which gives a classification of flat line bundles by elements in  $H^1(\mathcal{M}, U(1))$ . Cohomologically, this can be understood by the short exact sequence of sheaves [1]

$$0 \rightarrow 2\pi\mathbb{Z} \rightarrow \mathbb{R} \xrightarrow{\exp} U(1) \rightarrow 0 \quad (2.41)$$

which induces a long exact sequence of cohomology groups

$$0 \rightarrow H^1(\mathcal{M}, 2\pi\mathbb{Z}) \rightarrow H^1(\mathcal{M}, \mathbb{R}) \rightarrow H^1(\mathcal{M}, U(1)) \xrightarrow{\sigma} H^2(\mathcal{M}, 2\pi\mathbb{Z}) \rightarrow H^2(\mathcal{M}, \mathbb{R}) \rightarrow \dots \quad (2.42)$$

showing that two topologically equivalent flat line bundles (having the same Chern class in the image of the connecting morphism  $\sigma$ ) may have inequivalent connections labeled by an element in  $H^1(\mathcal{M}, U(1))$ . Note, that if the space under consideration is simply connected,  $H^1(\mathcal{M}, U(1)) = 0$ , the choice of a line bundle is unique up to equivalence. Here we meet the same classification as in the last section, since the topology dependence can be made clear by the isomorphism (2.7)

$$H^1(\mathcal{M}, U(1)) \simeq \text{Hom}(\pi_1(\mathcal{M}), U(1)), \quad (2.43)$$

---

<sup>§</sup>Take a sphere, paint a closed curve. The flux is the surface integral enclosed by the curve. Which surface to take? There are two, the one inside and the one outside (which is in fact on a sphere also inside but with opposite orientation!) There is only one *topological* possibility: Both results must agree.

with  $\pi_1(\mathcal{M})$  the fundamental group, but the reasoning lies only with the bundle itself. The result is the same, a non-trivial topology  $\pi_1(\mathcal{M}) \neq 0$  will lead to the existence of nonequivalent line bundles, which have the same curvature but nonequivalent connections.

## § 2.4 LOCAL CONSTRUCTION OF THE MAGNETIC AMPLITUDE

If everything is only locally defined, the evolution of the wave function (2.2) requires the use of a partition of unity. In short, a partition of unity is defined to be a family of differentiable functions  $\rho_i(x)$ ,  $x \in \mathcal{M}$  such that

$$\begin{aligned} i) \quad & 0 \leq \rho_i(x) \leq 1 \\ ii) \quad & \rho_i(x) = 0 \text{ if } x \notin \mathcal{U}_i \\ iii) \quad & \rho_1(x) + \rho_2(x) + \dots = 1 \text{ for any } x \in \mathcal{M} \end{aligned} \quad (2.44)$$

where it is assumed that  $\mathcal{M}$  is paracompact<sup>¶</sup>. Under this assumption, (2.2) reads in terms of the complex functions  $\psi_i$  defining the sections,

$$\psi'_j(y) = \sum_i \int dx \rho_i(x) K_{ji}(y, x) \psi_i(x). \quad (2.45)$$

The kernel  $K_{ji}(y, x)$  is now equipped with the indices of the open sets pertaining to the points  $x$  and  $y$  and is computed according to (2.4) and (2.14)

$$K_{ji}(y, x) = \int_{\substack{\varphi(a)=x \\ \varphi(b)=y}} [\mathcal{D}\varphi] e^{-S[\varphi]} \mathcal{A}_{ji}[\varphi]. \quad (2.46)$$

In (2.46), the magnetic amplitude is the only element that carries the local indices, as  $S[\varphi]$  only involves the kinetic term and does not require the use of the local potentials  $A_i$  and  $f_{ij}$ .

The holonomy of the connection along the chosen trajectory contained in  $\mathcal{A}_{ji}[\varphi]$  is constructed using the techniques introduced in [2]. Recall that a path in  $\mathcal{M}$  is the map  $\varphi$  from a fixed interval  $\ell$  into  $\mathcal{M}$ . Split the interval into segments  $s_i$ ,  $i = 1, \dots, n-1$ , and vertices  $v_j$ ,  $j = 1, \dots, n$ , such that  $\varphi(s_i) \subset \mathcal{U}_{\alpha_i}$  and  $\varphi(v_j) \in \mathcal{U}_{\beta_j}$  for a suitable assignment of open sets. Of course, this assignment is ambiguous, but the result should not depend on this choice. Since the vertices  $v_j$  bound the single segments, the holonomy can be calculated segment by segment. Every time, when there is a change of the chart, the transition functions are used to switch the potential according to  $A_j - A_i = \text{id} \log f_{ij}$  from the second equation in (2.38). It is obvious that the solution must be of the form

$$\mathcal{A}_{\beta_n \beta_1}[\varphi] = \exp \left\{ i \sum_{s_i \subset \ell} \int_{s_i} \varphi^* A_{\alpha_i} \right\} \prod_{\substack{s_i \subset \ell \\ v_j \in \partial s_i}} \varphi^* f_{\alpha_i \beta_j}^{-\epsilon(i,j)}(v_j). \quad (2.47)$$

Here,  $\varphi^*$  indicates the pull-back, i.e.  $\varphi^* f = f \circ \varphi$ , and  $\epsilon(i, j)$  takes the values  $+1$  if  $s_i$  is arriving at the corresponding vertex  $v_j$ , and  $-1$  otherwise. The precise procedure can be recovered from figure 2.1. For notational reasons and generality, rename the open sets  $\mathcal{U}_{\beta_1} \equiv \mathcal{U}_i$  and

<sup>¶</sup>The open cover  $\{\mathcal{U}_i\}$  is such that every point  $x \in \mathcal{M}$  is covered with a finite number of  $\mathcal{U}_i$ .

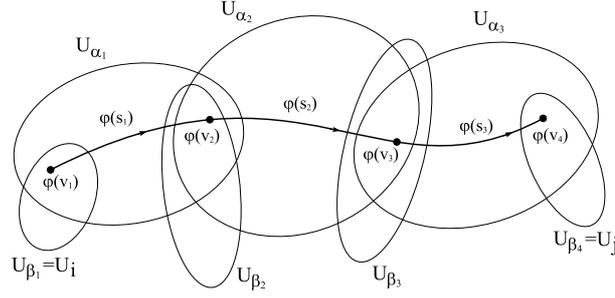

Figure 2.1: A path is split into segments and vertices.

$U_{\beta_n} \equiv U_j$  such that (2.47) becomes  $\mathcal{A}_{\beta_n \beta_1}[\varphi] \equiv \mathcal{A}_{ji}[\varphi]$  as in (2.46). Besides, the image under  $\varphi$  of the initial and the final vertex will be denoted by  $x \equiv \varphi(v_1)$ ,  $y \equiv \varphi(v_n)$  respectively.

Changing the triangulation of  $\ell$  and/or assigning different open sets, the amplitude (2.47) is completely invariant, up to the covering chosen at the end points. Indeed, changing  $U_i \rightarrow U_k$  and  $U_j \rightarrow U_l$ , the amplitude becomes

$$\mathcal{A}_{lk}[\varphi] = f_{lj}(y) \mathcal{A}_{ji}[\varphi] f_{ik}(x). \quad (2.48)$$

For example, consider the configuration of figure 2.1. From formula (2.47) one obtains the magnetic amplitude

$$\begin{aligned} \mathcal{A}_{ji}[\varphi] &= \exp \left\{ i \left( \int_{s_1} \varphi^* A_{\alpha_1} + \int_{s_2} \varphi^* A_{\alpha_2} + \int_{s_3} \varphi^* A_{\alpha_3} \right) \right\} \\ &\times f_{\alpha_1 i}(x) f_{\alpha_1 \beta_2}^{-1}(\varphi(v_2)) \\ &\times f_{\alpha_2 \beta_2}(\varphi(v_2)) f_{\alpha_2 \beta_3}^{-1}(\varphi(v_3)) \\ &\times f_{\alpha_3 \beta_3}(\varphi(v_3)) f_{\alpha_3 j}^{-1}(y). \end{aligned} \quad (2.49)$$

Using the cocycle condition for the transition functions  $f_{\alpha_1 i} f_{ik} = f_{\alpha_1 k}$  at the vertex  $x$  and  $f_{\alpha_3 j} f_{jl} = f_{\alpha_3 l}$  at  $y$ , one easily verifies equation (2.48).

Under any intermediate change of an open set  $U_{\beta_i} \rightarrow U_{\beta'_i}$ , it is also invariant, since the  $\beta_i$ 's are only used to switch  $\alpha_i \rightarrow \alpha_{i+1}$ . For a change  $U_{\alpha_i} \rightarrow U_{\alpha'_i}$ , there is a contribution from the respective integral over  $A_{\alpha_i}$ , which transforms accordingly  $A_{\alpha'_i} = A_{\alpha_i} + i \, d \log f_{\alpha_i \alpha'_i}$ . One has thus a difference of  $\exp \int_{s_i} d \log f_{\alpha_i \alpha'_i} = f_{\alpha_i \alpha'_i}(\varphi(v_{i+1})) f_{\alpha_i \alpha'_i}^{-1}(\varphi(v_i))$ , which is cancelled by the corresponding terms stemming from the lower part of (2.49).

## GAUGE INVARIANCE

It is interesting to analyze the behavior of the magnetic amplitude under gauge transformations. Under such a transformation,  $A'_{\alpha_i} = A_{\alpha_i} + i \, d \log \eta_{\alpha_i}$ ,  $g'_{\alpha_i \beta_j} = \eta_{\alpha_i}^{-1} f_{\alpha_i \beta_j} \eta_{\beta_j}$  the ratio

of the corresponding magnetic amplitudes is, following (2.47),

$$\begin{aligned} \frac{\mathcal{A}'_{ji}[\varphi]}{\mathcal{A}_{ji}[\varphi]} &= \exp\left\{i \sum_{s_i \subset \ell} \int_{\varphi(s_i)} i \, d \log \eta_{\alpha_i}\right\} \prod_{\substack{s_i \subset \ell \\ v_j \in \partial s_i}} \left(\frac{\eta_{\beta_j}}{\eta_{\alpha_i}}\right)^{-\epsilon(i,j)} (\varphi(v_j)) \\ &= \prod_{\substack{s_i \subset \ell \\ v_j \in \partial s_i}} \eta_{\beta_j}^{-\epsilon(i,j)} (\varphi(v_j)) = \eta_j^{-1}(y) \eta_i(x) \end{aligned} \quad (2.50)$$

which is absorbed by the transformation of the wave functions  $\psi'_i = \eta_i^{-1} \psi_i$  and  $\psi'_j = \eta_j^{-1} \psi_j$ , as usual. In our context, we use a gauge transformation as an equivalence relation between bundles with connection, in the sense that all objects  $A_i$ ,  $f_{ij}$  and  $\psi_i$  are transformed at the same time, i.e.

$$\begin{aligned} A_i &\rightarrow A_i + i \, d \log \eta_i \\ f_{ij} &\rightarrow \eta_i^{-1} f_{ij} \eta_j \\ \psi_i &\rightarrow \eta_i^{-1} \psi_i \end{aligned} \quad (2.51)$$

for some  $U(1)$ -valued function  $\eta_i$ . Since we shall always work with the given local data  $(A_i, f_{ij}; \psi_i)$ , gauge invariance/transformations (probably the most important physical principle) will build up a basic guideline for consistency throughout a great number of calculations to be done. As a consequence there will be important observations justified purely by gauge invariance.

Once written down, the explicit expression of the magnetic amplitude always follows the same pattern and should be thought of exactly how it appears in (2.47). However, in our setting it will turn out to be very convenient to use a powerful abbreviation, which will be defined later within Deligne cohomology [2, 20]. For the moment, let us write the magnetic amplitude (2.47) for a path  $\varphi$  joining  $x = \varphi(v_1)$  to  $y = \varphi(v_n)$  symbolically as

$$\mathcal{A}_{ji}[\varphi] = \left[ e^{i \int_x^y \mathbf{A}} \right]_{ji}, \quad (2.52)$$

where *the use of a triangulation is self-understood* and it only depends on the open sets  $\mathcal{U}_i$  and  $\mathcal{U}_j$  used to cover the endpoints. Using this notation, gauge transformations act as

$$\left[ e^{i \int_x^y \mathbf{A}} \right]_{ji} \rightarrow \eta_j^{-1}(y) \left[ e^{i \int_x^y \mathbf{A}} \right]_{ji} \eta_i(x). \quad (2.53)$$

The crucial bold letter  $\mathbf{A}$  stands for both the 1-form potential  $A_i$  as well as the transition function  $f_{ij}$ . Bold letters will be defined in more detail in chapter 3.

## § 2.5 PROJECTIVE GROUP ACTION ON PARTICLE STATES

As pointed out in section 2.2, we are interested in the magnetic translation operators realizing the symmetry of the physical system under consideration. In our case the symmetry is given by a discrete group  $G$  and the magnetic translation operators shall lift this symmetry to the quantum states, i.e. the sections of the underlying line bundle. In our setup, a classical

symmetry would be diffeomorphisms of  $\mathcal{M}$  that leave the field strength  $B$  invariant. As we have already seen in section 2.2, a classical symmetry does not *a priori* give rise to a symmetry of the quantized theory due to the anomaly introduced by the 2-cocycle. In the local picture, the basic obstruction is that any diffeomorphism  $\mathcal{Q}$  of  $\mathcal{M}$  is not liftable to an isomorphism  $\hat{\mathcal{Q}}$  of the bundle  $\mathcal{L}$ , in the sense that the *pull-back bundle*  $g^*\mathcal{L}$  may not, in general, be isomorphic to  $\mathcal{L}$ .

However, if  $H^1(\mathcal{M}, U(1))$  is trivial, the pull-back bundle is isomorphic to  $\mathcal{L}$  and  $\hat{\mathcal{Q}}$  preserves the Hermitian structure and the connection. The lift is then defined only up to multiplication by elements of  $U(1)$  which gives rise to the *projective* representation of the symmetry group we already encountered for globally exact MTG.

Recall that a projective representation of a group respects the multiplication only modulo complex numbers. If  $\varrho$  is a representation of the group  $G$ , then  $\varrho(g)\varrho(h)$  is only proportional to  $\varrho(gh)$ , i.e.  $\varrho(g)\varrho(h) = \omega_{g,h} \varrho(gh)$ . The map  $\omega : G \times G \rightarrow U(1)$  satisfies the cocycle property  $\omega_{h,k}\omega_{g,hk} = \omega_{gh,k}\omega_{g,h}$ ,  $\forall g, h, k \in G$ , which ensures the associativity of the product. From the cohomological side of view,  $\omega$  defines a group cohomology class in  $H^2(G, U(1))$ . It is sometimes called the twist of the projective representation.

To start, consider a discrete group  $G$ , acting on  $\mathcal{M}$  from the right. We choose a right action of the group on the manifold  $\mathcal{M}$ , i.e.  $(x \cdot g) \cdot h = x \cdot (gh)$  for any  $x \in \mathcal{M}$  and  $g, h \in G$ , so that we have a standard left action of  $G$  by pull-back on differential forms. The pull-back action is defined for functions as  $g^*f(x) = f(x \cdot g)$  and more generally for differential forms by  $\int_{\mathcal{N}} g^*\omega = \int_{\mathcal{N} \cdot g} \omega$  for any  $n$ -form  $\omega$  and  $n$ -dimensional submanifold  $\mathcal{N} \subset \mathcal{M}$ . The pull-back action is also compatible with the de Rham differential in the sense that  $d(g^*\omega) = g^*(d\omega)$ . These properties of the pull-back action of  $G$  are essential in the following computations.

As already stated above the magnetic field  $B$  is considered to be invariant under the group action, which translates into the equation  $g^*B = B$  for any  $g \in G$ . We aim at finding the operators  $T_g$  that lift the action of  $G$  to the wave functions of the particle in such a way that the dynamics remains invariant. We assume that the action  $S[\varphi]$  is genuinely invariant, i.e. that  $S[\varphi \cdot g] = S[\varphi]$  for any path  $\varphi$  and  $g \in G$ .

To implement the group action on the locally defined gauge fields, it is convenient to work with a good invariant cover  $\{\mathcal{U}_i\}$  of  $\mathcal{M}$  by open sets  $\mathcal{U}_i$  that are stable by  $G$  and which are disjoint unions of contractible open sets. Acting with  $G$  on a section defined by  $\psi_i$  on  $\mathcal{U}_i$ , one finds that  $g^*\psi_i$  is a section of the pull-back bundle  $g^*\mathcal{L}$ . The latter is defined by the transition functions  $g^*f_{ij}$  and is equipped with the pull-back connection given by the forms  $g^*A_i$ . Because  $B$  is invariant under  $G$ , the two connections have the same curvature  $B$ . If  $H^1(\mathcal{M}, U(1))$  is trivial, which is the case for simply connected  $\mathcal{M}$ , the bundles  $\mathcal{L}$  and  $g^*\mathcal{L}$  are isomorphic as bundles with connections, so that there exists a function  $\phi_{g;i}$  such that

$$\begin{cases} g^*A_i - A_i &= i \, d \log \phi_{g;i} & \text{on } \mathcal{U}_i, \\ g^*f_{ij} (f_{ij})^{-1} &= \phi_{g;j} (\phi_{g;i})^{-1} & \text{on } \mathcal{U}_i \cap \mathcal{U}_j. \end{cases} \quad (2.54)$$

The  $U(1)$ -valued function  $\phi_{g;i}$  realizes the isomorphism since it takes a section of  $\mathcal{L}$  to a section of  $g^*\mathcal{L}$  as  $\psi_i \mapsto (\phi_{g;i})^{-1}\psi_i$  and transforms the local fields in the right way. Note, that the

explicit construction of  $\phi_{g;i}$  can be performed using Čech cohomology: One solves the first equation in (2.54), then the triviality of the cohomology group  $H^1(\mathcal{M}, U(1))$  shows that there is a common solution to both equations, unique up to a multiplicative constant.

Using this isomorphism, one can define the unitary operators  $T_g : \mathcal{H} \rightarrow \mathcal{H}$  locally by

$$(T_g \psi)_i = \phi_{g;i} g^* \psi_i, \quad (2.55)$$

which should be compared to eq. (2.27). The only difference is that the wave functions as well as the function  $\phi_{g;i}$  carry a local index  $i$  of an open set  $\mathcal{U}_i$ . Indeed, this is the geometrical explication for the phase  $\phi_{\bar{g}}$  in equation (2.28): It is the isomorphism between the pull-back bundle  $g^* \mathcal{L}$  and the original one  $\mathcal{L}$ .

As is easy to check,  $(T_g \psi)_i$  also defines a section of  $\mathcal{L}$ ,

$$\begin{aligned} (T_g \psi)_i &= \phi_{g;i} g^*(f_{ij} \psi_j) = \frac{\phi_{g;i} g^* f_{ij}}{\phi_{g;j} f_{ij}} \phi_{g;j} f_{ij} g^* \psi_j \\ &= f_{ij} (T_g \psi)_j, \end{aligned} \quad (2.56)$$

and  $T_g$  is composed out of two operations: First, it takes the pull-back of  $\psi$  which is a section of  $g^* \mathcal{L}$  and then the inverse of the previous isomorphism is used to come back to a section of  $\mathcal{L}$ .

Thus the map  $g \mapsto T_g$  provides a lift to the quantum setting of the classical symmetry group  $G$ . By construction, these operators commute with the connection  $\nabla$ ,

$$\begin{aligned} T_g(\nabla \psi)_i &= T_g(d - iA_i)\psi_i \\ &= \phi_{g;i}(g^* d\psi_i - ig^*(A_i \psi_i)) \\ &= \phi_{g;i}(d - ig^* A_i) g^* \psi_i \\ &= \phi_{g;i}(d + \phi_{g;i}^{-1} d\phi_{g;i} - iA_i) g^* \psi_i \\ &= (d - iA_i)\phi_{g;i} g^* \psi_i \\ &= \nabla_i(T_g \psi)_i. \end{aligned} \quad (2.57)$$

so that they also commute with the Hamiltonian which is constructed out of  $\nabla$ . This was the point of departure in paragraph 2.2. The commutativity of  $T_g$  with the connection therefore ensures that the  $T_g$  commute with the dynamics of the system, i.e. they should be derivable from the commutation with the propagator and its magnetic amplitude. This 'second' derivation will be performed after analyzing the appearance of the cocycle.

As mentioned (and expected), in quantum mechanics,  $g \mapsto T_g$  only provides a projective representation of  $G$ , and the twist can be computed by comparing

$$\begin{aligned} (T_g(T_h \psi))_i &= \phi_{g;i} g^*(T_h \psi)_i \\ &= \phi_{g;i} g^* \phi_{h;i} (gh)^* \psi_i \end{aligned} \quad (2.58)$$

$$(T_{gh} \psi)_i = \phi_{gh;i} (gh)^* \psi_i \quad (2.59)$$

so that one finds

$$T_g T_h = \omega_{g,h} T_{gh}, \quad (2.60)$$

where

$$\omega_{g,h} = \frac{g^* \phi_{h;i} \phi_{g;i}}{\phi_{gh;i}}. \quad (2.61)$$

The last equation should be compared to (2.33). Again,  $\omega$  is constant,

$$\begin{aligned} \text{id log } \omega_{g,h} &= \text{id log } g^* \phi_{h;i} + \text{id log } \phi_{g;i} - \text{id log } \phi_{gh;i} \\ &= g^* h^* A_i - g^* A_i + g^* A_i - A_i - (gh)^* A_i + A_i \\ &= 0 \end{aligned} \quad (2.62)$$

and does not depend on the open set  $\mathcal{U}_i$  used to compute it:

$$\begin{aligned} \frac{g^* \phi_{h;i} \phi_{g;i}}{\phi_{gh;i}} &= \frac{g^* \phi_{h;i} \phi_{g;i} \phi_{gh;j}}{g^* \phi_{h;j} \phi_{g;j} \phi_{gh;i}} \cdot \frac{g^* \phi_{h;j} \phi_{g;j}}{\phi_{gh;j}} = \frac{g^* f_{ij} f_{ij} (gh)^* f_{ij}}{g^* h^* f_{ij} g^* f_{ij} f_{ij}} \cdot \frac{g^* \phi_{h;j} \phi_{g;j}}{\phi_{gh;j}} \\ &= \frac{g^* \phi_{h;j} \phi_{g;j}}{\phi_{gh;j}}, \end{aligned} \quad (2.63)$$

where the second equation of (2.54) was used. Of course, it fulfills the cocycle identity

$$\omega_{h,k} \omega_{g,hk} = \omega_{gh,k} \omega_{g,h} \quad (2.64)$$

which ensures the associativity of the product of three operators,  $(T_g T_h) T_k = T_g (T_h T_k)$ . The special combination of  $\phi_{g;i}$  in (2.61) thus fulfills all necessary conditions to provide a projective representation with  $\omega$  defining an element in the group cohomology class  $H^2(G, U(1))$ . Notice that although the form of  $\omega$  by equation (2.61) might suggest that it is exact, it is not. This would have been the case if  $\phi$  were a constant instead of a function. As operators acting on the particle's Hilbert space  $\mathcal{H}$ , the operators  $T_g$  generate an algebra which is denoted by  $\mathbb{K}G^\omega$ . When the action is free (i.e. there is no fixed point),  $\mathbb{K}G^\omega$  is nothing but the twisted group algebra of  $G$  defined by the 2-cocycle  $\omega$ .

$T_g$  is not unique since one can always multiply  $\phi_{g;i}$  by a constant  $\alpha_g$ . This changes the cocycle  $\omega$  by a group coboundary,

$$\omega_{g,h} \rightarrow \omega_{g,h} \frac{\alpha_g \alpha_h}{\alpha_{gh}}, \quad (2.65)$$

which corresponds to an equivalent projective representation. Two projective representations are said to be equivalent, if the 2-cocycles define the same cohomology class, i.e. they differ by a group coboundary, which has the effect of multiplying each  $T_g$  by a factor  $\alpha_g$  not changing the algebraic structure.

We come now to the derivation of the magnetic translations  $T_g$  from the path integral (as we already did at the end of section 2.2). For that, it is used that the operators  $T_g$  are expected to be symmetries of the theory, which means that they commute with propagation. In short, this most important principle is

$$T_g K = K T_g. \quad (2.66)$$

Though this follows (2.57) from the commutation of  $T_g$  with  $\nabla$ , it is instructive to derive this in the path integral framework. To this aim, let us express the commutation relation  $T_g K = K T_g$  using the local forms of  $T_g$  and  $K$  given in (2.55) and (2.45). Starting with  $\psi_i$ , the local expression for  $K T_g \psi$  reads

$$(K T_g \psi)_j = \sum_i \int dx \rho_i(x) K_{ji}(y, x) \phi_{g;i}(x) \psi_i(x \cdot g), \quad (2.67)$$

whereas  $T_g K \psi$  yields

$$\begin{aligned} (T_g K \psi)_j &= \phi_{g;j}(y) \sum_i \int dx \rho_i(x) K_{ji}(y \cdot g, x) \psi_i(x) \\ &= \sum_i \int dx \rho_i(x) \phi_{g;j}(y) K_{ji}(y \cdot g, x \cdot g) \psi_i(x \cdot g). \end{aligned} \quad (2.68)$$

To obtain this equality, one has to perform a change of variables  $x \rightarrow x \cdot g$ , assuming that the measure (usually associated to the Riemannian metric involved in the kinetic term) and the partition of unity are  $G$ -invariant.

Accordingly, the commutation of  $T_g$  and  $K$  follows if

$$K_{ji}(y \cdot g, x \cdot g) = \phi_{g;i}^{-1}(y) K_{ji}(y, x) \phi_{g;i}(x). \quad (2.69)$$

Using (2.46), the propagator  $K_{ji}(y \cdot g, x \cdot g)$  is expressed as a path integral

$$K_{ji}(y \cdot g, x \cdot g) = \int_{\substack{\varphi'(a)=x \cdot g \\ \varphi'(b)=y \cdot g}} [\mathcal{D}\varphi'] e^{-S[\varphi']} \mathcal{A}_{ji}[\varphi']. \quad (2.70)$$

Then, we substitute  $\varphi' = \varphi \cdot g$ , assuming that the measure and the kinetic term  $S[\varphi]$  of the total action are genuinely invariant under  $G$ ,

$$K_{ji}(y \cdot g, x \cdot g) = \int_{\substack{\varphi(a)=x \\ \varphi(b)=y}} [\mathcal{D}\varphi] e^{-S[\varphi]} \mathcal{A}_{ji}[\varphi \cdot g]. \quad (2.71)$$

Then, (2.69) follows immediately from the transformation law of the magnetic amplitude,

$$\mathcal{A}_{ji}[\varphi \cdot g] = \phi_{g;j}^{-1}(y) \mathcal{A}_{ji}[\varphi] \phi_{g;i}(x). \quad (2.72)$$

This last relation is easily checked using (2.54) and the definition of the magnetic amplitude

(2.47) which gives explicitly for the ratio,

$$\begin{aligned}
\frac{\mathcal{A}_{ji}[\varphi \cdot g]}{\mathcal{A}_{ji}[\varphi]} &= \exp\left\{i \sum_{s_i \subset \ell} \int_{\varphi(s_i)} g^* A_{\alpha_i} - A_{\alpha_i}\right\} \prod_{\substack{s_i \subset \ell \\ v_j \in \partial s_i}} \left(\frac{g^* f_{\alpha_i \beta_j}}{f_{\alpha_i \beta_j}}\right)^{-\epsilon(i,j)}(\varphi(v_j)) \\
&= \exp\left\{i \sum_{s_i \subset \ell} \int_{\varphi(s_i)} i d \log \phi_{g; \alpha_i}\right\} \prod_{\substack{s_i \subset \ell \\ v_j \in \partial s_i}} \left(\frac{\phi_{g; \beta_j}}{\phi_{g; \alpha_i}}\right)^{-\epsilon(i,j)}(\varphi(v_j)) \\
&= \prod_{\substack{s_i \subset \ell \\ v_j \in \partial s_i}} \phi_{g; \alpha_i}^{-\epsilon(i,j)}(\varphi(v_j)) \left(\frac{\phi_{g; \beta_j}}{\phi_{g; \alpha_i}}\right)^{-\epsilon(i,j)}(\varphi(v_j)) \\
&= \phi_{g; j}^{-1}(y) \phi_{g; i}(x) \tag{2.73}
\end{aligned}$$

with our convention that the open set that covers the initial point  $x$  is  $\mathcal{U}_{\beta_1} \equiv \mathcal{U}_i$  and the one covering  $y$  is  $\mathcal{U}_{\beta_n} \equiv \mathcal{U}_j$ .

We arrived at the result pointed out when the ratio of the globally exact versions was computed (2.37). And again, alternatively, one could have directly determined the phase  $\phi_{g; i}$  by comparing the magnetic amplitude of  $\varphi$  and  $\varphi \cdot g$ . Then,  $\phi_{g; i}$  is defined such that (2.72) holds. This provides the phase that must accompany the pull-back action in the definition of  $T_g$  in such a way that it commutes with the propagator. The physical requirement, namely the commutation of the translation operators with the propagator, will influence the line of thought that will be adopted for a string in succeeding chapters. Besides, it turns out that this method is versatile enough to also encompass processes involving string interactions. But before going to interactions, there is a single string to handle which turns out to be very interesting. We have to generalize the local gauge fields to a 'higher dimensional' version, since the string is a 'higher dimensional' geometrical object. The mathematical object handling the local data of the fields is now called a *gerbe*<sup>||</sup> to be defined in the next chapter. For a brief idea of gerbes, see [3, 22].

---

<sup>||</sup>Oxford English Dictionary: **Gerbe**. 1698 [-Fr. *gerbe* wheat-sheaf] 1. A wheat-sheaf 1808. 2. Something resembling a sheaf of wheat: esp. a kind of firework.

---



---

## CHAPTER 3

---

### MAGNETIC TRANSLATIONS FOR STRINGS

*"Never calculate without first knowing the answer." – J. Wheeler*

In this chapter, a generalization of the previous construction for bosonic strings in the presence of a Kalb-Ramond (KR) field strength  $H$  on  $\mathcal{M}$  is presented. This construction is inspired by the application of orbifolds  $\mathcal{M}/G$  to string theory and the KR field is taken to be invariant under the orbifold group  $G$ . In analogy with the case of the particle in a  $B$ -field, the *stringy magnetic translations* are defined as the operators  $T_g^w$  that realize the action of  $g \in G$  on the twisted sectors which are strings of winding  $w$ . The idea makes use of the fact that the general form of these operators follows again from their commutation with string propagation along cylinders,

$$T \text{ (cylinder) } = \text{ (cylinder) } T \tag{3.1}$$

as was the case for the particle,  $T_g K = K T_g$ . Since in string theory, a simple cylinder should be thought of as the higher dimensional generalization of a particle world-line. It is assumed that one can find a similar algebraic structure for the stringy magnetic translations, i.e. a projective multiplication law.

However, because string interactions are by essence geometrical, the algebra generated by these operators is also expected to admit a much richer structure than in the case of a particle. Indeed, the action of  $T_g^w$  on two string states is constrained by its commutation with processes involving *pairs of pants*<sup>\*</sup>, which provides the algebra with an additional structure, called coproduct  $\Delta$ ,

$$T \text{ (pairs of pants) } = \text{ (pairs of pants) } \Delta T. \tag{3.2}$$

As a result, the stringy magnetic translations turn out to generate a *quasi-quantum group*  $D^\omega(KG)$ , first introduced by R. Dijkgraaf, V. Pasquier and P. Roche [23] in the context of

---

<sup>\*</sup>This is indeed the correct mathematical expression.

orbifold conformal field theory (CFT). The algebraic structure of  $D^\omega(\mathbb{K}G)$  is that of a twisted Drinfel'd quantum double, to be explained in chapter 4. For the moment, let us ignore the knowledge of any algebraic structure and naively start to analyze a propagating string.

### § 3.1 STRING ACTION AND CFT

As previously stated, describing a propagating string in space time is by its nature more complicated than the propagation of a particle. A string is a one-dimensional object, thus it will be described by a *world-sheet* instead of a world-line. A closed string for example traces out a tube in space-time, while an open string traces out a strip. Formally, one distinguishes an abstract 'world-sheet' from its image in space-time, sometimes confusingly called world-sheet, as well. To avoid this confusion, we shall adopt the notation that  $\Sigma$  is the image in space time of an abstract world-sheet  $\mathcal{S}$ . The abstract world-sheet  $\mathcal{S}$  is an area in parametrization space spanned by two coordinates  $(\sigma, \tau)$ , where  $\sigma$  indicates the string direction and  $\tau$  describes the propagation in time. The surface  $\Sigma$  in space-time  $\mathcal{M}$  is then described by a map (the field)

$$\varphi : \mathcal{S} \rightarrow \mathcal{M}. \quad (3.3)$$

One should think of  $\varphi(\mathcal{S}) \equiv \Sigma$  as the embedded surface in  $\mathcal{M}$  representing the history of a string, in the same way as a world-line represents the path of a particle.

Fields mapping a surface  $\mathcal{S}$  to a target manifold  $\mathcal{M}$ , both equipped with metric structures, are described by two-dimensional sigma models [24]. Such field configurations represent the evolution of a string, and the basic action functional of a classical bosonic string then reads [24, 25]

$$S[\varphi] = -\frac{1}{4\pi\alpha'} \int_{\mathcal{S}} d\tau d\sigma \sqrt{-\gamma} \gamma^{\alpha\beta} \eta_{\mu\nu} \partial_\alpha \varphi^\mu \partial_\beta \varphi^\nu \quad (3.4)$$

with  $\alpha'$  the string tension,  $\eta_{\mu\nu}$  is the Minkowski metric of the target space, and  $\gamma_{ab}$  the metric on  $\mathcal{S}$ . Here,  $\alpha, \beta \in \{1, 2\}$  indicate the  $\tau$ - and  $\sigma$ -directions, respectively. The action (3.4) is essentially the Nambu-Goto action, which can be seen by variation with respect to  $\gamma$  and then rewriting  $\gamma$  in terms of the 'induced' metric  $h_{\alpha\beta} = \partial_\alpha \varphi^\mu \partial_\beta \varphi^\nu \eta_{\mu\nu}$ . For the record, the important features of (3.4) are its symmetries: Apart from Lorentz/Poincaré-invariance, it is invariant under world-sheet reparametrizations. Writing  $\xi^1 = \sigma$  and  $\xi^2 = \tau$ , this is due to the transformation behavior of the measure of the Nambu-Goto action  $\sim \int d\xi^1 d\xi^2 \sqrt{-h}$ . The latter is invariant under a reparametrization  $(\tilde{\xi}^1(\xi^1, \xi^2), \tilde{\xi}^2(\xi^1, \xi^2))$  since the Jacobi-determinants are inverse of each other, yielding  $d\xi^1 d\xi^2 \sqrt{-h} = d\tilde{\xi}^1 d\tilde{\xi}^2 \sqrt{-\tilde{h}}$ .

The second important symmetry is its conformal invariance,  $\gamma_{\alpha\beta} \rightarrow \gamma'_{\alpha\beta} = e^{2\omega(\sigma, \tau)} \gamma_{\alpha\beta}$ . In the quantum setting, two-dimensional field theories exhibiting conformal invariance (CFT) are the adequate formulation for the two-dimensional string world sheets. This is particularly important for string interactions, where the perturbation expansion is built by considering two-dimensional conformal theories on surfaces of arbitrary topology. In this thesis, CFT is not what is targeted. However, we will make use of some general axiomatic ingredients which are most important, because of the application of a 'path integral' analogue. This does not exceed some basic axioms from [26].

Recall that, for the particle, the emphasis was placed on the algebraic structure of the operators  $T_g$  arising exclusively from the topological (magnetic) term. To mimic this procedure, let us analyze the coupling of a string to a 'magnetic' term, and after the extraction of the basic objects (which turn out to be differential forms) focus on the structure that arises solely from those. Since a string exhibits a supplementary dimension, the coupling to a background field, say, some type of magnetic field, will also involve objects of higher degree. In consequence, the Maxwell field  $A_\mu$  appearing in the action of a particle coupled to this field is replaced by a higher dimensional one, the 'Kalb-Ramond' field originally introduced in [27] as an antisymmetric two tensor  $B_{\mu\nu}$ , not to be confused with the magnetic field of the previous section ( $dA = B$ ). Now,  $B_{\mu\nu}$  must be understood as a *potential* whose derivative leads to a 3-form field, usually denoted  $H = dB$ , or in local coordinates

$$H_{\mu\nu\lambda} = \partial_\mu B_{\nu\lambda} + \partial_\nu B_{\lambda\mu} + \partial_\lambda B_{\mu\nu}. \quad (3.5)$$

It is the field strength  $H_{\mu\nu\lambda}$  which plays the role of the magnetic field in the particle's case,  $B_{\mu\nu} = \partial_\mu A_\nu - \partial_\nu A_\mu$ , and which is now a 3-form instead of a 2-form.

As a generalization to the free action (3.4), the coupling of a string to background fields is described by the  $\sigma$ -model action [28]

$$S = \frac{1}{4\pi\alpha'} \int_{\mathcal{S}} d^2\sigma \sqrt{\gamma} \left\{ (\gamma^{\alpha\beta} G_{\mu\nu}(X) + i\epsilon^{\alpha\beta} B_{\mu\nu}(X)) \partial_\alpha X^\mu \partial_\beta X^\nu + \alpha' \Phi R \right\}, \quad (3.6)$$

where  $G_{\mu\nu}$  is the metric of the target space,  $\Phi$  is the dilaton and  $B_{\mu\nu}$  is the Kalb-Ramond potential. The dilaton is a scalar field, which couples to the world-sheet metric through its Ricci scalar<sup>†</sup>. Such an action is reparametrization invariant and the kinetic term stays invariant under Weyl rescaling. However, the conformal symmetry cannot be maintained in the quantum theory, unless the target space fields  $G, H$  and  $\Phi$  obey some equations of motion reminiscent of Einstein's equations at the lowest order in  $\alpha'$  [28]. Although the KB field must be chosen such that conformal invariance is satisfied, we restrict ourselves to the analysis of this magnetic term, conveniently written as

$$\mathcal{A} = \exp\left\{i \int_{\Sigma} B\right\}. \quad (3.7)$$

Since it does not use the metric on  $\mathcal{S}$ , it is often called a topological term. In our context, it is this term (3.7) generating the interesting structure, the constants are ignored with no loss of generality. In analogy with the holonomy in the particle's case, the KR-term (3.7) is now the integral over  $B$  along the surface  $\Sigma = \varphi(\mathcal{S})$ .

To construct an orbifold string theory, some care is needed when dealing with the Kalb-Ramond field. Indeed, whereas the field strength  $H$  is invariant, this is not necessarily so for its potential 2-form  $B$ , exactly as was the case for the particle coupled to the potential 1-form  $A$ . Analogously, the relation  $H = dB$  may only hold locally on  $\mathcal{M}$ , so that one has to cover  $\mathcal{M}$  by patches  $\mathcal{U}_i$  and work with locally defined potentials  $B_i$ . Recall that for a bundle,

---

<sup>†</sup>The dilaton is introduced on the quantum level due to the requirement of renormalization.

two locally given potentials  $A_i$  and  $A_j$  have to be related by the transition functions  $f_{ij}$  on a two-fold overlapping  $\mathcal{U}_i \cap \mathcal{U}_j$ . For the KR-field, the posed question is how to relate two fields  $B_i$  and  $B_j$ . Since  $B_{i/j}$  are 2-forms, they will have to be related by the exterior derivative of a 1-form  $B_{ij}$ . But then, the 1-forms  $B_{ij}$ ,  $B_{jk}$  and  $B_{ki}$  will also have to be related on three-fold overlappings  $\mathcal{U}_i \cap \mathcal{U}_j \cap \mathcal{U}_k$  by 0-forms  $f_{ijk}$ , just to glue everything together smoothly. Indeed, such a construction exist and this is what makes the local data of a *1-gerbe* [22, 2, 29, 30].

Therefore, in order to handle all these fields and, additionally, their transformation laws under  $G$ , it is convenient to introduce a special mathematical object, called *tricomplex*, combining de Rham, Čech and group cohomologies. Starting with  $H$ , one obtains a sequence of locally defined fields by solving cohomological equations. As for the particle, the locally defined potentials (and the derived relations between them) are the basic ingredients entering the construction of the magnetic amplitudes for the twisted sectors. The latter are the phases describing the coupling of a string to the Kalb-Ramond field, i.e. (3.7) but constructed locally, and have to be inserted into the world-sheet path integral like the magnetic amplitude  $\mathcal{A}_{ji}$  had to be inserted into the path integral of the particle (2.14).

### § 3.2 TRICOMPLEX

As stated above, to construct all required relations that are necessary to define a consistent group action on a string wave function and the fields, we will make use of a tricomplex. To locally construct magnetic amplitudes, the required objects to work with are de Rham forms and Čech cochains. All these objects mix up due to the group action, so it seems natural to try to group them together as single elements with the required coboundary operators. For example, recall the first appearance of the bold potential  $\mathbf{A} = (A_i, f_{ij})$  in equation (2.52). This tuple contains the 1-form  $A_i$  which is a Čech 0-cochain as well as the transition functions  $f_{ij}$  as a 0-form with two Čech indices, i.e. a Čech 1-cochain. There is indeed systematics behind it. In the string's case, the interesting objects are the 2-forms  $B_i$ , 1-forms  $B_{ij}$  and functions (0-forms)  $f_{ijk}$  coming as 0-,1- and 2-Čech cochains. From the group action (2.54), one can read off the relations between the pulled-back fields  $g^*A_i$  and  $g^*f_{ij}$  and their untranslated pendants. This leads to the isomorphism  $\phi_{g;i}$  relating the line bundle  $\mathcal{L}$  with its pull-back. As a calibrating example, let us produce these equations with the help of the systematic method of the tricomplex. Once done, apply it to the higher degree case of the fields  $B_i$ ,  $B_{ij}$  and  $f_{ijk}$  and look what comes out.

To begin with, assume that  $\mathcal{M}$  has been covered with a good invariant cover  $\{\mathcal{U}_i\}$ . Define the tricomplex by cochains  $c_{p,q,r}$ , which are de Rham forms of degree  $p$ , defined on  $(q+1)$ -fold intersections  $\mathcal{U}_{i_0} \cap \dots \cap \mathcal{U}_{i_q}$  and which are functions of  $r$  group indices. For convenience, these cochains are real-valued for  $p \geq 1$  and  $U(1)$ -valued in the case  $p = 0$ . This convention comes with a little complication, namely, the additive notation for  $p > 0$  using '+' and '-' will switch to multiplication and the inverse in the case  $p = 0$ . Having the de Rham differential  $d$  in the  $p$ -direction, this means that for  $p = 0$ , we take  $\text{id} \log$ . Besides, elements  $c_{p,q,r}$  are completely antisymmetric in their indices labelling the open sets involved in the intersection,

where for  $p = 0$  the antisymmetry involves the inverse instead of the opposite. The directions of the corresponding coboundaries are chosen as in figure 3.1.

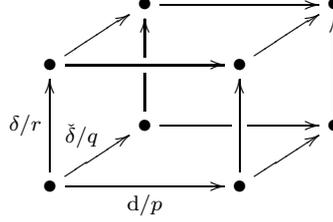

Figure 3.1: Directions of the coboundaries.

It is then straight forward to define the other two coboundary operators. In the  $q$ -direction, the Čech coboundary  $\check{\delta}$  is defined as

$$(\check{\delta}c)_{i_0, \dots, i_q} = \sum_{k=0}^q (-1)^k c_{i_0, \dots, \hat{i}_k, \dots, i_q} \quad (3.8)$$

where  $\hat{i}_k$  means that the index  $i_k$  has been omitted. As a simple example consider low values of  $q$ ,

$$\begin{cases} (\check{\delta}c)_{ij} &= c_j - c_i & \text{on } \mathcal{U}_i \cap \mathcal{U}_j, \\ (\check{\delta}c)_{ijk} &= c_{jk} - c_{ik} + c_{ij} & \text{on } \mathcal{U}_i \cap \mathcal{U}_j \cap \mathcal{U}_k \\ (\check{\delta}c)_{ijkl} &= c_{jkl} - c_{ikl} + c_{ijl} - c_{ijk} & \text{on } \mathcal{U}_i \cap \mathcal{U}_j \cap \mathcal{U}_k \cap \mathcal{U}_l. \end{cases} \quad (3.9)$$

The first equation is a measure of how far is  $c_i$  from a global object whereas the other ones compare objects defined on multiple intersections. Note, that for  $U(1)$ -valued cochains, the additive notation is replaced by the multiplication. For example, recall that the transition functions  $f_{ij}$  of a line bundle (2.38) are Čech 1-cocycles which means nothing but  $(\check{\delta}f)_{ijk} = 1$ .

Finally, in the  $r$ -direction, the group coboundary operator [31]

$$(\delta c)_{g_0, \dots, g_r} = g_0^* c_{g_1, \dots, g_r} + \sum_{k=1}^r (-1)^k c_{g_0, \dots, g_{k-1} g_k, \dots, g_r} + (-1)^{r+1} c_{g_0, \dots, g_{r-1}}, \quad (3.10)$$

defines group cohomology. The group action is by pull-back, i.e.  $g^*$  is the pull-back action on forms. Again, as an example for low values of  $r$ ,

$$(\delta c)_g = g^* c - c, \quad (3.11)$$

$$(\delta c)_{g,h} = g^* c_h - c_{gh} + c_g, \quad (3.12)$$

$$(\delta c)_{g,h,k} = g^* c_{h,k} - c_{gh,k} + c_{g,hk} - c_{g,h}. \quad (3.13)$$

The first equation quantifies the lack of invariance of  $c$  under the action of  $g$ . The other equations appear in physics in the definition of representations up to a phase [32]. Indeed, if we represent the group  $G$  on some functions by  $T_g \psi(x) = \rho_g(x) \psi(xg)$ , the multiplication law of

$G$  is fulfilled iff  $\rho$  satisfies (3.12). This is nothing but (2.61) for the  $U(1)$ -valued  $\phi_{g;i}$  and  $\omega$ . The third equation enters into the definition of projective representations:  $T_g T_h = \omega_{g,h} T_{gh}$  defines an associative multiplication law iff  $\omega$  obeys (3.13). Because most of the multiplication laws encountered in physics involve the operator multiplication, a failure of associativity seldom occurs. This is nothing but (2.64), i.e.  $\omega_{g,h}$  is a group 2-cocycle. Let us also note that we have defined the group coboundary  $\delta$  for differential forms on which  $G$  acts by pull-back but the same definition is valid for an arbitrary representation of  $G$ . Further note that the three differentials  $d, \delta$  and  $\check{\delta}$  commute. Recently, a similar construction including group cohomology has been introduced [33] concerning the lift of an orientifold group action on the  $B$ -fields.

The construction of the tricomplex  $\mathcal{T}_{r,s}$  arises directly from the Čech-de Rham bicomplex given for any fixed value of  $r$ ,

$$\mathcal{T}_{r,s} = \bigoplus_{p+q=s} c_{p,q,r}, \quad (3.14)$$

where the Čech-de Rham sector is equipped with the Deligne differential [2, 20]

$$\mathcal{D} : \mathcal{T}_{r,s} \rightarrow \mathcal{T}_{r,s+1} \quad (3.15)$$

leaving the group index  $r$  untouched. It acts as

$$(\mathcal{D}c)_{p,q,r} = (-1)^q dc_{p-1,q,r} + (-1)^{q-1} \check{\delta}c_{p,q-1,r} \quad (3.16)$$

for  $(c_{p,q,r})_{r,p+q=s}$  a component of an element  $\mathbf{C}$  in  $\mathcal{T}_{r,s}$ . We define  $dc_{p-1,q,r}$  (resp.  $\check{\delta}c_{p,q-1,r}$ ) as 0 when  $p = 0$  (resp.  $q = 0$ ). Obviously,  $\mathcal{D}$  squares to 0 and commutes with the group coboundary  $\delta$ , which makes it into a total tricomplex. Up to multiplication by a global sign on  $\mathcal{T}_{r,s}$ , the Čech-de Rham sub bicomplex is identical to the one presented in [2], so that it follows that they share the same cohomology. In particular, it follows [2] that in degree one, the cohomology of the Čech-de Rham complex is given by  $H^1(\mathcal{M}, U(1))$  and in degree two by  $H^2(\mathcal{M}, U(1))$ .

*Again in simple words:* A general  $\mathcal{T}_{r,s}$ -cochain  $\mathbf{C}$  is an element carrying  $r$  group indices,  $\mathbf{C}_{g_1, \dots, g_r}$ . This element is further decomposed into  $(s+1)$  Čech/de Rham cochain components, of which the first is a de Rham  $s$ -form being a Čech 0-cochain at the same time. For the following components the de Rham degree decreases and the Čech degree increases. The last component of  $\mathbf{C}$  is a de Rham 0-form which is a Čech  $s$ -cochain at the same time. The  $r$ -index is the same for every component. As an example take the element  $\mathbf{C} \in \mathcal{T}_{1,2}$ . One can write out the components to be

$$\mathcal{T}_{1,2} \ni \mathbf{C} := (c_{g;i}, c_{g;ij}, c_{g;ijk}). \quad (3.17)$$

The Deligne differential acts on each component according to (3.16):

$$\mathcal{T}_{1,3} \ni \mathcal{D}\mathbf{C} = (dc_{g;i}, \check{\delta}c_{g;i} - dc_{g;ij}, -\check{\delta}c_{g;ij} + dc_{g;ijk}, +\check{\delta}c_{g;ijk}). \quad (3.18)$$

Note that for  $U(1)$ -valued components the additive notation must be changed to the multiplicative notation. As a convention, total cochains  $\in \mathcal{T}_{r,s}$  will always be printed as **bold** letters, unless it is a Greek capital<sup>‡</sup> or a constant.

<sup>‡</sup>This convention is chosen because **bold** Greek capitals lead to unnaturally high fluctuations of the grey-value distribution of a printed page, i.e. for aesthetical reasons.

**1-FORM GAUGE POTENTIALS**

With all these fancy definitions, let us try to reconstruct the defining equations of the line bundle encountered in equation (2.38). With

$$\begin{aligned}\mathbf{B} &= (B_i, 0, 1) \in \mathcal{T}_{0,2} \\ \mathbf{A} &= (A_i, f_{ij}) \in \mathcal{T}_{0,1},\end{aligned}\tag{3.19}$$

where  $A_i$  are the locally defined connection one forms and  $f_{ij}$  the  $U(1)$ -valued transition functions, formula (2.38) is obtained by setting  $\mathcal{D}\mathbf{A} = \mathbf{B}$ :

$$\begin{aligned}\mathcal{D}\mathbf{A} &= \mathcal{D}(A_i, f_{ij}) = (dA_i, (\check{\delta}A_i)_{ij} - \text{id log } f_{ij}, -(\check{\delta}f_{ij})_{ijk}) \\ &= (dA_i, A_j - A_i - \text{id log } f_{ij}, f_{jk} f_{ik}^{-1} f_{ij}) \\ \stackrel{!}{=} \mathbf{B} &= (B_i, 0, 1).\end{aligned}\tag{3.20}$$

Note the possibly confusing<sup>§</sup> but exact notation in expressions like  $(\check{\delta}f_{ij})_{ijk}$ :  $\check{\delta}$  is the Čech coboundary operator and creates an additional index. The two indices  $ij$  are different from the three indices  $ijk$  after the application of  $\check{\delta}$ . This was omitted in (3.18) for clarity and will be omitted in future computations. If a coboundary is applied, it is the result, that carries the indices.

Assuming that  $H^1(\mathcal{M}, U(1))$  is trivial, the degree one cohomology of the Čech-de Rham complex is also trivial, and one can make a very convenient observation, namely, since the magnetic field strength  $\mathbf{B}$  is invariant under the group action,  $\delta\mathbf{B} = g^*\mathbf{B} - \mathbf{B} = 0$ , and  $\delta$  commutes with  $\mathcal{D}$ ,

$$\delta\mathcal{D}\mathbf{A} = \mathcal{D}\delta\mathbf{A} = 0 \Rightarrow \exists\Phi \in \mathcal{T}_{1,0} \mid \mathcal{D}\Phi = \delta\mathbf{A},\tag{3.21}$$

or in words,  $\delta\mathbf{A}$  is exact with respect to  $\mathcal{D}$ . Writing out the group indices,

$$\mathcal{D}\Phi_g = g^*\mathbf{A} - \mathbf{A},\tag{3.22}$$

one recovers exactly the relations (2.54), with  $\Phi = (\phi_{g;i})$ , because

$$\begin{aligned}\mathcal{D}\Phi &= \mathcal{D}(\phi_{g;i}) = (\text{id log } \phi_{g;i}, \phi_{g;j} \phi_{g;i}^{-1}) \\ \stackrel{!}{=} \delta\mathbf{A} &= (g^*A_i - A_i, g^*f_{ij} f_{ij}^{-1}).\end{aligned}\tag{3.23}$$

We also define

$$\mathcal{T}_{2,0} \ni \omega = \delta\Phi\tag{3.24}$$

that fulfills

$$\mathcal{D}\omega = \mathcal{D}\delta\Phi = \delta\mathcal{D}\Phi = \delta^2\mathbf{A} = 0.\tag{3.25}$$

It shows that  $\omega$  is constant and globally defined ( $\check{\delta}\omega = 0$ ). By definition,  $\omega$  also satisfies  $\delta\omega = 0$  so that it is a group 2-cocycle. Of course it is nothing but  $\omega_{g,h}$  from (2.61).

If the degree one cohomology of the Čech-de Rham bicomplex is not trivial, then there is an obstruction to solving  $\mathcal{D}\delta\mathbf{A} = 0$ , which corresponds to the fact that a line bundle and its

---

<sup>§</sup>In principle it is less confusing, but there are more indices to worry about.

pull-back by  $g$  are not necessarily isomorphic. Here, we are working in the simply connected case.

Finally, the gauge ambiguity in this setting is described by an element  $\boldsymbol{\eta} \in \mathcal{T}_{0,0}$  acting on the potential as

$$\begin{cases} \mathbf{A} & \rightarrow \mathbf{A} + \mathcal{D}\boldsymbol{\eta} \\ \Phi & \rightarrow \Phi \delta\boldsymbol{\eta} \alpha \end{cases}, \quad (3.26)$$

which can be written out with  $\boldsymbol{\eta} = (\eta_i)$

$$\begin{cases} A_i & \rightarrow A_i + i \, d \log \eta_i, \\ f_{ij} & \rightarrow f_{ij} \eta_i^{-1} \eta_j \\ \phi_{g;i} & \rightarrow \phi_{g;i} g^* \eta_i (\eta_i)^{-1} \alpha_g \end{cases}. \quad (3.27)$$

As an additional ambiguity, note that the constant group 1-cochain  $\alpha_g$  changes  $\omega_{g,h}$  by a coboundary, since  $\omega = \delta\Phi$  and  $(\delta\alpha)_{g,h} = \alpha_h \alpha_{gh}^{-1} \alpha_g$  which corresponds to what we encountered in (2.65).

We can now understand the  $[\dots]_{ji}$  notation of the magnetic amplitude (2.52). The notation encodes (up to a sign) the formal analogy between cochains of the Čech-de Rham bicomplex and ordinary differential forms. Gauge transformations (3.26) read

$$\left[ e^{i \int_x^y \mathbf{A}} \right]_{ji} \rightarrow \left[ e^{i \int_x^y \mathbf{A} + \mathcal{D}\boldsymbol{\eta}} \right]_{ji} = [\boldsymbol{\eta}^{-1}(y)]_j \left[ e^{i \int_x^y \mathbf{A}} \right]_{ji} [\boldsymbol{\eta}(x)]_i, \quad (3.28)$$

with  $[\boldsymbol{\eta}(x)]_i = \eta_{g;i}(x)$ . The action of  $g \in G$  on the amplitude reads

$$\mathcal{A}_{ji}[\varphi \cdot g] = \left[ e^{i \int_x^y g^* \mathbf{A}} \right]_{ji} = [\Phi_g^{-1}(y)]_j \left[ e^{i \int_x^y \mathbf{A}} \right]_{ji} [\Phi_g(x)]_i, \quad (3.29)$$

with  $[\Phi_g(x)]_i = \phi_{g;i}(x)$ . An element  $\in \mathcal{T}_{r,s}$  enclosed by a pair of square brackets has several components which are evaluated at the Čech indices attached,  $[\dots]_{i_1 \dots i_n}$ . Let us carry over all this to higher forms.

## 2-FORM GAUGE POTENTIALS AND THEIR INVARIANCE

The formalism just developed is of course very well suited to be applied to the higher dimensional case of the local data of a *1-gerbe*. (In particular, because the equations are rather compact, it is harder to lose sight even if applied to  $n$ -gerbes). We have seen that the KR gauge potential is a 2-form and the field strength a 3-form. To start with, let  $H$  be the Kalb-Ramond 3-form such that its de Rham cohomology class belongs to  $H^3(\mathcal{M}, 2\pi\mathbb{Z})$ . This class is also called Dixmier-Douady-class [20] and can be considered as the 'higher dimensional' version of the Chern class for line bundles. Under these assumptions one can find locally defined forms of lower degree such that

$$\begin{cases} H_i & = dB_i & \text{on } \mathcal{U}_i \\ B_j - B_i & = dB_{ij} & \text{on } \mathcal{U}_i \cap \mathcal{U}_j \\ B_{jk} - B_{ik} + B_{ij} & = i \, d \log f_{ijk} & \text{on } \mathcal{U}_i \cap \mathcal{U}_j \cap \mathcal{U}_k \\ f_{jkl} (f_{ikl})^{-1} f_{ijl} (f_{ijk})^{-1} & = 1 & \text{on } \mathcal{U}_i \cap \mathcal{U}_j \cap \mathcal{U}_k \cap \mathcal{U}_l \end{cases}, \quad (3.30)$$

where all forms are antisymmetric in their indices. This set of equations is the analogue of the local data defining a line bundle with connection, (2.38). The mathematical profoundness of the underlying equations and their geometrical meaning in terms of gerbes or even 'bundle gerbes' [34, 35] will not be used. We simply adapt the techniques introduced for the particle to the case where there is a 3-form background field instead of a 2-form and solely work with the local representation of the fields. As a generic term, all these local fields will be referred to as 'the  $B$ -fields'.

Given  $H$ , 'the  $B$ -fields' are not unique. One can gauge transform them as

$$\begin{cases} B_i & \rightarrow B_i + d\Lambda_i, \\ B_{ij} & \rightarrow B_{ij} + \Lambda_j - \Lambda_i - i d \log \eta_{ij}, \\ f_{ijk} & \rightarrow f_{ijk} \eta_{jk}^{-1} \eta_{ik} \eta_{ij}^{-1}, \end{cases} \quad (3.31)$$

while preserving (3.30). Note that the gauge transformation now involves real 1-forms  $\Lambda_i$  and  $U(1)$ -valued functions  $\eta_{ij}$ . Besides, there is a gauge transformation of the gauge transformation since

$$\begin{cases} \Lambda_i & \rightarrow \Lambda_i + i d \log \xi_i, \\ \eta_{ij} & \rightarrow \eta_{ij} \xi_j (\xi_i)^{-1} \end{cases} \quad (3.32)$$

has no effect on the  $B$ -fields. For the sake of brevity, the latter shall be called *residual gauge transformations*.

To write these equations using the Čech-de Rham bicomplex, let us define elements in  $\mathcal{T}_{r,s}$  and mimic the method applied for the bundle,

$$\begin{aligned} \mathbf{H} &= (H_i, 0, 0, 1) \in \mathcal{T}_{0,3} \\ \mathbf{B} &= (B_i, B_{ij}, f_{ijk}) \in \mathcal{T}_{0,2} \end{aligned} \quad (3.33)$$

The equations (3.30) are then equivalent to the very compact equation

$$\mathcal{D}\mathbf{B} = \mathbf{H} \quad (3.34)$$

as can be recovered using the definition of  $\mathcal{D}$  (3.16)

$$\begin{aligned} \mathcal{D}\mathbf{B} &= \mathcal{D}(B_i, B_{ij}, f_{ijk}) \\ &= (dB_i, (\check{\delta}B_i)_{ij} - dB_{ij}, -(\check{\delta}B_{ij})_{ijk} + i d \log f_{ijk}, (\check{\delta}f_{ijk})_{ijkl}) \\ \stackrel{!}{=} \mathbf{H} &= (H_i, 0, 0, 1) \end{aligned} \quad (3.35)$$

and the application of the Čech coboundary.

Again, the invariance of  $\mathbf{H}$  under the group action, i.e.  $\delta\mathbf{H} = g^*\mathbf{H} - \mathbf{H} = 0$ , and  $\mathcal{D}\mathbf{B} = \mathbf{H}$  implies

$$\delta\mathcal{D}\mathbf{B} = \mathcal{D}\delta\mathbf{B} = 0 \rightarrow \exists \mathbf{A} \in \mathcal{T}_{1,1} \mid \mathcal{D}\mathbf{A} = \delta\mathbf{B} \quad (3.36)$$

because the relevant cohomology is assumed to be trivial [2]. By the same token and because  $\delta^2 = 0$ ,

$$\delta^2\mathbf{B} = \delta\mathcal{D}\mathbf{A} = \mathcal{D}\delta\mathbf{A} = 0 \rightarrow \exists \Phi \in \mathcal{T}_{2,0} \mid \mathcal{D}\Phi = \delta\mathbf{A}, \quad (3.37)$$

such that the group action is completely encoded by

$$\begin{cases} \mathcal{D}\mathbf{A} &= \delta\mathbf{B}, \\ \mathcal{D}\Phi &= \delta\mathbf{A}, \\ \omega &= \delta\Phi \end{cases} . \quad (3.38)$$

Here,  $\omega = \delta\Phi$  is a constant and globally defined element  $\in \mathcal{T}_{3,0}$ , since

$$\mathcal{D}\omega = \mathcal{D}\delta\Phi = \delta\mathcal{D}\Phi = \delta^2\mathbf{A} = 0. \quad (3.39)$$

Further, it is a group 3-cocycle, because of

$$\delta\omega = \delta^2\Phi = 0. \quad (3.40)$$

The 3-cocycle will play an important role, since it is an essential ingredient of the algebraic structure we are interested in. However, on this stage of its derivation, this cannot be recognized yet.

For the defining equations of the group action (3.38), one can write out the group indices leading to

$$\begin{cases} \mathcal{D}\mathbf{A}_g &= g^*\mathbf{B} - \mathbf{B} \\ \mathcal{D}\Phi_{g,h} &= g^*\mathbf{A}_h - \mathbf{A}_{gh} + \mathbf{A}_g \\ \omega_{g,h,l} &= g^*\Phi_{h,k}(\Phi_{gh,k})^{-1}\Phi_{g,hk}(\Phi_{g,h})^{-1} \end{cases} . \quad (3.41)$$

The first equation means that  $\mathbf{A}_g$  is a gauge transformation from  $\mathbf{B}$  to  $g^*\mathbf{B}$ . Then,  $(gh)^*\mathbf{B}$  can be obtained from  $\mathbf{B}$  either by  $\mathbf{A}_{gh}$ , or by  $\mathbf{A}_g + g^*\mathbf{A}_h$ . Therefore, the two gauge transformations must be related by a residual gauge transformation  $\Phi_{g,h}$ . This is encoded in the second equation. The last equation arises from the two ways of combining two residual gauge transformations from  $\mathbf{A}_{ghk}$  to  $\mathbf{A}_g + h^*\mathbf{A}_g + (gh)^*\mathbf{A}_k$ . Indeed, one can use either

$$\mathbf{A}_{ghk} \xrightarrow{\Phi_{g,hk}} \mathbf{A}_g + g^*\mathbf{A}_{hk} \xrightarrow{g^*\Phi_{h,k}} \mathbf{A}_g + g^*\mathbf{A}_h + (gh)^*\mathbf{A}_k, \quad (3.42)$$

or

$$\mathbf{A}_{ghk} \xrightarrow{\Phi_{gh,k}} \mathbf{A}_{gh} + (gh)^*\mathbf{A}_k \xrightarrow{\Phi_{g,h}} \mathbf{A}_g + g^*\mathbf{A}_h + (gh)^*\mathbf{A}_k. \quad (3.43)$$

Since the two combinations of residual gauge transformations have the same action on  $\mathbf{A}_{ghk}$ , they differ by a constant which is  $\omega_{g,h,k}$ .

In figure 3.2, vertices correspond to  $B$ -fields, arrows to gauge transformations  $\mathbf{A}_g$ , faces to residual gauge transformations  $\Phi_{g,h}$  and  $\omega_{g,h,k}$  to the tetrahedron obtained by gluing the two couples of triangles corresponding to (3.42) and (3.43).

The next logical step is to write down all Čech-indices. In accordance with their definition,

$$\begin{aligned} \mathbf{A} &= (A_{g;i}, f_{g;ij}) \in \mathcal{T}_{1,1}, \\ \Phi &= (\phi_{g,h;i}) \in \mathcal{T}_{2,0}, \end{aligned} \quad (3.44)$$

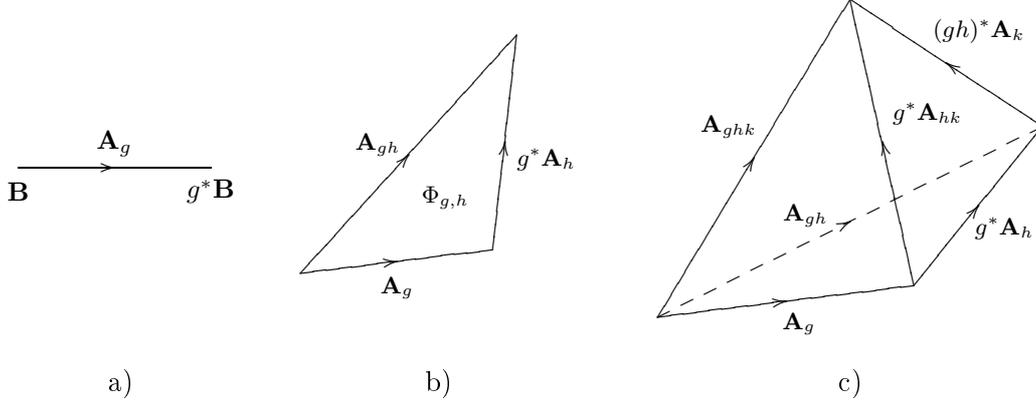

Figure 3.2: Geometric illustration for group cochains.

such that one obtains

$$\left\{ \begin{array}{l} dA_{g;i} = g^*B_i - B_i \\ A_{g;j} - A_{g;i} - i \, d \log f_{g;ij} = g^*B_{ij} - B_{ij} \\ (f_{g;jk})^{-1} f_{g;ik} (f_{g;ij})^{-1} = g^*f_{ijk} (f_{ijk})^{-1} \\ i \, d \log \phi_{g,h;i} = g^*A_{h;i} - A_{gh;i} + A_{g;i} \\ \phi_{g,h;j} (\phi_{g,h;i})^{-1} = g^*f_{h;ij} (f_{gh;ij})^{-1} f_{g;ij} \\ \omega_{g,h,k} = g^*\phi_{h,k;i} (\phi_{gh,k;i})^{-1} \phi_{g,hk;i} (\phi_{g,h;i})^{-1} \end{array} \right. . \quad (3.45)$$

These are the equations derived by E. Sharpe in his analysis of discrete torsion [36], at the notable exception of the 3-cocycle  $\omega$ . As we have seen, the triviality of  $\omega$  cannot be obtained solely on the grounds of the invariance of  $H$ . However, it is an essential consistency condition in order to build a honest orbifold theory. We come back to this point in chapter 5. For the moment, just note that the 3-cocycle  $\omega_{g,h,k}$  (for the particle it was the 2-cocycle  $\omega_{g,h}$ ) arises naturally from the construction using the tricplex.

To complete all possible gauge transformations, they can be written in a compact way

$$\left\{ \begin{array}{ll} \mathbf{B} \rightarrow \mathbf{B} + \mathcal{D}\Lambda & , \quad \Lambda \in \mathcal{T}_{0,1} \\ \mathbf{A} \rightarrow \mathbf{A} + \delta\Lambda + \mathcal{D}\Theta & , \quad \Theta \in \mathcal{T}_{1,0} \\ \Phi \rightarrow \Phi \delta\Theta \alpha & , \quad \alpha \in \mathcal{T}_{2,0} \\ \omega \rightarrow \omega \delta\alpha & , \quad \omega \in \mathcal{T}_{3,0} \end{array} \right. , \quad (3.46)$$

such that with the explicit version of the gauge fields

$$\begin{aligned} \Lambda &= (\Lambda_i, \eta_{ij}) \in \mathcal{T}_{0,1} \\ \Theta &= (\theta_{g;i}) \in \mathcal{T}_{1,0} \end{aligned} \quad (3.47)$$

one recovers (3.31) plus additional transformations of the other fields

$$\left\{ \begin{array}{l} B_i \rightarrow B_i + d\Lambda_i \\ B_{ij} \rightarrow B_{ij} + \Lambda_j - \Lambda_i - i d \log \eta_{ij} \\ f_{ijk} \rightarrow f_{ijk} (\eta_{jk})^{-1} \eta_{ik} (\eta_{ij})^{-1} \\ A_{g;i} \rightarrow A_{g;i} + g^* \Lambda_i - \Lambda_i + i d \log \theta_{g;i} \\ f_{g;ij} \rightarrow f_{g;ij} g^* \eta_{ij} (\eta_{ij})^{-1} \theta_{g,j} (\theta_{g;i})^{-1} \\ \phi_{g,h;i} \rightarrow \phi_{g,h;i} g^* \theta_{h;i} (\theta_{gh;i})^{-1} \theta_{g;i} \end{array} \right. \quad (3.48)$$

In this context, the residual gauge transformations read

$$\Lambda \rightarrow \Lambda + \mathcal{D}\xi \quad , \quad \xi = (\xi_i) \in \mathcal{T}_{0,0}, \quad (3.49)$$

which reproduces (3.32).

The precise construction can be recovered from figure 3.3 by following the step-like path indicated by the arrows towards the  $\delta/r$ -axis. The presented general method constructs

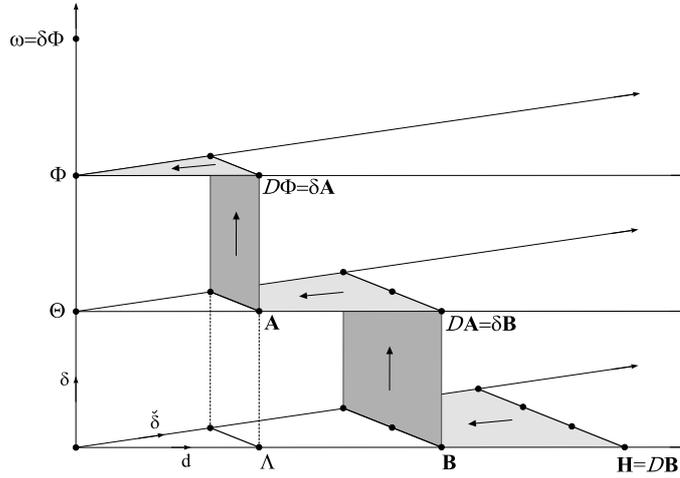

Figure 3.3: De Rham/Čech/group tricomplex for the derivation of  $\mathbf{B}$ ,  $\mathbf{A}$ ,  $\Phi$  and  $\omega$ .

the local field transformations under the group action. For the bundle (2.38), these relations assured that the pull-back bundle is isomorphic to the original bundle, yielding the phase that accompanies the operators of magnetic translations. For a group invariant 3-form  $H$  with all its local components gathered into  $\mathbf{H}$ , and the corresponding potential forms gathered into  $\mathbf{B}$ , the relations assure the pull-back gerbe to be stably isomorphic to the original one [29]. The group action introduces two fields,  $\mathbf{A}_g$  and  $\Phi_{g,h}$ , and a group 3-cocycle  $\omega_{g,h,k} \in \mathcal{T}_{3,0}$  which is constant and globally defined. Apart from that, there are gauge transformations induced by  $\Lambda \in \mathcal{T}_{0,1}$  and  $\Theta \in \mathcal{T}_{1,0}$  as well as gauge transformations of the gauge transformation induced by an element  $\xi \in \mathcal{T}_{0,0}$ .

It is now clear how to proceed to define stringy magnetic translations: Construct the analogue of the particle's magnetic amplitude for a string and compare the translated amplitude

with the original one. From the ratio, read off the phase that must accompany the magnetic translation operators. For the following computation, all field relations derived here will be of striking importance. The magnetic amplitude should be invariant under gauge transformations and locally appearing re-triangulations up to boundary terms that are absorbed by the string states, completely analogous to the particle case. The string magnetic amplitude will be constructed in the next section.

### M-THEORY<sup>¶</sup>

To show the generality of the introduced methods, let us apply the tricomplex to the local data of a 2-gerbe [37, 38]. The local data is given by a background 4-form and the corresponding potential being a 3-form. The tricomplex method is so general that it could be applied to any degree. In M-Theory, the equations are obtained from a set of fields

$$\mathbf{C} = (C_i, C_{ij}, C_{ijk}, f_{ijkl}) \in \mathcal{T}_{0,3}, \quad (3.50)$$

standing for the locally defined 3-form potentials  $C_i$  and all lower degree forms needed to glue them on non trivial intersections. The globally defined closed 4-form field strength  $\mathbf{G} = (G_i, 0, 0, 0, 1) \in \mathcal{T}_{0,4}$  together with all defining equations is obtained by

$$\mathcal{D}\mathbf{C} = \mathbf{G}, \quad (3.51)$$

or written explicitly with Čech indices

$$\left\{ \begin{array}{lll} G_i = dC_i & \text{on } \mathcal{U}_i \\ C_j - C_i = dC_{ij} & \text{on } \mathcal{U}_i \cap \mathcal{U}_j \\ C_{ij} + C_{jk} + C_{ki} = dC_{ijk} & \text{on } \mathcal{U}_i \cap \mathcal{U}_j \cap \mathcal{U}_k \\ C_{jkl} - C_{ikl} + C_{ijl} - C_{ijk} = \text{id log } f_{ijkl} & \text{on } \mathcal{U}_i \cap \mathcal{U}_j \cap \mathcal{U}_k \cap \mathcal{U}_l \\ (f_{jklm})^{-1} f_{iklm} (f_{ijlm})^{-1} f_{ijkm} (f_{ijkl})^{-1} = 1 & \text{on } \mathcal{U}_i \cap \mathcal{U}_j \cap \mathcal{U}_k \cap \mathcal{U}_l \cap \mathcal{U}_m \end{array} \right. . \quad (3.52)$$

We are then introducing the additional fields needed to define the group action on that 2-gerbe. These are clearly  $\mathbf{B} \in \mathcal{T}_{1,2}$ ,  $\mathbf{A} \in \mathcal{T}_{2,1}$  and  $\Phi \in \mathcal{T}_{3,0}$ , such that the group action is finally given by

$$\left\{ \begin{array}{l} \mathcal{D}\mathbf{B} = \delta\mathbf{C} \\ \mathcal{D}\mathbf{A} = \delta\mathbf{B} \\ \mathcal{D}\Phi = \delta\mathbf{A} \\ \omega = \delta\Phi \end{array} \right. . \quad (3.53)$$

These equations are very convenient to read off the gauge degrees of freedom. The gauge ambiguities take the form

$$\left\{ \begin{array}{ll} \mathbf{C} \rightarrow \mathbf{C} + \mathcal{D}\Upsilon & , \quad \Upsilon \in \mathcal{T}_{0,2} \\ \mathbf{B} \rightarrow \mathbf{B} + \delta\Upsilon + \mathcal{D}\Lambda & , \quad \Lambda \in \mathcal{T}_{1,1} \\ \mathbf{A} \rightarrow \mathbf{A} + \delta\Lambda + \mathcal{D}\Theta & , \quad \Theta \in \mathcal{T}_{2,0} \\ \Phi \rightarrow \Phi \delta\Theta \alpha & , \quad \alpha \in \mathcal{T}_{3,0} \\ \omega \rightarrow \omega \delta\alpha & , \quad \omega \in \mathcal{T}_{4,0} \end{array} \right. , \quad (3.54)$$

where we included the ambiguity due to the group 3-cochain  $\alpha$ , which is a 3-cocycle if one requires that  $\omega$  remains unchanged, and can be identified with the M-theory analogue of discrete torsion [37, 38].

---

<sup>¶</sup>Not necessary but interesting

Additionally, there are now three levels of residual gauge transformations, namely

$$\begin{cases} \Upsilon & \rightarrow \Upsilon + \mathcal{D}\Xi & , \quad \Xi \in \mathcal{T}_{0,1} \\ \Xi & \rightarrow \Xi + \mathcal{D}\eta & , \quad \eta \in \mathcal{T}_{0,0} \\ \Lambda & \rightarrow \Lambda + \mathcal{D}\zeta & , \quad \zeta \in \mathcal{T}_{1,0} \end{cases} . \quad (3.55)$$

Let's start to write out the group indices for the group action. One obtains

$$\begin{cases} \mathcal{D}\mathbf{B}_g & = g^*\mathbf{C} - \mathbf{C} \\ \mathcal{D}\mathbf{A}_{g,h} & = g^*\mathbf{B}_h - \mathbf{B}_{gh} + \mathbf{B}_g \\ \mathcal{D}\Phi_{g,h,k} & = g^*\mathbf{A}_{h,k} - \mathbf{A}_{gh,k} + \mathbf{A}_{g,hk} - \mathbf{A}_{g,h} \\ \omega_{g,h,k,l} & = g^*\Phi_{h,k,l}(\Phi_{gh,k,l})^{-1}\Phi_{g,hk,l}(\Phi_{g,h,kl})^{-1}\Phi_{g,h,k} \end{cases} \quad (3.56)$$

We are now going to display all Čech indices. Note, that the fields are written explicitly as

$$\begin{aligned} \mathbf{B} &= (B_{g;i}, B_{g;ij}, f_{g;ijk}), \\ \mathbf{A} &= (A_{g,h;i}, f_{g,h;ij}), \\ \Phi &= (\phi_{g,h,k;i}). \end{aligned} \quad (3.57)$$

From (3.56) we have

$$\left\{ \begin{array}{l} d B_{g;i} = g^* C_i - C_i \\ B_{g;j} - B_{g;i} - d B_{g;ij} = g^* C_{ij} - C_{ij} \\ B_{g;ik} + B_{g;kj} + B_{g;ji} + i d \log f_{g;ijk} = g^* C_{ijk} - C_{ijk} \\ f_{g;jkl} f_{g;ikl}^{-1} f_{g;ijl} f_{g;ijk}^{-1} = g^* f_{ijkl} (f_{ijkl})^{-1} \\ d A_{g,h;i} = g^* B_{h;i} - B_{gh;i} + B_{g;i} \\ A_{g,h;j} - A_{g,h;i} - i d \log f_{g,h;ij} = g^* B_{h;ij} - B_{gh;ij} + B_{g;ij} \\ (f_{g,h;jk})^{-1} f_{g,h;ik} (f_{g,h;ij})^{-1} = g^* f_{h;ijk} (f_{gh;ijk})^{-1} f_{g;ijk} \\ i d \log \phi_{g,h,k;i} = g^* A_{h,k;i} - A_{gh,k;i} + A_{g,hk;i} - A_{g,h;i} \\ \phi_{g,h,k;j} (\phi_{g,h,k;i})^{-1} = g^* f_{h,k;ij} (f_{gh,k;ij})^{-1} f_{g,hk;ij} (f_{g,h;ij})^{-1} \end{array} \right. \quad (3.58)$$

These equations are equivalent to the ones presented in [37].

### § 3.3 STRING PROPAGATION AND STATES

As for a particle, a closed string propagating on  $\mathcal{M}$  in a background 3-form  $H$  can be described in the functional integral approach by the insertion of a magnetic amplitude. More precisely, the string propagator  $K$  can be derived in perturbation theory from CFT as<sup>||</sup> [26]

$$K(Y; X) = \int_{\varphi(\partial\mathcal{S})=X^*\cup Y} [\mathcal{D}\varphi] e^{-S[\varphi]} \mathcal{A}[\varphi], \quad (3.59)$$

where  $\varphi$  is the map ('path') from the corresponding two dimensional surface  $\mathcal{S}$  into the manifold  $\mathcal{M}$ , where the boundary values coincide with the string initial and final positions  $X$  and  $Y$  in analogy to the particle propagator and the map  $\varphi : [a, b] \rightarrow \mathcal{M}$  with  $\varphi(a) = x$  and  $\varphi(b) = y$  fixed. The \* stands for the different orientations with respect to the incoming and outgoing string, since the strings have a winding. In general,  $X$  and  $Y$  may both have

<sup>||</sup>To be more precise one has to further integrate over the moduli and sum over the genera of  $\mathcal{S}$

several connected components and the topology of  $\mathcal{S}$  encodes all the possible interactions. For example,  $Y$  may be a disjoint union of several outgoing strings if there is a decomposition during the propagation process encoded by the topology of  $\mathcal{S}$ . In this thesis, we confine ourselves to the simplest topologies for  $\mathcal{S}$ : a cylinder (free string propagation) and later a pair of pants (tree level decay of a string).

Besides,  $K(Y; X)$  fulfills a set of axioms which essentially state that two processes corresponding to two world-sheets  $\mathcal{S}$  and  $\mathcal{S}'$  can be sewn end-to-end [26], if their boundaries allow for it.  $K$  provides the evolution of the string wave function according to

$$\Psi(X) \rightarrow \Psi'(Y) = \int [DX] K(Y; X) \Psi(X), \quad (3.60)$$

where the 'string wave functions'  $\Psi$  and  $\Psi'$  are now functionals of the string's embedding  $X$  in space-time. The magnetic amplitude  $\mathcal{A}[\varphi]$  encodes the couplings to the potentials of the external  $H$ -field and defines, together with  $S[\varphi]$  a conformally invariant field theory on  $\mathcal{S}$ . In comparison to the magnetic amplitude of the particle,  $\mathcal{A}[\varphi]$  holds the topological KR term (3.7). The kinetic term for the propagating string (the free action (3.4)) is denoted by  $S[\varphi]$  in (3.59).

The definition of a string's configuration  $X$  used here is intimately connected with the posed problem of the orbifold construction. For that, it is again assumed that a finite discrete group  $G$  acts on  $\mathcal{M}$  and leaves the background field  $H$  as well as the kinetic action  $S[\varphi]$  invariant,  $g^*H - H = 0$ ,  $S[\varphi \cdot g] = S[\varphi]$ ,  $\forall g \in G$ . We aim at constructing magnetic amplitudes for some *open strings* in  $\mathcal{M}$  that will define *closed strings* on the orbifold  $\mathcal{M}/G$ . These states are called *twisted sectors*, and are defined to be strings that close up to an element of the group  $G$ . More precisely, the configuration space  $\mathcal{C}_w$  of strings with winding  $w$  is defined by

$$\mathcal{C}_w = \{ X_w : [0, 2\pi] \rightarrow \mathcal{M} \text{ such that } X_w(2\pi) = X_w(0) \cdot w \}. \quad (3.61)$$

For  $w = 1_G$ , it corresponds to closed strings and one can glue together the endpoints of the segment to recover the circle  $S^1$ . In the general case, it is convenient to view strings in  $\mathcal{C}_w$  as defined on a pointed circle, with boundary value differing by  $w$ , or equivalently, as strings defined on the universal cover  $\mathbb{R}$  of  $S^1$  fulfilling the quasi periodicity condition  $X_w(\sigma + 2n\pi) = X_w(\sigma) \cdot w^n$ . In order to make the illustrations easier, the first point of view shall be adopted.

### § 3.4 STRING MAGNETIC AMPLITUDE

The simplest amplitude corresponds to a single free string of winding  $w$  propagating between an initial configuration  $X_w$  and a final one  $Y_w$ . The magnetic amplitude is constructed using a slight modification of the techniques introduced in [2], in order to deal with the twisted sectors. Such an amplitude is associated to a map  $\varphi$  from a cut cylinder  $\mathcal{S}_c$  to  $\mathcal{M}$ , that interpolates between  $X_w$  and  $Y_w$  such that its boundary values along the cut differ by  $w$ . Hence, the cut cylinder  $\mathcal{S}_c$  replaces the interval  $\ell$  known from the particle's case, and to locally reconstruct (3.7), it has to be triangulated analogously to the choice of segments and vertices needed for

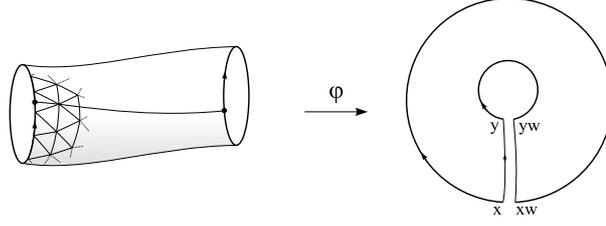

Figure 3.4: The cut of a cylinder.

$\ell$ . This time, the triangulation includes 2-simplices as well, since we deal with an object with dimension raised by one. The procedure is therefore to pick a triangulation of the cylinder  $\mathcal{S}_c$  by 2-simplices denoted by  $c_i$ , 1-simplices (the former segments)  $s_j$  and vertices  $v_k$  such that  $\varphi(c_i) \subset \mathcal{U}_{\alpha_i}$ ,  $\varphi(s_j) \subset \mathcal{U}_{\beta_j}$  and  $\varphi(v_k) \in \mathcal{U}_{\gamma_k}$ . Note that cutting the cylinder in the twisted sector's sense does not spoil the validity of such a triangulation, since the open cover  $\{\mathcal{U}_i\}$  is chosen to be group invariant. The procedure of 'cutting' is graphically represented in figure 3.4. Starting from  $\mathcal{S}$ , it is cut ( $\mathcal{S} \rightarrow \mathcal{S}_c$ ) and triangulated as indicated by the subset of little triangles. Everything is then mapped to  $\mathcal{M}$  depicted as the incoming circle from  $x$  to  $xw$  that propagates to its final position at  $y$  to  $yw$ . Note that the winding is an invariant and the propagation process is represented by the actual size of the circles. It should be regarded as if one looks through a cylinder which is located in front of ones eye, like a monocular telescope. This is a standard way of visualization also applied in CFT.

To realize a gauge invariant magnetic amplitude for twisted sectors, one has to include an additional term into (3.7). This is triggered by the possible gauge  $B \rightarrow B + d\Lambda$ , with  $\Lambda$  a 1-form. Due to the cut, this produces a contribution to the amplitude which cannot be absorbed by the gauged wave function; only boundary terms at  $X_w$  or  $Y_w$  are allowed to remain. Thus, gauge invariance requires an additional term integrated along the cut to cancel the term stemming from  $B \rightarrow B + d\Lambda$ . The field to be integrated has already been constructed, it is  $\mathbf{A}_w$  from the tricomplex construction (3.45) for a string with winding  $w$ . If everything were globally defined, its relation to  $B$  would be  $dA_w = w^*B - B$ . Since  $\mathbf{A}_w \in \mathcal{T}_{1,1}$ , it has to be integrated using a triangulation. The intersections of the cut with the triangles provide this triangulation by segments  $s'_j$  and by vertices  $v'_k$ . Collecting all together leads to the definition of the amplitude

$$\begin{aligned}
\mathcal{A}_{JI}[\varphi] &= \exp\left\{i \sum_{c_i} \int_{c_i} \varphi^* B_{\alpha_i}\right\} \exp\left\{i \sum_{\substack{c_i, s_j \\ s_j \subset \partial c_i}} \int_{s_j} \varphi^* B_{\alpha_i \beta_j}\right\} \prod_{\substack{c_i, s_j, v_k \\ s_j \subset \partial c_i \\ v_k \in \partial s_j}} \varphi^* f_{\alpha_i \beta_j \gamma_k}^{\epsilon(j,k)}(v_k) \\
&\times \exp\left\{i \sum_{s'_j} \int_{s'_j} \varphi^* A_{w; \beta'_j}\right\} \prod_{\substack{s'_j, v'_k \\ v'_k \in \partial s'_j}} \varphi^* f_{w; \beta'_j \gamma'_k}^{-\epsilon(j,k)}(v'_k). \tag{3.62}
\end{aligned}$$

The first line is identical to the contribution of closed strings in [2]. Here one can see the individual roles played by the local components of the total form  $\mathbf{B} = (B_i, B_{ij}, f_{ijk})$

introduced in the previous section. The locally given 2-form  $B_i$  is integrated along the 2-simplices  $c_i$  in (3.62). The corresponding local version is given by the open set associated to the 2-simplex; in our case, it is denoted by  $\mathcal{U}_{\alpha_i}$ , which leads to an integral over  $B_{\alpha_i}$ . In order to consistently 'switch' between triangles, one has to integrate the 1-form components  $B_{ij}$  along the bounding segments  $s_j \subset \partial c_i$ , where the open sets are given by the associated  $\mathcal{U}_{\alpha_i}$  of the 2-simplex itself and the one associated to the chosen bounding segment, whose open sets are denoted by  $\mathcal{U}_{\beta_j}$ . This leads to the integral over  $B_{\alpha_i\beta_j}$ . Analogously to switching between the line segments using the transition functions  $f_{ij}$  in the particle's amplitude, the  $U(1)$ -valued functions  $f_{ijk}$  play a similar role in equation (3.62). Namely, the line integrals over  $B_{\alpha_i\beta_j}$  along the boundaries  $\partial c_i$  meet the triangle vertices  $v_k$ , each one being an element of the associated open set  $\mathcal{U}_{\gamma_k}$ . In passing from one segment to another, there comes a factor  $f_{\alpha_i\beta_j\gamma_k}^{\epsilon(j,k)}(\varphi(v_k))$ , where  $\epsilon$  encodes the orientation of the current boundary segment in the sense that  $v_k$  inherits the orientation depending on whether  $v_k \in \partial s_j$  is the vertex where the segments starts or ends. As an analogue to the line bundle (2.38), equation (3.30) gives the necessary conditions in order to give a procedure of how switching between the open sets for all involved forms.

The second line is formally identical to the magnetic amplitude for a particle (2.47), with the difference, that the functions  $f_{w,ij}$  are not the transition functions of a line bundle because of equation (3.45). Note the slight abuse of notation. The cylinder is first cut and then triangulated, such that the segments and vertices of the cut are induced by the boundaries and vertices of the little triangles that touch the cut. Because of the invariance of the open cover with respect to the group action, the two triangulations on the upper and lower lip of the cut coincide. Thus the total form  $\mathbf{A}_w = (A_w; i, f_w; ij)$  introduced in (3.44) and (3.45) is integrated along the induced segments, using exactly the same convention as for the holonomy of the particle path.

### HOMOTOPIC CHANGE OF THE CUT

The full amplitude (3.62) is constructed to be invariant under a change of the triangulation or assignment of open sets. It is further invariant under homotopic changes of the cut. As long as the endpoints on the bounding circles are fixed, this is due to the use of a good invariant cover. Suppose the cut changes as indicated in figure 3.5. This leads to a new surface in

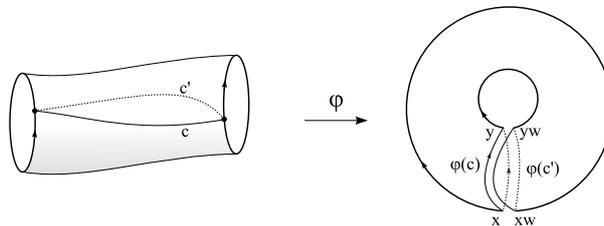

Figure 3.5: Homotopy under the change of the cut.

the target space, that coincides with the original one up to some region  $\Sigma''$ . To see this, separate the cylinder world-sheet into two pieces,  $\mathcal{S}_c = \mathcal{Z} \cap \mathcal{S}''$  compatible with some chosen triangulation. Imagine the two regions  $\mathcal{Z}$  and  $\mathcal{S}''$  to be separated by the new cut  $c'$ . Denote

the restrictions of  $\varphi$  on the corresponding pieces by  $\varphi(\mathcal{Z}) := \Delta$ ,  $\varphi(\mathcal{S}'') := \Sigma''$  respectively. Accordingly, the world-sheet  $\mathcal{S}_c$  takes the form  $\Sigma = \Delta \cap \Sigma''$  in target space. Then, the image of the new world-sheet  $\mathcal{S}_{c'}$  corresponding to the new cut  $c'$  equals the  $\mathcal{Z}$ -part,  $\varphi(\mathcal{Z}) = \Delta$ , whereas the region  $\mathcal{S}''$  of the gap between the two different cuts appears in  $\mathcal{M}$  lifted by the winding, i.e. as the surface  $w^*\Sigma''$ . To obtain this result, note that due to the invariance of the open cover,  $\varphi$  can be extended to the universal cover of the cylinder, using a periodic triangulation. Then, depending on the domain,  $\mathcal{S}''$  is mapped to  $\mathcal{M}$  modulo elements  $w^n \in G$ ,  $n \in \mathbb{Z}$ . The surface  $\Sigma''$  and its shifted version by the winding is illustrated in figure 3.6 and

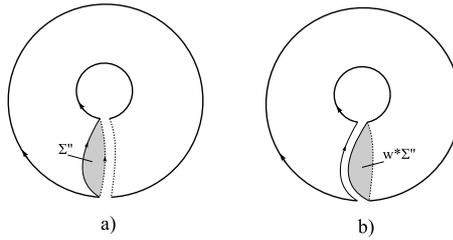

Figure 3.6: The shaded area is shifted by  $w$ .

corresponds to the shaded area. To make contact with the action of the group  $G$  on the fields, suppose  $\mathbf{B} \equiv B$  and  $\mathbf{A}_w \equiv A_w$  were globally defined, with  $d\mathbf{A}_w = w^*\mathbf{B} - \mathbf{B}$  according to (3.45). Then the amplitude (3.62) could be trivially written as

$$\mathcal{A}[\varphi] = e^{i \int_{\Sigma} \mathbf{B} + i \int_{\gamma} \mathbf{A}_w}, \quad (3.63)$$

where  $\gamma$  is the path along the image of the cut,  $\gamma = \varphi(c)$ . For two different cuts  $c$  and  $c'$  but with the same endpoints, apply the previous considerations, yielding two amplitudes  $\mathcal{A}$  and  $\mathcal{A}'$  with the ratio

$$\begin{aligned} \mathcal{A}/\mathcal{A}' &= e^{i \int_{\Sigma''} \mathbf{B} - w^*\mathbf{B} + i \int_{\gamma} \mathbf{A}_w - i \int_{\gamma'} \mathbf{A}_w} \\ &= e^{i \int_{\Sigma''} (-d\mathbf{A}_w) + i \int_{\partial\Sigma''} \mathbf{A}_w} = 1 \end{aligned} \quad (3.64)$$

because of Stoke's law.

### DIFFEOMORPHISM INVARIANCE

Besides, the amplitude is invariant under diffeomorphisms of the cylinder that are connected to the identity and reduce to the identity on the boundary. Such diffeomorphisms are simply a change of the triangulation followed by a change of variables in the associated integrals, as well as a smooth deformation of the cut. This is not true if we consider large diffeomorphisms because the latter induce a non homotopic change of the cut. We shall come back to this point in chapter 5.

### § 3.5 TRANSITION FUNCTIONS

From figure 3.4 one can learn that a triangulation of  $\mathcal{S}_c$  such that  $\varphi(c_i) \subset \mathcal{U}_{\alpha_i}$ ,  $\varphi(s_j) \subset \mathcal{U}_{\beta_j}$  and  $\varphi(v_k) \in \mathcal{U}_{\gamma_k}$  induces a triangulation on the boundary circles. These induced triangulations

shall serve to define an open cover of the string's configuration space  $\mathcal{C}_w$ . In analogy to the particle we would like to interpret the string wave functions as sections of a line bundle over  $\mathcal{C}_w$ . For that, one has to define the open sets  $\mathcal{U}_I$  used to cover the string space. Afterwards one needs transition functions  $G_{IJ}$  that allow to glue together the local data, exactly like in the case for the line bundle of the particle. Recall that, for the particle, the magnetic amplitude (2.47) depends on the open sets pertaining to the end points of the path and the propagator is interpreted as a map from the fiber at the initial position  $x$  to the fibre at  $y$  acting on wave functions being sections of this bundle. Something similar happens for strings.  $I$  and  $J$  are indices that label a covering of  $\mathcal{C}_w$  by open sets  $\mathcal{U}_I$  and the string wave functions are sections of a bundle over  $\mathcal{C}_w$ . The dependence of the magnetic amplitude for the string (3.62) on the induced triangulations  $I$  and  $J$  is thus not very surprising. This is why in (3.62) it was written with the two indices,  $\mathcal{A}_{JI}[\phi]$ .

Suppose, there are two triangulations of the cut circle,  $I$  and  $J$ , or equivalently, periodic triangulations of the real line. The triangulation  $I$  is defined by segments  $s$  and vertices  $v$ , such that  $X(s) \subset \mathcal{U}_{\alpha_s}$  and  $X(v) \in \mathcal{U}_{\beta_v}$ . The triangulation  $J$  is defined by  $s'$  and  $v'$  such that  $X(s') \subset \mathcal{U}_{\alpha'_{s'}}$  and  $X(v') \in \mathcal{U}_{\beta'_{v'}}$ . For notational reasons, the numbering index of segments and vertices is omitted, because a condensed notation permits to write down the transition functions more clearly. Motivated by [2], the open sets  $\mathcal{U}_I$  can be defined to be

$$\mathcal{U}_I = \{ X \in \mathcal{C}_w \quad \text{such that} \quad X(s) \subset \mathcal{U}_{\alpha_s} \quad \text{and} \quad X(v) \in \mathcal{U}_{\beta_v} \} \quad (3.65)$$

and varying over all triangulations and assignments, these open sets cover  $\mathcal{C}_w$ . Consider now a non-empty intersection  $\mathcal{U}_I \cap \mathcal{U}_J$  defined by segments  $\bar{s} := s \cap s'$  and associated vertices  $\bar{v}$ . As an important definition, set  $\alpha_{\bar{s}} = \alpha_s$  and  $\alpha'_{\bar{s}} = \alpha'_{s'}$ . For  $\bar{v}$  set

$$\beta_{\bar{v}} = \begin{cases} \beta_v & \text{if } \bar{v} = v \\ \alpha_s & \text{if } \bar{v} \in s \end{cases}, \quad \beta'_{\bar{v}} = \begin{cases} \beta'_{v'} & \text{if } \bar{v} = v' \\ \alpha'_{s'} & \text{if } \bar{v} \in s' \end{cases} \quad (3.66)$$

Then, the transition functions  $G_{IJ}$  are defined as

$$G_{IJ}(X) = \exp \left\{ i \sum_{\bar{s}} \int_{\bar{s}} X^* B_{\alpha_{\bar{s}} \alpha'_{\bar{s}}} \right\} \prod_{\bar{v}, \bar{s} | \bar{v} \in \partial \bar{s}} \left( \frac{X^* f_{\alpha_{\bar{v}} \alpha'_{\bar{v}} \alpha'_{\bar{s}}}(\bar{v})}{X^* f_{\alpha_{\bar{v}} \alpha_{\bar{s}} \alpha'_{\bar{s}}}(\bar{v})} \right)^{-\epsilon(\bar{v})} \times X^* f_{w; \beta_{v_0} \beta'_{v_0}}(0) \quad (3.67)$$

with  $v_0$  being the vertex of the cut and  $\epsilon(\bar{v})$  takes values  $-1$  if  $\bar{v}$  is the first vertex of  $\bar{s}$ , and  $+1$  if  $\bar{v}$  is the second. Here, the order is given by the intrinsic order of the single segments  $\bar{s}$ . With these conventions, it is possible to prove

$$G_{IK}(X) = G_{IJ}(X) G_{JK}(X) \quad (3.68)$$

for  $X \in \mathcal{U}_I \cap \mathcal{U}_J \cap \mathcal{U}_K$ .

For example, consider a configuration of 3 intersecting triangulations building up four segments,  $\bar{l}_1, \dots, \bar{l}_4$ . This means that  $I$  is covered by  $\bar{l}_1$  and  $\bar{l}_2 + \bar{l}_3 + \bar{l}_4$  with vertices  $v_0, v_1$  and  $v_0 \cdot w$ . The intersection  $J$  is covered by  $\bar{l}_1 + \bar{l}_2$  and  $\bar{l}_3 + \bar{l}_4$  with bounding vertices  $v_0, v_2$  and  $v_0 \cdot w$ . According to

this,  $K$  has  $\bar{l}_1 + \bar{l}_2 + \bar{l}_3$  and  $\bar{l}_4$  with vertices  $v_0, v_3$  and  $v_0 \cdot w$ . Compute  $G_{IJ}, G_{JK}$  and  $G_{IK}$  to see what terms are involved:

$$G_{IJ} = \exp\left\{i \int_{\bar{l}_1} X^* B_{\alpha_0 \alpha'_0} + i \int_{\bar{l}_2} X^* B_{\alpha_1 \alpha'_0} + i \int_{\bar{l}_3 + \bar{l}_4} X^* B_{\alpha_1 \alpha'_1}\right\} X^* f_{w; \beta_0 \beta'_0}^{-1} \quad (3.69)$$

$$\left(\frac{f_{\beta_0 \beta'_0 \alpha'_0}}{f_{\beta_0 \alpha_0 \alpha'_0}}\right)_{v_0} \left(\frac{f_{\beta_1 \alpha'_0 \alpha'_0}}{f_{\beta_1 \alpha_0 \alpha'_0}}\right)_{v_1}^{-1} \left(\frac{f_{\beta_1 \beta'_0 \alpha'_0}}{f_{\beta_1 \alpha_1 \alpha'_0}}\right)_{v_1} \left(\frac{f_{\alpha_1 \beta'_1 \alpha'_0}}{f_{\alpha_1 \alpha_1 \alpha'_0}}\right)_{v_2}^{-1} \left(\frac{f_{\alpha_1 \beta'_1 \alpha'_1}}{f_{\alpha_1 \alpha_1 \alpha'_1}}\right)_{v_2} \left(\frac{f_{\beta_0 \beta'_0 \alpha'_1}}{f_{\beta_0 \alpha_1 \alpha'_1}}\right)_{v_0 \cdot w}^{-1},$$

$$G_{JK} = \exp\left\{i \int_{\bar{l}_1 + \bar{l}_2} X^* B_{\alpha'_0 \alpha''_0} + i \int_{\bar{l}_3} X^* B_{\alpha'_1 \alpha''_0} + i \int_{\bar{l}_4} X^* B_{\alpha'_1 \alpha''_1}\right\} X^* f_{w; \beta'_0 \beta''_0}^{-1} \quad (3.70)$$

$$\left(\frac{f_{\beta'_0 \beta''_0 \alpha''_0}}{f_{\beta'_0 \alpha'_0 \alpha''_0}}\right)_{v_0} \left(\frac{f_{\beta'_1 \alpha''_0 \alpha''_0}}{f_{\beta'_1 \alpha'_0 \alpha''_0}}\right)_{v_2}^{-1} \left(\frac{f_{\beta'_1 \alpha''_0 \alpha''_0}}{f_{\beta'_1 \alpha'_1 \alpha''_0}}\right)_{v_2} \left(\frac{f_{\alpha'_1 \beta'_1 \alpha''_0}}{f_{\alpha'_1 \alpha'_1 \alpha''_0}}\right)_{v_3}^{-1} \left(\frac{f_{\alpha'_1 \beta'_1 \alpha''_1}}{f_{\alpha'_1 \alpha'_1 \alpha''_1}}\right)_{v_3} \left(\frac{f_{\beta'_0 \beta''_0 \alpha''_1}}{f_{\beta'_0 \alpha'_1 \alpha''_1}}\right)_{v_0 \cdot w}^{-1},$$

$$G_{IK} = \exp\left\{i \int_{\bar{l}_1} X^* B_{\alpha_0 \alpha'_0} + i \int_{\bar{l}_2 + \bar{l}_3} X^* B_{\alpha_1 \alpha'_0} + i \int_{\bar{l}_4} X^* B_{\alpha_1 \alpha'_1}\right\} X^* f_{w; \beta_0 \beta'_0}^{-1} \quad (3.71)$$

$$\left(\frac{f_{\beta_0 \beta'_0 \alpha'_0}}{f_{\beta_0 \alpha_0 \alpha'_0}}\right)_{v_0} \left(\frac{f_{\beta_1 \alpha'_0 \alpha'_0}}{f_{\beta_1 \alpha_0 \alpha'_0}}\right)_{v_1}^{-1} \left(\frac{f_{\beta_1 \alpha'_0 \alpha'_0}}{f_{\beta_1 \alpha_1 \alpha'_0}}\right)_{v_1} \left(\frac{f_{\alpha_1 \beta'_1 \alpha'_0}}{f_{\alpha_1 \alpha_1 \alpha'_0}}\right)_{v_3}^{-1} \left(\frac{f_{\alpha_1 \beta'_1 \alpha'_1}}{f_{\alpha_1 \alpha_1 \alpha'_1}}\right)_{v_3} \left(\frac{f_{\beta_0 \beta'_0 \alpha'_1}}{f_{\beta_0 \alpha_1 \alpha'_1}}\right)_{v_0 \cdot w}^{-1},$$

where the notation  $(\cdot)_{v_i}$  means  $X^*(\cdot)(v_i)$ . The integrals over the 1-forms  $B_{ij}$  can be eliminated using the third relation of equation (3.30), i.e.  $B_{ij} + B_{jk} + B_{ki} = \text{id} \log f_{ijk}$ . The other terms can be rearranged using the cocycle condition  $f_{jkl} f_{ikl}^{-1} f_{ijl} f_{ijk}^{-1} = 1$  and from (3.45) recall  $w^* f_{ijk} (f_{ijk})^{-1} = f_{w; ik} f_{w; kj} f_{w; ji}$ . All together, one finds after writing down over  $\sim 40$  terms and a long and tedious calculation that  $\frac{G_{IJ} G_{JK}}{G_{IK}} = 1$ , which is the required condition for the transition functions.

Accordingly, a line bundle can be constructed on  $\mathcal{C}_w$  using these transition functions. The string wave functions are sections of this bundle, defined locally in the chart  $\mathcal{U}_I$  by a complex valued function  $\Psi_I$  that fulfills  $\Psi_I = G_{IJ} \Psi_J$  on overlapping charts. We denote by  $\mathcal{H}_w$  the space of sections of the line bundle over  $\mathcal{C}_w$ .

The magnetic amplitude (3.62) only depends on the fields  $\mathbf{A} \in \mathcal{T}_{1,1}$  and  $\mathbf{B} \in \mathcal{T}_{0,2}$ , on the surface  $\Sigma$  swept out by the string in  $\mathcal{M}$  and on the triangulations and assignments  $I$  and  $J$  pertaining to  $X$  and  $Y$ . Because the expression (3.62) is rather cumbersome to work with, we abbreviate it as we did for the particle

$$\mathcal{A}_{JI}[\varphi] = \left[ e^{i \int_{\Sigma} \mathbf{B} + i \int_x^y \mathbf{A}_w} \right]_{JI}, \quad (3.72)$$

where  $x = X(0)$  and  $y = Y(0)$ . However, there are some computations that follow in the explicit version of formula (3.72). Recall that  $\mathbf{B} = (B_i, B_{ij}, f_{ijk})$  and  $\mathbf{A}_w = (A_{w;i}, f_{w;ij})$  contain all fields such that the choice of the notation in (3.72) exactly reproduces (3.62). In words, it really means that one has to cut the cylinder, triangulate it and compute the amplitude as in (3.62). For topologically trivial fields,  $\mathbf{B}$  and  $\mathbf{A}_w$  can be identified with de Rham forms  $B$  and  $A_w$ , and (3.72) can be taken literally as the integrals of  $B$  over  $\Sigma$  and of  $A_w$  over the cut joining  $x$  to  $y$ . The same argument holds for the locally constructed particle magnetic amplitude. Here, the contributions of  $\mathbf{B}$  and  $\mathbf{A}_w$  cannot be separated, only their combination is consistent.

From this construction, the dependence of the magnetic amplitude (3.62) on the covering and assignments pertaining to the endpoints is readily expressed using the transition functions. If one trades  $I$  and  $J$  for  $K$  and  $L$ , a simple argumentation shows that

$$\left[ e^{i \int_{\Sigma} \mathbf{B} + i \int_x^y \mathbf{A}_w} \right]_{LK} = G_{LJ} \left[ e^{i \int_{\Sigma} \mathbf{B} + i \int_x^y \mathbf{A}_w} \right]_{JI} G_{IK}, \quad (3.73)$$

which is in agreement with its interpretation as an holonomy in the line bundle, in analogy with the particle's case, compare to (2.48). Since the transition  $I \rightarrow K$  and  $J \rightarrow L$  changes the triangulation on the boundary, this transition comes together with a reassignment of the 'inner' triangulation of  $\mathcal{A}_{JI}$  which is compatible with the new induced  $K$  and  $L$ . Because  $\mathcal{A}_{JI}$  is triangulation-invariant (up to the triangulation on the boundary), (3.73) describes the right procedure of such a re-triangulation including the boundary terms.

### § 3.6 GAUGE TRANSFORMATIONS

As a warm up for the derivation of stringy magnetic translations, consider now a gauge transformation (3.46) given by  $\Lambda = (\Lambda_i, \eta_{ij})$  and  $\Theta_w = (\theta_{w,i})$  acting on the fields as in (3.48). Explicitly, there are many fields involved in such transformations. For the magnetic amplitude, it induces the following change:

$$\mathcal{A}_{JI}[\varphi] = \left[ e^{i \int_{\Sigma} \mathbf{B} + i \int_x^y \mathbf{A}_w} \right]_{JI} \rightarrow \mathcal{A}'_{JI}[\varphi] = \left[ e^{i \int_{\Sigma} (\mathbf{B} + \mathcal{D}\Lambda) + i \int_x^y (\mathbf{A}_w + w^* \Lambda - \Lambda + \mathcal{D}\Theta_w)} \right]_{JI}. \quad (3.74)$$

Upon expressing everything using the triangulations and the explicit form of the gauge transformations (3.48), there are cancellations occurring simplex by simplex in such a way that only boundary terms remain. One can safely dare to write down the explicit ratio

$$\frac{\mathcal{A}'_{JI}[\varphi]}{\mathcal{A}_{JI}[\varphi]} = \exp\left\{i \sum_{c_i} \int_{\partial c_i} \varphi^* \Lambda_{\alpha_i}\right\} \exp\left\{i \sum_{\substack{c_i, s_j \\ s_j \subset \partial c_i}} \int_{s_j} \varphi^* (\Lambda_{\beta_j} - \Lambda_{\alpha_i})\right\} \prod_{\substack{c_i, s_j \\ s_j \subset \partial c_i}} \varphi^* \eta_{\alpha_i \beta_j} \Big|_{\partial s_j} \quad (3.75)$$

$$\times \prod_{\substack{c_i, s_j, v_k \\ s_j \subset \partial c_i \\ v_k \in \partial s_j}} (\eta_{\beta_j \gamma_k}^{-1} \eta_{\alpha_i \gamma_k} \eta_{\alpha_i \beta_j}^{-1})^{\epsilon(j,k)} \times \exp\left\{i \sum_{s'_j} \int_{\varphi(s'_j)} (w^* \Lambda_{\beta'_j} - \Lambda_{\beta'_j})\right\} \quad (3.76)$$

$$\times \prod_{s'_j} \varphi^* \theta_{w; \beta'_j}^{-1} \Big|_{\partial s'_j} \times \prod_{\substack{s'_j, v'_k \\ v'_k \in \partial s'_j}} \varphi^* \left( \frac{w^* \eta_{\beta'_j \gamma'_k}}{\eta_{\beta'_j \gamma'_k}} \theta_{w; \gamma'_k} \theta_{w; \beta'_j}^{-1} \right)^{-\epsilon(j,k)} (v'_k) \quad (3.77)$$

$$= \exp\left\{i \sum_{s_j \subset \partial c_i} \int_{s_j} \varphi^* \Lambda_{\beta_j}\right\} \exp\left\{i \sum_{s'_j} \int_{\varphi(s'_j)} w^* \Lambda_{\beta'_j} - \Lambda_{\beta'_j}\right\} \quad (3.78)$$

$$\times \prod_{\substack{c_i, s_j, v_k \\ s_j \subset \partial c_i \\ v_k \in \partial s_j}} (\eta_{\beta_j \gamma_k})^{-\epsilon(j,k)} (\varphi(v_k)) \prod_{\substack{s'_j, v'_k \\ v'_k \in \partial s'_j}} \left( \frac{w^* \eta_{\beta'_j \gamma'_k}}{\eta_{\beta'_j \gamma'_k}} \theta_{w; \gamma'_k} \right)^{-\epsilon(j,k)} (\varphi(v'_k)). \quad (3.79)$$

The last expression has an amazing abbreviation in terms of the compact notation introduced in (3.72). It reads

$$\frac{\mathcal{A}'_{JI}[\varphi]}{\mathcal{A}_{JI}[\varphi]} = \left[ \Theta_w(x) e^{-i \int_x^{xw} \Lambda} \right]_I \left[ \Theta_w^{-1}(y) e^{i \int_y^{yw} \Lambda} \right]_J. \quad (3.80)$$

While all 'inner' integrals along triangles cancel, the contribution of  $\Lambda$  along the cut cancels with the lateral boundary of the world-sheet  $\Sigma$ . Only the integrals of  $\Lambda$  along the incoming and outgoing string remain, where the open sets  $\mathcal{U}_{\beta_j}$  are the ones defining the covers  $I$ ,  $J$  respectively. The third term in line (3.75) is canceled by the  $\eta_{\alpha_i \beta_j}$ -part of the first term in row (3.76). Elements of the form  $\eta_{\alpha_i \gamma_k}$  vanish, because they cancel separately for each triangle. The  $\eta_{\beta_j \gamma_k}$ 's together with the integrals over  $\Lambda$  thus generate a factor  $[e^{-i \int_x^{xw} \Lambda}]_I$  and  $[e^{i \int_y^{yw} \Lambda}]_J$  with  $\Lambda = (\Lambda_i, \eta_{ij}) \in \mathcal{T}_{0,1}$ , where  $[\cdot \cdot \cdot]_I$  always means that the expression inside the bracket is evaluated using the triangulation and assignments given by  $I$ , i.e. taking the line integrals segment by segment and introducing the  $U(1)$ -valued function  $\eta$  for each vertex between the segments analogously to the particle's amplitude. The remaining terms in line (3.77) containing  $\theta$ 's along the cut all cancel as well, apart from two values  $\theta_{w; \gamma'_x}(x)$  and  $\theta_{w; \gamma'_y}^{-1}(y)$  with  $\gamma'_x$  and  $\gamma'_y$  indicating the open sets  $\mathcal{U}_{\gamma'_x}$  and  $\mathcal{U}_{\gamma'_y}$  used on the boundary at  $X(0)$ ,  $Y(0)$  respectively, induced by  $I$  and  $J$ . For the notation, recall that  $\Theta \in \mathcal{T}_{1,0}$  with only one local component,  $\Theta = (\theta_{g;i})$ .

Therefore, the gauge transformed amplitude reads

$$\left[ \Theta_w^{-1}(y) e^{i \int_y^{yw} \Lambda} \right]_J \left[ e^{i \int_{\Sigma} \mathbf{B} + i \int_x^y \mathbf{A}_w} \right]_{JI} \left[ \Theta_w(x) e^{-i \int_x^{xw} \Lambda} \right]_I. \quad (3.81)$$

Note the identical structure in comparison with formula (2.53) for the particle. For physics to remain invariant, the wave function has to be changed as

$$\Psi_I(X) \rightarrow \left[ \Theta_w^{-1}(x) e^{i \int_x^{xw} \Lambda} \right]_I \Psi_I(X). \quad (3.82)$$

It is worthwhile to notice that in addition to the expected 1-form gauge transformation given by  $\Lambda$ , there is a new, winding dependent, scalar gauge transformation associated to  $\Theta$ . This part of the general gauge transformation shall be referred to as *secondary gauge transformations* in the sequel.

### § 3.7 STRINGY MAGNETIC TRANSLATIONS

At the classical level, the group  $G$  transforms a string  $X_w$  that starts at  $x$  and ends at  $x \cdot w$ , into the string  $X_w \cdot g$ , starting at  $x \cdot g$  and ending at  $x \cdot w g = x \cdot g w^g$ , with  $w^g = g^{-1} w g$ . Accordingly,  $g$  changes the winding from  $w$  to  $w^g$  and defines a map from  $\mathcal{C}_w$  to  $\mathcal{C}_{w^g}$ . This is a complication that enters because the group  $G$  is assumed to be non commutative. However, all results also hold in the commutative case but they simplify dramatically.

The stringy magnetic translation must therefore be interpreted as a map

$$T_g^w : \mathcal{H}_{w^g} \rightarrow \mathcal{H}_w \quad (3.83)$$

realizing the translations at the quantum level as the pull-back action on sections of the corresponding bundles, followed by a multiplication by a winding dependent phase factor. In accordance with formula (2.55), they can be written as

$$[T_g^w \Psi]_I(X_w) = [\Upsilon_g^w(X_w)]_I \Psi_I(X_w \cdot g), \quad (3.84)$$

for any  $X_w \in U_I \subset \mathcal{C}_w$ . Because the open cover of  $\mathcal{M}$  is invariant, we are allowed to use  $\mathcal{U}_I$  to cover  $\mathcal{C}_{w^g}$ , with the same triangulation and assignment. This can be summarized by the assertion that the collection of all  $\mathcal{U}_I$  forms an invariant cover of  $\mathcal{C} = \cup_w \mathcal{C}_w$ . Once determined the covering dependent phase  $[\Upsilon_g^w(X)]_I$ , it will be necessary to show that all  $[T_g^w \Psi]_I$  can be glued together to form a section over  $\mathcal{C}_w$  that belongs to  $\mathcal{H}_w$ .

To proceed as for the particle, the unknown phase is determined by requiring that  $T_g^w$  commutes with string propagation. To obtain a sufficient condition ensuring this commutation, let us perform a heuristic analysis, similar to the path integral derivation in section 2.5. Following (3.60), the propagation process of a string of winding  $w$  is expressed as

$$\Psi_w(X) \rightarrow \Psi'_w(Y) = \int [DX] K_w(Y; X) \Psi_w(X), \quad (3.85)$$

where the index  $I$  has been omitted for clarity. The most important postulation is then (in terms of matrix elements) the commutation relation

$$T_g^w K_{w^g} = K_w T_g^w \quad (3.86)$$

or equivalently, the commutation of the diagram

$$\begin{array}{ccc} \mathcal{H}_w & \xrightarrow{K_w} & \mathcal{H}_w \\ T_g^w \uparrow & & \uparrow T_g^w \\ \mathcal{H}_{w^g} & \xrightarrow{K_{w^g}} & \mathcal{H}_{w^g} \end{array} \quad (3.87)$$

as the guiding principle. Including the yet to be defined phases  $\Upsilon$  into this commutation relation yields on the level of matrix elements

$$\Upsilon_g^w(Y) K_{w^g}(Y \cdot g; X \cdot g) = K_w(Y; X) \Upsilon_g^w(X), \quad (3.88)$$

which can be considered as the analogue to (2.69). From here, the analysis goes as before, namely if this commutation relation holds for the propagator, it is sufficient to postulate it for the magnetic amplitude, the object we now know to handle. Again, this can be achieved by assuming that all terms in the path integral (3.59) but the magnetic amplitudes are genuinely invariant under the action of  $G$ . By equating the magnetic contribution of  $\varphi \cdot g$  and  $\varphi$  in the path integral on both sides of (3.88),

$$[\Upsilon_g^w(Y)]_J \mathcal{A}_{JI}[\varphi \cdot g] = \mathcal{A}_{JI}[\varphi] [\Upsilon_g^w(X)]_I, \quad (3.89)$$

we get the sufficient condition for the commutation to hold.

It is then clear how one should proceed. Using the explicit expression of the magnetic amplitude, compute the ratio of  $\mathcal{A}_{JI}[\varphi \cdot g]$  and  $\mathcal{A}_{JI}[\varphi]$  and read off the phase  $\Upsilon_g^w$  for the magnetic translations. The explicit form in terms of a triangulation will involve a lot of terms, of which a great number should cancel. To compare the two contributions, the key will be to make considerable use of the relations for the local fields (3.45). Let us see if one can cancel terms. Start from the results of the previous section, and write down the amplitude of the translated cylinder:

$$\mathcal{A}_{JI}[\varphi \cdot g] = \left[ e^{i \int_{\Sigma} g^* \mathbf{B} + i \int_x^y g^* \mathbf{A}_{wg}} \right]_{JI}. \quad (3.90)$$

Then, writing everything out with Čech indices, the ratio takes the form

$$\frac{\mathcal{A}_{JI}[\varphi \cdot g]}{\mathcal{A}_{JI}[\varphi]} = \exp\{i \sum_{c_i} \int_{\varphi(c_i)} g^* B_{\alpha_i} - B_{\alpha_i}\} \exp\{i \sum_{\substack{c_i, s_j \\ s_j \subset \partial c_i}} \int_{\varphi(s_j)} g^* B_{\alpha_i \beta_j} - B_{\alpha_i \beta_j}\} \quad (3.91)$$

$$\times \exp\{i \sum_{s'_j} \int_{\varphi(s'_j)} g^* A_{wg; \beta'_j} - A_{w; \beta'_j}\} \quad (3.92)$$

$$\times \prod_{\substack{c_i, s_j, v_k \\ s_j \subset \partial c_i \\ v_k \in \partial s_j}} \left( \frac{g^* f_{\alpha_i \beta_j \gamma_k}}{f_{\alpha_i \beta_j \gamma_k}} \right)^{\epsilon(j, k)} (\varphi(v_k)) \times \prod_{\substack{s'_j, v'_k \\ v'_k \in \partial s'_j}} \left( \frac{g^* f_{w g; \beta'_j \gamma'_k}}{f_{w; \beta'_j \gamma'_k}} \right)^{-\epsilon(j, k)} (\varphi(v'_k)). \quad (3.93)$$

The first term in line (3.91) is easily evaluated using  $g^* B_i - B_i = dA_{g; i}$  from (3.45). One obtains a boundary term

$$\exp\{i \sum_{c_i} \int_{\varphi(c_i)} g^* B_{\alpha_i} - B_{\alpha_i}\} = \exp\{i \sum_{\substack{c_i, s_j \\ s_j \subset \partial c_i}} \int_{s_j} \varphi^* A_{g; \alpha_i}\}. \quad (3.94)$$

Analogously, for the 1-form term of (3.91)

$$\exp\{i \sum_{\substack{c_i, s_j \\ s_j \subset \partial c_i}} \int_{\varphi(s_j)} g^* B_{\alpha_i \beta_j} - B_{\alpha_i \beta_j}\} \quad (3.95)$$

$$= \exp\{i \sum_{\substack{c_i, s_j \\ s_j \subset \partial c_i}} \int_{\varphi(s_j)} A_{g; \beta_j} - A_{g; \alpha_i} - i d \log f_{g; \alpha_i \beta_j}\} \quad (3.96)$$

$$= \exp\{i \sum_{\substack{c_i, s_j \\ s_j \subset \partial c_i}} \int_{\varphi(s_j)} A_{g; \beta_j} - A_{g; \alpha_i}\} \times \prod_{\substack{c_i, s_j, v_k \\ s_j \subset \partial c_i \\ v_k \in \partial s_j}} f_{g; \alpha_i \beta_j}^{\epsilon(j, k)} (\varphi(v_k)). \quad (3.97)$$

The term in (3.92) is not so easy to transform to a boundary. For that, it is convenient to use the relation

$$\mathcal{D}\Phi = \delta \mathbf{A} \rightarrow i d \log \phi_{g, h; i} = g^* A_{h; i} - A_{gh; i} + A_{g; i} \quad (3.98)$$

for the definition of a new field

$$\Gamma_{g, h} = \Phi_{h, g^h} \Phi_{g, h}^{-1} \in \mathcal{T}_{2,0}, \quad (3.99)$$

such that with  $\Gamma_{g,h} = (\Gamma_{g,h;i}) = (\phi_{h,g,h;i} \phi_{g,h;i}^{-1})$  one has

$$\text{id log } \Gamma_{g,h;i} = h^* A_{g^h;i} - A_{g;i} - g^* A_{h;i} + A_{h;i}, \quad (3.100)$$

or, including all fields, in Deligne cohomology,

$$\mathcal{D}\Gamma_{g,h} = h^* \mathbf{A}_{g^h} - \mathbf{A}_g - g^* \mathbf{A}_h + \mathbf{A}_h. \quad (3.101)$$

Recall that  $g^h \equiv h^{-1}gh$ . Formula (3.100) can be used to obtain

$$\begin{aligned} & \exp\left\{i \sum_{s'_j} \int_{\varphi(s'_j)} g^* A_{w^g;\beta'_j} - A_{w;\beta'_j}\right\} \\ &= \exp\left\{i \sum_{s'_j} \int_{\varphi(s'_j)} w^* A_{g;\beta'_j} - A_{g;\beta'_j}\right\} \times \prod_{\substack{s'_j, v'_k \\ v'_k \in \partial s'_j}} \Gamma_{w,g;\beta'_j}^{-\epsilon(j,k)}(\varphi(v'_k)). \end{aligned} \quad (3.102)$$

To evaluate the second term in (3.93), we use again (3.101), but with the second field component, i.e.

$$\frac{\Gamma_{g,h;j}}{\Gamma_{g,h;i}} = \frac{h^* f_{g^h;ij} f_{h;ij}}{f_{g;ij} g^* f_{h;ij}}, \quad (3.103)$$

such that

$$\prod_{\substack{s'_j, v'_k \\ v'_k \in \partial s'_j}} \left( \frac{g^* f_{w^g;\beta'_j \gamma'_k}}{f_{w;\beta'_j \gamma'_k}} \right)^{-\epsilon(j,k)}(\varphi(v'_k)) = \prod_{\substack{s'_j, v'_k \\ v'_k \in \partial s'_j}} \left( \frac{w^* f_{g;\beta'_j \gamma'_k}}{f_{g;\beta'_j \gamma'_k}} \frac{\Gamma_{w,g;\gamma'_k}}{\Gamma_{w,g;\beta'_j}} \right)^{-\epsilon(j,k)}(\varphi(v'_k)). \quad (3.104)$$

Finally, the first term in (3.93) is standard, and can be rewritten using (3.45) again,

$$\prod_{\substack{c_i, s_j, v_k \\ s_j \subset \partial c_i \\ v_k \in \partial s_j}} \left( \frac{g^* f_{\alpha_i \beta_j \gamma_k}}{f_{\alpha_i \beta_j \gamma_k}} \right)^{\epsilon(j,k)}(\varphi(v_k)) = \prod_{\substack{c_i, s_j, v_k \\ s_j \subset \partial c_i \\ v_k \in \partial s_j}} \left( \frac{f_{g;\alpha_i \gamma_k}}{f_{g;\beta_j \gamma_k} f_{g;\alpha_i \beta_j}} \right)^{\epsilon(j,k)}(\varphi(v_k)). \quad (3.105)$$

Collecting all together, the result for the ratio (3.91)-(3.93) is

$$\frac{\mathcal{A}_{JI}[\varphi \cdot g]}{\mathcal{A}_{JI}[\varphi]} = \exp\left\{i \sum_{\substack{c_i, s_j \\ s_j \subset \partial c_i}} \int_{\varphi(s_j)} A_{g;\alpha_i}\right\} \exp\left\{i \sum_{\substack{c_i, s_j \\ s_j \subset \partial c_i}} \int_{\varphi(s_j)} A_{g;\beta_j} - A_{g;\alpha_i}\right\} \quad (3.106)$$

$$\times \prod_{\substack{c_i, s_j, v_k \\ s_j \subset \partial c_i \\ v_k \in \partial s_j}} f_{g;\alpha_i \beta_j}^{\epsilon(j,k)}(\varphi(v_k)) \exp\left\{i \sum_{s'_j} \int_{\varphi(s'_j)} w^* A_{g;\beta'_j} - A_{g;\beta'_j}\right\} \quad (3.107)$$

$$\times \prod_{\substack{s'_j, v'_k \\ v'_k \in \partial s'_j}} \Gamma_{w,g;\beta'_j}^{-\epsilon(j,k)}(\varphi(v'_k)) \times \prod_{\substack{s'_j, v'_k \\ v'_k \in \partial s'_j}} \left( \frac{w^* f_{g;\beta'_j \gamma'_k}}{f_{g;\beta'_j \gamma'_k}} \frac{\Gamma_{w,g;\gamma'_k}}{\Gamma_{w,g;\beta'_j}} \right)^{-\epsilon(j,k)}(\varphi(v'_k)) \quad (3.108)$$

$$\times \prod_{\substack{c_i, s_j, v_k \\ s_j \subset \partial c_i \\ v_k \in \partial s_j}} \left( \frac{f_{g;\alpha_i \gamma_k}}{f_{g;\beta_j \gamma_k} f_{g;\alpha_i \beta_j}} \right)^{\epsilon(j,k)}(\varphi(v_k)), \quad (3.109)$$

and after some cancellations similar to the ones that occurred for the computation of the gauge transformation ratio (3.75)-(3.77),

$$\begin{aligned} \frac{\mathcal{A}_{JI}[\varphi \cdot g]}{\mathcal{A}_{JI}[\varphi]} &= \exp\left\{i \sum_{s'_j} \int_{\varphi(s'_j)} w^* A_{g;\beta'_j} - A_{g;\beta_j}\right\} \exp\left\{i \sum_{\substack{c_i, s_j \\ s_j \subset \partial c_i}} \int_{\varphi(s_j)} A_{g;\beta_j}\right\} \quad (3.110) \\ &\times \prod_{\substack{c_i, s_j, v_k \\ s_j \subset \partial c_i \\ v_k \in \partial s_j}} f_{g;\beta_j \gamma_k}^{-\epsilon(j,k)}(\varphi(v_k)) \times \prod_{\substack{s'_j, v'_k \\ v'_k \in \partial s'_j}} \left( \frac{w^* f_{g;\beta'_j \gamma'_k}}{f_{g;\beta'_j \gamma'_k}} \Gamma_{w,g;\gamma'_k} \right)^{-\epsilon(j,k)}(\varphi(v'_k)), \quad (3.111) \end{aligned}$$

which can be written very conveniently using our [...] -notation:

$$\frac{\mathcal{A}_{JI}[\varphi \cdot g]}{\mathcal{A}_{JI}[\varphi]} = \left[ \Gamma_{w,g}^{-1}(y) e^{i \int_y^{y w} \mathbf{A}_g} \right]_J \left[ \Gamma_{w,g}(x) e^{-i \int_x^{x w} \mathbf{A}_g} \right]_I. \quad (3.112)$$

Accordingly, by comparing this with (3.89) and setting

$$\left[ \Upsilon_g^w(X) \right]_I = \left[ \Gamma_{w,g}(x) e^{-i \int_x^{x w} \mathbf{A}_g} \right]_I, \quad (3.113)$$

we can define the stringy magnetic translations as

$$\left[ T_g^w \Psi \right]_I(X) = \left[ \Gamma_{w,g}(x) e^{-i \int_x^{x w} \mathbf{A}_g} \right]_I \Psi_I(X \cdot g), \quad (3.114)$$

and the discussion preceding (3.89) ensures that it commutes with propagation.

Strictly speaking, the  $T_g^w$  are defined only for wave functions defined on local charts. To have operators defined between  $\mathcal{H}_{w,g}$  and  $\mathcal{H}_w$ , one has to check that all  $\left[ T_g^w \Psi \right]_I$  for various  $I$  can be glued into a global section on  $\mathcal{C}_w$ . But this follows from the relation

$$\frac{G_{IJ}(X \cdot g)}{G_{IJ}(X)} = \frac{\left[ \Gamma_{w,g}(x) e^{-i \int_x^{x w} \mathbf{A}_g} \right]_I}{\left[ \Gamma_{w,g}(x) e^{-i \int_x^{x w} \mathbf{A}_g} \right]_J}, \quad (3.115)$$

that is obtained from the explicit form of  $G_{IJ}$  given in (3.67) and a very long and tedious computation, since it only juggles relations between  $f_{w;ij}$  and  $f_{ijk}$  as well as their pull-backs by group elements.

As a simple illustration of the action of a stringy magnetic translation, consider the process  $K^{0 \rightarrow 1}(X; -)$  in which a single string with trivial winding  $w = 1_G$  is created out of the vacuum. The magnetic amplitude for such a process is

$$\mathcal{A}_I[\varphi] = \left[ e^{i \int_\Sigma \mathbf{B}} \right]_I, \quad (3.116)$$

where  $\Sigma = \varphi(\mathcal{S})$  is a cap as in figure 3.7. This amplitude is to be inserted into a path integral (3.59),

$$\Psi_I(X) = \int_{\varphi(\partial \mathcal{S})=X} [\mathcal{D}\varphi] e^{-S[\varphi]} \mathcal{A}_I[\varphi], \quad (3.117)$$

and yields a wave function for a string of trivial winding, which is invariant under  $G$ .

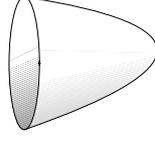

Figure 3.7: A cap.

### PROJECTIVE ACTION AND COCYCLE

In the particle's case, we have seen that magnetic translations only form a projective representation of  $G$ . In order to check if something similar happens for a string, let us compare  $T_g^w T_h^{w^g}$  with  $T_{gh}^w$ . On the left hand side, starting with  $\Psi \in \mathcal{H}_{w^g h}$ , we first act with  $T_h^{w^g}$

$$\Psi'_I(X) = [T_h^{w^g} \Psi]_I(X) = \left[ \Gamma_{w^g, h}(x) e^{-i \int_x^{xw^g} \mathbf{A}_h} \right]_I \Psi_I(X \cdot h), \quad \text{with } X \in \mathcal{C}_{w^g}. \quad (3.118)$$

Then, we further act on  $\Psi' \in \mathcal{H}_{wg}$  with  $T_g^w$ ,

$$[T_g^w \Psi']_I(X) = \left[ \Gamma_{w, g}(x) e^{-i \int_x^{xw} \mathbf{A}_g} \right]_I \Psi'_I(X \cdot g), \quad \text{with } X \in \mathcal{C}_w. \quad (3.119)$$

Replacing  $\Psi'$  by its expression, we arrive at

$$[T_g^w T_h^{w^g} \Psi]_I(X) = \left[ \Gamma_{w, g}(x) g^* \Gamma_{w^g, h}(x) e^{-i \int_x^{xw} (\mathbf{A}_g + g^* \mathbf{A}_h)} \right]_I \Psi_I(X \cdot gh), \quad \text{with } X \in \mathcal{C}_w, \quad (3.120)$$

where we have used the pull-back operation of  $g$  to trade the integral of  $\mathbf{A}_h$  over the string  $X \cdot g$  for the integral of  $g^* \mathbf{A}_h$  over  $X$ .

For the other hand side, calculate directly the action of  $T_{gh}^w$  to get

$$[T_{gh}^w \Psi]_I(X) = \left[ \Gamma_{w, gh}(x) e^{-i \int_x^{xw} \mathbf{A}_{gh}} \right]_I \Psi_I(X \cdot gh). \quad (3.121)$$

The result is that there is a phase mismatch between  $T_{gh}^w$  and  $T_g^w T_h^{w^g}$ , that is,

$$[T_g^w T_h^{w^g} \Psi(X)]_I = \left[ \mathcal{P}_w^{g, h}(X) \right]_I [T_{gh}^w \Psi(X)]_I, \quad (3.122)$$

with

$$\left[ \mathcal{P}_w^{g, h}(X) \right]_I = \frac{\left[ \Gamma_{w, g}(x) g^* \Gamma_{w^g, h}(x) e^{i \int_x^{xw} (\mathbf{A}_g + g^* \mathbf{A}_h)} \right]_I}{\left[ \Gamma_{w, gh}(x) e^{i \int_x^{xw} \mathbf{A}_{gh}} \right]_I}. \quad (3.123)$$

Using  $\mathcal{D}\Phi_{g, h} = g^* \mathbf{A}_h - \mathbf{A}_{gh} + \mathbf{A}_g$ , cancellations similar to the ones in (3.91)-(3.93) occur in the explicit evaluation using Čech cochains. Recall that

$$\Phi_{g, h} = (\phi_{g, h; i}) \in \mathcal{T}_{2, 0} \quad (3.124)$$

such that

$$\mathcal{D}\Phi = (\text{id log } \phi_{g, h; i}, \frac{\phi_{g, h; j}}{\phi_{g, h; i}}). \quad (3.125)$$

With (3.99), the result can then be expressed solely with  $\Phi$ 's:

$$\left[ \mathcal{P}_w^{g,h}(X) \right]_I = \left[ \frac{\Phi_{g,w^g} g^* \Phi_{h,w^{gh}} \Phi_{w,gh} w^* \Phi_{g,h}(x)}{\Phi_{w,g} g^* \Phi_{w^g,h} \Phi_{h,w^{gh}} \Phi_{g,h}} \right]_I. \quad (3.126)$$

After repeated use of  $\omega = \delta\Phi$ , or more precisely the special combination

$$\begin{cases} \omega_{g,h,w^{gh}} = g^* \Phi_{h,w^{gh}} \Phi_{gh,w^{gh}}^{-1} \Phi_{g,w^g h} \Phi_{g,h}^{-1} \\ \omega_{w,g,h} = w^* \Phi_{g,h} \Phi_{wg,h}^{-1} \Phi_{w,gh} \Phi_{w,g}^{-1} \\ \omega_{g,w^g,h} = g^* \Phi_{w^g,h} \Phi_{wg,h}^{-1} \Phi_{g,w^g h} \Phi_{g,w^g}^{-1} \end{cases} \quad (3.127)$$

the previous expression simplifies to

$$\mathcal{P}_w^{g,h} = \frac{\omega_{w,g,h} \omega_{g,h,w^{gh}}}{\omega_{g,w^g,h}}. \quad (3.128)$$

Further, because  $\mathcal{D}\omega = 0$ ,  $\omega$  is globally defined (i.e. it does not depend on the open set in which it has been computed) and is constant. This is why the  $I$  and  $X$  in the notation was dropped. As a generalization to the 2-cocycle in the particle case,  $\mathcal{P}_w^{g,h}$  describes a (winding-dependent) group 2-cochain fulfilling

$$\mathcal{P}_w^{g,h} \mathcal{P}_w^{gh,k} = \mathcal{P}_w^{g,hk} \mathcal{P}_{w^g}^{h,k} \quad (3.129)$$

which makes the action of  $T_g^w$  on the string states a projective one. In our context the appearance of  $w^g$  as an index of  $\mathcal{P}$  is due to the winding changing property of  $T_g^w$ . The occurrence of this combination of the 3-cocycle  $\omega$  corresponds to chopping the prism spanned by  $w$ ,  $w^g$  and  $w^{gh}$  into three tetrahedra, as can be seen in figure 3.8. We thus encountered a

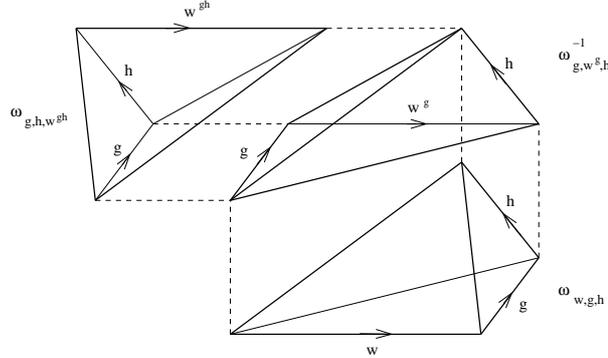

Figure 3.8: The phase of the product in terms of tetrahedra.

similar projective lift of the 'magnetic' translations with the general multiplication law

$$T_g^w T_h^v = \delta_{v,w^g} \mathcal{P}_w^{g,h} T_{gh}^w, \quad (3.130)$$

which is exactly the multiplication of the quasi-quantum group  $\mathcal{D}^\omega(\mathbb{K}G)$  introduced in [23] and the 'twisted' version of the *Drinfel'd quantum double* explained in the next chapter. Indeed, the phase  $\mathcal{P}$  can also be understood as a twist of the algebraic structure. As we shall see

later, it is just one component of a more general '2-cocycle', namely a 2-cocycle in a certain bicomplex twisting the algebra-part of  $\mathcal{D}^\omega(\mathbb{K}G)$  whose product law has just been found. Although a 3-cocycle like  $\omega_{g,h,k}$  usually indicates a breakdown of an associativity law, the product of three stringy magnetic translations remains associative, since they are operators in the Hilbert space, and which is assured by (3.128). However, we will encounter a certain kind of non-associativity due to this 3-cocycle when we will deal with the representation theory of this algebra.

As stated above, equation (3.130) gives us the first hint of the (possibly) more general algebraic structure of the operators  $T_g^w$  realizing the magnetic translations for the twisted sectors. Indeed, the structure of  $\mathcal{D}^\omega(\mathbb{K}G)$  is mathematically a bit more involved. As it turns out, one can analyze more complicated magnetic amplitudes associated to world-sheets whose topology encodes a string interaction. Arbitrary string processes, be it decompositions of one or more incoming strings, or even loop amplitudes, can be described by the associated Riemannian surfaces. As already said in the introductory paragraph of this chapter, we are going to extend our previous construction to a simple interaction encoded by a world-sheet which has the shape of a pair of pants. Since the outgoing is two strings, one has to find a consistent procedure of how to apply a magnetic translation. For that, one has to introduce the concept of a *coproduct* which is a basic ingredient of a bialgebra or *Hopf algebra*. Apart from that, there is a very rich representation theory, i.e. modules over such an algebra naturally carry certain equivalent features, for example a tensor product or a *braiding*. Since we want to understand the Hilbert spaces of the string states as modules over the algebra which is generated by the operators  $T_g^w$ , a further investigation of the underlying algebraic structure will give us some insights into the structure of the representation spaces in which the wave functions of the string live. As it turns out, one has to touch the domain of category theory and quasi-triangular quasi Hopf algebras. To provide some necessary definitions of the concepts to be used, the next chapter will list the most basic properties of various Hopf algebras.

In our context, when we will analyze the basic string interactions, most of the mathematical concepts will arise naturally from the asking for gauge invariance, like it has just happened for the product. The mathematical profoundness could, in principle, be ignored. However, as a beautiful mathematical construction, it is very worthwhile to develop the link between physical assumptions and the algebraic aspect of this theory.



---



---

## CHAPTER 4

---

### HOPF ALGEBRAS, CATEGORIES AND BRAIDS

This chapter shall be devoted to a brief survey of the basic definitions concerning Hopf algebras and quasi Hopf algebras. There is an interesting interconnectedness between bialgebras  $\mathcal{A}$  and their associated tensor categories  ${}_{\mathcal{A}}\mathcal{M}$  of representations which can be carried over to the case of braided or quasi-triangular Hopf algebras. In this case, the monoidal category of modules over the bialgebra inherits some key features of the underlying structure. As the most important referential literature one might mention the books [39, 40, 41] among other well established sources.

#### § 4.1 ALGEBRAS AND COALGEBRAS

In standard parlance, an algebra can be thought of as a triple  $(\mathcal{A}, \mu, \eta)$ , where  $\mathcal{A}$  is a vector space (over a field  $\mathbb{K}$ ) equipped with a product  $\mu : \mathcal{A} \otimes \mathcal{A} \rightarrow \mathcal{A}$  and a unit  $\eta : \mathbb{K} \rightarrow \mathcal{A}$  as linear maps such that the following diagrams commute:

◇ Associativity:

$$\begin{array}{ccc}
 \mathcal{A} \otimes \mathcal{A} \otimes \mathcal{A} & \xrightarrow{\mu \otimes \text{id}} & \mathcal{A} \otimes \mathcal{A} \\
 \text{id} \otimes \mu \downarrow & & \downarrow \mu \\
 \mathcal{A} \otimes \mathcal{A} & \xrightarrow{\mu} & \mathcal{A}
 \end{array} \tag{4.1}$$

(which is sometimes written as  $(a \cdot b) \cdot c = a \cdot (b \cdot c)$  for all  $a, b, c \in \mathcal{A}$ ).

◇ Unity:

$$\begin{array}{ccccc}
 \mathbb{K} \otimes \mathcal{A} & \xrightarrow{\eta \otimes \text{id}} & \mathcal{A} \otimes \mathcal{A} & \xleftarrow{\text{id} \otimes \eta} & \mathcal{A} \otimes \mathbb{K} \\
 & \searrow \simeq & \downarrow \mu & & \swarrow \simeq \\
 & & \mathcal{A} & & 
 \end{array} \tag{4.2}$$

(i.e.  $\eta(1_{\mathbb{K}})$  is a left and right unit for  $\mu$ ).

The algebra is said to be *commutative* if, in addition, the diagram

◇ Commutativity:

$$\begin{array}{ccc}
 \mathcal{A} \otimes \mathcal{A} & \xrightarrow{\tau} & \mathcal{A} \otimes \mathcal{A} \\
 & \searrow \mu & \downarrow \mu \\
 & & \mathcal{A}
 \end{array} \tag{4.3}$$

commutes. Here  $\tau$  denotes the *flip*, i.e.  $\tau(a \otimes b) = b \otimes a$  for  $a, b \in \mathcal{A}$ .

A coalgebra can be thought of as the dual picture of an algebra, which means that it is obtained by reversing the arrows in the diagrams (4.1), (4.2) and (4.3). Formally, a coalgebra is a triple  $(\mathcal{C}, \Delta, \epsilon)$ , where  $\mathcal{C}$  is a vector space over  $\mathbb{K}$  together with the coproduct  $\Delta : \mathcal{C} \rightarrow \mathcal{C} \otimes \mathcal{C}$  and the counit  $\epsilon : \mathcal{C} \rightarrow \mathbb{K}$ , i.e. linear maps such that the diagrams

◇ Coassociativity:

$$\begin{array}{ccc}
 \mathcal{C} \otimes \mathcal{C} \otimes \mathcal{C} & \xleftarrow{\Delta \otimes \text{id}} & \mathcal{C} \otimes \mathcal{C} \\
 \text{id} \otimes \Delta \uparrow & & \uparrow \Delta \\
 \mathcal{C} \otimes \mathcal{C} & \xleftarrow{\Delta} & \mathcal{C}
 \end{array} \tag{4.4}$$

and

◇ Counity:

$$\begin{array}{ccccc}
 \mathbb{K} \otimes \mathcal{C} & \xleftarrow{\epsilon \otimes \text{id}} & \mathcal{C} \otimes \mathcal{C} & \xrightarrow{\text{id} \otimes \epsilon} & \mathcal{C} \otimes \mathbb{K} \\
 & \searrow \simeq & \mathcal{C} & \swarrow \simeq & \\
 & & \mathbb{K} & & 
 \end{array} \tag{4.5}$$

commute. If, in addition, one has that

◇ Cocommutativity:

$$\begin{array}{ccc}
 \mathcal{C} \otimes \mathcal{C} & \xrightarrow{\tau} & \mathcal{C} \otimes \mathcal{C} \\
 & \swarrow \Delta & \uparrow \Delta \\
 & & \mathcal{C}
 \end{array} \tag{4.6}$$

commutes, the coalgebra is said to be *cocommutative*.

For an algebra  $\mathcal{A}$ , there is also the notion of an opposite algebra  $\mathcal{A}^{\text{op}}$ , which is an algebra with the same underlying vector space, but with the opposite product  $\mu^{\text{op}} = \mu \circ \tau$ . The commutativity axiom (4.3) therefore means simply, that  $\mu^{\text{op}} = \mu$ . Analogously one has an opposite coalgebra  $\mathcal{C}^{\text{cop}}$  which is defined as  $\mathcal{C}$  but with the opposite coproduct  $\Delta^{\text{op}} = \tau \circ \Delta$ . Axiom (4.6) then reads  $\Delta^{\text{op}} = \Delta$ .

## SWEEDLER'S AND OTHER USEFUL NOTATIONS

There is a nice notation for the coproduct of an element  $a \in \mathcal{C}$  due to Sweedler. One writes  $\Delta(a) = \sum_i a_{i(1)} \otimes a_{i(2)}$ , where the sum is normally omitted for shortness, i.e.  $\Delta(a) = a_{(1)} \otimes a_{(2)}$ . For example, coassociativity (4.4) looks like  $(a_{(1)(1)} \otimes a_{(1)(2)}) \otimes a_{(2)} = a_{(1)} \otimes (a_{(2)(1)} \otimes a_{(2)(2)})$ ,

which is then written as  $a_{(1)} \otimes a_{(2)} \otimes a_{(3)}$ . In general, if one looks at higher coproducts, i.e.  $\Delta^n : \mathcal{C} \rightarrow \mathcal{C}^{\otimes(n+1)}$ , coassociativity guarantees that

$$\Delta^n = (\Delta \otimes \text{id}^{\otimes(n-1)}) \circ \Delta^{n-1} = (\text{id}^{\otimes(n-1)} \otimes \Delta) \circ \Delta^{n-1} \tag{4.7}$$

such that in Sweedler’s notation, it is simply  $\Delta^n(a) = a_{(1)} \otimes \dots \otimes a_{(n+1)}$ . To get used to the notation, notice the definition of higher coproducts, for example  $\Delta^2 = (\text{id} \otimes \Delta) \circ \Delta = (\Delta \otimes \text{id}) \circ \Delta$  or  $\Delta^3 = (\text{id} \otimes \text{id} \otimes \Delta) \circ (\text{id} \otimes \Delta) \circ \Delta = \dots = (\Delta \otimes \text{id} \otimes \text{id}) \circ (\Delta \otimes \text{id}) \circ \Delta$  (the dots stand for all other four permutations of  $\text{id}$  and  $\Delta$  in the brackets).

Sometimes one has to embed an element  $\phi = \phi_1 \otimes \phi_2 \otimes \phi_3 \in \mathcal{A}^{\otimes 3}$  into  $\mathcal{A}^{\otimes n}$  by the repeated insertion of  $1_{\mathcal{A}}$  and possibly reshuffling the components  $\phi_i$ . For example

$$\phi_{ijk} := 1_{\mathcal{A}} \otimes \dots \otimes \phi_1 \otimes 1_{\mathcal{A}} \otimes \dots \otimes \phi_3 \otimes \dots \otimes \phi_2 \otimes \dots \otimes 1_{\mathcal{A}} \in \mathcal{A}^{\otimes n} \tag{4.8}$$

is an element, where  $\phi_1$  is in the  $i^{\text{th}}$  position,  $\phi_2$  in the  $j^{\text{th}}$ ,  $\phi_3$  in the  $k^{\text{th}}$  and the rest is  $1_{\mathcal{A}}$ . Consequently, one does not know a priori if an element  $\phi_{234}$  is in  $\mathcal{A}^{\otimes 4}$  or perhaps in  $\mathcal{A}^{\otimes 7}$ , but this is always clear from the context. Here,  $\phi \in \mathcal{A}^{\otimes 3}$  is just an example, and the same notation is of course used for general elements  $\mathcal{A}^{\otimes k}$  which are embedded into  $\mathcal{A}^{\otimes n}$  for  $k \leq n$ .

### § 4.2 BIALGEBRAS AND HOPF ALGEBRAS

A bialgebra is a quintuple  $(\mathcal{H}, \mu, \Delta, \eta, \epsilon)$  which is equipped with an algebra and a coalgebra structure at the same time in a compatible way. The compatibility is, that  $\eta$  and  $\mu$  are morphisms of coalgebras and  $\Delta$  and  $\epsilon$  are morphisms of algebras, respectively. In fact, both statements are equivalent. In other words,  $\Delta$  and  $\epsilon$  have to intertwine with  $\mu$  and  $\eta$ , i.e.  $\Delta \circ \mu = (\mu \otimes \mu) \circ (\text{id} \otimes \tau \otimes \text{id}) \circ (\Delta \otimes \Delta)$  and  $\Delta(1_{\mathcal{H}}) = 1_{\mathcal{H}} \otimes 1_{\mathcal{H}}$ , as well as  $\epsilon \circ \mu \simeq \epsilon \otimes \epsilon$  and  $\epsilon(1_{\mathcal{H}}) = 1_{\mathbb{K}}$ .

A Hopf algebra is a bialgebra with an additional piece of information, that is, an endomorphism  $S : \mathcal{H} \rightarrow \mathcal{H}$ , called an *antipode*. It has to satisfy  $\mu \circ (S \otimes \text{id}) \circ \Delta = \mu \circ (\text{id} \otimes S) \circ \Delta = \eta \circ \epsilon$ , or diagrammatically, that

◊ Antipode:

$$\begin{array}{ccc} \mathcal{H} \otimes \mathcal{H} & \xrightarrow{(S \otimes \text{id}) \text{ or } (\text{id} \otimes S)} & \mathcal{H} \otimes \mathcal{H} \\ \Delta \uparrow & & \downarrow \mu \\ \mathcal{H} & \xrightarrow{\eta \circ \epsilon} & \mathcal{H} \end{array} \tag{4.9}$$

commutes. It is unique and plays more or less the rôle of an inverse, since (4.9) is nothing but  $S(a_{(1)})a_{(2)} = a_{(1)}S(a_{(2)}) = \epsilon(a)1_{\mathcal{H}}$ . So the full set of data giving a Hopf algebra is the sextuple  $(\mathcal{H}, \mu, \Delta, \eta, \epsilon, S)$ . Note, that the antipode does not have to be invertible.

### A GROUP ALGEBRA

One of the easiest examples is the group algebra  $\mathcal{A} = \mathbb{K}G$ , which is a free  $\mathbb{K}$ -module with a finite group  $G$  as a basis. The unit in  $G$  is denoted by  $1_G$  and  $\mathbb{K}G$  can be written as the set  $\{a = \sum_{g \in G} a(g)g\}$ . The algebra structure is evidently given by linearly extending the product in  $G$  and  $\eta(1_{\mathbb{K}}) = 1_{\mathcal{A}} = 1_G$ , whereas the coalgebra structure is  $\Delta(g) = g \otimes g$  and  $\epsilon(g) = 1_{\mathbb{K}}$ . The antipode can be set to  $S(g) = g^{-1}$ , which would not have worked, if  $G$  were just a monoid. Notice that  $\mathbb{K}G$  is always cocommutative, but only commutative if  $G$  is abelian. It is clear that the product is associative, because the product in  $G$  is associative, and also that  $\Delta$  is coassociative. The bialgebra structure is given, because  $\Delta$  and  $\epsilon$  are algebra morphisms, i.e.  $\Delta(gh) = gh \otimes gh = (g \otimes g)(h \otimes h) = \Delta(g)\Delta(h)$  and  $\epsilon(gh) = 1_{\mathbb{K}} = \epsilon(g)\epsilon(h)$ . One can also check that for the antipode  $S$  one has the required condition  $\mu \circ (S \otimes \text{id}) \circ \Delta(g) = S(g)g = 1_G = \eta \circ \epsilon(g)$  and trivially  $(\epsilon \otimes \text{id}) \circ \Delta(g) = 1_{\mathbb{K}} \otimes g \simeq g$ .

### THE ALGEBRA OF FUNCTIONS ON A FINITE GROUP

Let  $G$  be a finite group as in the previous example. Denote by  $\mathbb{K}(G)$  the algebra of functions on  $G$  with values in  $\mathbb{K}$ . It is a commutative Hopf algebra. The  $\mathbb{K}$ -module structure is simply  $(k\phi)(g) = k\phi(g)$  for  $k \in \mathbb{K}$ ,  $\phi \in \mathbb{K}(G)$  and  $g \in G$  and the addition is point-wise. The algebra product is given by  $(\phi\psi)(g) = \phi(g)\psi(g)$  with unit  $\eta(k)(g) = k$ , the coproduct, counit and antipode are  $(\Delta\phi)(u, v) = \phi(uv)$ ,  $\epsilon(\phi) = \phi(1_G)$  and  $(S(\phi))(g) = \phi(g^{-1})$ . Note that the coproduct is defined by identifying  $\mathbb{K}(G) \otimes \mathbb{K}(G) \simeq \mathbb{K}(G \times G)$ . Coassociativity follows directly from the associativity in the group:  $((\Delta \otimes \text{id}) \circ \Delta\phi)(g, h, j) = (\Delta\phi)(gh, j) = \phi((gh)j) = \phi(g(hj)) = (\Delta\phi)(g, hj) = ((\text{id} \otimes \Delta) \circ \Delta\phi)(g, h, j)$ . Also  $((\epsilon \otimes \text{id}) \circ \Delta\phi)(g) = (\Delta\phi)(1_G, g) = \phi(1_G g)$  and  $((S\phi_{(1)})\phi_{(2)})(g) = (S\phi_{(1)})(g)\phi_{(2)}(g) = \phi_{(1)}(g^{-1})\phi_{(2)}(g) = \phi(g^{-1}g) = \phi(1_G) = \epsilon(\phi)$ . The two algebras  $\mathbb{K}(G)$  and  $\mathbb{K}G$  are the dual of each other.

### § 4.3 BRAIDED BIALGEBRAS

Now that the basic definitions have been given, one can relax some relations, i.e. for example cocommutativity and coassociativity. This will lead to the concept of *braided* bialgebras and *quasi* bialgebras, respectively. Let's start with a braided bialgebra.

Given a bialgebra  $(\mathcal{H}, \mu, \Delta, \eta, \epsilon)$ , it is called *quasi-cocommutative*, if there is an invertible element  $\mathcal{R} \in \mathcal{H} \otimes \mathcal{H}$ , called *universal  $\mathcal{R}$ -matrix*, such that for all  $a \in \mathcal{H}$  one has

◇ Quasi-Cocommutativity:

$$\Delta^{\text{op}}(a) = \mathcal{R} \Delta(a) \mathcal{R}^{-1} \quad \forall a \in \mathcal{H}. \quad (4.10)$$

Furthermore, the bialgebra is called *braided*, if  $\mathcal{R}$  satisfies the relations

◇ Braid relations:

$$\begin{aligned} i) \quad & (\text{id} \otimes \Delta)\mathcal{R} = \mathcal{R}_{13}\mathcal{R}_{12} \\ ii) \quad & (\Delta \otimes \text{id})\mathcal{R} = \mathcal{R}_{13}\mathcal{R}_{23} \end{aligned} \quad (4.11)$$

using the notation introduced in (4.8). A Hopf algebra is braided, if the underlying bialgebra is and the universal  $\mathcal{R}$ -matrix becomes part of the definition, hence  $(\mathcal{H}, \mu, \Delta, \eta, \epsilon, S, \mathcal{R})$ . For braided bialgebras, the  $\mathcal{R}$ -matrix is also often called *quasi-triangular structure*, which is due to Drinfel'd.

### THE BRAID GROUP AND THE QUANTUM-YANG-BAXTER-EQUATION

A very important consequence of (4.10) and (4.11) is the so called (*Quantum-)*Yang-Baxter-Equation, which follows directly by calculating

$$(\text{id} \otimes \Delta^{\text{op}})\mathcal{R} = (\text{id} \otimes \tau)(\text{id} \otimes \Delta)\mathcal{R} = \mathcal{R}_{23}[(\text{id} \otimes \Delta)\mathcal{R}]\mathcal{R}_{23}^{-1}, \quad (4.12)$$

or

$$(\Delta^{\text{op}} \otimes \text{id})\mathcal{R} = (\tau \otimes \text{id})(\Delta \otimes \text{id})\mathcal{R} = \mathcal{R}_{12}[(\Delta \otimes \text{id})\mathcal{R}]\mathcal{R}_{12}^{-1}. \quad (4.13)$$

One finds

◇ Quantum-Yang-Baxter-Equation (QYBE):

$$\mathcal{R}_{12}\mathcal{R}_{13}\mathcal{R}_{23} = \mathcal{R}_{23}\mathcal{R}_{13}\mathcal{R}_{12}, \quad (4.14)$$

which is in fact closely related to the braid group  $\mathcal{B}_n$ . The braid group  $\mathcal{B}_n$  is literally the collection of all braids with  $n$  strands one can imagine. Therefore, it is infinite. It is generated by the two elementary braids

$$\sigma_i = \begin{array}{c} i \quad i+1 \\ \diagdown \quad \diagup \\ \diagup \quad \diagdown \end{array}, \quad \sigma_i^{-1} = \begin{array}{c} i \quad i+1 \\ \diagup \quad \diagdown \\ \diagdown \quad \diagup \end{array},$$

involving only the  $i^{\text{th}}$  and  $(i+1)^{\text{th}}$  strand while leaving all others straight. There are essentially three conditions, that have to be fulfilled and which define properly the features of  $\mathcal{B}_n$ , the so called *Artin-* or *Braid-relations*:

◇ Artin Relations:

$$\begin{array}{ll} i) & \sigma_i \sigma_k = \sigma_k \sigma_i, \quad \text{if } |k - i| > 1 \\ ii) & \sigma_i \sigma_{i+1} \sigma_i = \sigma_{i+1} \sigma_i \sigma_{i+1} \\ iii) & \sigma_i \sigma_i^{-1} = \iota = \sigma_i^{-1} \sigma_i \end{array} \quad (4.15)$$

(where the unit of the braid group is written as  $\iota$ ).

These relations are completely obvious, since one can really think with ropes or draw fancy pictures. For example, the second Artin relation has a very natural origin, because depicted it looks like

$$\begin{array}{c} i \quad i+1 \quad i+2 \\ \diagdown \quad \diagup \quad | \\ \diagup \quad \diagdown \quad | \\ | \quad \diagdown \quad \diagup \\ | \quad \diagup \quad \diagdown \end{array} = \begin{array}{c} i \quad i+1 \quad i+2 \\ | \quad \diagdown \quad \diagup \\ | \quad \diagup \quad \diagdown \\ \diagdown \quad \diagup \quad | \\ \diagup \quad \diagdown \quad | \end{array}$$

and is clear if one tries to retangle a bit the strands. (In fact it's a *Reidemeister Move* of the third kind with the second strand.)

To understand the relation between the braid group and the  $\mathcal{R}$ -Matrix of a braided Hopf algebra  $\mathcal{H}$ , one has to look from the viewpoint of the tensor category  ${}_{\mathcal{H}}\mathcal{M}$  of modules, which can eventually be braided as well. Since I have not yet said what a tensor category is, I postpone it to one of the next sections, but it can already be said that the  $\mathcal{R}$ -matrix will be used to "construct" the braiding of the tensor category or, in other words, it gives a representation of the braid group for free.

#### § 4.4 QUASI BIALGEBRAS AND BRAIDED QUASI BIALGEBRAS

Weakening cocommutativity (4.6) to quasi-cocommutativity (4.10) lead to braided bialgebras. Following the same lines one can also relax coassociativity (4.4) to *quasi-coassociativity*, which will have *quasi-bialgebras* as a consequence. Both concepts can be mixed, and from that a *braided quasi bialgebra* or *quasi-triangular quasi bialgebra* will emerge, which will be the basic object of concern.

#### QUASI BIALGEBRAS AND QUASI HOPF ALGEBRAS

In order to define a quasi bialgebra one has to introduce additional structures. The definition goes as follows: Starting out from an algebra  $\mathcal{H}$  with a counit  $\epsilon$  and a coproduct  $\Delta$  as before, one requires the existence of an invertible element  $\Omega \in \mathcal{H} \otimes \mathcal{H} \otimes \mathcal{H}$ , called the *Drinfel'd associator* and two invertible elements  $r, l \in \mathcal{H}$  such that one has

◇ Quasi-Coassociativity:

$$(\text{id} \otimes \Delta) \circ \Delta(a) = \Omega [(\Delta \otimes \text{id}) \circ \Delta(a)] \Omega^{-1} \quad \forall a \in \mathcal{H} \quad (4.16)$$

◇ Counit Constraints:

$$\begin{aligned} i) \quad & (\epsilon \otimes \text{id}) \circ \Delta(a) = l^{-1} a l \\ ii) \quad & (\text{id} \otimes \epsilon) \circ \Delta(a) = r^{-1} a r \end{aligned} \quad (4.17)$$

◇ Drinfel'd Associator Relations:

$$\begin{aligned} i) \quad & (\text{id} \otimes \text{id} \otimes \Delta)(\Omega)(\Delta \otimes \text{id} \otimes \text{id})(\Omega) = \Omega_{234} [(\text{id} \otimes \Delta \otimes \text{id})(\Omega)] \Omega_{123} \\ ii) \quad & (\text{id} \otimes \epsilon \otimes \text{id})(\Omega) = r \otimes l^{-1} \end{aligned} \quad (4.18)$$

In the case  $l = r = 1_{\mathcal{H}}$ , the counit constraints (4.17) are nothing but the diagram (4.5), and therefore required for a bialgebra anyway.

Notice, that as  $\mathcal{R}$  can be used to define a braiding in the category of  $\mathcal{H}$ -modules, the Drinfel'd associator  $\Omega$  appearing in the coassociativity of the algebra can play a similar role, namely defining a non trivial associativity constraint in  ${}_{\mathcal{H}}\mathcal{M}$ . We will see this later on.

A quasi Hopf algebra is a quasi bialgebra (with an antipode) where the relation for the antipode (4.9) is modified by the requirement of the existence of two elements  $\alpha, \beta \in \mathcal{H}$  such that

◇ Antipode and Counit:

$$\begin{aligned} i) \quad & S(a_{(1)})\alpha a_{(2)} = \epsilon(a)\alpha \\ ii) \quad & a_{(1)}\beta S(a_{(2)}) = \epsilon(a)\beta \end{aligned} \quad \forall a \in \mathcal{H} \quad (4.19)$$

◇ Antipode and Drinfel'd Associator:

$$\sum \varphi_1 \beta S(\varphi_2) \alpha \varphi_3 = \sum S(\bar{\varphi}_1) \alpha \bar{\varphi}_2 \beta S(\bar{\varphi}_3) = 1_{\mathcal{H}} \quad (4.20)$$

(with the notation  $\Omega = \sum \varphi_1 \otimes \varphi_2 \otimes \varphi_3$  and  $\Omega^{-1} = \sum \bar{\varphi}_1 \otimes \bar{\varphi}_2 \otimes \bar{\varphi}_3$ ).

### BRAIDED QUASI BI- AND HOPF ALGEBRAS

As mentioned, a quasi bialgebra can also be braided. The definition will involve the braid relations (4.11) and the Yang-Baxter-Equation (4.14). Whereas the quasi-cocommutativity (4.10) stays untouched, i.e.  $\Delta^{\text{op}}(a) = \mathcal{R}\Delta(a)\mathcal{R}^{-1}$ , the other ones will mix a bit with the Drinfel'd associator  $\Omega$  in the following way:

◇ Quasi Braid relations:

$$\begin{aligned} i) \quad & (\text{id} \otimes \Delta)\mathcal{R} = \Omega_{231}^{-1}\mathcal{R}_{13}\Omega_{213}\mathcal{R}_{12}\Omega_{123}^{-1} \\ ii) \quad & (\Delta \otimes \text{id})\mathcal{R} = \Omega_{312}\mathcal{R}_{13}\Omega_{132}^{-1}\mathcal{R}_{23}\Omega_{123} \end{aligned} \quad (4.21)$$

◇ Quasi-(Quantum-)Yang-Baxter-Equation:

$$\mathcal{R}_{12}\Omega_{312}\mathcal{R}_{13}\Omega_{132}^{-1}\mathcal{R}_{23}\Omega = \Omega_{321}\mathcal{R}_{23}\Omega_{231}^{-1}\mathcal{R}_{13}\Omega_{213}\mathcal{R}_{12} \quad (4.22)$$

The QYBE is now called *Quasi-(Quantum-)Yang-Baxter-Equation* (QQYBE) and arises again naturally from the second Artin relation in (4.15), but this time with a non-trivial associativity constraint of the tensor category, where  $\mathcal{R}$  represents the braid group.

Finally, a quasi Hopf algebra is quasi-triangular, if the underlying quasi bialgebra is.

### DRINFEL'D TWIST

Generally, a Drinfel'd twist is an equivalence relation on quasi Hopf algebras such that the category of modules of two equivalent quasi Hopf algebras are tensor equivalent. In the literature, it is also called a *gauge transformation* of the Hopf algebra. The twist is constructed with the aid of an invertible element  $\mathcal{F} \in \mathcal{H} \otimes \mathcal{H}$  such that  $(\epsilon \otimes \text{id})\mathcal{F} = (\text{id} \otimes \epsilon)\mathcal{F} = 1$ . One can then define a new quasi Hopf algebra, whose quasi bialgebra structure is given by the twisted coproduct as well as a new Drinfel'd associator:

$$\begin{cases} \Delta_{\mathcal{F}} : \mathcal{H} \rightarrow \mathcal{H} \otimes \mathcal{H}, & \mathcal{H} \ni a \mapsto \Delta_{\mathcal{F}}(a) = \mathcal{F}\Delta(a)\mathcal{F}^{-1} \\ \Omega_{\mathcal{F}} = \mathcal{F}_{23}(\text{id} \otimes \Delta)[\mathcal{F}]\Omega(\Delta \otimes \text{id})[\mathcal{F}^{-1}]\mathcal{F}_{12}^{-1} \end{cases}, \quad (4.23)$$

whereas the counit stays the same. It is then the triple  $(\epsilon, \Delta_{\mathcal{F}}, \Omega_{\mathcal{F}})$  which defines the gauge transformed quasi bialgebra structure on  $\mathcal{H}$ , now denoted by  $\mathcal{H}_{\mathcal{F}}$ .

Recall that a quasi Hopf structure comes with elements  $\alpha, \beta \in \mathcal{H}$  as a modification of the standard antipode relations. If  $\alpha$  and  $\beta$  are the corresponding elements in  $\mathcal{H}$ , then a Drinfel'd twist carries them over to  $\mathcal{H}_{\mathcal{F}}$ . With the notation  $\mathcal{F} = \sum f_1 \otimes f_2$  and  $\mathcal{F}^{-1} = \sum \bar{f}_1 \otimes \bar{f}_2$ , define new versions  $\alpha_{\mathcal{F}}$  and  $\beta_{\mathcal{F}}$  by

$$\begin{cases} \alpha_{\mathcal{F}} = \sum S(\bar{f}_1) \alpha \bar{f}_2 \\ \beta_{\mathcal{F}} = \sum f_1 \beta S(f_2) \end{cases} . \quad (4.24)$$

The quasi Hopf structure of the new collection  $\mathcal{H}_{\mathcal{F}}, \epsilon, \Delta_{\mathcal{F}}, \Omega_{\mathcal{F}}, \alpha_{\mathcal{F}}$  and  $\beta_{\mathcal{F}}$  is then complete.

If  $\mathcal{H}$  additionally comes with a braiding  $\mathcal{R}$ , then  $\mathcal{H}_{\mathcal{F}}$  is also equipped with a quasi-triangular structure,

$$\mathcal{R}_{\mathcal{F}} = \mathcal{F}_{21} \mathcal{R} \mathcal{F}_{12}^{-1} \quad (4.25)$$

fulfilling all necessary relations of the  $\mathcal{R}$ -matrix and braid relations using the transformed versions  $\Delta_{\mathcal{F}}$  and  $\Omega_{\mathcal{F}}$ .

#### § 4.5 THE DRINFEL'D QUANTUM DOUBLE

The Drinfel'd Quantum Double is a quasi-triangular Hopf algebra arising from a single Hopf algebra by building a special bicrossed product. The bicrossed product is similar to the semi-direct product of groups, but is a generalization. The bicrossed product for bialgebras is technically a bit challenging, therefore let us have a look at groups first.

One has to start with the definition of a *matched pair* of groups: Two groups  $(G, H)$  are called matched, if there is a left-action of  $H$  on  $G$  as well as a right-action of  $G$  on  $H$ . Denoting the left-action of an element  $h$  on  $g$  as  $h \triangleright g$  (respectively  $h \triangleleft g$  for a right-action), they have to fulfill

$$\begin{aligned} (hh') \triangleleft g &= (h \triangleleft (h' \triangleright g))(h' \triangleleft g) \\ h \triangleright (gg') &= (h \triangleright g)((h \triangleleft g) \triangleright g') \\ h \triangleright 1_G &= 1_G \quad , \quad 1_H \triangleleft g = 1_H. \end{aligned} \quad (4.26)$$

Note that one has of course  $h \triangleleft (gg') = (h \triangleleft g) \triangleleft g'$ ,  $h \triangleleft 1_G = h$  and  $(hh') \triangleright g = h \triangleright (h' \triangleright g)$ ,  $1_H \triangleright g = g$ , i.e. really an action. Once having a matched pair, one can define a group structure on  $G \times H$ , which is called *bicrossed product* of  $G$  and  $H$  and is denoted by  $G \bowtie H$ . The product in  $G \bowtie H$  is defined to be  $(g, h)(g', h') = (g(h \triangleright g'), (h \triangleleft g')h')$  and the inverse is  $(g, h)^{-1} = (h^{-1} \triangleright g^{-1}, (h \triangleleft (h^{-1} \triangleright g^{-1}))^{-1})$ .

Two bialgebras  $(\mathcal{A}, \mathcal{B})$  can also be matched. Namely if  $\mathcal{A}$  is a left  $\mathcal{B}$ -module coalgebra and  $\mathcal{B}$  is a right  $\mathcal{A}$ -module coalgebra, such that

$$\begin{aligned} b \triangleright (aa') &= (b_{(1)} \triangleright a_{(1)})((b_{(2)} \triangleleft a_{(2)}) \triangleright a') \\ (bb') \triangleleft a &= (b \triangleleft (b'_{(1)} \triangleright a_{(1)}))(b'_{(2)} \triangleleft a_{(2)}) \\ b \triangleright 1_{\mathcal{A}} &= \epsilon(b)1_{\mathcal{A}} \quad , \quad 1_{\mathcal{B}} \triangleleft a = \epsilon(a)1_{\mathcal{B}} \\ (b_{(1)} \triangleleft a_{(1)}) \otimes (b_{(2)} \triangleright a_{(2)}) &= (b_{(2)} \triangleleft a_{(2)}) \otimes (b_{(1)} \triangleright a_{(1)}). \end{aligned} \quad (4.27)$$

Recall that an algebra  $\mathcal{A}$  is a  $\mathcal{B}$ -module coalgebra, if the  $\mathcal{B}$ -module structure is compatible with the coalgebra-structure of  $\mathcal{A}$ , or in simple words, the action of  $\mathcal{B}$  as a map  $\triangleright : \mathcal{B} \otimes \mathcal{A} \rightarrow \mathcal{A}$  is a coalgebra morphism, i.e

$$\Delta(b \triangleright a) = (b_{(1)} \triangleright a_{(1)}) \otimes (b_{(2)} \triangleright a_{(2)}) \quad (4.28)$$

together with  $\epsilon(b \triangleright a) = \epsilon(b)\epsilon(a)$ . Like for the groups, one can now define a bialgebra structure on the vector space  $\mathcal{A} \otimes \mathcal{B}$ , the bicrossed product of bialgebras  $\mathcal{A} \bowtie \mathcal{B}$ . The product in  $\mathcal{A} \bowtie \mathcal{B}$  is

$$(a \otimes b)(a' \otimes b') = a(b_{(1)} \triangleright a'_{(1)}) \otimes (b_{(2)} \triangleleft a'_{(2)})b', \quad (4.29)$$

the coproduct is the standard tensor coproduct given by  $\Delta(a \otimes b) = (a_{(1)} \otimes b_{(1)}) \otimes (a_{(2)} \otimes b_{(2)})$  and the counit is  $\epsilon(a \otimes b) = \epsilon(a)\epsilon(b)$ . If, furthermore,  $\mathcal{A}$  and  $\mathcal{B}$  are Hopf algebras with antipodes  $S_{\mathcal{A}}$  and  $S_{\mathcal{B}}$ , then  $\mathcal{A} \bowtie \mathcal{B}$  is a Hopf algebra with the antipode

$$S(a \otimes b) = S_{\mathcal{B}}(b_{(2)}) \triangleright S_{\mathcal{A}}(a_{(2)}) \otimes S_{\mathcal{B}}(b_{(1)}) \triangleleft S_{\mathcal{A}}(a_{(1)}). \quad (4.30)$$

The crucial observation is, that if a Hopf algebra  $\mathcal{H}$  has an invertible antipode  $S$ , then there is a natural left action of  $\mathcal{H}$  on  $(\mathcal{H}^{\text{op}})^*$ , the so called co-adjoint representation. Likewise one can show that this induces a right action of  $(\mathcal{H}^{\text{op}})^*$  on  $\mathcal{H}$ . Therefore,  $\mathcal{H}$  comes naturally equipped with a right  $(\mathcal{H}^{\text{op}})^*$ -module-coalgebra structure, whereas  $(\mathcal{H}^{\text{op}})^*$  is a left  $\mathcal{H}$ -module-coalgebra. Without going into further details, the actions can be given, for  $a, b \in \mathcal{H}$ ,  $f \in \mathcal{H}^*$ ,

$$\begin{aligned} (a \triangleright f)(b) &= f(S^{-1}(a_{(2)}) b a_{(1)}), \\ (a \triangleleft f) &= f(S^{-1}(a_{(3)}) a_{(1)}) a_{(2)}, \end{aligned} \quad (4.31)$$

such that the pair  $((\mathcal{H}^{\text{op}})^*, \mathcal{H})$  is matched. Having a matched pair, one can construct the bicrossed product

$$\mathcal{D}(\mathcal{H}) := (\mathcal{H}^{\text{op}})^* \bowtie \mathcal{H}, \quad (4.32)$$

which is called the *Drinfel'd quantum double of  $\mathcal{H}$* . As a vector space it is clearly  $(\mathcal{H}^{\text{op}})^* \otimes \mathcal{H}$  and the two Hopf algebras are embedded as Hopf subalgebras

$$(\mathcal{H}^{\text{op}})^* \hookrightarrow \mathcal{D}(\mathcal{H}) \hookrightarrow \mathcal{H} \quad (4.33)$$

via the natural identifications  $a \mapsto 1 \otimes a$ , respectively  $f \mapsto f \otimes 1$ . The product in  $\mathcal{D}(\mathcal{H})$  follows directly by the one of the bicrossed product (4.29) given by

$$(f \otimes a)(g \otimes b) = fg(S^{-1}(a_{(3)})(\cdot)a_{(1)}) \otimes a_{(2)}b, \quad (4.34)$$

where  $(\cdot)$  is just a wildcard character for an element  $\in \mathcal{H}$ .

The theory of quantum doubles is a vast topic, and is not the aim of this thesis\*. Nevertheless, there is a last feature of  $\mathcal{D}(\mathcal{H})$  which should be mentioned. Namely, that it is braided. Suppose the basis of  $\mathcal{H}$  is denoted by  $e_i$  and the one of it's dual  $e^i$ . One can than choose an element

$$\mathcal{R} \in \mathcal{D}(\mathcal{H}) \otimes \mathcal{D}(\mathcal{H}) = \sum (e^i \otimes 1) \otimes (1 \otimes e_i) \quad (4.35)$$

and will find that it is a quasi-triangular structure fulfilling all necessary conditions to build a braided bialgebra.

---

\*By all means it is not the mathematical point of view we are so interested in.

### QUANTUM DOUBLE OF THE GROUP ALGEBRA

The construction of the previous section is the most general one. As an example, consider the quantum double of the group algebra of a finite group  $G$ , i.e.  $\mathcal{D}(\mathbb{K}G) = \mathbb{K}(G) \bowtie \mathbb{K}G$ . Recall that these two Hopf algebras are strictly dual to each other and  $\mathbb{K}G$  is always cocommutative. As a result, the right action of  $\mathbb{K}(G)$  on  $\mathbb{K}G$  is the trivial one, namely  $a \triangleleft f = \epsilon(f)a$  for  $a \in \mathbb{K}G$ ,  $f \in \mathbb{K}(G)$ , whereas  $\mathbb{K}G$  still acts on  $\mathbb{K}(G)$  by the coadjoint representation (the first equation in (4.31)). The next step is to choose a basis of the algebra of functions  $\mathbb{K}(G)$ . Take the Kronecker- $\delta$ -functions (with a group index), taking one argument, such that  $\delta_g(h) = 1$ , if  $g = h$  and zero otherwise. A function  $f \in \mathbb{K}(G)$  can then be written as  $f = \sum_{g \in G} f(g)\delta_g$  and in that basis, the algebra structure becomes  $(\delta_g \delta_h)(\cdot) = \delta_g(h)\delta_g(\cdot)$  with unit  $\sum_g \delta_g$ . The coalgebra structure takes the form  $\Delta(\delta_k) = \sum_{gh=k} \delta_g \otimes \delta_h$  with counit  $\epsilon(\delta_g) = \delta_g(1_G)$ . The antipode is  $S(\delta_g) = \delta_{g^{-1}}$ . We have thus a basis of  $\mathcal{D}(\mathbb{K}G)$ ,

$$\{\delta_w \otimes g\}_{(w,g) \in G \times G}, \quad (4.36)$$

and we can write down the coalgebra structure in  $\mathcal{D}(\mathbb{K}G)$ , which is

$$\Delta(\delta_w \otimes g) = \sum_{uv=w} (\delta_u \otimes g) \otimes (\delta_v \otimes g), \quad (4.37)$$

where the counit takes the form

$$\epsilon(\delta_w \otimes g) = \delta_w(1_G)1_{\mathbb{K}}. \quad (4.38)$$

The left coadjoint action of a group element  $g$  on a dual basis element  $\delta_w$  translates into  $g \triangleright \delta_w = \delta_{gwg^{-1}}$ , i.e. the right adjoint action of  $G$  on itself. So one can write the algebra structure using (4.34)

$$(\delta_w \otimes g)(\delta_v \otimes h) = \delta_w(g \triangleright \delta_v) \otimes gh = \delta_w(gvg^{-1}) (\delta_w \otimes gh), \quad (4.39)$$

which is even simpler if  $G$  is abelian, since the adjoint action becomes trivial as well. Finally, one can immediately write down the  $\mathcal{R}$ -Matrix which is given by (4.35) and therefore,

$$\mathcal{R} = \sum_v (\delta_v \otimes 1_G) \otimes \left( \sum_w \delta_w \otimes v \right), \quad (4.40)$$

as well as the antipode using equation (4.30):

$$S(\delta_w \otimes g) = (g^{-1} \triangleright \delta_{w^{-1}}) \otimes g^{-1} = (\delta_{g^{-1}w^{-1}g} \otimes g^{-1}). \quad (4.41)$$

In this example the trivial right action of the dual back on the algebra rather simplifies things. This always happens, if the algebra (in our case the group algebra) is cocommutative. Then,  $(\mathcal{H}^{\text{op}})^*$  is not only a  $\mathcal{H}$ -module-coalgebra, but a  $\mathcal{H}$ -module-algebra. This is the definition of a *crossed product*, often denoted by  $\mathcal{A} \rtimes \mathcal{B}$ . Indeed, for the group algebra,

$$\mathcal{D}(\mathbb{K}G) = \mathbb{K}(G) \rtimes \mathbb{K}G, \quad (4.42)$$

because  $\mathbb{K}G$  is always cocommutative.

**TWISTED QUANTUM DOUBLE**

The quantum double  $\mathcal{D}(\mathbb{K}G)$  from the last subsection is a braided Hopf algebra. There is a method to modify (twist) this algebra into a quasi Hopf algebra due to a  $U(1)$ -valued group 3-cocycle  $\omega_{g,h,k}$ , which, as a cocycle fulfills

$$\omega_{h,k,l} \omega_{gh,k,l}^{-1} \omega_{g,hk,l} \omega_{g,h,kl}^{-1} \omega_{g,h,k} = 1, \quad (4.43)$$

and was already met in (3.40). However, for the moment we do not have to know anything about how it arose in chapter 3. However, to continue with this nice correspondence, let us rename the basis elements from equation (4.36), i.e.

$$T_g^w := \{\delta_w \otimes g\}_{(w,g) \in G \times G}. \quad (4.44)$$

With the aid of the 3-cocycle  $\omega$ , eq. (4.43), one defines elements

$$\mathcal{P}_w^{g,h} = \frac{\omega_{w,g,h} \omega_{g,h,w^{gh}}}{\omega_{g,w^g,h}} \quad (4.45)$$

and

$$\mathcal{Q}_{v,w}^g = \frac{\omega_{v,w,g} \omega_{g,v^g,w^g}}{\omega_{v,g,w^g}}, \quad (4.46)$$

with the notation  $g^h = h^{-1}gh, \forall g, h \in G$ .

There is then a *twisted* version of the Drinfel'd quantum double, which will be denoted by  $\mathcal{D}^\omega(\mathbb{K}G)$  and with  $\omega$  called the twist. The algebra  $\mathcal{D}^\omega(\mathbb{K}G)$  is not only a quasi-triangular (braided) Hopf algebra, but a quasi-triangular quasi Hopf algebra. To define it,  $\mathcal{P}_w^{g,h}$  modifies the product law, and  $\mathcal{Q}_{v,w}^g$  appears in the coproduct, if one would like to compare it to the untwisted  $\mathcal{D}(\mathbb{K}G)$  from the last section. The algebra structure is then

$$T_g^w T_h^v = \delta_{v,w^g} \mathcal{P}_w^{g,h} T_{gh}^w, \quad 1_{\mathcal{D}^\omega} = \sum_w T_{1_G}^w, \quad (4.47)$$

(to be compared to (4.39)), and the coalgebra structure (counit  $\epsilon$  and coproduct  $\Delta$ ) by

$$\Delta(T_g^w) = \sum_{uv=w} \mathcal{Q}_{u,v}^g T_g^u \otimes T_g^v, \quad \epsilon(T_g^w) = \delta(w, 1_G) 1_{\mathbb{K}}. \quad (4.48)$$

(to be compared to (4.37)). Apart from the additional phases  $\mathcal{P}$  and  $\mathcal{Q}$ , it is exactly the same. (Note that  $\delta_w(gvg^{-1}) = \delta_{v,w^g}$ ). As a quasi Hopf algebra, there is a Drinfel'd associator

$$\Omega = \sum_{u,v,w} \omega_{u,v,w}^{-1} T_{1_G}^u \otimes T_{1_G}^v \otimes T_{1_G}^w, \quad (4.49)$$

and the two elements  $\alpha$  and  $\beta$  are given by

$$\alpha = 1_{\mathcal{D}^\omega}, \quad \beta = \sum_w \omega_{w,w^{-1},w} T_{1_G}^w. \quad (4.50)$$

(Recall the definition of a quasi Hopf algebra from subsection 4.4).

Furthermore, as a braided Hopf algebra,  $\mathcal{D}^\omega(\mathbb{K}G)$  comes with a quasi-triangular structure which stays the same as in the untwisted case,

$$\mathcal{R} = \sum_{v,w} T_{1_G}^v \otimes T_v^w, \quad (4.51)$$

and which fulfills the Quasi-Yang-Baxter Equation (4.22). The antipode acts as

$$S(T_g^w) = (\mathcal{P}_{w^{-1}}^{g,g^{-1}})^{-1} (\mathcal{Q}_{w,w^{-1}}^g)^{-1} T_{g^{-1}}^{(w^{-1})^g}. \quad (4.52)$$

and one can find an explicit Drinfel'd twist

$$\mathcal{F} = \sum_{u,v} \alpha_{u,v}^{-1} T_{1_G}^u \otimes T_{1_G}^v, \quad (4.53)$$

with  $\alpha_{u,v} : G \times G \rightarrow U(1)$  being some group 2-cochain. As an aside, any twist-equivalent quantum double  $\mathcal{D}^{\omega'}(\mathbb{K}G) = \mathcal{D}^\omega(\mathbb{K}G)_{\mathcal{F}}$  is then given by a cohomologous 3-cocycle  $\omega'$ , i.e.  $\omega' \omega^{-1} = \delta\alpha$ . One is then tempted to deduce that quasi Hopf algebras of the form  $\mathcal{D}^\omega(\mathbb{K}G)$  are thus classified (up to twist equivalence) by  $H^3(G, U(1))$ , but we are not going to follow this statement here.

The law (4.47) has already been encountered in (3.130)! A natural question to ask would be whether all other structures of this general theory arise as well as physical consequences like the product did. Indeed, as we will work out, the coproduct as well as the braiding and the associator have physical interpretations. However, before going into the details, there is just one other mathematical construction to be alluded to, which describes the structure of the representation spaces. As already stated in the beginning, the theory of Hopf algebras and their respective representation spaces is intimately tied up with the theory of tensor categories.

## § 4.6 MODULES AS TENSOR CATEGORIES

Suppose  $M_1, M_2$  are modules over an algebra  $\mathcal{A}$ . Then, there is of course a  $\mathcal{A} \otimes \mathcal{A}$ -module structure on the tensor product  $M_1 \otimes M_2$ , given canonically by  $(a \otimes b)(m_1 \otimes m_2) = (am_1 \otimes bm_2)$ , where  $a, b \in \mathcal{A}$  and  $m_i \in M_i$ . The important observation is, for  $\mathcal{A}$  equipped with a bialgebra structure, the algebra morphism  $\Delta : \mathcal{A} \rightarrow \mathcal{A} \otimes \mathcal{A}$  allows the  $\mathcal{A} \otimes \mathcal{A}$ -module  $M_1 \otimes M_2$  to become also an  $\mathcal{A}$ -module, simply by the abuse of the coproduct  $a(m_1 \otimes m_2) = a_{(1)}m_1 \otimes a_{(2)}m_2$ . This procedure is applicable more than once, giving for example an  $\mathcal{A}$ -module structure on  $M_1 \otimes M_2 \otimes M_3$  by  $\Delta^2(a)(m_1 \otimes m_2 \otimes m_3)$ . Recall that there are two possibilities for  $\Delta^2$ . Namely  $(\text{id} \otimes \Delta) \circ \Delta$  and  $(\Delta \otimes \text{id}) \circ \Delta$  corresponding to  $M_1 \otimes (M_2 \otimes M_3)$  and  $(M_1 \otimes M_2) \otimes M_3$ , respectively. They are only equivalent if  $\mathcal{A}$  is coassociative, otherwise there has to exist at least an isomorphism between them. For vector spaces there are the natural isomorphisms  $(V_1 \otimes V_2) \otimes V_3 \simeq V_1 \otimes (V_2 \otimes V_3)$  and  $\mathbb{K} \otimes V \simeq V \simeq V \otimes \mathbb{K}$  due to the definition of the tensor product. In the case of modules over an algebra (or even more general tensor products), these isomorphisms have to become the appropriate morphisms compatible with the structure.

Indeed, if  $\mathcal{A}$  is a bialgebra, the isomorphisms between  $(M_1 \otimes M_2) \otimes M_3 \simeq M_1 \otimes (M_2 \otimes M_3)$  and  $\mathbb{K} \otimes M \simeq M \simeq M \otimes \mathbb{K}$  are  $\mathcal{A}$ -module morphisms, with  $\mathbb{K}$  as an  $\mathcal{A}$ -module by the trivial action  $a\lambda = \epsilon(a)\lambda$ . The existence of these properties can be expressed by saying that the category of representations of a Hopf algebra is *monoidal* because the necessary compatibility axioms for the tensor product in a monoidal category are satisfied in this case.

A physicist's definition of a category goes as follows: A category  $\mathcal{C}$  is a collection of objects  $U, V, W, \dots$  and a set of morphisms  $\text{Mor}(U, V)$  for each  $U, V$ . The sets  $\text{Mor}(U, V)$  and  $\text{Mor}(W, X)$  should be disjoint unless  $U = W$  and  $V = X$  and there is an associative composition  $(\psi \circ \phi) \in \text{Mor}(U, W)$  if  $\phi \in \text{Mor}(U, V)$  and  $\psi \in \text{Mor}(V, W)$ . Further, every set  $\text{Mor}(V, V)$  should contain an identity element  $\text{id}_V$ .

Talking about categories always comes with talking about functors as well. So a *covariant functor*  $F : \mathcal{C} \rightarrow \mathcal{D}$  between two categories is a map, mapping objects to objects, i.e. for every  $V \in \mathcal{C}$  there is an element  $F(V) \in \mathcal{D}$ , and morphisms to morphisms, i.e. for every  $\phi : V \rightarrow W$  there is a morphism  $F(\phi) : F(V) \rightarrow F(W)$ , such that  $F(\psi \circ \phi) = F(\psi) \circ F(\phi)$ . Then, a *monoidal* category is a category  $\mathcal{C}$  together with a functor  $\otimes : \mathcal{C} \times \mathcal{C} \rightarrow \mathcal{C}$  which is associative, i.e. there is for each triple  $(U, V, W)$  a functorial isomorphism (called associativity constraint)  $\Phi_{U,V,W} : (U \otimes V) \otimes W \rightarrow U \otimes (V \otimes W)$ . It is clear that here one tries to mimic the definitions of a normal tensor product between vector spaces; so this is why the functor  $\otimes$  of the category is also called tensor product and the category *tensor category*. One also requires the existence of a unit element  $I \in \mathcal{C}$  together with isomorphisms  $\ell_V : I \otimes V \rightarrow V$  and  $r_V : V \otimes I \rightarrow V$ , called left (resp. right) unit constraint.  $\Phi$  has to fulfill the famous

◇ Pentagon Axiom:

$$\begin{array}{ccc}
 & (W \otimes X) \otimes (Y \otimes Z) & \\
 \Phi_{W \otimes X, Y, Z} \nearrow & & \searrow \Phi_{W, X, Y \otimes Z} \\
 ((W \otimes X) \otimes Y) \otimes Z & & W \otimes (X \otimes (Y \otimes Z)) \\
 \Phi_{W, X, Y} \otimes \text{id}_Z \searrow & & \nearrow \text{id}_W \otimes \Phi_{X, Y, Z} \\
 (W \otimes (X \otimes Y)) \otimes Z & \xrightarrow{\Phi_{W, X \otimes Y, Z}} & W \otimes ((X \otimes Y) \otimes Z)
 \end{array} \tag{4.54}$$

commutes,

whereas the unit-constraints obey the

◇ Triangle Axiom:

$$\begin{array}{ccc}
 (V \otimes I) \otimes W & \xrightarrow{\Phi_{V, I, W}} & V \otimes (I \otimes W) \\
 r_V \otimes \text{id}_W \searrow & & \nearrow \text{id}_V \otimes \ell_W \\
 & V \otimes W &
 \end{array} \tag{4.55}$$

commutes.

Indeed, this definition seems a bit abstract, but in principle, one just has to think about a collection of tensor products of elements, where you can fill in the brackets where you want, because they all coincide (in the sense that there is an isomorphism between them). As a matter of fact, the pentagon axiom (4.54) and the triangle (4.55) are sufficient to show the generality of the latter argument.

What should be kept in mind is, that the axioms that are necessary for having a bialgebra  $\mathcal{A}$  are directly reflected by the axioms that have to be fulfilled in order to make the category of modules  ${}_{\mathcal{A}}\mathcal{M}$  a tensor category. So one could say that coassociativity translates to associativity in the category, and the counit relations of the bialgebra lead to the axioms of unity in  ${}_{\mathcal{A}}\mathcal{M}$ . There is even a statement about the opposite argumentation: if the category of  $\mathcal{A}$ -modules over an algebra  $\mathcal{A}$  is tensor, then  $\mathcal{A}$  is equipped with a bialgebra structure. For a coassociative bialgebra, the associativity constraint  $\Phi$  of the category is trivial. (If, in addition the left and right unit constraints  $\ell, r$  are trivial as well, the category is called strict.) If the bialgebra is a quasi bialgebra with a Drinfel'd associator  $\Omega$ , the associativity constraint in the category is given by

$$\Phi_{U,V,W}((u \otimes v) \otimes w) = \sum \varphi_1 \triangleright u \otimes (\varphi_2 \triangleright v \otimes \varphi_3 \triangleright w), \quad (4.56)$$

where again the notation is  $\Omega = \sum \varphi_1 \otimes \varphi_2 \otimes \varphi_3$ . Therefore, quasi-coassociativity on the bialgebra level determines an associativity constraint for the category and the strictness is lost.

## § 4.7 QUASITENSOR OR BRAIDED MONOIDAL CATEGORIES

Having an associativity and a left (resp. right) unity constraint for the tensor category following from coassociativity and the counit, one could ask the question whether there is a similar construction concerning commutativity of the 'tensor' product. For vector spaces, this is trivially implemented just by the transposition map flipping two elements  $u \otimes v \mapsto v \otimes u$ . For the category of  $\mathcal{A}$ -modules  ${}_{\mathcal{A}}\mathcal{M}$  there should be isomorphisms between two objects  $\Psi : U \otimes V \simeq V \otimes U$ , but the two representations can be rather unrelated. As a matter of fact, one can define a category with such a map  $\Psi$  in the following way: A *braided* or *quasitensor* category  $\mathcal{C}$  is a monoidal category with a commutativity constraint, i.e. a functorial isomorphism  $\Psi_{V,W} : V \otimes W \rightarrow W \otimes V$  for each two elements  $U, V \in \mathcal{C}$ .  $\Psi$  has to fulfill the the famous

◇ Hexagon Axioms:

$$\begin{array}{ccc}
V \otimes (W \otimes Z) & & (V \otimes W) \otimes Z \\
\text{id}_V \otimes \Psi_{W,Z} \swarrow & & \Phi_{V,W,Z} \swarrow \\
V \otimes (Z \otimes W) & & (V \otimes W) \otimes Z \\
\Phi_{V,Z,W}^{-1} \downarrow & & \Psi_{V \otimes W, Z} \downarrow \\
(V \otimes Z) \otimes W & & Z \otimes (V \otimes W) \\
\Psi_{V,Z} \otimes \text{id}_W \searrow & & \Phi_{Z,V,W}^{-1} \searrow \\
(Z \otimes V) \otimes W & & \\
\end{array}
\qquad
\begin{array}{ccc}
(V \otimes W) \otimes Z & & (V \otimes W) \otimes Z \\
\Phi_{V,W,Z} \swarrow & & \Psi_{V,W} \otimes \text{id}_Z \swarrow \\
V \otimes (W \otimes Z) & & (W \otimes V) \otimes Z \\
\Psi_{V,W \otimes Z} \downarrow & & \Phi_{W,V,Z} \downarrow \\
(W \otimes Z) \otimes V & & W \otimes (V \otimes Z) \\
\Phi_{W,Z,V} \searrow & & \text{id}_W \otimes \Psi_{V,Z} \searrow \\
W \otimes (Z \otimes V) & & \\
\end{array}
\tag{4.57}$$

commute.

In general, the difference between  $\Psi$  and the transposition map is that one does not assume that  $\Psi \circ \Psi = \text{id}$ . This is why one has to think of 'braids' between the objects of the category, and not simply transpositions. So  $\Psi$  itself is normally called *braiding* of the category.

The interesting analogy between the braided category and the underlying braided bialgebra is that  $\Psi$  can be constructed from the quasi-triangular structure  $\mathcal{R}$ ,

$$\Psi_{V,W}(v \otimes w) = \sum \mathcal{R}_2 \triangleright w \otimes \mathcal{R}_1 \triangleright v = \mathcal{R}_{21} \triangleright \tau(v \otimes w), \tag{4.58}$$

so just by the action of  $\mathcal{R}$  (written as  $\sum \mathcal{R}_1 \otimes \mathcal{R}_2$ ) followed by the flip  $\tau$ . Again, the argumentation goes as well into the opposite direction, namely, the category of modules over a bialgebra is braided, *if and only if*, the bialgebra is. Notice that if one has a braiding between two objects of  $\mathcal{A}\mathcal{M}$ , this corresponds to having a generator of the braid group! As a result, one has automatically a representation of the braid group on any braided tensor category. And this is the connection between the braid group and the (Quasi)-Yang-Baxter-Equation (4.14) (resp. (4.22)): Suppose we use the representation  $\varrho(\sigma_i)$  of the generators  $\sigma_1$  and  $\sigma_2$  on  $(U \otimes V) \otimes W$  by applying the map given in (4.58) in the appropriate slot. This means that we have to take care of the bracket structure, i.e.  $\Psi$  can only act within a bracket enclosing two elements. This will introduce some multiplications with  $\Omega$  following (4.56); in other words we want to act with  $\sigma_1 \sigma_2 \sigma_1$  on an element  $u \otimes v \otimes w \in (U \otimes V) \otimes W$  (written as  $(u \otimes v) \otimes w$  for clarity) and compare the result with  $\sigma_2 \sigma_1 \sigma_2$  acting on the same element. Of course, this is the second Artin relation, and having a good representation of the braid group means  $\sigma_1 \sigma_2 \sigma_1 = \sigma_2 \sigma_1 \sigma_2$ . After a little calculation one finds

$$\varrho(\sigma_1) \varrho(\sigma_2) \varrho(\sigma_1) ((u \otimes v) \otimes w) = \mathcal{R}_{21} \Omega_{213}^{-1} \mathcal{R}_{31} \Omega_{231} \mathcal{R}_{32} ((w \otimes v) \otimes u) \tag{4.59}$$

$$\varrho(\sigma_2) \varrho(\sigma_1) \varrho(\sigma_2) ((u \otimes v) \otimes w) = \Omega_{123}^{-1} \mathcal{R}_{32} \Omega_{132} \mathcal{R}_{31} \Omega_{312}^{-1} \mathcal{R}_{21} \Omega_{321} ((w \otimes v) \otimes u) \tag{4.60}$$

with the action  $\triangleright$  in (4.56) and (4.58) taken just as multiplication. But this is exactly the QQYBE of (4.22) after swapping  $1 \leftrightarrow 3$ . Analogously, this becomes the normal QYBE, namely if  $\Omega$  and therefore the associativity constraint  $\Phi$  are trivial.

So in the case of a quasi algebra, the Drinfel'd associator  $\Omega \in \mathcal{A} \otimes \mathcal{A} \otimes \mathcal{A}$  makes the braiding more complicated, because one has to take care of the brackets in multiple tensor product expressions

$$(u \otimes v \otimes w \otimes z) \longrightarrow (((u \otimes v) \otimes w) \otimes z). \quad (4.61)$$

Therefore one can decide to chose a unique system of parenthesis all opening on the left (or on the right). The multiplication by  $\Omega$  allows to change these brackets, for example  $((u \otimes v) \otimes w) \rightarrow \Omega(u \otimes (v \otimes w))$ , or  $((u \otimes v) \otimes (w \otimes z)) \rightarrow (\Delta \otimes \text{id} \otimes \text{id})[\Omega^{-1}](((u \otimes v) \otimes w) \otimes z)$ . It is not possible, to braid the last expression  $((u \otimes v) \otimes (w \otimes z))$  in the 2. and 3. argument without multiplying before with  $(\Omega \otimes \text{id})(\Delta \otimes \text{id} \otimes \text{id})[\Omega^{-1}]$ , to enclose  $v$  and  $w$  into a pair of brackets. This means that the representation of the braid group has to take this into account if acting on multiple tensor product expressions like (4.61). Define

$$\varrho(\sigma_i) (\dots(v_1 \otimes v_2) \otimes \dots v_{n-1}) \otimes v_n = \Phi_i^{-1} \tau_{i,i+1} \mathcal{R}_{i,i+1} (\Phi_i(v_1 \otimes \dots \otimes v_n)) \quad (4.62)$$

to always ensure the right positions of the brackets.  $\Phi_k$  is defined to be

$$\Phi_k = \Delta_L^{k-2}(\Omega) \otimes \text{id}^{\otimes n-k-1} \quad (4.63)$$

and

$$\Delta_L(v_1 \otimes \dots \otimes v_n) = (\Delta(v_1) \otimes v_2 \otimes \dots \otimes v_n). \quad (4.64)$$

$\Phi_1$  is the identity. This representation shifts the brackets into the proper position, applies the braid, and puts the brackets back to place afterwards. In (4.59) and (4.60) this was done, we only had to use  $\Phi_2 = \Omega$ .

## § 4.8 APPENDIX: HIGHER COPRODUCTS OF $\mathcal{R}$

In the coassociative case, sometimes it might be useful to have a closed expression for higher coproducts of the  $\mathcal{R}$ -matrix. Since this does not exist in various textbooks, the formula and its proof is included here:

*Proposition:* If  $\mathcal{R}$  is the quasi-triangular structure of a braided bialgebra with coproduct  $\Delta$ , then for  $m, n \geq 0$

$$(\Delta^m \otimes \Delta^n) \mathcal{R} = \prod_{i=1}^{m+1} \prod_{j=m+n+2}^{m+2} \mathcal{R}_{ij}. \quad (4.65)$$

*Proof:* Since we are in the case of a braided bialgebra, we have  $(\text{id} \otimes \Delta) \mathcal{R} = \mathcal{R}_{13} \mathcal{R}_{12}$  and  $(\Delta \otimes \text{id}) \mathcal{R} = \mathcal{R}_{13} \mathcal{R}_{23}$ . Now assume that for  $n \geq 0$  it is true that

$$(\text{id} \otimes \Delta^n) \mathcal{R} = \prod_{i=n+2}^2 \mathcal{R}_{1,i} \quad (4.66)$$

and write

$$(\text{id} \otimes \Delta^n) = (\text{id}^{\otimes n} \otimes \Delta) \circ (\text{id}^{\otimes n-1} \otimes \Delta) \circ \dots \circ (\text{id} \otimes \Delta). \quad (4.67)$$

Then, for  $n + 1$  we have

$$\begin{aligned} (\text{id} \otimes \Delta^{n+1})\mathcal{R} &= (\text{id}^{\otimes n+1} \otimes \Delta) \circ (\text{id} \otimes \Delta^n)\mathcal{R} = (\text{id}^{\otimes n+1} \otimes \Delta) \left[ \prod_{i=n+2}^2 \mathcal{R}_{1,i} \right] \\ &= \prod_{i=n+2}^2 [(\text{id}^{\otimes n+1} \otimes \Delta)\mathcal{R}_{1,i}] \end{aligned} \quad (4.68)$$

Note that in the above formula  $\mathcal{R}_{1,i} \in \mathcal{A}^{\otimes n+2}$  with  $i = 2, \dots, n+2$ . There are two possibilities:

- i)  $2 \leq i \leq n+1 : \rightarrow (\text{id}^{\otimes n+1} \otimes \Delta)\mathcal{R}_{1,i} = \mathcal{R}_{1,i} \in \mathcal{A}^{\otimes n+3}$  (with  $\Delta(1) = 1 \otimes 1$ )
- ii)  $i = n+2 : \rightarrow (\text{id}^{\otimes n+1} \otimes \Delta)\mathcal{R}_{1,i} = \mathcal{R}_{1,n+3}\mathcal{R}_{1,n+2}$

It follows

$$\begin{aligned} \prod_{i=n+2}^2 (\text{id}^{\otimes n+1} \otimes \Delta)\mathcal{R}_{1,i} &= \mathcal{R}_{1,n+3}\mathcal{R}_{1,n+2} \prod_{i=n+1}^2 (\text{id}^{\otimes n+1} \otimes \Delta)\mathcal{R}_{1,i} \\ &= \prod_{i=(n+1)+2}^2 \mathcal{R}_{1,i} \in \mathcal{A}^{\otimes n+3}. \end{aligned} \quad (4.69)$$

A similar formula is obtained in the same way for the other one

$$(\Delta^m \otimes \text{id})\mathcal{R} = \prod_{i=1}^{m+1} \mathcal{R}_{i,m+2}. \quad (4.70)$$

Since we are interested in  $(\Delta^m \otimes \Delta^n)$ , we first rewrite it as

$$(\Delta^m \otimes \Delta^n) = (\text{id}^{\otimes m+1} \otimes \Delta^n) \circ (\Delta^m \otimes \text{id}) \quad (4.71)$$

and use eq. (4.66) respectively (4.70) to handle the expressions. Plugging it in and using again the fact, that  $\Delta$  is an algebra homomorphism, we have to calculate

$$(\text{id}^{\otimes m+1} \otimes \Delta^n) \left[ \prod_{i=1}^{m+1} \mathcal{R}_{i,m+2} \right] = \prod_{i=1}^{m+1} (\text{id}^{\otimes m+1} \otimes \Delta^n)\mathcal{R}_{i,m+2}, \quad (4.72)$$

and recover formula (4.66), this time for  $\mathcal{R}_{i,m+2}$  instead of  $\mathcal{R}_{12}$ , where there is just  $m$  times a “1” included. In other words,

$$(\text{id}^{\otimes m+1} \otimes \Delta^n)\mathcal{R}_{i,m+2} = \prod_{j=m+n+2}^{m+2} \mathcal{R}_{ij}, \quad (4.73)$$

which gives eq. (4.65). □



---



---

## CHAPTER 5

---

# INTERACTING STRINGS AND THE QUASI HOPF STRUCTURE

Returning to the magnetic translations  $T_g^w$  (and having viewed the coproduct from the purely algebraic perspective), a further analysis will pave the way to a stringy interpretation of the various algebraic components in terms of magnetic amplitudes describing interactions. As previously stated, string interactions can be represented by Riemann surfaces (world-sheets)  $\Sigma$  that encode the details of the interaction process within their topology. For example, an incoming string that splits into two and recombines afterwards will build a genus one world-sheet which has the shape of a torus with two holes in it. For the sake of simplicity and feasibility, the following analysis shall be restricted to the case of tree-level decays, i.e. trivial genus.

### § 5.1 STOKE'S LAW IN DELIGNE LANGUAGE

The first problem one encounters if one likes to do explicit calculations, is that for amplitudes more complicated than the cylinder, the assumed triangulation is not that simple. Recall that any abstract world-sheet  $\mathcal{S}$  has to be cut  $\mathcal{S} \rightarrow \mathcal{S}_c$  such that one has a simply connected time-space submanifold  $\varphi(\mathcal{S}_c) = \Sigma$ . However, as described in chapter 3, the amplitude is triangulation invariant and is implicitly encoded into the short notation [...]. From (3.28) we can see that this notation gives a correspondence between the complicated  $(s+1)$ -tuples in  $\mathcal{T}_{r,s}$  of the Čech-de Rham bicomplex and globally defined differential  $s$ -forms. This is the line of thought followed in the sequel, namely, the Deligne-cochains behave *as if* they were global forms. The computational details are all done automatically if [...] is used.

For example, we have seen that an element  $\mathbf{A} = (A_i, f_{ij}) \in \mathcal{T}_{r,1}$ , (the  $r$ -fold group index has been omitted for brevity), can be integrated along a trajectory from  $\varphi : x \rightarrow y$ , simply written as

$$\left[ e^{i \int_x^y \mathbf{A}} \right]_{ji} := \exp\left\{ i \sum_{s_j} \int_{s_j} \varphi^* A_{\beta_j} \right\} \prod_{s_j, v_k | v_k \in \partial s_j} \varphi^* f_{\beta_j \gamma_k}^{-\epsilon(j,k)}(v_k), \quad (5.1)$$

which intrinsically uses both components  $(A_i, f_{ij})$ . Apart from the assignment of open sets pertaining to the initial point  $x, \mathcal{U}_i$ , and the final point  $y, \mathcal{U}_j$ , it is assumed that there always exists an application  $\varphi$  and an intermediate triangulation with open sets such that  $\varphi(s_j) \subset \mathcal{U}_{\beta_j}$  and  $\varphi(v_k) \in \mathcal{U}_{\gamma_k}$ . This is particularly useful, if one integrates a total derivative. Let  $\boldsymbol{\eta} \in \mathcal{T}_{r,0}$ , or in components,  $\boldsymbol{\eta} = (\eta_i)$ . The Deligne differential  $\mathcal{D}$  (3.16) tells us that

$$\mathcal{D}\boldsymbol{\eta} = (\text{id log } \eta_i, \eta_j \eta_i^{-1}). \quad (5.2)$$

By computing explicitly the line integral of this differential

$$\begin{aligned} \left[ e^{\int_x^y \mathcal{D}\boldsymbol{\eta}} \right]_{ji} &= \exp\left\{i \sum_{s_j} \int_{\varphi(s_j)} \text{id log } \eta_{\beta_j}\right\} \prod_{s_j, v_k | v_k \in \partial s_j} (\eta_{\gamma_k} \eta_{\beta_j}^{-1})^{-\epsilon(j,k)}(\varphi(v_k)) \\ &= \prod_{s_j, v_k | v_k \in \partial s_j} \eta_{\gamma_k}^{-\epsilon(j,k)}(\varphi(v_k)) = \eta_j^{-1}(y) \eta_i(x) \\ &= [\boldsymbol{\eta}(y)^{-1}]_j [\boldsymbol{\eta}(x)]_i \end{aligned} \quad (5.3)$$

this yields up to a sign convention exactly the result one would have expected from globally defined forms.

The same holds for Deligne 2-forms. For example, take  $\Lambda = (\Lambda_i, \eta_{ij}) \in \mathcal{T}_{r,1}$  and integrate

$$\mathcal{D}\Lambda = (d\Lambda_i, \Lambda_j - \Lambda_i - \text{id log } \eta_{ij}, \eta_{jk}^{-1} \eta_{ik} \eta_{ij}^{-1}) \quad (5.4)$$

along a surface  $\Sigma$ :

$$\begin{aligned} \left[ e^{\int_{\Sigma} \mathcal{D}\Lambda} \right] &= \exp\left\{i \sum_{c_i} \int_{\varphi(c_i)} d\Lambda_{\alpha_i}\right\} \exp\left\{i \sum_{s_j \subset \partial c_i} \int_{\varphi(s_j)} (\Lambda_{\beta_j} - \Lambda_{\alpha_i} - \text{id log } \eta_{\alpha_i \beta_j})\right\} \\ &\times \prod_{v_k \in \partial s_j} (\eta_{\beta_j \gamma_k}^{-1} \eta_{\alpha_i \gamma_k} \eta_{\alpha_i \beta_j}^{-1})^{\epsilon(j,k)}(\varphi(v_k)) \\ &= \exp\left\{i \sum_{s_j \in \partial c_i} \int_{\varphi(s_j)} \Lambda_{\beta_j}\right\} \prod_{v_k \in \partial s_j} \eta_{\beta_j \gamma_k}^{-\epsilon(j,k)}(\varphi(v_k)) \\ &= \left[ e^{\int_{\partial \Sigma} \Lambda} \right], \end{aligned} \quad (5.5)$$

which is again Stoke's law. Therefore, one can intuitively carry out the computations without knowing anything about the interior cancellations (which are in fact always of this nature). In other words, the notation behaves as if all forms were globally defined. By choosing a valid triangulation, writing down all Čech indices and doing the explicit computation, one will always find a result which could have been expected from the previous considerations. Also, by the same token, this justifies the result (3.64) concerning homotopic changes of the cut.

## § 5.2 DERIVATION OF THE COPRODUCT FROM THE PAIR OF PANTS

As said above, the cornerstone of the subsequent derivation of the quasi Hopf structure of the algebra generated by the stringy magnetic translations resides in the geometrical nature

of the interactions of strings. To be more precise, consider a process in which  $m$  incoming strings scatter to produce  $n$  outgoing ones. In the path integral formalism, this should give rise to an operator

$$K^{m \rightarrow n} : \mathcal{H}^{\otimes m} \rightarrow \mathcal{H}^{\otimes n} \quad (5.6)$$

containing the magnetic amplitude,

$$K^{m \rightarrow n}(\cup_i^n Y_i ; \cup_j^m X_j) = \int_{\varphi(\partial\mathcal{S}) = \vec{X}^* \cup \vec{Y}} [\mathcal{D}\varphi] e^{-S[\varphi]} \mathcal{A}[\varphi], \quad (5.7)$$

where  $\varphi : \mathcal{S} \rightarrow \mathcal{M}$  is the conformal field describing the embedding of the strings into space-time. The surface  $\mathcal{S}$  has a boundary made of  $m + n$  circles, the  $n$  circles  $\vec{Y} = (Y_1, \dots, Y_n)$  whose orientation agrees with that of  $\varphi(\partial\mathcal{S})$  correspond to the outgoing strings while the  $m$  others  $\vec{X} = (X_1, \dots, X_m)$  are the incoming ones. This is a generalization of the single string propagator  $K^{1 \rightarrow 1}(Y; X)$  (3.59) where the index  $\cdot^{1 \rightarrow 1}$  has been omitted. In our context, the magnetic amplitude  $\mathcal{A}[\varphi]$  has to be equipped with  $n + m$  boundary triangulation indices,  $J_1, \dots, J_n, I_1, \dots, I_m$  pertaining to the collection of circles  $\cup_i Y_i$  and  $\cup_j X_j$ .

To derive the coproduct, it suffices to regard the tree level decay of a string of winding  $vw$  into a string of winding  $v$  and another one of winding  $w$ . In decays, one should think of the winding as a conserved quantity. The amplitude of this process  $K_{v,w}^{1 \rightarrow 2}$  is associated to the pair of pants  $\mathcal{S}$  depicted in figure 5.1.

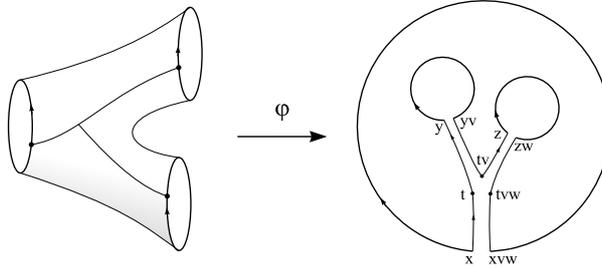

Figure 5.1: Basic interaction associated to a pair of pants.

To construct the corresponding magnetic amplitude, one has to cut the pants in order to obtain a simply connected surface. Then, the amplitude reads

$$\mathcal{A}_{JK,I}[\varphi] = \left[ e^{i \int_{\Sigma} \mathbf{B} + i \int_x^t \mathbf{A}_{vw} + i \int_t^y \mathbf{A}_v + i \int_{t_v}^z \mathbf{A}_w} \Phi_{v,w}^{-1}(t) \right]_{JK,I}, \quad (5.8)$$

where  $I$  is used to cover the incoming string while  $J$  and  $K$  label the covers of the two outgoing strings. The insertion of  $\Phi_{v,w}^{-1}(t)$  is necessary to maintain invariance under the secondary gauge transformations of  $\mathbf{A}$  and  $\Phi$  given by (3.46) as we will see below. Apart from the surface integral over  $\Sigma$ , there are several integrations along the cuts, each one integrates the 1-form contribution corresponding to its winding, i.e.  $\mathbf{A}_v$ ,  $\mathbf{A}_w$  and  $\mathbf{A}_{vw}$ . This magnetic amplitude is to be inserted into the path integral for the evolution operator  $K_{v,w}^{1 \rightarrow 2}$  encoding

the decay process  $\mathcal{H}_{vw} \rightarrow \mathcal{H}_v \otimes \mathcal{H}_w$ ,

$$K_{v,w}^{1 \rightarrow 2}(Y \cup Z; X) = \int_{\varphi(\partial\mathcal{S})=X^* \cup Y \cup Z} [\mathcal{D}\varphi] e^{-S[\varphi]} \mathcal{A}[\varphi], \quad (5.9)$$

where  $X$ ,  $Y$  and  $Z$  are three strings of respective windings  $vw$ ,  $v$  and  $w$ . In this heuristic analysis above, the indices pertaining to the coverings are left out for the sake of clarity. Lower winding indices indicate the result of a  $\cdot^{1 \rightarrow 2}$  process.

As already mentioned, the insertion of  $\Phi^{-1}$  in the amplitude (5.8) is motivated by the requirement of gauge invariance. Recall that if  $\mathbf{B} \rightarrow \mathbf{B} + \mathcal{D}\Lambda$ , the 1-form contribution changes according to  $\mathbf{A} \rightarrow \mathbf{A} + \delta\Lambda$ . Writing in detail the so arising terms, one finds that

$$\left[ e^{i \int_{\partial\Sigma} \Lambda + i \int_x^t (\delta\Lambda)_{vw} + i \int_t^y (\delta\Lambda)_v + i \int_{tv}^z (\delta\Lambda)_w} \right]_{JK,I} = \left[ e^{-i \int_x^{vw} \Lambda} \right]_I \left[ e^{i \int_y^{vw} \Lambda} \right]_J \left[ e^{i \int_z^{vw} \Lambda} \right]_K \quad (5.10)$$

leaving one primary gauge term for each string, as expected. Secondary gauging,  $\mathbf{A} \rightarrow \mathbf{A} + \mathcal{D}\Theta$ , however, generates a term

$$\begin{aligned} \left[ e^{i \int_x^t \mathcal{D}\Theta_{vw} + i \int_t^y \mathcal{D}\Theta_v + i \int_{tv}^z \mathcal{D}\Theta_w} \right]_{JK,I} &= [\Theta_{vw}(x)]_I [\Theta_v^{-1}(y)]_J [\Theta_w^{-1}(z)]_K \\ &\times [v^* \Theta_w(t) \Theta_{vw}^{-1}(t) \Theta_v(t)]_\alpha, \end{aligned} \quad (5.11)$$

with  $\mathcal{U}_\alpha$  the open set used to cover the branching point  $t$ . In order to cancel the  $t$ -dependent term in the previous formula, one has to insert an additional  $\Phi^{-1}$  in the amplitude (5.8), since secondary gauging also changes  $\Phi$  according to  $\Phi \rightarrow \Phi \delta\Theta$ .

Apart from gauge invariance, the amplitude is independent of the homotopy class of the three cuts and under diffeomorphisms connected to the identity that act trivially on the boundary strings. Besides, using the relation  $\mathcal{D}\Phi_{v,w} = v^* \mathbf{A}_w - \mathbf{A}_{vw} + \mathbf{A}_v$ , one can move the point  $t$  along the cut, leaving the amplitude unchanged. Obviously, if one considers the reversed process in which two strings join, one has to insert  $\Phi_{v,w}$ . It is interesting to note that a similar phase factor has been encountered in the context of toroidally compactified closed string field theory [42]. Whereas our phase factor is a 2-cochain on the windings, their phase factor is a 2-cocycle on the momenta. This is equivalent, since T-duality exchanges windings and momenta, and their cocycle condition simply stipulates the triviality of  $\omega$ .

The amplitude (5.8) contributes to the process describing the tree level decay  $\mathcal{H}_{vw} \rightarrow \mathcal{H}_v \otimes \mathcal{H}_w$ . It is expected that the corresponding operator  $K_{v,w}^{1 \rightarrow 2}$  commutes with the action of  $G$ , but the latter may be defined on the tensor product  $\mathcal{H}_v \otimes \mathcal{H}_w$  only up to an additional phase. To determine the possible extra phase in the tensor product, compare the operators

$$K_{v,w}^{1 \rightarrow 2} T_g^{vw} \leftrightarrow (T_g^v \otimes T_g^w) K_{v^g, w^g}^{1 \rightarrow 2}. \quad (5.12)$$

It is important to take care of the windings for  $G$  not abelian, because as already stated above,  $T_g^w$  changes the winding, since  $X \cdot g$  starts at  $x \cdot g$  and ends at  $x \cdot wg = x \cdot gw^g$ . At the level of the kernels, (5.12) means that one has to compare

$$K_{v,w}^{1 \rightarrow 2}(Y \cup Z; X) \Upsilon_g^{vw}(X) \leftrightarrow \Upsilon_g^v(Y) \Upsilon_g^w(Z) K_{v^g, w^g}^{1 \rightarrow 2}(Y \cdot g \cup Z \cdot g; X \cdot g), \quad (5.13)$$

where  $\Upsilon_g^w$  stands for the phase defining the stringy magnetic translation given by equation (3.113). For that, proceed as for single string propagations in the last section and simply compare the magnetic amplitudes.  $\mathcal{A}_{JK,I}[\varphi]$  enters into  $K_{v,w}^{1 \rightarrow 2}(Y \cup Z; X)$  whereas  $\mathcal{A}_{JK,I}[\varphi \cdot g]$  is the corresponding term in  $K_{v^g, w^g}^{1 \rightarrow 2}(Y \cdot g \cup Z \cdot g; X \cdot g)$ .

To begin with, the translated amplitude involving strings of windings  $v^g$ ,  $w^g$  and  $(vw)^g$  reads

$$\mathcal{A}_{JK,I}[\varphi \cdot g] = \left[ e^{i \int_{\Sigma} g^* \mathbf{B} + i \int_x^t g^* \mathbf{A}_{(vw)^g} + i \int_t^y g^* \mathbf{A}_{v^g} + i \int_{t^z}^z g^* \mathbf{A}_{w^g}} g^* \Phi_{v^g, w^g}^{-1}(t) \right]_{JK,I}. \quad (5.14)$$

For the computation of the ratio (in order to find the expected extra phase factors that accompany the tensor product), recall that  $\mathcal{D}\Gamma_{w,g} = g^* \mathbf{A}_{w^g} - \mathbf{A}_w - w^* \mathbf{A}_g + \mathbf{A}_g$ . Using as well Stoke's law for Deligne 2-forms (5.5),

$$\left[ e^{i \int_{\Sigma} g^* \mathbf{B} - \mathbf{B}} \right] = \left[ e^{i \int_{\partial \Sigma} \mathbf{A}_g} \right], \quad (5.15)$$

one can rearrange the terms in the ratio, such that

$$\begin{aligned} \frac{\mathcal{A}_{JK,I}[\varphi \cdot g]}{\mathcal{A}_{JK,I}[\varphi]} &= \left[ e^{-i \int_x^{xvw} \mathbf{A}_g} \right]_I \left[ e^{i \int_y^{yv} \mathbf{A}_g} \right]_J \left[ e^{i \int_z^{zw} \mathbf{A}_g} \right]_K \\ &\times \left[ e^{i \int_x^t \mathcal{D}\Gamma_{vw,g} + i \int_t^y \mathcal{D}\Gamma_{v,g} + i \int_{t^z}^z \mathcal{D}\Gamma_{w,g}} g^* \Phi_{v^g, w^g}^{-1}(t) \Phi_{v,w}(t) \right]_{JK,I}. \end{aligned} \quad (5.16)$$

Integrating the total derivatives and reshuffling some of the components, the ratio can be expressed as

$$\frac{\mathcal{A}_{JK,I}[\varphi \cdot g]}{\mathcal{A}_{JK,I}[\varphi]} = \left[ \frac{(\Gamma_{v,g}^{-1}(y) e^{i \int_y^{yv} \mathbf{A}_g}) (\Gamma_{w,g}^{-1}(z) e^{i \int_z^{zw} \mathbf{A}_g})}{(\Gamma_{vw,g}^{-1}(x) e^{i \int_x^{xvw} \mathbf{A}_g})} \times \underbrace{\frac{\Phi_{v,w} \Gamma_{v,g} v^* \Gamma_{w,g}(t)}{g^* \Phi_{v^g, w^g} \Gamma_{vw,g}}}_{:= (\mathcal{Q}_{v,w}^g)^{-1}}(t) \right]_{JK,I}. \quad (5.17)$$

The first ratio in the bracket is nothing but

$$\frac{\left[ \Gamma_{v,g}^{-1}(y) e^{i \int_y^{yv} \mathbf{A}_g} \right]_J \left[ \Gamma_{w,g}^{-1}(z) e^{i \int_z^{zw} \mathbf{A}_g} \right]_K}{\left[ \Gamma_{vw,g}^{-1}(x) e^{i \int_x^{xvw} \mathbf{A}_g} \right]_I} = \frac{[\Upsilon_g^{vw}(X)]_I}{[\Upsilon_g^v(Y)]_J [\Upsilon_g^w(Z)]_K} \quad (5.18)$$

which is exactly what one expects from acting with  $T_g^{vw}$  on the incoming string and  $T_g^v \otimes T_g^w$  on the two outgoing ones, so that it cancels when acting with the stringy magnetic translations.

The under-braced term  $\mathcal{Q}_{v,w}^g$  takes a special form using the 3-cocycle  $\omega = \delta\Phi$ . With

$$\begin{cases} \omega_{g,v^g,w^g} = g^* \Phi_{v^g, w^g} \Phi_{v^g, w^g}^{-1} \Phi_{g, (vw)^g} \Phi_{g, v^g}^{-1} \\ \omega_{v,w,g} = v^* \Phi_{w,g} \Phi_{vw,g}^{-1} \Phi_{v,w,g} \Phi_{v,w}^{-1} \\ \omega_{v,g,w^g} = v^* \Phi_{g,w^g} \Phi_{v,g,w^g}^{-1} \Phi_{v,w,g} \Phi_{v,g}^{-1} \end{cases} \quad (5.19)$$

one obtains

$$\mathcal{Q}_{v,w}^g = \frac{\omega_{v,w,g} \omega_{g,v^g,w^g}}{\omega_{v,g,w^g}}, \quad (5.20)$$

which is globally defined and constant. Therefore, the action of  $G$  on the tensor product  $\mathcal{H}_{v^g} \otimes \mathcal{H}_{w^g}$  must be defined with the extra phase,

$$\mathcal{Q}_{v,w}^g (T_g^v \otimes T_g^w) : \mathcal{H}_{v^g} \otimes \mathcal{H}_{w^g} \rightarrow \mathcal{H}_v \otimes \mathcal{H}_w. \quad (5.21)$$

Amazing, eh? This is exactly the phase appearing in the coproduct  $\Delta : \mathcal{D}^\omega(\mathbb{K}G) \rightarrow \mathcal{D}^\omega(\mathbb{K}G) \otimes \mathcal{D}^\omega(\mathbb{K}G)$  of the quasi-quantum group, defined in (4.48) as

$$\Delta(T_g^u) = \sum_{vw=u} \mathcal{Q}_{v,w}^g T_g^v \otimes T_g^w. \quad (5.22)$$

In the first place, the definition of  $\mathcal{D}^\omega(\mathbb{K}G)$  appears rather abstractly. However, note that the derivation of the coproduct in our context arises quite naturally and, in fact, is a consequence of gauge invariance. The phase  $\mathcal{Q}_{v,w}^g$  is not a group 2-cocycle in  $v, w$ . Instead it fulfills

$$\mathcal{Q}_{u,v}^g \mathcal{Q}_{uv,w}^g \omega_{u^g,v^g,w^g} = \mathcal{Q}_{v,w}^g \mathcal{Q}_{u,vw}^g \omega_{u,v,w} \quad (5.23)$$

arising by repeated application of the cocycle relation  $\delta\omega = 1$ . As for the phase appearing in the product, the phase of the coproduct can be understood in terms of a prism, representing the translation by  $g$  of a string of winding  $vw$  decomposed into a string of winding  $v$  followed by a string of winding  $w$ . The decomposition of the prism into the three tetrahedra components is depicted in figure 5.2.

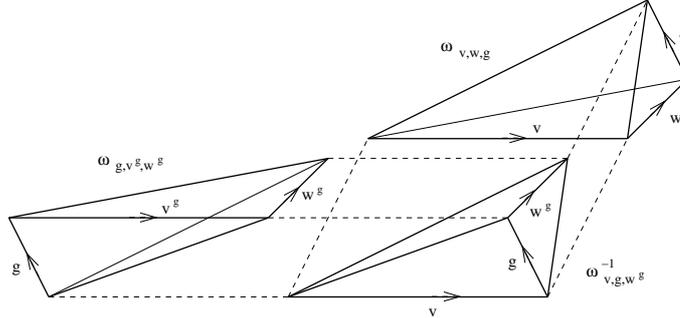

Figure 5.2: The phase of the coproduct in terms of tetrahedra.

Algebraically, we can thus promote (5.12) to an equation,

$$\Delta(T_g^{vw}) K_{v^g,w^g}^{1 \rightarrow 2} = K_{v,w}^{1 \rightarrow 2} T_g^{vw} \quad , \quad T_g^{vw} \in \mathcal{D}^\omega(\mathbb{K}G). \quad (5.24)$$

The coproduct provides us automatically with the phase  $\mathcal{Q}$  such that this equation is true. In (5.12), this was the ansatz, which has now turned out to be the right one if one adds the phase  $\mathcal{Q}$  by replacing the naive tensor product with the coproduct. One thus obtains the commuting diagram

$$\begin{array}{ccc} \mathcal{H}_{vw} & \xrightarrow{K_{v,w}^{1 \rightarrow 2}} & \mathcal{H}_v \otimes \mathcal{H}_w \\ T_g^{vw} \uparrow & & \uparrow \Delta(T_g^{vw}) \\ \mathcal{H}_{(vw)^g} & \xrightarrow{K_{v^g,w^g}^{1 \rightarrow 2}} & \mathcal{H}_{v^g} \otimes \mathcal{H}_{w^g} \end{array} \quad . \quad (5.25)$$

### § 5.3 TRANSGRESSION AND TWIST\*

The expression of the phase factor appearing in the multiplication law (3.130) in terms of the 3-cocycle  $\omega$  can be interpreted using a *transgression map* similar to the one introduced in [43]. Denote by  $(C, \delta)$  the standard group cohomology complex with values in  $U(1)$  and by  $(\tilde{C}, \tilde{\delta})$  a new complex whose cochains are group cochains with values in  $U(1)$ -valued functions over  $G$ . For any  $n$ -cochain in  $\tilde{C}^n$  defined by the function  $w \mapsto \tilde{c}_{g_1, \dots, g_n}(w)$ , define a twisted coboundary as

$$(\tilde{\delta}\tilde{c})_{g_0, \dots, g_n}(w) = \tilde{c}_{g_1, \dots, g_n}(w^{g_0}) \times \prod_{k=1}^n (\tilde{c}_{g_0, \dots, g_{k-1}g_k, \dots, g_n}(w))^{(-1)^k} \times (\tilde{c}_{g_0, \dots, g_{n-1}}(w))^{(-1)^{n+1}}. \quad (5.26)$$

The transgression map  $\mathcal{T}$  takes an  $(n+1)$ -cochain  $c_{g_1, \dots, g_{n+1}} \in C^{n+1}$  to an  $n$ -cochain in  $\tilde{C}$  by

$$[\mathcal{T}c]_{g_1, \dots, g_n}(w) = \prod_{i=0}^n (c_{g_1, \dots, g_i, w^{g_1 \dots g_i}, g_{i+1}, \dots, g_n})^{(-1)^{n-i}}. \quad (5.27)$$

For cocycles  $\beta$ ,  $\alpha$  and  $\omega$  of orders 1, 2 and 3, we have

$$[\mathcal{T}\beta](w) = \beta_w, \quad [\mathcal{T}\alpha]_g(w) = \frac{\alpha_{g, w^g}}{\alpha_{w, g}}, \quad [\mathcal{T}\omega]_{g, h}(w) = \frac{\omega_{w, g, h} \omega_{g, h, w^{gh}}}{\omega_{g, w^g, h}}. \quad (5.28)$$

The transgression map induces a morphism of complexes since it fulfills  $\mathcal{T} \circ \delta = \tilde{\delta} \circ \mathcal{T}$ . Therefore, the image of an  $(n+1)$ -cocycle in  $C$  is an  $n$ -cocycle in  $\tilde{C}$ . In particular, the 3-cocycle  $\omega$  is transgressed into a 2-cocycle on functions of the winding, which allows to interpret the product law (3.130) of stringy magnetic translations as a projective representation.

The twist of the algebra  $\mathcal{D}^\omega(\mathbb{K}G)$  by the 3-cocycle  $\omega_{g, h, k}$  has the elements  $\mathcal{P}$  and  $\mathcal{Q}$  as a consequence. Thus, one is tempted to understand the twist that produces the quasi-structure as the twist by a general 2-cocycle, as it is the case for the twist of a group leading to a projective multiplication. For the Hopf algebra, the twist changes the multiplication and the comultiplication at the same time, caused by a 3-cocycle. Indeed, the consistency of the quasi-Hopf algebra structure implies that the phases  $\mathcal{P}$  and  $\mathcal{Q}$  obey the following equations

$$\begin{cases} \mathcal{P}_u^{g, h} \mathcal{P}_u^{gh, k} = \mathcal{P}_u^{g, hk} \mathcal{P}_u^{h, k}, \\ \mathcal{P}_u^{g, h} \mathcal{P}_v^{g, h} \mathcal{Q}_{u, v}^g \mathcal{Q}_{u^g, v^g}^h = \mathcal{P}_{uv}^{g, h} \mathcal{Q}_{u, v}^{gh}, \\ \mathcal{Q}_{u, v}^g \mathcal{Q}_{uv, w}^g \omega_{u^g, v^g, w^g} = \mathcal{Q}_{v, w}^g \mathcal{Q}_{u, vw}^g \omega_{u, v, w}. \end{cases} \quad (5.29)$$

The first equation expresses the associativity of the product, this is nothing but (3.129). The second one ensures the compatibility of the product and the coproduct (the coproduct is an algebra morphism) and the last one is the quasi-coassociativity of the coproduct, i.e. (5.23). Using the group coboundary  $\delta$  for the windings  $u, v, w, \dots$  and the twisted group coboundary  $\tilde{\delta}$  for  $g, h, k, \dots$ , with its extra action by conjugation on the windings for its first factor, these

---

\*Just a short cohomological remark about the appearance of  $\mathcal{P}$  and  $\mathcal{Q}$  as a twist of  $\mathcal{D}(\mathbb{K}G)$ .

equations read

$$\left\{ \begin{array}{l} (\tilde{\delta}\mathcal{P})_u^{g,h,k} = 1, \\ (\tilde{\delta}\mathcal{Q})_{u,v}^{g,h} (\delta\mathcal{P})_{u,v}^{g,h} = 1, \\ (\delta\mathcal{Q})_{u,v,w}^g \left( (\tilde{\delta}\omega)_{u,v,w}^g \right)^{-1} = 1. \end{array} \right. \quad (5.30)$$

Together with  $(\delta\omega)_{u,v,w} = 1$ , these equations simply stipulate that  $(\mathcal{P}_u^{g,h}, \mathcal{Q}_{u,v}^g, \omega_{u,v,w})$  is a 2-cocycle in a bicomplex constructed out of  $\delta$  and  $\tilde{\delta}$ .

## § 5.4 QUASI COASSOCIATIVITY

From chapter 4 we know that the occurrence of the coproduct in the action on the tensor product is natural in the theory of quasi Hopf algebras  $\mathcal{A}$ , i.e. one can construct an  $\mathcal{A}$ -module structure on the tensor product of two  $\mathcal{A}$ -modules by taking two representations  $\varrho_1$  and  $\varrho_2$  and building a new one

$$(\varrho_1 \otimes \varrho_2) \circ \Delta \quad (5.31)$$

with the aid of the coproduct. This is exactly what happens for strings in a background 3-form  $H$ : the representation acting on  $\mathcal{H}_v \otimes \mathcal{H}_w$  is nothing but the tensor product of the representations on  $\mathcal{H}_v$  and on  $\mathcal{H}_w$ , but with the tensor product defined using the coproduct rule (5.31).

It is also interesting to analyze if the quasi-coassociativity of the algebra has a counterpart interpreted in terms of magnetic amplitudes. As explained in section 4.6, the Drinfel'd associator gives an associativity constraint on the tensor category of representations. Recall that quasi-coassociativity (4.16) reads

$$(\text{id} \otimes \Delta) \circ \Delta = \Omega((\Delta \otimes \text{id}) \circ \Delta) \Omega^{-1}, \quad (5.32)$$

where  $\Omega$  is the Drinfel'd associator (4.49),

$$\Omega = \sum_{u,v,w} \omega_{u,v,w}^{-1} T_{1G}^u \otimes T_{1G}^v \otimes T_{1G}^w. \quad (5.33)$$

This means that, on the level of the representation of the algebra, one has to distinguish between different parenthesisings of the tensor products

$$(\varrho_1 \otimes \varrho_2) \otimes \varrho_3 \xrightarrow{\Omega} \varrho_1 \otimes (\varrho_2 \otimes \varrho_3), \quad (5.34)$$

where these two representations are intertwined by  $\Omega$  due to equation (4.56). In our case,  $\Omega$  is central and therefore disappears from 5.32, however, on the level of the category, the extra phase stays where it is.

Can this be viewed in terms of our amplitudes? In fact, the failure of associativity is very natural from the point of view of the magnetic amplitudes. Consider the process in which one string of winding  $uvw$  decays into three of windings  $u$ ,  $v$  and  $w$ . Such a process can happen in two different ways: 1) A first decomposition of a string of winding  $uvw$  into  $uv$  and  $w$  and

then a splitting of the first into  $u$  and  $v$ . 2) The first decomposition produces  $u$  and  $vw$ , a second one produces  $v$  and  $w$  for the second string. These are the two possibilities for  $\Delta^2$ . In the language of pairs of pants, this arises from the composition of two pairs of pants in the two different ways, like in figure 5.3. Due to the different cut, the amplitudes will not

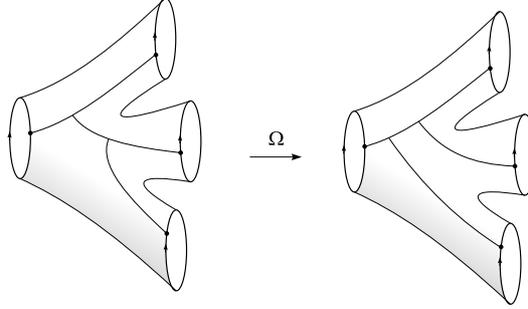

Figure 5.3: Two different cuts related by the associator.

exactly give the same contribution. To compare the two amplitudes, it is useful to apply the relation  $\mathcal{D}\Phi_{g,h} = g^* \mathbf{A}_h - \mathbf{A}_{gh} + \mathbf{A}_g$  in such a way that the two branching points of the cut come together. However, they cannot pass through each other and they always remain in the same order. The 'fine structure' of a triple branching point for the  $1 \rightarrow 3$  decay is depicted in figure 5.4. The two amplitudes coincide except that the branching yields  $[\Phi_{uv,w}^{-1} \Phi_{u,v}^{-1}]_\alpha$  for the first and  $[u^* \Phi_{v,w}^{-1} \Phi_{u,vw}^{-1}]_\alpha$  for the second, with  $\alpha$  being the index of the open set used to cover the branching point (which is ' $x$ ' and not ' $t$ ' just in the figure). The order of branchings must always be preserved, which is represented by the triangles that are attached to each other's edges. Each triangle corresponds to a factor  $\Phi_{u,v}^{-1}$  depending on the winding that belongs to the two edges that point into the direction of disintegration.

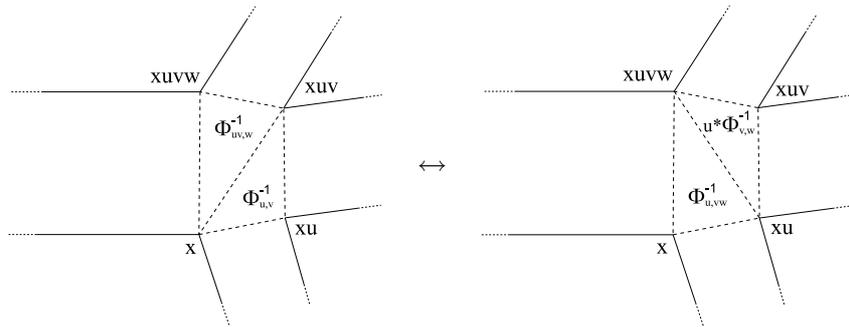

Figure 5.4: The fine structure of the branching point, with all  $\Phi^{-1}$ 's evaluated at  $x$ .

Notice the combination of  $\Phi$ 's: This is nothing but the last line in (3.41), i.e. the usual relation between the 3-cocycle and  $\Phi$ . Thus, the second amplitude simply differs from the first one by the phase factor  $\omega_{u,v,w}$ . This is in perfect agreement with the quasi category point of view, where the pattern of splittings implies that the first process reads

$$\mathcal{H}_{uvw} \rightarrow \mathcal{H}_{uv} \otimes \mathcal{H}_w \rightarrow (\mathcal{H}_u \otimes \mathcal{H}_v) \otimes \mathcal{H}_w, \tag{5.35}$$

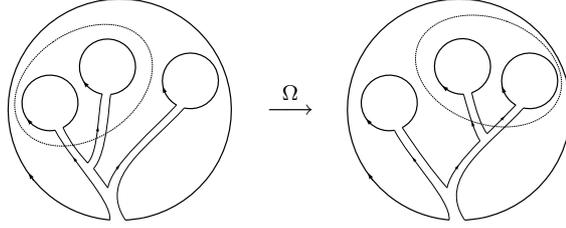

Figure 5.5: Quasi-associativity on the states.

whereas the second is

$$\mathcal{H}_{uvw} \rightarrow \mathcal{H}_u \otimes \mathcal{H}_{vw} \rightarrow \mathcal{H}_u \otimes (\mathcal{H}_v \otimes \mathcal{H}_w). \quad (5.36)$$

The two processes end in two different tensor products, differing only by their parenthesisings. This statement is illustrated in figure 5.5, where we indicated the different parenthesisings on the Hilbert spaces by the finely drawn ellipses encircling the corresponding states. Indeed, the phase difference of the two amplitudes corresponds to the Drinfel'd associator  $\Omega$ ! Interpreting the spaces  $\mathcal{H}$  as objects of the tensor category, and therefore as modules over the algebra  $\mathcal{D}^\omega(\mathbb{K}G)$ , the Drinfel'd associator switches the parenthesisings according to equation (4.56). Thus what is derived here as a consequence of gauge invariance has a deep interpretation in terms of the representation theory of the underlying Hopf algebra.

It is compatible with the action of magnetic translations, in the sense that they commute with the switching of brackets. Recall that a magnetic translation on a 3-fold tensor product acts depending on the module as

$$\mathcal{Q}_{uv,w}^g \mathcal{Q}_{u,v}^g T_g^u \otimes T_g^v \otimes T_g^w : (\mathcal{H}_{u^g} \otimes \mathcal{H}_{v^g}) \otimes \mathcal{H}_{w^g} \rightarrow (\mathcal{H}_u \otimes \mathcal{H}_v) \otimes \mathcal{H}_w \quad (5.37)$$

for the first possibility of parenthesisings, and for the second

$$\mathcal{Q}_{u,vw}^g \mathcal{Q}_{v,w}^g T_g^u \otimes T_g^v \otimes T_g^w : \mathcal{H}_{u^g} \otimes (\mathcal{H}_{v^g} \otimes \mathcal{H}_{w^g}) \rightarrow \mathcal{H}_u \otimes (\mathcal{H}_v \otimes \mathcal{H}_w). \quad (5.38)$$

One can then use relation (5.23) to obtain the commutation of the corresponding actions.

A similar result holds for more general amplitudes: the pattern of interactions involved selects the parenthesisings of the Hilbert spaces appearing on the boundary due to the various possibilities of  $\Delta^N$ . This is particularly clear if one considers processes in which one string can decay into  $n$  strings, i.e. processes of the form  $K^{1 \rightarrow N}$ . The branching of the cut yields a tree that encodes all the information on the parenthesisings to be used. The choice made for intermediate states is irrelevant since changing their parenthesisings always produce two phases that cancel. Any change in the parenthesisings can be implemented by successive applications of the associator that moves branches of the tree from one side of the corresponding branching point to the other side. Using MacLane's coherence theorem [39], the cocycle condition on  $\omega$  implies that any sequence of associators between two fixed parenthesisings always yields the same phase. For the branching point, MacLane's coherence theorem is presented by the pentagon from category theory (4.54) and is depicted in figure 5.6. It is equivalent to relation (4.18). Figure 5.6 can directly be compared to (4.54) by simply translating the triangles attached to each other and the indicated tree structure to the corresponding structure of brackets.

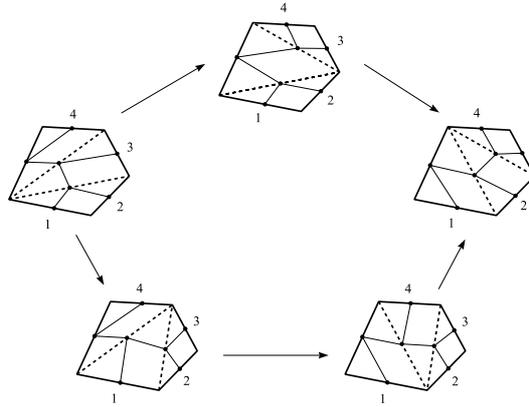

Figure 5.6: The pentagon with branching points and its tree structure.

### § 5.5 LARGE DIFFEOMORPHISMS AND MAPPING CLASS GROUP

A homotopic change of the cut corresponds to a diffeomorphism of the surface  $\mathcal{S}$  that lies in the connected component of the identity diffeomorphism. As already stated, such transformations do not alter the outcome of the amplitude of the process. However, there are *large diffeomorphisms* that transform the cut into a different homotopy class. In general, the structure of self-homeomorphisms of any surface up to homotopy is known as the *mapping class group* [44] of the surface, which is isomorphic to the automorphism group of the fundamental group. More precisely, take a topological space  $\mathcal{M}$  and denote by  $\text{Homeo}(\mathcal{M})$  its self-homeomorphisms. By  $\text{Homeo}_{\text{id}}(\mathcal{M})$  denote the homeomorphisms homotopically connected to the identity homeomorphism. Then, the mapping class group  $\text{MCG}(\mathcal{M})$  of  $\mathcal{M}$  is given by the short exact sequence

$$1 \rightarrow \text{Homeo}_{\text{id}}(\mathcal{M}) \rightarrow \text{Homeo}(\mathcal{M}) \rightarrow \text{MCG}(\mathcal{M}) \rightarrow 1, \quad (5.39)$$

i.e. the self-homeomorphisms up to homotopy. For example, a 2-torus  $\mathbb{T}^2$  has  $\text{SL}(2, \mathbb{Z})$  as its group of large diffeomorphisms.

In this section it is shown that the mapping class group of surfaces describing tree level decays is generated by two elementary diffeomorphisms, namely the Dehn twist of the cylinder and the braiding of a pair of pants. The braiding should arise naturally in the framework of our algebra, since it is a braided Hopf algebra. The representation space then carries a braiding as well, interpreted as the map (4.58) that flips two objects of the tensor category since the braid must be constructed from the  $\mathcal{R}$ -matrix. To begin, consider all the tree level amplitudes describing the decay of one string into  $N$  others, i.e. processes of the form  $K^{1 \rightarrow N}$ . Any tree level amplitude can be obtained by gluing cylinders and pants together. The resulting surface has a mapping class group whose generators can be constructed using the quasi-quantum group  $\mathcal{D}^\omega(\mathbb{K}G)$ .

### DEHN TWIST OF THE CYLINDER

In our context, the Dehn twist of the cylinder changes the cut by turning it once around the cylinder during propagation. The magnetic translations  $T_g^w$  allow us to understand the transformation of the cylinder amplitude under this large diffeomorphism. Recall that the cylinder amplitude reads

$$\mathcal{A}_{JI}[\varphi] = \left[ e^{i \int_{\Sigma} \mathbf{B} + i \int_x^y \mathbf{A}_w} \right]_{JI}. \quad (5.40)$$

If we act with a Dehn twist on the cylinder, then the cut  $c$  is changed into  $c'$  which induces a corresponding change  $\varphi \rightarrow \varphi'$ . In the target space  $\mathcal{M}$ , the transformation yields a new world-sheet  $\Sigma'$  and the image of the new cut joins  $x$  to  $y \cdot w$ , as can be seen in figure 5.7. Therefore, we get another amplitude  $\mathcal{A}_{JI}[\varphi']$  and the ratio of the two amplitudes turns out

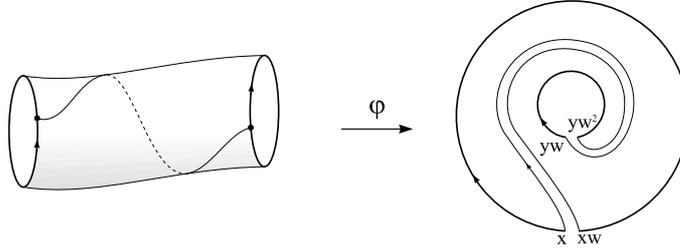

Figure 5.7: The Dehn twist of the cylinder.

to be

$$\frac{\mathcal{A}_{JI}[\varphi']}{\mathcal{A}_{JI}[\varphi]} = \left[ e^{i \int_{\Sigma''} (w^* \mathbf{B} - \mathbf{B}) + i \int_x^{yw} \mathbf{A}_w - i \int_x^y \mathbf{A}_w} \right]_{JI}. \quad (5.41)$$

This follows from the fact that  $\Sigma$  and  $\Sigma'$  only differ by the shaded surface  $\Sigma''$  (see figure 5.8),

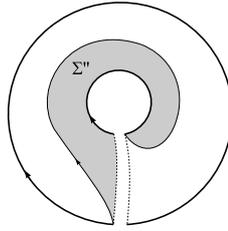

Figure 5.8: The surface  $\Sigma''$ .

whose contribution is lifted by  $w$  in  $\mathcal{A}_{JI}[\varphi']$  with respect to its contribution to  $\mathcal{A}_{JI}[\varphi]$ . After using  $w^* \mathbf{B} = \mathbf{B} + \mathcal{D} \mathbf{A}_w$  in the explicit expression of the ratio, only boundary terms remain. Two of them cancel with the integrals along the cut and we are left with

$$\frac{\mathcal{A}_{JI}[\varphi']}{\mathcal{A}_{JI}[\varphi]} = \left[ e^{i \int_y^{yw} \mathbf{A}_w} \right]_J. \quad (5.42)$$

Now recall the translation by  $w$  of a string  $Y$  with winding  $w$  which is

$$[T_w^w \Psi]_J(Y) = \left[ e^{-i \int_y^{yw} \mathbf{A}_w} \right]_J \Psi_J(Y), \quad (5.43)$$

because  $\Gamma_{w,w} = 1$ . Thus, the action of the Dehn twist simply amounts to translating the outgoing string by its own winding. Starting with the twisted cylinder one constructs the twisted propagator  $K'$  and the comparison of the magnetic amplitudes for  $\varphi$  and  $\varphi'$  shows that

$$T_w^w K_w^{1 \rightarrow 1} = K_w^{1 \rightarrow 1}. \tag{5.44}$$

Because of the commutation of  $T_w^w$  and  $K_w$ , the twist can as well be implemented on the incoming string.

**BRAIDING OF THE PAIR OF PANTS**

Consider now the large diffeomorphism of the pant that induces a braiding of the cut as in figure 5.9. The braiding induces the change  $\varphi \rightarrow \varphi'$  associated to the new amplitude

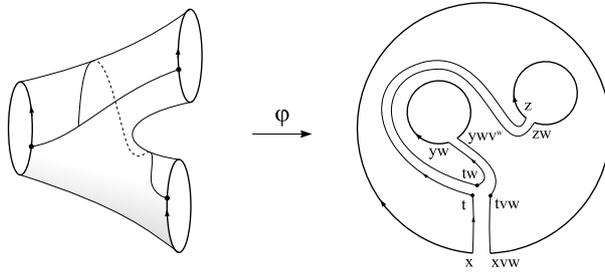

Figure 5.9: The braiding.

$$\mathcal{A}_{KJ,I}[\varphi'] = \left[ e^{i \int_{\Sigma'} \mathbf{B} + i \int_x^t \mathbf{A}_{vw} + i \int_{tw}^{yw} \mathbf{A}_{v^w} + i \int_t^z \mathbf{A}_w} \Phi_{w,v^w}^{-1}(t) \right]_{KJ,I} \tag{5.45}$$

where the line integrals involve the cuts in figure 5.9. The new amplitude  $\mathcal{A}_{KJ,I}[\varphi']$  differs from the old one  $\mathcal{A}_{JK,I}[\varphi]$  given in (5.8) by the ordering of the windings ( $(v, w) \rightarrow (w, v^w)$ ) and by the shaded surface  $\Sigma''$  (see figure 5.10) which is a) removed from  $\Sigma$ , lifted by  $w$  and b) reinserted into  $\Sigma$  to form  $\Sigma'$ . To indicate the order of the windings, note that the indices  $JK \leftrightarrow KJ$  have swapped. As before for the unbraided pair of pants, we assume the name of the open set that covers the branching point  $t$  as  $\mathcal{U}_\alpha$ . The ratio of the two amplitudes can

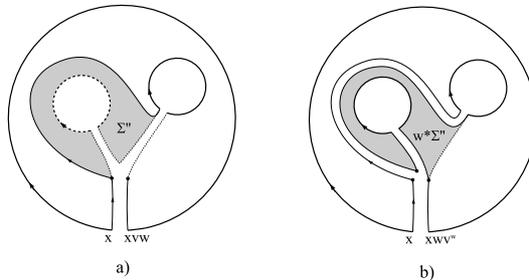

Figure 5.10: The surface  $\Sigma''$  and its lift by  $w$ .

then be calculated to be

$$\begin{aligned} \frac{\mathcal{A}_{KJ,I}[\varphi']}{\mathcal{A}_{JK,I}[\varphi]} &= [\Gamma_{v,w}^{-1}(t)]_{\alpha} \left[ e^{i \int_t^y w^* \mathbf{A}_{vw} - \mathbf{A}_v - v^* \mathbf{A}_w + \mathbf{A}_w} \right]_{J,\alpha} \left[ e^{i \int_y^{yv} \mathbf{A}_w} \right]_J \\ &= \left[ \Gamma_{v,w}^{-1}(y) e^{i \int_y^{yv} \mathbf{A}_w} \right]_J \end{aligned} \quad (5.46)$$

which matches exactly the phase that appears in the operator  $T_w^v$ . To obtain this result, use  $\mathcal{D}\mathbf{A}_w = w^* \mathbf{B} - \mathbf{B}$  and

$$\left[ e^{i \int_{\Sigma''} \mathcal{D}\mathbf{A}_w} \right] = \left[ e^{i \int_{\partial \Sigma''} \mathbf{A}_w} \right]. \quad (5.47)$$

Therefore, the braiding of the pants induces a change of the magnetic amplitude  $\mathcal{A}_{JK,I}[\varphi] \rightarrow \mathcal{A}_{KJ,I}[\varphi']$  that corresponds to the braid group action derived from the general theory of quasi-triangular Hopf algebras.

To understand this phase in terms of the braiding of the algebra, recall that the algebra comes with the  $\mathcal{R}$ -matrix (4.51)

$$\mathcal{R} = \sum_{v,w} T_{1_G}^w \otimes T_w^v. \quad (5.48)$$

When acting on a tensor product of two states, it leaves the first string invariant (due to the  $T_{1_G}$  factor) and translates the second by the winding of the first. The corresponding action of the braid group with two strands  $\mathcal{B}_2$  is defined by its generator  $\sigma = \tau \circ \mathcal{R}$ , where  $\tau$  is the flip, see equation (4.58) in section 4.7. If we restrict ourselves to strings with fixed windings, this induces a map

$$\sigma_{v,w} : \mathcal{H}_w \otimes \mathcal{H}_{vw} \rightarrow \mathcal{H}_v \otimes \mathcal{H}_w \quad (5.49)$$

defined by  $\sigma_{v,w} = \tau \circ (\text{id} \otimes T_w^v)$ . Then, the same reasoning as for the twist of the cylinder applies: The braiding yields another pant  $\mathcal{S}'$  whose field  $\varphi'$  defines a propagator  $K'$  related to  $K$  by

$$\sigma_{v,w} K_{w,vw}^{1 \rightarrow 2} = K_{v,w}^{1 \rightarrow 2}, \quad (5.50)$$

or more precisely,

$$\begin{array}{ccc} \mathcal{H}_{vw} & \xrightarrow{K_{v,w}^{1 \rightarrow 2}} & \mathcal{H}_v \otimes \mathcal{H}_w \\ & \searrow^{K_{w,vw}^{1 \rightarrow 2}} & \uparrow \sigma_{v,w} \\ & & \mathcal{H}_w \otimes \mathcal{H}_{vw} \end{array} \quad (5.51)$$

Note that thanks to the quasi-triangularity condition  $\tau \circ \Delta = \mathcal{R} \Delta \mathcal{R}^{-1}$  the braid group action commutes with the stringy magnetic translations, provided the latter act on tensor products using the coproduct rule.

When more than two factors are involved and  $\omega$  is trivial, i.e. the Drinfel'd associator  $\omega$  is also trivial, the exchange of the factors is governed by the braid group with  $N$  strands  $\mathcal{B}_N$ . And as already mentioned the latter is generated by the operators  $\sigma_i = \tau \circ \mathcal{R}$  that exchange the two adjacent factors located at the  $i^{\text{th}}$  and  $(i+1)^{\text{th}}$  place in the tensor product. From equations (4.59) and (4.60), the defining relations of  $\mathcal{B}_N$  hold thanks to the Yang-Baxter

equation  $\mathcal{R}_{12}\mathcal{R}_{13}\mathcal{R}_{23} = \mathcal{R}_{23}\mathcal{R}_{13}\mathcal{R}_{12}$ . If  $\omega$  is non-trivial, the braid group action still makes sense, but some care is required because of the lack of associativity of the tensor product. For the action of  $\mathcal{B}_N$  defined using its generators  $\sigma_i$  one has to make a repeated use of the associator to make sure that the parentheses do not separate the two factors being exchanged. Therefore, when composing  $\sigma_i$  and  $\sigma_j$ , one has to insert suitable representations of the associator as it was shown in (4.62)-(4.64). The defining relations of the braid group (4.15) then follow from the quasi Yang-Baxter equation (4.22), which is a modification of the Yang-Baxter equation (4.14) in order to take into account the Drinfel'd associator.

As a result, the operators  $T$  generate the Dehn twists and implement the braidings of pants. By gluing cylinders and pants, one arrives at the mapping class group generated by the twists and braids of cylinders and pants, forming tree-level amplitudes with one incoming and  $N$  outgoing strings.

### BRAIDED OPERAD STRUCTURE

If the windings match, an amplitude for a process  $1 \rightarrow N$  can be glued together with  $N$  amplitudes for  $1 \rightarrow n_i$ ,  $i = 1, \dots, N$ , so that the result is an amplitude pertaining to the process  $1 \rightarrow \sum_{i=1}^N n_i$ . In figure 5.11, one can see a simple example of gluing three amplitudes  $1 \rightarrow 1$ ,  $1 \rightarrow 3$  and  $1 \rightarrow 2$ , into the corresponding slots of a first one  $1 \rightarrow 3$ . More generally,

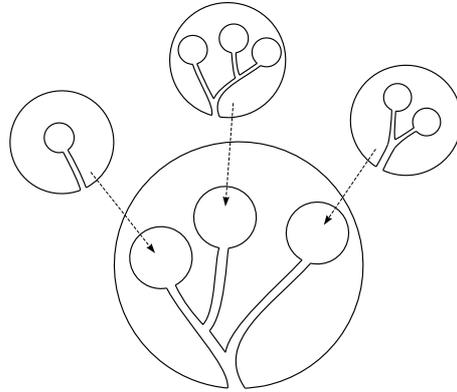

Figure 5.11: The braided operad structure of tree level amplitudes.

denoting by  $\Delta_k$  the set of amplitudes with  $k$  outgoing strings, the gluings define composition laws

$$\gamma_N : \Delta_N \times \Delta_{n_1} \times \cdots \times \Delta_{n_N} \rightarrow \Delta_{n_1 + \cdots + n_N}. \quad (5.52)$$

The sets  $\Delta_k$  carry an obvious representation of the braid group  $\mathcal{B}_k$ , with generators  $\sigma_i$  acting in the same manner as for the pair of pants. The action is compatible with the gluing, in the sense that braiding before gluing is equivalent to braiding after gluing. A composition rule like (5.52) defines the *structure map* of a special mathematical object, called an *operad*. To be compatible with an operad's full definition, the structure map has to be associative (which

is obviously the case), and has to respect an action of a symmetry group  $\mathfrak{S}_N$ ,

$$\begin{aligned} i) \quad & \gamma_N(\Delta_N \cdot \sigma; \Delta_{n_1}, \dots, \Delta_{n_N}) = \gamma_N(\Delta_N; \Delta_{n_{\sigma^{-1}(1)}}, \dots, \Delta_{n_{\sigma^{-1}(N)}}) \cdot \sigma(n_1, \dots, n_N) \\ ii) \quad & \gamma_N(\Delta_N; \Delta_{n_1} \cdot \tau_1, \dots, \Delta_{n_N} \cdot \tau_N) = \gamma_N(\Delta_N \cdot \sigma; \Delta_{n_1}, \dots, \Delta_{n_N}) \cdot (\tau_1 \oplus \dots \oplus \tau_N) \end{aligned} \quad (5.53)$$

with  $\sigma \in \mathfrak{S}_N$ . The group  $\mathfrak{S}_N$  can be the permutation group  $(\Sigma_N)$  or, in the case of a *braided operad*, the braid group  $\mathfrak{S}_N = \mathcal{B}_N$  [45]. The notation  $\sigma(n_1, \dots, n_N)$  means an element in  $\mathfrak{S}_{\sum n_k}$  which is obtained from  $\sigma$  by replacing its  $i^{\text{th}}$  strand by  $n_i$  parallel strands.  $\oplus \tau_k$  is the block direct sum of the braids  $\tau_k \in \mathfrak{S}_{n_k}$ . These relations are simply the manifestation of the commutability of 'gluing' and 'braiding', which is fulfilled in our case of the amplitudes.

## § 5.6 LOOP AMPLITUDES AND MODULAR INVARIANCE OF THE TORUS<sup>†</sup>

As the simplest example of a loop amplitude, we want to consider the torus. As an amplitude, it can be constructed from the cylinder amplitude (3.72). For that, by acting with a stringy magnetic translation on one of the boundaries, it can be glued together to form the torus. The procedure is pictured in figure 5.12. The amplitude can be written as

$$\mathcal{A}[\varphi] = \left[ e^{i \int_{\Sigma} \mathbf{B} + \int_x^{x+h} \mathbf{A}_g - i \int_x^{x+g} \mathbf{A}_h} \Gamma_{g,h}(x) \right], \quad (5.54)$$

and corresponds to a cylinder of winding  $g$  and 'length'  $h$ .  $g$  and  $h$  are two commuting elements of  $G$  and the extra phase  $\Upsilon_h^g$  corresponding to the translation by  $h$  has been added. This amplitude should be thought of as being inserted into a functional integral contributing to the trace of  $(T_h^g)K_g$ , which is further summed over  $g$  and  $h$  to provide the torus partition function. Because there is no boundary, it does not depend at all on the triangulation used in its computation. Nevertheless, we write it into brackets to remember that its actual definition relies on some triangulation. Besides, it is invariant under homotopic changes of the cut, diffeomorphisms connected to the identity and gauge transformations. These properties are valid whether  $\omega$  is trivial or not.

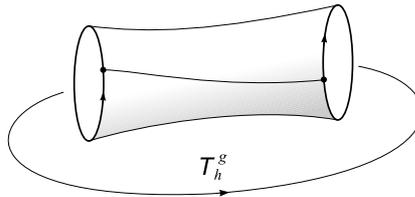

Figure 5.12: Obtaining a torus amplitude from a cylinder.

The problem arises if one analyzes its behavior under a global magnetic translation. In this case, the amplitude receives a phase which can be written solely in terms of the 3-cocycle  $\omega$ , i.e. under a global translation  $\varphi \rightarrow \varphi \cdot k$ , the amplitude changes according to

$$\mathcal{A}[\varphi \cdot k] = \frac{\omega_{k,h^k,g^k} \omega_{g,k,h^k} \omega_{h,g,k}}{\omega_{k,g^k,h^k} \omega_{g,h,k} \omega_{h,k,g^k}} \mathcal{A}[\varphi] = \frac{\mathcal{Q}_{h,g}^k}{\mathcal{Q}_{g,h}^k} \mathcal{A}[\varphi]. \quad (5.55)$$

<sup>†</sup>In lack of an explanation, this section should rather be viewed as an observation.

Such a phase is called a *global anomaly* which is an anomaly that violates a large gauge transformation. It is interesting to note that, for a commutative group, this phase matches exactly the topological action for a 3-torus in finite group topological gauge theory derived by Witten and Dijkgraaf [46]. Using the relation (3.130) and its geometrical interpretation given in figure 3.8, this combination of 3-cocycles can be understood as a way of chopping the parallelepiped build out of  $g$ ,  $h$  and  $k$  into six tetrahedra.

In string theory, one requirement for vanishing global anomalies is modular invariance of 1-loop diagrams. For the torus, the *modular group* is the group of large diffeomorphisms  $SL(2, \mathbb{Z})$ , namely diffeomorphisms that are not continuously connected to the identity diffeomorphism as analyzed in the last subsection. It is generated by two modular transformations, conventionally denoted by  $S$  and  $T$ , that act on the cut in the following sense:

$$T: \begin{cases} g \rightarrow gh \\ h \rightarrow h \end{cases} \quad S: \begin{cases} g \rightarrow h^{-1} \\ h \rightarrow g \end{cases}. \quad (5.56)$$

Here, the amplitude changes by extra phases depending on the 3-cocycle  $\omega$  as well. More precisely,  $T$  acts as

$$\mathcal{A}[\varphi] \rightarrow \mathcal{A}[T\varphi] = \omega_{h,g,h} \mathcal{A}[\varphi] \quad (5.57)$$

and  $S$  as

$$\mathcal{A}[\varphi] \rightarrow \mathcal{A}[S\varphi] = \frac{\omega_{h,g,h^{-1}}}{\omega_{h,h^{-1},g} \omega_{g,h,h^{-1}}} \mathcal{A}[\varphi]. \quad (5.58)$$

This behavior of the torus amplitude and of all the previous tree level amplitudes under global translations and large diffeomorphisms yields relations that are very similar to the ones in [47], derived in the context of CFT. In fact, this last paper deals with algebraic properties of the conformal blocks in an orbifold theory with group  $G$ . It is rather amazing that the formulae pertaining to the transformation of conformal blocks are so close to the ones derived here for magnetic amplitudes, especially because our derivation relies solely on the geometry of the Kalb-Ramond field and does not refer to CFT.

More generally, we expect all loop amplitudes to be flawed by these global anomalies under translation and global diffeomorphisms. This is due to the insertion of the gauge fields  $\mathbf{A}_g$  and  $\Phi_{g,h}$  along the internal cuts, which is required by gauge invariance. Any global change induces a change of these gauge fields which is only partially compensated along the two boundaries of the cut. This is another clue that the orbifold theory is consistent only for trivial  $\omega$ . If we assume that  $\omega$  is trivial, then one can construct the magnetic amplitude for an arbitrary surface as follows. At the tree level, we construct the amplitude by gluing together cylinders and pairs of pants as given in (3.62) and (5.8). For the latter it is crucial to insert a factor of  $\Phi_{v,w}^{-1}$  when a string of winding  $vw$  splits into two strings of windings  $v$  and  $w$  and  $\Phi_{v,w}$  when they join. Loop amplitudes are obtained by further gluing together some incoming and outgoing strings using the operators  $T_g^w$ . At the level of magnetic amplitudes, this translates into insertions of the phases  $\Upsilon_g^w$  when a string of winding  $w$  is glued with its lift by  $g$ . Then, the triviality of  $\omega$  ensures that the amplitude is independent of the patterns of joining and splitting, as well as under global translations and large diffeomorphisms.

### § 5.7 DISCRETE TORSION AND DRINFEL'D TWIST

Originally, *discrete torsion* was introduced [48] as an additional degree of freedom appearing as complex weights  $\epsilon_{g,h} \in U(1)$ ,  $g, h \in G$ , for orbifold amplitudes. Constraints for modular invariance of 1-loop and higher partition functions of a closed string on the orbifold  $\mathcal{M}/G$  then lead to a set of axioms,

$$\begin{cases} \epsilon_{w,gh} &= \epsilon_{w,g}\epsilon_{w,h} \\ \epsilon_{g,w} &= \epsilon_{w,g}^{-1} \\ \epsilon_{g,g} &= 1 \end{cases}, \quad (5.59)$$

if one restricts oneself to mutually commuting elements  $w, g, h \in G$ . Its geometrical nature has been unveiled in [36, 38], showing that it corresponds to an ambiguity appearing in the lift of the orbifold group action to the fields. Due to global anomalies we have already seen that for the orbifold to be existent, the 3-cocycle  $\omega_{g,h,k}$  must be assumed to be trivial. However, let us analyze if discrete torsion has a pendant in our context of the Hopf algebra. For that, recall the constant ambiguity in the definition of  $\Phi$  in equation (3.38) and (3.46). The change  $\Phi \rightarrow \Phi' = \Phi\alpha$  with  $\alpha \in \mathcal{T}_{2,0}$ , or with group indices for clarity

$$\Phi_{g,h} \rightarrow \Phi'_{g,h} = \Phi_{g,h}\alpha_{g,h}, \quad (5.60)$$

does not induce a change of  $\omega$  due to its definition  $\omega = \delta\Phi$ , if  $\alpha$  is a group 2-cocycle

$$\alpha_{h,k}\alpha_{g,hk} = \alpha_{gh,k}\alpha_{g,h}. \quad (5.61)$$

Because the operators realizing the stringy magnetic translations  $T_g^w$  defined in (3.114) depend on  $\Phi$  through  $\Gamma$  (see definition (3.101)), the 2-cocycle  $\alpha$  induces the change

$$T_g^w \rightarrow (T')_g^w = \epsilon_{w,g} T_g^w, \quad (5.62)$$

where we set the phase to be equal to the corresponding combination of  $\alpha$ 's,

$$\epsilon_{w,g} = \frac{\alpha_{g,w^g}}{\alpha_{w,g}}. \quad (5.63)$$

If  $\alpha = \delta\beta$  is a coboundary, this simply amounts to multiply the wave functions in  $\mathcal{H}_w$  by the global phase  $\beta_w$ , so that the ambiguity is parametrized by the group cohomology class of  $\alpha$ , i.e.  $H^2(G, U(1))$ .

The magnetic translations  $T_g^w$  and  $(T')_g^w$  thus obey the same multiplication law as given in (3.130), since their product only involves  $\omega$  which is left unchanged by the 2-cocycle  $\alpha_{g,h}$ . Writing the product (3.130) in terms of  $(T')_g^w$  by replacing them with  $T_g^w$  and  $\epsilon_{w,g}$  leads to the identity

$$\epsilon_{w,g}\epsilon_{w^g,h} = \epsilon_{w,gh}, \quad (5.64)$$

that can be checked directly by repeated use of the cocycle condition (5.61). In other words, at fixed  $w$  the application  $g \mapsto \epsilon_{w,g}$  defines a 1-cocycle on the normalizer  $N_w$  of  $w$ . Or, in other words, one finds the relation of discrete torsion (5.59).

For the coproduct, however, there is an extra phase that remains,

$$\Delta((T'_g)^u) = \sum_{vw=u} \left( \frac{\alpha_{v^g, w^g}}{\alpha_{v, w}} \right) \mathcal{Q}_{v, w}^g (T'_g)^v \otimes (T'_g)^w, \quad (5.65)$$

which can easily be computed from the ratio

$$\frac{\epsilon_{v, g} \epsilon_{w, g}}{\epsilon_{vw, g}} = \frac{\alpha_{g, v^g} \alpha_{g, w^g} \alpha_{vw, g}}{\alpha_{v, g} \alpha_{w, g} \alpha_{g, (vw)^g}} = \frac{\alpha_{v^g, w^g}}{\alpha_{v, w}} \quad (5.66)$$

by repeated use of the cocycle relation for  $\alpha$ , namely  $(\delta\alpha)_{v, w, g} = 1$ ,  $(\delta\alpha)_{g, v^g, w^g} = 1$  and  $\delta\alpha_{v, g, w^g} = 1$ . Generally, the change in the coproduct could have been expected since the definition of the coproduct depends on the interaction which involves  $\Phi^{-1}$  as required by invariance under secondary gauge transformations.

But all this is a Drinfel'd twist! Recall it from the equations (4.23). It defines a new coproduct of the form

$$\Delta \rightarrow \Delta_{\mathcal{F}} = \mathcal{F} \Delta \mathcal{F}^{-1}, \quad (5.67)$$

with the element  $\mathcal{F} \in \mathcal{D}^\omega(\mathbb{K}G) \otimes \mathcal{D}^\omega(\mathbb{K}G)$  given by (4.53),

$$\mathcal{F} = \sum_{u, v \in G} \alpha_{u, v}^{-1} T_{1_G}^u \otimes T_{1_G}^v. \quad (5.68)$$

If one computes explicitly the new coproduct  $\mathcal{F} \Delta \mathcal{F}^{-1}$ , one finds exactly the phase  $\alpha_{v^g, w^g} \alpha_{v, w}^{-1}$  from the derivation in (5.65) and (5.66). Therefore, the operation  $T_g^w \rightarrow (T'_g)^w$  corresponds to a Drinfel'd twist of the quasi-quantum group  $\mathcal{D}^\omega$ . By equation (4.25) it also induces a change of the  $\mathcal{R}$ -matrix involved in the braiding, now given by

$$\mathcal{R} \rightarrow \mathcal{R}_{\mathcal{F}} = \mathcal{F}_{21} \mathcal{R} \mathcal{F}_{12}^{-1} = \sum_{v, w \in G} \epsilon_{w, v} T_{1_G}^v \otimes T_v^w, \quad (5.69)$$

but leaves the associator  $\Omega$  invariant because of the cocycle condition (5.61).

In summary, discrete torsion was identified in [36, 38] with an ambiguity in the lift of the orbifold group action to the fields. Since the operators  $T_g^w$  are defined with a subset of these fields, there is an induced ambiguity appearing in the definition of the operators  $T_g^w$  that lift the group action to the twisted states. Then, any two choices  $T_g^w$  and  $(T'_g)^w$  of such operators generate quasi-quantum groups related by a Drinfel'd twist. As already stated, they are equivalent as far as their representations are considered [39].

## § 5.8 ANTIPODE AND COUNIT

To investigate the role played by the counit  $\epsilon$  of the algebra  $\mathcal{D}^\omega(\mathbb{K}G)$ , consider a process  $K^{0 \rightarrow 2}(X \cup Y; -)$ , in which two states are created out of the vacuum. This process can be obtained by gluing the cap (3.7) to the incoming slot of a pair of pants, see figure 5.13. Using the homotopy invariance of the cut, the magnetic amplitude takes the form

$$\mathcal{A}_{IJ, -}[\varphi] = \left[ e^{i \int_{\Sigma} \mathbf{B} + i \int_{xw}^y \mathbf{A}_{w^{-1}} \Phi_{w, w^{-1}}^{-1}(x)} \right]_{IJ, -}. \quad (5.70)$$

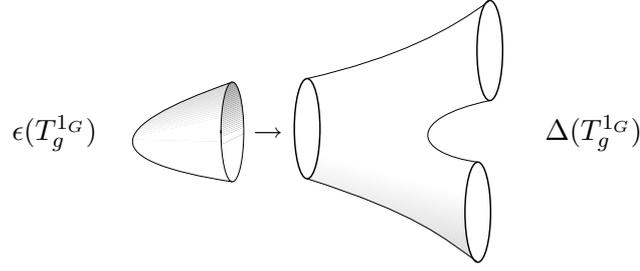

Figure 5.13: A cap is glued to a pant.

Here,  $I$  and  $J$  correspond to the two outgoing states  $X$  and  $Y$ . The notation  $K_{w,w^{-1}}^{0 \rightarrow 2}(X \cup Y; -)$  shall indicate the creation out of the vacuum of two strings with respective winding  $w$  and  $w^{-1}$  as already used for the cap. The amplitude (5.70) can easily be obtained using  $\mathcal{D}\Phi_{w,w^{-1}} = w^* \mathbf{A}_{w^{-1}} + \mathbf{A}_w$  to shift the 'branching point' directly to the position  $x$ , i.e.  $X(0)$ . The commutation of this process with a magnetic translation  $T \in \mathcal{D}^\omega(\mathbb{K}G)$  then reads

$$\Delta(T_g^{1G}) K_{w^g, (w^{-1})^g}^{0 \rightarrow 2} = K_{w, w^{-1}}^{0 \rightarrow 2} \epsilon(T_g^{1G}), \quad (5.71)$$

or in terms of a commutative diagram

$$\begin{array}{ccc} \langle \rangle & \xrightarrow{K_{w, w^{-1}}} & \mathcal{H}_w \otimes \mathcal{H}_{w^{-1}} \\ \epsilon(T) \uparrow & & \uparrow \Delta(T_g^{1G}) \\ \langle \rangle & \xrightarrow{K_{w^g, (w^{-1})^g}} & \mathcal{H}_{w^g} \otimes \mathcal{H}_{(w^{-1})^g} \end{array} \quad (5.72)$$

where  $\langle \rangle$  denotes the vacuum. At the level of matrix elements one has to compare,

$$\Upsilon_g^w(X) \Upsilon_g^{w^{-1}}(Y) K_{w^g, (w^{-1})^g}^{0 \rightarrow 2}(X \cdot g \cup Y \cdot g; -) \leftrightarrow K_{w, w^{-1}}^{0 \rightarrow 2}(X \cup Y; -). \quad (5.73)$$

Indeed,  $\mathcal{D}^\omega(\mathbb{K}G)$  acts trivially on the vacuum, as can be seen by the ratio

$$\frac{\mathcal{A}_{IJ, -}[\varphi \cdot g]}{\mathcal{A}_{IJ, -}[\varphi]} = \left[ \Gamma_{w, g}^{-1}(x) e^{i \int_x^{xw} \mathbf{A}_g} \right]_I \left[ \Gamma_{w^{-1}, g}^{-1}(y) e^{i \int_y^{yw^{-1}} \mathbf{A}_g} \right]_J (\mathcal{Q}_{w, w^{-1}}^g)^{-1}, \quad (5.74)$$

reproducing the two phases  $\Upsilon_g^w(X)$  and  $\Upsilon_g^{w^{-1}}(Y)$  for the two outgoing states and producing the expected factor  $\mathcal{Q}_{w, w^{-1}}^g$  from the coproduct. Therefore, the counit provides the trivial representation.

The similarity between the amplitude (5.70) and that of the cylinder (3.72) suggest some procedure of 'orientation reversing'. Indeed, from the general propagator (5.7), the orientation of the boundaries of the surface  $\varphi(\partial\mathcal{S}) = \partial\Sigma$  encodes which string is incoming and which is outgoing. Outgoing states are in correspondence with the orientation of the world-sheet, and they are interpreted as incoming, if their orientation is reversed. Hence, the surface that corresponds to the process  $K^{0 \rightarrow 2}$  should also contribute to a single string propagation  $K^{1 \rightarrow 1}$ . This suggests the existence of an operator  $\Pi$  from  $\mathcal{H}$  to its dual that changes an outgoing

string to an incoming one. At the level of a wave function, if  $\Psi \in \mathcal{H}_w$ , then one can define  $\Pi\Psi \in \mathcal{H}_{w^{-1}}^*$  by

$$[\Pi\Psi]_{I^*}(X^*) = [\Phi_{w,w^{-1}}(x)]_I \Psi_I(X) \quad (5.75)$$

where  $X^* \in \mathcal{C}_{w^{-1}}$  denotes the string with orientation reversed, i.e. that starts at  $xw$  and ends at  $x$ , and  $I^*$  is the triangulation and assignment with the order reversed. Geometrically,  $\Pi\Psi$  is a section of the dual bundle defined by the transition functions  $G_{I^*J^*}^* = G_{IJ}^{-1}$  and with gauge transformations and holonomies along cylinders defined by the opposite phases. As for the pair of pants, the inclusion of the winding dependent extra phase  $\Phi_{w,w^{-1}}$  is dictated by the requirement of invariance under secondary gauge transformations. In geometrical terms,  $\Pi$  is a line bundle isomorphism induced by the orientation reversing. For the process of a two string state created from the vacuum, this means

$$(\Pi \otimes \text{id}) K_{w,w^{-1}}^{0 \rightarrow 2} = K_{w^{-1}}^{1 \rightarrow 1} \quad (5.76)$$

or at the level of matrix elements,

$$\Phi_{w,w^{-1}}(x) K_{w,w^{-1}}^{0 \rightarrow 2}(X \cup Y; -) = K_{w^{-1}}^{1 \rightarrow 1}(Y; X^*). \quad (5.77)$$

Note that the surface  $\varphi(\mathcal{S})$  contributing to both of the latter processes has the border  $\varphi(\partial\mathcal{S}) = Y \cup X$  which can also be interpreted as  $\varphi(\partial\mathcal{S}) = Y \cup (X^*)^*$ . The same argument holds for the process of the annihilation of two strings,  $K_{w^{-1},w}^{2 \rightarrow 0}(-; X^* \cup Y^*)$  which can be associated to the surface  $\varphi(\partial\mathcal{S}) = (Y^*)^* \cup (X^*)^*$ .

For Hopf algebras  $\mathcal{A}$ , see for example [39, 40, 41], the antipode allows to define the dual of a given representation. Let  $M$  be an  $\mathcal{A}$ -module and  $M^*$  the dual. Then the antipode induces an  $\mathcal{A}$ -module structure on  $M^*$  according to

$$(a \triangleright f)(v) = f(S(a) \triangleright v) \quad , \quad a \in \mathcal{A}, v \in M, f \in M^*. \quad (5.78)$$

In our setting, the antipode ensures the compatibility of the quasi-quantum group action on the string states with the orientation reversing operation. Indeed, if  $\Psi \in \mathcal{H}_w$  and  $\Psi' \in \mathcal{H}_{w^{-1}}$ , then we have

$$[\Pi [T_g^w \Psi]]_{I^*}(X^*) \Psi'_I(X^*) = [\Pi\Psi]_{I^*}(X^* \cdot g) [S(T_g^w) \Psi']_I(X^* \cdot g) \quad (5.79)$$

for any string  $X^* \in \mathcal{C}_{w^{-1}}$ , with

$$S(T_g^w) = \frac{\omega_{g,(w^{-1})^g,g^{-1}}}{\omega_{w^{-1},g,g^{-1}} \omega_{g,g^{-1},w^{-1}}} \frac{\omega_{w,g,(w^{-1})^g}}{\omega_{w,w^{-1},g} \omega_{g,w^g,(w^{-1})^g}} T_{g^{-1}}^{(w^{-1})^g} \quad (5.80)$$

the antipode of  $\mathcal{D}^\omega(\mathbb{K}G)$ , or written as in (4.52),

$$S(T_g^w) = (\mathcal{P}_{w^{-1}}^{g,g^{-1}})^{-1} (\mathcal{Q}_{w,w^{-1}}^g)^{-1} T_{g^{-1}}^{(w^{-1})^g} : \mathcal{H}_{w^{-1}} \rightarrow \mathcal{H}_{(w^{-1})^g}. \quad (5.81)$$

To see that (5.79) is true, just apply the definitions of the appearing operators, i.e. on the LHS of (5.79)  $\mathcal{H}_{w^{-1}}^* \ni [\Pi[T_g^w \Psi]]$

$$[\Pi[T_g^w \Psi]]_{I^*}(X^*) = [\Phi_{w,w^{-1}}(x) \Gamma_{w,g}(x) e^{-i \int_x^{xw} \mathbf{A}_g}]_I \Psi_I(X). \quad (5.82)$$

On the RHS, there is for  $\mathcal{H}_{(w^{-1})^g} \ni [\Pi\Psi]$

$$[\Pi\Psi]_{I^*}(X^* \cdot g) = [g^* \Phi_{w^g, (w^{-1})^g}(x)]_I \Psi_I(X \cdot g) \quad (5.83)$$

as well as for the term  $\mathcal{H}_{(w^{-1})^g} \ni [T_{g^{-1}}^{(w^{-1})^g} \Psi']$ ,

$$\left[ T_{g^{-1}}^{(w^{-1})^g} \Psi' \right]_I (X^* \cdot g) = \left[ (wg)^* \Gamma_{(w^{-1})^g, g^{-1}}(x) e^{-i \int_{xw}^x g^* \mathbf{A}_{g^{-1}}} \right]_I \Psi'_I(X^*) \quad (5.84)$$

not forgetting the factor  $(\mathcal{P}_{w^{-1}}^{g, g^{-1}} \mathcal{Q}_{w, w^{-1}}^g)^{-1}$ . Now express the phases in (5.83) and (5.84) solely with  $\Phi$ 's and obtain (after putting them on the LHS):

$$\begin{aligned} \text{LHS} &= \left[ \Phi_{w, w^{-1}} \Phi_{g, w^g} \Phi_{w, g}^{-1} g^* \Phi_{w^g, (w^{-1})^g}^{-1} \right. \\ &\quad \times \left. (wg)^* \Phi_{(w^{-1})^g, g^{-1}} (wg)^* \Phi_{g^{-1}, w^{-1}}^{-1} \Phi_{g, g^{-1}}^{-1} w^* \Phi_{g, g^{-1}} \right]_I \end{aligned} \quad (5.85)$$

everything evaluated at  $x$ . Finally, to show (5.79), express the phase of the antipode (5.80) solely with  $\Phi$ 's using  $\omega_{g, h, k} = g^* \Phi_{h, k} \Phi_{gh, k}^{-1} \Phi_{g, hk} \Phi_{g, h}^{-1}$ :

$$\begin{aligned} (\mathcal{P}_{w^{-1}}^{g, g^{-1}} \mathcal{Q}_{w, w^{-1}}^g)^{-1} &= w^* \left\{ g^* \Phi_{(w^{-1})^g, g^{-1}} \Phi_{w^{-1}, g, g^{-1}}^{-1} \Phi_{g, (wg)^{-1}} \Phi_{g, (w^{-1})^g}^{-1} \right\} \\ &\quad \times w^* \Phi_{g, (w^{-1})^g} \Phi_{wg, (w^{-1})^g}^{-1} \Phi_{w, w^{-1}g} \Phi_{w, g}^{-1} \\ &\quad \times w^* \left\{ (w^{-1})^* \Phi_{g, g^{-1}}^{-1} \Phi_{w^{-1}g, g^{-1}} \Phi_{w^{-1}, 1_G}^{-1} \Phi_{w^{-1}, g} \right\} \\ &\quad \times w^* \left\{ g^* \Phi_{g^{-1}, w^{-1}}^{-1} \Phi_{1_G, w^{-1}} \Phi_{g, (wg)^{-1}}^{-1} \Phi_{g, g^{-1}} \right\} \\ &\quad \times w^* \Phi_{w^{-1}, g}^{-1} \Phi_{1_G, g} \Phi_{w, w^{-1}g}^{-1} \Phi_{w, w^{-1}} \\ &\quad \times g^* \Phi_{w^g, (w^{-1})^g}^{-1} \Phi_{wg, (w^{-1})^g} \Phi_{g, 1_G}^{-1} \Phi_{g, w^g}. \end{aligned} \quad (5.86)$$

In this last formula, the first  $(\omega_{g, (w^{-1})^g, g^{-1}})$ , third  $(\omega_{w^{-1}, g, g^{-1}})$  and fourth line  $(\omega_{g, g^{-1}, w^{-1}})$  have been lifted by  $w$  for convenience. Note that this is allowed due to  $d\omega = 1$ . In (5.86), there are 16 terms that cancel, leaving the ones in (5.85).  $\square$

Using this compatibility (5.79), one gets for a fixed winding

$$(\Pi \otimes \text{id})[\Delta(T_g^{1G}) K_{w^g, (w^{-1})^g}^{0 \rightarrow 2}] = T_g^{w^{-1}} K_{(w^{-1})^g}^{1 \rightarrow 1} S(T_g^w), \quad (5.87)$$

representing the isomorphism between

$$(\Pi \otimes \text{id})[\Delta(T_g^{1G}) K_{w^g, (w^{-1})^g}^{0 \rightarrow 2}] \in \mathcal{H}_{w^{-1}}^* \otimes \mathcal{H}_{w^{-1}} \quad (5.88)$$

and

$$T_g^{w^{-1}} K_{(w^{-1})^g}^{1 \rightarrow 1} S(T_g^w) : \mathcal{H}_{w^{-1}} \rightarrow \mathcal{H}_{w^{-1}}. \quad (5.89)$$

Together with (5.71) and (5.76) this gives rise to the equation

$$T_{(2)} S(T_{(1)}) = \epsilon(T), \quad \forall T \in \mathcal{D}^\omega(\mathbb{K}G), \quad (5.90)$$

which can be obtained using [49]

$$S^2(T) = \beta^{-1}T\beta, \quad \forall T \in \mathcal{D}^\omega(\mathbb{K}G) \quad (5.91)$$

as well as the anti-morphism property of the antipode and

$$T_{(1)}\beta S(T_{(2)}) = \epsilon(T)\beta, \quad \forall T \in \mathcal{D}^\omega(\mathbb{K}G). \quad (5.92)$$



---

---

## CHAPTER 6

---

### CONCLUSIONS AND OUTLOOK

From the physical point of view, the operators  $T_g^w$  realizing magnetic translations for strings have been constructed. Generally, the operators lift the action of a discrete finite group  $G$  to the states, where the magnetic background field is taken to be  $G$ -invariant. In the case of a particle in an invariant magnetic field strength  $B$ , it turns out that the operators  $T_g$  furnish a projective representation of the translation group. The operators are derived for topologically non trivial background fields, i.e.  $B \neq dA$  globally. For that, we have applied the local construction of the magnetic amplitude  $\mathcal{A}[\varphi]$  entering Feynman's path integral formula for the propagator. The magnetic amplitude for a path  $\varphi$  is given by the holonomy of the connection of an hermitian complex line bundle  $\mathcal{L}$  and the propagator  $K(y, x)$  is interpreted as a linear map between the fibres at  $x$  and  $y$ . For the magnetic amplitude, the local data of the line bundle is used, that is, the fields  $(A_i, f_{ij})$  are combined in such a way that they provide the tool to write down the holonomy. Here,  $f_{ij}$  are the transition functions and  $A_i$  the gauge fields. The wave functions  $\psi_i$  become sections over the line bundle and the magnetic translations act projectively on the space of sections. The extra phase that accompanies the magnetic translations is thus identified with the isomorphism that relates the line bundle  $\mathcal{L}$  with its pull-back bundle  $g^*\mathcal{L}$  for any  $g \in G$ . The explicit construction of the  $T_g$ 's is done by requiring their commutation with the dynamics of the system, i.e. they commute with the propagator. The algebra generated by these operators is that of a non-commutative torus due to the appearance of the group 2-cocycle  $\omega_{g,h}$ .

For a string, the coupling to a magnetic field  $H$  is achieved via the Kalb-Ramond potential  $B$  which is now a 2-form instead of the 1-form connection. Analogously, the 3-form  $H$  is assumed to be invariant with respect to the group action and the problem of a globally non exact field strength  $H \neq dB$  is treated. Geometrically, the  $B$ -fields provide the local data of a 1-gerbe as a triple  $(B_i, B_{ij}, f_{ijk})$ , where  $B_i$  is the locally given 2-form,  $B_{ij}$  a 1-form and  $f_{ijk}$  are  $U(1)$  valued 'transition functions' of the gerbe, all fields are related on multiple intersections of open sets  $\cap_i \mathcal{U}_i$ . To implement the action of the group  $G$  on the gauge fields, the convenient framework of a tricomplex in terms of the Čech- de Rham- and group cohomology has been introduced. This allows to methodically generate a sequence of Čech-de Rham gauge fields

of decreasing degree ending in a constant group 3-cocycle  $\omega_{g,h,k}$ . The group action on the gauge fields is then completely encoded by (Deligne-)cohomological equations. This procedure is versatile enough to be applied to gauge potentials of any degree, for example the 3-form potential appearing in M-theory. In its easiest version, the methods of the tricomplex have been used to derive the equations that provide the group action to the local data of the line bundle.

The construction of the magnetic translations on the string states follows the lines of the procedure introduced for the particle. For that, one has to formulate the string magnetic amplitude with the local data  $(B_i, B_{ij}, f_{ijk})$ . Using these gauge fields, the operators  $T_g^w$  realizing the group action are constructed by requiring that they commute with the propagation of a single string. This leads to a projective action where the extra phase  $\mathcal{P}_w^{g,h}$  can be given in terms of the 3-cocycle  $\omega_{g,h,k}$  that appeared already in the tricomplex method. To complete the structural analysis of the algebra generated by the so derived magnetic translation operators  $T_g^w$ , tree level amplitudes for a single string are included. The most basic interaction is a string that decomposes into two and therefore builds up a world-sheet which has the form of a pair of pants. The action of the magnetic translations on the outgoing two-string state can only be consistent, if they act as  $\mathcal{Q}_{u,v}^g T_g^u \otimes T_g^v$  which is expected by the representation theory of the underlying algebra. Indeed, it predicts this action by the coproduct  $\Delta(T_g^{uv})$ , where the coproduct is accompanied by the extra phase  $\mathcal{Q}_{u,v}^g$  and is entirely justifiable by gauge invariance. It is rather amazing and highly non trivial that the so obtained algebraic structure is in one-to-one correspondence with that of the quasi-quantum group  $\mathcal{D}^w(KG)$ , i.e. the  $\omega$ -twisted Drinfel'd quantum double of a finite group algebra  $KG$ . This quasi Hopf algebra was derived by R. Dijkgraaf, V. Pasquier and P. Roche [23] in the context of two dimensional conformal field theory and reappears here rather naturally as the algebra generated by simple magnetic translations. Therefore, it is expected that the underlying quantum symmetry group has a deeper physical and mathematical meaning than it has been unveiled here.

To make contact with the representation theory of  $\mathcal{D}^w(KG)$  in a more explicit manner, the winding dependent Hilbert spaces of twisted sector states are identified with modules over the algebra. These modules are nothing but objects in a tensor category, which inherits some key features of the underlying algebra. For example, the coproduct  $\Delta$  provides the tensor product  $\otimes$  for the category and the quasi-coassociativity given by the Drinfel'd associator  $\Omega$  for a quasi Hopf algebra provides the associativity constraint  $\Phi_{U,V,W}$  in the category. If the algebra is braided, it is further equipped with a quasi-triangular structure, i.e. an  $\mathcal{R}$ -matrix, that provides a braiding  $\Psi_{U,V}$  as a functorial isomorphisms in the category. Since  $\mathcal{D}^w(KG)$  is a braided quasi Hopf algebra, the braiding and the quasi-coassociativity have counterparts on the level of magnetic amplitudes. Indeed, it turns out that for tree level amplitudes of a string that disintegrates into more than two, quasi-coassociativity is reflected by the structure of parenthesisings that arises from the propagation and decomposition process in a tree shaped manner. Picking two amplitudes with a different outgoing Hilbert space structure, one can switch them by repeated use of the Drinfel'd associator, in complete accordance with the category point of view. Analogously, the braiding is accomplished by using the  $\mathcal{R}$ -matrix. For the magnetic amplitude, the process of braiding corresponds to turning the cut around one

of the legs, thus to produce a large diffeomorphism of the world-sheet which does not lie in the connected component of the identity diffeomorphism. Together with the Dehn twist of a single cylinder, the algebra  $\mathcal{D}^\omega(\mathbb{K}G)$  generates the mapping class group of more complicated surfaces, obtained by gluing together cylinders and pair of pants. By gluing together tree-level amplitudes, one can deduce their behavior as respecting that of a braided operad, which is simply the statement that gluing commutes with braiding and twisting.

However, with a view to the construction of an orbifold  $\mathcal{M}/G$  in the presence of a  $G$ -invariant 3-form  $H$  on  $\mathcal{M}$ , the 3-cocycle  $\omega_{g,h,k}$  leads to problems. This is due to the non-existence of invariant states and the global anomalies appearing for 1-loop amplitudes, requiring  $\omega_{g,h,k}$  to be trivial. This also confirms, from a different viewpoint, the results presented by Sharpe in the context of discrete torsion. Discrete torsion has as well a beautiful counterpart in the context of the presented work, namely it corresponds to a Drinfel'd twist of  $\mathcal{D}^\omega(\mathbb{K}G)$ . Finally, the antipode and the counit of  $\mathcal{D}^\omega(\mathbb{K}G)$  provide the compatibility of vacuum amplitudes with magnetic translations. The counit  $\epsilon(T_g^w)$  turns out to be just the trivial representation on the vacuum that can be found by commuting a process  $K^{0 \rightarrow 2}$  with the magnetic translations. Since in algebraic terms the antipode provides a dual representation, one obtains a relation between processes  $K^{0 \rightarrow 2}$  and  $K^{1 \rightarrow 1}$  by orientation reversing. The orientation of the boundaries of the world-sheet encodes whether a string is incoming or outgoing. Reversing the orientations of several boundary components provides a way to reinterpret a given process by reshuffling the incoming and outgoing variables. In this context, the antipode represents the mediator between translations and flips of boundary orientations.

In view of [23] and [47] it remains to understand the true origin of this quasi Hopf algebra since it already appears without the application of conformal field theory. Therefore, it seems possible that the algebra  $\mathcal{D}^\omega(\mathbb{K}G)$  has indeed a deeper structural meaning. Particularly its application to M-Theory or supersymmetric models should be considered as an interesting future research project.



---

## BIBLIOGRAPHY

- [1] N.M.J. Woodhouse, *"Geometric Quantization"*, Oxford Mathematical Press (1997)
- [2] K. Gawędzki, *"Topological actions in two-dimensional quantum field theories"*, in *Non-perturbative quantum field theory*, Cargèse (1987)
- [3] N. Hitchin, *"What is... a Gerbe?"*, AMS notices,  
<http://www.ams.org/notices/200302/what-is.pdf>
- [4] S. Hamidi and C. Vafa, *"Interactions on Orbifolds"*, Nucl. Phys. B **279** (1987) 465
- [5] G. Mack and V. Schomerus, *"Quasi Hopf quantum symmetry in quantum theory"*, Nucl. Phys. B **370** (1992) 185
- [6] G. Grensing, *"Fractional quantum Hall effect and quantum symmetry"*, Phys. Rev. B **61** (2000) 5483
- [7] J. H. Jureit and T. Krajewski, *"Quasi-quantum groups from Kalb-Ramond fields and magnetic amplitudes for strings on orbifolds"*, [arXiv:hep-th/0612105]
- [8] H. Kleinert, *"Pfadintegrale"*, B.I. Wissenschaftsverlag Mannheim (1993)
- [9] M. Blau, *"Symplectic Geometry and Geometric Quantization"*, lecture notes, unpublished
- [10] A. Kirillov, *"Geometric Quantization"*, Encyclopedia of Mathematical Sciences **4**, V.I. Arnold and S.P. Novikov (eds.), Springer-Verlag (2001)
- [11] L. Schulman, *"A Path integral for spin"*, Phys. Rev. **176** (1968) 1558
- [12] M.G.G. Laidlaw, C. Morette DeWitt, *"Feynman Functional Integrals for Systems of Indistinguishable Particles"*, Phys. Rev. D **3** (1970) 1375
- [13] A. Lerda, *"Anyons"*, Lecture Notes in physics 14, Springer-Verlag, Berlin-Heidelberg (1994)

- 
- [14] G.L. Naber, *"Topology, Geometry, and Gauge Fields"*, Springer-Verlag, New York (1997)
- [15] Y. Aharonov and D. Bohm, *"Significance of electromagnetic potential in the quantum theory"*, Phys. Rev. **115** (1959) 485
- [16] J. Zak, *"Magnetic Translation Group"*, Phys. Rev. **134** (1964) A1602
- [17] E. Brown, *"Bloch Electrons in a Uniform Magnetic Field"*, Phys. Rev. **133** (1964) A1038
- [18] M. Murray, *"Line Bundles"*, Honours (1999)
- [19] M Nakahara, *"Geometry, Topology and physics"*, Graduate Student Series in Physics, IoP Bristol and Philadelphia, second edition (2003)
- [20] J.L. Brylinski, *"Loop Spaces, Characteristic classes and Geometric Quantization"*, Birkhäuser Boston (1993)
- [21] J. Baez, *"Braids and Quantization"*, rambling lectures, (1992)
- [22] N. J. Hitchin, *"Lectures on special Lagrangian submanifolds"*, [arXiv:math.dg/9907034]
- [23] P. Roche, V. Pasquier and R. Dijkgraaf, *"Quasi Hopf Algebras, Group Cohomology And Orbifold Models"*, Nucl. Phys. Proc. Suppl. **18B** (1990) 60
- [24] K. Gawedzki, *"Conformal field theory: A case study"*, [arXiv:hep-th/9904145]
- [25] B. Zwiebach, *"A first course in String Theory"*, Cambridge University Press (2004)
- [26] G. Segal, *"Two-dimensional conformal field theories and modular functors"*, in *Proceedings, Mathematical physics*, Swansea (1988)
- [27] M. Kalb, P. Ramond, *"Classical direct interstring action"*, Phys. Rev. D **9** (1974) 2273
- [28] C. V. Johnson, *"D-brane primer"*, [arXiv:hep-th/0007170]
- [29] K. Gawędzki and N. Reis, *"WZW branes and gerbes"*, Rev. Math. Phys. **14** (2002) 1281
- [30] P. Aschieri, *"Gerbes, M5-brane anomalies and E(8) gauge theory"*, JHEP **0410** (2004) 068
- [31] I.R. Shafarevich, *"Basic Notions of Algebra"*, Springer-Verlag (1997)
- [32] R. Jackiw, *"Topological Investigations Of Quantized Gauge Theories"* in *Les Houches Summer School on Theoretical Physics: Relativity Groups and Topology*, Les Houches (1983)
- [33] K. Gawedzki, R. R. Suszek and K. Waldorf, *"WZW orientifolds and finite group cohomology"*, [arXiv:hep-th/0701071]
- [34] M. K. Murray, *"Bundle gerbes"*, J. Lond. Math. Soc. **54** (1996) 403

- [35] K. Gawędzki and N. Reis, "*Basic gerbe over non simply connected compact groups*", [arXiv:math.dg/0307010]
- [36] E. R. Sharpe, "*Discrete torsion*", Phys. Rev. D **68**, 126003 (2003); "*Discrete torsion and gerbes I*", [arXiv:hep-th/9909108]; "*Discrete torsion and gerbes II*", [arXiv:hep-th/9909120]
- [37] S. Seki, "*Discrete torsion and branes in M-theory from the mathematical view point*", Nucl. Phys. B **606** (2001) 689
- [38] E. R. Sharpe, "*Analogues of discrete torsion for the M-theory three-form*", Phys. Rev. D **68**, 126004 (2003)
- [39] C. Kassel, "*Quantum groups*", Graduate text in mathematics, Springer (1995)
- [40] V. Chari and A. Pressley, "*Quantum groups*", Cambridge University Press (1994)
- [41] S. Majid, "*Foundations of Quantum Group Theory*", Cambridge University Press (1995)
- [42] H. Hata, K. Itoh, T. Kugo, H. Kunitomo and K. Ogawa, "*Gauge String Field Theory For Torus Compactified Closed String*", Prog. Theor. Phys. **77** (1987) 443.
- [43] S. Willerton, "*The twisted drinfeld double of a finite group via gerbes and finite groupoids*", [arXiv:math.QA/0503266v1]
- [44] J.S. Birman, "*Links, Braids and Mapping Class groups*", Princeton University Press (1975)
- [45] Z. Fiedorowicz "*The symmetric bar construction*", preprint available at <http://www.math.ohio-state.edu/fiedorow/>
- [46] R. Dijkgraaf and E. Witten, "*Topological Gauge Theories And Group Cohomology*", Commun. Math. Phys. **129** (1990) 393
- [47] P. Bantay, "*Algebraic aspects of orbifold models*", Int. J. Mod. Phys. A **9** (1994) 1443
- [48] C. Vafa, "*Modular Invariance And Discrete Torsion On Orbifolds*", Nucl. Phys. B **273** (1986) 592
- [49] D. Altschuler and A. Coste, "*Quasiquantum Groups, Knots, Three Manifolds, And Topological Field Theory*", Commun. Math. Phys. **150** (1992) 83



## Part II

### QUANTUM FIELD THEORY ON PROJECTIVE MODULES



---

---

## CHAPTER 7

---

### INTRODUCTION:

### WHY NONCOMMUTATIVE FIELD THEORY?

This chapter gives a brief idea of noncommutative field theory. It is a cumulative part with the publication attached to its end.

#### § 7.1 NONCOMMUTATIVE SPACES

Noncommutative geometry [1] is a mathematical branch developed at the end of the last century by Alain Connes. It allows to translate differential geometry into a purely algebraic language. More precisely, the idea is to identify a smooth manifold with the algebra of functions over it. It is then possible to describe geometrical objects like vector bundles, connections, differential forms and exterior derivatives solely in algebraic terms. Since the commutativity of the algebra associated to the space does not play any role, one can extend this procedure to a 'noncommutative space' in replacing the algebra of functions by a noncommutative deformation. For a good review, see for example [2].

Probably the most familiar example is the phase space of quantum mechanics. Classical observables, the algebra of functions on phase space, is replaced by a noncommutative  $C^*$ -algebra of quantum mechanical observables obeying the commutation relation  $[x^i, p_j] = i\hbar\delta_j^i$ . In consequence, Heisenberg's uncertainty causes points of this space to lose their meaning. In this sense, noncommutative geometry does to position space what Heisenberg does to phase space. The space becomes 'fuzzy' which means that the coordinates of spacetime are replaced by Hermitian operators obeying the commutation relation

$$[x^i, x^j] = i\theta^{ij}. \quad (7.1)$$

Here, the antisymmetric deformation tensor  $\theta^{ij}$  plays the role of Planck's constant, and can be taken to be constant or as a function of the coordinates. In some applications, the number theoretical aspect plays an important role.

Another example is that of the quantum mechanics of the motion of charged particles in two dimensions under the influence of a constant, perpendicular applied magnetic field. Recall that, the Hamiltonian of one particle is given by

$$\hat{H}_L = \frac{\hat{\pi}^2}{2m} = \frac{1}{2m} \left( \hat{p} - \frac{e}{c} \hat{A} \right)^2 \quad (7.2)$$

with  $A$  the vector potential in any gauge choice. The energy eigenvalues are the Landau levels  $E = \hbar\omega_c(n + \frac{1}{2})$  where  $\omega_c = \frac{eB}{mc}$  is the cyclotronic frequency of the classical electron orbits. It is interesting, that the kinetical momenta  $\hat{\pi} = \hat{p} - \frac{e}{c} \hat{A}$  do not commute,

$$[\hat{\pi}_i, \hat{\pi}_j] = i\hbar \frac{e}{c} (\partial_i A_j - \partial_j A_i), \quad (7.3)$$

one has thus a situation in which the momentum space of a system is no longer commutative. To obtain an example of a noncommutative position space, take the example above in the strong magnetic field limit. If the magnetic field  $B$  is made strong enough, there is an insuperable energy gap between the lowest Landau level and the excited ones due to the separation of energy levels proportional to  $B$ . If  $B \gg m$ , the Lagrangian in the gauge  $A = (0, Bx)$  reads

$$L = p\dot{q} = \left( \frac{eB}{c} x \right) (\dot{y}) \quad (7.4)$$

such that one has the canonical pair

$$[\hat{x}, \hat{y}] = i\hbar \frac{c}{eB}. \quad (7.5)$$

With  $\theta^{ij} = \frac{\hbar c}{eB} \epsilon^{ij}$ , this is the starting point (7.1). Hence, a two-dimensional physical system constrained to the lowest Landau level can be understood as a simple example of noncommutative position space.

## § 7.2 FIELD THEORY

The idea already suggested by Heisenberg was that if spacetime is indeed smeared out on very small length scales, this might perhaps prevent loop integrals to be divergent, so to say, some sort of a 'natural' energy cut-off. From a different viewpoint, this is completely obvious: probing smaller and smaller regions comes together with putting more and more energy into a little volume. There is a natural limit of this procedure [3], namely the creation of a little black hole that blocks the so desired deeper insight from the observer by its event horizon. However, this argument assumes that the laws of general relativity are really applicable at these scales which is *a priori* not so obvious. From the field theoretical perspective, there are many reasons why one might postulate noncommutativity apart from the hope to improve the short distance behavior and renormalizability properties of a theory. For some good review see [4, 5, 6]. For example, string theory 'predictions' are limited by the spacial extension of a string, i.e. the string length. And there are arguments for the appearance of noncommutative gauge theories as certain limits of M-Theory [7]. Noncommutative geometry seems to appear in condensed matter physics as well [8, 9]. Electrons confined to a plane projected to the

lowest Landau level can be thought of as a noncommutative field theory. This gives hope to find a field theoretical explanation for the (fractional) quantum Hall effect [10, 11].

One of the best studied noncommutative quantum field theories is the noncommutative version of the toy model  $\phi_4^4$ . For a recent review, see [12, 13]. Recall that the action of ordinary  $\phi_4^4$  theory is given by

$$S[\phi] = \int d^4x \left( -\frac{1}{2} \partial_\mu \phi \partial^\mu \phi + \frac{1}{2} m^2 \phi^2 + \frac{\lambda}{4!} \phi^4 \right). \quad (7.6)$$

The field  $\phi$  is a continuous function\* over  $\mathbb{R}^4$  and in the quartic interaction the four fields are just multiplied according to the commutative point-wise product. To render such a theory noncommutative, one passes over from  $\mathbb{R}^4$  to the so called *Moyal plane*  $\mathbb{R}_\Theta^4$ . The algebra of functions changes according to the change of the product. Namely the point-wise product is exchanged by the Moyal-Groenenwald product defined as

$$(f \star g)(x) = \frac{1}{(2\pi)^4} \int d^4y d^4k f(x + \Theta \cdot k) g(x + y) e^{iky}. \quad (7.7)$$

Here,  $\Theta$  is an antisymmetric  $4 \times 4$ -matrix and  $\Theta \cdot k = \Theta_{\mu\nu} k^\nu$ . The idea is then to replace all products in the action to obtain

$$S[\phi] = \int d^4x \left( -\frac{1}{2} \partial_\mu \phi \star \partial^\mu \phi + \frac{1}{2} m^2 \phi \star \phi + \frac{\lambda}{4!} \phi \star \phi \star \phi \star \phi \right). \quad (7.8)$$

There are several consequences of the use of the Moyal product. First, the free part of the theory is unchanged since the product of two fields is unchanged by the deformation. The quartic interaction term, however, yields a vertex which is now invariant only if the permutations of the fields have a *cyclic* order. This means that such Feynman graphs are represented as *ribbon graphs*. This gives rise to a distinction between topologically trivial, or *planar* graphs, as well as *non-planar* graphs that can be thought of lying on a surface of non-trivial topology. The planar sector of this theory remains indeed unchanged in comparison with the commutative case. In contrast to this, non-planar diagrams lead to a strange mixing of scales, the so called UV/IR-mixing. For this, consider the non-planar tadpole

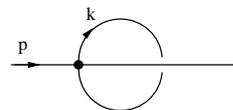

$$\propto \int d^4k \frac{e^{ip_\mu k_\nu \Theta^{\mu\nu}}}{k^2 + m^2} \quad (7.9)$$

which differs from the planar one

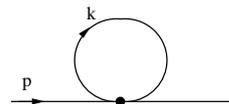

$$\propto \int d^4k \frac{1}{k^2 + m^2} \quad (7.10)$$

by the appearance of the oscillatory, momentum dependent phase. The planar loop (7.10) contributes to the standard one-loop mass correction and is quadratically divergent. Because

---

\*They are of course Schwartz class functions.

of the rapidly oscillating phase at high energies, the non-planar tadpole (7.9) is finite, but only if  $p \neq 0$ ! Indeed, the extra phase serves as a regulator, which can be seen most easily by rewriting the propagator in Schwinger parametrization and integrating out the Gaussian integral over  $k$ ,

$$\begin{aligned} \int d^4k \frac{e^{ip_\mu k_\nu \Theta^{\mu\nu}}}{k^2 + m^2} &= \int_0^\infty d\alpha \int d^4k e^{-\alpha(k^2+m^2)+i\tilde{p}\cdot k} \\ &= \frac{\pi^2}{4} \int_0^\infty \frac{d\alpha}{\alpha^2} e^{-\alpha m^2} e^{-\frac{\tilde{p}^2}{4\alpha}} \end{aligned} \quad (7.11)$$

with  $\tilde{p}^\mu = \Theta_{\mu\nu} p^\nu$  and  $\tilde{p}\cdot k = \tilde{p}^\mu k_\mu$ . Thus, at external momenta  $\neq 0$ , the damping factor  $1/4\alpha$  leads to a convergent integral. In consequence, non-planar tadpoles inserted into any bigger graph make IR-divergent any  $n$ -point Green function with  $n \geq 6$ . Since this term is non-local, it cannot be absorbed into a mass redefinition, thus rendering the theory non-renormalizable. This phenomenon is the extensively studied UV/IR-mixing, and is a characteristic feature of noncommutative field theory.

The UV/IR-problem was cured by H. Grosse and R. Wulkenhaar [14, 15] who found a way to formulate a renormalizable noncommutative  $\phi^4$  theory. The trick is to insert an extra term into the action,

$$S[\phi] = \int d^4x \left( -\frac{1}{2} \partial_\mu \phi \star \partial^\mu \phi + \frac{\Omega^2}{2} (\tilde{x}_\mu \phi) \star (\tilde{x}^\mu \phi) + \frac{1}{2} m^2 \phi \star \phi + \frac{\lambda}{4!} \phi \star \phi \star \phi \star \phi \right) \quad (7.12)$$

with  $\tilde{x}_\mu = 2\Theta^{-1}x$  and  $\Omega$  some real dimensionless parameter, in the self dual case  $\Omega = 1$ . The propagator of this theory is the kernel of the inverse of the operator  $(\Delta + \Omega^2 \tilde{x}^2 + m^2)$ , with  $\Delta = -\partial^\mu \partial_\mu$  the Laplacian, such that the kinetic term of this theory is given by a harmonic oscillator Hamiltonian and the propagator becomes the Mehler kernel. The origin of this term is still unclear, but it has important consequences. The most important, it renders this theory renormalizable to all orders in perturbation theory in overcoming the UV/IR mixing problem. The process of including such a term has been given a name; it is called *vulcanization*<sup>†</sup>. Further, it restores the so called Langmann-Szabo duality (LSD) [16] in the kinetic part of the action. Langmann and Szabo remarked that the interaction term with the Moyal product is invariant under a duality transformation that exchanges positions and momenta. More precisely, this is a cyclic Fourier transformation. The process of vulcanization serves to restore this duality for the free theory, like a harmonic oscillator is obviously invariant under such an exchange. The LS-duality then induces a change of the action

$$S[\phi; m, \lambda, \Omega] \mapsto S[\phi; \frac{m}{\Omega}, \frac{\lambda}{\Omega^2}, \frac{1}{\Omega}]. \quad (7.13)$$

which becomes exact for  $\Omega = 1$ . Up to now, it seems that this duality is important with respect to the renormalizability of noncommutative theories. In fact, there are other models, for example the noncommutative Gross-Neveu model [12], that can be rendered renormalizable to all orders by vulcanization.

---

<sup>†</sup>I prefer the term 'wulkenhaarization' for obvious reasons.

In QFT, the fields can be interpreted geometrically as sections in a vector bundle over the underlying manifold. In simple cases, this bundle is taken to be trivial, thus topologically it is isomorphic to a direct product of the base manifold and the fibres. For a field theory over the Moyal plane, the fields can be thought of as sections over a trivial bundle, whose base manifold is a noncommutative space. In terms of noncommutative geometry, this is equivalent to fields taking their values in a free  $\mathcal{A}$ -module with  $\mathcal{A}$  being the noncommutative Moyal algebra, i.e. the Schwartz space of smooth and rapidly decreasing functions equipped with the Moyal  $\star$ -product. This idea can be extended to the case of a topologically non-trivial bundle which leads to the interpretation of fields living in a projective module which stands for the noncommutative pendant of a non-trivial vector bundle.

### § 7.3 FIELD THEORY ON PROJECTIVE MODULES

Hence, returning to this more general setting, noncommutative geometry says that the topological structure of a space  $\mathcal{M}$  can be analyzed by its  $C^*$ -algebra of continuous functions. This is due to the Gelfand-Naimark theorem that states that commutative  $C^*$ -algebras are equivalent to locally compact Hausdorff spaces (there are some functors between their categories). For details, please consult [2, 17, 18]. One can then pass over to the noncommutative realm by formulating some notions of standard (commutative) geometry in purely algebraic terms and replacing the algebra by a noncommutative one. For example, let  $\mathcal{A}$  be the algebra of smooth functions  $C^\infty(\mathcal{M})$ . A vector bundle is specified by a projection  $\pi : E \rightarrow \mathcal{M}$  with  $E$  the total space. The space of smooth sections  $\Gamma(E) = C^\infty(\mathcal{M}, E)$  comes naturally equipped with an  $\mathcal{A}$ -module structure, in the sense that sections can be multiplied point-wise with functions, yielding another section, compatible with the definition of an action. For trivial bundles, this means that the space of sections  $\Gamma(E)$  is isomorphic to the free module  $\mathcal{A}^N$ . By the Serre-Swan theorem, any vector bundle can be written as a direct summand of a trivial one, which means that  $\Gamma(E)$  itself can be obtained by some sort of projection. More precisely, suppose  $\mathcal{M}$  is covered with open sets  $\{\mathcal{U}_i\}$  and compact, which allows for a partition of unity by functions  $\psi_1, \dots, \psi_q \in \mathcal{A}$  with  $\sum_{i=1}^q |\psi_i|^2 = 1$ . One can define a projection  $p \in M_{qN}(\mathcal{A})$  by  $p_{ij} = \psi_i f_{ij} \psi_j$ , where  $f_{ij}$  are the transition functions of  $E$  fulfilling the cocycle condition. A section  $s \in \Gamma(E)$  is locally given by a function  $s_i : \mathcal{U}_i \rightarrow \mathbb{C}^N$  and transforms according to  $s_i = f_{ij} s_j$  on intersections  $\mathcal{U}_i \cap \mathcal{U}_j$ . On regarding sections as tuples  $s = (s_1 \psi_1, \dots, s_q \psi_q) \in \mathcal{A}^{qN}$ , one identifies  $\Gamma(\mathcal{M})$  with  $p\mathcal{A}^{qN}$ . Generally,  $\mathcal{A}$ -modules of the form  $p\mathcal{A}^m$  are called finite projective modules. A noncommutative vector bundle is just a finite projective module  $\mathcal{E}$  over  $\mathcal{A}$ , where  $\mathcal{A}$  is no longer commutative. There are similar constructions that allow to properly define differential forms, connections, etc, i.e. the ingredients necessary to define an action and a field theory.

The basic and most general constructions to define an action functional for such a theory can be summarized [19]:

- A (finitely generated) projective module  $\mathcal{E}$  over  $\mathcal{A}$ . For technical reasons,  $\mathcal{A}$  is assumed to be a dense sub-algebra of a  $C^*$  algebra  $A$ . The projective module will become the receptacle for matter fields.  $\mathcal{A}$  should be equipped with a trace  $\text{Tr}_{\mathcal{A}}$ .

- Differential forms on  $\mathcal{A}$  can be defined by the graded differential algebra  $\Omega^\bullet(\mathcal{A}) = \bigoplus_{k=0}^{\infty} \Omega^k(\mathcal{A})$  equipped with the nilpotent differential  $d : \Omega^k(\mathcal{A}) \rightarrow \Omega^{k+1}(\mathcal{A})$  fulfilling the graded Leibniz rule. As an  $\mathcal{A}$ -bimodule, each component  $\Omega^k(\mathcal{A})$  must be equipped with a scalar product  $\langle \cdot, \cdot \rangle_k$  compatible with the action, i.e.  $\langle \omega, \eta a \rangle_k = \langle \omega a^*, \eta \rangle_k$  and  $\langle \omega, a \eta \rangle_k = \langle a^* \omega, \eta \rangle_k$ ,  $\forall a \in \mathcal{A}$  and  $\omega, \eta \in \Omega^k$ .
- An Hermitian structure in terms of an  $\mathcal{A}$  valued pairing  $(\cdot, \cdot)_{\mathcal{A}} : \mathcal{E} \times \mathcal{E} \rightarrow \mathcal{A}$ . This pairing must be compatible with the action of  $\mathcal{A}$ ,  $(\phi, \chi a)_{\mathcal{A}} = (\phi, \chi)_{\mathcal{A}} a$  and with the involution,  $(\phi, \chi)_{\mathcal{A}} = (\chi, \phi)_{\mathcal{A}}^*$ , and is positive definite,  $(\phi, \phi)_{\mathcal{A}} \geq 0$  with  $a \geq 0 \Leftrightarrow \exists b \in \mathcal{A} | a = b^* b$ .
- Further one needs a connection on the projective module, i.e. a map  $\nabla : \mathcal{E} \rightarrow \mathcal{E} \otimes_{\mathcal{A}} \Omega^1(\mathcal{A})$  fulfilling the Leibniz rule  $\nabla(\phi a) = \nabla(\phi) a + \phi \otimes da$  for  $\phi \in \mathcal{E}$  and  $a \in \mathcal{A}$ . It should be compatible with the Hermitian structure, i.e.  $d(\phi, \chi)_{\mathcal{A}} = (\nabla \phi, \chi)_{\mathcal{A}} + (\phi, \nabla \chi)_{\mathcal{A}}$ . This promotes  $\mathcal{E}$  to a pré- $C^*$  module or pré-Hilbert module.
- The module  $\mathcal{E}$  can be completed in the norm,  $\|\phi\| = \sqrt{\|(\phi, \phi)_{\mathcal{A}}\|}$  with  $\|\cdot\|$  being the  $C^*$ -norm in  $\mathcal{A}$  promoting  $\mathcal{E}$  to a  $C^*$ -module. Using the trace in  $\mathcal{A}$ , the scalar product  $\langle \cdot, \cdot \rangle_{\mathcal{E}} := \text{Tr}_{\mathcal{A}}[(\phi, \chi)_{\mathcal{A}}]$  turns  $\mathcal{E}$  into a Hilbert space.
- Finally, to define a kinetic term, one has to extend the scalar product  $\langle \cdot, \cdot \rangle_k$  on  $\Omega^k(\mathcal{A})$  to  $\mathcal{E} \otimes \Omega^k(\mathcal{A})$ , denoted by  $\langle \cdot, \cdot \rangle_{\mathcal{A}, k}$ .

The previous algebraic constructions allows to define a general action functional

$$S[\phi, \phi^\dagger] = \langle \nabla \phi, \nabla \phi \rangle_{\mathcal{A}, 1} + m^2 \text{Tr}_{\mathcal{A}}[(\phi, \phi)_{\mathcal{A}}] + \frac{\lambda}{2} \text{Tr}_{\mathcal{A}}[(\phi, \phi)_{\mathcal{A}}^2], \quad (7.14)$$

which should be compared to the well known version (7.6).

#### § 7.4 HEISENBERG MODULE OVER THE NCT AS AN EXAMPLE

In [19], this construction is applied to the example of a 4-dimensional noncommutative torus as underlying algebra  $\mathbb{T}_\theta^4$ . The representation space is a projective module  $\mathcal{E}_{\mathcal{S}}(\mathbb{R}^2)$  which is constructed to be a Heisenberg module [18] over  $\mathbb{T}_\theta^4$  and is equivalent to the Schwartz space  $\mathcal{S}(\mathbb{R}^2)$  of the real plane. For convenience, one can show that this representations space is isomorphic to the Bargmann [20] space  $\mathcal{E}_B(\mathbb{C}^2)$ , the space of holomorphic functions on  $\mathbb{C}^2$ . This leads to an interesting physical interpretation in 2 dimensions. The analytic functions building up the Bargmann space are in one-to-one correspondence with wave functions of the lowest Landau level. The noncommutative torus arises naturally if one considers a translational invariance under a lattice. This is the topology of the quantum Hall effect.

The analysis of the four dimensional theory in terms of the 1PI-Green functions leads to the behavior under renormalization. It turns out that the 2-point sector in the one-loop approximation generates quadratically divergent local counter-terms which can be absorbed by a mass redefinition. The 4-point sector decomposes into a planar and non-planar one. The planar part is perfectly acceptable in the sense that it generates a logarithmically diverging

but local contribution to the coupling constant renormalization. However, the non-planar 4-point sector yields a non-local contribution corresponding to a term of the form

$$\frac{\lambda'}{2} \text{Tr}_{\mathcal{A}} [(\phi, \phi)_{\mathcal{A}}]^2 \quad (7.15)$$

that was absent in the original action (7.14). The appearance of this term is the manifestation of the UV/IR-mixing problem mentioned in the beginning and arises in [19] from the non-planar graphs:



Finally, it allows to write down the action functional which is renormalizable up to one-loop calculations,

$$S[\phi, \phi^\dagger] = \langle \nabla \phi, \nabla \phi \rangle_{\mathcal{A},1} + m^2 \text{Tr}_{\mathcal{A}} [(\phi, \phi)_{\mathcal{A}}] + \frac{\lambda}{2} \text{Tr}_{\mathcal{A}} [(\phi, \phi)_{\mathcal{A}}^2] + \frac{\lambda'}{2} \text{Tr}_{\mathcal{A}} [(\phi, \phi)_{\mathcal{A}}]^2. \quad (7.16)$$

Noncommutative field theory and noncommutative geometry is an active research area in mathematical physics. It would be nice to enhance the previous example to fermions, i.e. some kind of Gross-Neveu model or something similar. A challenge would be to prove the renormalizability to all orders in perturbation theory. This is indeed an aspect of a future work. Possibly, this can be achieved in position space (not in Bargmann space) by the application of the so called multi-scale analysis. This procedure has proven to be very effective in demonstrating all-order renormalizability of several noncommutative field theory models [12]. Since this part of the thesis is a cumulative one, a detailed description of the outlined techniques and results can be found in the attached publication [19] done in collaboration with Raimar Wulkenhaar, Victor Gayral and Thomas Krajewski.



---

---

## CHAPTER 8

---

### PUBLICATION

This chapter contains the reference to the publication from a collaboration with Victor Gayral, Thomas Krajewski and Raimar Wulkenhaar. The publication is attached to the end of this part.

- *Quantum field theory on projective modules* [19], V. Gayral, T. Krajewski, R. Wulkenhaar and J.-H.J.. We propose a general formulation of perturbative quantum field theory on (finitely generated) projective modules over noncommutative algebras. This is the analogue of scalar field theories with non-trivial topology in the noncommutative realm. We treat in detail the case of Heisenberg modules over noncommutative tori and show how these models can be understood as large rectangular  $p \times q$  matrix models, in the limit  $p/q \rightarrow \theta$ , where  $\theta$  is a possibly irrational number. We find out that the model is highly sensitive to the number-theoretical aspect of  $\theta$  and suffers from an UV/IR-mixing. We give a way to cure the entanglement and prove one-loop renormalizability.



---

## BIBLIOGRAPHY

- [1] A. Connes, *"Noncommutative geometry"*, Academic Press, London and San Diego (1994)
- [2] J. C. Varilly, *"An introduction to noncommutative geometry"*, [arXiv:physics/9709045]
- [3] S. Doplicher, K. Fredenhagen and J. E. Roberts, *"The Quantum structure of space-time at the Planck scale and quantum fields"*, Commun. Math. Phys. **172** (1995) 187
- [4] M. R. Douglas and N. A. Nekrasov, *"Noncommutative field theory"*, Rev. Mod. Phys. **73** (2001) 977
- [5] R. J. Szabo, *"Quantum field theory on noncommutative spaces"*, Phys. Rept. **378** (2003) 207
- [6] R. J. Szabo, *"Magnetic backgrounds and noncommutative field theory"*, Int. J. Mod. Phys. A **19** (2004) 1837
- [7] A. Connes, M. R. Douglas and A. S. Schwarz, *"Noncommutative geometry and matrix theory: Compactification on tori"*, JHEP **9802** (1998) 003
- [8] J. Bellissard, *"C\* Algebras in solid state physics: 2-D electrons in a uniform magnetic field"*, Operator algebras and applications, Vol. 2, 49–76, London Math. Soc. Lecture Note Ser., 136, Cambridge Univ. Press, Cambridge, (1988).
- [9] J. Bellissard, *"Noncommutative Geometry of Aperiodic Solids"*, in: *Geometric and Topological Methods for Quantum Field Theory*, (Villa de Leyva, 2001), 86–156, World Sci. Publishing, River Edge, NJ (2003)
- [10] M. Marcolli & V. Mathai, *"Towards the fractional quantum Hall effect: A noncommutative geometry perspective"*, [cond-mat/0502356]
- [11] G. Grensing, *"Fractional quantum Hall effect and quantum symmetry"*, Phys. Rev. B **61** (2000) 5483

- 
- [12] F. Vignes-Tourneret, "*Renormalisation des théories de champs non commutatives*", Thèse de doctorat (2006)
- [13] V. Rivasseau and F. Vignes-Tourneret, "*Renormalisation of non-commutative field theories*", [arXiv:hep-th/0702068]
- [14] H. Grosse and R. Wulkenhaar, "*Renormalisation of  $\phi^4$  theory on noncommutative  $\mathbb{R}^4$  to all orders*", Lett. Math. Phys. **71** (2005) 13
- [15] H. Grosse and R. Wulkenhaar, "*Renormalisation of  $\phi^4$ -theory on noncommutative  $\mathbb{R}^4$  in the matrix base*", Commun. Math. Phys. **256** (2005) 305
- [16] E. Langmann and R. Szabo, "*Duality in scalar field theories on noncommutative phase spaces*", Phys. Lett. B **533** (2002) 168
- [17] A. Konechny & A. Schwarz, "*Introduction to M(atrrix) theory and noncommutative geometry*", [arXiv:hep-th/0012145]
- [18] A. Konechny and A. S. Schwarz, "*Introduction to M(atrrix) theory and noncommutative geometry II*", [arXiv:hep-th/0107251]
- [19] V. Gayral, J. H. Jureit, T. Krajewski and R. Wulkenhaar, "*Quantum field theory on projective modules*", to be published in JNCG, [arXiv:hep-th/0612048]
- [20] B. Hall, "*Holomorphic methods in analysis and mathematical physics*", [arXiv:quant-ph/9912054]

# Quantum field theory on projective modules

V. Gayral<sup>1</sup>, J.-H. Jureit<sup>2,3</sup>, T. Krajewski<sup>2,4</sup> and R. Wulkenhaar<sup>5</sup>

**Abstract:** We propose a general formulation of perturbative quantum field theory on (finitely generated) projective modules over noncommutative algebras. This is the analogue of scalar field theories with non-trivial topology in the noncommutative realm. We treat in detail the case of Heisenberg modules over noncommutative tori and show how these models can be understood as large rectangular  $p \times q$  matrix models, in the limit  $p/q \rightarrow \theta$ , where  $\theta$  is a possibly irrational number. We find out that the model is highly sensitive to the number-theoretical aspect of  $\theta$  and suffers from an UV/IR-mixing. We give a way to cure the entanglement and prove one-loop renormalizability.

**Keywords:** Heisenberg modules, renormalization, matrix models, Diophantine condition.

<sup>1</sup> Matematisk Afdeling, Københavns Universitet, gayral@math.ku.dk

<sup>2</sup> Centre de Physique Théorique

– Unité Mixte de Recherche du CNRS (UMR 6207) et des Universités Aix-Marseille I, Aix-Marseille II et de l'Université du Sud Toulon-Var

– Laboratoire affilié à la FRUMAM – FR 2291

<sup>3</sup> Also at Christian-Albrechts-Universität Kiel, jureit@cpt.univ-mrs.fr

<sup>4</sup> Also at Université de Provence, krajew@cpt.univ-mrs.fr

<sup>5</sup> Mathematisches Institut, Westfälische Wilhelms-Universität Münster, raimar@math.uni-muenster.de

# Contents

<b>1</b>	<b>Introduction</b>	<b>2</b>
<b>2</b>	<b>Classical field theory</b>	<b>4</b>
2.1	Projective modules in noncommutative geometry . . . . .	4
2.2	Noncommutative tori . . . . .	8
2.2.1	Geometric structures . . . . .	8
2.2.2	Heisenberg modules . . . . .	10
2.2.3	Symmetries and field equation . . . . .	12
2.3	Holomorphic representation . . . . .	13
<b>3</b>	<b>QFT and diagrammatics</b>	<b>16</b>
3.1	Feynman rules . . . . .	16
3.2	Reduced theory . . . . .	21
3.3	Position space Feynman rules and relations with other models . . . . .	23
3.3.1	Relation with matrix models . . . . .	23
3.3.2	Relation with the Grosse-Wulkenhaar model . . . . .	27
3.4	Feynman diagrams in the holomorphic representation . . . . .	29
3.5	Parametric representation . . . . .	30
<b>4</b>	<b>One-loop renormalization</b>	<b>33</b>
4.1	2-point sector . . . . .	33
4.2	4-point sector: Planar graphs . . . . .	35
4.3	4-point sector: Non-planar graphs . . . . .	37
<b>5</b>	<b>Mixed diagrams</b>	<b>44</b>
5.1	2-point sector . . . . .	45
5.2	4-point sector: planar graphs . . . . .	45
5.3	4-point sector: non-planar graphs . . . . .	46
<b>6</b>	<b><math>\beta</math>-functions</b>	<b>47</b>
<b>A</b>	<b>Comments on the duality covariant model</b>	<b>48</b>

## 1 Introduction

In its most general acceptance, quantum field theory (QFT) can be defined as the theory of infinite-dimensional dynamical systems which are based on geometrical concepts like, for instance, locality and invariance principles. Within the path integral approach, one first defines an action functional  $S[\phi]$ , the argument of which is a field  $\phi$  that belongs to a fixed configuration space  $\mathcal{C}$ . Then, one defines and studies the (euclidian) path integral

$$\langle \mathcal{F} \rangle = \frac{\int_{\mathcal{C}} [\mathcal{D}\phi] \mathcal{F}[\phi] e^{-S[\phi]}}{\int_{\mathcal{C}} [\mathcal{D}\phi] e^{-S[\phi]}}, \quad (1.1)$$

where  $\mathcal{F}$  belongs to a suitable class of functionals of the field. Such a framework is at the root of our current understanding of the dynamics of elementary particles, where the configuration space contains matter fields (section of various bundles over space-time) and gauge fields (connections over these bundles). For a trivial topology of these bundles, all these fields can be understood

as functions over the space-time manifold  $\mathcal{M}$ . Then the action functional involves the integral over  $\mathcal{M}$  of a Lagrangian density ultimately constructed out of pointwise products of the fields.

Over the last decade, a radical modification of this construction has proven to be of interest in mathematical physics: instead of being grounded in ordinary differential geometry, QFT can also fruitfully use the concepts introduced in *Noncommutative Geometry*. The latter is a branch of mathematics pioneered in the eighties by A. Connes (see [8] and [12] for an overview of recent developments), that extends geometrical concepts to a wide class of spaces whose coordinate algebras are noncommutative, instead of being merely functions with the pointwise product. For instance, noncommutative analogues of vector bundles, which are the natural receptacles for matter fields, are defined as projective modules over the noncommutative algebra of coordinates. Noncommutative field theory (NCFT) has grown up from the need of new methods in understanding a wide range of problems in theoretical physics, ranging from the construction of open string field theory [27] to the understanding of the dynamics of string theory [25] and M-theory [11] in magnetic backgrounds. Though not directly related to NCFT, other applications of noncommutative geometry include the geometry of aperiodic solids [3] as well as the standard model of particle physics [5].

The NCFT's involved in most of these applications are based on configuration spaces  $\mathcal{C}$  which consist of matrices with coefficients in the algebra of quantum coordinates  $\mathcal{A}$ . The latter are deformations of the commutative algebra of coordinates over space-time, with deformation parameters depending on some background. In the language of noncommutative geometry, these configuration spaces correspond to free modules, which are the analogues of trivial vector bundles. There is first success with renormalisation to all orders of such NCFT's [18]. Since noncommutative geometry is versatile enough to include non-trivial bundles as projective modules, the restriction to free modules appears to be rather unnatural. While projective modules already appear in the string theory literature (see for instance [28] and [25]), the NCFT's they naturally define has not yet been investigated. The present work aims at filling this gap, in the case of the simplest non-trivial projective modules over noncommutative tori.

This paper is organized as follows.

In section 2, we first give a general construction of the configuration space and the action functional in the framework of noncommutative geometry, making use of a spectral triple  $(\mathcal{A}, \mathcal{H}, \mathcal{D})$ . Then, we illustrate the general theory for some Heisenberg modules over  $d$ -dimensional noncommutative tori. These modules are constructed using representations of the Heisenberg group that can be formulated either using functions over  $\mathbb{R}^{\frac{d}{2}}$  or holomorphic functions on  $\mathbb{C}^{\frac{d}{2}}$ . In this last case, we illustrate how such a module appears naturally in the study of an electron on the plane in an external magnetic field, confined to its ground state in the presence of a periodic potential.

Section 3 is devoted to the construction of the NCFT based on Heisenberg modules. We first give the perturbative expansion of the path integral using a Hubbard-Stratonovitch transformation. The resulting theory makes use of planar diagrams reminiscent of rectangular matrix models and exhibits a duality symmetry. Then, we use the position space formulation to strengthen this analogy with rectangular matrices. Finally, we give the general rules for the computation of Feynman diagrams in the holomorphic representation.

In section 4 we use the holomorphic representation to compute one-loop diagrams. While the divergent planar diagrams turn out to be renormalizable by standard methods, new phenomena occur in the non-planar case. If the deformation parameter fulfills a Diophantine condition, we give explicit bounds on the amplitude showing that they are renormalized by an extra counterterm.

Section 5 deals with the effect of the new counterterm. It is shown that it is harmless and does not spoil the general properties of the NCFT.

Finally, in section 6 we compute the  $\beta$  functions for the two interacting terms.

## 2 Classical field theory

### 2.1 Projective modules in noncommutative geometry

To begin with, let us recall some basic facts about projective modules in noncommutative geometry and the way they enter in the construction of a noncommutative field theory. A much more thorough presentation of the subject can be found in [8] (see also [12] for an overview of recent developments in noncommutative geometry). Here, we restrict ourselves to the amount of material that is necessary in order to construct our noncommutative field theory.

First, we recall that the basic idea of noncommutative geometry is to replace the commutative data of a space  $\mathcal{X}$  by a possibly noncommutative algebra  $\mathcal{A}$  that plays the role of the complex-valued functions on  $\mathcal{X}$ . In general, it is necessary to assume that  $\mathcal{A}$  is a  $C^*$ -algebra, which means that it is equipped with an involution  $*$  and a norm which are compatible. This is motivated by the Gelfand-Naimark theorem which asserts that commutative  $C^*$ -algebras with unit are equivalent to compact Hausdorff spaces.

In the same spirit, the notion of a finite-dimensional complex vector bundle is extended to the noncommutative realm by first looking at the structure of its space of sections. By the Serre-Swan theorem, spaces of sections of vector bundles over  $\mathcal{X}$  are equivalent to finitely generated projective modules  $\mathcal{E}$  (projective modules for short) over the algebra of continuous functions over  $\mathcal{X}$ . Up to an isomorphism, such a module can always be realized as the right  $\mathcal{A}$ -module  $e\mathcal{A}^N$ , where  $e$  is a projection in the algebra of  $N \times N$  matrices with coefficients in  $\mathcal{A}$ . The relation between the idempotent and the standard construction of a vector bundle using transition functions goes as follows. Cover the compact space  $\mathcal{X}$  by  $N$  open sets  $\{U_i\}$  defining a good cover and let  $\sum_i |f_i|^2$  be a partition of unity associated to this cover. Using the transition functions  $g_{ij}$ , we define the  $N \times N$  matrix  $e_{ij} = f_i^* g_{ij} f_j$ , whose entries are complex-valued functions over  $\mathcal{X}$ . Then, it is straightforward to check that  $e$  is a projection using the cocycle condition  $g_{ij} = g_{ik} g_{kj}$ . Accordingly, in the general setting one defines by duality a noncommutative vector bundle to be a finitely generated projective module over a possibly noncommutative  $C^*$ -algebra. From a classical field theoretical perspective, the module  $\mathcal{E}$  is the natural receptacle for the matter fields with non-trivial topology. If the topology is trivial, these fields simply live in a free module  $\mathcal{A}^N$ , the simplest version being the algebra itself.

Rather than at the  $C^*$ -level, we will work here at the smooth one, i.e. we will assume that  $\mathcal{A}$  is a Fréchet pré- $C^*$ -algebra. This means that  $\mathcal{A}$  is a dense sub-algebra of a  $C^*$ -algebra  $A$ , which is stable under holomorphic functional calculus and which is endowed with a Fréchet topology. We will assume that the topology comes from a set of semi-norms, say  $\{p_i\}$ . Without any further structure,  $\mathcal{E}$  is simply a projective right module over  $\mathcal{A}$ ; it will be promoted to a topological vector space later on. There are many reasons why it is preferable to work at the smooth level. First, our construction of perturbative field theory relies on the theory of distributions, useless at the level of  $C^*$ -algebras and  $C^*$ -modules (our projective modules will be soon endowed with an  $\mathcal{A}$ -valued hermitian pairing promoting it to a pre- $C^*$ -module). But also for many interesting examples (e.g. Heisenberg modules and  $C^*$ -dynamical systems [10]), one does not lose any geometrical information passing from  $C^*$ - to smooth structures.

To construct a noncommutative field theory out of the previous data, one further needs a suitable space of differential forms as well as some scalar products on these forms. Differential forms are defined through a graded differential algebra:

$$\Omega(\mathcal{A}) := \bigoplus_{n \in \mathbb{N}} \Omega_n(\mathcal{A}), \quad (2.1)$$

which is a graded bi-module over  $\mathcal{A}$ , together with a nilpotent differential operator

$$d: \Omega_n(\mathcal{A}) \rightarrow \Omega_{n+1}(\mathcal{A}), \quad (2.2)$$

fulfilling the graded Leibniz rule. Note that in the general noncommutative setting, it is not assumed that  $\Omega(\mathcal{A})$  is graded commutative. Usually, one assumes that  $\Omega_0(\mathcal{A}) = \mathcal{A}$  and that  $\Omega(\mathcal{A})$  is equipped with an involution  $*$  compatible with those of  $\mathcal{A}$ . The scalar product  $\langle \cdot, \cdot \rangle_n$  on  $\Omega_n(\mathcal{A})$  is assumed to be compatible with the left and right actions of  $\mathcal{A}$ ,

$$\begin{cases} \langle \omega, \eta a \rangle_n = \langle \omega a^*, \eta \rangle_n, \\ \langle \omega, a \eta \rangle_n = \langle a^* \omega, \eta \rangle_n, \end{cases} \quad (2.3)$$

for all  $\omega, \eta \in \Omega_n(\mathcal{A})$  and  $a \in \mathcal{A}$ . In full generality, the scalar product in degree 0 is always obtained from a faithful state  $\Psi$ , i.e. a normalized positive-definite linear functional on  $\mathcal{A}$ :

$$\langle a, b \rangle_0 := \Psi(a^*b), \quad a, b \in \mathcal{A}. \quad (2.4)$$

In view of the application we have in mind, it is more appropriate to require that the state is actually a faithful trace on  $\mathcal{A}$ , so that

$$\langle a, b \rangle_0 = \text{Tr}_{\mathcal{A}}(a^*b). \quad (2.5)$$

For instance, in the simplest version of a (commutative or not) Yang-Mills theory, one starts with a topologically trivial connection given by an anti-hermitian element  $A$  of  $\Omega_1(\mathcal{A})$ , out of which we define the curvature as  $F = dA + A^2 \in \Omega_2(\mathcal{A})$ . The Yang-Mills action is then constructed as  $\langle F, F \rangle_2$ , where  $\langle \cdot, \cdot \rangle_2$  is an invariant scalar product on  $\Omega_2(\mathcal{A})$ . This invariance condition simply states that the left and right actions of  $\mathcal{A}$  are compatible with the scalar product. This ensures gauge invariance, where gauge transformations are given by unitary elements  $u \in \mathcal{A}$ , acting as

$$\begin{cases} A & \rightarrow & u^{-1}Au + u^{-1}du, \\ F & \rightarrow & u^{-1}Fu. \end{cases} \quad (2.6)$$

Such a scalar product encodes an information that goes beyond the topological level, contained in the algebra  $\mathcal{A}$  alone. For instance, in a four-dimensional Yang-Mills theory, it amounts to the choice of a conformal structure. Before we come to grips with such an issue, let us note that one can also define in full generality a noncommutative Chern-Simons theory out of a cyclic 3-cocycle [4] which is a convenient setting to develop open string field theory [27]. As a topological theory, the construction of Chern-Simons theory does not rely on such a scalar product.

Differential forms and their scalar products are conveniently constructed out of a spectral triple  $(\mathcal{A}, \mathcal{D}, \mathcal{H})$ . This involves a Hilbert space  $\mathcal{H}$  carrying a representation  $\pi$  of the algebra  $\mathcal{A}$  by bounded operators and a self-adjoint unbounded operator  $\mathcal{D}$  with compact resolvent. This data is constrained by compatibility conditions, allowing to reconstruct a smooth Riemannian manifold when  $\mathcal{A}$  is commutative. For instance, the commutators of  $\mathcal{D}$  with the elements of  $\mathcal{A}$  must extend to bounded operators. For a spectral triple, there is a notion of dimension, given by the growth of the eigenvalues of  $|\mathcal{D}|$ . More precisely, such a triple has spectral dimension  $d$  if the resolvent of  $\mathcal{D}$  belongs to the  $d$ -th weak Schatten ideal  $\mathcal{L}^{d,\infty}(\mathcal{H})$ . The latter is the ideal of compact operators whose sequence singular values (in decreasing order and counted with multiplicity) are  $\mathcal{O}(n^{-1/d})$ . With a spectral triple, one defines differential forms as a representation of the universal differential algebra

$$a_0 da_1 \cdots da_n \quad \mapsto \quad \pi(a_0) [\mathcal{D}, \pi(a_1)] \cdots [\mathcal{D}, \pi(a_n)]. \quad (2.7)$$

Such representation can be quite pathological since it may happen that the image of an element of the universal differential algebra is zero, whereas the image of the differential of this element is not! To overcome this problem, one has to divide the resulting algebra by a graded differential ideal (the so-called junk ideal). Fortunately we can ignore this point here. This is because the first non-trivial component of this ideal occurs at the level of two-forms only. However, this is

highly relevant for a proper formulation of noncommutative Yang-Mills theory in this framework. For a triple of spectral dimension  $d$ , there is a canonical way to define the scalar product between two differential forms in  $\Omega_n(\mathcal{A})$ :

$$\langle \omega, \eta \rangle_n = \text{Tr}_{\text{Dix}}(\omega^* \eta (1 + |\mathcal{D}|)^{-d}). \quad (2.8)$$

Here,  $\text{Tr}_{\text{Dix}}$  is any of the Dixmier traces. Such an object is a singular trace defined on the ideal  $\mathcal{L}^{1,\infty}(\mathcal{H})$  and is heuristically given by the coefficient of the logarithmic divergence of the ordinary operator trace (see [8] for more details on Dixmier traces). There is no point to enter here in the mathematical subtleties of the theory of Dixmier traces. This is because the operator  $(1 + |\mathcal{D}|)^{-d}$  we will consider in our example belongs to the class of ‘measurable operators’. The latter consists of elements of  $\mathcal{L}^{1,\infty}(\mathcal{H})$  for which any Dixmier trace gives the same result.

It is important to know that the Dirac operator  $\mathcal{D}$  encodes the metric aspect of noncommutative geometry and allows also to define the fermionic action for spinors  $\psi \in \mathcal{H}$  as  $\langle \psi, \mathcal{D}\psi \rangle_{\mathcal{H}}$ .

It is worthwhile to mention that the use of a spectral triple to construct noncommutative field theory is highly convenient (mainly because it allows to define differential forms with scalar products in a canonical way) but not necessary. Indeed, our construction is much more general and works for any differential calculus with scalar products on each component.

Turning back to the projective module  $\mathcal{E}$ , one has to define a connection  $\nabla$ . This is an operator that extends to elements of  $\mathcal{E}$  the differential of a given differential calculus  $(\Omega(\mathcal{A}), d)$ . In general, a connection is a linear map

$$\nabla: \mathcal{E} \rightarrow \mathcal{E} \otimes_{\mathcal{A}} \Omega_1(\mathcal{A}), \quad (2.9)$$

fulfilling the Leibniz rule

$$\nabla(\phi a) = \nabla(\phi) a + \phi \otimes da, \quad (2.10)$$

for any  $\phi \in \mathcal{E}$  and  $a \in \mathcal{A}$ . The projective module  $\mathcal{E}$  is further equipped with a hermitian structure  $(\cdot, \cdot)_{\mathcal{A}}: \mathcal{E} \times \mathcal{E} \rightarrow \mathcal{A}$ , which is an  $\mathcal{A}$ -valued sesquilinear form on  $\mathcal{E}$ , satisfying the following compatibility and positivity conditions:

$$\begin{cases} (\phi, \chi a)_{\mathcal{A}} = (\phi, \chi)_{\mathcal{A}} a, \\ (\phi, \chi)_{\mathcal{A}} = (\chi, \phi)_{\mathcal{A}}^*, \\ (\phi, \phi)_{\mathcal{A}} \geq 0, \end{cases} \quad (2.11)$$

for all  $\phi, \chi \in \mathcal{E}$  and  $a \in \mathcal{A}$ . We recall that  $a$  is a positive element of  $\mathcal{A}$  if it can be written as  $a = b^* b$  with  $b \in \mathcal{A}$ . Besides, the connection has to be compatible with the hermitian structure in the sense that

$$d(\phi, \chi)_{\mathcal{A}} = (\nabla\phi, \chi)_{\mathcal{A}} + (\phi, \nabla\chi)_{\mathcal{A}}, \quad (2.12)$$

for all  $\phi, \chi \in \mathcal{E}$ . We would like to stress that the field theory we are constructing is Euclidean, precisely because the pairing (2.11) is positive definite.

As a side remark, let us note that one can define the curvature of  $\nabla$  as  $F = \nabla^2$ , where  $\nabla$  has been extended by the Leibniz rule to  $\mathcal{E} \otimes_{\mathcal{A}} \Omega(\mathcal{A})$ . This is the starting point for the development of a general gauge theory in the framework of noncommutative geometry.

Within the supplementary structure of an hermitian  $\mathcal{A}$ -valued pairing,  $\mathcal{E}$  can be promoted to a topological vector space in different ways. When  $\mathcal{A}$  comes from a  $C^*$ -algebra  $A$ ,  $\mathcal{E}$  is called a pré-Hilbert module and it can be completed with respect to the norm  $\|\phi\| := \sqrt{\|(\phi, \phi)_{\mathcal{A}}\|}$ , where  $\|\cdot\|$  denotes the  $C^*$ -norm of  $A$ . The resulting Banach space is obviously called a right Hilbert- or  $C^*$ -module. One can also define a Fréchet topology on  $\mathcal{E}$ , finer than the  $C^*$  one, via the semi-norms  $\{p_i\}$  of  $\mathcal{A}$ , setting  $q_i(\phi) := \sqrt{p_i(\|(\phi, \phi)_{\mathcal{A}}\|)}$ , for all  $\phi \in \mathcal{E}$ . When  $\mathcal{E}$  is complete with respect to this topology, that we will assume from now on, we will call it a Fréchet projective

right  $\mathcal{A}$ -module. Finally, when  $\mathcal{A}$  possesses a faithful trace  $\text{Tr}_{\mathcal{A}}$ ,  $\mathcal{E}$  can be completed to an Hilbert space  $\mathcal{H}_{\mathcal{E}}$  using the scalar product  $\langle \cdot, \cdot \rangle_{\mathcal{E}}$ , obtained by composition of the trace with the hermitian structure:

$$\langle \phi, \chi \rangle_{\mathcal{E}} := \text{Tr}_{\mathcal{A}} [(\phi, \chi)_{\mathcal{A}}]. \quad (2.13)$$

We use the notation  $\mathcal{H}_{\mathcal{E}}$  for this Hilbert space, in order to emphasize its canonical nature, once a trace and an hermitian structure are given.

If we realize the projective module as  $e\mathcal{A}^N$  for some hermitian idempotent  $e \in M_N(\mathcal{A})$ , then a connection is easily defined as  $\nabla(e\xi) := ed(e\xi) + eAe\xi$ ,  $\xi \in \mathcal{A}^N$ , where  $A$  is an anti-hermitian matrix in  $M_N(\mathcal{A})$ . In this case, the hermitian structure is given by  $(e\xi, e\zeta)_{\mathcal{A}} := \xi^* e \zeta$ , and the compatibility of the connection follows from  $(eAe)^* = -eAe$ .

Finally, let us construct a functional action for a classical field  $\phi$  in a projective module  $\mathcal{E}$ . To this aim, we have to extend the scalar product  $\langle \cdot, \cdot \rangle_1$  on  $\Omega_1(\mathcal{A})$  to a scalar product on  $\mathcal{E} \otimes_{\mathcal{A}} \Omega_1(\mathcal{A})$ . It will allow to construct the kinetic term out of  $\nabla\phi$ . Let us construct this scalar product on  $\mathcal{E} \otimes_{\mathcal{A}} \Omega_n(\mathcal{A})$ , for any  $n \in \mathbb{N}$ . For  $\Phi, \Psi \in \mathcal{E} \otimes_{\mathcal{A}} \Omega_n(\mathcal{A})$ , we write

$$\Phi = \sum_i \phi_i \otimes \omega_i, \quad \Psi = \sum_i \psi_i \otimes \eta_i, \quad (2.14)$$

with  $\phi_i, \psi_i \in \mathcal{E}$  and  $\omega_i, \eta_i \in \Omega_n(\mathcal{A})$ . Then, one can define the scalar product  $\langle \cdot, \cdot \rangle_{\mathcal{A},n}$  using both  $\langle \cdot, \cdot \rangle_n$  and  $(\cdot, \cdot)_{\mathcal{A}}$ :

$$\langle \Phi, \Psi \rangle_{\mathcal{A},n} := \sum_{i,j} \langle \omega_i, (\phi_i, \psi_j)_{\mathcal{A}} \eta_j \rangle_n. \quad (2.15)$$

In particular, it allows to define the kinetic term as

$$\langle \nabla\phi, \nabla\phi \rangle_{\mathcal{A},1}. \quad (2.16)$$

To construct the mass term, we simply use the scalar product (2.13):

$$\mu_0^2 \langle \phi, \phi \rangle_{\mathcal{E}} = \mu_0^2 \text{Tr}_{\mathcal{A}} [(\phi, \phi)_{\mathcal{A}}]. \quad (2.17)$$

For the interaction term, which should be a polynomial in the field, we can extend the former construction. For instance, the basic  $\lambda\phi^4$  interaction reads

$$\frac{\lambda}{2} \text{Tr}_{\mathcal{A}} [(\phi, \phi)_{\mathcal{A}}^2]. \quad (2.18)$$

More generally, one can construct arbitrary monomials

$$\frac{\lambda}{n} \text{Tr}_{\mathcal{A}} [(\phi, \phi)_{\mathcal{A}}^n]. \quad (2.19)$$

We may also consider products of such terms. Despite they look very unnatural with respect to ordinary QFT, they should be needed to obtain a stable quantum theory; stable with respect to the renormalization group flow. We will see in the next sections that for a  $\phi_4^4$  theory on the Heisenberg module, such a ‘product of trace’ term is precisely the missing term which will allow to cure the UV/IR mixing problem.

The basic action we shall use in the sequel reads

$$S[\phi, \phi^\dagger] := \langle \nabla\phi, \nabla\phi \rangle_{\mathcal{A},1} + \mu_0^2 \text{Tr}_{\mathcal{A}} [(\phi, \phi)_{\mathcal{A}}] + \frac{\lambda}{2} \text{Tr}_{\mathcal{A}} [(\phi, \phi)_{\mathcal{A}}^2]. \quad (2.20)$$

Here we have followed the traditional notation of QFT where a complex field  $\phi$  and its conjugate  $\phi^\dagger$  are treated as independent variables. In our setting,  $\phi^\dagger$  has to be considered as an element of the dual module  $\mathcal{E}^*$  which consists of  $\mathcal{A}$ -linear forms on  $\mathcal{E}$ , defined by

$$\phi^\dagger(\chi) := (\phi, \chi)_{\mathcal{A}}, \quad (2.21)$$

for any  $\chi \in \mathcal{A}$ . This distinction between  $\phi$  and  $\phi^\dagger$  will prove to be very convenient when developing the perturbative path integral approach, for instance in getting the right symmetry factors. However, it is important to notice that  $\mathcal{E}^*$  is not the topological dual of  $\mathcal{E}$ . Moreover, it should be clear that  $\mathcal{E}^* \simeq \mathcal{E}$  as a linear space, the identification being given by  $\phi \leftrightarrow (\phi, \cdot)_{\mathcal{A}}^* = (\cdot, \phi)_{\mathcal{A}}$ . Also,  $\mathcal{E}^*$  carries the same Fréchet topology than  $\mathcal{E}$ .

In the case of a field theory constructed out of a spectral triple, we would like to stress that the choice of the order  $n$  of the monomials (2.19) involved in the interaction term depends on the spectral dimension of the triple  $d$ . In the general setting,  $n$  should be related to the spectral properties of the propagator, which is the bounded operator on  $\mathcal{H}_{\mathcal{E}}$  given by the inverse of the (densely defined) positive operator  $H$ , corresponding to the quadratic part of the action (2.20). More precisely,  $H$  is defined in terms of the following quadratic form on  $\mathcal{E}$

$$\langle \phi, H\chi \rangle_{\mathcal{E}} := \langle \nabla\phi, \nabla\chi \rangle_{\mathcal{A},1}, \quad \phi, \chi \in \mathcal{E} \subset \mathcal{H}_{\mathcal{E}}. \quad (2.22)$$

It is precisely because we are going to study a model coming from a spectral triple of spectral dimension 4 that we focus on quartic interaction.

It may seem to be quite restrictive to ask for the existence of a faithful trace to define the classical action. Faithfulness is required in order that the quantum theory has a power-counting properly related to the spectral properties of the propagator of the model. But traciality is not needed at all, it simply makes the noncommutative models closer to the commutative one. For instance, there are numerous noncommutative algebras giving rise to non-trivial spectral triples (e.g.  $SU_q(2)$  [14]), that do not possess any faithful trace. In such circumstance, one can define the classical theory by replacing everywhere the trace  $\text{Tr}_{\mathcal{A}}$  by a faithful state  $\Psi$  on  $\mathcal{A}$ .

It is also worthwhile to notice that this theory is naturally coupled to gauge fields since it is invariant under

$$\begin{cases} \phi & \rightarrow u\phi \\ \nabla & \rightarrow u \otimes 1_{\Omega_1(\mathcal{A})} \nabla u^{-1}, \end{cases} \quad (2.23)$$

where  $u$  is a unitary element of the algebra  $\mathcal{B} := \text{End}_{\mathcal{A}}(\mathcal{E})$  of  $\mathcal{A}$ -linear transformations of  $\mathcal{E}$ . Thus the gauge invariant action for the field  $\phi$  coupled to a Yang-Mills connection  $\nabla$  reads

$$S[\phi, \phi^\dagger, \nabla] := \langle F, F \rangle_2 + \langle \nabla\phi, \nabla\phi \rangle_{\mathcal{A},1} + \mu_0^2 \text{Tr}_{\mathcal{A}}[(\phi, \phi)_{\mathcal{A}}] + \frac{\lambda}{2} \text{Tr}_{\mathcal{A}}[(\phi, \phi)_{\mathcal{A}}^2], \quad (2.24)$$

which involves the scalar product  $\langle \cdot, \cdot \rangle_2$  on the space of 2-forms  $\Omega_2(\mathcal{A})$ . As already mentioned, in the context of spectral triple, the curvature is in principle an equivalence class of 2-forms (modulo the junk ideal). However, we still ignore this point since we are not going to include a gauge degree of freedom when developing the quantum theory. For that reason, it is preferable to stick to the action functional (2.20).

## 2.2 Noncommutative tori

### 2.2.1 Geometric structures

Let us now work out the previous construction in the case of a  $d$ -dimensional smooth noncommutative torus. The latter is defined through its algebra of coordinates,  $\mathcal{A}_{\Theta}$ , which is the algebra of all power series  $a = \sum_{\gamma \in \mathbb{Z}^d} a_{\gamma} U_{\gamma}$ , with fast decreasing coefficients  $\{a_{\gamma}\} \in \mathcal{S}(\mathbb{Z}^d)$ . Here,  $U_{\gamma}$  are unitary elements of  $\mathcal{A}_{\Theta}$  fulfilling

$$U_{\gamma} U_{\gamma'} = e^{-i\pi\Theta(\gamma, \gamma')} U_{\gamma+\gamma'}, \quad (2.25)$$

where  $\Theta$  is a skew-symmetric real  $d \times d$  matrix which defines a 2-cocycle on the group  $\mathbb{Z}^d \subset \mathbb{R}^d$ . The algebra  $\mathcal{A}_{\Theta}$  is endowed with its natural Fréchet topology, coming from the set of semi-norms  $p_n(a) = \sup_{\gamma \in \mathbb{Z}^d} ((1 + |\gamma|^2)^n |a_{\gamma}|)$ ,  $n \in \mathbb{N}$ ,  $a \in \mathcal{A}_{\Theta}$ . In analogy with its commutative counterpart,

where the unitaries  $U_\gamma$ 's are nothing but the Fourier modes, the smoothness condition relies on the rapid decay of the sequence  $\{a_\gamma\}$ .

The structure of this algebra depends on the arithmetical properties of the entries of the matrix  $\Theta$ . Three typical cases have to be distinguished.

- If all the entries of  $\Theta$  are integers, then the algebra  $\mathcal{A}_\Theta$  is commutative and can be identified with the algebra of smooth functions on an ordinary torus.
- If all the entries of  $\Theta$  are rational numbers, then  $\mathcal{A}_\Theta$  can be realized as a bundle of matrix algebras over an ordinary torus. This is clear for  $d = 2$ , where the unique parameter  $\theta = p/q$  in  $\Theta$  determines the size of the matrices to be  $q$ . The general case follows from reducing the matrix  $\Theta$  to a direct sum of  $2 \times 2$  matrices plus a zero matrix (that corresponds to the null space of  $\Theta$ ), using a transformation in  $SL(d, \mathbb{Z})$ . The algebra of functions over the underlying torus is nothing but the center of  $\mathcal{A}_\Theta$ .
- If all the entries of  $\Theta$  are irrational numbers and  $\Theta$  is invertible, then the center of the algebra is trivial and  $\mathcal{A}_\Theta$  is a noncommutative space that cannot be reduced to an ordinary space.

In our analysis of noncommutative field theories, we are mostly interested in the irrational case that exhibits some new phenomena. However, it is also interesting to keep in mind the first two cases since they can always be understood in the context of commutative field theories with matrix-valued fields. In the discussion of the non-planar diagrams, it will be necessary to single out irrational numbers that fulfill a Diophantine condition. The latter are irrational numbers that are 'far away from the rationals'. The use of the Diophantine condition is not infrequent in noncommutative geometry. For instance, it appears to be crucial in the computation of the Hochschild cohomology of  $\mathcal{A}_\Theta$  [9], as well as for the heat-invariants [17].

The differential algebra can be constructed out of the  $d$  commuting derivations

$$\delta_\mu(U_\gamma) := 2i\pi\gamma_\mu U_\gamma, \quad \gamma = (\gamma_1, \dots, \gamma_d) \in \mathbb{Z}^d, \quad (2.26)$$

which is the infinitesimal form of the proper action of  $\mathbb{T}^d$  on  $\mathcal{A}_\Theta$  given by

$$(e^{2i\pi\alpha_1}, \dots, e^{2i\pi\alpha_d}) \cdot U(\gamma) := e^{2i\pi\alpha \cdot \gamma} U(\gamma). \quad (2.27)$$

Elements of  $\Omega_n(\mathcal{A}_\Theta)$  are completely antisymmetric multiplets  $\omega_{\mu_1, \dots, \mu_n}$  of  $\mathcal{A}_\Theta$ . The multiplication and the differential in  $\Omega(\mathcal{A}_\Theta)$  obey the same algebraic rules as the wedge product and the de Rham differential. The algebra  $\mathcal{A}_\Theta$  has a faithful trace  $\text{Tr}_{\mathcal{A}_\Theta}$  defined by

$$\text{Tr}_{\mathcal{A}_\Theta} \left( \sum_{\gamma \in \mathbb{Z}^d} a_\gamma U_\gamma \right) := a_0. \quad (2.28)$$

If  $\mathcal{A}_\Theta$  is commutative, this trace is nothing but the integral over the underlying torus, with a volume normalized to 1. In the irrational case,  $\text{Tr}_{\mathcal{A}_\Theta}$  is the unique faithful trace up to normalization. The scalar product on  $\Omega_n(\mathcal{A}_\Theta)$  is made out of the trace

$$\langle \omega, \eta \rangle_n := \text{Tr}_{\mathcal{A}_\Theta} (\omega_{\mu_1 \dots \mu_n}^* \eta^{\mu_1, \dots, \mu_n}), \quad (2.29)$$

where the euclidian metric and Einstein's summation convention have been used. This construction follows readily from the general principles, using the spectral triple  $(\mathcal{A}_\Theta, \mathcal{H}, \mathcal{D})$  where  $\mathcal{H} = A_\Theta^{2[d/2]}$ , with  $A_\Theta$  the completion of  $\mathcal{A}_\Theta$  with respect to the norm induced by the scalar product  $\langle a, b \rangle_{\mathcal{A}_\Theta} := \text{Tr}_{\mathcal{A}_\Theta}(a^*b)$  and where  $\mathcal{D} = i\Gamma^\mu \delta_\mu$  is the standard euclidian Dirac operator. Note that a noncommutative torus is a noncommutative manifold without boundary, in the sense that the integral of a derivative always vanishes:  $\text{Tr}_{\mathcal{A}_\Theta}(\delta_\mu U_\gamma) = 0$ . This relation is particularly useful in the study of classical field theories, because it allows to derive classical field equations and invariance laws.

### 2.2.2 Heisenberg modules

A wide class of projective modules over  $\mathcal{A}_\Theta$  can be constructed as projective representations of groups of the type  $G \times \widehat{G}$  with  $G = \mathbb{R}^p \times \mathbb{Z}^q \times F$ , where  $F$  is a finite Abelian group and  $\widehat{G}$  the dual of  $G$  [24]. Equivalently, these projective representations can be thought of as representations of the Heisenberg groups associated to the corresponding central extensions. The group  $G \times \widehat{G}$  acts by unitary operators on the Hilbert space  $L^2(G, dg)$  obtained by completion of the space of smooth fast decreasing functions  $\mathcal{S}(G)$  on  $G$ . For  $(g, \mu) \in G \times \widehat{G}$  and  $\psi \in L^2(G, dg)$ , the action is

$$T_{g,\mu}\psi(x) := \mu(g)^{1/2} \mu(x) \psi(x + g). \quad (2.30)$$

Then, given a lattice  $\Gamma$  isomorphic to  $\mathbb{Z}^d$  in  $G \times \widehat{G}$ , one can represent the algebra  $\mathcal{A}_\Theta$  (acting on the right) on  $L^2(G, dg)$  by restricting the action (2.30) to the sub-group  $\Gamma$ :

$$\phi U_\gamma := T_{g,\mu}\phi, \quad \phi \in L^2(G, dg), \quad \gamma = (g, \mu) \in \Gamma. \quad (2.31)$$

The multiplication law of the algebra  $\mathcal{A}_\Theta$  is satisfied with the so-called Heisenberg cocycle:  $e^{-2i\pi\Theta(\gamma,\gamma')} := \mu(g')\mu'(g)^{-1}$ . If we assume that  $(G \times \widehat{G})/\Gamma$  is compact, then  $\mathcal{E}_\mathcal{S} := \mathcal{S}(G)$  is a finitely generated projective module called the Heisenberg module. In particular, this forces the dimension of the noncommutative torus  $d$  to be even. This means that for  $a \in \mathcal{A}_\Theta$  and  $\phi \in \mathcal{E}_\mathcal{S}$  then  $\phi a = \sum_\gamma a_\gamma \phi U_\gamma$  is well defined as an element of  $\mathcal{E}_\mathcal{S}$ . This can be proven by elementary Fourier analysis. This module is equipped with a  $\mathcal{A}_\Theta$ -valued scalar product defined by

$$(\phi, \chi)_{\mathcal{A}_\Theta} := \sum_{\gamma \in \Gamma} \langle \phi, \chi U_\gamma \rangle_{L^2(G, dg)} U_{-\gamma}. \quad (2.32)$$

This pairing takes values in the smooth algebra  $\mathcal{A}_\Theta$  and not in its  $C^*$ -completion. Again, basic Fourier analysis shows that the sequence  $\{\langle \phi, \chi U_\gamma \rangle_{L^2(G, dg)}\}_{\gamma \in \mathbb{Z}^d}$  is of Schwartz class whenever  $\phi, \chi \in \mathcal{E}_\mathcal{S}$ .

A connection on  $\mathcal{E}_\mathcal{S}$  is entirely specified by its covariant derivatives  $\nabla_\mu$ , once we have identified  $\Omega_1(\mathcal{A}_\Theta)$  with  $(\mathcal{A}_\Theta)^d$ . The canonical Heisenberg connection  $\nabla$  is obtained from the infinitesimal action of the continuous part of the group  $G \times \widehat{G}$ . In general, it both involves partial derivatives  $\frac{\partial}{\partial x_i}$  (action of  $\mathbb{R}^p$ ) and multiplication by  $x_i$  (action of  $(\mathbb{R}^p)^*$ ). Finally, it is also useful to note that the endomorphism algebra  $\text{End}_{\mathcal{A}_\Theta}(\mathcal{E}_\mathcal{S})$  is nothing but another noncommutative torus generated by the dual lattice  $\widehat{\Gamma} \in \widehat{G} \times G$ , which pairs trivially with  $\Gamma$  with respect to the Heisenberg cocycle.

Besides, the curvature of  $\nabla$  is defined as  $F_{\mu\nu} := [\nabla_\mu, \nabla_\nu]$ , which is always an anti-hermitian element of  $\text{End}_{\mathcal{A}_\Theta}(\mathcal{E}_\mathcal{S})$ .

To construct the action functional for a classical field  $\phi \in \mathcal{E}_\mathcal{S}$ , we choose a constant positive definite matrix  $g_{\mu\nu}$  to define a scalar product between 1-forms, so that the general form of the action given by (2.20) is

$$S[\phi, \bar{\phi}] = \sqrt{g} g^{\mu\nu} \text{Tr}_{\mathcal{A}_\Theta} [(\nabla_\mu \phi, \nabla_\nu \phi)_{\mathcal{A}_\Theta}] + \sqrt{g} \mu_0^2 \text{Tr}_{\mathcal{A}_\Theta} [(\phi, \phi)_{\mathcal{A}_\Theta}] + \sqrt{g} \frac{\lambda}{2} \text{Tr}_{\mathcal{A}_\Theta} [(\phi, \phi)_{\mathcal{A}_\Theta}^2], \quad (2.33)$$

with  $g^{\mu\nu}$  denoting the inverse of  $g_{\mu\nu}$  and  $g$  its determinant. Since the module we consider is made out of complex-valued functions, from now on, we denote an element of the dual module  $\mathcal{E}_\mathcal{S}$  by  $\bar{\phi}$ . Note that more general terms such as

$$\left[ \text{Tr}_{\mathcal{A}_\Theta} [(\phi, \phi)_{\mathcal{A}_\Theta}]^n \right]^k, \quad (2.34)$$

can be introduced. In the last section, we shall see that for  $d = 4$ , the renormalization forces the introduction of such a term with  $n = 1$ ,  $k = 2$ .

The simplest example of a Heisenberg module is constructed explicitly for  $d = 2$  as follows. In the two-dimensional case there is only one deformation parameter in the matrix  $\Theta$ , namely  $\theta$ . We will denote by  $\mathcal{A}_\theta$  the corresponding noncommutative torus algebra. In this case, we start with the projective representation (2.30) of  $\mathbb{R} \times (\mathbb{R})^*$  on the Schwartz space of the real line. Then, one defines the lattice  $\Gamma$  and its dual  $\widehat{\Gamma}$  as

$$\begin{cases} \Gamma := \{\gamma = (\theta m, 2\pi n) & \text{with } m, n \in \mathbb{Z}\}, \\ \widehat{\Gamma} := \{\widehat{\gamma} = (m', \frac{2\pi n'}{\theta}) & \text{with } m', n' \in \mathbb{Z}\}, \end{cases} \quad (2.35)$$

with  $\theta > 0$ . The lattices  $\Gamma$  and  $\widehat{\Gamma}$  define two commuting noncommutative torus algebras  $\mathcal{A}_\theta$  and  $\text{End}_{\mathcal{A}_\theta}(\mathcal{E}_S) = \mathcal{A}_{1/\theta}$ , acting on  $\phi \in \mathcal{E}_S$  as

$$\begin{cases} (\phi U_\gamma)(x) := e^{i\pi\theta mn} e^{2i\pi n x} \phi(x + m\theta), \\ (U_{\widehat{\gamma}}\phi)(x) := e^{i\frac{\pi mn}{\theta}} e^{\frac{2i\pi n' x}{\theta}} \phi(x + m'). \end{cases} \quad (2.36)$$

In the previous equation, we have identified  $(\mathbb{R} \times \mathbb{R}^*)^* = \mathbb{R}^* \times \mathbb{R}$  with  $\mathbb{R} \times \mathbb{R}^*$  so that the lattice and its dual are both subsets of  $\mathbb{R} \times \mathbb{R}^*$ .

The  $\mathcal{A}_\theta$ -valued scalar product follows from the general form (2.32) and is explicitly given by

$$(\phi, \chi)_{\mathcal{A}_\theta} = \sum_{\gamma \in \Gamma} \left( e^{i\pi\theta mn} \int_{\mathbb{R}} dx \bar{\phi}(x) e^{2i\pi n x} \chi(x + m\theta) \right) U_{-\gamma}. \quad (2.37)$$

The Heisenberg connection is given by the two covariant derivatives

$$\nabla_1 \phi(x) = -\frac{2i\pi x}{\theta} \phi(x) \quad \text{and} \quad \nabla_2 \phi(x) = \frac{d\phi(x)}{dx}. \quad (2.38)$$

This connection minimize the Yang-Mills action [13] and has a constant curvature given by

$$F_{12} = [\nabla_1, \nabla_2] = \frac{2i\pi}{\theta}. \quad (2.39)$$

In this example, with the euclidian metric  $g_{\mu\nu} = \delta_{\mu\nu}$ , the action functional (2.33) reads

$$\begin{aligned} S[\phi, \bar{\phi}] := & \int_{\mathbb{R}} dx \bar{\phi}(x) \left( -\frac{d^2}{dx^2} + \frac{4\pi^2}{\theta^2} x^2 \right) \phi(x) + \mu_0^2 \int_{\mathbb{R}} dx \bar{\phi}(x) \phi(x) \\ & + \frac{\lambda}{2} \sum_{m, n \in \mathbb{Z}} \int_{\mathbb{R}} dx \bar{\phi}(x + n + m\theta) \phi(x + n) \bar{\phi}(x) \phi(x + m\theta). \end{aligned} \quad (2.40)$$

To derive this expression from (2.37), we used the Poisson re-summation formula in the sense of tempered distributions to write  $\sum e^{2i\pi n x} = \sum \delta(x + n)$ . The kinetic part of this action is simply the energy of an harmonic oscillator. The interaction takes a non-local form in  $x$ -space because of the summation over  $m$  and  $n$ , but reduces to the an-harmonic oscillator for  $m = n = 0$ . We shall further comment on the non-local structure of this interaction in section 3.3.1, once we have derived the Feynman rules.

So far, we have seen that for the Heisenberg module there are two notions of dimension. The first one,  $d$ , is the spectral dimension of the noncommutative torus, whereas the second,  $d/2$ , is the dimension of the representation space entering in  $\mathcal{E}_S(\mathbb{R}^{d/2}) = \mathcal{S}(\mathbb{R}^{d/2})$ . In the sequel, in view of quantum field application, we will see that the pertinent notion of dimension is those of the noncommutative torus. In the following and unless otherwise specified,  $d$  will always denote the dimension of the noncommutative torus, which moreover has to be even.

### 2.2.3 Symmetries and field equation

We are now going to review the classical discrete symmetries of the Model. First note that this action is invariant under a version of the Langmann-Szabo duality [23]. If we replace  $\phi$  by its Fourier transform

$$\eta(\xi) = \int_{\mathbb{R}} dx e^{-2i\pi x\xi} \phi(x), \quad (2.41)$$

then the action is invariant, up to a rescaling of the different parameters:

$$S_{\lambda, \mu_0, \theta}[\phi, \bar{\phi}] = \frac{1}{\theta^2} S_{\theta\lambda, \theta^2\mu_0, 1/\theta}[\eta, \bar{\eta}]. \quad (2.42)$$

This duality is an essential tool in the study of the renormalizability of the model.

Besides the Langmann-Szabo duality, there is another discrete symmetry involving the Fourier transform. This symmetry is related to the action of the modular group  $SL(2, \mathbb{Z})$  on the modulus  $\tau$  in the upper half plane. Here  $\tau$  parameterizes the constant matrix of determinant one, entering in the kinetic term as

$$g = \frac{1}{\Im(\tau)} \begin{pmatrix} 1 & \Re(\tau) \\ \Re(\tau) & |\tau|^2 \end{pmatrix}. \quad (2.43)$$

Then, the action is invariant under simultaneous changes of the field and the modulus under the generators  $S$  and  $T$  of the modular group,

$$\begin{cases} S : \phi(x) \rightarrow \frac{1}{\sqrt{\theta}} \int_{\mathbb{R}} d\xi e^{\frac{-2i\pi x\xi}{\theta}} \phi(\xi), & \tau \rightarrow -\frac{1}{\tau}, \\ T : \phi(x) \rightarrow e^{\frac{-i\pi x^2}{\theta}} \phi(x), & \tau \rightarrow \tau + 1. \end{cases} \quad (2.44)$$

For such a metric, the Langmann-Szabo duality must also be accompanied by the action of  $S$  on the modulus. The transformations given by  $S$  and  $T$  define outer automorphisms of the algebra of the noncommutative torus and correspond to large diffeomorphisms of the torus. Other outer automorphisms are given by the translations defined in (2.27), but they do not leave the action invariant because of the non-trivial connection. Translation invariance can only be recovered by including gauge fields.

We have displayed the construction in the two dimensional case with the simplest Heisenberg module. More general modules can easily be obtained in any even dimension by simply tensoring this module by itself  $d/2$  times. In this case the action takes the same form as in (2.40) with  $x$ ,  $m$  and  $n$  replaced by  $d/2$ -dimensional vectors. The Langmann-Szabo duality takes the same form as before except that the coupling constant  $\lambda$  transforms as

$$\lambda \rightarrow \lambda \theta^{2 - \frac{d}{2}}. \quad (2.45)$$

In particular, the coupling constant is invariant in four dimensions.

It is also interesting to look at the classical field equation:

$$\frac{\delta S[\phi, \bar{\phi}]}{\delta \bar{\phi}} = 0, \quad \frac{\delta S[\phi, \bar{\phi}]}{\delta \phi} = 0, \quad (2.46)$$

where, as usual, the functional derivatives are defined in the weak sense, with respect to the pairing (2.13). Because the action is ‘‘symmetric’’ in  $\phi$  and  $\bar{\phi}$ , it is sufficient to look at one of them. The first one reads

$$H\phi = -\lambda \phi(\phi, \phi)_{\mathcal{A}_\theta} = -\lambda \sum_{\gamma \in \Gamma} \langle \phi, \phi U_\gamma \rangle_{L^2(\mathbb{R})} \phi U_{-\gamma}, \quad (2.47)$$

where

$$H := -\frac{d^2}{dx^2} + \frac{4\pi^2}{\theta^2}x^2 + \mu_0^2 \quad (2.48)$$

is the harmonic oscillator Hamiltonian with frequency  $2\pi/\theta$ . In the explicit realization of the module  $\mathcal{E}_S = \mathcal{S}(\mathbb{R})$ , the field equation can be rewritten as

$$\left(-\frac{d^2}{dx^2} + \frac{4\pi^2}{\theta^2}x^2 + \mu_0^2\right)\phi(x) = -\lambda \sum_{n,m \in \mathbb{Z}} \phi(x+n) \bar{\phi}(x+n+m\theta) \phi(x+m\theta). \quad (2.49)$$

A very important task would be to study the solutions of the classical field equation.

### 2.3 Holomorphic representation

For our purposes it is convenient to work with an equivalent representation of the Heisenberg modules in terms of holomorphic functions. In the general case, these are constructed out of the space of square integrable holomorphic functions on  $\mathbb{C}$  with respect to the scalar product

$$\langle \phi, \chi \rangle_B := \int d\mu(z, \bar{z}) \bar{\phi}(\bar{z}) \chi(z), \quad (2.50)$$

with the Gaussian measure, normalized as  $d\mu(z, \bar{z}) := (\omega/\pi) e^{-\omega|z|^2} d\Re(z) d\Im(z)$ , and  $\omega > 0$  is an arbitrary parameter. We denote by  $\mathcal{H}_B := L_{hol}^2(\mathbb{C}, d\mu)$  the corresponding Hilbert space. It also admits a projective representation of  $\mathbb{C} \simeq \mathbb{R} \times \mathbb{R}^*$  given by

$$(T_v \phi)(z) := e^{-\frac{\omega|v|^2}{2} - \omega \bar{v}z} \phi(z+v), \quad v \in \mathbb{C}. \quad (2.51)$$

The operators  $T_v$  are unitary with respect to the scalar product  $\langle \cdot, \cdot \rangle_B$  and obey to the multiplication rule

$$T_v T_w = e^{\frac{\omega}{2}(\bar{v}w - \bar{w}v)} T_{v+w}. \quad (2.52)$$

Let us choose a square lattice in  $\mathbb{C}$  parametrized by  $l > 0$ ,

$$\Gamma := \{\gamma = l(m + in) \quad \text{with} \quad (m, n) \in \mathbb{Z}^2\}. \quad (2.53)$$

One can define a right action  $U_\gamma$  of  $\mathcal{A}_\theta$ , with  $\theta = \frac{\omega l^2}{\pi}$ , by restricting the action (2.51) to the lattice  $\Gamma$ , i.e.  $\phi U_\gamma := T_\gamma \phi$ ,  $\gamma \in \Gamma$ . Here and in the following, we made a slight abuse of notation by denoting by  $U_\gamma$  an element of  $\mathcal{A}_\theta$  as well as the operator acting on the right on  $\mathcal{H}_B$ . Note that in this framework, the dual lattice is given by

$$\hat{\Gamma} := \{\hat{\gamma} = \frac{\pi}{\omega l}(m' + in') \quad \text{with} \quad (m', n') \in \mathbb{Z}^2\}, \quad (2.54)$$

and gives rise to an action of  $\mathcal{A}_{1/\theta}$ . The scalar product with values in the algebra  $\mathcal{A}_\theta$  is defined as in (2.32), with  $\langle \cdot, \cdot \rangle_B$  denoting the Bargmann scalar product:

$$(\phi, \chi)_{\mathcal{A}_\theta} = \sum_{\gamma \in \Gamma} \langle \phi, \chi U_\gamma \rangle_B U_{-\gamma}. \quad (2.55)$$

The connection follows from the infinitesimal action of the translation group on  $\mathcal{H}_B$ . It reads

$$\nabla_1 \phi(z) = \frac{\pi}{i\omega l R} \left[ \frac{d\phi}{dz}(z) + \omega z \phi(z) \right] \quad \text{and} \quad \nabla_2 \phi(z) = \frac{\pi}{\omega l R} \left[ \frac{d\phi}{dz}(z) - \omega z \phi(z) \right], \quad (2.56)$$

and of course they fulfil the Leibniz rule  $\nabla_i(\phi U_\gamma) = (\nabla_i \phi) U_\gamma + \phi(\delta_i U_\gamma)$ ,  $i = 1, 2$ , where the derivations of  $\mathcal{A}_\theta$  have been defined in (2.26). Note that we have introduced an extra parameter  $R > 0$

which has the dimension of a length and has to be thought as the ‘radius’ of the noncommutative torus. It is to be noted that this connection has constant curvature  $F_{12} = [\nabla_1, \nabla_2] = \frac{2i\pi^2}{kl^2R^2}$  and that  $\text{Tr}_{\mathcal{A}_\theta} [F_{12}] = 2i\pi \frac{\pi}{kl^2}$ . This provides a topological invariant of the bundle, analogous to the first Chern class. Usually, one includes the factor  $\frac{\pi}{kl^2}$  in the trace since it corresponds to the *dimension* of the bundle [12]. Therefore, the topological invariant belongs to  $2i\pi\mathbb{Z}$ , which holds for arbitrary projective modules and arbitrary connections over a two-dimensional noncommutative torus.

From a physical point of view, the Bargmann module appears in the analysis of the motion of an electron confined to the  $x, y$  plane in an external uniform magnetic field of strength  $B$  along an orthogonal axis. If we denote by  $-e$  and  $m$  the charge and the mass of the electron, the Hamiltonian is, in the Landau gauge,

$$H_L = -\frac{\hbar^2}{2m} \left[ \left( \frac{\partial}{\partial x} - \frac{ieB}{2\hbar} y \right)^2 + \left( \frac{\partial}{\partial y} + \frac{ieB}{2\hbar} x \right)^2 \right]. \quad (2.57)$$

Translation invariance is realized through the magnetic translation operators

$$(T_{a,b}\psi)(x, y) := e^{\frac{ieB}{2\hbar}(ay-bx)}\psi(x+a, y+b), \quad (2.58)$$

which form a projective representation of the translation group,

$$T_{a,b}T_{a',b'} = e^{\frac{ieB}{2\hbar}(ab'-ba')}T_{a+a',b+b'}. \quad (2.59)$$

Let us now assume that the magnetic field is strong enough so that the electron is confined to the lowest Landau level, which is the ground state of the Hamiltonian  $H_L$  with energy  $\frac{\hbar eB}{2m}$ .

The wave functions pertaining to the lowest Landau level are conveniently written using a complex coordinate  $z = x + iy$ ,

$$\psi(z, \bar{z}) = e^{-\frac{eB}{4\hbar}|z|^2}\phi(z), \quad (2.60)$$

where  $\phi$  is an arbitrary holomorphic function with square summable Taylor coefficients. Thus, the lowest Landau level is infinitely degenerated and its wave functions are in one-to-one correspondence with analytic functions  $\phi$  in the Bargmann space  $\mathcal{H}_B$  with  $\omega = \frac{eB}{2\hbar}$ . Besides, a magnetic translation by  $v = a + ib$  acts on  $\phi$  via the action of  $\mathbb{C}$  on holomorphic functions (2.51).

The noncommutative tori arise naturally when we consider the effect of an atomic lattice in perturbation theory. Indeed, let us assume that in addition to the magnetic field, the electron is submitted to a potential  $V$  created by a square lattice of spacing  $l$ . Then, the potential is  $\mathbb{Z}^2$ -periodic,  $V(x + lm, y + nl) = V(x, y)$  for any  $(m, n) \in \mathbb{Z}^2$ . Furthermore, let us make the assumption that the magnetic field is strong enough so that one can consider the electron to be confined to the lowest Landau level even in the presence of  $V$ . Therefore, the implementation of the lattice translations imply that the lowest Landau level is nothing but the Bargmann module  $\mathcal{H}_B$  over the noncommutative torus  $\mathcal{A}_\theta$  with a parameter

$$\theta = \frac{\omega l^2}{\pi} = \frac{eBl^2}{2\pi\hbar} = \frac{\Phi}{\Phi_0}, \quad (2.61)$$

where  $\Phi = Bl^2$  is the flux of  $B$  through the unit cell of the lattice and  $\Phi_0 = \frac{2\pi\hbar}{e}$  is the quantum flux. This noncommutative torus may be seen as a *Noncommutative Brioullin zone* since it replaces the ordinary Brioullin zone in the presence of the magnetic field. For this interpretation to hold, it is necessary to take  $R = \frac{2\pi}{l}$  which corresponds to the size of the Brioullin zone. Let us note that the topological invariant given by  $\text{Tr}_{\mathcal{A}_\theta}(F_{12})$ , is nothing but the Hall conductivity [2].

If the electron remains confined to the lowest Landau level, then  $V$  has to be projected on  $\mathcal{H}_B$  and lattice invariance translates into the statement that  $V$  must commute with the left action

of  $\mathcal{A}_\theta$ . Therefore,  $V$  is an element of the algebra  $\mathcal{A}_{1/\theta}$  acting on the right. This is a general constraint on the action of  $V$ , solely derived from symmetry considerations and independent of the precise form of  $V$ .

Obviously, the projective modules constructed out of the Schwartz space and the Bargmann space are equivalent, the explicit equivalence being the unitary Bargmann transform  $B : \mathcal{H}_S \rightarrow \mathcal{H}_B$  defined as

$$(B\chi)(z) = \left(\frac{\omega}{\pi}\right)^{1/2} \int_{\mathbb{R}} dx e^{-\frac{\omega(x^2+z^2)}{2} + \sqrt{2}\omega zx} \chi(x), \quad (2.62)$$

and its inverse is

$$(B^{-1}\phi)(x) = \left(\frac{\omega}{\pi}\right)^{1/2} \int_{\mathbb{C}} d\mu(z, \bar{z}) e^{-\frac{\omega(x^2+\bar{z}^2)}{2} + \sqrt{2}\omega \bar{z}x} \phi(z), \quad (2.63)$$

for  $\chi \in L^2(\mathbb{R})$  and  $\phi \in \mathcal{H}_B$ . This corresponds to the equivalence between the vertical polarization on the phase space  $\mathbb{R} \times \mathbb{R}^*$  and the holomorphic one. Then, one defines the smooth module  $\mathcal{E}_B$  as the image of Schwartz space under the Bargmann transform.

Consider now the projective action  $T_{a,b}$  of  $\mathbb{R} \times \mathbb{R}^*$  on the Schwartz functions of the real line. Its image through the Bargmann transform is an action of  $\mathbb{C}$  by the operators  $T_v$  given in (2.51) with  $v = \frac{1}{\sqrt{2}}(a + \frac{ib}{\omega})$ . This allows to establish a general correspondence between the two projective modules, their scalar products and their connections. In what follows, it is particularly convenient to set  $\omega = \frac{2\pi}{\theta}$ , in such a way that the lattices  $\Gamma$  and  $\widehat{\Gamma}$  read, in the holomorphic formulation,

$$\Gamma = \left\{ \frac{\theta}{\sqrt{2}}(m + in) \quad \text{with} \quad (m, n) \in \mathbb{Z}^2 \right\}, \quad (2.64)$$

and

$$\widehat{\Gamma} = \left\{ \frac{1}{\sqrt{2}}(m' + in') \quad \text{with} \quad (m', n') \in \mathbb{Z}^2 \right\}, \quad (2.65)$$

It amounts to set  $l = \frac{\theta}{\sqrt{2}}$  in the general square lattice introduced at the beginning of this section. An arbitrary lattice in  $\mathbb{C}$  would correspond to an arbitrary lattice in  $\mathbb{R} \times \mathbb{R}^*$  using the inverse Bargmann transform. From now on, we restrict ourselves to the preceding values of  $\omega$  and  $l$ .

In this framework, the two operators representing the connection read

$$\nabla_1\phi(z) = \frac{1}{i\sqrt{2}} \left[ \frac{d\phi}{dz}(z) + \omega z\phi(z) \right] \quad \text{and} \quad \nabla_2\phi(z) = \frac{1}{\sqrt{2}} \left[ \frac{d\phi}{dz}(z) - \omega z\phi(z) \right], \quad (2.66)$$

as follows from (2.66) with  $\omega = \frac{2\pi}{\theta}$ ,  $l = \frac{\theta}{\sqrt{2}}$  and  $R = 1$ . The operator (2.48) entering into the definition of the kinetic term is

$$H = -(\nabla_1)^2 - (\nabla_2)^2 + \mu_0^2 = 2\omega \left( z \frac{d}{dz} + \frac{1}{2} \right) + \mu_0^2, \quad (2.67)$$

which is nothing but the image through the Bargmann transform of the harmonic oscillator Hamiltonian  $-\frac{d^2}{dx^2} + \omega^2 x^2 + \mu_0^2$ . Note that there is a constant term in  $H$  even if  $\mu_0 = 0$ . Thus, even in a massless theory, there is *a priori* no infrared divergences at the tree level. Of course, this picture may change at higher loop order because of the IR/UV mixing.

In the development of the quantum theory associated to these projective modules, it will be interesting to have at our disposal higher dimensional analogues of the previous construction. While the general structure of projective modules over higher dimensional noncommutative tori is extremely rich [24], we can easily construct simple examples in any even dimension  $d$  by simply taking the  $\frac{d}{2}$ <sup>th</sup> tensor power of the previous module. This corresponds to a Bargmann space of

holomorphic functions on  $\mathbb{C}^{d/2}$ . The corresponding lattices are simply obtained by replacing the integers  $m, n, m'$  and  $n'$  by vectors in  $\mathbb{Z}^{d/2}$ . This procedure leads to a noncommutative algebra  $\mathcal{A}_\Theta$  with a  $d \times d$  matrix  $\Theta$  which is a direct sum of  $2 \times 2$  antisymmetric matrices,

$$\Theta = \begin{pmatrix} 0 & \theta & & & \\ -\theta & 0 & & & \\ & & \ddots & & \\ & & & 0 & \theta \\ & & & -\theta & 0 \end{pmatrix}. \quad (2.68)$$

To emphasize the difference with a generic noncommutative torus algebra  $\mathcal{A}_\Theta$ , we will denote the algebra corresponding to the specific choice (2.68) by  $\mathcal{A}_\theta$ , like in the two-dimensional case.

### 3 QFT and diagrammatics

#### 3.1 Feynman rules

In this section, we restore the notation  $\phi^\dagger$ , instead of the complex conjugate notation  $\bar{\phi}$ , to denote an element of the dual module  $\mathcal{E}^*$ . The reason is that we would like to sketch a representation free construction of Feynman rules for a field theory on the Heisenberg modules corresponding to the choice (2.68). Otherwise specified,  $\mathcal{E}$  can be either  $\mathcal{E}_S(\mathbb{R}^{d/2})$  or  $\mathcal{E}_B(\mathbb{C}^{d/2})$ , or even another unitarily equivalent module. We also emphasize that such a procedure does not rely on the particular structures of the module studied, so that it can be employed for the construction of any quantum field theory on a projective module.

The action functional  $S[\phi, \phi^\dagger]$  we have defined in the previous section can serve as a basis for the construction of a perturbative quantum field theory. This amounts to define and study the  $(2N)$ -point functions  $G_{2N}$ , given in terms of the functional integral

$$G_{2N} := \frac{\int [D\phi][D\phi^\dagger] \left( \phi \otimes \phi^\dagger \otimes \dots \otimes \phi \otimes \phi^\dagger \right) e^{-S[\phi, \phi^\dagger]}}{\int [D\phi][D\phi^\dagger] e^{-S[\phi, \phi^\dagger]}}, \quad (3.1)$$

as a perturbation of a free Gaussian functional integral. Because the projective module can be realized as a dense sub-space of an Hilbert space of functions with a kinetic term given by a second order differential operator, the free field theory is always well-defined. We will always assume in this section that the functional integral has been regularized, for example by integrating only over a finite dimensional subspace of the projective module. Later on, we shall use other regularization techniques suitable for renormalization.

This means that once the theory is regularized, the Green's functions  $G_{2N}$  define distributions on the projective tensor product  $\mathcal{E}^{\otimes N} \otimes \mathcal{E}^{*\otimes N} \simeq \mathcal{S}(\mathbb{R}^{dN})$  (recall that  $\mathcal{S}(\mathbb{R}^{d/2})$  is a nuclear space). The evaluation of  $G_{2N}$  on  $2N$  test functions  $\psi_i \in \mathcal{E}$ ,  $\chi_i^\dagger \in \mathcal{E}^*$ ,  $i = 1, \dots, N$ , is given by the following path integral formula:

$$G_{2N}(\chi_1^\dagger, \dots, \chi_n^\dagger, \psi_1, \dots, \psi_n) = \frac{\int [D\phi][D\phi^\dagger] \text{Tr}_{\mathcal{A}_\theta}[(\chi_1, \phi)_{\mathcal{A}_\theta}] \text{Tr}_{\mathcal{A}_\theta}[(\phi, \psi_1)_{\mathcal{A}_\theta}] \dots \text{Tr}_{\mathcal{A}_\theta}[(\chi_n, \phi)_{\mathcal{A}_\theta}] \text{Tr}_{\mathcal{A}_\theta}[(\phi, \psi_n)_{\mathcal{A}_\theta}] e^{-S[\phi, \phi^\dagger]}}{\int [D\phi][D\phi^\dagger] e^{-S[\phi, \phi^\dagger]}}. \quad (3.2)$$

It has to be noted that the field  $\phi$  and its conjugate  $\phi^\dagger$  must occur an equal number of times, as required by the invariance under global phase multiplication. Any correlation function not

fulfilling this condition vanishes identically. Note that the field  $\phi$  lives in a module  $\mathcal{E}$  and its conjugate  $\phi^\dagger$  in the dual module  $\mathcal{E}^*$ , so that the correlation function with  $2N$  fields is conveniently seen as a linear map from  $\mathcal{E}^{\otimes N}$  to itself.

As usual in QFT, all the correlations functions can be gathered into the generating functional

$$Z[J, J^\dagger] = \frac{\int [D\phi][D\phi^\dagger] e^{-S[\phi, \phi^\dagger] + \text{Tr}_{\mathcal{A}_\theta}[(J, \phi)_{\mathcal{A}_\theta}] + \text{Tr}_{\mathcal{A}_\theta}[(\phi, J)_{\mathcal{A}_\theta}]}{\int [D\phi][D\phi^\dagger] e^{-S[\phi, \phi^\dagger]}}. \quad (3.3)$$

From  $Z[J, J^\dagger]$  we define  $W[J, J^\dagger] = \log Z[J, J^\dagger]$  and  $\Gamma[\phi, \phi^\dagger]$  as the Legendre transform of  $W[J, J^\dagger]$ ,

$$\Gamma[\varphi, \varphi^\dagger] = \text{Tr}_{\mathcal{A}_\theta}[(\varphi, J)_{\mathcal{A}_\theta}] + \text{Tr}_{\mathcal{A}_\theta}[(J, \varphi)_{\mathcal{A}_\theta}] - W[J, J^\dagger] \quad \text{with} \quad \varphi = \frac{\delta W}{\delta J^\dagger} \quad \text{and} \quad \varphi^\dagger = \frac{\delta W}{\delta J}.$$

Whereas  $Z$  is obtained as a sum over all Feynman diagrams,  $W$  only involves connected diagrams and  $\Gamma$  only 1PI diagrams, i.e. diagrams that remain connected if one cuts any internal line. In the sequel, we shall always restrict our analysis to 1PI diagrams.

Since the action functional can be written as

$$S[\phi, \phi^\dagger] = \text{Tr}_{\mathcal{A}_\theta} \left[ (\phi, H\phi)_{\mathcal{A}_\theta} + \frac{\lambda}{2} (\phi, \phi)_{\mathcal{A}_\theta}^2 \right], \quad (3.4)$$

it is convenient to rewrite the quartic interaction using a Hubbard-Stratonovitch transform as

$$e^{-\frac{\lambda}{2} \text{Tr}_{\mathcal{A}_\theta}[(\phi, \phi)_{\mathcal{A}_\theta}^2]} = \int [DA] e^{-\text{Tr}_{\mathcal{A}_\theta} \left[ \frac{\lambda A^2}{2} + i\lambda A(\phi, \phi)_{\mathcal{A}_\theta} \right]}, \quad (3.5)$$

where we integrate over all Hermitian elements  $A^* = A \in \mathcal{A}_\theta$ . From a physical perspective, this amounts to consider  $A$  as a random external field subjected to Gaussian probability law.

As usual, a regularization is self-understood and we have dropped an irrelevant normalization factor. Thus, the correlation function reads

$$G_{2N} = \frac{\int [D\phi][D\phi^\dagger][DA] \left( \phi \otimes \phi^\dagger \otimes \dots \otimes \phi \otimes \phi^\dagger \right) e^{-\text{Tr}_{\mathcal{A}_\theta} \left[ (\phi, H\phi)_{\mathcal{A}_\theta} + \frac{\lambda A^2}{2} + i\lambda A(\phi, \phi)_{\mathcal{A}_\theta} \right]}}{\int [D\phi][D\phi^\dagger][DA] e^{-\text{Tr}_{\mathcal{A}_\theta} \left[ (\phi, H\phi)_{\mathcal{A}_\theta} + \frac{\lambda A^2}{2} + i\lambda A(\phi, \phi)_{\mathcal{A}_\theta} \right]}}. \quad (3.6)$$

This allows us to derive the Feynman rules in a very simple way. There is a trivial propagator for the  $A$ -field

$$\text{---}\overset{\gamma}{\curvearrowright}\text{---} = \frac{1}{\lambda}. \quad (3.7)$$

Note that the field  $A$  only appears in internal lines since we only compute correlations of  $\phi$  and  $\phi^\dagger$ . We have also used an explicit expansion over the noncommutative Fourier modes  $A = \sum_\gamma A_\gamma U_\gamma$ . The fields  $\phi$  and  $\phi^\dagger$  propagate according to

$$\text{---}\blacktriangleright\text{---} = H^{-1}, \quad (3.8)$$

where  $H$  is defined in (2.67). Because the fields are complex, the propagator is not symmetric and an orientation on the lines is necessary. We always consider  $\phi^\dagger$  as incoming and  $\phi$  as outgoing, so that the propagator makes sense as a linear map from  $\mathcal{E}$  to itself. Finally, the interaction vertex is

$$\begin{array}{c} \text{---}\blacktriangleright\text{---} \\ \text{---}\blacktriangleright\text{---} \\ \text{---}\blacktriangleright\text{---} \end{array} \overset{\gamma}{\curvearrowright} = i\lambda U_\gamma. \quad (3.9)$$

It is important to note that there is a cyclic ordering of the fields  $A$ ,  $\phi^\dagger$  and  $\phi$  at the vertices which is due to the fact that the scalar product  $(\phi, \phi)_{\mathcal{A}_\theta}$  takes its values in the algebra  $\mathcal{A}_\theta$ . The vertex (3.9) always has the  $A$ -field attached to the right when following the arrows of the  $\phi$ -field. Exchanging  $\phi$  and  $\phi^\dagger$  would involve the scalar product  $(\phi, \phi)_{\mathcal{B}_\theta}$  with values in the commutant of  $\mathcal{A}_\theta$  in  $\mathcal{L}(\mathcal{H}_\mathcal{E})$ . (Recall that  $\mathcal{H}_\mathcal{E}$  is the Hilbert space obtained by completion of  $\mathcal{E}$  with respect to the norm subordinate to the scalar product  $\langle \cdot, \cdot \rangle_\mathcal{E} = \text{Tr}_{\mathcal{A}_\theta}[(\cdot, \cdot)_{\mathcal{A}_\theta}]$ .) We shall come back to this point when discussing duality.

It is worthwhile to notice that all the operators entering in the Feynmann rules extend to bounded operators on  $\mathcal{H}_\mathcal{E}$ . Instead being interpreted as a distribution, a typical regularized Feynman diagram with  $N$ -incoming and  $N$ -outgoing lines will then be conveniently seen as a linear map from  $\mathcal{H}^{\otimes N}$  to itself.

For instance, an arbitrary diagram with  $2N$  external legs is obtained as follows:

- Draw  $N$  oriented lines representing the propagation of the field  $\phi$ . Each of these lines represents an operator from  $\mathcal{H}_\mathcal{E}$  to itself, obtained by multiplying propagators  $H^{-1}$  and interactions  $U_\gamma$ .
- If they occur, draw closed oriented loops made of propagators  $H^{-1}$  and vertices  $U_\gamma$  and take the traces of the corresponding operators.
- Relate all interactions by wavy lines representing the propagation of  $A$  and sum over all the corresponding  $\gamma$ .

It is important to know at this stage that the divergences we will encounter may both come from the traces and the sums over  $\gamma$ 's.

Because of the orientation of the lines, there are no non-trivial symmetry factors, as e.g. in QED.

The simplest diagram in the 2-point function  $\mathcal{H}_\mathcal{E} \rightarrow \mathcal{H}_\mathcal{E}$  is

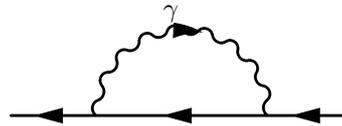

$$= -\lambda \sum_{\gamma} U_{-\gamma} H^{-1} U_{\gamma}. \quad (3.10)$$

Here we have made a little abuse of notation, using the same symbol  $U_\gamma$  to denote an element of the noncommutative torus and the operator acting (on the right) on  $\mathcal{H}_\mathcal{E}$ . Also, the trace which will appear in the next diagram, is not the noncommutative torus trace but the operator trace on  $\mathcal{H}_\mathcal{E}$ . A diagram contributing to the 2-point function involving a closed loop is

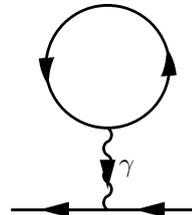

$$= -\lambda \sum_{\gamma} \text{Tr} (U_{-\gamma} H^{-1}) U_{\gamma}. \quad (3.11)$$

The simplest non-planar diagram contributing to the 2-point function is

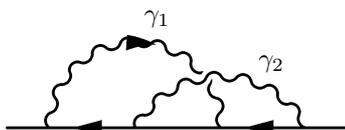

$$= \lambda^2 \sum_{\gamma_1, \gamma_2} U_{-\gamma_1} H^{-1} U_{-\gamma_2} H^{-1} U_{\gamma_1} H^{-1} U_{\gamma_2}, \quad (3.12)$$

where  $\gamma_2$  has the same orientation as  $\gamma_1$ . Analogously, let us list a few diagrams contributing to the 4-point function  $\mathcal{H}_\mathcal{E} \otimes \mathcal{H}_\mathcal{E} \rightarrow \mathcal{H}_\mathcal{E} \otimes \mathcal{H}_\mathcal{E}$ , starting with the tree level contribution:

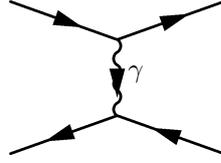

$$= -\lambda \sum_{\gamma} U_{-\gamma} \otimes U_{\gamma}. \quad (3.13)$$

This diagram simply represents the vertex once the  $A$ -field has been integrated out. The first non-trivial four-point diagram with a loop is

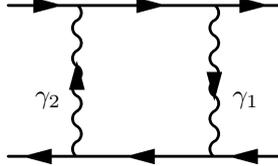

$$= \lambda^2 \sum_{\gamma_1, \gamma_2} (U_{-\gamma_1} H^{-1} U_{\gamma_2}) \otimes (U_{-\gamma_2} H^{-1} U_{\gamma_1}). \quad (3.14)$$

This diagram is planar and a non-planar one, can be constructed by exchanging  $\gamma_1$  and  $\gamma_2$  in the second tensor product,

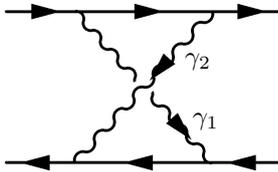

$$= \lambda^2 \sum_{\gamma_1, \gamma_2} (U_{-\gamma_2} H^{-1} U_{-\gamma_1}) \otimes (U_{\gamma_2} H^{-1} U_{\gamma_1}). \quad (3.15)$$

With a trace, the simplest example is

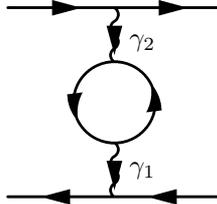

$$= \lambda^2 \sum_{\gamma_1, \gamma_2} \text{Tr} (H^{-1} U_{\gamma_2} H^{-1} U_{-\gamma_1}) U_{-\gamma_2} \otimes U_{\gamma_1}. \quad (3.16)$$

Finally, let us give a more complicated example, contributing to the 6-point function  $\mathcal{H}_\mathcal{E} \otimes \mathcal{H}_\mathcal{E} \otimes \mathcal{H}_\mathcal{E} \rightarrow \mathcal{H}_\mathcal{E} \otimes \mathcal{H}_\mathcal{E} \otimes \mathcal{H}_\mathcal{E}$ ,

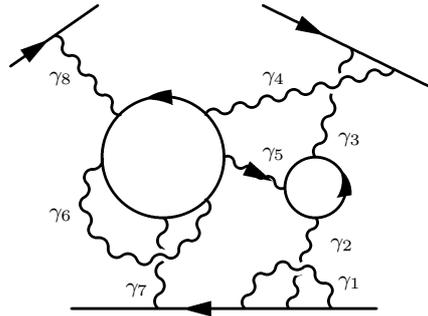

$$(3.17)$$

$$= \lambda^8 \sum_{\gamma_1, \dots, \gamma_8} \begin{aligned} & U_{\gamma_8} \otimes (U_{\gamma_4} H^{-1} U_{\gamma_3}) \otimes (U_{\gamma_7} H^{-1} U_{\gamma_1} H^{-1} U_{\gamma_2} H^{-1} U_{-\gamma_1}) \\ & \times \text{Tr} (H^{-1} U_{-\gamma_5} H^{-1} U_{\gamma_6} H^{-1} U_{-\gamma_7} H^{-1} U_{-\gamma_6} H^{-1} U_{-\gamma_8} H^{-1} U_{-\gamma_4}) \\ & \times \text{Tr} (H^{-1} U_{-\gamma_2} H^{-1} U_{\gamma_5} H^{-1} U_{-\gamma_3}) \end{aligned} , \quad (3.18)$$

where  $\gamma_2, \gamma_3, \gamma_4, \gamma_7, \gamma_8$  leave the loops and the internal  $\gamma_1$  and  $\gamma_6$  first leave and then arrive, accordingly to the orientation.

Let us note that on the definition of an 1PI diagram, we impose the irreducibility condition only for the  $\phi$ -lines, not for the  $A$ -lines. In fact, only the  $\phi$ -lines are really internal lines. Thus we reserved the terminology to the latter. The wavy  $A$ -lines are just a convenient way to visualize the interaction and serve to indicate the identifications of the operators  $U_\gamma$  inserted in the diagram.

For the simplest example of a Heisenberg module in  $x$ -space, we have seen that the theory is invariant under the Langmann-Szabo duality, see (2.42). This is a general fact that follows from the existence of two compatible scalar products on the projective module  $\mathcal{E}$ , under fairly general conditions [24]. Indeed, if we denote by  $\mathcal{B}_\theta$  the endomorphism algebra  $\text{End}_{\mathcal{A}_\theta}(\mathcal{E})$ , then one defines a scalar product  $(\cdot, \cdot)_{\mathcal{B}_\theta}$  on  $\mathcal{E}$ , which is linear with respect to the left action of  $\mathcal{B}_\theta$  on the first variable and anti-linear in the second one. The two scalar products are compatible in the sense that

$$\phi(\chi, \psi)_{\mathcal{A}_\theta} = (\phi, \chi)_{\mathcal{B}_\theta} \psi, \quad (3.19)$$

for any  $\phi, \chi, \psi \in \mathcal{E}$ . The algebra  $\mathcal{B}_\theta$  is in general another noncommutative torus constructed with the dual lattice. If we denote by  $\text{Tr}_{\mathcal{B}_\theta}$  its normalized trace, then the interaction can be transformed as

$$\begin{aligned} \text{Tr}_{\mathcal{A}_\theta} \left[ (\phi_1, \phi_2)_{\mathcal{A}_\theta} (\phi_3, \phi_4)_{\mathcal{A}_\theta} \right] &= \text{Tr}_{\mathcal{A}_\theta} \left[ (\phi_1, \phi_2 (\phi_3, \phi_4)_{\mathcal{A}_\theta})_{\mathcal{A}_\theta} \right] \\ &= \text{Tr}_{\mathcal{A}_\theta} \left[ (\phi_1, (\phi_2, \phi_3)_{\mathcal{B}_\theta} \phi_4)_{\mathcal{A}_\theta} \right] \\ &= \text{Tr}_{\mathcal{B}_\theta} \left[ ((\phi_2, \phi_3)_{\mathcal{B}_\theta} \phi_4, \phi_1)_{\mathcal{B}_\theta} \right] \\ &= \text{Tr}_{\mathcal{B}_\theta} \left[ (\phi_4, \phi_1)_{\mathcal{B}_\theta} (\phi_2, \phi_3)_{\mathcal{B}_\theta} \right], \end{aligned} \quad (3.20)$$

where we have used  $\text{Tr}_{\mathcal{A}_\theta} [(\phi, \chi)_{\mathcal{A}_\theta}] = \text{Tr}_{\mathcal{B}_\theta} [(\chi, \phi)_{\mathcal{B}_\theta}]$ . We have also labeled explicitly all the fields in order to better visualize the manipulation we have made.

At the level of the Feynman diagrams, especially for the (total) vertex, this duality reads

The diagram shows an equality between two expressions. On the left, a summation over  $\gamma \in \Gamma$  is shown next to a vertical double line with arrows pointing right. On the right, a summation over  $i\gamma \in \hat{\Gamma}$  is shown next to a vertical wavy line with a bubble in the middle, and arrows pointing down on the left and up on the right. A double-headed arrow indicates the duality.

$$\sum_{\gamma \in \Gamma} \text{---} \longleftrightarrow \sum_{i\gamma \in \hat{\Gamma}} \text{---} \quad (3.21)$$

Then, it is easy to see that this duality exchanges different types of diagrams: for planar diagrams lines and bubbles are exchanged. The dual of an arbitrary diagram is constructed in two steps. First, replace any wavy line by a double line. Then, in each double line, relate the two lines by a new wavy line. The dual theory can also be written using a Hubbard-Stratonovitch transform with an auxiliary field  $B \in \mathcal{B}_\theta$ , but now the opposite convention have to be used: following the arrows, the field  $B$  leaves on the right.

The diagram shows an equality between two expressions. On the left, a horizontal double line with arrows pointing left is shown with a bubble on top. On the right, a horizontal double line with arrows pointing left is shown with a bubble on the bottom. A double-headed arrow indicates the duality.

$$\text{---} \longleftrightarrow \text{---} \quad (3.22)$$

For the simple Heisenberg module obtained from Schwartz functions on  $\mathbb{R}$ , the scalar product with values in  $\mathcal{B}_\theta = \mathcal{A}_{1/\theta}$  is simply

$$(\chi, \phi)_{\mathcal{A}_{1/\theta}} = \frac{1}{\theta} \sum_{\hat{\gamma} \in \hat{\Gamma}} \langle \phi, U_{\hat{\gamma}} \chi \rangle_{L^2(\mathbb{R})} U_{-\hat{\gamma}} \quad (3.23)$$

$$= \frac{1}{\theta} \sum_{\hat{\gamma} \in \hat{\Gamma}} \left( \int_{\mathbb{R}} dx \bar{\phi}(x) e^{\frac{i\pi m n}{\theta}} \chi(x+m) e^{\frac{2i\pi n x}{\theta}} \right) U_{-\hat{\gamma}}. \quad (3.24)$$

One passes from one scalar product to the other one by Poisson re-summation. In the study of the renormalizability, it will prove to be helpful to use the Poisson re-summation for some of the  $\gamma$ 's only. This corresponds to a duality operation on only some of the vertices.

### 3.2 Reduced theory

To make contact with the standard analysis of divergences of a field theory in the Moyal plane [15], it is helpful to write the propagator as

$$H^{-1} = \int_0^\infty d\alpha e^{-\alpha H}. \quad (3.25)$$

Therefore, the contribution of any diagram  $G$  with  $N$  internal lines and  $M$  vertices is expressed as an integral over  $N$  Schwinger parameters and a sum over  $M$  lattice elements

$$\int d\alpha_1 \cdots d\alpha_N \sum_{\gamma_1, \dots, \gamma_M} I_G(\alpha_1, \dots, \alpha_N; \gamma_1, \dots, \gamma_M). \quad (3.26)$$

We refer to the next section for a precise evaluation of this integral in the Bargmann representation.

At a heuristic level, it is expected that all the divergences arise from the regions of integration in which one or several Schwinger parameters go to zero. Indeed, if all the Schwinger parameters are different from zero, the traces in  $I_G$  as well as the sums over lattice elements  $\gamma$  are convergent as tempered distributions. We shall see in the next sections the details of this fact for all one-loop diagrams.

Therefore, it is interesting to analyze  $I_G(\alpha_1, \dots, \alpha_N; \gamma_1, \dots, \gamma_M)$  when all Schwinger parameters are set to zero. In this case, there are no propagators anymore and only the insertions of  $U_\gamma$  remain. For any trace around a closed loop of internal lines, there is a divergence proportional to the trace of the product of the operators  $U(\gamma)$  along the loop. If we renormalize the trace such that the trace of the identity is 1, this reduced vertex reads

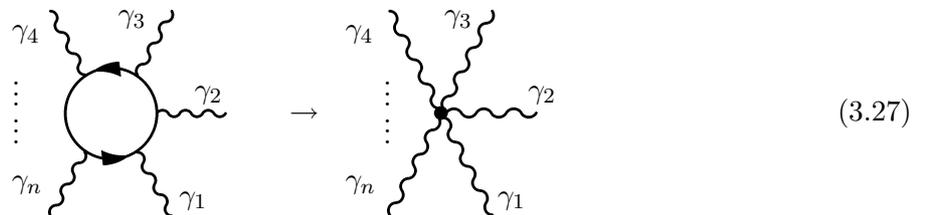

$$\prod_{i < j} e^{i\pi\theta(\gamma_i, \gamma_j)} \delta(\gamma_1 + \cdots + \gamma_M),$$

where the ordering is given by the orientation of the loop. By the same method, we can reduce an open line. It is important to keep in mind that the reduced diagrams are also to be thought of as ribbon diagrams, because the cyclic orders at the vertices matters:

$$\prod_{i < j} e^{i\pi\theta(\gamma_i, \gamma_j)} U_{\gamma_1 + \dots + \gamma_M}, \quad (3.28)$$

where the ordering is again given by the orientation of the line.

The reduced theory behaves as a very simple model with vertices given by the previous two types of diagrams, propagators equal to one and momenta corresponding to the lattice elements. External legs of the reduced diagrams are given by the external legs of the lines that have been reduced and the sum of the lattice elements along the line corresponds to the external momenta of the reduced diagram. Momentum is conserved at the internal vertices and only the loops of the reduced diagram involve a non-trivial summation. Besides, any diagram carries a phase factor that is readily computed using the techniques introduced by T. Filk [15].

It follows from this work that the phase associated with a planar diagram (i.e. a diagram that can be drawn without crossings) only depends on the external momenta of the reduced diagram. Therefore, the diagram is independent of the loop momenta flowing into the reduced diagram and the corresponding summation is divergent. For example, in the ladder diagram contributing to the 4-point function, the summation reads

$$\sum_{\gamma_1, \gamma_2} U_{\gamma_1} U_{\gamma_2} \otimes U_{-\gamma_1} U_{-\gamma_2} = \sum_{\gamma} U_{\gamma} \otimes U_{-\gamma} \underbrace{\left( \sum_{\gamma_1} 1 \right)}_{\text{constant divergence}}, \quad (3.29)$$

with  $\gamma = \gamma_1 + \gamma_2$ . The remaining sum over  $\gamma_1$  is obviously divergent and its divergent part is proportional to the vertex  $\sum_{\gamma} U_{\gamma} \otimes U_{-\gamma}$  so that one can infer that it is renormalizable.

The non-planar analogue of the previous diagram behaves very differently. Its contribution to the 4-point function is

$$\sum_{\gamma_1, \gamma_2} U_{\gamma_1} U_{\gamma_2} \otimes U_{-\gamma_2} U_{-\gamma_1} = \sum_{\gamma} U_{\gamma} \otimes U_{-\gamma} \underbrace{\left( \sum_{\gamma_1} e^{2i\pi\theta(\gamma_1, \gamma)} \right)}_{\gamma\text{-dependent divergence}}. \quad (3.30)$$

In the integral case, the phase factor is trivial and the integral diverges for all  $\gamma$  as in the commutative theory. If the phases are all rational, then there is a divergence for those  $\gamma$  such that  $U_{\gamma}$  is central, for other values of  $\gamma$  there is an exact cancellation. In the irrational case, there is obviously a divergence when  $\gamma = 0$ . We shall see in the section on 1-loop renormalization that this is the only divergence when  $\theta$  satisfies a Diophantine condition.

All the properties of the noncommutative field theory we have presented in this section are independent of the representation we choose. As such, they are best derived in a general setting, without using any specific representation for the operators  $H$  and  $U_{\gamma}$ . In the next

two sections, we shall use the position space (or equivalently, by Langmann-Szabo duality, the momentum space representation) to uncover an analogy with matrix models and with the Grosse-Wulkenhaar one [18], and the holomorphic representation for an explicit evaluation of Feynman diagrams and their divergences.

### 3.3 Position space Feynman rules and relations with other models

#### 3.3.1 Relation with matrix models

Let us come back to the non-local structure of the interaction in  $x$ -space. For the simplest module, i.e.  $\mathcal{E}_S = \mathcal{S}(\mathbb{R}^2)$ , the interaction term given by (2.40), can be written as

$$\int_{\mathbb{R}^4} dx dy dz dt V(x, y, z, t) \bar{\phi}(x)\phi(y)\bar{\phi}(z)\phi(t), \quad (3.31)$$

with

$$V(x, y, z, t) = \frac{\lambda}{2} \sum_{m, n \in \mathbb{Z}} \delta(y - x - m\theta)\delta(z - x - m\theta - n)\delta(t - x - n). \quad (3.32)$$

This leads to a vertex

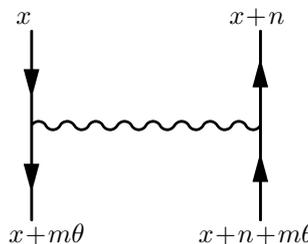

$$(3.33)$$

The non-local structure of this interaction given by the vertex (3.32) is intuitively understood as follows. First let us notice that the interaction involves products of the fields at the four points  $x$ ,  $x + m\theta + n$ ,  $x + n$  and  $x + m\theta$ . These four points are identical in the quotient space  $\mathbb{R}/(\mathbb{Z} + \theta\mathbb{Z})$  so that the theory would be local if it could be formulated on such a quotient. This is possible if  $\theta$  is rational but otherwise the quotient space is badly behaved from a topological viewpoint, namely because  $\mathbb{Z} + \theta\mathbb{Z}$  is dense in  $\mathbb{R}$  when  $\theta$  is irrational. Such a quotient space is related to Kronecker's foliation and is fruitfully understood using the powerful techniques presented in [8]. Here we shall content ourselves with a very rough analysis by disregarding the topological difficulties so that we simply write any real number as  $x = [x] + k\theta + l$ , where  $[x]$  is the class of  $x$  in the quotient and  $k$  and  $l$  are elements of  $\mathbb{Z}$ . Accordingly, the interaction vertex can be written as

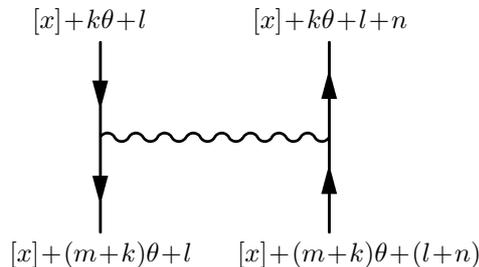

$$(3.34)$$

It appears that all the fields are evaluated at a point which corresponds to the same equivalence class  $[x]$  whereas the interaction mixes the integers  $k$  and  $l$  in a particular pattern reminiscent of matrix models. Indeed in a matrix model involving  $(p \times q)$ -rectangular matrices with an interaction of the type

$$V(M, M^\dagger) = \frac{\lambda}{2} \text{Tr} [M^\dagger M M^\dagger M] = \frac{\lambda}{2} \sum_{\substack{0 \leq i_1, i_2 \leq q-1 \\ 0 \leq j_1, j_2 \leq p-1}} (M^\dagger)_{i_1 j_1} M_{j_1 i_2} (M^\dagger)_{i_1 j_2} M_{j_2 i_1}, \quad (3.35)$$

the interaction vertex is

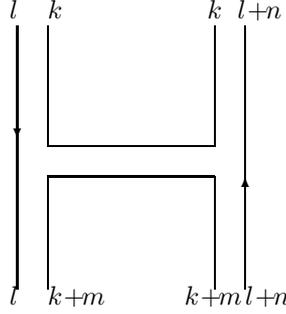

The integers  $k$ ,  $l$ ,  $k + m$  and  $l + n$  correspond to matrix indices  $i_1$ ,  $j_1$ ,  $i_2$  and  $j_2$ . In the framework of rectangular matrix models, the duality (3.20) exchanges  $M$  with its adjoint  $M^\dagger$  [7].

If  $\theta = \frac{p}{q}$ , with  $p$  and  $q$  two relatively prime positive integers, then the relation with rectangular matrix models can be established as follows. Define the vector bundle  $F \rightarrow \mathbb{T}^2$  over a commutative 2-torus of radius  $1/q$ , whose fibers are  $(p \times q)$  complex matrices, in terms of its module of smooth sections  $\Gamma^\infty(F)$ . The latter is defined as the set of  $(p \times q)$  matrix-valued smooth functions on  $[0, 1/q] \times [0, 1/q]$ , which are periodic in the second variable but only quasi-periodic in the first:

$$\begin{cases} M(x, y + \frac{1}{q}) = M(x, y), \\ M(x + \frac{1}{q}, y) = \Omega_p^a(qy)M(x, y)\Omega_q^{-b}(-qy), \end{cases} \quad (3.36)$$

where  $a$  and  $b$  are two integers such that  $aq + bp = 1$  and  $\Omega_N(y)$  is the  $N \times N$  matrix defined by

$$\Omega_N(y) = \begin{pmatrix} 0 & 1 & & \\ & \ddots & \ddots & \\ & & & 1 \\ e^{2i\pi y} & & & 0 \end{pmatrix}. \quad (3.37)$$

Now, given  $\phi \in \mathcal{S}(\mathbb{R})$  one associates an element of  $\Gamma^\infty(F)$  via the map  $\rho$

$$\rho : \mathcal{S}(\mathbb{R}) \rightarrow \Gamma^\infty(F), \quad \phi(x) \mapsto M_{ij}(x, y) = \sum_{n \in \mathbb{Z}} \phi\left(x + \frac{iq + jp + npq}{q}\right) e^{-2i\pi nqy}, \quad (3.38)$$

with  $i \in \{0, 1, \dots, p-1\}$  and  $j \in \{0, 1, \dots, q-1\}$ . Using the identity

$$[\Omega_N^n(y)]_{ij} = \sum_k \delta_{j, i+n-kN} e^{2i\pi ky}, \quad (3.39)$$

where only one term in the sum is non-zero, it is easy to prove that  $M$  satisfies the boundary conditions (3.36). Conversely, one can define a function  $\phi \in \mathcal{S}(\mathbb{R})$  from a matrix  $M \in \Gamma^\infty(F)$  using the map  $\rho^*$  (the notation will be justified soon):

$$\rho^* : \Gamma^\infty(F) \rightarrow \mathcal{S}(\mathbb{R}), \quad M(x, y) \mapsto \phi(x) = q \int_0^{\frac{1}{q}} dy M_{00}(x, y). \quad (3.40)$$

From the boundary conditions (3.36), it is straightforward to see that the latter is well defined as an element of  $\mathcal{S}(\mathbb{R})$ .

The map  $\rho$  establishes an isomorphism between  $\mathcal{S}(\mathbb{R})$  and  $\Gamma^\infty(F)$ , whose inverse is  $\rho^*$ . Moreover,  $\rho$  and  $\rho^*$  extend to unitary operators at the level of  $L^2$ -completions. To this aim, let  $L^2(\mathbb{T}^2, F)$  be the completion of  $\Gamma^\infty(F)$  with respect to the norm  $\|\cdot\|_F$  induced from the scalar product  $\langle M, N \rangle_F = q \int_0^{1/q} dx \int_0^{1/q} dy \text{Tr}[M^\dagger(x, y)N(x, y)]$ .

**Lemma 3.1.** For  $\theta = \frac{p}{q}$ , with  $p$  and  $q$  relatively prime positive integer, the map  $\rho$  is a unitary operator from  $L^2(\mathbb{R})$  to  $L^2(\mathbb{T}^2, F)$ , whose adjoint is  $\rho^*$ .

*Proof.* First note that the maps (3.38)  $\rho : \mathcal{S}(\mathbb{R}) \rightarrow \Gamma^\infty(F)$  and (3.40)  $\rho^* : \Gamma^\infty(F) \rightarrow \mathcal{S}(\mathbb{R})$  are inverse each other. Indeed, for any  $\phi \in \mathcal{S}(\mathbb{R})$ , we have

$$\begin{aligned} (\rho^* \rho \phi)(x) &= q \int_0^{1/q} dy (\rho \phi)_{00}(x, y) = q \int_0^{1/q} dy \sum_{n \in \mathbb{Z}} \phi(x + np) e^{-2i\pi n q y} \\ &= \sum_{n \in \mathbb{Z}} \delta_{n,0} \phi(x + np) = \phi(x). \end{aligned}$$

Conversely, for any  $M \in \Gamma^\infty(F)$ , we find

$$\begin{aligned} (\rho \rho^* M)_{ij}(x, y) &= \sum_{n \in \mathbb{Z}} (\rho^* M) \left( x + \frac{iq + jp + npq}{q} \right) e^{-2i\pi n q y} \\ &= q \sum_{n \in \mathbb{Z}} \int_0^{1/q} dz M_{00} \left( x + \frac{iq + jp + npq}{q}, z \right) e^{-2i\pi n q y}. \end{aligned}$$

Using the boundary conditions (3.36) and the Poisson re-summation formula (in the sense of tempered distributions), the former expression reads

$$q \sum_{n \in \mathbb{Z}} \int_0^{1/q} dz M_{ij}(x, z) e^{-2i\pi n q (y-z)} = q \sum_{n \in \mathbb{Z}} \int_{n/q}^{(n+1)/q} dz M_{ij}(x, z) \delta(qz - qy) = M_{ij}(x, y).$$

Now for  $\phi, \chi \in \mathcal{S}(\mathbb{R})$ , denote by  $M, N \in \Gamma^\infty(F)$  the corresponding matrices. Let us also introduce the bijective map

$$\begin{aligned} \Xi : \{0, 1, \dots, p-1\} \times \{0, 1, \dots, p-1\} \times \mathbb{Z} &\rightarrow \mathbb{Z} \\ (i, j, n) &\mapsto iq + jp + npq. \end{aligned} \quad (3.41)$$

Using this map, one has

$$\begin{aligned} \langle M, N \rangle_F &= q \int_0^{1/q} dx \int_0^{1/q} dy \operatorname{Tr} [M^\dagger(x, y) N(x, y)] \\ &= \sum_{\Xi(i, j, n) \in \mathbb{Z}} \int_0^{1/q} dx \bar{\phi} \left( x + \frac{\Xi(i, j, n)}{q} \right) \chi \left( x + \frac{\Xi(i, j, n)}{q} \right) \\ &= \int_{-\infty}^{+\infty} dx \bar{\phi}(x) \chi(x) = \langle \phi, \chi \rangle_{L^2(\mathbb{R})}. \end{aligned}$$

Thus  $\|\rho \phi\|_F = \|\phi\|_{L^2(\mathbb{R})}$  and  $\|\rho^* M\|_{L^2(\mathbb{R})} = \|M\|_F$ , for any  $\phi \in \mathcal{S}(\mathbb{R})$  and  $M \in \Gamma^\infty(F)$ . By density, this proves that  $\rho$  and  $\rho^*$  extend to isometries on  $L^2(\mathbb{R})$  and  $L^2(\mathbb{T}^2, F)$  and that they are adjoint each other. This concludes the proof since one has already checked that  $\rho^* \rho = 1_{L^2(\mathbb{R})}$ ,  $\rho \rho^* = 1_{L^2(\mathbb{T}^2, F)}$ .  $\square$

It is worthwhile to notice that the map  $\rho$  possesses more structures. In particular, it preserves the module structure, where  $\Gamma^\infty(F)$  is equipped with a left action of the bundle algebra of  $(p \times p)$ -matrices over  $\mathbb{T}^2$ , with boundary conditions :

$$\begin{cases} A(x, y + \frac{1}{q}) = A(x, y), \\ A(x + \frac{1}{q}, y) = \Omega_p^a(qy) A(x, y) \Omega_p^a(qy)^\dagger, \end{cases} \quad (3.42)$$

In particular, the two covariant derivatives defining the connection (2.38) on the Schwartz space translate into

$$\nabla_1 = \frac{\partial}{\partial y} - \frac{2i\pi p x}{q} + A \cdot + \cdot B \quad \text{and} \quad \nabla_2 = \frac{\partial}{\partial x}, \quad (3.43)$$

on the rectangular matrices. In this definition,  $A$  and  $B$  are two square  $p \times p$  and  $q \times q$  constant diagonal matrices acting by left and right multiplication. Their diagonal elements are

$$A_{kk} = -2i\pi p k \quad \text{and} \quad B_{ll} = -\frac{2i\pi}{p} l. \quad (3.44)$$

Therefore, at rational  $\theta$ , the Heisenberg module simply describes a bundle of rectangular matrices over an ordinary torus. These relations generalize the one given in [21], which corresponds to the case  $p = q = 1$ .

Consider now a rectangular matrix model, with matrix-valued functions satisfying the boundary conditions (3.36) and an action given by

$$S[M, M^\dagger] = \int_0^{\frac{1}{q}} dx \int_0^{\frac{1}{q}} dy \operatorname{Tr} [\nabla_\mu M^\dagger(x, y) \nabla^\mu M(x, y) + \mu_0^2 M^\dagger(x, y) M(x, y) + \frac{\lambda}{2} (M^\dagger(x, y) M(x, y))^2]. \quad (3.45)$$

If we express the matrix  $M$  in terms of  $\phi$  via the map  $\rho$ , the matrix model action agrees with the Heisenberg module action (2.40) up to a factor  $q$ ,

$$qS[M, M^\dagger] = S[\phi, \bar{\phi}]. \quad (3.46)$$

The equality for the quadratic part of the action is already contained in the Lemma 3.1. The interaction term can be treated along the same lines. The matrix model interaction reads

$$\frac{q\lambda}{2} \sum_{i,j,k,l} \int_0^{\frac{1}{q}} dx \int_0^{\frac{1}{q}} dy \bar{M}_{ij}(x, y) M_{ik}(x, y) \bar{M}_{lk}(x, y) M_{lj}(x, y). \quad (3.47)$$

Expressing  $M$  in terms of  $\phi$  and integrating over  $y$  yields

$$\begin{aligned} \frac{\lambda}{2} \sum_{N, N', N''} \sum_{i,j,k,l} \int_0^{\frac{1}{q}} dx \quad & \bar{\phi} \left( x + \frac{iq+jp+Npq}{q} \right) \phi \left( x + \frac{iq+kp+N'pq}{q} \right) \\ & \times \bar{\phi} \left( x + \frac{lq+kp+(N'+N''-N)pq}{q} \right) \phi \left( x + \frac{lq+jp+N''pq}{q} \right). \end{aligned} \quad (3.48)$$

After a shift of the integration variable by  $\Xi(i, j, N)$  and a change of summation indices

$$\begin{cases} N' - jp - N & \rightarrow N', \\ N'' - iq - N & \rightarrow N'', \end{cases} \quad (3.49)$$

the interaction reads

$$\begin{aligned} \frac{\lambda}{2} \sum_{\Xi(i,j,N)} \sum_{N', N''} \sum_{k,l} \int_{\Xi(i,j,N)}^{\frac{\Xi(i,j,N)+1}{q}} dx \quad & \bar{\phi}(x) \phi \left( x + \frac{kp+(N')pq}{q} \right) \\ & \times \bar{\phi} \left( x + \frac{lq+kp+(N'+N'')pq}{q} \right) \phi \left( x + \frac{lq+N''pq}{q} \right). \end{aligned} \quad (3.50)$$

Finally, the identification with the vertex in  $x$ -space

$$\frac{\lambda}{2} \int_{+\infty}^{-\infty} dx \sum_{m,n \in \mathbb{Z}} \bar{\phi}(x) \phi \left( x + m \frac{p}{q} \right) \bar{\phi} \left( x + m \frac{p}{q} + n \right) \phi(x+n), \quad (3.51)$$

follows from the euclidian division of  $m$  by  $q$  and of  $n$  by  $p$ ,

$$\begin{cases} m &= k + qN', \\ n &= l + pN''. \end{cases} \quad (3.52)$$

Let us note that the action in terms of the Schwartz function  $\phi$  only involves the ratio  $\frac{p}{q}$  and does not depend separately on  $p$  and  $q$ . Therefore, it is suited to the study of the limit case

$$p \rightarrow \infty \quad \text{and} \quad q \rightarrow \infty, \quad \text{with} \quad \frac{p}{q} \rightarrow \theta, \quad (3.53)$$

where  $\theta$  is a fixed positive real number. Thus, one has

$$\lim_{\substack{p, q \rightarrow \infty \\ p/q \rightarrow \theta}} \int [DM][DM^\dagger] e^{-qS[M, M^\dagger]} \mathcal{O}(M, M^\dagger) = \int [D\phi][D\bar{\phi}] e^{-S[\phi, \bar{\phi}]} \mathcal{O}(\phi, \bar{\phi}). \quad (3.54)$$

In this equation, one has to keep in mind that the matrix-valued function  $M$  satisfies the boundary condition (3.36), which means that its period is  $1/q$ , along the two directions  $x$  and  $y$ , which goes to zero as  $q \rightarrow \infty$ . In this respect, the quantum field theory over the Heisenberg module corresponds to a twisted reduced matrix model, the size of the underlying space going to zero. In the next sections, we shall see that the renormalization properties of these models involves some number-theoretical properties of  $\theta$  for non-planar diagrams.

### 3.3.2 Relation with the Grosse-Wulkenhaar model

Recall that in [18, 26] it is proven that the duality-covariant  $\phi_4^4$ -theory on the Moyal hyper-plane is renormalizable to all orders in perturbation theory. In the exact self-dual case ( $\Omega = 1$  in the language of [18]), the theory is defined by the following action functional

$$S[\phi] := \frac{1}{2} \int d^4x \phi(x) (\Delta + X^2 + \mu_0^2) \phi(x) + \frac{\lambda}{2} \int d^4x (\phi \star \phi \star \phi \star \phi)(x), \quad (3.55)$$

where  $\Delta = -\partial^\mu \partial_\mu$  is the Laplacian and  $X^2 = X^\mu X_\mu$ , with  $X^\mu = 2(\theta^{-1})^{\mu\nu} x_\nu$ , where  $\theta_{\mu\nu} = -\theta_{\nu\mu} \in \mathbb{R}$  are the components of the deformation matrix which defines the Moyal product  $\star$ , and  $x^\mu$  denotes the ordinary Cartesian coordinate on  $\mathbb{R}^4$ .

It is worthwhile to notice that the kinetic term of that theory is exactly the same as in the model we study here: it is given by an harmonic oscillator Hamiltonian. But the origin of this term is quite different. For the action (3.55), the term  $X^2$  has been ‘‘added by hand’’ to cure the UV/IR-mixing problem. More specifically, such a term is required by the renormalization flow. But to see it, one has to formulate the theory on the matrix base (see [18]). Moreover the presence of such term allows to restore the Langmann-Szabo duality, which holds only for the interaction term without the quadratic potential. For the Heisenberg module, the harmonic oscillator potential has a clear geometric origin since it comes from the connection (2.38). In particular, whereas the frequency of the oscillator is a free parameter in [26] (and has to be renormalized), this is not the case in our model where the frequency is inverse proportional to the deformation parameter. Furthermore, we will see in the next section, that the value of this parameter is preserved by the renormalization flow. However, in spite of the presence of the confining potential, the  $\phi_4^4$ -theory on the Heisenberg module will still suffer from an UV/IR-mixing. Fortunately, in this case the UV/IR-entanglement is easy to cure (at least at one-loop) by the adjunction of another interaction term.

To investigate the analogies and differences of the interactions of the two models, it is useful to rewrite the vertex (3.32) as

$$V(x, y, z, t) = \frac{\lambda}{2^{2d} \theta^{2d}} \sum_{m, n \in \mathbb{Z}^d} e^{\frac{2i\pi}{\theta} m(x-y)} \delta(x - y + z - t) e^{2i\pi n(x-t)}. \quad (3.56)$$

This formula can be obtained from (3.32) after a Poisson re-summation on the index  $m$ . Here we have considered the module  $\mathcal{S}(\mathbb{R}^d)$  over a  $2d$ -dimensional noncommutative torus, with deformation matrix of the form (2.68). On the other hand, the interaction vertex associated to (3.55) in  $d$ -dimensions is given by

$$V_\star(x, y, z, t) = \frac{\lambda}{\pi^d \theta^d} e^{2i\theta^{-1}(x, y)} \delta(x - y + z - t) e^{2i\theta^{-1}(z, t)}, \quad (3.57)$$

where  $\theta^{-1}$  is the antisymmetric bilinear form associated to the inverse deformation matrix  $\theta_{\mu\nu}$ . This leads to a correspondence between the field theory on the Heisenberg module in dimension  $2d$  (the dimension of the underlying noncommutative torus) and the field theory on the Moyal plane of dimension  $d$ . This correspondence relates the phases in the interactions as

$$e^{2i\theta^{-1}(x, y)} \leftrightarrow \sum_{m \in \mathbb{Z}^d} e^{\frac{2i\pi m}{\theta}(y-x)} \quad \text{and} \quad e^{2i\theta^{-1}(z, t)} \leftrightarrow \sum_{n \in \mathbb{Z}^d} e^{2i\pi n(x-t)}. \quad (3.58)$$

The dissymmetry between the two phases has a deep impact on the power counting of the two theories: The correct analogue of the commutative  $\phi_4^4$ -theory on the noncommutative hyperplane is made out of the Moyal product on  $\mathbb{R}^4$ , whereas in the non-trivial module case, it has to be formulated on  $\mathcal{S}(\mathbb{R}^2)$ , not on  $\mathcal{S}(\mathbb{R}^4)$ . Indeed, it is the dimension of the noncommutative torus, not of the representation space, that matters. This lead to the following question: How can it be that two theories with the same propagator in different dimensions behave the same? The answer comes precisely from dissymmetry between the vertices (3.56) and (3.57).

To see how the vertex affects the evaluation of the Feynman diagrams, let us have a look at the one-loop planar two-point function, associated to a quartic interaction, for the two models. In the case of the projective module over a  $(2d)$ -noncommutative torus, if we evaluate the diagram (3.11) in external fields  $\varphi_1, \varphi_2 \in \mathcal{S}(\mathbb{R}^d)$ , we obtain up to a numerical factor

$$\text{Tr}((\varphi_1, \varphi_2)_{\mathcal{A}_\theta} H^{-1}) = \sum_{\gamma \in \Gamma} \text{Tr}(U_{-\gamma} H^{-1}) \langle \varphi_1, \varphi_2 U_\gamma \rangle_{L^2(\mathbb{R}^d)}. \quad (3.59)$$

Recall that in  $d$ -dimensions, the spectrum of  $H^{-1} = (\Delta + X^2)^{-1}$  is  $(d/2 + |n|)^{-1}$ ,  $n \in \mathbb{N}^d$ . For  $\gamma = 0$  (we will see that the terms with  $\gamma \neq 0$  give rise to finite contributions), the divergence is logarithmic for  $d = 1$ , quadratic for  $d = 2$  and so on. The behavior of this diagram for  $d = 2$  is reminiscent to a just-renormalizable  $\phi_4^4$  theory.

Alternatively, one can study the UV-divergences using a parametric representation (3.25) for the propagator and looking at the small- $\beta$  behavior. With the help of the Mehler formula, one can express the kernel of  $H^{-1}$  as

$$H^{-1}(x, y) = \frac{\omega^2}{4\pi^2} \int_0^\infty d\beta \frac{1}{\sinh^{d/2}(2\omega\beta)} e^{-\frac{\omega}{4}(\coth(\omega\beta)|x-y|^2 + \tanh(\omega\beta)|x+y|^2)}, \quad (3.60)$$

where  $\omega$  is the frequency of the oscillator. If we regularize the theory by setting

$$H^{-1} \rightarrow H_\epsilon^{-1} = \int_\epsilon^\infty d\beta e^{-\beta H}, \quad (3.61)$$

then one gets up to an irrelevant constant

$$\text{Tr}(H_\epsilon^{-1}) = \int_{\mathbb{R}^d} dx H_\epsilon^{-1}(x, x) = \int_\epsilon^\infty d\beta \left( \frac{\cosh(\omega\beta)}{\sinh(\omega\beta) \sinh(2\omega\beta)} \right)^{d/2}. \quad (3.62)$$

This yields the same conclusion: the divergence (in  $\epsilon^{-1/2}$ ) is logarithmic for  $d = 1$ , quadratic for  $d = 2$ .

Now, the same diagram for the duality-covariant model on the Moyal plane reads

$$\text{Tr}(L(\varphi_1 \star \varphi_2) H^{-1}), \quad (3.63)$$

where  $L(\varphi)$  denotes the operator of left Moyal-multiplication by  $\varphi$  (a look at [16] can help the unfamiliar reader to derive such formula). We show in the appendix A that the leading divergence of (3.63) is given by

$$\int_{\mathbb{R}^d} dx \varphi_1 \star \varphi_2(x) H_\epsilon^{-1}(x, x). \quad (3.64)$$

The last expression equals

$$\int_{\mathbb{R}^d} dx \varphi_1 \star \varphi_2(x) \int_\epsilon^\infty d\beta \frac{1}{\sinh^{d/2}(2\omega\beta)} e^{-\omega \tanh(\omega\beta)|x|^2}. \quad (3.65)$$

Due to the presence of the fields  $\varphi_1, \varphi_2$  inside the  $x$ -integral, the former can be estimated by

$$\int_{\mathbb{R}^d} dx |\varphi_1 \star \varphi_2|(x) \int_\epsilon^\infty d\beta \frac{1}{\sinh^{d/2}(2\omega\beta)}. \quad (3.66)$$

Since in the Moyal plane case only even dimensions are allowed (to respect the symplectic pairs structure of the Moyal product), the divergence of the planar two-point diagram (3.63) is (only) logarithmic for  $d = 2$  and (as expected) quadratic for  $d = 4$ .

This is a strong evidence that our field theory on  $\mathcal{S}(\mathbb{R}^d)$  doesn't behave accordingly to the dimension  $d$  of the representation space, but accordingly to the dimension  $2d$  of the underlying noncommutative torus!

### 3.4 Feynman diagrams in the holomorphic representation

From now on, we shall work in the holomorphic representation for a Bargmann module in two dimensions, obtained by tensoring twice the module of the previous type, i.e. corresponding to a four-dimensional deformation matrix of the form (2.68). In the explicit computation of Feynman diagrams, we have to evaluate traces and kernels of products of operators of the type  $H^{-1}$  and  $U_\gamma$  in the holomorphic representation. To this aim, recall that an operator  $A$  is said to be an operator with distribution kernel  $A(z, \bar{z}')$  if its action on  $\phi \in \mathcal{H}_B$  can be written as

$$A\phi(z) = \int_{\mathbb{C}^2} d\mu(z', \bar{z}') A(z, \bar{z}') \phi(z'). \quad (3.67)$$

For instance, the identity is an operator with kernel  $I(z, \bar{z}') = e^{\omega \bar{z}' z}$ ; the reproducing kernel of the Bargmann space. By convention, our kernels are holomorphic in the in first variable (associated to an incoming field on the diagram) and anti-holomorphic in the second one (associated to an outgoing field).

Now and for all, we will fix a regularization scheme. To this aim, we define the regularized propagator  $H_\epsilon^{-1}$  as follows

$$H_\epsilon^{-1} := \int_\epsilon^\infty d\beta e^{-\beta H} = H^{-1} e^{-\epsilon H}. \quad (3.68)$$

As soon as  $\epsilon > 0$ , the operator  $H_\epsilon^{-1}$  is a strictly positive compact operator with fast decreasing eigenvalues, and in particular trace-class. This operator admits a kernel given by

$$H_\epsilon^{-1}(z_2, \bar{z}_1) = \frac{1}{2} \int_\epsilon^\infty d\beta e^{-\frac{\beta m^2}{2}} I(z_2, e^{-\beta \omega} \bar{z}_1). \quad (3.69)$$

As such, it provides a natural regularization of the Feynman integrals. Indeed, if we come back to  $\mathcal{E}_S(\mathbb{R}^2)$  by the inverse Bargmann transform, it is easy to see that  $H_\epsilon^{-1}(x, y)$  is a function of Schwartz class in both variables (have a look at (3.60) versus (3.61)). Since the vertex (3.32)

is a tempered distribution, this means that all the contractions with the regularized propagator are now well defined. Using the Bargmann transform back, it is immediate to see that the same holds for the module  $\mathcal{E}_B(\mathbb{C}^2)$ .

The regularized propagator, given by the expression (3.69), is graphically represented by a single oriented line:

$$\xrightarrow{z_1} \xrightarrow{\bar{z}_2} = H_\epsilon^{-1}(z_1, \bar{z}_2). \quad (3.70)$$

Using the definition (2.51), it is easy to see that the operator  $U_\gamma$  also admits a kernel, given by

$$U_\gamma(z_1, \bar{z}_2) = e^{-\frac{\omega}{2}|\gamma|^2 - \omega\bar{\gamma}z_1} I(z_1 + \gamma, \bar{z}_2) = e^{-\frac{\omega}{2}|\gamma|^2 + \omega\bar{z}_2\gamma} I(z_1, \bar{z}_2 - \bar{\gamma}). \quad (3.71)$$

Thus in the holomorphic representation, the (total or quadri-valent) vertex reads

$$\begin{aligned} V(z_1, \bar{z}_2, z_3, \bar{z}_4) &= \frac{\lambda}{2} \sum_\gamma U_\gamma(z_1, \bar{z}_2) U_{-\gamma}(z_3, \bar{z}_4) \\ &= \frac{\lambda}{2} \sum_\gamma e^{-\omega|\gamma|^2} e^{\omega(\bar{z}_2 - \bar{z}_4)\gamma} I(z_1, \bar{z}_2 - \bar{\gamma}) I(z_3, \bar{z}_4 + \bar{\gamma}) \\ &= \frac{\lambda}{2} \sum_\gamma e^{-\omega|\gamma|^2} I(\gamma, \bar{z}_2 - \bar{z}_4) I(z_1, \bar{z}_2 - \bar{\gamma}) I(z_3, \bar{z}_4 + \bar{\gamma}) \end{aligned} \quad (3.72)$$

and is represented by

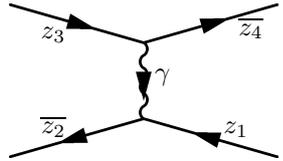

$$= V(z_1, \bar{z}_2, z_3, \bar{z}_4). \quad (3.73)$$

When drawing the Feynman graphs it is important to notice that propagator and vertex are oriented. When following the scalar field arrow, the wavy  $\gamma$ -line always leaves the vertex to the right. Alternatively, to stress the link with the Hubbard-Stratonovich transformation, we may split the vertex (3.73) into two tri-valent vertices



$$= i\lambda U_\gamma(z_1, \bar{z}_2), \quad (3.74)$$

and a propagator for the auxiliary field



$$= \frac{1}{\lambda}. \quad (3.75)$$

### 3.5 Parametric representation

A careful analysis of the involved terms shows that a general (regularized) graph always has the following structure

$$\Gamma_n[z_1, \bar{z}_2, \dots, z_{2N-1}, \bar{z}_{2N}] = \sum_{\gamma_1, \dots, \gamma_V} \int_\epsilon^\infty \prod_{k=1}^L (d\beta_k e^{-\frac{\mu_0^2}{2}\beta_k}) \frac{1}{U_\Gamma(\beta)} e^{-\gamma_i \mathcal{Q}_{ij}(\beta) \bar{\gamma}_j + \mathcal{B}_i(z, \beta) \bar{\gamma}_i + \gamma_i \bar{\mathcal{B}}_i(\bar{z}, \beta)},$$

up to a symmetry factor due to its multiple appearance and a term purely depending on  $z_1, \dots, \bar{z}_{2N}$ . The notation means that having chosen an arbitrary graph,  $L$  indicates the number of internal scalar field line integrations and  $V$  is the number of  $\gamma$ -lines. Missing indices for  $\beta$  or

$z$  is just short for taking all. We now give a complete set of rules to construct the matrix  $\mathcal{Q}_{ij}(\beta)$  and the linear terms  $\mathcal{B}_i(z, \beta)$ ,  $\overline{\mathcal{B}}_i(\bar{z}, \beta)$  respectively. These can be used to directly write down the result, skipping Gaussian integrations or tracing out loops.

Draw a graph and properly orient the scalar lines as well as the  $\gamma$ -lines. For each internal line, there is a  $\beta$ -integration accompanied by a factor  $\exp(-\frac{\mu_0^2}{2}\beta)$ . For each  $\gamma$  there is a sum. To construct the diagonal  $\mathcal{Q}_{ii}$ , one has to take care of five different types of  $\gamma$ -lines:

1. Each  $\gamma_i$  which connects two different external lines gives  $\mathcal{Q}_{ii} = \omega$ .
2. A  $\gamma_i$  connecting a line with a bubble leads to

$$\mathcal{Q}_{ii} = \frac{\omega}{(1 - e^{-\omega \sum \beta_k})}, \quad (3.76)$$

where the sum counts the internal integrations of the associated bubble.

3. Each  $\gamma_i$  that connects two loops  $L_1$  and  $L_2$  generates a term

$$\mathcal{Q}_{ii} = \omega \frac{(1 - e^{-\omega \sum \beta_k})}{(1 - e^{-\omega \sum_{L_1} \beta_k})(1 - e^{-\omega \sum_{L_2} \beta_k})}, \quad (3.77)$$

where  $\sum_{L_1}$ , respectively  $\sum_{L_2}$ , counts the internal integrations of the associated loop and the  $\beta$ -sum in the numerator counts them all.

4. An internal  $\gamma_i$  on an external line gives

$$\mathcal{Q}_{ii} = \omega(1 - e^{-\omega \sum \beta_k}), \quad (3.78)$$

where the sum counts the  $\beta$ -integrations appearing on the part of the external line which is enclosed by that  $\gamma_i$ .

5. Every  $\gamma_i$ , which represents an internal line inside a bubble generates

$$\mathcal{Q}_{ii} = \omega \frac{(1 - e^{-\omega \sum_{H_1} \beta_k})(1 - e^{-\omega \sum_{H_2} \beta_k})}{(1 - e^{-\omega \sum \beta_k})}, \quad (3.79)$$

where the sum in the denominator counts all  $\beta$ -integrations of the bubble and  $\sum_{H_1}$  ( $\sum_{H_2}$ ) counts the  $\beta$ -integrations of the first (second) half of the bubble, each defined by the points the gamma is attached to.

For the off diagonal elements  $\mathcal{Q}_{ij}$ , there are essentially two different cases to take care of.

1. Lines. For a  $\gamma_i$  which is attached to a chosen line, there are three possibilities. The  $\gamma_i$  may leave or arrive, or it may be 'internal'. Following the orientation of the line, denote by  $\gamma_i^{(1)}$  the first position the  $\gamma_i$  is attached to and by  $\gamma_i^{(2)}$  the (possible) second position. Of course, the latter might be empty. Further, define  $\text{sign}(\gamma_i^{(a)})$  to be +1 if it is arriving and -1 otherwise. The same convention holds for a  $\gamma_j$  with  $i \neq j$ . As a last ingredient, define  $L_{ij}^{(a,b)}$  to be the sum over internal integration variables  $\beta$  enclosed by the positions  $\gamma_i^{(a)}$  and  $\gamma_j^{(b)}$  on the line. Then, the final contribution is

$$\mathcal{Q}_{ij} = \omega \sum_{a,b,a < b} \text{sign}(\gamma_i^{(a)}) \text{sign}(\gamma_j^{(b)}) e^{-\omega L_{ij}^{(a,b)}}. \quad (3.80)$$

With slight abuse of notation, the ordering  $a < b$  is given by the orientation of the line.

2. Loops. If there is a  $\gamma_i$  and a  $\gamma_j$  attached to a chosen loop, the same conventions as in 1) can be used. Here,  $L_{ij}^{(a,b)}$  is defined to be the sum over internal integration variables on the shortest loop segment connecting  $\gamma_i^{(a)}$  and  $\gamma_j^{(b)}$  following the orientation of the loop. One finds

$$\mathcal{Q}_{ij} = \frac{\omega}{(1 - e^{-\omega \sum \beta_k})} \sum_{a,b} \text{sign}(\gamma_i^{(a)}) \text{sign}(\gamma_j^{(b)}) e^{-\omega L_{ij}^{(a,b)}}. \quad (3.81)$$

In this case, note that there is no ordering in the sum over  $a, b$ , but again, the convention is to take only  $a = 2$  ( $b = 2$ ) if the associated  $\gamma$  really is internal.

The general procedure to construct the matrix  $\mathcal{Q}_{ij}$  is then to regard line by line and loop by loop all  $\gamma$ 's that are attached to it and to apply the rules given above. For the linear terms  $\mathcal{B}_i(z, \beta)$  and  $\overline{\mathcal{B}}_j(\bar{z}, \beta)$  it is sufficient to restrict oneself to a line by line analysis.

1. For the first one, for every line decorated with an incoming  $z_k$  and outgoing  $\bar{z}_l$  denote by  $\gamma_i^{(1)}$  and  $\gamma_i^{(2)}$ , as before, the positions a  $\gamma_i$  might be attached to. Define  $L_i^{(a)}$  to be the sum of internal integration variables on the line segment between  $z_k$  and  $\gamma_i^{(a)}$  following the orientation. Note that  $L_i^{(a)}$  can be the empty sum. One has

$$\mathcal{B}_i = -\omega z_k \sum_a \text{sign}(\gamma_i^{(a)}) e^{-\omega L_i^{(a)}}, \quad (3.82)$$

and the sum only runs from  $a = 1$  to  $a = 2$  if there is a second attachment point.

2. The second term is constructed completely analogously. It is

$$\overline{\mathcal{B}}_i = \omega \bar{z}_l \sum_a \text{sign}(\gamma_i^{(a)}) e^{-\omega L_i^{(a)}}, \quad (3.83)$$

with  $L_i^{(a)}$  being the sum of  $\beta$ 's on the oriented line segment between  $\gamma_i^{(a)}$  and  $\bar{z}_l$ .

The pre-factor  $U_\Gamma(\beta)$  is a product of terms of the form  $(1 - e^{-\omega \sum \beta_k})^{d/2}$ . Namely, for each scalar loop  $L$  it associates such a factor, that is, for  $d = 4$  dimensions

$$U_\Gamma(\beta) = \prod_L (1 - e^{-\omega \sum_L \beta_k})^2. \quad (3.84)$$

The sum  $\sum_L \beta_k$  stands again for the sum over the internal integration variables defined on the corresponding loop.

As an example, consider the first 4-point graph  $\Gamma_{4a}^{(1)}[z_1, \bar{z}_2, z_3, \bar{z}_4]$  (given in (4.13)). For  $\mathcal{Q}_{ij}$  and  $\mathcal{B}_i, \overline{\mathcal{B}}_i$  one finds

$$\mathcal{Q}_{ij} = \frac{\omega}{(1 - e^{-\omega(\beta_1 + \beta_2)})} \begin{pmatrix} 1 & -e^{-\omega\beta_2} \\ -e^{-\omega\beta_1} & 1 \end{pmatrix}, \quad (3.85)$$

and

$$\mathcal{B}_i = \omega \begin{pmatrix} -z_1 \\ z_3 \end{pmatrix}, \quad \overline{\mathcal{B}}_i = \omega \begin{pmatrix} \bar{z}_2 \\ -\bar{z}_4 \end{pmatrix}, \quad (3.86)$$

as well as

$$U_{\Gamma_{4a}^{(1)}} = (1 - e^{-\omega(\beta_1 + \beta_2)})^2. \quad (3.87)$$

To complete the construction, finally include for each external line decorated with incoming  $z_k$  and outgoing  $\bar{z}_l$  a term  $\exp\{z_k \bar{z}_l e^{-\omega \sum_i \beta_i}\}$  with the sum given by the (possibly empty) sum over all integrations variables on that line.

## 4 One-loop renormalization

We start this section by showing that for a  $\phi^4$ -theory on the simplest Heisenberg module  $\mathcal{E}_B(\mathbb{C}^2)$  over  $\mathbb{T}_\theta^4$ , only the two- and four-point functions are divergent in the one-loop approximation.

**Proposition 4.1.** *At one loop, for  $N > 2$ , the  $2N$ -point Green's functions are finite as tempered distributions.*

*Proof.* In the one-loop approximation, the 1PI quantum effective action in external fields  $\varphi_1 \in \mathcal{E}$ ,  $\overline{\varphi_2} \in \mathcal{E}^*$  is given by

$$\Gamma^{(1)}[\varphi_1, \overline{\varphi_2}] = \frac{1}{2} \ln \det (H^{-1}(H + \lambda B_{\varphi_1, \overline{\varphi_2}})), \quad (4.1)$$

where  $H$  is the harmonic oscillator Hamiltonian in two dimensions,  $\lambda$  is the coupling constant and  $B_{\varphi_1, \overline{\varphi_2}}$  is a bounded operator on  $\mathcal{H}_\mathcal{E}$ , depending only on  $\varphi_1 \in \mathcal{E}$ ,  $\overline{\varphi_2} \in \mathcal{E}^*$ . ( $\mathcal{E}$  can be either  $\mathcal{E}_S(\mathbb{R}^2)$  or  $\mathcal{E}_B(\mathbb{C}^2)$ .) Here the definition of  $\Gamma^{(1)}[\varphi_1, \overline{\varphi_2}]$  includes the normalization of the partition function, yielding the  $H^{-1}$  pre-factor in the determinant. To see that only the two- and four-point functions need regularization, we perform a Dyson expansion. It formally reads:

$$\ln \det (H^{-1}(H + \lambda B_{\varphi_1, \overline{\varphi_2}})) = \text{Tr} \ln (1 + \lambda H^{-1} B_{\varphi_1, \overline{\varphi_2}}) = \sum_{n=1}^{\infty} (-)^{n+1} \frac{\lambda^n}{n} \text{Tr} ((H^{-1} B_{\varphi_1, \overline{\varphi_2}})^n). \quad (4.2)$$

But in  $d = 2$  dimensions, the spectrum of  $H^{-1}$  is  $\{(1 + n_1 + n_2)^{-1}, n_1, n_2 \in \mathbb{N}\}$ , so that  $H^{-1}$  belongs to  $\mathcal{L}^p(\mathcal{H}_\mathcal{E})$  (the  $p$ -th Schatten class) for  $p > 2$ . Thus only the two first terms of (4.2) are divergent. Moreover, the truncated series (starting at  $n = 3$ ) is absolutely convergent for reasonable small values of (the absolute value of) the coupling constant:

$$\begin{aligned} \left| \sum_{n=3}^{\infty} (-)^{n+1} \frac{\lambda^n}{n} \text{Tr} ((H^{-1} B_{\varphi_1, \overline{\varphi_2}})^n) \right| &\leq \sum_{n=3}^{\infty} \|B_{\varphi_1, \overline{\varphi_2}}\|^n \frac{|\lambda|^n}{n} \|H^{-1}\|^{n-3} \|H^{-3}\|_1 \\ &\leq \sum_{n=3}^{\infty} \|B_{\varphi_1, \overline{\varphi_2}}\|^n \frac{|\lambda|^n}{n}. \end{aligned}$$

□

### 4.1 2-point sector

At one loop we have the following contributions for the two-point function:

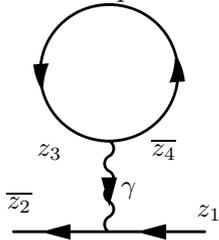

$$\Gamma_{2a}^{(1)}[z_1, \overline{z_2}] = 2 \int d\mu(z_3, \overline{z_3}) d\mu(z_4, \overline{z_4}) V(z_1, \overline{z_2}, z_3, \overline{z_4}) H_\epsilon^{-1}(z_4, \overline{z_3}). \quad (4.3)$$

The graph of this type appears twice, once with loop connecting  $\overline{z_4} \rightarrow z_3$  (which is shown) and once with loop connecting  $\overline{z_2} \rightarrow z_1$ . Replacing  $\gamma \mapsto -\gamma$  shows that both contributions are identical.

The  $z_4$ -integration is directly eliminated using one reproducing kernel of the vertex (3.73), and we are left with

$$\Gamma_{2a}^{(1)}[z_1, \overline{z_2}] = \frac{\lambda}{2} I(z_1, \overline{z_2}) \int_\epsilon^\infty d\beta \sum_\gamma \int d\mu(z, \overline{z}) e^{-\frac{\beta \mu_0^2}{2}} e^{-\omega(|\gamma|^2 - |z|^2) e^{-\beta \omega} + \overline{z} \gamma e^{-\beta \omega} - \overline{\gamma} z + \overline{\gamma} z_1 - \overline{z_2} \gamma}. \quad (4.4)$$

Now the Gaußian  $z$ -integral can be evaluated to give

$$\Gamma_{2a}^{(1)}[z_1, \bar{z}_2] = \frac{\lambda}{2} I(z_1, \bar{z}_2) \int_{\varepsilon}^{\infty} d\beta \sum_{\gamma} \frac{e^{-\frac{\beta\mu_0^2}{2}} e^{-\omega(\frac{|\gamma|^2}{1-e^{-\beta\omega}} + \bar{\gamma}z_1 - \bar{z}_2\gamma)}}{(1 - e^{-\beta\omega})^2}. \quad (4.5)$$

These two operations, use of reproducing kernels and Gaußian integration for loops, can be tedious for more complicated graphs. This is the reason why we provide the general rules for the parametric representation of an arbitrary Feynman graph in subsection 3.5.

In the last expression (4.5), only the term  $\gamma = 0$  is divergent. This divergence is local and quadratic in the cut-off ( $\Lambda = \varepsilon^{-1/2}$ ), yielding a mass counter-term:

$$\Gamma_{2a,div}^{(1)}[z_1, \bar{z}_2] = \frac{\lambda}{2} I(z_1, \bar{z}_2) \int_{\varepsilon}^{\infty} d\beta \frac{e^{-\frac{\beta\mu_0^2}{2}}}{(1 - e^{-\beta\omega})^2}. \quad (4.6)$$

The (integrated) sum over  $\gamma \neq 0$  is convergent as a distribution on  $\mathcal{E}_B(\mathbb{C}^2)$ , in the limit  $\varepsilon \rightarrow 0$ . (Recall that as a Fréchet space,  $\mathcal{E}_B(\mathbb{C}^2)$  is defined as the image of  $\mathcal{E}_S(\mathbb{R}^2) = \mathcal{S}(\mathbb{R}^2)$  under the Bargmann transform.) Indeed, we have for any  $\varphi_1, \varphi_2 \in \mathcal{E}_B(\mathbb{C}^2)$

$$\begin{aligned} & \Gamma_{2a,conv}^{(1)}[\bar{\varphi}_1, \varphi_2] \\ &= \int d\mu(z_1, \bar{z}_1) d\mu(z_2, \bar{z}_2) \bar{\varphi}_1(\bar{z}_1) \varphi_2(z_2) I(z_1, \bar{z}_2) \int_0^{\infty} d\beta \sum_{\gamma \neq 0} \frac{e^{-\frac{\beta\mu_0^2}{2}} e^{-\omega(\frac{|\gamma|^2}{1-e^{-\beta\omega}} + \bar{\gamma}z_1 - \bar{z}_2\gamma)}}{(1 - e^{-\beta\omega})^2} \\ &= \sum_{\gamma \neq 0} \langle \varphi_1, \varphi_2 U_{\gamma} \rangle_{\mathcal{B}} \int_0^{\infty} d\beta \frac{e^{-\frac{\beta\mu_0^2}{2}} e^{-\omega \frac{|\gamma|^2}{2} \frac{1+e^{-\beta\omega}}{1-e^{-\beta\omega}}}}{(1 - e^{-\beta\omega})^2}. \end{aligned} \quad (4.7)$$

The  $\beta$ -integral is bounded from above since  $|\gamma|^2 \geq \frac{\theta^2}{2}$ . Because  $\langle \varphi_1, \varphi_2 U_{\gamma} \rangle_{\mathcal{B}}$  is by construction a Schwartz sequence, the sum is finite. More precise estimations can be obtained using

$$\frac{1 - e^{-x_0}}{x_0} x \leq 1 - e^{-x} \leq x \quad \text{for} \quad 0 \leq x \leq x_0. \quad (4.8)$$

The second contribution to the one-loop two-point function is the graph

$$\Gamma_{2b}^{(1)}[z_1, \bar{z}_2] = 2 \int d\mu(z_3, \bar{z}_3) d\mu(z_4, \bar{z}_4) V(z_1, \bar{z}_4, z_3, \bar{z}_2) H_{\varepsilon}^{-1}(z_4, \bar{z}_3). \quad (4.9)$$

There are again two graphs of this type which after a change of variables give the same contribution. Using (3.73) and (3.69), we find

$$\Gamma_{2b}^{(1)}[z_1, \bar{z}_2] = \frac{\lambda}{2} I(z_1, \bar{z}_2) \sum_{\gamma} \int_{\varepsilon}^{\infty} d\beta e^{-\frac{\beta\mu_0^2}{2}} e^{-\omega(\bar{\gamma}(1-e^{-\beta\omega})\gamma + \bar{\gamma}(1-e^{-\beta\omega})z_1 + \bar{z}_2(1-e^{-\beta\omega})\gamma + \bar{z}_2(1-e^{-\beta\omega})z_1)}. \quad (4.10)$$

A small  $\beta$  spoils the Gaußian decay for large  $|\gamma|$ . This can be made transparent by a Poisson re-summation. For that, the convention on the Fourier transform we use is  $\hat{f}(\xi) = \int e^{-2i\pi x\xi} f(x) dx$ . The formula we obtain with this convention is

$$\sum_{\gamma} e^{-\omega a|\gamma|^2} e^{-\omega(\bar{b}\gamma + \bar{\gamma}c)} = (a\theta)^{-2} \sum_{\gamma^*} e^{\frac{\omega}{a}(\bar{b} + i\bar{\gamma}^*)(c + i\gamma^*)}, \quad \text{for all } a \in \mathbb{R}_*^+, b, c \in \mathbb{C}^2, \quad (4.11)$$

with the frequency  $\omega = \frac{2\pi}{\theta}$  and with  $\gamma = \frac{\theta}{\sqrt{2}}(n+im) \in \Gamma \subset \mathbb{C}^2$  one has  $\gamma^* = \frac{1}{\sqrt{2}}(n+im) \in \hat{\Gamma} \subset \mathbb{C}^2$ . In order to simplify the notations, here we use the notation  $\gamma^*$  instead of  $\hat{\gamma}$  to denote an element of the dual lattice.

Using this formula, we can continue the computation of (4.10):

$$\Gamma_{2b}^{(1)}[z_1, \bar{z}_2] = \frac{\lambda}{2\theta^2} I(z_1, \bar{z}_2) \sum_{\gamma^*} \int_{\epsilon}^{\infty} d\beta \frac{e^{-\frac{\beta\mu_0^2}{2}} e^{-\omega\left(\frac{|\gamma^*|^2}{(1-e^{-\beta\omega})} - i\bar{z}_2\gamma^* - i\bar{\gamma}^*z_1\right)}}{(1-e^{-\beta\omega})^2}. \quad (4.12)$$

Thus, the diagram (4.12) is, up to a normalization factor  $\theta^{-2}$  and the exchange  $\gamma \leftrightarrow i\gamma^*$ , the same as (4.5): only the term with  $\gamma^* = 0$  is divergent, with a local quadratic divergence.

We have proven the following

**Proposition 4.2.** *For any  $\theta \in \mathbb{R}$ , the divergent part of the two-point 1PI Green function associated with the action (2.33), in its one-loop approximation, is given by*

$$\Gamma_{2,div}^{(1)}[\bar{\varphi}_1, \varphi_2] = \frac{\lambda}{2\omega} \left(1 + \frac{1}{\theta^2}\right) \text{Tr}_{\mathcal{A}_\theta} [(\varphi_1, \varphi_2)_{\mathcal{A}_\theta}] \left(\frac{1}{\epsilon\omega} + \left(1 - \frac{\mu_0^2}{2\omega}\right) \ln \frac{1}{\epsilon}\right).$$

## 4.2 4-point sector: Planar graphs

Next, we look at four-leg graphs. The first possibility is

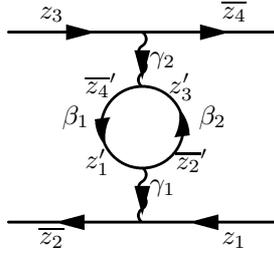

$$\begin{aligned} \Gamma_{4a}^{(1)}[z_1, \bar{z}_2, z_3, \bar{z}_4] &= -2 \int d\mu(z'_1, \bar{z}'_1) d\mu(z'_2, \bar{z}'_2) d\mu(z'_3, \bar{z}'_3) d\mu(z'_4, \bar{z}'_4) \\ &\quad \times V(z_1, \bar{z}_2, z'_1, \bar{z}'_1) V(z'_3, \bar{z}'_3, z_3, \bar{z}_4) H_\epsilon^{-1}(z'_2, \bar{z}'_2) H_\epsilon^{-1}(z'_4, \bar{z}'_4). \end{aligned} \quad (4.13)$$

This graph appears four times in the expansion, and because it contains two vertices there is a combinatorial factor  $\frac{1}{2!}$ . The minus sign is from the Legendre transformation of 1PI functions. Three of the four integrations (e.g. over  $z'_2, z'_3, z'_4$ ) can be trivially done using the reproducing kernels in the vertex. Thus we have

$$\begin{aligned} \Gamma_{4a}^{(1)}[z_1, \bar{z}_2, z_3, \bar{z}_4] &= -\frac{\lambda^2}{8} \int_{\epsilon}^{\infty} d\beta_1 d\beta_2 \sum_{\gamma_1, \gamma_2} e^{-\frac{\mu_0^2}{2}(\beta_1+\beta_2)} e^{-\omega(|\gamma_1|^2+|\gamma_2|^2-\bar{z}_2\gamma_1-\bar{z}_2z_1+\bar{\gamma}_1z_1+\bar{z}_4\gamma_2-\bar{z}_4z_3-\bar{\gamma}_2z_3)} \\ &\quad \times \int d\mu(z, \bar{z}) e^{-\omega(-\bar{z}e^{-\beta_1\omega}\gamma_2+\bar{z}e^{-(\beta_1+\beta_2)\omega}\gamma_1-\bar{\gamma}_2e^{-\beta_2\omega}\gamma_1-\bar{z}e^{-(\beta_1+\beta_2)\omega}z+\bar{\gamma}_2e^{-\beta_2\omega}z-\bar{\gamma}_1z)}. \end{aligned}$$

We integrate over  $z$ , put  $\gamma_2 = \gamma_1 + \gamma$ , and obtain after some reorganizations

$$\begin{aligned} \Gamma_{4a}^{(1)}[z_1, \bar{z}_2, z_3, \bar{z}_4] &= -\frac{\lambda^2}{8} \sum_{\gamma_1, \gamma} e^{-\omega|\gamma_1|^2} I(\gamma_1, \bar{z}_2 - \bar{z}_4) I(z_1, \bar{z}_2 - \bar{\gamma}_1) I(z_3, \bar{z}_4 + \bar{\gamma}_1) \int_{\epsilon}^{\infty} \frac{d\beta_1 d\beta_2 e^{-\frac{\mu_0^2}{2}(\beta_1+\beta_2)}}{(1-e^{-(\beta_1+\beta_2)\omega})^2} \\ &\quad \times e^{-\omega(\bar{z}_4\gamma-\bar{\gamma}z_3+\frac{|\gamma|^2}{1-e^{-(\beta_1+\beta_2)\omega}}+\bar{\gamma}_1\frac{1-e^{-\beta_1\omega}}{1-e^{-(\beta_1+\beta_2)\omega}}\gamma+\bar{\gamma}\frac{1-e^{-\beta_2\omega}}{1-e^{-(\beta_1+\beta_2)\omega}}\gamma_1+|\gamma_1|^2\frac{(1-e^{-\beta_1\omega})(1-e^{-\beta_2\omega})}{1-e^{-(\beta_1+\beta_2)\omega}})}. \end{aligned} \quad (4.14)$$

For  $\gamma = 0$  one obtains

$$\Gamma_{4a,0}^{(1)}[z_1, \bar{z}_2, z_3, \bar{z}_4] = -\frac{\lambda}{4} V(z_1, \bar{z}_2, z_3, \bar{z}_4) \int_{\epsilon}^{\infty} \frac{d\beta_1 d\beta_2 e^{-\frac{\mu_0^2}{2}(\beta_1+\beta_2)}}{(1-e^{-(\beta_1+\beta_2)\omega})^2} \quad (4.15)$$

$$\begin{aligned}
& + \frac{\lambda^2}{8} \sum_{\gamma_1} e^{-\omega|\gamma_1|^2} I(\gamma_1, \bar{z}_2 - \bar{z}_4) I(z_1, \bar{z}_2 - \bar{\gamma}_1) I(z_3, \bar{z}_4 + \bar{\gamma}_1) \\
& \times \int_{\varepsilon}^{\infty} \frac{d\beta_1 d\beta_2 e^{-\frac{\mu_0^2}{2}(\beta_1+\beta_2)}}{(1 - e^{-(\beta_1+\beta_2)\omega})^2} \left(1 - e^{-\omega|\gamma_1|^2 \frac{(1-e^{-\beta_1\omega})(1-e^{-\beta_2\omega})}{1-e^{-(\beta_1+\beta_2)\omega}}}\right). \quad (4.16)
\end{aligned}$$

The line (4.15) gives the logarithmically divergent renormalization of the coupling constant. It remains to show that the remaining parts are convergent. In (4.16), if we add the external fields  $\varphi_1, \varphi_2, \varphi_3, \varphi_4 \in \mathcal{E}_B(\mathbb{C}^2)$  and if use the inequality (4.8), we obtain:

$$\begin{aligned}
& \left| \sum_{\gamma_1} \langle \varphi_1, \varphi_2 U_{\gamma_1} \rangle_B \langle \varphi_3, \varphi_4 U_{-\gamma_1} \rangle_B \int_0^{\infty} \frac{d\beta_1 d\beta_2 e^{-\frac{\mu_0^2}{2}(\beta_1+\beta_2)}}{(1 - e^{-(\beta_1+\beta_2)\omega})^2} \left(1 - e^{-\omega|\gamma_1|^2 \frac{(1-e^{-\beta_1\omega})(1-e^{-\beta_2\omega})}{1-e^{-(\beta_1+\beta_2)\omega}}}\right) \right| \\
& \leq \omega \sum_{\gamma_1} |\langle \varphi_1, \varphi_2 U_{\gamma_1} \rangle_B| |\langle \varphi_3, \varphi_4 U_{-\gamma_1} \rangle_B| |\gamma_1|^2 \int_0^{\infty} d\beta_1 d\beta_2 e^{-\frac{\mu_0^2}{2}(\beta_1+\beta_2)} \frac{(1 - e^{-\beta_1\omega})(1 - e^{-\beta_2\omega})}{(1 - e^{-(\beta_1+\beta_2)\omega})^3},
\end{aligned}$$

which is finite since  $\langle \varphi_i, \varphi_j U_{\gamma_1} \rangle_B$  is a Schwartz sequence and because the  $\beta$ -integral is now harmless.

It remains to estimate in (4.14) the remaining sum over  $\gamma \neq 0$ . Similar manipulations show that

$$\begin{aligned}
\Gamma_{4a, \neq 0}^{(1)}[\bar{\varphi}_1, \varphi_2, \bar{\varphi}_3, \varphi_4] & = -\frac{\lambda^2}{8} \sum_{\gamma_1, \gamma \neq 0} \langle \varphi_1, \varphi_2 U_{-\gamma_1} \rangle_B \langle \varphi_3, \varphi_4 U_{\gamma_1+\gamma} \rangle_B \int_0^{\infty} \frac{d\beta_1 d\beta_2 e^{-\frac{\mu_0^2}{2}(\beta_1+\beta_2)}}{(1 - e^{-(\beta_1+\beta_2)\omega})^2} \\
& \times e^{-\frac{\omega}{2}(|\gamma|^2 \frac{1+e^{-(\beta_1+\beta_2)\omega}}{1-e^{-(\beta_1+\beta_2)\omega}} + \bar{\gamma}_1 \gamma \frac{1-2e^{-\beta_1\omega} + e^{-(\beta_1+\beta_2)\omega}}{1-e^{-(\beta_1+\beta_2)\omega}} + \bar{\gamma}_1 \gamma \frac{1-2e^{-\beta_2\omega} + e^{-(\beta_1+\beta_2)\omega}}{1-e^{-(\beta_1+\beta_2)\omega}} + 2|\gamma_1|^2 \frac{(1-e^{-\beta_1\omega})(1-e^{-\beta_2\omega})}{1-e^{-(\beta_1+\beta_2)\omega}})}.
\end{aligned}$$

Thus,

$$\begin{aligned}
\left| \Gamma_{4a, \neq 0}^{(1)}[\bar{\varphi}_1, \varphi_2, \bar{\varphi}_3, \varphi_4] \right| & \leq \frac{\lambda^2}{8} \sum_{\gamma_1, \gamma \neq 0} |\langle \varphi_1, \varphi_2 U_{-\gamma_1} \rangle_B \langle \varphi_3, \varphi_4 U_{\gamma_1+\gamma} \rangle_B| \int_0^{\infty} \frac{d\beta_1 d\beta_2 e^{-\frac{\mu_0^2}{2}(\beta_1+\beta_2)}}{(1 - e^{-(\beta_1+\beta_2)\omega})^2} \\
& \times e^{-\frac{\omega}{2}(|\gamma|^2 \frac{1+e^{-(\beta_1+\beta_2)\omega}}{1-e^{-(\beta_1+\beta_2)\omega}} + (\bar{\gamma}_1 \gamma + \bar{\gamma}_1 \gamma + 2|\gamma_1|^2) \frac{(1-e^{-\beta_1\omega})(1-e^{-\beta_2\omega})}{1-e^{-(\beta_1+\beta_2)\omega}})} \\
& \leq \frac{\lambda^2}{8} \sum_{\gamma_1, \gamma \neq 0} |\langle \varphi_1, \varphi_2 U_{-\gamma_1} \rangle_B \langle \varphi_3, \varphi_4 U_{\gamma_1+\gamma} \rangle_B| \int_0^{\infty} \frac{d\beta_1 d\beta_2 e^{-\frac{\mu_0^2}{2}(\beta_1+\beta_2)}}{(1 - e^{-(\beta_1+\beta_2)\omega})^2} e^{-\frac{\omega\theta^2}{4} \frac{e^{-\beta_1\omega} + e^{-\beta_2\omega}}{1-e^{-(\beta_1+\beta_2)\omega}}},
\end{aligned}$$

which is finite.

The next graph is

$$\begin{aligned}
& \Gamma_{4b}^{(1)}[z_1, \bar{z}_2, z_3, \bar{z}_4] \\
& = -2 \int d\mu(z'_1, \bar{z}'_1) d\mu(z'_2, \bar{z}'_2) d\mu(z'_3, \bar{z}'_3) d\mu(z'_4, \bar{z}'_4) \\
& \times V(z_1, \bar{z}'_2, z'_3, \bar{z}_4) V(z'_1, \bar{z}_2, z_3, \bar{z}'_4) H_{\varepsilon}^{-1}(z'_2, \bar{z}'_1) H_{\varepsilon}^{-1}(z'_4, \bar{z}'_2). \quad (4.17)
\end{aligned}$$

This graph appears with the same symmetry factor as the first one. All  $z'$ -integrations can be trivially done using the reproducing kernels in the vertices, giving

$$\begin{aligned}
\Gamma_{4b}^{(1)}[z_1, \bar{z}_2, z_3, \bar{z}_4] & = -\frac{\lambda^2}{8} \sum_{\gamma_1, \gamma_2} \int_{\varepsilon}^{\infty} d\beta_1 d\beta_2 e^{-\frac{\mu_0^2}{2}(\beta_1+\beta_2)} e^{-\omega(|\gamma_2|^2 + |\gamma_1|^2 + \bar{z}_2 \gamma_2 + \bar{\gamma}_1 z_1 + \bar{z}_4 \gamma_1 + \bar{\gamma}_2 z_3)} \\
& \times e^{\omega(\bar{z}_2 e^{-\beta_1\omega} \gamma_1 + \bar{\gamma}_2 e^{-\beta_1\omega} \gamma_1 + \bar{z}_2 e^{-\beta_1\omega} z_1 + \bar{\gamma}_2 e^{-\beta_1\omega} z_1 + \bar{z}_4 e^{-\beta_2\omega} \gamma_2 + \bar{\gamma}_1 e^{-\beta_2\omega} \gamma_2 + \bar{z}_4 e^{-\beta_2\omega} z_3 + \bar{\gamma}_1 e^{-\beta_2\omega} z_3)}.
\end{aligned}$$

There are two ways to proceed. We could set  $\gamma_1 = \gamma_2 + \gamma$  and perform a Poisson re-summation (4.11) in the loop variable  $\gamma_2$ . The second possibility, which underlines the duality with the previous graph, consists in a Poisson re-summation in both  $\gamma_1$  and  $\gamma_2$ :

$$\Gamma_{4b}^{(1)}[z_1, \bar{z}_2, z_3, \bar{z}_4] = -\frac{\lambda^2}{8\theta^4} e^{\omega(\bar{z}_4 z_1 + \bar{z}_2 z_3)} \sum_{\gamma_1^*, \gamma_2^*} \int_{\epsilon}^{\infty} d\beta_1 d\beta_2 \frac{e^{-\frac{\mu_0^2}{2}(\beta_1 + \beta_2)\omega}}{(1 - e^{-(\beta_1 + \beta_2)\omega})^2} e^{-\omega \frac{|\gamma_1^*|^2 + |\gamma_2^*|^2}{1 - e^{-(\beta_1 + \beta_2)\omega}}} \\ \times e^{\omega(i\bar{\gamma}_1^* z_1 + \bar{z}_4 i\gamma_1^* + \bar{z}_2 i\gamma_2^* + i\bar{\gamma}_2^* z_3 + \frac{i\bar{\gamma}_1^* e^{-\beta_2 \omega} i\gamma_2^* + i\bar{\gamma}_2^* e^{-\beta_1 \omega} i\gamma_1^*}{1 - e^{-(\beta_1 + \beta_2)\omega}})}.$$

If we plug now  $\gamma_2^* = -\gamma_1^* + \gamma^*$ , we see that this graph leads to the same expression as the previous one (4.14), up to a constant factor and the exchange  $\gamma_1 \rightarrow i\gamma_1^*$ ,  $\gamma \rightarrow -i\gamma^*$  and  $z_2 \leftrightarrow z_4$ :

$$\Gamma_{4b}^{(1)}[z_1, \bar{z}_2, z_3, \bar{z}_4] \\ = -\frac{\lambda^2}{8\theta^4} \sum_{\gamma_1^*, \gamma^*} e^{-\omega|\gamma_1^*|^2} I(i\gamma_1^*, \bar{z}_4 - \bar{z}_2) I(z_1, \bar{z}_4 - i\bar{\gamma}_1^*) I(z_3, \bar{z}_2 + i\bar{\gamma}_1^*) \int_{\epsilon}^{\infty} \frac{d\beta_1 d\beta_2 e^{-\frac{\mu_0^2}{2}(\beta_1 + \beta_2)\omega}}{(1 - e^{-(\beta_1 + \beta_2)\omega})^2} \\ \times e^{-\omega(-\bar{z}_2 i\gamma^* - i\bar{\gamma}^* z_3 + \frac{|\gamma^*|^2}{1 - e^{-(\beta_1 + \beta_2)\omega}} + i\bar{\gamma}_1^* \frac{1 - e^{-\beta_2 \omega}}{1 - e^{-(\beta_1 + \beta_2)\omega}} i\gamma^* + i\bar{\gamma}^* \frac{1 - e^{-\beta_1 \omega}}{1 - e^{-(\beta_1 + \beta_2)\omega}} i\gamma_1^* + |\gamma_1^*|^2 \frac{(1 - e^{-\beta_1 \omega})(1 - e^{-\beta_2 \omega})}{1 - e^{-(\beta_1 + \beta_2)\omega}})}.$$
 (4.18)

The divergent part is thus given by

$$\Gamma_{4b,div}^{(1)}[z_1, \bar{z}_2, z_3, \bar{z}_4] \\ = -\frac{\lambda^2}{8\theta^4} \sum_{\gamma_1^*} e^{-\omega|\gamma_1^*|^2} I(i\gamma_1^*, \bar{z}_4 - \bar{z}_2) I(z_1, \bar{z}_4 - i\bar{\gamma}_1^*) I(z_3, \bar{z}_2 + i\bar{\gamma}_1^*) \int_{\epsilon}^{\infty} \frac{d\beta_1 d\beta_2 e^{-\frac{\mu_0^2}{2}(\beta_1 + \beta_2)\omega}}{(1 - e^{-(\beta_1 + \beta_2)\omega})^2},$$
 (4.19)

which gives after a (final) Poisson re-summation (4.11) another (local, logarithmically divergent) contribution for the coupling constant renormalization:

$$\Gamma_{4b,div}^{(1)}[z_1, \bar{z}_2, z_3, \bar{z}_4] = -\frac{\lambda}{4\theta^2} V(z_1, \bar{z}_2, z_3, \bar{z}_4) \int_{\epsilon}^{\infty} \frac{d\beta_1 d\beta_2 e^{-\frac{\mu_0^2}{2}(\beta_1 + \beta_2)\omega}}{(1 - e^{-(\beta_1 + \beta_2)\omega})^2}.$$
 (4.20)

We can summarize this estimations in the following

**Proposition 4.3.** *For any  $\theta \in \mathbb{R}$ , the divergent part of the four-point planar 1PI Green function associated with the action (2.33), in its one-loop approximation, is given by*

$$\Gamma_{4,planar,div}^{(1)}[\bar{\varphi}_1, \varphi_2, \bar{\varphi}_3, \varphi_3] = -\frac{\lambda^2}{8\omega^2} \left(1 + \frac{1}{\theta^2}\right) \text{Tr}_{\mathcal{A}_\theta} [(\varphi_1, \varphi_2)_{\mathcal{A}_\theta} (\varphi_3, \varphi_4)_{\mathcal{A}_\theta}] \ln \frac{1}{\epsilon}.$$

### 4.3 4-point sector: Non-planar graphs

Up to now, we have found only local divergences which can be absorbed in a mass and coupling constant renormalization. This is not the end of the story. We will see that the next two four-point one-loop graphs develop non-local divergences, in the sense that the counter-term needed is not present in the classical action (2.33). Indeed, the next graphs are topologically non-planar and their singularities are of the same kind as the singularity of the non-planar sector of a scalar field theory on the noncommutative torus or even on certain isospectral deformations [16]. This is the discrete version of the so-called the UV/IR-entanglement phenomenon: these new singularities are restricted to the zero-mode  $\gamma = 0$  of the vertex. They should not appear in

models where the zero-mode can be consistently removed such as for  $U(1)$ -Yang-Mills theory on the noncommutative torus [22].

As we will see, the behavior of these non-planar graphs for the Heisenberg module is highly sensitive to the number-theoretical aspect of the deformation parameter  $\theta$ . There are two different cases to consider. When  $\theta$  is rational, we know that the model is a commutative one and the singularities are local. For irrational  $\theta$ , in order to control the sums for non-vanishing  $\gamma$ , we need to impose a Diophantine type condition. We first give definitions.

**Definition 4.4.** An irrational number  $\theta$  is said to satisfy a *Diophantine condition* if for all  $n \in \mathbb{Z} \setminus \{0\}$  there exist two constants  $C, \delta > 0$  such that

$$\|n\theta\|_{\mathbb{T}} = \inf_{m \in \mathbb{Z}} |n\theta - m| \geq C|n|^{-(1+\delta)}. \quad (4.21)$$

We have the possibility to weaken this condition: An irrational number  $\theta$  is said to satisfy a *weak Diophantine condition* if for all  $n \in \mathbb{Z} \setminus \{0\}$  there exist two constants  $C_1, C_2 > 0$  such that

$$\|n\theta\|_{\mathbb{T}} = \inf_{m \in \mathbb{Z}} |n\theta - m| \geq C_1 e^{-C_2|n|}. \quad (4.22)$$

Those definitions extends for tuples of irrational number  $(\theta_1, \dots, \theta_d)$ , where the exponent  $1 + \delta$  in (4.21) has to be replaced by  $d + \delta$ .

A Diophantine condition is a way to measure “how far from rationals” is an irrational number. More precisely, it means that the convergence of the continuous fractional expansion is quite slow. Note that the (ordinary) Diophantine condition is equivalent to the requirement that the inverse torus-norm of  $n\theta$  is a tempered distribution on  $\mathcal{S}(\mathbb{Z} \setminus \{0\})$ . This is a natural requirement because of the distributional nature of QFT and since the basic formulation of our model relies on Schwartz sequences. Note also that irrational numbers satisfying a Diophantine condition are not exceptional since they are of full Lebesgue measure. However, since at one-loop the non-planar sector is only logarithmically divergent, this condition can be weakened: We are able to control the convergence even under the weakest version of the Diophantine condition (4.22).

The first non-planar graph to compute is given by

$$\begin{aligned} & \Gamma_{4c}^{(1)}[z_1, \bar{z}_2, z_3, \bar{z}_4] \\ &= -4 \int d\mu(z'_1, \bar{z}'_1) d\mu(z'_2, \bar{z}'_2) d\mu(z'_3, \bar{z}'_3) d\mu(z'_4, \bar{z}'_4) \\ & V(z_1, \bar{z}_2, z'_1, \bar{z}'_2) V(z_3, \bar{z}_4, z'_3, \bar{z}'_4) H_\epsilon^{-1}(z'_2, \bar{z}'_3) H_\epsilon^{-1}(z'_4, \bar{z}'_1). \end{aligned} \quad (4.23)$$

This graph appears eight times in the expansion, leading to twice the symmetry factor of the previous graphs. We have

$$\begin{aligned} \Gamma_{4c}^{(1)}[z_1, \bar{z}_2, z_3, \bar{z}_4] &= -\frac{\lambda^2}{4} \sum_{\gamma_1, \gamma_2} \int_\epsilon^\infty d\beta_1 d\beta_2 e^{-\frac{\mu_0^2}{2}(\beta_1 + \beta_2)} e^{-\omega(|\gamma_1|^2 + |\gamma_2|^2 - \bar{z}_2 \gamma_1 - (\bar{z}_2 - \bar{\gamma}_1)z_1 + \bar{z}_4 \gamma_2)} \\ & \times e^{\omega(-(\bar{z}_4 + \bar{\gamma}_2)e^{-\beta_1 \omega} \gamma_1 + ((\bar{z}_4 + \bar{\gamma}_2)e^{-(\beta_1 + \beta_2)\omega} + \bar{\gamma}_1 e^{-\beta_2 \omega}) \gamma_2 + ((\bar{z}_4 + \bar{\gamma}_2)e^{-(\beta_1 + \beta_2)\omega} + \bar{\gamma}_1 e^{-\beta_2 \omega} - \bar{\gamma}_2)z_3)}. \end{aligned} \quad (4.24)$$

We perform a Poisson re-summation in the loop wavy line index (in  $\gamma_2$ ):

$$\begin{aligned} \Gamma_{4c}^{(1)}[z_1, \bar{z}_2, z_3, \bar{z}_4] &= -\frac{\lambda^2}{4\theta^2} \sum_{\gamma_1, \gamma_2^*} e^{\omega(\bar{z}_2 z_1 + \bar{z}_4 z_3 + i\bar{\gamma}_2^* z_3 + \bar{z}_4 i\gamma_2^* - \bar{\gamma}_1 z_1 + \bar{z}_2 \gamma_1)} \int_\epsilon^\infty d\beta_1 d\beta_2 \frac{e^{-\frac{\mu_0^2}{2}(\beta_1 + \beta_2)}}{(1 - e^{-(\beta_1 + \beta_2)\omega})^2} \\ & \times e^{-\frac{\omega}{1 - e^{-(\beta_1 + \beta_2)\omega}}(|\gamma_1|^2 + |\gamma_2^*|^2 + \bar{\gamma}_1 i\gamma_2^* e^{-\beta_2 \omega} - i\bar{\gamma}_2^* \gamma_1 e^{-\beta_1 \omega})}. \end{aligned} \quad (4.25)$$

In order to see what happens in the different arithmetical cases, it is perhaps more enlightening to add external field  $\varphi_1, \varphi_2, \varphi_3, \varphi_4 \in \mathcal{E}_B$ . After some rearrangements, we obtain

$$\begin{aligned} \Gamma_{4c}^{(1)}[\overline{\varphi}_1, \varphi_2, \overline{\varphi}_3, \varphi_4] &= -\frac{\lambda^2}{4\theta^2} \sum_{\gamma_1, \gamma_2^*} \langle \varphi_1, \varphi_2 U_{\gamma_1} \rangle_B \langle \varphi_3, \varphi_4 U_{i\gamma_2^*} \rangle_B \int_{\varepsilon}^{\infty} d\beta_1 d\beta_2 \frac{e^{-\frac{\mu_0^2}{2}(\beta_1+\beta_2)}}{(1 - e^{-(\beta_1+\beta_2)\omega})^2} \\ &\times e^{-\frac{\omega}{2} \frac{1+e^{-(\beta_1+\beta_2)\omega}}{1-e^{-(\beta_1+\beta_2)\omega}} (|\gamma_1|^2 + |\gamma_2^*|^2)} e^{-\frac{\omega}{1-e^{-(\beta_1+\beta_2)\omega}} (\overline{\gamma_1} i \gamma_2^* e^{-\beta_2 \omega} - i \overline{\gamma_2^*} \gamma_1 e^{-\beta_1 \omega})}. \end{aligned} \quad (4.26)$$

Now, the number-theoretical aspect of the deformation parameter  $\theta$  comes into the play. Since  $\gamma^* = \frac{1}{\sqrt{2}}(m + in)$ , for  $\theta \in \mathbb{N}$  (commutative case) we can set  $\gamma_1 = -i\gamma_2^*$  in (4.25) (the sum  $\gamma_1 \neq -i\gamma_2^*$  gives a finite contribution as it can be shown by similar estimates as those used along this section) and obtain

$$-\frac{\lambda^2}{4\theta^2} \sum_{\gamma_1} \langle \varphi_1, \varphi_2 U_{\gamma_1} \rangle_B \langle \varphi_3, \varphi_4 U_{-\gamma_1} \rangle_B \int_{\varepsilon}^{\infty} d\beta_1 d\beta_2 \frac{e^{-\frac{\mu_0^2}{2}(\beta_1+\beta_2)}}{(1 - e^{-(\beta_1+\beta_2)\omega})^2} e^{-\omega|\gamma_1|^2 \frac{(1-e^{-\beta_1\omega})(1-e^{-\beta_2\omega})}{1-e^{-(\beta_1+\beta_2)\omega}}}.$$

Thus, using the routine inequalities, we can extract the divergent part of  $\Gamma_{4d}^{(1)}[z_1, \overline{z_2}, z_3, \overline{z_4}]$ :

$$\Gamma_{4c,div}^{(1)}[z_1, \overline{z_2}, z_3, \overline{z_4}] = -\frac{\lambda}{2\theta^2} V(z_1, \overline{z_2}, z_3, \overline{z_4}) \int_{\varepsilon}^{\infty} d\beta_1 d\beta_2 \frac{e^{-\frac{\mu_0^2}{2}(\beta_1+\beta_2)}}{(1 - e^{-(\beta_1+\beta_2)\omega})^2}, \quad (4.27)$$

so in the commutative case, the divergence is local as expected.

When  $\theta$  is rational, the divergence is local as well. Indeed, for  $\theta = p/q$  we have  $\gamma_1 = \frac{p}{q\sqrt{2}}(m_1 + in_1)$  and  $-i\gamma_2^* = \frac{1}{\sqrt{2}}(n_2 - im_2)$ . Thus, if we restrict the sum to the set of  $(m_1, n_1, m_2, n_2) \in \mathbb{Z}^8$ , such that  $pn_1 = -qm_2$  and  $pm_1 = qn_2$  (the rest is a finite sum that corresponds to a finite multiplicity and yields a finite contribution) and if we add external fields and use the transformation (3.38), we find for the divergent part:

$$-\frac{q^2 \lambda^2}{4p^2} \int_0^{\frac{1}{q}} dx \int_0^{\frac{1}{q}} dy \text{Tr} [M^\dagger M](x, y) \text{Tr} [M^\dagger M](x, y) \int_{\varepsilon}^{\infty} d\beta_1 d\beta_2 \frac{e^{-\frac{\mu_0^2}{2}(\beta_1+\beta_2)}}{(1 - e^{-(\beta_1+\beta_2)\omega})^2}. \quad (4.28)$$

Whereas unfamiliar in the standard formulation of a field theory on a vector bundle with matricial fibers, such a term in the original action is perfectly acceptable.

When  $\theta$  is irrational, plus satisfying a Diophantine condition (Definition 4.4) to control the sums  $\gamma_1, \gamma_2^* \neq 0$ , we see in (4.25) that only the mode  $\gamma_1 = 0, \gamma_2^* = 0$  will contribute to the divergent part. There are three regions to consider:

- (I)  $\gamma_1 = \gamma_2^* = 0,$
- (II)  $\gamma_1 = 0, \gamma_2^* \neq 0,$
- (III)  $\gamma_1 \neq 0, \text{ any } \gamma_2^*.$

In case (I), we obtain

$$\Gamma_{4c, \theta \notin \mathbb{Q}, (I)}^{(1)}[\overline{\varphi}_1, \varphi_2, \overline{\varphi}_3, \varphi_4] = -\frac{\lambda^2}{4\theta^2} \langle \varphi_1, \varphi_2 \rangle_B \langle \varphi_3, \varphi_4 \rangle_B \int_{\varepsilon}^{\infty} d\beta_1 d\beta_2 \frac{e^{-\frac{\mu_0^2}{2}(\beta_1+\beta_2)}}{(1 - e^{-(\beta_1+\beta_2)\omega})^2}. \quad (4.29)$$

It is worthwhile to notice that this divergence is non-local and requires a counter-term of the form

$$\text{Tr}_{\mathcal{A}_\theta} [(\varphi, \varphi)_{\mathcal{A}_\theta}] \text{Tr}_{\mathcal{A}_\theta} [(\varphi, \varphi)_{\mathcal{A}_\theta}]. \quad (4.30)$$

This is the discrete version of the UV/IR-entanglement, reminiscent to toric-noncommutative spaces [16].

The estimation in region (II) is analogous to an estimation we performed for planar graphs. It remains to estimate the region (III), where the Diophantine condition will be used. We obtain in the limit  $\varepsilon \rightarrow 0$ :

$$\begin{aligned}
& \left| \Gamma_{4c, \theta \notin \mathbb{Q}, (III)}^{(1)}[\overline{\varphi_1}, \varphi_2, \overline{\varphi_3}, \varphi_4] \right| \\
& \leq \frac{\lambda^2}{4\theta^2} \sum_{\gamma_1 \neq 0, \gamma_2^*} \left| \langle \varphi_1, \varphi_2 U_{\gamma_1} \rangle_B \right| \left| \langle \varphi_3, \varphi_4 U_{i\gamma_2^*} \rangle_B \right| \\
& \quad \times \int_0^\infty d\beta_1 d\beta_2 \frac{e^{-\frac{\mu_0^2}{2}(\beta_1 + \beta_2)}}{(1 - e^{-(\beta_1 + \beta_2)\omega})^2} e^{-\frac{\omega}{2} \frac{1 + e^{-(\beta_1 + \beta_2)\omega}}{1 - e^{-(\beta_1 + \beta_2)\omega}} (|\gamma_1|^2 + |\gamma_2^*|^2)} e^{-\frac{\omega}{2} \frac{e^{-\beta_1} + e^{-\beta_2}}{1 - e^{-(\beta_1 + \beta_2)\omega}} (\overline{\gamma_1} i \gamma_2^* - i \overline{\gamma_2^*} \gamma_1)} \\
& = \frac{\lambda^2}{4\theta^2} \sum_{\gamma_1 \neq 0, \gamma_2^*} \left| \langle \varphi_1, \varphi_2 U_{\gamma_1} \rangle_B \right| \left| \langle \varphi_3, \varphi_4 U_{i\gamma_2^*} \rangle_B \right| \\
& \quad \times \int_0^\infty d\beta_1 d\beta_2 \frac{e^{-\frac{\mu_0^2}{2}(\beta_1 + \beta_2)}}{(1 - e^{-(\beta_1 + \beta_2)\omega})^2} e^{-\frac{\omega}{2} \frac{e^{-\beta_1\omega} + e^{-\beta_2\omega}}{1 - e^{-(\beta_1 + \beta_2)\omega}} |\gamma_1 + i\gamma_2^*|^2} e^{-\frac{\omega}{2} \frac{(1 - e^{-\beta_1})(1 - e^{-\beta_2})}{1 - e^{-(\beta_1 + \beta_2)\omega}} (|\gamma_1|^2 + |\gamma_2^*|^2)} \\
& \leq \frac{\lambda^2}{4\theta^2} \sum_{\gamma_1 \neq 0, \gamma_2^*} \left| \langle \varphi_1, \varphi_2 U_{\gamma_1} \rangle_B \right| \left| \langle \varphi_3, \varphi_4 U_{i\gamma_2^*} \rangle_B \right| \\
& \quad \times \int_0^\infty d\beta_1 d\beta_2 \frac{e^{-\frac{\mu_0^2}{2}(\beta_1 + \beta_2)}}{(1 - e^{-(\beta_1 + \beta_2)\omega})^2} e^{-\frac{\omega}{2} \frac{e^{-\beta_1\omega} + e^{-\beta_2\omega}}{1 - e^{-(\beta_1 + \beta_2)\omega}} |\gamma_1 + i\gamma_2^*|^2}. \tag{4.31}
\end{aligned}$$

Using now the (regular) Diophantine condition according to Definition 4.4, and disregarding the  $\beta$ -integrals from 1 to  $+\infty$  (which gives a finite contribution say  $C_1$ ), we are left with

$$\begin{aligned}
& \left| \Gamma_{4c, \gamma_1 \neq 0, (III)}^{(1)}[\overline{\varphi_1}, \varphi_2, \overline{\varphi_3}, \varphi_4] \right| \\
& \leq C_1 + \frac{\lambda^2}{4\theta^2} \sum_{\gamma_2^*} \left| \langle \varphi_3, \varphi_4 U_{i\gamma_2^*} \rangle_B \right| \sum_{\gamma_1 \neq 0} \left| \langle \varphi_1, \varphi_2 U_{\gamma_1} \rangle_B \right| \int_0^1 d\beta_1 d\beta_2 \frac{\sup_{\gamma_2^*} \left\{ e^{-\frac{\omega}{2} \frac{e^{-\beta_1\omega} + e^{-\beta_2\omega}}{1 - e^{-(\beta_1 + \beta_2)\omega}} |\gamma_1 + i\gamma_2^*|^2} \right\}}{(1 - e^{-(\beta_1 + \beta_2)\omega})^2} \\
& \leq C_1 + C_2 \sum_{\gamma_1 \neq 0} \left| \langle \varphi_1, \varphi_2 U_{\gamma_1} \rangle_B \right| \int_0^1 d\beta_1 d\beta_2 \frac{e^{-\frac{\omega}{2} \frac{e^{-\beta_1\omega} + e^{-\beta_2\omega}}{1 - e^{-(\beta_1 + \beta_2)\omega}} \inf_{\gamma_2^*} |\gamma_1 + i\gamma_2^*|^2}}{(1 - e^{-(\beta_1 + \beta_2)\omega})^2} \\
& \leq C_1 + C_2 \sum_{\gamma_1 \neq 0} \left| \langle \varphi_1, \varphi_2 U_{\gamma_1} \rangle_B \right| \int_0^1 d\beta_1 d\beta_2 \frac{e^{-\frac{C\omega}{2} \frac{e^{-\beta_1\omega} + e^{-\beta_2\omega}}{1 - e^{-(\beta_1 + \beta_2)\omega}} |\gamma_1|^{-2(4+\delta)}}}{(1 - e^{-(\beta_1 + \beta_2)\omega})^2} \\
& \leq C_1 + \sum_{\gamma_1 \neq 0} \left| \langle \varphi_1, \varphi_2 U_{\gamma_1} \rangle_B \right| (C_3 + C_4 \ln |\gamma_1|), \tag{4.32}
\end{aligned}$$

which is finite because  $\langle \varphi_i, \varphi_j U_\gamma \rangle_B$  is a Schwartz sequence.

It should be clear that the same conclusion holds with the weak Diophantine condition (4.22) instead. The reason for that works is that this graph is logarithmically divergent only. However, it is unclear for us if this condition will suffice at higher loops. There is a general argument [6] that oriented just renormalizable  $\phi^4$ -models do not have quadratically divergent non-planar graphs. If this argument applies to our case, the weak Diophantine condition might suffice in general.

The second non-planar graph we have to compute is

$$\begin{aligned}
& \Gamma_{4d}^{(1)}[z_1, \bar{z}_2, z_3, \bar{z}_4] \\
&= -2 \int d\mu(z'_1, \bar{z}'_1) d\mu(z'_2, \bar{z}'_2) d\mu(z'_3, \bar{z}'_3) d\mu(z'_4, \bar{z}'_4) \\
& \times V(z_1, \bar{z}'_2, z_3, \bar{z}'_4) V(z'_3, \bar{z}_4, z'_1, \bar{z}_2) H_\varepsilon^{-1}(z'_2, \bar{z}'_1) H_\varepsilon^{-1}(z'_4, \bar{z}'_3). \tag{4.33}
\end{aligned}$$

We have

$$\begin{aligned}
\Gamma_{4d}^{(1)}[z_1, \bar{z}_2, z_3, \bar{z}_4] &= -\frac{\lambda^2}{8} \sum_{\gamma_1, \gamma_2} \int_\varepsilon^\infty d\beta_1 d\beta_2 e^{-\frac{\mu_0^2}{2}(\beta_1 + \beta_2)} e^{-\omega(|\gamma_1|^2 + |\gamma_2|^2)} \\
& \times e^{\omega(\bar{z}_2 \gamma_2 + (\bar{z}_2 - \bar{\gamma}_2) e^{-\beta_1 \omega} \gamma_1 + (\bar{z}_2 - \bar{\gamma}_2) e^{-\beta_1 \omega} z_1 - \bar{\gamma}_1 z_1 - \bar{z}_4 \gamma_2 - (\bar{z}_4 + \bar{\gamma}_2) e^{-\beta_2 \omega} \gamma_1 + (\bar{z}_4 + \bar{\gamma}_2) e^{-\beta_2 \omega} z_3 + \bar{\gamma}_1 z_3)}.
\end{aligned}$$

We set  $\gamma_2 = -\gamma_1 + \gamma$ . The resulting Gaussian decay in  $\gamma_1$  is suppressed for small  $\beta_i$ , which is best expressed by a Poisson re-summation in  $\gamma_1$ :

$$\begin{aligned}
& \Gamma_{4d}^{(1)}[z_1, \bar{z}_2, z_3, \bar{z}_4] \\
&= -\frac{\lambda^2}{8\theta^2} \sum_{\gamma_1^*, \gamma} \int_\varepsilon^\infty \frac{d\beta_1 d\beta_2 e^{-\frac{\mu_0^2}{2}(\beta_1 + \beta_2)}}{(2 - e^{-\beta_1 \omega} - e^{-\beta_2 \omega})^2} e^{\omega((\bar{z}_2 - \bar{z}_4)\gamma - |\gamma|^2 + (\bar{z}_2 - \bar{\gamma}) e^{-\beta_1 \omega} z_1 + (\bar{z}_4 + \bar{\gamma}) e^{-\beta_2 \omega} z_3)} \\
& \times e^{\frac{\omega}{(2 - e^{-\beta_1 \omega} - e^{-\beta_2 \omega})} (\bar{\gamma}(1 - e^{-\beta_1 \omega} - e^{-\beta_2 \omega}) - \bar{z}_2(1 - e^{-\beta_1 \omega}) + \bar{z}_4(1 - e^{-\beta_2 \omega}) - i\bar{\gamma}_1^*) (\gamma - (1 - e^{-\beta_1 \omega}) z_1 + (1 - e^{-\beta_2 \omega}) z_3 - i\gamma_1^*)} \\
&= -\frac{\lambda^2}{8\theta^2} \sum_{\gamma_1^*, \gamma} \int_\varepsilon^\infty \frac{d\beta_1 d\beta_2 e^{-\frac{\mu_0^2}{2}(\beta_1 + \beta_2)}}{(2 - e^{-\beta_1 \omega} - e^{-\beta_2 \omega})^2} e^{\omega((\bar{z}_2 - \bar{z}_4)\gamma + \bar{\gamma}(z_3 - z_1) + \bar{z}_2 z_1 + \bar{z}_4 z_3 - \bar{\gamma}_1 \gamma_1^*)} \\
& \times e^{-\frac{\omega}{(2 - e^{-\beta_1 \omega} - e^{-\beta_2 \omega})} (|\gamma - i\gamma_1^*|^2 + (\gamma - i\gamma_1^*)((1 - e^{-\beta_2 \omega}) z_3 - (1 - e^{-\beta_1 \omega}) z_1) + (\bar{z}_2(1 - e^{-\beta_1 \omega}) - \bar{z}_4(1 - e^{-\beta_2 \omega})) (\gamma - i\gamma_1^*))} \\
& \times e^{-\frac{\omega(1 - e^{-\beta_1 \omega})(1 - e^{-\beta_2 \omega})}{(2 - e^{-\beta_1 \omega} - e^{-\beta_2 \omega})} (\bar{z}_2 + \bar{z}_4)(z_1 + z_3)}. \tag{4.34}
\end{aligned}$$

When  $\theta$  is irrational, plus satisfying a Diophantine condition (Definition 4.4) to control the sums  $\gamma, \gamma_1^* \neq 0$ , we see that only the mode  $\gamma = 0, \gamma_1^* = 0$  will contribute to the diverging part. Adding external fields and integrating over the  $z_i$ -positions with the help of the reproducing kernels, we obtain in this case

$$\begin{aligned}
\Gamma_{4d, \gamma = \gamma_1^* = 0}^{(1)}[\bar{\varphi}_1, \varphi_2, \bar{\varphi}_3, \varphi_4] &= -\frac{\lambda^2}{8\theta^2} \int d\mu(z_1, \bar{z}_1) d\mu(z_3, \bar{z}_3) \int_\varepsilon^\infty \frac{d\beta_1 d\beta_2 e^{-\frac{\mu_0^2}{2}(\beta_1 + \beta_2)}}{(2 - e^{-\beta_1 \omega} - e^{-\beta_2 \omega})^2} \\
& \bar{\varphi}_1(\bar{z}_1) \varphi_2\left(z_1 - \frac{\omega(1 - e^{-\beta_1 \omega})(1 - e^{-\beta_2 \omega})}{(2 - e^{-\beta_1 \omega} - e^{-\beta_2 \omega})} (z_1 + z_3)\right) \bar{\varphi}_3(\bar{z}_3) \varphi_4\left(z_3 - \frac{\omega(1 - e^{-\beta_1 \omega})(1 - e^{-\beta_2 \omega})}{(2 - e^{-\beta_1 \omega} - e^{-\beta_2 \omega})} (z_1 + z_3)\right). \tag{4.35}
\end{aligned}$$

Now, using Taylor's theorem in the form  $\varphi(z + y) = \varphi(z) + y \int_0^1 d\xi (\partial\varphi)(z + \xi y)$ , it is easy to see that the derivatives of  $\varphi$  lead to a convergent  $\beta$ -integral. Therefore, the divergent part is given by

$$\Gamma_{4d, div}^{(1)}[\bar{\varphi}_1, \varphi_2, \bar{\varphi}_3, \varphi_4] = -\frac{\lambda^2}{8\theta^2} \langle \varphi_1, \varphi_2 \rangle_{\mathcal{B}} \langle \varphi_3, \varphi_4 \rangle_{\mathcal{B}} \int_\varepsilon^\infty \frac{d\beta_1 d\beta_2 e^{-\frac{\mu_0^2}{2}(\beta_1 + \beta_2)}}{(2 - e^{-\beta_1 \omega} - e^{-\beta_2 \omega})^2}. \tag{4.36}$$

Again, this divergence is quite problematic at this stage since it corresponds to a counterterm of the form (4.30), which was not present in the classical action we have chosen (2.33).

For  $\theta \in \mathbb{N}$ , the divergent part of the graph (4.33) is given by the mode  $\gamma_1^* = -i\gamma$ . Using again Taylor's theorem we obtain

$$\Gamma_{4d, \theta \in \mathbb{N}, \text{div}}^{(1)}[z_1, \bar{z}_2, z_3, \bar{z}_4] = -\frac{\lambda}{4\theta^2} V(z_1, \bar{z}_2, z_3, \bar{z}_4) \int_{\varepsilon}^{\infty} \frac{d\beta_1 d\beta_2 e^{-\frac{\mu_0^2}{2}(\beta_1 + \beta_2)}}{(2 - e^{-\beta_1 \omega} - e^{-\beta_2 \omega})^2}. \quad (4.37)$$

In contrast to the irrational case, this is now a local counterterm. For  $\theta$  rational, the same discussion than in the previous graph applies, and we are left with a divergence of the form (4.28).

It remains to show that in the irrational Diophantian case, the remaining sum over  $(\gamma, \gamma_1^*) \neq (0, 0)$  leads to a convergent integral. With the help of reproducing kernels we find for (4.34)

$$\begin{aligned} \Gamma_{4d, \theta \notin \mathbb{Q}, \text{conv}}^{(1)}[\bar{\varphi}_1, \varphi_2, \bar{\varphi}_3, \varphi_4] &= -\frac{\lambda^2}{8\theta^2} \sum_{(\gamma_1^*, \gamma) \neq (0, 0)} \int d\mu(z_1, \bar{z}_1) d\mu(z_3, \bar{z}_3) \int_{\varepsilon}^{\infty} \frac{d\beta_1 d\beta_2 e^{-\frac{\mu_0^2}{2}(\beta_1 + \beta_2)}}{(2 - e^{-\beta_1 \omega} - e^{-\beta_2 \omega})^2} \\ &\times \bar{\varphi}_1(\bar{z}_1) \varphi_2\left(z_1 + \gamma - \frac{(1 - e^{-\beta_1 \omega})}{(2 - e^{-\beta_1 \omega} - e^{-\beta_2 \omega})}(\gamma - i\gamma_1^*) - \frac{(1 - e^{-\beta_1 \omega})(1 - e^{-\beta_2 \omega})}{(2 - e^{-\beta_1 \omega} - e^{-\beta_2 \omega})}(z_1 + z_3)\right) \\ &\times \bar{\varphi}_3(\bar{z}_3) \varphi_4\left(z_3 - \gamma + \frac{(1 - e^{-\beta_2 \omega})}{(2 - e^{-\beta_1 \omega} - e^{-\beta_2 \omega})}(\gamma - i\gamma_1^*) - \frac{(1 - e^{-\beta_1 \omega})(1 - e^{-\beta_2 \omega})}{(2 - e^{-\beta_1 \omega} - e^{-\beta_2 \omega})}(z_1 + z_3)\right) \\ &\times e^{\omega(\bar{\gamma}(z_3 - z_1) - \bar{\gamma}i\gamma_1^*)} e^{-\frac{\omega}{(2 - e^{-\beta_1 \omega} - e^{-\beta_2 \omega})}(|\gamma - i\gamma_1^*|^2 + (\overline{\gamma - i\gamma_1^*})((1 - e^{-\beta_2 \omega})z_3 - (1 - e^{-\beta_1 \omega})z_1))}. \end{aligned}$$

We re-express  $\gamma, \gamma_1^*$ -dependence of the field positions in terms of the unitaries  $U$ :

$$\begin{aligned} \Gamma_{4d, \theta \notin \mathbb{Q}, \text{conv}}^{(1)}[\bar{\varphi}_1, \varphi_2, \bar{\varphi}_3, \varphi_4] &= -\frac{\lambda^2}{8\theta^2} \sum_{(\gamma_1^*, \gamma) \neq (0, 0)} \int d\mu(z_1, \bar{z}_1) d\mu(z_3, \bar{z}_3) \int_{\varepsilon}^{\infty} \frac{d\beta_1 d\beta_2 e^{-\frac{\mu_0^2}{2}(\beta_1 + \beta_2)}}{(2 - e^{-\beta_1 \omega} - e^{-\beta_2 \omega})^2} \\ &\times \bar{\varphi}_1(\bar{z}_1) \left( \varphi_2 U_{\gamma} U_{-\frac{(1 - e^{-\beta_1 \omega})(\gamma - i\gamma_1^*)}{(2 - e^{-\beta_1 \omega} - e^{-\beta_2 \omega})}} \right) \left( z_1 - \frac{(1 - e^{-\beta_1 \omega})(1 - e^{-\beta_2 \omega})}{(2 - e^{-\beta_1 \omega} - e^{-\beta_2 \omega})}(z_1 + z_3) \right) \\ &\times \bar{\varphi}_3(\bar{z}_3) \left( \varphi_4 U_{-\gamma} U_{\frac{(1 - e^{-\beta_2 \omega})(\gamma - i\gamma_1^*)}{(2 - e^{-\beta_1 \omega} - e^{-\beta_2 \omega})}} \right) \left( z_3 - \frac{(1 - e^{-\beta_1 \omega})(1 - e^{-\beta_2 \omega})}{(2 - e^{-\beta_1 \omega} - e^{-\beta_2 \omega})}(z_1 + z_3) \right) \\ &\times e^{-\frac{\omega}{(2 - e^{-\beta_1 \omega} - e^{-\beta_2 \omega})}|\gamma - i\gamma_1^*|^2 \left( 1 - \frac{(1 - e^{-\beta_1 \omega})^2 + (1 - e^{-\beta_2 \omega})^2}{2(2 - e^{-\beta_1 \omega} - e^{-\beta_2 \omega})} \right)} \\ &\times e^{-\frac{\omega(1 - e^{-\beta_1 \omega})(1 - e^{-\beta_2 \omega})(e^{-\beta_1 \omega} - e^{-\beta_2 \omega})}{(2 - e^{-\beta_1 \omega} - e^{-\beta_2 \omega})^2} (\overline{\gamma - i\gamma_1^*})(z_1 + z_3)}. \end{aligned}$$

Now we absorb the last line in new unitaries, at the price of  $(\gamma - i\gamma_1^*)$ -dependent positions:

$$\begin{aligned} \Gamma_{4d, \theta \notin \mathbb{Q}, \text{conv}}^{(1)}[\bar{\varphi}_1, \varphi_2, \bar{\varphi}_3, \varphi_4] &= -\frac{\lambda^2}{8\theta^2} \sum_{(\gamma_1^*, \gamma) \neq (0, 0)} \int d\mu(z_1, \bar{z}_1) d\mu(z_3, \bar{z}_2) \int_{\varepsilon}^{\infty} \frac{d\beta_1 d\beta_2 e^{-\frac{\mu_0^2}{2}(\beta_1 + \beta_2)}}{(2 - e^{-\beta_1 \omega} - e^{-\beta_2 \omega})^2} \\ &\times \bar{\varphi}_1(\bar{z}_1) \left( \varphi_2 U_{-\gamma} U_{\frac{(1 - e^{-\beta_1 \omega})(\gamma - i\gamma_1^*)}{(2 - e^{-\beta_1 \omega} - e^{-\beta_2 \omega})}} U_{\frac{(1 - e^{-\beta_1 \omega})(1 - e^{-\beta_2 \omega})(e^{-\beta_1 \omega} - e^{-\beta_2 \omega})}{2(2 - e^{-\beta_1 \omega} - e^{-\beta_2 \omega})(e^{-\beta_2 \omega}(1 - e^{-\beta_1 \omega}) + e^{-\beta_1 \omega}(1 - e^{-\beta_2 \omega}))}} (\gamma - i\gamma_1^*)} \right) \\ &\left( z_1 - \frac{(1 - e^{-\beta_1 \omega})(1 - e^{-\beta_2 \omega})}{(2 - e^{-\beta_1 \omega} - e^{-\beta_2 \omega})}(z_1 + z_3) - \frac{(1 - e^{-\beta_1 \omega})(1 - e^{-\beta_2 \omega})(e^{-\beta_1 \omega} - e^{-\beta_2 \omega})}{2(2 - e^{-\beta_1 \omega} - e^{-\beta_2 \omega})(e^{-\beta_2 \omega}(1 - e^{-\beta_1 \omega}) + e^{-\beta_1 \omega}(1 - e^{-\beta_2 \omega}))} (\gamma - i\gamma_1^*) \right) \\ &\times \bar{\varphi}_3(\bar{z}_3) \left( \varphi_4 U_{\gamma} U_{-\frac{(1 - e^{-\beta_2 \omega})(\gamma - i\gamma_1^*)}{(2 - e^{-\beta_1 \omega} - e^{-\beta_2 \omega})}} U_{\frac{(1 - e^{-\beta_1 \omega})(1 - e^{-\beta_2 \omega})(e^{-\beta_1 \omega} - e^{-\beta_2 \omega})}{2(2 - e^{-\beta_1 \omega} - e^{-\beta_2 \omega})(e^{-\beta_2 \omega}(1 - e^{-\beta_1 \omega}) + e^{-\beta_1 \omega}(1 - e^{-\beta_2 \omega}))}} (\gamma - i\gamma_1^*)} \right) \\ &\left( z_3 - \frac{(1 - e^{-\beta_1 \omega})(1 - e^{-\beta_2 \omega})}{(2 - e^{-\beta_1 \omega} - e^{-\beta_2 \omega})}(z_1 + z_3) - \frac{(1 - e^{-\beta_1 \omega})(1 - e^{-\beta_2 \omega})(e^{-\beta_1 \omega} - e^{-\beta_2 \omega})}{2(2 - e^{-\beta_1 \omega} - e^{-\beta_2 \omega})(e^{-\beta_2 \omega}(1 - e^{-\beta_1 \omega}) + e^{-\beta_1 \omega}(1 - e^{-\beta_2 \omega}))} (\gamma - i\gamma_1^*) \right) \\ &\times e^{-\frac{\omega|\gamma - i\gamma_1^*|^2}{(2 - e^{-\beta_1 \omega} - e^{-\beta_2 \omega})} \left( 1 - \frac{(1 - e^{-\beta_1 \omega})^2 + (1 - e^{-\beta_2 \omega})^2}{2(2 - e^{-\beta_1 \omega} - e^{-\beta_2 \omega})} + \frac{(1 - e^{-\beta_1 \omega})^2(1 - e^{-\beta_2 \omega})^2(e^{-\beta_1 \omega} - e^{-\beta_2 \omega})^2}{4(2 - e^{-\beta_1 \omega} - e^{-\beta_2 \omega})(e^{-\beta_2 \omega}(1 - e^{-\beta_1 \omega}) + e^{-\beta_1 \omega}(1 - e^{-\beta_2 \omega}))^2} \right)}. \end{aligned}$$

Since

$$1 - \frac{(1 - e^{-\beta_1\omega})^2 + (1 - e^{-\beta_2\omega})^2}{2(2 - e^{-\beta_1\omega} - e^{-\beta_2\omega})} \geq \frac{1}{2},$$

we obtain

$$\begin{aligned} & \left| \Gamma_{4d, \theta \notin \mathbb{Q}, \text{conv}}^{(1)}[\overline{\varphi_1}, \varphi_2, \overline{\varphi_3}, \varphi_4] \right| \\ & \leq \frac{\lambda^2}{8\theta^2} \sum_{(\gamma_1^*, \gamma) \neq (0,0)} \int_{\varepsilon}^{\infty} \frac{d\beta_1 d\beta_2 e^{-\frac{\mu_0^2}{2}(\beta_1 + \beta_2)}}{(2 - e^{-\beta_1\omega} - e^{-\beta_2\omega})^2} e^{-\frac{\omega|\gamma - i\gamma_1^*|^2}{2(2 - e^{-\beta_1\omega} - e^{-\beta_2\omega})}} \\ & \times \left| \int d\mu(z_1, \overline{z_1}) d\mu(z_3, \overline{z_3}) \overline{\varphi_1}(\overline{z_1}) \overline{\varphi_3}(\overline{z_3}) \right. \\ & \times \left( \varphi_2 U_{-\gamma} U_{f_1(\beta_1, \beta_2)(\gamma - i\gamma_1^*)} U_{f_2(\beta_1, \beta_2)(\gamma - i\gamma_1^*)} \right) (z_1 - f_3(\beta_1, \beta_2)(z_1 + z_3) - f_2(\beta_1, \beta_2)(\gamma - i\gamma_1^*)) \\ & \times \left. \left( \varphi_4 U_{\gamma} U_{-f_1(\beta_2, \beta_1)(\gamma - i\gamma_1^*)} U_{f_2(\beta_1, \beta_2)(\gamma - i\gamma_1^*)} \right) (z_3 - f_3(\beta_1, \beta_2)(z_1 + z_3) - f_2(\beta_1, \beta_2)(\gamma - i\gamma_1^*)) \right|, \end{aligned}$$

where we have set

$$\begin{aligned} f_1(\beta_1, \beta_2) &= \frac{(1 - e^{-\beta_1\omega})}{(2 - e^{-\beta_1\omega} - e^{-\beta_2\omega})}, \\ f_2(\beta_1, \beta_2) &= \frac{(1 - e^{-\beta_1\omega})(1 - e^{-\beta_2\omega})(e^{-\beta_1\omega} - e^{-\beta_2\omega})}{2(2 - e^{-\beta_1\omega} - e^{-\beta_2\omega})(e^{-\beta_2\omega}(1 - e^{-\beta_1\omega}) + e^{-\beta_1\omega}(1 - e^{-\beta_2\omega}))}, \\ f_3(\beta_1, \beta_2) &= \frac{(1 - e^{-\beta_1\omega})(1 - e^{-\beta_2\omega})}{(2 - e^{-\beta_1\omega} - e^{-\beta_2\omega})}. \end{aligned}$$

The next step consists in disregarding the term  $f_3(\beta_1, \beta_2)(z_1 + z_3) + f_2(\beta_1, \beta_2)(\gamma - i\gamma_1^*)$  in the argument of  $\varphi_2, \varphi_4$ . Indeed, any  $\phi \in \mathcal{E}_B(\mathbb{C}^2) = \mathcal{BS}(\mathbb{R}^2)$  can be written as  $\phi(z) = \sum_n \phi_n z^n$ , where  $\{\phi_n\} \in \mathcal{S}(\mathbb{N})$ . This holds because any  $f \in \mathcal{S}(\mathbb{R}^2)$  can be expanded as a sum of the eigen-modes of the harmonic oscillator, with rapid decreasing coefficients. Thus, applying that to  $\varphi_2 U_{-\gamma} U_{f_1(\beta_1, \beta_2)(\gamma - i\gamma_1^*)} U_{f_2(\beta_1, \beta_2)(\gamma - i\gamma_1^*)}$ , the analysis of the first term in the expansion of

$$(z_1 - f_3(\beta_1, \beta_2)(z_1 + z_3) - f_2(\beta_1, \beta_2)(\gamma - i\gamma_1^*))^n,$$

is enough since they are all of the same weight, because  $f_i(\beta_1, \beta_2) \in L^\infty(\mathbb{R}^+ \times \mathbb{R}^+)$ ,  $i = 1, 2, 3$ . Thus, each term can be estimated along the same lines as the first one, with estimates uniform in  $\beta_i, \gamma, \gamma_1^*$ . Finally, the Schwartz coefficients will absorb the overall number of terms of the expansion in  $z^n$ . Thus, disregarding the integral from 1 to  $+\infty$  which gives a finite contribution  $C_1$ , we are left with

$$\begin{aligned} \left| \Gamma_{4d, \theta \notin \mathbb{Q}, \text{conv}}^{(1)}[\overline{\varphi_1}, \varphi_2, \overline{\varphi_3}, \varphi_4] \right| & \leq C_1 + \frac{\lambda^2}{8\theta^2} \sum_{(\gamma_1^*, \gamma) \neq (0,0)} \int_{\varepsilon}^1 \frac{d\beta_1 d\beta_2 e^{-\frac{\mu_0^2}{2}(\beta_1 + \beta_2)}}{(2 - e^{-\beta_1\omega} - e^{-\beta_2\omega})^2} e^{-\frac{\omega|\gamma - i\gamma_1^*|^2}{2(2 - e^{-\beta_1\omega} - e^{-\beta_2\omega})}} \\ & \times \left| \langle \varphi_1, \varphi_2 U_{-\gamma + (f_1(\beta_1, \beta_2) + f_2(\beta_1, \beta_2)(\gamma - i\gamma_1^*))} \rangle_B \langle \varphi_3, \varphi_4 U_{\gamma - (f_1(\beta_2, \beta_1) - f_2(\beta_1, \beta_2)(\gamma - i\gamma_1^*))} \rangle_B \right|, \end{aligned}$$

Since  $\langle \phi, \chi U_\eta \rangle_B$  belongs to  $\mathcal{S}(\mathbb{R}^4)$  as a function of  $\eta \in \mathbb{C}^2 \simeq \mathbb{R}^4$ , and since  $f_2 \rightarrow 0$ ,  $\beta_1, \beta_2 \rightarrow 0$  and  $f_1 \rightarrow 1$ ,  $\beta_1, \beta_2 \rightarrow 0$ ,  $\beta_1 = \beta_2$  (which is the only important case to treat), we deduce that

$$\left| \langle \varphi_1, \varphi_2 U_{-\gamma + (f_1(\beta_1, \beta_2) + f_2(\beta_1, \beta_2)(\gamma - i\gamma_1^*))} \rangle_B \langle \varphi_3, \varphi_4 U_{\gamma - (f_1(\beta_2, \beta_1) - f_2(\beta_1, \beta_2)(\gamma - i\gamma_1^*))} \rangle_B \right| \leq a_{\gamma, \gamma_1^*},$$

uniformly in  $\beta_1, \beta_2$  and where  $0 \leq \{a_{\gamma, \gamma_1^*}\} \in \mathcal{S}(\mathbb{Z}^8)$ . Finally, we get

$$\left| \Gamma_{4d, \theta \notin \mathbb{Q}, \text{conv}}^{(1)}[\overline{\varphi_1}, \varphi_2, \overline{\varphi_3}, \varphi_4] \right| \leq C_1 + \sum_{(\gamma_1^*, \gamma) \neq (0,0)} a_{\gamma, \gamma_1^*} \int_{\varepsilon}^1 \frac{d\beta_1 d\beta_2 e^{-\frac{\mu_0^2}{2}(\beta_1 + \beta_2)}}{(2 - e^{-\beta_1\omega} - e^{-\beta_2\omega})^2} e^{-\frac{\omega|\gamma - i\gamma_1^*|^2}{2(2 - e^{-\beta_1\omega} - e^{-\beta_2\omega})}}.$$

Thus the estimate (4.32) of the previous diagram applies as well and shows that the limit  $\epsilon \rightarrow 0$  is finite.

Gathering all result we have proven:

**Proposition 4.5.** *When  $\theta \in \mathbb{Q}$ , the divergent part of the four-point non-planar 1PI Green function associated with the action (2.33), in its one-loop approximation, is given by*

$$\begin{aligned} & \Gamma_{4,non-planar,div}^{(1)}[M_1^\dagger, M_2, M_3^\dagger, M_4] \\ &= -\frac{3\lambda^2}{8\omega^2\theta^2} \int_0^{\frac{1}{q}} dx \int_0^{\frac{1}{q}} dy \operatorname{Tr} [M_1^\dagger M_2](x, y) \operatorname{Tr} [M_3^\dagger M_4](x, y) \ln \frac{1}{\epsilon}, \end{aligned}$$

and when  $\theta \in \mathbb{R} \setminus \mathbb{Q}$  plus satisfying the weak Diophantine condition (4.22), it is given by

$$\Gamma_{4,non-planar,div}^{(1)}[\overline{\varphi}_1, \varphi_2, \overline{\varphi}_3, \varphi_4] = -\frac{3\lambda^2}{8\omega^2\theta^2} \operatorname{Tr}_{\mathcal{A}_\theta} [(\varphi_1, \varphi_2)_{\mathcal{A}_\theta}] \operatorname{Tr}_{\mathcal{A}_\theta} [(\varphi_3, \varphi_4)_{\mathcal{A}_\theta}] \ln \frac{1}{\epsilon}.$$

In the irrational case, this analysis leads to the introduction of a non-local term in the action (2.33), associated to the new divergence and with a second coupling constant:

$$\begin{aligned} S[\phi, \overline{\phi}] = g^{\mu\nu} \operatorname{Tr}_{\mathcal{A}_\theta} [(\nabla_\mu \phi, \nabla_\nu \phi)_{\mathcal{A}_\theta}] + \mu_0^2 \operatorname{Tr}_{\mathcal{A}_\theta} [(\phi, \phi)_{\mathcal{A}_\theta}] + \frac{\lambda}{2} \operatorname{Tr}_{\mathcal{A}_\theta} [(\phi, \phi)_{\mathcal{A}_\theta}^2] \\ + \frac{\lambda'}{2} \left[ \operatorname{Tr}_{\mathcal{A}_\theta} [(\phi, \phi)_{\mathcal{A}_\theta}] \right]^2. \end{aligned} \quad (4.38)$$

Such a term also appeared in [1].

To show that our theory is now reasonably well defined, we have to show that the divergences coming from loop diagrams constructed with the new vertex (and also with mixed vertices) can be absorbed by a redefinition of  $\mu_0$ ,  $\lambda$ ,  $\lambda'$ . This is shown to hold in the one-loop approximation in the next section.

## 5 Mixed diagrams

We symbolize the new vertex by a dotted line:

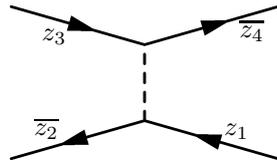

$$= \frac{\lambda'}{2} I(z_1, z_2) I(z_3, z_4). \quad (5.1)$$

This interaction  $(\operatorname{Tr}_{\mathcal{A}_\theta} [(\phi, \phi)_{\mathcal{A}_\theta}])^2$  can also be written using the Hubbard-Stratonovitch transform as

$$e^{-\frac{\lambda'}{2} (\operatorname{Tr}_{\mathcal{A}_\theta} [(\phi, \phi)_{\mathcal{A}_\theta}])^2} = \sqrt{\frac{\lambda'}{2\pi}} \int_{\mathbb{R}} da e^{-\frac{\lambda'}{2} a^2 - i\lambda' a \operatorname{Tr}_{\mathcal{A}_\theta} [(\phi, \phi)_{\mathcal{A}_\theta}]}, \quad (5.2)$$

where we integrate over a real number  $a$ . Equivalently, it can also be obtained by introducing a different coupling for the constant mode of the field  $A$  appearing in the Hubbard-Stratonovitch transform.

## 5.1 2-point sector

The first 2-point graph with the new vertex is thus

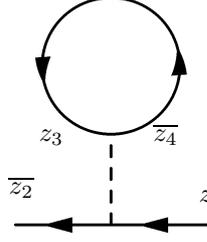

$$\Gamma_{2c}^{(1)}[z_1, \bar{z}_2] = \frac{\lambda'}{2} I(z_1, \bar{z}_2) \int_{\varepsilon}^{\infty} d\beta \frac{e^{-\frac{\beta \mu_0^2}{2}}}{(1 - e^{-\beta \omega})^2}. \quad (5.3)$$

Its value is obtained from (4.5) by putting  $\gamma \mapsto 0$  and  $\lambda \mapsto \lambda'$ . This coincides exactly with the previous divergence.

The second contribution to the one-loop two-point function is the graph

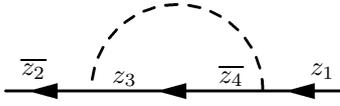

$$\Gamma_{2d}^{(1)}[z_1, \bar{z}_2] = \frac{\lambda'}{2} I(z_1, \bar{z}_2) \int_{\varepsilon}^{\infty} d\beta e^{-\frac{\beta \mu_0^2}{2}} e^{-\omega \bar{z}_2 (1 - e^{-\beta \omega}) z_1}. \quad (5.4)$$

Again, this is immediately obtained from (4.10). After insertion of external fields, the integral is obviously finite.

## 5.2 4-point sector: planar graphs

To each of the previous graphs there correspond three different new graphs. The mixed analogue of (4.13) is

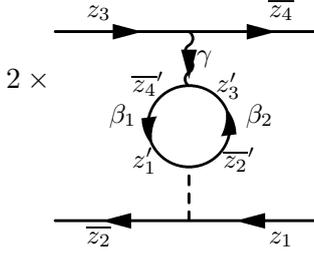

$$2 \times \Gamma_{4e}^{(1)}[z_1, \bar{z}_2, z_3, \bar{z}_4] = -\frac{\lambda \lambda'}{4} \sum_{\gamma} I(z_1, \bar{z}_2) I(z_3, \bar{z}_4) \int_{\varepsilon}^{\infty} \frac{d\beta_1 d\beta_2 e^{-\frac{\mu_0^2}{2}(\beta_1 + \beta_2)}}{(1 - e^{-(\beta_1 + \beta_2)\omega})^2} \times e^{-\omega(\bar{z}_4 \gamma - \bar{\gamma} z_3 + \frac{|\gamma|^2}{1 - e^{-(\beta_1 + \beta_2)\omega}})}. \quad (5.5)$$

The graph where the new vertex is above has the same value so that we count this graphs twice. Its value is obtained from (4.14) by setting  $\gamma_1 = 0$  and  $\gamma_2 = \gamma$ . Obviously, only the mode  $\gamma = 0$  produces a divergence:

$$\Gamma_{4e, div}^{(1)}[z_1, \bar{z}_2, z_3, \bar{z}_4] = -\frac{\lambda \lambda'}{4} I(z_1, \bar{z}_2) I(z_3, \bar{z}_4) \int_{\varepsilon}^{\infty} \frac{d\beta_1 d\beta_2 e^{-\frac{\mu_0^2}{2}(\beta_1 + \beta_2)}}{(1 - e^{-(\beta_1 + \beta_2)\omega})^2}. \quad (5.6)$$

There is also the analogue of (4.13) where both vertices are new ones:

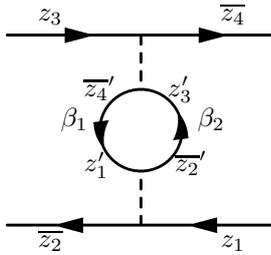

$$\Gamma_{4f}^{(1)}[z_1, \bar{z}_2, z_3, \bar{z}_4] = -\frac{\lambda'^2}{8} I(z_1, z_2) I(z_3, z_4) \int_{\varepsilon}^{\infty} \frac{d\beta_1 d\beta_2 e^{-\frac{\mu_0^2}{2}(\beta_1 + \beta_2)}}{(1 - e^{-(\beta_1 + \beta_2)\omega})^2}. \quad (5.7)$$

This gives directly the divergent part.

All mixed analogues of the graph (4.17) are finite, because there is no loop summation:

$$\begin{aligned}
& 2 \times \begin{array}{c} \xrightarrow{z_3} \xrightarrow{\overline{z'_4}} \xrightarrow{z'_3} \xrightarrow{\overline{z_4}} \\ \beta_2 \\ \xleftarrow{\overline{z_2}} \xleftarrow{z'_1} \xleftarrow{\overline{z'_2}} \xleftarrow{z_1} \\ \beta_1 \end{array} \Gamma_{4g}^{(1)}[z_1, \overline{z_2}, z_3, \overline{z_4}] \\
& = -\frac{\lambda\lambda'}{4} \sum_{\gamma} \int_{\varepsilon}^{\infty} d\beta_1 d\beta_2 e^{-\frac{\mu_0^2}{2}(\beta_1+\beta_2)} e^{\omega(-|\gamma_1|^2 - \overline{\gamma}z_1 - \overline{z_4}\gamma)} \\
& \quad \times e^{\omega(\overline{z_2}e^{-\beta_1\omega}\gamma + \overline{z_2}e^{-\beta_1\omega}z_1 + \overline{z_4}e^{-\beta_2\omega}z_3 + \overline{\gamma}e^{-\beta_2\omega}z_3)}. \quad (5.8)
\end{aligned}$$

$$\begin{aligned}
& \begin{array}{c} \xrightarrow{z_3} \xrightarrow{\overline{z'_4}} \xrightarrow{z'_3} \xrightarrow{\overline{z_4}} \\ \beta_2 \\ \xleftarrow{\overline{z_2}} \xleftarrow{z'_1} \xleftarrow{\overline{z'_2}} \xleftarrow{z_1} \\ \beta_1 \end{array} \Gamma_{4h}^{(1)}[z_1, \overline{z_2}, z_3, \overline{z_4}] \\
& = -\frac{\lambda'^2}{8} \int_{\varepsilon}^{\infty} d\beta_1 d\beta_2 e^{-\frac{\mu_0^2}{2}(\beta_1+\beta_2)} e^{\omega(\overline{z_2}e^{-\beta_1\omega}z_1 + \overline{z_4}e^{-\beta_2\omega}z_3)}. \quad (5.9)
\end{aligned}$$

### 5.3 4-point sector: non-planar graphs

The analogues of the first non-planar graph (4.23) have one possibility where a loop summation remains. Writing directly the result of the Poisson re-summation, we have

$$\begin{aligned}
& \begin{array}{c} \xrightarrow{z_3} \xrightarrow{\overline{z'_4}} \xrightarrow{z'_1} \xrightarrow{\overline{z'_2}} \xrightarrow{z'_3} \xrightarrow{\overline{z_4}} \\ \beta_2 \\ \xleftarrow{\overline{z_2}} \xleftarrow{z_1} \\ \beta_1 \end{array} \Gamma_{4i}^{(1)}[z_1, \overline{z_2}, z_3, \overline{z_4}] \\
& = -\frac{\lambda\lambda'}{4\theta^2} \sum_{\gamma_2^*} e^{\omega(\overline{z_2}z_1 + \overline{z_4}z_3 + i\overline{\gamma_2^*}z_3 + \overline{z_4}i\gamma_2^*)} \\
& \quad \times \int_{\varepsilon}^{\infty} d\beta_1 d\beta_2 \frac{e^{-\frac{\mu_0^2}{2}(\beta_1+\beta_2)}}{(1 - e^{-(\beta_1+\beta_2)\omega})^2} e^{-\frac{\omega}{1 - e^{-(\beta_1+\beta_2)\omega}}|\gamma_2^*|^2}. \quad (5.10)
\end{aligned}$$

Only the mode  $\gamma_2^* = 0$  contributes to the divergence:

$$\Gamma_{4i,div}^{(1)}[z_1, \overline{z_2}, z_3, \overline{z_4}] = -\frac{\lambda\lambda'}{4\theta^2} I(z_1, \overline{z_2}) I(z_3, \overline{z_4}) \int_{\varepsilon}^{\infty} d\beta_1 d\beta_2 \frac{e^{-\frac{\mu_0^2}{2}(\beta_1+\beta_2)}}{(1 - e^{-(\beta_1+\beta_2)\omega})^2}. \quad (5.11)$$

The other analogues of (4.23) are finite:

$$\begin{aligned}
& \begin{array}{c} \xrightarrow{z_3} \xrightarrow{\overline{z'_4}} \xrightarrow{z'_1} \xrightarrow{\overline{z'_2}} \xrightarrow{z'_3} \xrightarrow{\overline{z_4}} \\ \beta_2 \\ \xleftarrow{\overline{z_2}} \xleftarrow{z_1} \\ \beta_1 \end{array} \Gamma_{4j}^{(1)}[z_1, \overline{z_2}, z_3, \overline{z_4}] \\
& = -\frac{\lambda\lambda'}{4} \sum_{\gamma_1} \int_{\varepsilon}^{\infty} d\beta_1 d\beta_2 e^{-\frac{\mu_0^2}{2}(\beta_1+\beta_2)} e^{\omega(-|\gamma_1|^2 + \overline{z_2}\gamma_1 + \overline{z_2}z_1 - \overline{\gamma_1}z_1)} \\
& \quad \times e^{\omega(-\overline{z_4}e^{-\beta_1\omega}\gamma_1 + \overline{z_4}e^{-(\beta_1+\beta_2)\omega}z_3 + \overline{\gamma_1}e^{-\beta_2\omega}z_3)}. \quad (5.12)
\end{aligned}$$

$$\begin{aligned}
& \begin{array}{c} \xrightarrow{z_3} \xrightarrow{\overline{z'_4}} \xrightarrow{z'_1} \xrightarrow{\overline{z'_2}} \xrightarrow{z'_3} \xrightarrow{\overline{z_4}} \\ \beta_2 \\ \xleftarrow{\overline{z_2}} \xleftarrow{z_1} \\ \beta_1 \end{array} \Gamma_{4k}^{(1)}[z_1, \overline{z_2}, z_3, \overline{z_4}] \\
& = -\frac{\lambda'^2}{4} \int_{\varepsilon}^{\infty} d\beta_1 d\beta_2 e^{-\frac{\mu_0^2}{2}(\beta_1+\beta_2)} e^{\omega(\overline{z_2}z_1 + \overline{z_4}e^{-(\beta_1+\beta_2)\omega}z_3)}. \quad (5.13)
\end{aligned}$$

All analogues of the second non-planar graph (4.33) are finite:

$$\begin{aligned}
2 \times & \begin{array}{c} \xrightarrow{z_3} \xrightarrow{\bar{z}'_4} \xrightarrow{z'_3} \xrightarrow{\bar{z}_4} \\ \xleftarrow{\bar{z}_2} \xleftarrow{z'_1} \xleftarrow{\bar{z}'_2} \xleftarrow{z_1} \end{array} \Gamma_{4l}^{(1)}[z_1, \bar{z}_2, z_3, \bar{z}_4] \\
& = -\frac{\lambda\lambda'}{4} \sum_{\gamma_2} \int_{\epsilon}^{\infty} d\beta_1 d\beta_2 e^{-\frac{\mu_0^2}{2}(\beta_1+\beta_2)} e^{-\omega|\gamma_2|^2} \\
& \times e^{\omega(\bar{z}_2\gamma_2+(\bar{z}_2-\bar{\gamma}_2)e^{-\beta_1\omega}z_1-\bar{z}_4\gamma_2+(\bar{z}_4+\bar{\gamma}_2)e^{-\beta_2\omega}z_3)}. \quad (5.14)
\end{aligned}$$

$$\begin{aligned}
& \begin{array}{c} \xrightarrow{z_3} \xrightarrow{\bar{z}'_4} \xrightarrow{z'_3} \xrightarrow{\bar{z}_4} \\ \xleftarrow{\bar{z}_2} \xleftarrow{z'_1} \xleftarrow{\bar{z}'_2} \xleftarrow{z_1} \end{array} \Gamma_{4m}^{(1)}[z_1, \bar{z}_2, z_3, \bar{z}_4] \\
& = -\frac{\lambda'^2}{8} \int_{\epsilon}^{\infty} d\beta_1 d\beta_2 e^{-\frac{\mu_0^2}{2}(\beta_1+\beta_2)} e^{\omega(\bar{z}_2 e^{-\beta_1\omega}z_1 + \bar{z}_4 e^{-\beta_2\omega}z_3)}. \quad (5.15)
\end{aligned}$$

In conclusion, the new divergences reproduce the action functional (4.38) (which includes the new vertex) so that the model is one-loop renormalizable.

## 6 $\beta$ -functions

Here we compute the  $\beta$ -functions of our model in the most interesting case where  $\theta$  is irrational and satisfies the Diophantine condition (4.22). We can summarize the divergent Green's functions to

$$\Gamma_2^{(1)}[z_1, \bar{z}_2] = \frac{1}{2\omega} \left( \lambda \left( 1 + \frac{1}{\theta^2} \right) + \lambda' \right) I(z_1, \bar{z}_2) \left( \frac{1}{\epsilon\omega} + \left( 1 - \frac{\mu_0^2}{2\omega} \right) \ln \frac{1}{\epsilon} \right), \quad (6.1)$$

$$\Gamma_4^{(1)}[z_1, \bar{z}_2, z_3, \bar{z}_4] = -\frac{\lambda}{4\omega^2} \left( 1 + \frac{1}{\theta^2} \right) V(z_1, \bar{z}_2, z_3, \bar{z}_4) \ln \frac{1}{\epsilon} \quad (6.2)$$

$$- \frac{1}{8\omega^2} \left( \lambda'^2 + \frac{3\lambda^2}{\theta^2} + 2\lambda\lambda' \left( 1 + \frac{1}{\theta^2} \right) \right) I(z_1, \bar{z}_2) I(z_3, \bar{z}_4) \ln \frac{1}{\epsilon}. \quad (6.3)$$

This leads to the following relation between the renormalized quantities  $\mu_R, \lambda_R, \lambda'_R$  and the bare quantities  $\mu_0, \lambda, \lambda'$ :

$$\mu_R = \mu_0 + \frac{1}{2\omega} \left( \lambda \left( 1 + \frac{1}{\theta^2} \right) + \lambda' \right) \left( \frac{1}{\epsilon\omega} + \left( 1 - \frac{\mu_0^2}{2\omega} \right) \ln \frac{1}{\epsilon} \right), \quad (6.4)$$

$$\lambda_R = \lambda - \frac{\lambda^2}{4\omega^2} \left( 1 + \frac{1}{\theta^2} \right) \ln \frac{1}{\epsilon}, \quad (6.5)$$

$$\lambda'_R = \lambda' - \frac{1}{4\omega^2} \left( \lambda'^2 + \frac{3\lambda^2}{\theta^2} + 2\lambda\lambda' \left( 1 + \frac{1}{\theta^2} \right) \right) \ln \frac{1}{\epsilon}. \quad (6.6)$$

Solving for the bare quantities, we obtain

$$\mu_0 = \mu_R - \frac{1}{2\omega} \left( \lambda_R \left( 1 + \frac{1}{\theta^2} \right) + \lambda'_R \right) \left( \frac{1}{\epsilon\omega} + \left( 1 - \frac{\mu_0^2}{2\omega} \right) \ln \frac{1}{\epsilon} \right), \quad (6.7)$$

$$\lambda = \lambda_R + \frac{\lambda_R^2}{4\omega^2} \left( 1 + \frac{1}{\theta^2} \right) \ln \frac{1}{\epsilon}, \quad (6.8)$$

$$\lambda' = \lambda'_R + \frac{1}{4\omega^2} \left( \lambda_R'^2 + \frac{3\lambda_R^2}{\theta^2} + 2\lambda_R\lambda'_R \left( 1 + \frac{1}{\theta^2} \right) \right) \ln \frac{1}{\epsilon}. \quad (6.9)$$

The  $\beta$ -functions are therefore given by

$$\beta = \frac{\lambda_R^2}{4\omega^2} \left( 1 + \frac{1}{\theta^2} \right), \quad \beta' = \frac{1}{4\omega^2} \left( \lambda_R'^2 + \frac{3\lambda_R^2}{\theta^2} + 2\lambda_R\lambda'_R \left( 1 + \frac{1}{\theta^2} \right) \right). \quad (6.10)$$

We thus conclude that the model is neither asymptotically free nor has a finite fixed point as it was the case for the renormalizable  $\phi_4^4$ -model on the Moyal plane [19]. The result also shows that there does not exist a ( $\theta$ -independent) relation between the coupling constants  $\lambda', \lambda'$  which is preserved over all scales.

## Conclusion

In the general formalism of noncommutative geometry, we have proposed a definition of a field theory on a projective module which is the noncommutative analogue of a scalar field theory with non-trivial topology. In the case of a noncommutative torus, the simplest non-trivial projective modules can be constructed using representations of the Heisenberg commutation relations. We have given a detailed account of the corresponding field theory, whose properties are reminiscent of those of a rectangular matrix model, whereas algebra-valued fields correspond to square matrices.

In particular, we have shown that the model suffers from an UV/IR-mixing. Contrarily to what happens for field theories on the Moyal plane, here the arithmetical nature of the deformation parameters plays a central role. For  $\theta$  satisfying a Diophantine condition, the theory is one-loop renormalizable at the price of introducing the extra counterterm

$$\left[ \text{Tr}_{\mathcal{A}_\theta} (\phi, \phi)_{\mathcal{A}_\theta} \right]^2 \quad (6.11)$$

in the action, whereas the basic action we started with is

$$\text{Tr}_{\mathcal{A}_\theta} \left[ (\phi, \phi)_{\mathcal{A}_\theta}^2 \right]. \quad (6.12)$$

In a commutative field theory, such a counterterm would break the locality of the action but in a matrix model it corresponds to  $[\text{Tr}(M^\dagger M)]^2$  and is perfectly acceptable. This is the only way we found to cure the UV/IR-mixing problem. Note that the adjunction of such a counterterm fits perfectly with the spirit of [18]. The only difference is that they need to modify the propagator, whereas we need to change the interaction.

The occurrence of the Diophantine condition is not so surprising here. In fact, after suitable Poisson re-summations, divergences in the  $\beta$  integrals appear whenever the lattice  $\Gamma$  and its dual  $\widehat{\Gamma}$  have elements that are close enough. In the rational case, the two lattices have non-trivial intersections that lead to sharp divergences corresponding to the usual counterterms but otherwise the distance is bounded by a fixed number. In the irrational case,  $\Gamma \cap \widehat{\Gamma} = \{0\}$  but the two lattices have elements that are as close as possible. The Diophantine condition allows to set a lower bound for the distance between  $\Gamma$  and  $\widehat{\Gamma}$  when restricted to a ball of radius  $R$  as a function of  $R$ .

## Acknowledgments

RW thanks the Université de Provence. J.-H. J. gratefully acknowledges his fellowship of the Friedrich-Ebert-Stiftung and wants to thank Prof. G. Grensing for helpful discussions.

## A Comments on the duality covariant model

In the duality covariant  $\phi_4^4$ -theory on the Moyal plane (3.55), the planar one-loop two-point graph reads:

$$\begin{aligned}
\Gamma_{1,P}^{(1)}(x_1, x_2) &= \int dx_3 dx_4 V_*(x_1, x_2, x_3, x_4) H_\epsilon^{-1}(x_3, x_4) \\
&= \frac{\lambda\Omega}{4!4\pi^6\theta^5} \int dx_3 dx_4 \delta(x_1 - x_2 + x_3 - x_4) e^{-2i\theta^{-1}(x_1, x_2)} e^{-2i\theta^{-1}(x_3, x_4)} \\
&\quad \times \int_\epsilon^\infty d\beta \frac{e^{-\theta\mu_0^2\beta/4\Omega}}{\sinh^2(\beta)} e^{-\frac{\Omega}{2\theta}(\coth(\beta/2)|x_3-x_4|^2 + \tanh(\beta/2)|x_3+x_4|^2)} \\
&= \frac{\lambda\Omega}{4!4\pi^6\theta^5} e^{-2i\theta^{-1}(x_1, x_2)} \int_\epsilon^\infty d\beta \frac{e^{-\theta\mu_0^2\beta/4\Omega}}{\sinh^2(\beta)} \int dx_3 e^{-2i\theta^{-1}(x_3, x_1-x_2)} \\
&\quad \times e^{-\frac{\Omega}{2\theta}(\coth(\beta/2)|x_1-x_2|^2 + 4\tanh(\beta/2)|x_3|^2)} \\
&= \frac{\lambda}{4!4^2\pi^4\theta^3\Omega} e^{-2i\theta^{-1}(x_1, x_2)} \int_\epsilon^\infty d\beta \frac{e^{-\theta\mu_0^2\beta/4\Omega}}{\sinh^2(\beta) \tanh^2(\beta/2)} e^{-\frac{1+\Omega^2}{2\theta\Omega} \coth(\beta/2)|x_1-x_2|^2}. \tag{A.1}
\end{aligned}$$

To obtain the third equality we used the translation  $x_3 \rightarrow x_3 + \frac{1}{2}(x_1 - x_2)$ , which leaves unchanged the phase factor due to the skew-symmetry of  $S$ .

This amplitude is divergent in the coinciding-points limit, i.e. it is UV-divergent. We now extract local divergences from the previous expression. They will correspond to the mass, wave-function and oscillator frequency renormalization. In the same manner that momentum space renormalization corresponds to subtract Feynman amplitude with zero external momenta, configuration space renormalization is done by attaching all the external legs at the same point. To be able to apply this guiding principle, we have to go to the quantum effective action level, that is to smear the regularized Green functions with external or background fields, and to expand them on a neighborhood of a given point via a Taylor expansion with integral remainder.

$$\begin{aligned}
\Gamma_{1,P}^{(1)}[\varphi_1, \varphi_2] &:= \int dx dy \Gamma_{1,P}^{(1)}(x, y) \varphi_1(x) \varphi_2(y) \\
&= \frac{\lambda}{4!4^2\pi^4\theta^3\Omega} \int dx dy \varphi_1(x) \varphi_2(x+y) e^{-2i\theta^{-1}(x, y)} \\
&\quad \times \int_\epsilon^\infty d\beta \frac{e^{-\theta\mu_0^2\beta/4\Omega}}{\sinh^2(\beta) \tanh^2(\beta/2)} e^{-\frac{1+\Omega^2}{2\theta\Omega} \coth(\beta/2)|y|^2} \\
&= \frac{\lambda}{4!4^2\pi^4\theta^3\Omega} \int dx dy \varphi_1(x) \left( \varphi_2(x) + y^\mu \partial_\mu \varphi_2(x) + \frac{1}{2} y^\mu y^\nu \partial_\mu \partial_\nu \varphi_2(x) \right. \\
&\quad \left. + \frac{1}{2} y^\mu y^\nu y^\rho \int_0^1 d\xi (1-\xi)^2 (\partial_\mu \partial_\nu \partial_\rho \varphi)(x + \xi y) \right) e^{-2i\theta^{-1}(x, y)} \\
&\quad \times \int_\epsilon^\infty d\beta \frac{e^{-\theta\mu_0^2\beta/4\Omega}}{\sinh^2(\beta) \tanh^2(\beta/2)} e^{-\frac{1+\Omega^2}{2\theta\Omega} \coth(\beta/2)|y|^2}, \tag{A.2}
\end{aligned}$$

Let us label by  $X_i$ ,  $i = 1, \dots, 4$  the four different terms coming from the Taylor expansion. The first summand reads:

$$\begin{aligned}
X_1 &= \frac{\lambda}{4!4^2\pi^4\theta^3\Omega} \int dx dy \varphi_1(x) \varphi_2(x) e^{-2i\theta^{-1}(x, y)} \int_\epsilon^\infty d\beta \frac{e^{-\theta\mu_0^2\beta/4\Omega}}{\sinh^2(\beta) \tanh^2(\beta/2)} e^{-\frac{1+\Omega^2}{2\theta\Omega} \coth(\beta/2)|y|^2} \\
&= \frac{\lambda\Omega}{96\pi^2\theta(1+\Omega^2)^2} \int dx \varphi_1(x) \varphi_2(x) \int_\epsilon^\infty d\beta \frac{e^{-\theta\mu_0^2\beta/4\Omega}}{\sinh^2(\beta)} e^{-\frac{2\Omega}{\theta(1+\Omega^2)} \tanh(\beta/2)|x|^2} \\
&= \frac{\lambda\Omega}{96\pi^2\theta(1+\Omega^2)^2} \int dx \varphi_1(x) \varphi_2(x) \int_\epsilon^\infty d\beta \frac{e^{-\theta\mu_0^2\beta/4\Omega}}{\sinh^2(\beta)} \\
&\quad - \frac{\lambda\Omega^2}{96\pi^2\theta^2(1+\Omega^2)^3} \int dx \varphi_1(x) |x|^2 \varphi_2(x) \int_\epsilon^\infty d\beta \frac{e^{-\theta\mu_0^2\beta/4\Omega}}{\sinh(\beta) \cosh^2(\beta/2)} + O(\epsilon^0). \tag{A.3}
\end{aligned}$$

For the second summand, we obtain using integration by parts:

$$\begin{aligned}
X_2 &= \frac{\lambda}{4!4^2\pi^4\theta^3\Omega} \int dx dy \varphi_1(x) y^\mu \partial_\mu \varphi_2(x) e^{-2i\theta^{-1}(x,y)} \\
&\quad \times \int_\varepsilon^\infty d\beta \frac{e^{-\theta\mu_0^2\beta/4\Omega}}{\sinh^2(\beta) \tanh^2(\beta/2)} e^{-\frac{1+\Omega^2}{2\theta\Omega} \coth(\beta/2)|y|^2} \\
&= \frac{\lambda}{4!4^2\pi^4\theta^3\Omega} \int dx dy \varphi_1(x) \frac{i}{2} \theta^{\mu\nu} \partial_\mu \partial_\nu \varphi_2(x) e^{-2i\theta^{-1}(x,y)} \\
&\quad \times \int_\varepsilon^\infty d\beta \frac{e^{-\theta\mu_0^2\beta/4\Omega}}{\sinh^2(\beta) \tanh^2(\beta/2)} e^{-\frac{1+\Omega^2}{2\theta\Omega} \coth(\beta/2)|y|^2} \\
&= 0.
\end{aligned} \tag{A.4}$$

Thus,  $X_2$  identically vanishes due to the skew-symmetry of the deformation matrix. For the third one, we get:

$$\begin{aligned}
X_3 &= \frac{\lambda}{4!4^2\pi^4\theta^3\Omega} \int dx dy \varphi_1(x) \frac{1}{2} y^\mu y^\nu \partial_\mu \partial_\nu \varphi_2(x) e^{-2i\theta^{-1}(x,y)} \\
&\quad \times \int_\varepsilon^\infty d\beta \frac{e^{-\theta\mu_0^2\beta/4\Omega}}{\sinh^2(\beta) \tanh^2(\beta/2)} e^{-\frac{1+\Omega^2}{2\theta\Omega} \coth(\beta/2)|y|^2} \\
&= -\frac{\lambda\Omega}{4!4^2\pi^2\theta(1+\Omega^2)^2} \frac{1}{8} \theta^{\mu_1\nu_1} \theta^{\mu_2\nu_2} \int dx \varphi_1(x) \partial_{\mu_1} \partial_{\mu_2} \varphi_2(x) \int_\varepsilon^\infty d\beta \frac{e^{-\theta\mu_0^2\beta/4\Omega}}{\sinh^2(\beta)} \\
&\quad \times \left( -\frac{4\Omega}{\theta(1+\Omega^2)} \tanh(\beta/2) \delta_{\nu_1\nu_2} + \frac{16\Omega^2}{\theta^2(1+\Omega^2)^2} \tanh^2(\beta/2) x_{\nu_1} x_{\nu_2} \right) e^{-\frac{2\Omega}{\theta(1+\Omega^2)} \tanh(\beta/2)|x|^2} \\
&= -\frac{\lambda\Omega^2}{384\pi^2(1+\Omega^2)^3} \int dx \varphi_1(x) \Delta \varphi_2(x) \int_\varepsilon^\infty d\beta \frac{e^{-\theta\mu_0^2\beta/4\Omega}}{\sinh(\beta) \cosh^2(\beta/2)} + O(\varepsilon^0).
\end{aligned} \tag{A.5}$$

Let us show that  $X_4$ , the integral remainder of the Taylor expansion, gives a finite contribution. Indeed, we have

$$\begin{aligned}
X_4 &= \frac{\lambda}{4!4^2\pi^4\theta^3\Omega} \int dx dy \varphi_1(x) \frac{1}{2} y^\mu y^\nu y^\rho \int_0^1 d\xi (1-\xi)^2 (\partial_\mu \partial_\nu \partial_\rho \varphi_2(x + \xi y) e^{-2i\theta^{-1}(x,y)} \\
&\quad \times \int_\varepsilon^\infty d\beta \frac{e^{-\theta\mu_0^2\beta/4\Omega}}{\sinh^2(\beta) \tanh^2(\beta/2)} e^{-\frac{1+\Omega^2}{2\theta\Omega} \coth(\beta/2)|y|^2},
\end{aligned} \tag{A.6}$$

thus,

$$\begin{aligned}
|X_4| &\leq C \|\partial_\mu \partial_\nu \partial_\rho \varphi_2\|_\infty \|\varphi_1\|_1 \int_0^1 d\xi (1-\xi)^2 \int dy |y^\mu y^\nu y^\rho| \\
&\quad \times \int_\varepsilon^\infty d\beta \frac{e^{-\theta\mu_0^2\beta/4\Omega}}{\sinh^2(\beta) \tanh^2(\beta/2)} e^{-\frac{1+\Omega^2}{2\theta\Omega} \coth(\beta/2)|y|^2} \\
&= C' \|\partial_\mu \partial_\nu \partial_\rho \varphi\|_\infty \|\varphi\|_1 \int dy |y^\mu y^\nu y^\rho| e^{-\frac{1+\Omega^2}{2\theta\Omega} |y|^2} \int_\varepsilon^\infty d\beta e^{-\theta\mu_0^2\beta/4\Omega} \frac{\tanh^{3/2}(\beta/2)}{\sinh^2(\beta)},
\end{aligned}$$

which is finite in the limit  $\varepsilon \rightarrow 0$  since  $\varphi$  is a Schwartz function and since  $\tanh^{3/2}(\beta/2) \sinh^{-2}(\beta)$  is integrable in  $\beta = 0$ .

Putting all together, we finally obtain:

$$\begin{aligned} \Gamma_{1,P}^{(1)}[\varphi_1, \varphi_2] = & \frac{\lambda\Omega}{96\pi^2\theta(1+\Omega^2)^2} \int dx \varphi_1(x) \varphi_2(x) \int_{\varepsilon}^{\infty} d\beta \frac{e^{-\theta\mu_0^2\beta/4\Omega}}{\sinh^2(\beta)} \\ & - \frac{\lambda\Omega^2}{384\pi^2(1+\Omega^2)^3} \int dx \varphi_1(x) \left(\Delta + \frac{X^2}{\Omega^2}\right) \varphi_2(x) \int_{\varepsilon}^{\infty} d\beta \frac{e^{-\theta\mu_0^2\beta/4\Omega}}{\sinh(\beta) \cosh^2(\beta/2)} \\ & + O(\varepsilon^0). \end{aligned}$$

The last two lines are the relevant contribution to the mass renormalization and marginal contribution to the wave-function and to the oscillator frequency renormalization.

## References

- [1] C. Becchi, S. Giusto and C. Imbimbo, “The Wilson-Polchinski renormalization group equation in the planar limit,” Nucl. Phys. B **633** (2002) 250 [arXiv:hep-th/0202155].
- [2] J. Bellissard, “C\* Algebras in solid state physics: 2-D electrons in a uniform magnetic field,” Operator algebras and applications, Vol. 2, 49–76, London Math. Soc. Lecture Note Ser., 136, Cambridge Univ. Press, Cambridge, (1988).
- [3] J. Bellissard, “Noncommutative Geometry of Aperiodic Solids,” in: *Geometric and Topological Methods for Quantum Field Theory*, (Villa de Leyva, 2001), 86–156, World Sci. Publishing, River Edge, NJ (2003), available at <http://www.math.gatech.edu/~jeanbel/publijb.html>.
- [4] A. H. Chamseddine and A. Connes, “Scale invariance in the spectral action,” J. Math. Phys. **47** (2006) 063504 [arXiv:hep-th/0512169].
- [5] A. H. Chamseddine, A. Connes and M. Marcolli, “Gravity and the standard model with neutrino mixing,” [arXiv:hep-th/0610241].
- [6] I. Chepelev and R. Roiban, “Convergence theorem for non-commutative Feynman graphs and renormalization,” JHEP **0103** (2001) 001 [arXiv:hep-th/0008090].
- [7] G. M. Cicuta, L. Molinari, E. Montaldi and F. Riva, “Large rectangular matrices,” J. Math. Phys. **28** (1987) 1716.
- [8] A. Connes, *Noncommutative geometry*, Academic Press Inc., San Diego, (1994), available at <http://www.alainconnes.org/downloads.html>.
- [9] A. Connes, “Noncommutative differential geometry,” Publications mathématiques de l’IHES **62** (1985), available at <http://www.alainconnes.org/downloads.html>.
- [10] A. Connes, “C\* algebras and differential geometry,” Translated from original French journal article Compt. Rend. Math. **A290** (1980) 599 [arXiv:hep-th/0101093].
- [11] A. Connes, M. R. Douglas and A. S. Schwarz, “Noncommutative geometry and matrix theory: Compactification on tori,” JHEP **9802** (1998) 003 [arXiv:hep-th/9711162].
- [12] A. Connes and M. Marcolli, “A walk in the noncommutative garden,” (2006) available at <http://www.alainconnes.org/downloads.html>.
- [13] A. Connes and M. A. Rieffel, “Yang-Mills for noncommutative two-tori,” Contemp. Math. **62** (1987) 237.

- [14] L. Dąbrowski, G. Landi, A. Sitarz, W. van Suijlekom and J. Várilly, “The Dirac operator on  $SU_q(2)$ ,” *Commun. Math. Phys.* **259** (2005) 729 [arXiv:math.qa/0501287].
- [15] T. Filk, “Divergencies in a field theory on quantum space,” *Phys. Lett.* **B376** (1996) 53.
- [16] V. Gayral, “Heat-kernel approach to UV/IR mixing on isospectral deformation manifolds,” *Ann. Henri Poincaré* **6** (2005) 991 [arXiv:hep-th/0412233].
- [17] V. Gayral, B. Iochum and D. V. Vassilevich, “Heat-kernel and number theory on noncommutative torus,” to appear in *Commun. Math. Phys.* [arXiv:hep-th/0607078].
- [18] H. Grosse and R. Wulkenhaar, “Renormalisation of  $\phi^4$ -theory on noncommutative  $\mathbb{R}^4$  in the matrix base,” *Commun. Math. Phys.* **256** (2005) 305 [arXiv:hep-th/0401128].
- [19] H. Grosse and R. Wulkenhaar, “Renormalisation of  $\phi^4$ -theory on noncommutative  $\mathbb{R}^4$  to all orders,” *Lett. Math. Phys.* **71** (2005) 13 [arXiv:hep-th/0403232].
- [20] R. Gurau, J. Magnen, V. Rivasseau and F. Vignes-Tourneret, “Renormalization of noncommutative  $\phi^4$  field theory in  $x$ -space,” *Commun. Math. Phys.* **267** (2006) 515 [arXiv:hep-th/0512271].
- [21] A. Kirillov, *Geometric Quantization*, Encyclopedia of Mathematical Sciences **4**, V.I. Arnold and S.P. Novikov (eds.), Springer-Verlag, (2001).
- [22] T. Krajewski and R. Wulkenhaar, “Perturbative quantum gauge fields on the noncommutative torus,” *Int. J. Mod. Phys. A* **15** (2000) 1011 [arXiv:hep-th/9903187].
- [23] E. Langmann and R. Szabo, “Duality in scalar field theories on noncommutative phase spaces,” *Phys. Lett. B* **533** (2002) 168 [arXiv:hep-th/0202039].
- [24] M.A. Rieffel, “Projective modules over higher-dimensional noncommutative tori,” *Canad. Jour. Math.* **40** (1988) 257.
- [25] N. Seiberg and E. Witten, “String theory and noncommutative geometry,” *JHEP* **9909** (1999) 032 [arXiv:hep-th/9908142].
- [26] V. Rivasseau, F. Vignes-Tourneret and R. Wulkenhaar, “Renormalization of noncommutative  $\phi^4$ -theory by multi-scale analysis,” *Commun. Math. Phys.* **262** (2006) 565 [arXiv:hep-th/0501036].
- [27] E. Witten, “Noncommutative geometry and string field theory,” *Nucl. Phys. B* **268** (1986) 253.
- [28] E. Witten, “Overview of K-theory applied to strings,” *Int. J. Mod. Phys. A* **16** (2001) 693 [arXiv:hep-th/0007175].

## Part III

### CLASSIFICATION OF ALMOST-COMMUTATIVE GEOMETRIES



---

---

## CHAPTER 9

---

### INTRODUCTION:

### THE ALMOST-COMMUTATIVE STANDARD MODEL

This chapter is a very short survey of the main ideas of almost commutative geometries and their application to the standard model of particle physics. The mathematical details are worked out in the thesis of Christoph Stephan [1]. This Part is a cumulative part, with the publications attached to its end.

#### § 9.1 UNIFICATION IDEA

If theoretical physicists wished for something, it would probably be a theory that unifies gravity with the forces of the sub-atomic world, i.e. the electro-weak and the strong force. However, to reach this goal it seems like there are some non-trivial obstructions to take. After Maxwell had achieved the unification of the electro-magnetic sector, probably one of the most promising ideas to incorporate gravity with Maxwell's theory came from T. Kaluza [2] where he proposed to consider a 5-dimensional metric  $g_{\mu\nu}$  including some terms in  $A_\mu$ . The fifth dimension was assumed to be a real spacial dimension, however, it had to be compactified to a circle with very small radius. Indeed, the 5-dimensional geodesic equation lead to an equation of motion of a particle inside a gravitational field plus the Lorentz force. But even if the 5-dimensional Ricci scalar lead to an Einstein-Maxwell action, some serious problems arose and this simple idea was discarded until string theory came up with its compactified (large) extra dimensions.

In the meanwhile, theoretical physicists were bothered with the non-gravitational part of the story, developing the standard model of particle physics. Taking quantum mechanics as a basis, the standard model is formulated as a quantum field theory (QFT), perturbatively giving extraordinary precise experimental predictions. One of the main summits to take was the unification of the electro-magnetic and the weak force by introducing the  $SU(2) \times U(1)_Y$ -symmetry breaking Higgs mechanism. The strong force found its mathematical formulation in the asymptotically free  $SU(3)$ -gauge theory QCD. From the differential geometric point of view, the total gauge group  $SU(2) \times U(1)_Y \times SU(3)$  acts on the matter fields being sections in

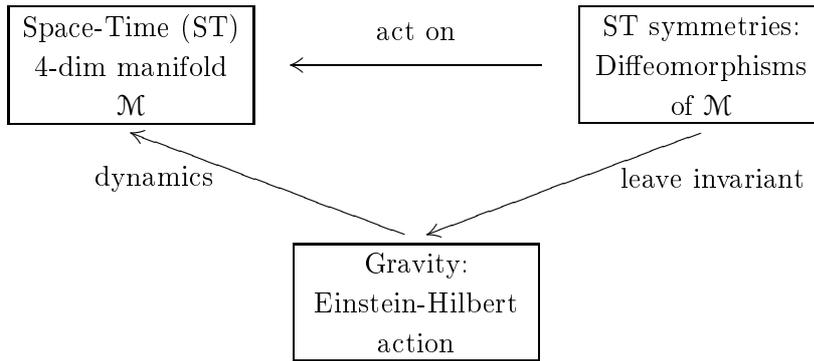

Figure 9.1: The structure of general relativity.

a vector bundle associated to the principal  $G$ -bundle over the manifold,  $G$  indicating the gauge group. Since gauge transformations are taken locally, one can thus imagine an 'internal' space which is attached to each point of the manifold, i.e reflecting the gauge degrees of freedom. Apart from the fact, that this 'gauge space' is rather abstract, it is similar to Kaluza's point of view.

The geometry of general relativity is different. Whereas Euclidean geometry describes Newton's mechanics with absolute time, special relativity unifies flat space and time within Minkowskian geometry. In GR, Riemannian geometry is the right point of view, describing a curved space-time. By the equivalence principle, gravity arises as a pseudo force from a general coordinate transformation. General coordinate transformations are diffeomorphisms of the underlying Riemannian manifold, leaving as such the Einstein-Hilbert action invariant. This circumstance is schematically depicted in figure 9.1. The symmetry acts directly on the manifold  $\mathcal{M}$ , i.e. its metric.

Would it not be nice to have such a picture for the standard model, where symmetries act 'directly' on an underlying space-time manifold producing all forces as pseudo forces by a group of 'coordinate transformations'  $SU(2) \times U(1)_Y \times SU(3)$ ? Or in other words, what could one put into the upper left corner of figure 9.2? Let us think of one step even further:

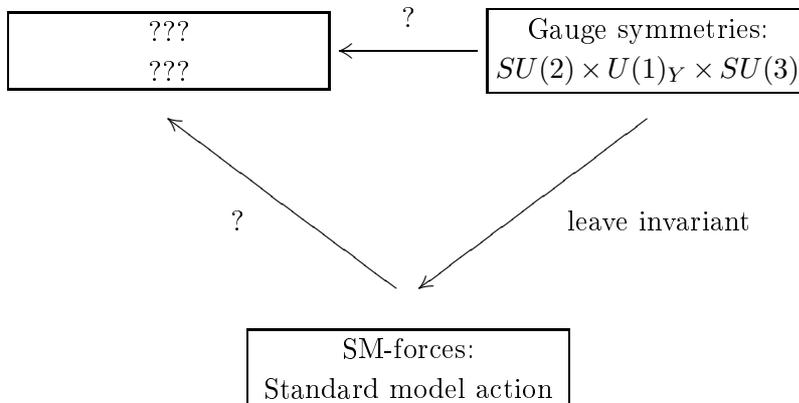

Figure 9.2: What is figure 9.1 for the standard model?

Would it not be nice to place gravity and the other forces on the same footing, namely by obtaining all forces as pseudo forces from some strange general 'coordinate transformations' acting on some general 'space-time'?

§ 9.2 SPECTRAL TRIPLES

To answer the question, this is where A. Connes' non-commutative geometry [3] comes into play. In quantum mechanics, points of the phase space lose their meaning due to Heisenberg's uncertainty,  $\Delta x \Delta p \geq \hbar/2$ . The commutative algebra of classical observables, i.e. functions on phase space, is made into a noncommutative  $C^*$ -algebra  $\mathcal{A}$  due to  $[\hat{x}_i, \hat{p}_j] = i\hbar\delta_{ij}$ , with the involution  $\cdot^*$  the Hermitian conjugation. In the relativistic setting, the wave functions are square integrable spinors living in the Hilbert space  $\mathcal{H} = \mathcal{L}^2(\mathcal{S})$ . The algebra  $\mathcal{A}$  is faithfully represented on  $\mathcal{H}$  and the dynamics is given by the Dirac operator  $\not{D} \in \text{End}(\mathcal{H})$ . It is this triple  $(\mathcal{A}, \mathcal{H}, \not{D})$  (with some additional structure) which describes Connes' geometries. A slight shortcoming is the requirement for an Euclidean setting, which means that  $\not{D}^* = \not{D}$ . One assumes that this can be cured by a Wick rotation [6], but it is still an open question how to implement a Lorentzian signature. Since a detailed description of spectral triples is far be-

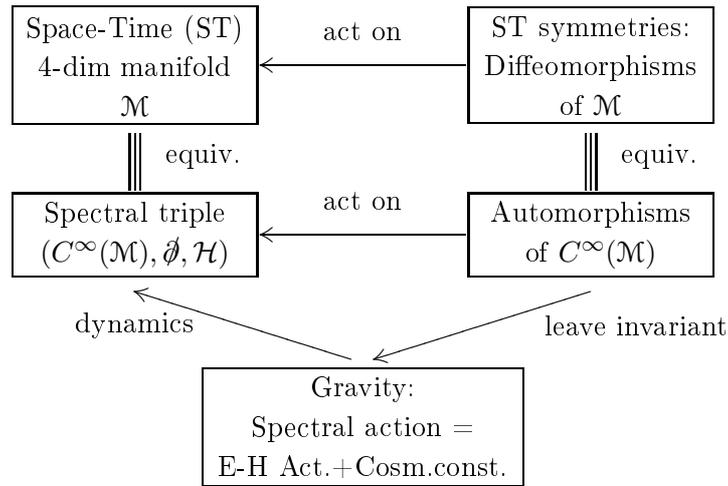

Figure 9.3: Gravity from a spectral triple.

yond the scope of the introduction, we simply accept the fact that by Connes' reconstruction theorem [4], given an even, real spectral triple  $(\mathcal{A}, \mathcal{H}, \mathcal{D}, (J), (\chi))$  with commutative  $\mathcal{A}$ , there exists a Riemannian spin manifold  $\mathcal{M}$ , whose spectral triple  $(C^\infty(\mathcal{M}), \mathcal{L}^2(\mathcal{S}), \not{D}, (C), (\gamma^5))$  coincides with the former triple. Some additional structure must be given, the real structure  $J$  and the chirality  $\chi$ , fulfilling together with  $\mathcal{D}$  and the representation of  $\mathcal{A}$  on  $\mathcal{H}$  the axioms of a spectral triple [4]. The crucial observation is that one can translate all the differential geometric structure to an algebraic analogue. Roughly said, this allows to identify a (compact) Riemannian spin manifold with a spectral triple. In the case of GR, the diffeomorphisms of

the manifold have their equivalent in the automorphisms of  $\mathcal{A}$  lifted to the spinors and the so called spectral action due to Chamseddine & Connes [5] reproduces from the eigenvalues of the fluctuated [1] Dirac operator the Einstein-Hilbert action with cosmological constant. One can see the general setting in figure 9.3.

It is now possible to relax the commutativity of the algebra  $\mathcal{A}$ . In that sense, a spectral triple  $(\mathcal{A}, \mathcal{D}, \mathcal{H})$  with a noncommutative algebra will still be equivalent to some 'manifold', now promoted to a space, where points lose their meaning, i.e. a noncommutative space. Connes' geometry thus does to space-time what quantum mechanics does to phase space. In particular, it is even applicable to discrete spaces, or spaces which have dimension zero. Spectral triples are thus versatile enough to describe spaces, noncommutative or not, discrete or continuous, on an equal footing. For example, to find an algebra  $\mathcal{A}_f$  whose automorphisms reproduce the gauge symmetries of the standard model, one can define a *finite* spectral triple, for example with an algebra  $\mathcal{A}_f$  being a direct sum of matrix algebras. In the case of the standard model, this is  $\mathcal{A}_f = \mathbb{C} \oplus \mathbb{H} \oplus M_3(\mathbb{C})$ .

§ 9.3 ALMOST COMMUTATIVE GEOMETRY

An almost commutative geometry is defined to be the tensor product of two spectral triples, the first one describing a 4-dimensional spacetime, i.e.  $(C^\infty(\mathcal{M}), \mathcal{H} = \mathcal{L}^2(\mathcal{S}), \not{D})$ , and the second is a 0-dimensional one  $(\mathcal{A}_f, \mathcal{D}_f, \mathcal{H}_f)$ . A 0-dimensional triple has a finite dimensional Hilbert space  $\mathcal{H}_f$  and a finite dimensional algebra  $\mathcal{A}_f$ . In doing the tensor product, all ingredients are just tensorized, for example  $\mathcal{A} = C^\infty(\mathcal{M}) \otimes \mathcal{A}_f$  and  $\mathcal{H} = \mathcal{L}^2(\mathcal{S}) \otimes \mathcal{H}_f$ , while the total Dirac operator is given by the Leibniz rule, i.e.  $\mathcal{D} = \not{D} \otimes \mathbb{1}_f + \gamma^5 \otimes \mathcal{D}_f$ . One can

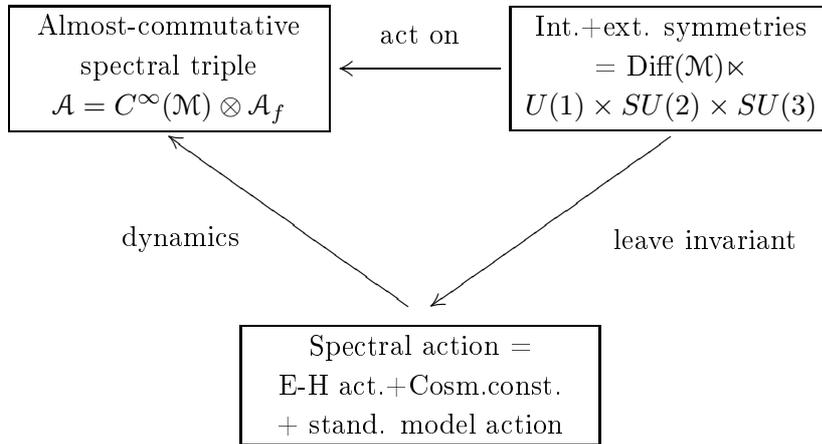

Figure 9.4: The almost commutative standard model.

show that the spectral action gives the Einstein-Hilbert action together with the bosonic part of the standard model action, in the case where the finite algebra  $\mathcal{A}_f$  is taken to be a direct sum of matrix algebras,  $\mathcal{A}_f = \mathbb{C} \oplus \mathbb{H} \oplus M_3(\mathbb{C})$ . One can view such an almost commutative geometry as ordinary (commutative) 4-dimensional spacetime with an 'internal' Kaluza-Klein

space attached to each point. The 'fifth' dimension is a discrete, 0-dimensional space. In figure 9.4, one can see the geometric arrangements. The automorphisms are a combination of  $\text{Diff}(\mathcal{M})$  and the gauge transformations acting on the finite particle content in a certain representation. It is a rather amazing fact that, since everything is formulated in a pure geometrical language, the Higgs fields turns out to be a connection on the 'internal' space and comes out automatically because of the interplay between the two unseparable  $C^\infty(\mathcal{M})$  and finite parts. Probably, this is one of the most appealing features of almost commutative geometry.

§ 9.4 KRAJEWSKI DIAGRAMS

The data of finite spectral triples can be completely encoded into a diagrammatic representation, the so called *Krajewski diagrams* (KD) [7]. This turns out to be a very convenient method to search for *irreducible* spectral triples, represented by minimal KD's. Irreducible finite spectral triples are spectral triples, whose Hilbert space are as small as possible without violating the axioms for spectral triples in general. In the theory developed in [8], KD's correspond to matrix-shaped arrays of anchors providing attachment points of 'arrows'. The arrows correspond to (parts of) the Dirac operator  $\mathcal{D}_f$  connecting the left and right particle/anti-particle content of the Hilbert space, that decomposes as  $\mathcal{H}_f = \mathcal{H}_L \oplus \mathcal{H}_R \oplus \mathcal{H}_L^c \oplus \mathcal{H}_R^c$  into particle, anti-particle, left, right. For all remarkable technical details the reader is advised to consult the extensive literature.

In the case of the standard model, for the example of three algebra summands, the KD is given in figure 9.5. The columns and rows correspond to  $\mathbb{C}$ ,  $\mathbb{H}$  and  $M_3(\mathbb{C})$ . The KD encodes

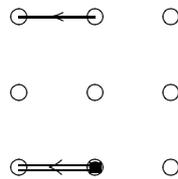

Figure 9.5: The Krajewski diagram of the standard model.

the representations compatible with the axioms of spectral triples. In the case of the KD 9.5, it reproduces the particle content of one generation

$$\begin{pmatrix} u \\ d \end{pmatrix}_L, \begin{pmatrix} c \\ s \end{pmatrix}_L, \begin{pmatrix} t \\ b \end{pmatrix}_L, \begin{pmatrix} \nu_e \\ e \end{pmatrix}_L, \begin{pmatrix} \nu_\mu \\ \mu \end{pmatrix}_L, \begin{pmatrix} \nu_\tau \\ \tau \end{pmatrix}_L, \tag{9.1}$$

$$u_R, c_R, t_R, e_R, \mu_R, \tau_R \\ d_R, s_R, b_R, \tag{9.2}$$

together with the corresponding anti particles. For three generations, the Hilbert space is 90-dimensional and the quarks are triplets under  $SU(3)$  as required. Note, that this representation is automatically reproduced from the representation sector of spectral triples and requires no further assumptions. Indeed, one can easily read it off the diagram: The starting

point of the top single arrow at the anchor  $(\mathbb{H}, \mathbb{C})$  is the left handed  $SU(2)$ -doublet  $(\nu_e, e)_L$ . The starting point of the 'clipped' double arrow at  $(\mathbb{H}, M_3(\mathbb{C}))$  corresponds to the left handed  $SU(2)$ -doublet of the quark  $SU(3)$ -triplets  $(u, d)_L$ . Finally, the right handed singlets are encoded from the position where the arrows point to. The top left corner at  $(\mathbb{C}, \mathbb{C})$  is  $(e_R)$ , the bottom left at  $(\mathbb{C}, M_3(\mathbb{C}))$  comes two times (because the arrows are not clipped together), one for the  $SU(3)$ -triplet  $(u_R)$ , the other one for  $(d_R)$ . This is the particle content of one generation. Analogously, it works for the anti-particle content and by taking everything three times (three generations), the particle content is complete. Note, that the picture given here is dramatically simplified, but it does not spoil the quite interesting result: As it happened for the representations, the axioms of spectral triples give the unfluctuated Dirac operator corresponding to a matrix with some numerical entries. By 'fluctuation', which can be thought of as the general coordinate transformation producing the 'pseudo' forces, a special entity pops up inside the matrix of  $\mathcal{D}$ , that can be identified with the Higgs field, being a color singlet, an isospin doublet with the physical component of vanishing electric charge. Indeed, in this framework, the Higgs can be understood as the 'internal' metric with its dynamics given by the Higgs potential. Calculating the spectral action produces the complete Yang-Mills-Higgs action of the standard model coupled to gravity.

## § 9.5 CLASSIFICATION

Following the 'minimal approach' in physics (and without knowing the KD for the standard model) one can now try to find all minimal KD's for a given number of matrix algebras. Roughly speaking, a minimal KD is a diagram which cannot be further reduced, in the sense of removing an arrow. Removing an arrow reduces the Hilbert space and therefore the particle content. A natural question then arises: Does the standard model represent a certain equivalence class of models in the set of all minimal diagrams? As shown in [8], this is indeed the case. For three matrix algebras, it is among a small set of some thirty irreducible diagrams, the only one making physical sense. Here, 'physical' stands for some basic physical assumptions, the 'shopping list' [8], for example one would like to have an anomaly free model, with non-degenerated fermion masses and an appropriate number of neutrinos.

Eventually, the classification of irreducible spectral triples with more than 2 algebra summands leads to an enormous amount of diagrams, hardly manageable by hand. The classification with three summands has been done in this way [8]. However, as it turns out, it is possible to translate a lot of necessary conditions imposed on the link between KD's and spectral triples into *if...then* statements. This allows to automatize the search for all irreducible spectral triples in a combinatorial manner, even for more than three summands of algebras.

For a most recent review about the noncommutative standard model, the classification and experimental predictions, please consult [12].

---

---

## CHAPTER 10

---

### PUBLICATIONS

The technical details of the algorithm to find all irreducible spectral triples and its consequences can be found in the following attached publications:

1. *Finding the standard model of particle physics, a combinatorial problem* [9], by Christoph Stephan and J.-H.J.. The publication explains in detail how to find all minimal KD's by developing an algorithm implemented as a program in C++. The program's size is about some 2000 lines and makes extensive use of object oriented programming (OOP) and standard template library (STL) techniques. The work has been accepted by *Computer Physics Communications (CPC)*. The program's source code can be obtained via e-mail: [jnx@quantentunnel.de](mailto:jnx@quantentunnel.de), subject: "use the source, luke".
2. *On a classification of almost commutative geometries, a second helping* [10], by Christoph Stephan and J.-H.J.. As a first application of the algorithm, we reproduced the results presented in [8]. It turned out that there were some diagrams missing in the analysis [8] which has been completed here. The work has been published in: *J. Math. Phys.* **46** (2005) 043512.
3. *On a classification of almost commutative geometries III* [11], by Thomas Schücker, C. Stephan and J.-H.J.. The classification of irreducible, almost commutative spectral triples has been extended to the case of four algebra summands. The work has been published in: *J. Math. Phys.* **46** (2005) 072303.

## READ.ME

```
*****
* 'Finding the standard model of particle physics - *
* a combinatorial problem' *
*****
```

Authors: Jan-H. Jureit & Christoph Stephan 2005-2007.

## Versions:

-----

The program package is coming in two versions:

- 'ko0' - Main program main\_ko0.cpp with all header and implementation files (listed below). Finding all irreducible Krajewski-diagrams in algebraic dimension K0-0 (see paper).
- 'ko6' - Main program main\_ko6.cpp with all header and implementation files (listed below). Finding all irreducible Krajewski-diagrams in algebraic dimension K0-6 (see paper).

Each version ('ko0' or 'ko6') comes with several headers (.h) and their implementations (.cpp), as well as a template class (.hpp).

## List of files:

-----

In each directory 'ko0' or 'ko6' one can find the following files:

- 'main\_koX.cpp' - Main program that arranges all the algorithm steps described in the article. The 'X' stands for '0' or '6'. In fact, both versions are completely equal, since the difference is in one of the additional files.
- 'AC\_Pos.cpp'
- 'AC\_Pos.h' - A simple class that provides a position (a point) inside a Krajewski diagram. It is essentially just a structure for a tuple (x,y) with integer values x and y.
- 'AC\_Arrow.cpp'
- 'AC\_Arrow.h' - This class provides an arrow inside a Krajewski diagram. It contains a vector of AC\_Pos-points. Several member functions are doing permutations, negations and other arrow-based operations.

- 
- 'AC\_Diagram.cpp' - This class represents a Krajewski diagram. It is a large collection of data and member functions doing all required operations used to manipulate a diagram like arrow-inversions, permutations, testing for equivalence, etc..
- 'AC\_Diagram.h' Here, there is the only difference between the two versions ko0 and ko6.
- 'AC\_Matrix.hpp' - This is a matrix template class provided for convenience and for handling the matrix content of each Krajewski-Diagram, like calculating determinants or summing matrices and so on. It's just a matrix class, nothing more.

Compiling and running:

-----

To compile and run a chosen version, make sure to adjust 3 global parameters given at the beginning of 'main\_koX.cpp'.

The global parameters are:

- 'DIMENSION' - Set the size of Krajewski diagrams. Default is 3 which means a 3x3-Matrix, i.e. a spectral triple with 3 algebra summands.
- 'MAX\_LEVEL' - Its default value is set to 3. This is the reached level of the main-net algorithm. If 3, all Krajewski diagram with a maximal number of 3 arrows will be generated.
- 'PRINT' - This is a bool for (printing || !printing). If true, the diagrams will be printed on standard output at the end of the calculation.

To compile, just compile all files (but the .hpp-file) and link them, for example with gcc on a unix machine:

```
'g++ -o output main_ko0.cpp AC_Pos.cpp AC_Arrow.cpp AC_Diagram.cpp -O2'
```

Running time and memory consumptions:

-----

The running time highly depends on the chosen size (DIMENSION) of the Krajewski diagrams. Starting with seconds for 3x3, it can run for a week or so for 5x5

on a standard Pentium 4.

For our computers, memory (>1GB) has been exceeded for the case 6x6 due to some millions of diagrams. Good luck.

---

## BIBLIOGRAPHY

- [1] C. Stephan, *"Noncommutative Geometry and the Standard Model of Particle Physics"*, Thesis, Universität Kiel (2005)
- [2] T. Kaluza, *"On the problem of Unity in Physics"*, Sitzungsber. Preuss. Akad. Wiss. Berlin (Math. Phys.) (1921) 966
- [3] A. Connes, *"Noncommutative Geometry"*, Academic Press (1994)
- [4] A. Connes, *"Noncommutative Geometry and Reality"*, J. Math. Phys. **36** (1995) 6194; A. Connes, *"Gravity coupled with matter and the foundations of noncommutative geometry"*, Comm. Math. Phys. **182** (1996) 155
- [5] A. Chamseddine, A. Connes, *"The spectral action principle"*, Comm. Math Phys. **186** (1997) 731;
- [6] T. Schücker, *"Forces from Connes' Geometry"*, Lect. Notes Phys. **659** (2005) 285
- [7] T., Krajewski, *"Classification of finite spectral triples"*, J. Geom. Phys. **28** (1998) 1
- [8] B. Iochum, T. Schücker and C. Stephan, *"On a classification of irreducible almost commutative geometries"*, J. Math. Phys. **45** (2004) 5003
- [9] J. H. Jureit and C. A. Stephan, *"Finding the standard model of particle physics: A combinatorial problem,"* to be published in Computer Physics Communications
- [10] J. H. Jureit and C. A. Stephan, *"On a classification of irreducible almost commutative geometries, a second helping,"* J. Math. Phys. **46**, 043512 (2005)
- [11] J. H. Jureit, T. Schucker and C. Stephan, *"On a classification of irreducible almost commutative geometries. III"*, J. Math. Phys. **46**, 072303 (2005)
- [12] J. H. Jureit, T. Krajewski, T. Schucker and C. A. Stephan, *"On the noncommutative standard model"*, arXiv:0705.0489 [hep-th].



## Finding the Standard Model of Particle Physics A Combinatorial Problem

Jan-Hendrik Jureit<sup>2, 3, 5</sup> Christoph A. Stephan<sup>2, 4, 5</sup>

### Abstract

We present a combinatorial problem which consists in finding irreducible Krajewski diagrams from finite geometries. This problem boils down to placing arrows into a quadratic array with some additional constraints. The Krajewski diagrams play a central role in the description of finite noncommutative geometries. They allow to localise the standard model of particle physics within the set of all Yang-Mills-Higgs models.

November 2006

---

<sup>1</sup> Leibnizstraße 15, D-24098 Kiel, Germany

<sup>2</sup> Université de Provence

<sup>3</sup> jureit@cpt.univ-mrs.fr

<sup>4</sup> stephan@cpt.univ-mrs.fr

<sup>5</sup> Centre de Physique Théorique Unité Mixte de Recherche (UMR) 6207 du CNRS  
et des Universités Aix-Marseille 1 et 2 Sud Toulon-Var, Laboratoire  
affilié à la FRUMAM (FR 2291)

# 1 Introduction

In this paper we present an algebraic problem which has its roots in noncommutative geometry. Given is the set of all square matrices  $M \in M_n(\mathbb{Z})$ , with integer entries and for fixed  $n$ . These matrices are called multiplicity matrices. Define a partial order in  $M_n(\mathbb{Z})$  by  $M \geq M'$  if  $M_{ij}$  and  $M'_{ij}$  have the same sign and  $|M_{ij}| \geq |M'_{ij}|$  for all  $i, j = 1, \dots, n$ . The task is now to find all the minimal multiplicity matrices with respect to this partial order which obey two further conditions. First, the determinant of  $M$  has to be non-zero. The second condition asserts that for any non vanishing matrix element there has to exist a second element of opposite sign in the same row or in the same column. It is straight forward to translate this problem into a combinatorial problem using diagrammatic language with arrows as basic elements. There are two reasons why it is preferable to work with these diagrams instead of the multiplicity matrices. The first and main reason is the geometric origin of the problem. Here the arrows in the diagram play a central role since they encode almost all the geometric information necessary for noncommutative geometry. Second, the map from the multiplicity matrices to the diagrams may be multivalued, i.e. for one multiplicity matrix there may exist several diagrammatic representations. But since these diagrammatic representations encode the geometric information we are finally interested in, it is appropriate to work with the diagrams.

We will give a simple set of rules how to fit arrows into a quadratic diagram body. The resulting diagrams are called Krajewski diagrams. They can be reduced by combining or “clipping” the arrows in the diagram in accordance with the rules. To each Krajewski diagram a multiplicity matrix will be associated. Our aim will be to find those Krajewski diagrams with a minimal number of arrows that are also as much reduced as possible while the determinant of the multiplicity matrix is non-zero. These diagrams will be called irreducible.

The rules to construct Krajewski diagrams follow directly from Alain Connes’ non-commutative geometry [1]. They are due to a special class of noncommutative geometries called almost-commutative geometries. These unify the general theory of relativity with the classical field theory of the standard model of particle physics [2]. It is possible to give a complete classification of almost-commutative geometries [3] which can be narrowed under addition of some physical assumptions to a classification of a class of Yang-Mills-Higgs theories. Within these theories, the standard model of particle physics takes a most prominent place [4, 8]. For a thorough introduction into the physical application of almost-commutative geometry we refer to [5].

Recent developments [6, 7] take into account that two different notions of *dimension* exist in noncommutative geometry. On the one hand the well known metric dimension (being four for space-time and zero for the internal space considered here) and an algebraic dimension associated to K-homology [1]. Before the work presented in [6, 7] these two dimensions were taken to be equal for a given space. But to solve some technical problems it proves to be beneficial to take the algebraic dimension of the internal space to be six instead of zero. Fortunately the specific value of the algebraic dimension can be translated straightforwardly into the setting of multiplicity matrices [8]. One finds that for an algebraic dimension zero the multiplicity matrix has to be symmetric, while an algebraic dimension six requires an anti-symmetric multiplicity matrix. These two multiplicity matrices originate from the same Krajewski diagram as will be explained below.

## 2 Constructing the Diagrams

Our task will now be to construct an algorithm that finds the irreducible Krajewski diagrams. To begin with we will give the basic rules that follow from the axioms of spectral triples and from the requirement of irreducibility. These rules will allow us to generate the diagrams and to perform all the necessary operations.

### 2.1 Basic Rules

**The diagram body:** The diagram body is the basis to construct diagrams from. It is a quadratic array of a given size with circles indicating the intersection points of the rows and the columns. These

circles have no meaning on their own but are there to guide the eye of the reader. The size of the diagram body will be fixed in advance.

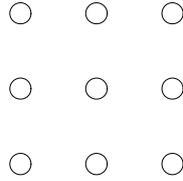

A  $3 \times 3$  diagram body

**The basic arrow:** The basic simple arrow connects two circles of the diagram body. With the end points of an arrow we associate two numbers which are called the chirality. This term stems from noncommutative geometry and corresponds to the chirality of particle physics. A simple arrow points from chirality  $+1$  to chirality  $-1$ :

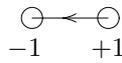

A simple arrow

It is also possible to connect two circles with more than one arrow. At a circle where two or more arrows end or start, the chiralities are simply added:

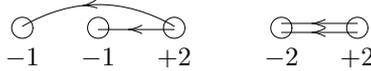

Examples of two arrows

Only an antiparallel arrangement of arrows is forbidden:

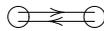

Forbidden antiparallel arrows

**Constructing a basic diagram:** To construct a basic diagram we put  $n$  horizontal arrows in an arbitrary way into the body. Diagrams are sorted by their total number of arrows. The empty diagram (i.e. the diagram body) is said to lie in level 0, the diagrams with one arrow are said to lie in level 1 and so on. For  $3 \times 3$  diagrams, some examples of possible diagrams are:

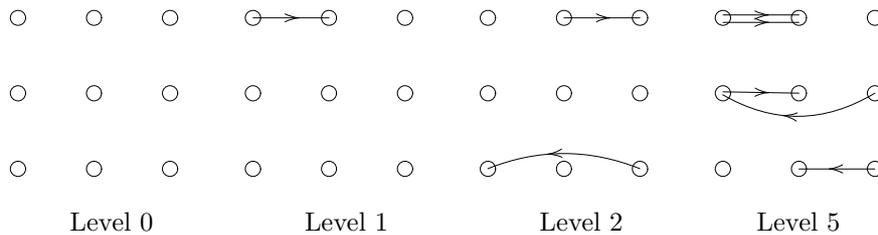

**The Multiplicity Matrix:** To every diagram, a matrix, called the *multiplicity matrix*  $M$ , is associated. It is a direct translation of the diagram into a matrix, achieved by taking the values of the chiralities at each end of the arrows in the diagram. These values are then written into a square matrix of the same size as the diagram. The multiplicity matrix is then the sum (difference) of this matrix and of its transposed, as shown in the following example:

$$M = \begin{pmatrix} 0 & 1 & -1 \\ 0 & 0 & 0 \\ -1 & 0 & 1 \end{pmatrix} \pm \begin{pmatrix} 0 & 0 & -1 \\ 1 & 0 & 0 \\ -1 & 0 & 1 \end{pmatrix}$$

The multiplicity matrix of a diagram where the plus-sign refers to the case with algebraic dimension zero and the minus-sign refers to algebraic dimension six.

Therefore, the multiplicity matrices corresponding to a diagram may be either symmetric or anti-symmetric, depending on the choice of the algebraic dimension. The algorithm presented below does not explicitly depend on the form of the multiplicity matrix, although the resulting minimal diagrams of course do.

For completeness we would like to mention that the case of algebraic dimension six has a further subtlety. If all the axioms of noncommutative geometry are strictly employed, no arrows are allowed to touch the main diagonal of the diagram [8]. Relaxing this axiom permits to include right-handed Majorana neutrinos into the standard-model [9] and thus the see-saw mechanism. Therefore, since this could be of physical interest we decided to allow arrows touching the diagonal even in the case of algebraic dimension six. It however turned out in the final classification [8] that the minimal standard model appears without such arrows, although they may be added by hand [9].

To avoid unnecessary long formulas in the examples given below, we will restrict ourselves in these examples to the symmetric case, i.e. to the case of algebraic dimension zero. Whenever a multiplicity matrix is given explicitly, it will be the symmetric one. The anti-symmetric case runs along the same lines.

**Clipping two arrows:** There are three different actions which may be performed on a diagram. The first consists in combining or *clipping* two arrows at a common point with common chirality. This creates a multiple arrow which has the chirality reduced to  $\pm 1$  at the clipping point. Due to a technicality from noncommutative geometry [4], clipping may only be considered as a *reduction* of a diagram, if it takes place on the diagonal. But diagrams with off-diagonal clipping points do produce sensible geometries and have to be taken into account. Clipping arrows will not change the level a diagram belongs to. Two simple examples of clipping two arrows are given by

where the black dot represents the clipping point.

One can extend the procedure of clipping in a natural way to multiple arrows. The only restriction is that clipping two arrows, be they multiple or simple, must not produce more than one clipping point. This means that the following construction is not permitted:

A permitted way of clipping a multiple arrow with a simple arrow would be

and clipping two multiple arrows, by combining their clipping points, is performed in the same way.

There may in general be more than one possibility to clip two arrows. An example of the two clipped diagrams originating from a diagram with two arrows in it, along with the corresponding multiplicity matrices, is given by:

$$\begin{array}{ccc}
 \begin{array}{ccc} \circ \rightleftarrows \circ & \circ & \\ \circ & \circ & \circ \\ \circ & \circ & \circ \end{array} & \longrightarrow & \begin{array}{ccc} \bullet \rightleftarrows \circ & \circ & \\ \circ & \circ & \circ \\ \circ & \circ & \circ \end{array}, \quad \begin{array}{ccc} \circ \rightleftarrows \bullet & \circ & \\ \circ & \circ & \circ \\ \circ & \circ & \circ \end{array} \\
 M = \begin{pmatrix} 4 & -2 & 0 \\ -2 & 0 & 0 \\ 0 & 0 & 0 \end{pmatrix} & \longrightarrow & M = \begin{pmatrix} 2 & -2 & 0 \\ -2 & 0 & 0 \\ 0 & 0 & 0 \end{pmatrix}, \quad M = \begin{pmatrix} 4 & -1 & 0 \\ -1 & 0 & 0 \\ 0 & 0 & 0 \end{pmatrix}
 \end{array}$$

Building a double arrow by clipping two parallel arrows

Note that the first clipped diagram is considered to be a reduction of the unclipped diagram since the clipping point lies on the diagonal. For the second clipped diagram this is not true, the clipping point is off-diagonal.

**Building a Corner** The second action which may be performed on a diagram consists in *building a corner*. Due to the same technical reason from noncommutative geometry as in the clipping case, building a corner is **never** considered to be a reduction of a diagram. Yet, these diagrams produce viable geometries and thus have to be considered. Building a corner is very closely related to the clipping of two arrows. In fact, it is achieved by transposing one of the two arrows which are then clipped, if they acquire a common point with compatible chirality. In analogy with matrices, transposing an arrow means reflecting it on the main diagonal of the diagram. This may again be possible in more than one way:

$$\begin{array}{ccc}
 \begin{array}{ccc} \circ \longrightarrow \circ & \circ & \\ \circ \longleftarrow \circ & \circ & \\ \circ & \circ & \circ \end{array} & \longrightarrow & \begin{array}{ccc} \circ \longrightarrow \bullet & \circ & \\ \circ & \circ & \circ \\ \circ & \circ & \circ \end{array}, \quad \begin{array}{ccc} \circ & \circ & \circ \\ \circ & \bullet & \circ \\ \circ & \circ & \circ \end{array} \\
 M = \begin{pmatrix} 2 & -2 & 0 \\ -2 & 2 & 0 \\ 0 & 0 & 0 \end{pmatrix} & \longrightarrow & M = \begin{pmatrix} 2 & -1 & 0 \\ -1 & 2 & 0 \\ 0 & 0 & 0 \end{pmatrix}, \quad M = \begin{pmatrix} 2 & -1 & 0 \\ -1 & 2 & 0 \\ 0 & 0 & 0 \end{pmatrix}
 \end{array}$$

Building a corner by clipping an arrow and a transposed arrow

This example also shows how a multiplicity matrix may correspond to different Krajewski diagrams.

**Erasing an arrow from a diagram:** The third action which may be performed on a diagram, consists in erasing an arrow. Erasing an arrow from a diagram is completely natural and lowers the level of the diagram by one. It is **always** considered to be a reduction. A simple arrow will be deleted and a multiple arrow will be reduced by erasing one of its sub-arrows, while leaving the chirality at the clipping point unaltered:

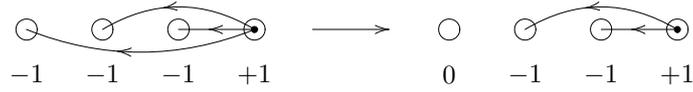

Since every arrow in a diagram may be reduced this way, erasing one arrow from a diagram in all possible ways will produce several different diagrams:

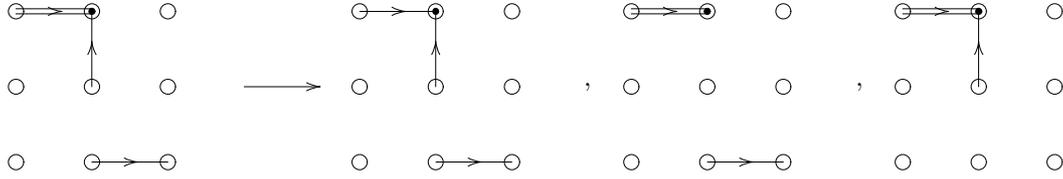

All possibilities to erase one arrow from a diagram

**Irreducible Diagrams:** A diagram is said to be irreducible, if it satisfies two conditions. First, the determinant of the multiplicity matrix has to be non-zero. Second, reducing the diagram by clipping on the diagonal or erasing arrows in all possible ways until one is left with the bare diagram body will on the way always produce diagrams with  $\det M = 0$ . These two conditions are required to hold whether the multiplicity matrix is symmetric or anti-symmetric.

As was already stressed above, the symmetry of the multiplicity matrix is irrelevant for the algorithm. But of course the determinant takes this symmetry into account. It follows immediately that for the case of algebraic dimension six, i.e. anti-symmetric multiplicity matrices, only diagrams of even size have to be taken into account. Any anti-symmetric  $n \times n$  matrix,  $n$  being an odd integer, has automatically zero determinant. Thus diagrams of odd size can only appear if the algebraic dimension is zero, i.e. the multiplicity matrix is symmetric. The following examples will continue to take only the symmetric case into account, since the anti-symmetric case follows straightforwardly and would only complicate the examples.

The simplest example for an irreducible diagram comes from the  $2 \times 2$  case and its irreducibility is easy to spot, since it contains only one arrow:

$$\begin{array}{ccc}
 \begin{array}{cc} \ominus & \longrightarrow & \ominus \\ \circ & & \circ \end{array} & \longrightarrow & \begin{array}{cc} \circ & \circ \\ \circ & \circ \end{array} \\
 M = \begin{pmatrix} 2 & -1 \\ -1 & 0 \end{pmatrix} & \longrightarrow & M = \begin{pmatrix} 0 & 0 \\ 0 & 0 \end{pmatrix} \\
 \det M = -1 & \longrightarrow & \det M = 0
 \end{array}$$

This is in fact the only irreducible Krajewski diagram in the  $2 \times 2$  case. For the  $3 \times 3$ , case the complete list of irreducible diagrams, as found in [4], is given in the appendix. One of the simplest examples is the following:

$$\begin{array}{ccc}
\begin{array}{ccc} \ominus \leftarrow \ominus & \circ & \\ \circ & \ominus \leftarrow \ominus & \\ \circ & \circ & \circ \end{array} & \longrightarrow & \begin{array}{ccc} \ominus \leftarrow \ominus & \circ & \\ \circ & \circ & \circ & , & \circ & \ominus \leftarrow \ominus \\ \circ & \circ & \circ & & \circ & \circ & \circ \end{array} \\
M = \begin{pmatrix} -2 & 1 & 0 \\ 1 & -2 & 1 \\ 0 & 1 & 0 \end{pmatrix} & \longrightarrow & M = \begin{pmatrix} -2 & 1 & 0 \\ 1 & 0 & 0 \\ 0 & 0 & 0 \end{pmatrix}, \quad M = \begin{pmatrix} 0 & 0 & 0 \\ 0 & -2 & 1 \\ 0 & 1 & 0 \end{pmatrix} \\
\det M = 2 & \longrightarrow & \det M = 0, \quad \det M = 0
\end{array}$$

Reducing the two diagrams on the right further by erasing their last arrow will of course lead to the empty diagram. Thus the Krajewski diagram on the left is irreducible.

**The Labels:** Every diagram carries a label indicating the reducibility. An ‘i’ stands for an irreducible diagram (the determinant of the multiplicity matrix  $M$  is necessarily non-zero). Diagrams which carry an ‘r’ can be reduced to a diagram equipped with an ‘i’ or an ‘r’ ( $\det M$  is of no importance). The label ‘0’ is carried by diagrams, where the determinant of the multiplicity matrix is zero, and which cannot be reduced to diagrams equipped with an ‘r’ or an ‘i’. Two examples of diagrams which would have the label ‘i’ are the two irreducibles in the preceding sub-paragraph.

A diagram with label ‘0’ would be

$$\begin{array}{ccc}
\ominus \longrightarrow \ominus & \circ & \\ \circ & \circ & \circ \\ \ominus \longrightarrow \ominus & \circ & 
\end{array}
M = \begin{pmatrix} 2 & -1 & 1 \\ -1 & 0 & -1 \\ 1 & -1 & 0 \end{pmatrix} \quad \det M = 0$$

since the determinant of the multiplicity matrix is zero and erasing any arrow will only lead to diagrams with zero determinants for their multiplicity matrices.

An example for a reducible diagram with label ‘r’ is given by

$$\begin{array}{ccc}
\ominus \longleftarrow \ominus & \circ & \\ \circ & \circ & \circ \\ \ominus \longleftarrow \ominus & \circ & 
\end{array}
M = \begin{pmatrix} -4 & 2 & -1 \\ 2 & 0 & 1 \\ -1 & 1 & 0 \end{pmatrix} \quad \det M = 0$$

It is easy to check that this diagram indeed reduces to

$$\begin{array}{ccc}
\bullet \longleftarrow \ominus & \circ & \\ \circ & \circ & \circ \\ \ominus \longleftarrow \ominus & \circ & 
\end{array}
M = \begin{pmatrix} -2 & 2 & -1 \\ 2 & 0 & 1 \\ -1 & 1 & 0 \end{pmatrix} \quad \det M = -2$$

by clipping the two top row arrows. This is an irreducible Krajewski diagram as one can easily check by successively reducing the diagram further.

As a last example, two irreducible Krajewski diagrams shall be presented, where the second diagram is obtained from the first one by building a corner:

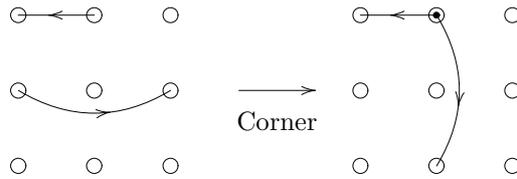

These two diagrams are considered irreducible, thus labelled ‘i’. Recall that building a corner is not interpreted as a reduction.

Since we are interested in irreducible Krajewski diagrams, the labels are in general of internal use only and we usually do not write them explicitly.

**Equivalence of Diagrams:** The physical theory following from a diagram is not dependent on the order of the rows and columns or on a reversal or transposition of all arrows at once. Permuting the rows and columns with the same permutation, transposing the diagram or reversing the arrows does not change the absolute value of the determinant of the multiplicity matrix. Consequently, diagrams that differ only by permutations of columns and rows, by transposition or by reversing the arrows, will be regarded as equivalent. All these diagrams build an equivalence class, and only one representative will be used for further operations. As an example, the following three diagrams are equivalent:

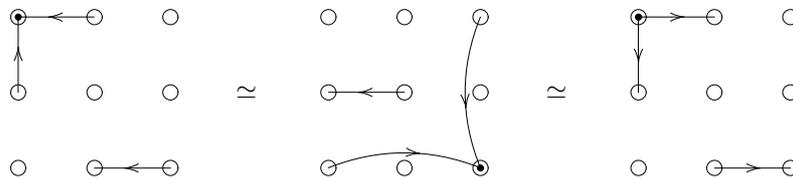

Three equivalent diagrams

**The Combinatorial Problem:** With the basic rules formulated above, our combinatorial problem is to find all the equivalence classes of irreducible Krajewski diagrams for a given size of the diagram body, and for a given maximal number of arrows. This seemingly simple task will produce complex structures which we will call *diagram nets*. These nets fall into two categories, the main-nets and the clip-nets. We will now present an algorithm to generate these nets and to find the embedded irreducible Krajewski diagrams.

### 3 The Algorithm

The algorithm to find the irreducible Krajewski diagrams can be divided into four subalgorithms. Every subalgorithm stands independently but builds up on the data produced by its predecessor. Summarised, the subalgorithms achieve the following: The first subalgorithm, dubbed the “main-net subalgorithm” creates a diagram net consisting of all equivalence classes of diagrams with up to  $N$  simple arrows. The “clip-net subalgorithm” creates a diagram net of equivalence classes from every element in the main-net, by clipping the contained arrows in each diagram in all possible ways. It thus produces all possible diagrams with multiple arrows. The third subalgorithm which we call the “label subalgorithm” checks, whether the elements of a clip-net represent an irreducible diagram and provisionally sets the labels ‘i’, ‘r’ and ‘0’ accordingly. Since the third subalgorithm can only see the elements in a single clip-net, the equivalence classes carrying an ‘i’ or a ‘0’ might still be reducible to an element one level below by erasing an arrow. So the last subalgorithm, the “label correction subalgorithm” checks these diagrams on their reducibility and changes their label to ‘r’, if necessary. The output of the whole algorithm are the diagrams labelled with an ‘i’, representing irreducible Krajewski diagrams.

### 3.1 The Main-Net Subalgorithm

The “main-net subalgorithm” fills the diagram body with up to  $N$  simple arrows. The maximal number of arrows, i.e. the maximal level, is chosen before. These arrows are put into the diagram body horizontally in every possible way, excluding only antiparallel arrows. Starting with the empty diagram body, level 1 is filled with one horizontal arrow. The resulting diagrams are checked for equivalence, and only one representative from each equivalence class is kept. In the same way every following level is built from the representative diagrams of the equivalence classes by adding one arrow. Each equivalence class is connected to its predecessors and its successors. Usually an equivalence class has several predecessors. To simplify the understanding of the complex structures which will arise, we will use the  $2 \times 2$  case, see figure 1, as an example.

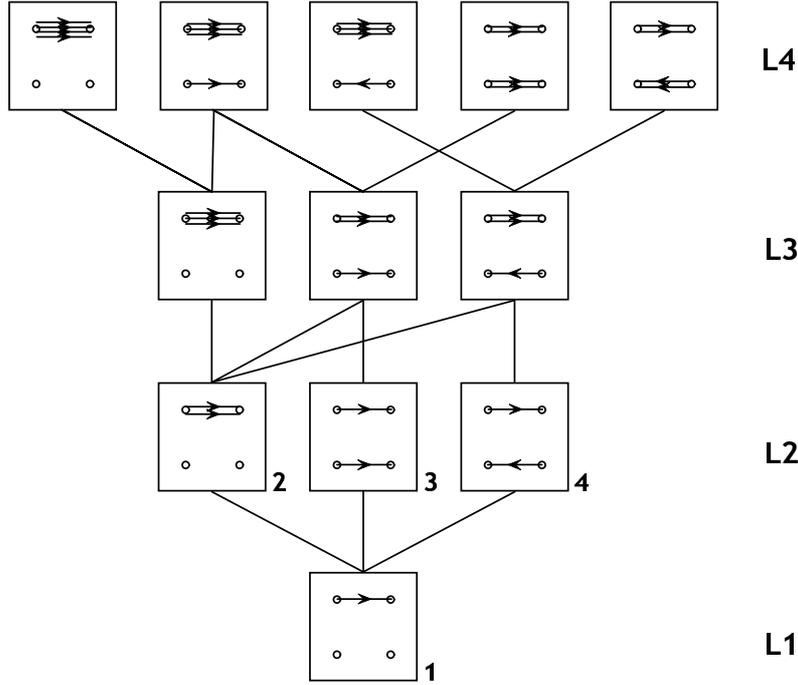

Figure 1: A main-net for a  $2 \times 2$  diagram with up to four arrows

The subalgorithm to generate the main-net is depicted in flow chart 1 in figure 4. Some explanations to read the flowchart are necessary:

1.  $N$  is the maximal number of arrows and is put in by hand. In our example, figure 1, we go up to  $N = 4$ .
2.  $L$  is the level index from which the diagrams are taken, which in our example goes up to  $L = 4$ , since there are  $N = 4$  arrows to be put in.
3.  $D_L$  is an element of the ordered set  $\{D_L\}$  that contains one representative of each equivalence class on level  $L$ . This kind of set is a basic notion in our flow charts. The specific order in the set is arbitrary, its only raison d'être is that the set can be run through from the first to the last element. The notion of ordered sets has as its aim to unclutter the flow charts and to eliminate superfluous indices. Taking the second level of our example with  $L = 2$ , the set  $\{D_{L=2}\}$  contains three elements which could be

$$\{D_{L=2}\} = \left\{ \begin{array}{ccc} \begin{array}{c} \circ \Rightarrow \circ \\ \circ \end{array} & \begin{array}{c} \circ \rightarrow \circ \\ \circ \end{array} & \begin{array}{c} \circ \rightarrow \circ \\ \circ \leftarrow \circ \end{array} \end{array} \right\}$$

or any other set consisting of equivalent diagrams.

- $f_{D_L}$  is an element of the ordered set  $\{f_{D_L}\}$  that contains all the operators which put one simple arrow into the diagram  $D_L$  in an allowed way. Each of these ordered sets is to be understood to belong to the specific diagram  $D_L \in \{D_L\}$  that is processed in the current loop. For the specific diagram

$$D_{L=2} = \begin{array}{c} \textcircled{\text{---}} \textcircled{\text{---}} \\ \textcircled{\text{---}} \quad \textcircled{\text{---}} \end{array} \quad (3.1)$$

the set of possible operations would be

$$\{f_{D_{L=2}}\} = \left\{ \begin{array}{l} \text{Put in :} \\ \textcircled{\text{---}} \textcircled{\text{---}} \quad \textcircled{\text{---}} \quad \textcircled{\text{---}} \quad \textcircled{\text{---}} \quad \textcircled{\text{---}} \\ \textcircled{\text{---}} \quad \textcircled{\text{---}}, \textcircled{\text{---}} \textcircled{\text{---}}, \textcircled{\text{---}} \textcircled{\text{---}} \end{array} \right\}. \quad (3.2)$$

The arrow

$$\begin{array}{c} \textcircled{\text{---}} \textcircled{\text{---}} \\ \textcircled{\text{---}} \quad \textcircled{\text{---}} \end{array}$$

may not be put into  $D_{L=2}$  since this would produce a forbidden antiparallel combination of arrows.

- $\{D_{L+1}\}$  is the set of diagrams that is generated by putting in an arrow by virtue of the operator  $f_{D_L}$ . For the example of  $D_{L=2}$  (3.1) and the set of operators  $\{f_{D_2}\}$  (3.2) this would give the set

$$\{f_{D_{L=2}}\} \left( \begin{array}{c} \textcircled{\text{---}} \textcircled{\text{---}} \\ \textcircled{\text{---}} \quad \textcircled{\text{---}} \end{array} \right) = \left\{ \begin{array}{l} \textcircled{\text{---}} \textcircled{\text{---}} \quad \textcircled{\text{---}} \textcircled{\text{---}} \quad \textcircled{\text{---}} \textcircled{\text{---}} \\ \textcircled{\text{---}} \quad \textcircled{\text{---}}, \textcircled{\text{---}} \textcircled{\text{---}}, \textcircled{\text{---}} \textcircled{\text{---}} \end{array} \right\}$$

- The equivalence of diagrams is checked making use of the definitions and invariants specified in section 2.1.

### 3.2 The Clip-Net Subalgorithm

This algorithm creates a clip-net from each main-net diagram by clipping the arrows or building corners in all possible ways. The main-net diagram is said to lie in clip level 0. The diagrams where two arrows have been clipped are said to be in clip level 1, and so on. Each of the diagrams in the clip-nets is again gathered in equivalence classes which are connected with regard to their predecessors and successors. Here the already mentioned technicality from the noncommutative geometry comes in: Whenever the clip-point is not on the diagonal the diagram has to ‘forget’ its predecessor. For a mathematical justification of this rule we refer to [4]. The maximal number of clip levels is determined by the number of arrows in the main-net diagram. If there are  $L$  arrows in a diagram there are up to  $L - 1$  ways to clip these arrows or to build corners.

The subalgorithm to generate the clip-net is depicted in flow chart 2 in figure 5. The explanations to read the flowchart are:

- The representative of the equivalence class from the main-net is a member of the clip-net. It is the only element on clip level 0.
- $S$  is the clip level index. It can go up to  $L - 1$ .
- $D_S$  is an element of the ordered set of representatives of the equivalence classes  $\{D_S\}$  of the diagrams in clip-net level  $S$ . For example the set  $\{D_{S=0}\}$  for the clip net of diagram (3.1) consists just of this element

$$D_{S=0} = D_{L=2} = \begin{array}{c} \textcircled{\text{---}} \textcircled{\text{---}} \\ \textcircled{\text{---}} \quad \textcircled{\text{---}} \end{array} \quad (3.3)$$

4.  $C_{D_S}$  is an element of the ordered set of operators  $\{C_{D_S}\}$  which clip pairs of arrows or builds corners in the diagram  $D_S$ , if possible. This set can be empty if it is impossible to clip any arrows or build corners.
5.  $\{D_{S+1}\}$  is the set of diagrams produced by applying  $\{C_{D_S}\}$  to each diagram in  $\{D_S\}$ , i.e. by clipping two arrows or building a corner in each  $D_S \in \{D_S\}$ . For the diagram  $D_{S=0}$ , (3.3) the set of possible operations would give the following diagrams in the set  $\{D_{S=1}\}$

$$\{C_{D_{S=0}}\} \left( \begin{array}{c} \text{---} \text{---} \text{---} \\ \circ \quad \circ \end{array} \right) = \left\{ \begin{array}{c} \bullet \text{---} \text{---} \text{---} \quad \text{---} \text{---} \bullet \\ \circ \quad \circ, \quad \circ \quad \circ \end{array} \right\} \quad (3.4)$$

And since there is only one diagram in  $\{D_{S=0}\}$  one immediately sees that  $\{D_{S=1}\} = \{C_{D_{S=0}}\}(D_{S=0})$ .

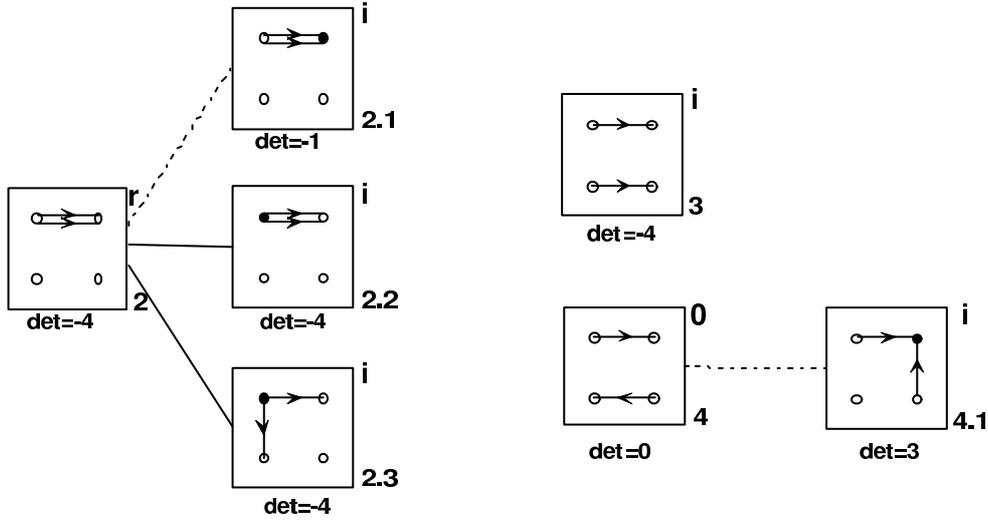

Figure 2: The elements of level 2 from the main-net, figure 1, with their corresponding clip-nets. The determinants of the corresponding multiplicity matrices are shown below the diagrams. Every diagram is labelled provisionally with respect to the label subalgorithm. Since all the diagrams are reducible to diagram 1 from the main-net, the label correction algorithm will change all the labels to ‘r’.

A simple example of such clip-nets is given by figure 2. It shows all the possible clip-nets belonging to the  $2 \times 2$  diagrams of the main-net from figure 1 for the second level. The dashed lines connecting diagram 2 to diagrams 2.1 and 2.3 as well as diagram 4 to 4.1 indicate that these connections should be “forgotten”. That is, they will not be taken into account, when the diagrams are labelled with respect to their reducibility since off-diagonal clipping is not considered to be a reduction.

To exhibit the possible complexity of such clip-nets, we give a schematic net in figure 3. Here we have left out the arrows to visualise only the basic structure of a clip-net. The dashed lines represent again the forgotten connections due off-diagonal clipping.

### 3.3 The Label Subalgorithm

This subalgorithm assigns to each equivalence class in a clip-net one of the labels ‘i’, ‘r’ or ‘0’ (one should not forget that the elements of the main-net are included in the clip-net). For the labels ‘i’ and ‘0’ this assignment is **provisional** since it might be changed by the “label correction subalgorithm”. The subalgorithm starts with the highest clip level since here the most reduced diagrams are situated. Here the labels are set to ‘i’ or ‘0’ depending on the determinant of the multiplicity matrix of the diagram

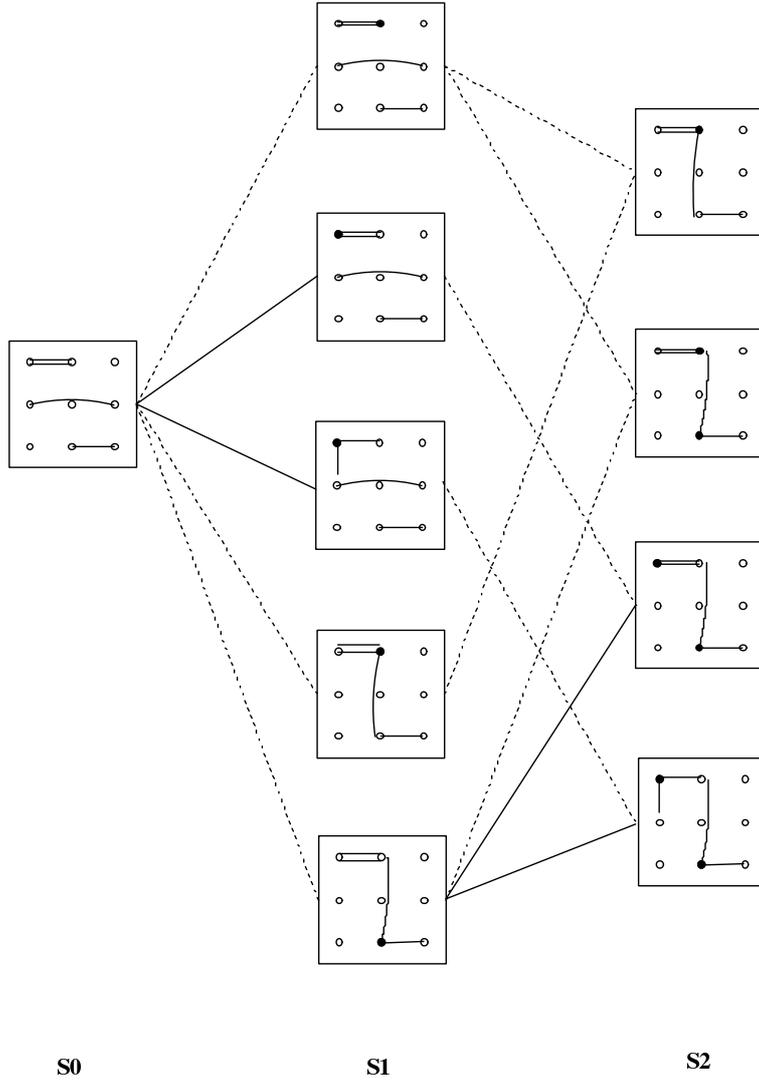

Figure 3: A simplified clip-net of a diagram with 4 arrows

being non-zero or not. Then the algorithm descends one by one to clip level 0 setting the labels according to the determinant to ‘i’ and ‘0’ or setting the label to ‘r’ if the diagram is connected to a successor with label ‘i’ or ‘r’.

The subalgorithm to label the clip-net is depicted in flow chart 3 in figure 6. The explanations to read the flowchart are:

1. If  $S$  is the highest clip level the command “Get label of  $D_{S+1}$ ” will always give label ‘0’ since the clip level  $S + 1$  does not exist and consequently there are no diagrams in  $\{D_{S+1}\}$ . This step is only needed to start the algorithm.
2.  $l(D_S)$  is the label of the element  $D_S$  and takes values ‘i’, ‘0’ or ‘r’.
3.  $\text{Det}(M_S)$  represents the determinant of the multiplicity matrix of  $D_S$ .

As an example for the labelling of a clip-net we take again the  $2 \times 2$  model from figure 1 and the corresponding clip-nets 2. First we set the label of the diagram in the level  $L = 1$ . It has only one

diagram which is also the only diagram in its clip-net (since there is just one arrow and thus nothing to clip). The determinant of the corresponding multiplicity matrix is  $\det M = -1 \neq 0$  and thus this diagram is irreducible and labelled ‘i’.

To label the diagrams of the clip-nets on level  $L = 2$  we proceed in the nets of figure 2 from right to left, since the diagrams on the right have the highest clip-level. Starting with the first clip-net for the diagram 2 in figure 2



we see that the three diagrams in the  $S = 1$  level have determinant  $\det M \neq 0$  for their multiplicity matrices and are thus provisionally labelled ‘i’. Proceeding to level  $S = 0$  we see that diagram 2 is connected to the diagrams 2.2 and 2.3 on level  $S = 1$  and is thus reducible. Therefore its label is set to ‘r’, no matter what the determinant of its multiplicity matrix may be. The other connection to diagram 2.1 has been forgotten and does not play any role. Diagram 3 in figure 2



does not allow any arrows to be clipped. And since the determinant of its multiplicity matrix is non-zero it is labelled ‘i’. Diagram 4 in figure 2



has a clip net which consists of itself on level  $S = 0$  and a corner on level  $S = 1$ . The diagram on level  $S = 1$  has determinant  $\det M \neq 0$  of its multiplicity matrix and is labelled ‘i’. Since the diagram 4 is only connected by a dashed line to the corner 4.1, i.e. it has “forgotten” the connection, one has to look at the determinant of the multiplicity matrix, which is zero. Therefore the diagram is labelled provisionally ‘0’.

To set the final labels and in this way to find the irreducible diagrams one has to correct the labels which were set by the “label subalgorithm”.

### 3.4 The Label Correction Subalgorithm

Since it may be possible to reduce a diagram provisionally carrying a label ‘i’ or ‘0’ to a diagram with label ‘i’ or ‘r’ by erasing an arrow, it is necessary to correct these labels. It is evident, when labelling from the bottom upwards, i.e. starting from  $L = 1$  upwards, that only the clip-nets of the predecessors of a main-net diagram are of importance for relabelling. The subalgorithm to relabel the clip-net is depicted in flow chart 4 in figure 7. The explanations to read the flowchart are:

1.  $D_S^{0,i}$  is an element of the ordered set  $\{D_S^{0,i}\}$  of *all* diagrams in the clip-net with label ‘i’ or ‘0’. The relations among the elements in the clip-net are of no importance since the diagrams are directly reduced to diagrams in clip-nets one level below. For the first diagram of figure 2 this set would be

$$\{D_S^{0,i}\} = \left\{ \begin{array}{cc} \begin{array}{c} \bullet \rightleftarrows \ominus \\ \circ \quad \circ \end{array} & \begin{array}{c} \ominus \rightleftarrows \bullet \\ \circ \quad \circ \end{array} \end{array} \right\} \quad (3.5)$$

2.  $R_{D_S^{0,i}}$  is an element of the ordered set of operators  $\{R_{D_S^{0,i}}\}$  that erase one arrow from a diagram  $D_S^{0,i} \in \{D_S^{0,i}\}$ . Applying  $\{R_{D_S^{0,i}}\}$  to the diagrams in the set 3.5 we find the following reduced diagrams

$$\{R_{D_S^{0,i}}\} \left( \begin{array}{c} \bullet \rightleftarrows \ominus \\ \circ \quad \circ \end{array} \right) = \left\{ \begin{array}{c} \ominus \rightarrow \circ \\ \circ \quad \circ \end{array} \right\} \quad \text{and} \quad \{R_{D_S^{0,i}}\} \left( \begin{array}{c} \ominus \rightleftarrows \bullet \\ \circ \quad \circ \end{array} \right) = \left\{ \begin{array}{c} \circ \rightarrow \ominus \\ \circ \quad \circ \end{array} \right\}$$

This is in both cases just the diagram on level  $L = 1$ . The same is true for all diagrams in all the clip-nets of figure 2, therefore all these diagrams are reducible to the diagram on level  $L = 1$ .

3.  $l(D_S^{0,i})$  is the label of the element  $D_S^{0,i}$  and takes values ‘i’, ‘0’ or ‘r’. For the example presented above this means that all the labels of the clip-net diagrams on level  $L = 2$  have to be corrected and their labels are set to ‘r’, since the diagrams can be reduced to the irreducible diagram on level  $L = 1$ . The same is obviously true for any level  $L > 1$  and thus the only irreducible diagram for the  $2 \times 2$  case is

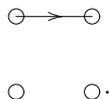

### 3.5 Assembling the Algorithm

The main algorithm is composed of the four subalgorithms. Its input is the size of the diagram body and the maximal number of arrows  $N$ . The assembly of the algorithm is now straight forward:

**Step 1:** Use the main-net subalgorithm to create the main-net up to level  $N$ .

**Step 2:** Create for each element in the main-net its clip-net with the clip-net subalgorithm.

**Step 3:** Starting with level  $L = 1$ , label all clip-nets on this level with the label subalgorithm and afterwards check the labels with the label correction algorithm. Repeat this procedure successively for each level up to  $N$ .

**Step 4:** Print out all the elements with label ‘i’. These are the equivalence classes representing irreducible Krajewski diagrams.

This algorithm runs very quickly on a recent PC with computation times of ca. 20 minutes for  $4 \times 4$  diagrams and five levels. But the complexity of the nets with their clip-nets grows rapidly with the size of the diagram bodies and the maximal number of arrows.

### 3.6 Using the Program

The program has been written in C++. For the structures building up the diagrams, arrows and all additional components, an extensive use of the OOP paradigm is made, together with STL-methods. As usual, the program comes as header files (.h) and their corresponding implementations (.cpp). The parts to be compiled and linked are *main\_ko0.cpp/main\_ko6.cpp*, *AC\_Pos.cpp*, *AC\_Arrow.cpp* and *AC\_Diagram.cpp*, where *main\_ko0.cpp* refers to the version with algebraic dimension zero and *main\_ko6.cpp* to the version with dimension six. We have also added a minimal matrix template class called *AC\_Matrix.hpp*. The structure of using these components should be clear from the context of the source code. The compilation was tested with *gcc-3.3* and should work with higher versions as well.

The program can be changed by adjusting three global parameters *DIMENSION*, *MAX\_LEVEL* and *PRINT* appearing from line 27 in *main.cpp*. The parameter *DIMENSION* can take any value above 2 (since a diagram with only one dimension makes no sense), and *MAX\_LEVEL* is the maximal number of arrows (Level) the main-net shall be generated with. Note, that settings higher then *DIMENSION > 4* and *MAX\_LEVEL > 5* lead to very long computation times. For testing purposes, the default setting is *DIMENSION=3* and *MAX\_LEVEL=4*. Finally, the variable *PRINT* is a boolean switch for printing the results or not, where *true* corresponds of course to printing the diagrams at the end of the calculation.

While the program is running, there is a number of further pieces of information displayed, indicating the sequential calls of the subalgorithms described before. As an example consider the output of the program *main\_ko0.cpp* for the  $2 \times 2$ -case up to level 3. It is easy to follow the steps, which are self explanatory (look also at the figures 1, 2 and 3):

- 1.1: Generating Level 1...  
[Ok]. 1 elements. Labels "i" have been set.
- 1.2: Generating Level 2...  
[Ok]. 3 elements.  
Connecting with Level 1...  
[Ok]. Connections: 3.
- 1.3: Generating Level 3...  
[Ok]. 3 elements.  
Connecting with Level 2...  
[Ok]. Connections: 5.
  
- 2.1: Setting pre-labels in level 2...  
[Ok].  $(r,i,0) = (3,0,0)$ .  
Generating clip-net structure...  
Label Correction...  
[Ok].  
Labels in this level:  $(r,i,0) = (3,0,0)$ .  
Irreducibles in clip-net structure: 0
- 2.2: Setting pre-labels in level 3...  
[Ok].  $(r,i,0) = (3,0,0)$ .  
Generating clip-net structure...  
Label Correction...  
[Ok].  
Labels in this level:  $(r,i,0) = (3,0,0)$ .  
Irreducibles in clip-net structure: 0

Note, that the message "Setting pre-labels" corresponds to the labels of the main-net diagrams if there were no additional clip-net structure. This had the purpose of testing the label correction, and we just left it in. "Generating clip-net structure" means the clip-net subalgorithm followed by the first label algorithm. Then the "Label correction" is followed by some information about the label content of the corresponding level and clip-net structure.

If *PRINT* is true, these lines are followed by the list of all irreducible diagrams (in this case it is only one!):

---

```

Label: i |Arrows: 1 |Level: 1 |Determinant: -1
1 -1
0 0
Arrow 1: (0,0) -> (1,0)
Predecessors: |Successors: 0 1 2

```

---

The predecessors and successors are of internal use only, and all other data should be clear. In this diagram, there is only one arrow going from the left top corner (0,0) to the right top corner (1,0). Note that the matrix-like numbers do not represent the multiplicity matrix, but rather the matrix which follows directly from the positions and directions of the arrows, i.e. the matrix of chiralities.

## 4 Open Problems

There are two major open problems. The first problem is the question how to choose the maximal number  $N$  of arrows to be put into a diagram body. We know that the total number of irreducible Krajewski diagrams is finite, see [4], but we do not know the exact number of such diagrams. Up to now we adopted the simple conjecture that if no diagrams with label 'i' appear in two successive levels (say level 4 and

level 5 for the  $4 \times 4$  case), we considered the maximal number of irreducibles as reached. But there is still a possibility of “islands” of irreducible Krajewski diagrams in higher levels. Although we have checked all the elements of the diagram net for  $3 \times 3$  diagram bodies (in the case of algebraic dimension zero) and can be sure that no more than three levels are necessary, already for  $4 \times 4$  diagram bodies (in both algebraic dimension zero and six) this is no longer possible. We are therefore looking for a criterion to determine the maximal level for a given size of the diagrams.

The second problem is the rapid increase of computational time and of memory required by the algorithm. We quickly exceed the capabilities of an ordinary personal computer and it will probably be necessary to use some sort of parallel computer or cluster to go beyond  $5 \times 5$  diagram bodies.

## 5 Statement of the Result and Conclusions

We presented an algorithm to find irreducible Krajewski diagrams. The rules given here quickly produce very complex nets of diagrams in which the irreducibles are embedded. One of the most surprising features of these nets is that for  $3 \times 3$  and  $4 \times 4$  diagram bodies only some fifty irreducible Krajewski diagrams appear in the case of algebraic dimension zero. In the case of algebraic dimension six the situation is even better with only one diagram for  $2 \times 2$  diagram bodies and thirteen for  $4 \times 4$  bodies. A complete list of these diagrams can be found in [4] for the zero dimensional case and in [8] for the six dimensional case. We give the list for the  $4 \times 4$  case in dimension six in the appendix.

Unfortunately already  $5 \times 5$  diagram bodies produce at least several hundreds of irreducible diagrams. The order of magnitude of the total number of irreducibles seems to be linked to the minimal number of arrows to produce an irreducible diagram.  $3 \times 3$  and  $4 \times 4$  diagrams need two arrows whereas  $5 \times 5$  diagrams already need three arrows. But in regard of the much shorter list of diagrams in dimension six the situation may there be better for  $6 \times 6$  diagrams, although here the calculation time is so far an obstacle. To get an idea of the increasing computational time and complexity of the problem we give a short list of the cases which were already computed on an Intel Pentium 4 PC with 2,8 GHz.

Alg. Dim.	Size	# Arrows	t	# Inequiv. Diag.
0	$3 \times 3$	3	$\sim 1s$	107
0	$4 \times 4$	3	$\sim 1min$	444
6	$4 \times 4$	3	$\sim 4min$	444
0	$4 \times 4$	4	$\sim 2h : 20min$	5201
6	$4 \times 4$	4	$\sim 36h$	5201

This list is ordered with respect to the algebraic dimension, the size of the diagram body, the maximal number of arrows, the resulting computation time and the number of inequivalent diagrams. Note that the program has to treat all the diagrams in each equivalence class as well which explains the rapid increase in computation time.

The irreducible Krajewski diagrams are a vital ingredient for the classification of almost-commutative geometries from the view point of a particle physicist. From this classification follows the prominent position of the standard model within the Yang-Mills-Higgs theories compatible with noncommutative geometry. To underline the virtue of the algorithm we would like to present the diagram corresponding to the standard model of particle physics:

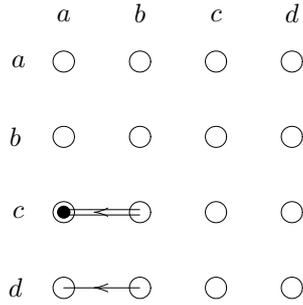

The Krajewski diagram of the standard model

It is most fascinating that this very diagram is irreducible irrespective its algebraic dimension. The standard model appears in the zero dimensional case [4] as well as in the most recent six dimensional case [8]. For a detailed treatment for the latter we refer to [10].

There is a discrepancy of two diagrams in the  $3 \times 3$  case between the output of the algorithm and the list of diagrams given in [4]. Some diagrams have been left out in the classifications, because they do not allow to construct a noncommutative geometry, due to a property of the spectral triples associated to the diagrams, for details see [3]. This is a purely geometrical property, which unfortunately cannot be encoded into the Krajewski diagrams and has to be checked later. The same is true for four diagrams in the  $4 \times 4$  case and explains the discrepancy between the output of the program and the list given in [4].

**Acknowledgements:** The authors would like to thank T. Schücker and B. Iochum for their advice and support. J.-H.J. gratefully acknowledges a fellowship of the Friedrich-Ebert-Stiftung and C.A.S. a fellowship of the Alexander von Humboldt-Stiftung.

## 6 Appendix

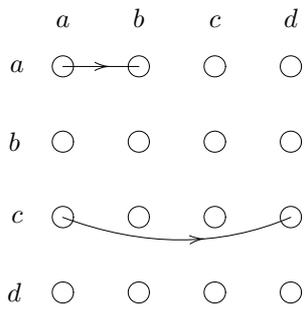

diag. 1

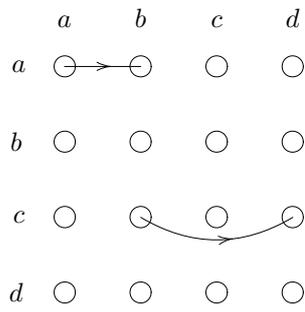

diag. 2

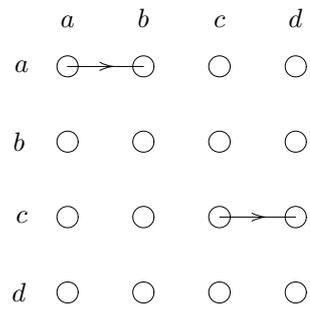

diag. 3

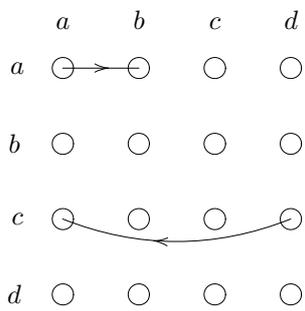

diag. 4

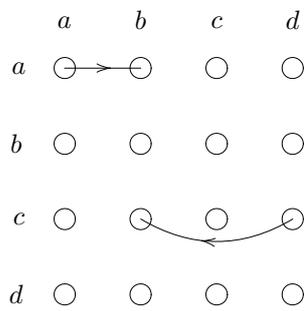

diag. 5

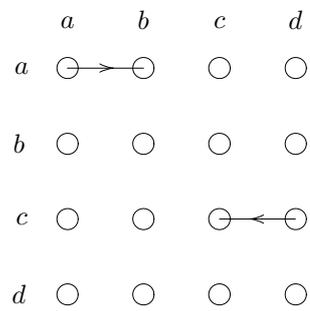

diag. 6

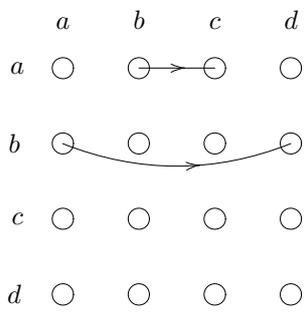

diag. 7

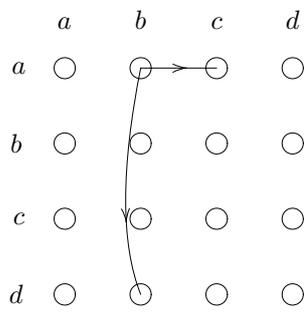

diag. 8

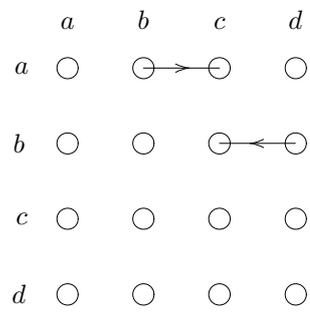

diag. 9

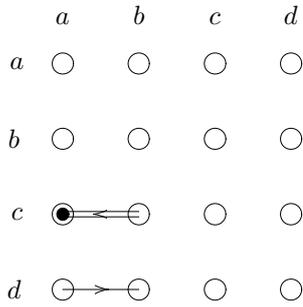
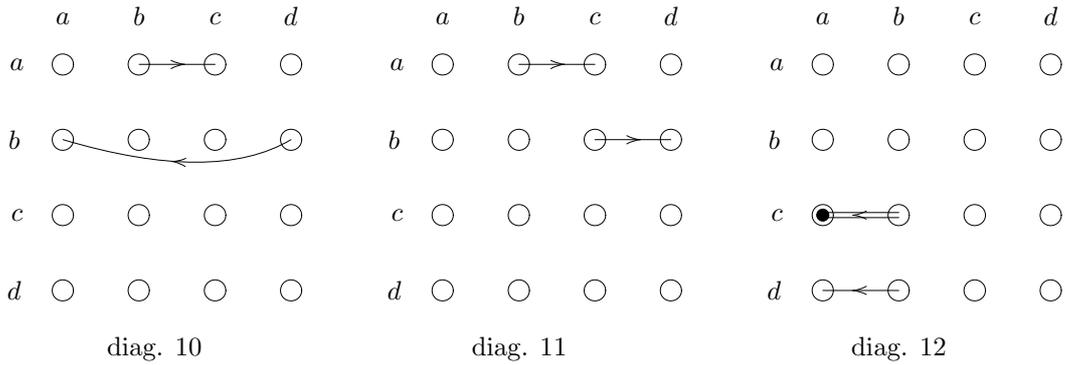

## References

- [1] A. Connes, *"Noncommutative Geometry"*, Academic Press, London and San Diego (1994)
- [2] A. Chamseddine & A. Connes, *"The spectral action principle"*, [hep-th/9606001], Comm. Math. Phys. 182 (1996) 155
- [3] T. Krajewski, *"Classification of finite spectral triples"*, [hep-th/9701081], J. Geom. Phys. 28 (1998) 1  
M. Paschke & A. Sitarz, *"Discrete spectral triples and their symmetries"*, [q-alg/9612029], J. Math. Phys. 39 (1998) 6191
- [4] B. Iochum, T. Schücker, C. Stephan, *"On a Classification of Irreducible Almost Commutative Geometries"*, [hep-th/0312276], J.Math.Phys. 45 (2004) 5003  
J.-H. Jureit, C. Stephan, *"On a Classification of Irreducible Almost Commutative Geometries, a Second Helping"*, [hep-th/0501134], J.Math.Phys. 46 (2005) 043512  
J.-H. Jureit, T. Schücker, C. Stephan, *"On a Classification of Irreducible Almost Commutative Geometries III"*, [hep-th/0503190], J.Math.Phys. 46 (2005) 072303  
T. Schücker, *"Krajewski diagrams and spin lifts"*, [hep-th/0501181]
- [5] T. Schücker, *"Forces from Geometry"*, [hep-th/0111236]
- [6] A. Connes, *"Noncommutative geometry and the standard model with neutrino mixing"*, [hep-th/0608226]

- [7] J.W. Barrett, "*A Lorentzian version of the non-commutative geometry of the standard model of particle physics*", [hep-th/0608221]
- [8] J. Jureit, C.A. Stephan, "*On a classification of irreducible almost-commutative geometries. IV*", [hep-th/0610040]
- [9] C. A. Stephan, "*Almost-commutative geometry, massive neutrinos and the orientability axiom in KO-dimension 6*", [hep-th/0610097]
- [10] A. Chamseddine, A. Connes & M. Marcolli, "*Gravity and the standard model with neutrino mixing*", [hep-th/0610241]

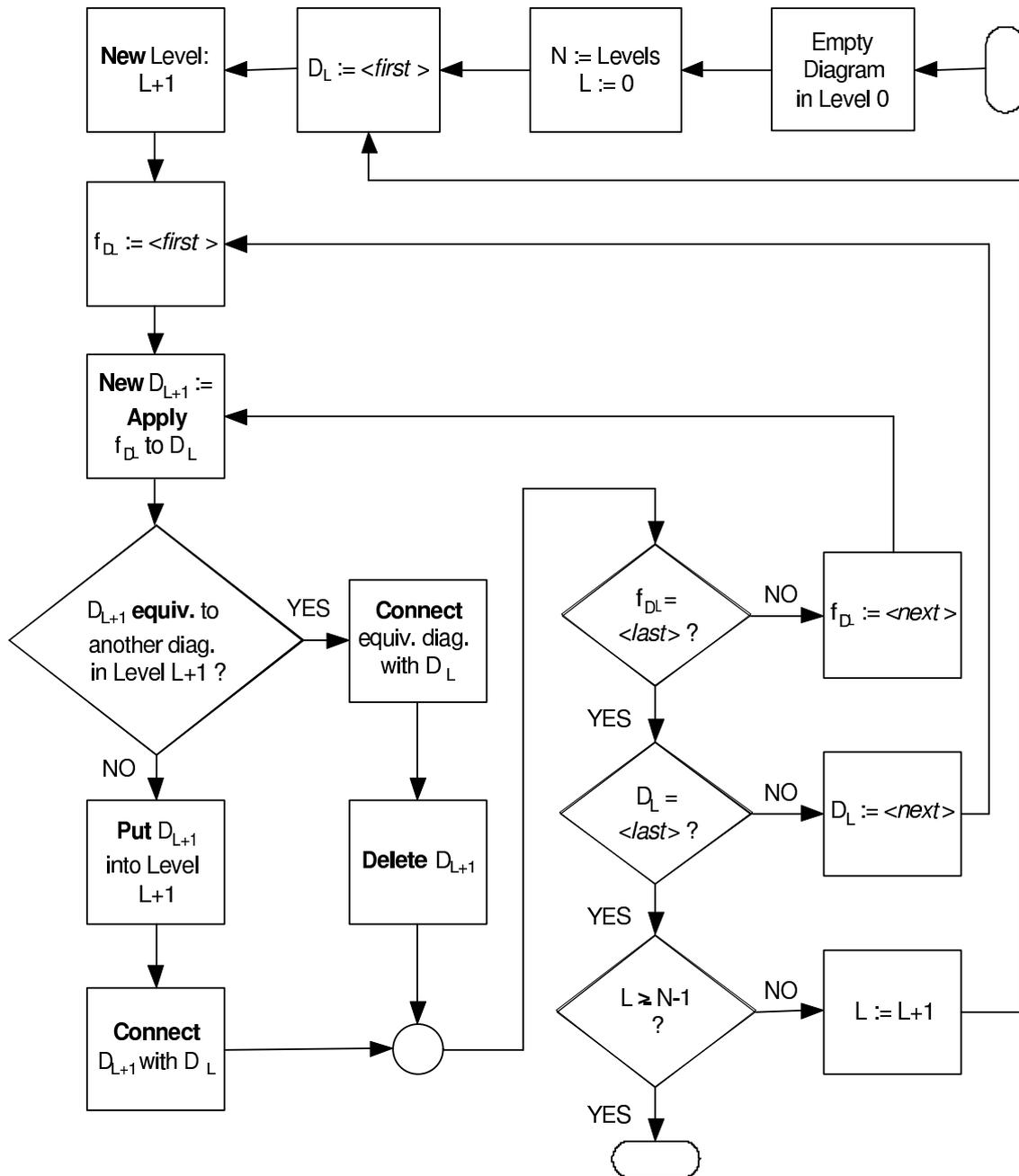

Figure 4: The Main-Net Subalgorithm

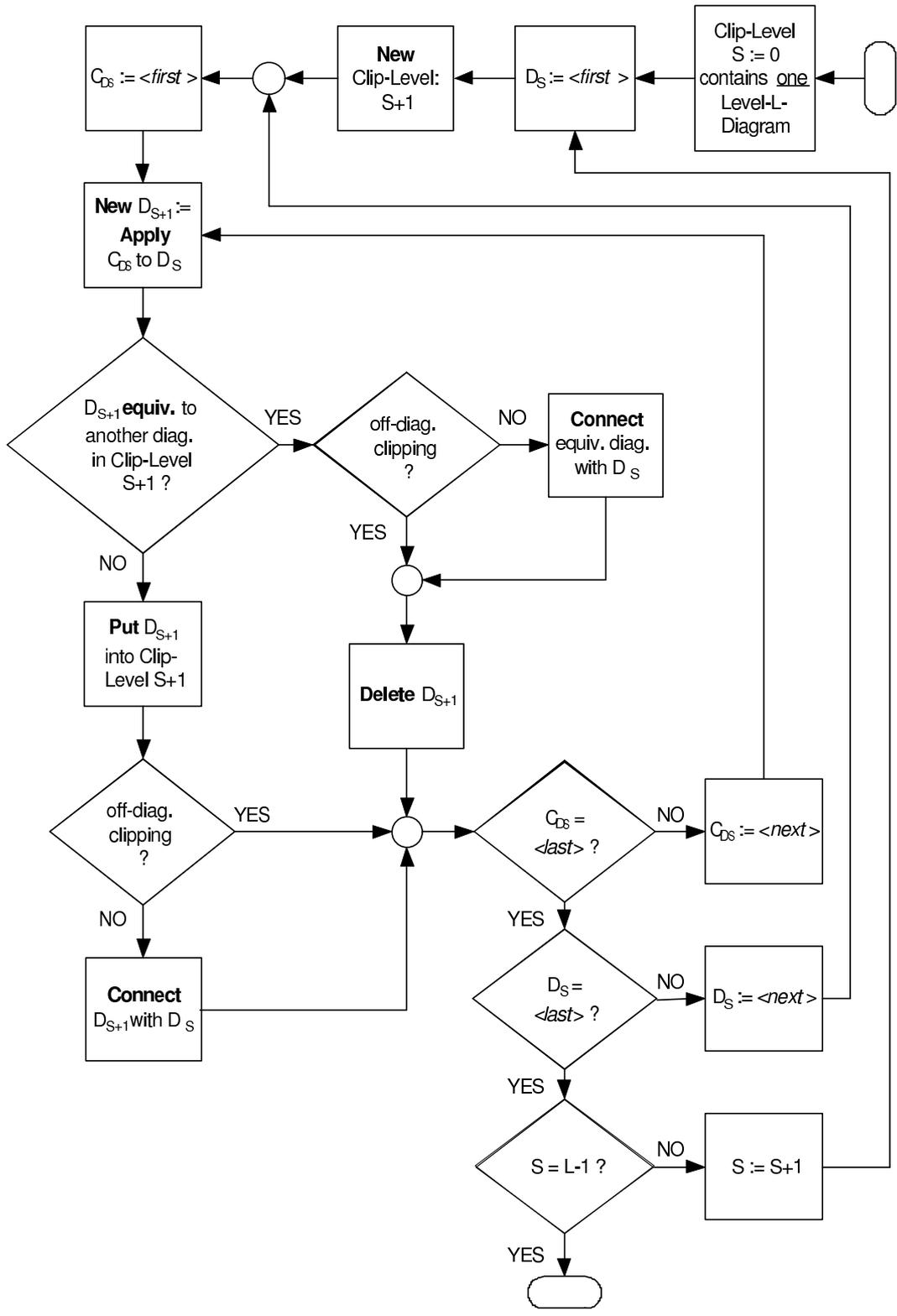

Figure 5: The Clip-Net Subalgorithm

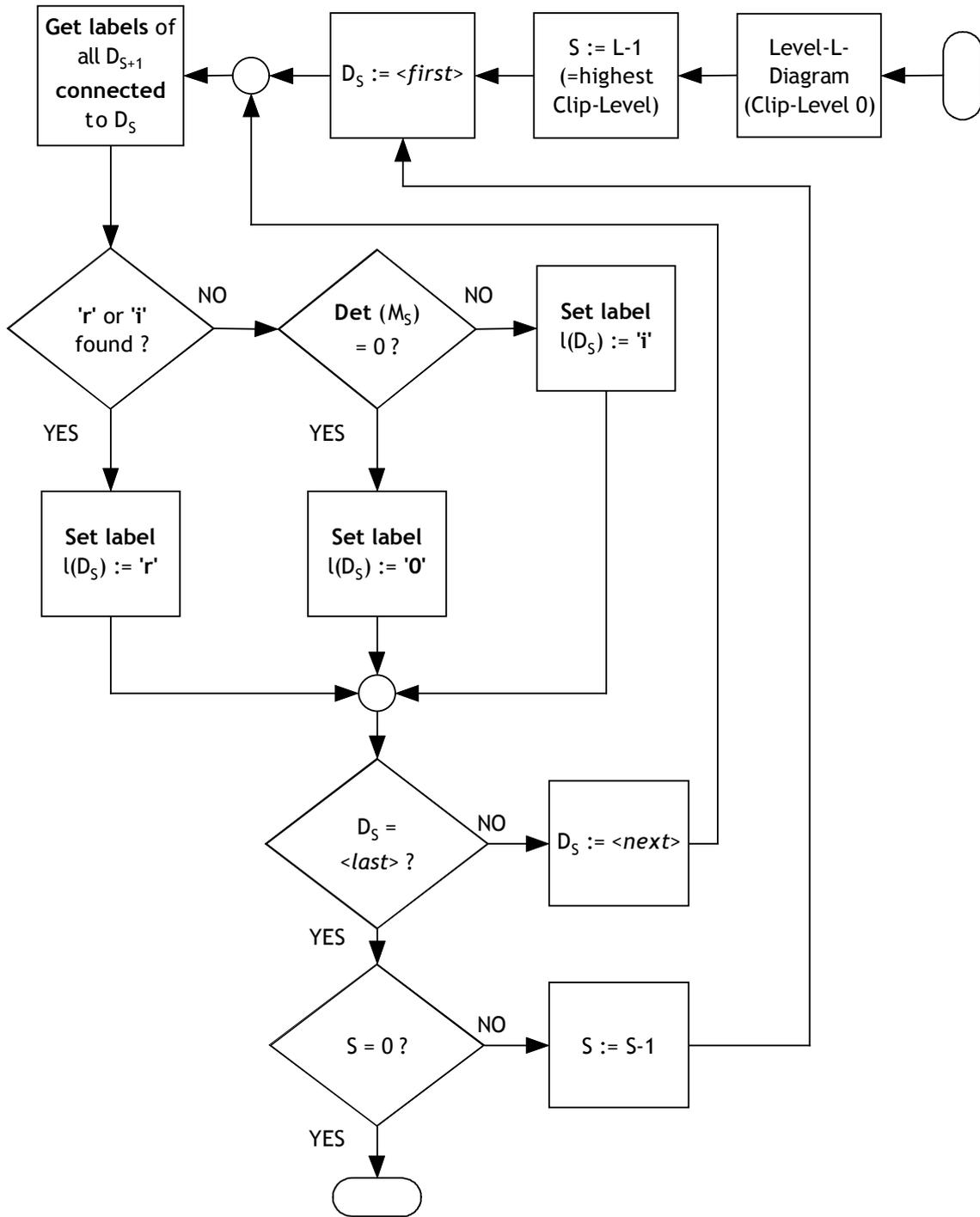

Figure 6: The Label Subalgorithm

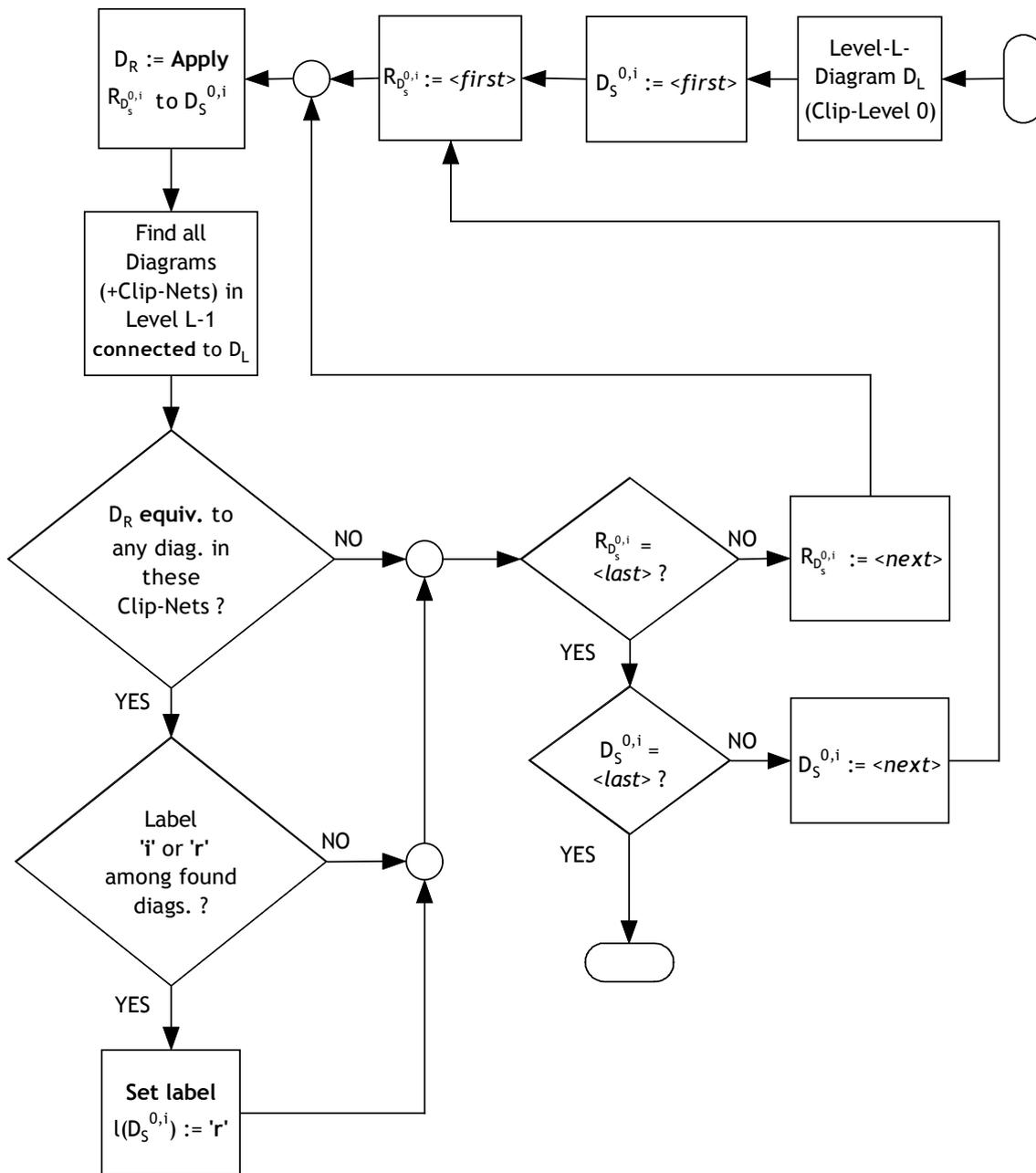

Figure 7: The Label Correction Subalgorithm

## On a classification of irreducible almost commutative geometries, a second helping

Jan-Hendrik Jureit<sup>a),b)</sup> and Christoph A. Stephan<sup>a),c)</sup>

*Centre de Physique Théorique, CNRS-Luminy, Case 907*

*13288 Marseille Cedex 9, France*

(Received 18 January 2005; accepted 26 January 2005; published online 29 March 2005)

We complete the classification of almost commutative geometries from a particle physics point of view given by Iochum, Schücker, and Stephan, *J. Math. Phys.* (to be published). Four missing Krajewski diagrams will be presented after a short introduction into irreducible, nondegenerate spectral triples. © 2005 American Institute of Physics. [DOI: 10.1063/1.1876873]

### I. INTRODUCTION

Alain Connes' noncommutative geometry<sup>1-4</sup> allows in an elegant way to unify gravity and the standard model of particle physics. A central role in this formalism is played by almost commutative spectral triples  $(\mathcal{A}, \mathcal{H}, \mathcal{D})$  which decompose into an external and an internal, finite dimensional component. The external part encodes a compact four-dimensional Euclidian space–time and the internal one corresponds to a discrete 0-dimensional Kaluza–Klein space, determining the particle content of the theory. Via the spectral action<sup>5</sup> one recovers the Einstein–Hilbert action combined with the bosonic action of a Yang–Mills–Higgs (YMH) theory. Since the set of allowed YMH theories is determined by the possible internal, finite dimensional spectral triples, we will restrict ourselves to this part. The standard model of particle physics is the most prominent example in this context.

Real, finite dimensional spectral triples have been completely classified by Krajewski<sup>6</sup> and Paschke and Sitarz.<sup>7</sup> A classification of almost commutative geometries from a physical point of view was given in Ref. 8. The spectral triples were required to be irreducible and nondegenerate, in the sense that the Hilbert space was chosen to be as small as possible with nondegenerate fermion masses. Heavy use was made of Krajewski's diagrammatic method, which will be described briefly below. The main obstacle in finding all physically relevant almost commutative spectral triples is the sheer mass of diagrams which must be considered. Since this is a purely combinatorial problem it is convenient to let a computer do the tedious task. The cases of one and two matrix algebras can still be done by hand. But already three algebras produce hundreds of diagrams and one easily loses sight.

Therefore we developed an algorithm to calculate these diagrams and used the known results from Ref. 8 to test and calibrate the program. The main goal was to extend the calculations to more than three algebras, where we expect thousands of possible irreducible spectral triples. During the calibration it turned out that four diagrams were overlooked in the case of three algebras. To complete the proof we will present these four missing diagrams and their models in this paper. The algorithm to compute the diagrams and the results for the case of four algebras will be presented elsewhere.

---

<sup>a)</sup>Also at Université de Provence and Universität Kiel.

<sup>b)</sup>Electronic mail: jureit@cpt.univ-mrs.fr

<sup>c)</sup>Electronic mail: stephan@cpt.univ-mrs.fr

In Sec. II we give some basic definitions and briefly introduce Krajewski diagrams and irreducible, nondegenerate spectral triples. The missing diagrams for three algebras are presented in Sec. III.

## II. BASIC DEFINITIONS, IRREDUCIBILITY, AND NONDEGENERACY

In this section we give the necessary basic definitions for a classification of almost commutative geometries from a particle physics point of view. As mentioned above only the 0-dimensional part will be taken into account, so we restrict ourselves to real,  $S^0$ -real, finite spectral triples  $(\mathcal{A}, \mathcal{H}, \mathcal{D}, J, \epsilon, \chi)$ . The algebra  $\mathcal{A}$  is a finite sum of matrix algebras  $\mathcal{A} = \bigoplus_{i=1}^N M_{n_i}(\mathbb{K}_i)$  with  $\mathbb{K}_i = \mathbb{R}, \mathbb{C}, \mathbb{H}$ , where  $\mathbb{H}$  denotes the quaternions. A faithful representation  $\rho$  of  $\mathcal{A}$  is given on the finite dimensional Hilbert space  $\mathcal{H}$ . The Dirac operator  $\mathcal{D}$  is a self-adjoint operator on  $\mathcal{H}$  and plays the role of the fermionic mass matrix.  $J$  is an antiunitary involution,  $J^2 = 1$ , and is interpreted as the charge conjugation operator of particle physics. The  $S^0$ -real structure  $\epsilon$  is a unitary involution,  $\epsilon^2 = 1$ . Its eigenstates with eigenvalue  $+1$  are the particle states, eigenvalue  $-1$  indicates antiparticle states. The chirality  $\chi$  as well is a unitary involution,  $\chi^2 = 1$ , whose eigenstates with eigenvalue  $+1(-1)$  are interpreted as right (left) particle states. These operators are required to fulfill Connes' axioms for spectral triples:

$$(i) \quad [J, \mathcal{D}] = [J, \chi] = [\epsilon, \chi] = [\epsilon, \mathcal{D}] = 0, \quad \epsilon J = -J\epsilon, \quad \mathcal{D}\chi = -\chi\mathcal{D},$$

$$[\chi, \rho(a)] = [\epsilon, \rho(a)] = [\rho(a), J\rho(b)J^{-1}] = [[\mathcal{D}, \rho(a)], J\rho(b)J^{-1}] = 0, \quad \forall a, b \in \mathcal{A}.$$

- (ii) The chirality can be written as a finite sum  $\chi = \sum_i \rho(a_i) J \rho(b_i) J^{-1}$ . This condition is called *orientability*.
- (iii) The intersection form  $\cap_{ij} := \text{tr}(\chi \rho(p_i) J \rho(p_j) J^{-1})$  is nondegenerate,  $\det \cap \neq 0$ . The  $p_i$  are minimal rank projections in  $\mathcal{A}$ . This condition is called *Poincaré duality*.

Now the Hilbert space  $\mathcal{H}$  and the representation  $\rho$  decompose with respect to the eigenvalues of  $\epsilon$  and  $\chi$  into left and right, particle and antiparticle spinors and representations,

$$\mathcal{H} = \mathcal{H}_L \oplus \mathcal{H}_R \oplus \mathcal{H}_L^c \oplus \mathcal{H}_R^c, \quad \rho = \rho_L \oplus \rho_R \oplus \overline{\rho}_L^c \oplus \overline{\rho}_R^c.$$

In this representation the Dirac operator has the form

$$\mathcal{D} = \begin{pmatrix} 0 & \mathcal{M} & 0 & 0 \\ \mathcal{M}^* & 0 & 0 & 0 \\ 0 & 0 & 0 & \overline{\mathcal{M}} \\ 0 & 0 & \overline{\mathcal{M}}^* & 0 \end{pmatrix},$$

where  $\mathcal{M}$  is the fermionic mass matrix connecting the left-handed and the right-handed fermions.

Connes' axioms, the decomposition of the Hilbert space, the representation and the Dirac operator allow a diagrammatic depiction. As was shown in Refs. 6,8 this can be boiled down to simple arrows, which encode the intersection form and the fermionic mass matrix. From this information all the ingredients of the spectral triple can be recovered. For our purpose a simple arrow and a double arrow are sufficient. The arrows always point from right fermions (positive chirality) to left fermions (negative chirality). We may also restrict ourselves to the particle part, since the information of the antiparticle part is included by transposing the particle part. We will adopt the conventions of Ref. 8.

The *fluctuation*  ${}^f\mathcal{D}$  of the Dirac operator  $\mathcal{D}$  is given by a finite collection  $f$  of real numbers  $r_j$  and algebra automorphisms  $\sigma_j \in \text{Aut}(\mathcal{A})^e$  lifted to the Hilbert space  $\mathcal{H}$  such that

$${}^f\mathcal{D} := \sum_j r_j L(\sigma_j) \mathcal{D} L(\sigma_j)^{-1}, \quad r_j \in \mathbb{R}, \quad \sigma_j \in \text{Aut}(\mathcal{A})^e,$$

where the Lift is given by

$$L(\sigma) = \rho(u) J \rho(u) J^{-1}.$$

The spectral action of this almost commutative spectral triple reduced to the finite part is a functional on the vector space of all fluctuated, finite Dirac operators,

$$V({}^f\mathcal{D}) = \lambda \text{tr}[({}^f\mathcal{D})^4] - \frac{\mu^2}{2} \text{tr}[({}^f\mathcal{D})^2],$$

where  $\lambda$  and  $\mu$  are positive constants.<sup>1,9</sup> Our task is to find the minima  $\hat{{}^f}\mathcal{D}$  of this action and their spectra.

To classify the almost commutative spectral triples we will impose some extra conditions as in Ref. 8. We will require the spectral triples to be irreducible and nondegenerate according to the following definitions.

*Definition 2.1:* (i) A spectral triple  $(\mathcal{A}, \mathcal{H}, \mathcal{D})$  is *degenerate* if the kernel of  $\mathcal{D}$  contains a nontrivial subspace of the complex Hilbert space  $\mathcal{H}$  invariant under the representation  $\rho$  on  $\mathcal{H}$  of the real algebra  $\mathcal{A}$ .

(ii) A nondegenerate spectral triple  $(\mathcal{A}, \mathcal{H}, \mathcal{D})$  is *reducible* if there is a proper subspace  $\mathcal{H}_0 \subset \mathcal{H}$  invariant under the algebra  $\rho(\mathcal{A})$  such that  $(\mathcal{A}, \mathcal{H}_0, \mathcal{D}|_{\mathcal{H}_0})$  is a nondegenerate spectral triple. If the triple is real,  $S^0$ -real and even, we require the subspace  $\mathcal{H}_0$  to also be invariant under the real structure  $J$ , the  $S^0$ -real structure  $\epsilon$  and under the chirality  $\chi$  such that the triple  $(\mathcal{A}, \mathcal{H}_0, \mathcal{D}|_{\mathcal{H}_0})$  is again real,  $S^0$ -real and even.

*Definition 2.2:* The irreducible spectral triple  $(\mathcal{A}, \mathcal{H}, \mathcal{D})$  is *dynamically nondegenerate* if all minima  $\hat{{}^f}\mathcal{D}$  of the action  $V({}^f\mathcal{D})$  define a nondegenerate spectral triple  $(\mathcal{A}, \mathcal{H}, \hat{{}^f}\mathcal{D})$  and if the spectra of all minima have no degeneracies other than the three kinematical degeneracies: left–right, particle–antiparticle, and color. Of course in the massless case there is no left–right degeneracy. We also suppose that the color degeneracies are protected by the little group. By this we mean that all eigenvectors of  $\hat{{}^f}\mathcal{D}$  corresponding to the same eigenvalue are in a common orbit of the little group (and scalar multiplication and charge conjugation).

In physicists' language nondegeneracy excludes all models with pairwise equal fermion masses up to color degeneracy. Irreducibility tells us that the Krajewski diagrams, which we must find must not contain more arrows than strictly necessary to satisfy Connes' axioms, especially the Poincaré duality. The last requirement of Definition 2.2 means noncommutative color groups are unbroken. It ensures that the corresponding mass degeneracies are protected from quantum corrections.

### III. THE MISSING DIAGRAMS

In this section we will present the diagrams missing in the proof for three algebras in Ref. 8. For every diagram only one representative model will be given. All the other models can be obtained by simply exchanging left with right and particles with antiparticles. On the diagrammatic side this is equivalent to changing the directions of all arrows or reflecting the diagram on its diagonal. Permutations of the algebras in the diagrams are neglected as well, since they lead to the same physical models with a different order of the particles. For every diagram there are several ways to connect the algebras by arrows in accordance with the consistency conditions of Table 1 in Ref. 6. With respect to this, the four diagrams are all computed in the same way and they all fall in the same way. The possibilities of complex conjugating an algebra representation are limited and yield no essentially new models. It should be obvious from the diagrams whether the matrix algebras are complex, real, or quaternionic. In all other cases the choice of the field will

not affect the calculations, so we will not specify the algebras explicitly. For the four missing diagrams,  $\mathcal{A}_1, \mathcal{A}_2, \mathcal{A}_3$  denote the algebras,  $a, b, c$  their generic elements and  $k, \ell, p$  the respective size of the matrices.

Diagram 1 yields the representation

$$\rho_L(a,b,c) = \begin{pmatrix} b \otimes 1_k & 0 & 0 \\ 0 & c \otimes 1_k & 0 \\ 0 & 0 & b \otimes 1_p \end{pmatrix}, \quad \rho_R(a,b,c) = \begin{pmatrix} \bar{a} \otimes 1_k & 0 & 0 \\ 0 & \bar{b} \otimes 1_k & 0 \\ 0 & 0 & a \otimes 1_p \end{pmatrix},$$

$$\rho_L^c(a,b,c) = \begin{pmatrix} 1_\ell \otimes a & 0 & 0 \\ 0 & 1_p \otimes a & 0 \\ 0 & 0 & 1_\ell \otimes \bar{c} \end{pmatrix}, \quad \rho_R^c(a,b,c) = \begin{pmatrix} 1_k \otimes a & 0 & 0 \\ 0 & 1_\ell \otimes a & 0 \\ 0 & 0 & 1_p \otimes \bar{c} \end{pmatrix}.$$

The mass matrix is

$$\mathcal{M} = \begin{pmatrix} M_1 \otimes 1_k & 0 & 0 \\ 0 & M_2 \otimes 1_k & 0 \\ 0 & 0 & M_3 \otimes 1_p \end{pmatrix}, \quad M_1, M_3 \in M_{k \times \ell}(\mathbb{C}), \quad M_2 \in M_{p \times \ell}(\mathbb{C}),$$

where all three algebras are  $M_n(\mathbb{C})$ . The fluctuations are

$${}^f M_1 = \sum_j r_j v_j M_1 \bar{u}_j^{-1}, \quad u_j \in U(\mathcal{A}_1), \quad v_j \in U(\mathcal{A}_2),$$

$${}^f M_2 = \sum_j r_j w_j M_2 \bar{v}_j^{-1}, \quad w_j \in U(\mathcal{A}_3),$$

$${}^f M_3 = \sum_j r_j v_j M_3 u_j^{-1},$$

and the action  $V(C_1, C_2, C_3)$  is, with  $C_i := {}^f M_i^* {}^f M_i$  equal to

$$4k \left[ \lambda \operatorname{tr}(C_1)^2 - \frac{1}{2} \mu^2 \operatorname{tr}(C_1) \right] + 4k \left[ \lambda \operatorname{tr}(C_2)^2 - \frac{1}{2} \mu^2 \operatorname{tr}(C_2) \right] + 4p \left[ \lambda \operatorname{tr}(C_3)^2 - \frac{1}{2} \mu^2 \operatorname{tr}(C_3) \right].$$

Counting neutrinos and imposing broken color to be commutative leaves only one case,  $k = \ell = p = 1$ . The fluctuations decouple the  ${}^f M_i$  so it is always possible to reach the absolute minimum of the Higgs potential and the triple is degenerate.

Diagram 2 falls in the same way.

Diagram 3 is degenerate in the commutative case and exhibits mass relations in the noncommutative case. The calculation runs along the lines of diagram 8 in Ref. 8.

Diagram 4 yields the representation

$$\rho_L(a,b,c) = \begin{pmatrix} c \otimes 1_k & 0 \\ 0 & a \otimes 1_\ell \end{pmatrix}, \quad \rho_R(a,b,c) = \begin{pmatrix} \bar{b} \otimes 1_k & 0 & 0 \\ 0 & \bar{b} \otimes 1_k & 0 \\ 0 & 0 & c \otimes 1_\ell \end{pmatrix},$$

$$\rho_L^c(a,b,c) = \begin{pmatrix} 1_p \otimes a & 0 \\ 0 & 1_k \otimes b \end{pmatrix}, \quad \rho_R^c(a,b,c) = \begin{pmatrix} 1_\ell \otimes a & 0 & 0 \\ 0 & 1_\ell \otimes a & 0 \\ 0 & 0 & 1_p \otimes b \end{pmatrix},$$

with possible complex conjugations here and there. The mass matrix is

$$\mathcal{M} = \begin{pmatrix} M_1 \otimes 1_k & M_2 \otimes 1_k & 0 \\ 0 & 0 & M_3 \otimes 1_\ell \end{pmatrix}, \quad M_1, M_2 \in M_{p \times \ell}(\mathbb{C}), \quad M_3 \in M_{k \times p}(\mathbb{C}).$$

The fluctuations are

$${}^f M_1 = \sum_j r_j w_j M_1 \bar{v}_j^{-1}, \quad w_j \in U(\mathcal{A}_3), \quad v_j \in U(\mathcal{A}_2),$$

$${}^f M_2 = \sum_j r_j w_j M_2 \bar{v}_j^{-1},$$

$${}^f M_3 = \sum_j r_j u_j M_3 w_j^{-1}, \quad u_j \in U(\mathcal{A}_1),$$

and the action is

$$V(C_1, C_2, C_3) = 4k \left[ \lambda \operatorname{tr}(C_1 + C_2)^2 - \frac{1}{2} \mu^2 \operatorname{tr}(C_1 + C_2) \right] + 4p \left[ \lambda \operatorname{tr}(C_3)^2 - \frac{1}{2} \mu^2 \operatorname{tr}(C_3) \right].$$

The neutrino count and broken color imply  $k = \ell = 1$  and  $p = 1$  or  $p = 2$ . The case  $k = \ell = p = 1$  is obviously degenerate.

For  $k = \ell = 1$ ,  $p = 2$  we have one neutrino.  ${}^f M_3$  fluctuates independently and can be pushed into the absolute minimum of the Higgs potential. Let us set  ${}^f M_1$  and  ${}^f M_2$  into one matrix

$${}^f M_{1,2} = \sum_j r_j w_j (M_1, M_2) \begin{pmatrix} \bar{v}_j^{-1} & 0 \\ 0 & \bar{v}_j^{-1} \end{pmatrix}.$$

Since the  $\bar{v}_j^{-1} \in \mathbb{C}$  they commute with  $(M_1, M_2)$  and so

$${}^f M_{1,2} = C(M_1, M_2),$$

where  $C \in M_{2 \times 2}(\mathbb{C})$  is an arbitrary matrix.  $M_1$  must be linearly independent of  $M_2$  because otherwise they would produce a second neutrino. It follows that  $(M_1, M_2)$  is invertible and we can choose  $C$  to be its inverse. In this way we reach the absolute minimum of the Higgs potential and the triple is degenerate.

#### IV. CONCLUSION

The new models discovered with help of the computer complete the proof for up to three algebras given in Ref. 8. We did not find anything of interest from the particle physics point of view but we gained confidence in our algorithm and it seems sensible to compute the case with four algebras.

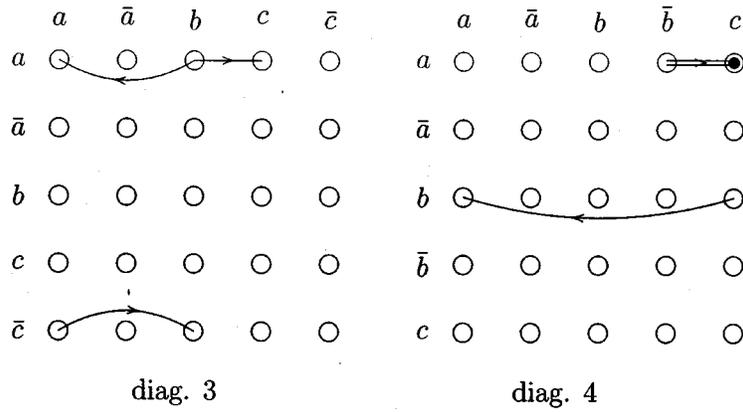
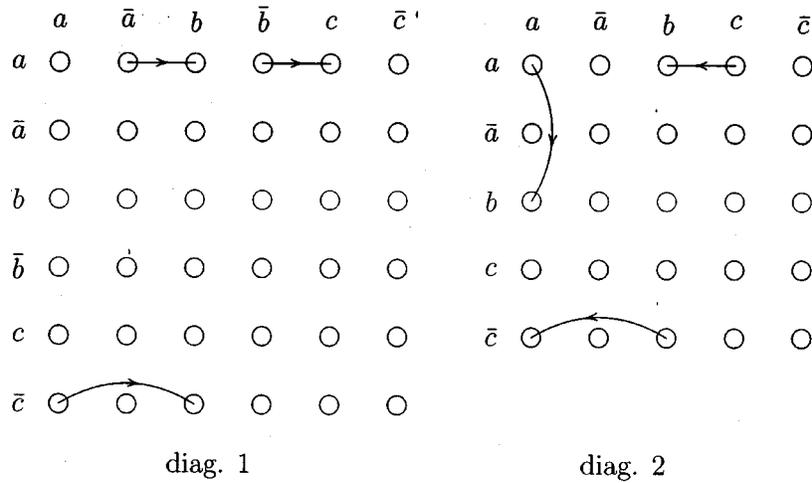

**ACKNOWLEDGMENTS**

The authors thank T. Schücker for his advice and support. The authors gratefully acknowledge the Friedrich–Ebert–Stiftung fellowships.

<sup>1</sup>A. Chamseddine and A. Connes, *Commun. Math. Phys.* **182**, 155 (1996).  
<sup>2</sup>A. Connes, *Noncommutative Geometry* (Academic, London, San Diego, 1994).  
<sup>3</sup>A. Connes, *J. Math. Phys.* **36**, 6194 (1995).  
<sup>4</sup>A. Connes, *Commun. Math. Phys.* **155**, 109 (1996).  
<sup>5</sup>A. Connes and J. Lott, *Nucl. Phys. B* **18**, 29 (1990); “The metric aspect of noncommutative geometry,” in *Proceedings of the 1991 Cargèse Summer Conference*, edited by J. Fröhlich *et al.* (Plenum, New York, 1992).  
<sup>6</sup>T. Krajewski, *J. Geom. Phys.* **28**, 1 (1998).  
<sup>7</sup>M. Paschke and A. Sitarz, *J. Math. Phys.* **39**, 6191 (1998).  
<sup>8</sup>B. Iochum, T. Schücker, and C. Stephan, *J. Math. Phys.* (to be published).  
<sup>9</sup>T. Krajewski, (unpublished).

## On a classification of irreducible almost commutative geometries. III

Jan-Hendrik Jureit<sup>a)</sup> and Christoph Stephan<sup>b)</sup>

*Centre de Physique Théorique, CNRS-Luminy, Case 907, 13288 Marseille Cedex 9, France; Université de Provence; and Universität Kiel*

Thomas Schücker<sup>c)</sup>

*Centre de Physique Théorique, CNRS-Luminy, Case 907, 13288 Marseille Cedex 9, France; Université de Provence*

(Received 4 April 2005; accepted 11 May 2005; published online 1 July 2005)

We extend a classification of irreducible, almost commutative geometries whose spectral action is dynamically nondegenerate to internal algebras that have four simple summands. © 2005 American Institute of Physics.

[DOI: 10.1063/1.1946527]

### I. INTRODUCTION

A Yang-Mills-Higgs model is specified by choosing a real compact Lie group describing the gauge bosons and three unitary representations describing the left- and right-handed fermions and the Higgs scalars. Connes<sup>1</sup> remarks that the set of all Yang-Mills-Higgs models comes in two classes, Fig. 1. The first is tiny and contains all those models that derive from gravity by generalizing Riemannian to almost commutative geometry. The intersections of this tiny class with the classes of left-right symmetric, grand unified, or supersymmetric Yang-Mills-Higgs models are all empty. However, the tiny class does contain the standard model of electromagnetic, weak, and strong forces with an arbitrary number of colors.

The first class is tiny, but still infinite and difficult to assess. We have started putting some order into this class. The criteria we apply are heteroclitic.<sup>2</sup>

Two criteria are simply motivated by simplicity: we take the internal algebra to be simple, or with two, three, ... simple summands, we take the internal triple to be irreducible.

Two criteria are motivated from perturbative quantum field theory of the nongravitational part in flat time space: vanishing Yang-Mills anomalies and dynamical nondegeneracy. The latter imposes that the number of possible fermion mass equalities be restricted to the minimum, and that they be stable under renormalization flow. The origin of these mass equalities is the following. In almost commutative geometry, the fermionic mass matrix is the “Riemannian metric” of internal space, and as such becomes a dynamical variable. Its “Einstein equation” is the requirement that the fermionic mass matrix minimize the Higgs potential. Indeed, in almost commutative geometry, the Higgs potential is the “Einstein-Hilbert action” of internal space.

Two criteria are motivated from particle phenomenology: We want the fermion representation to be complex under the little group in each of its irreducible components, because we want to distinguish particles from antiparticles by means of unbroken charges. We want possible massless fermions to remain neutral under the little group, i.e., not to couple to massless gauge bosons.

Two criteria are motivated from the hope that, one day, we will have a unified quantum theory of all forces: vanishing mixed gravitational Yang-Mills anomalies and again dynamical nondegeneracy.

---

<sup>a)</sup>Electronic mail: jureit@cpt.univ-mrs.fr>

<sup>b)</sup>Electronic mail: Stephan@cpt.univ-mrs.fr

<sup>c)</sup>Electronic mail: schucker@cpt.univ-mrs.fr

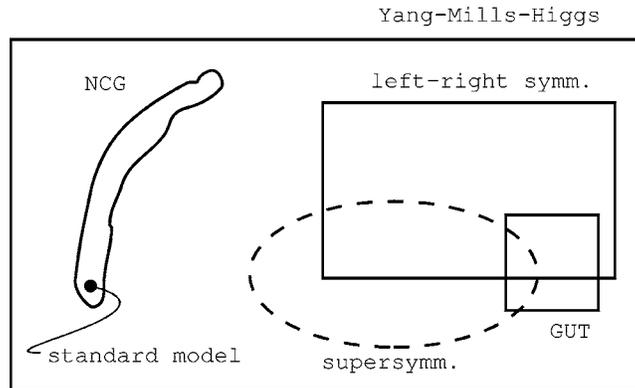

FIG. 1. Pseudoforces from noncommutative geometry.

Our analysis is based on a classification of all finite spectral triples by means of Krajewski diagrams<sup>3</sup> and centrally extended spin lifts of the automorphism group of their algebras.<sup>4</sup> The central extension serves two purposes: (i) It makes the spin lift of complex algebras  $M_n(\mathbb{C})$  well defined. (ii) It allows the corresponding  $U(n)$  anomalies to cancel.

Of course, we started with the case of a simple internal algebra. Here, there is only one contracted, irreducible Krajewski diagram and all induced Yang-Mills-Higgs models are dynamically degenerate.

The second case concerns algebras with two simple summands. It admits three contracted, irreducible Krajewski diagrams, one of them being a direct sum of two diagrams from the first case. The corresponding triples induce two Yang-Mills-Higgs models which are dynamically non-degenerate and anomaly free:  $SU(2)$  with a doublet of left-handed fermions and a singlet of right-handed fermions. The Higgs scalar is a doublet. Therefore, the little group is trivial,  $SU(2) \rightarrow \{1_2\}$ , and the fermion representation is real under the little group. The second model is the  $SO(2)$  submodel of the first.

The case of three summands has 41 contracted, irreducible diagrams plus direct sums. Its combinatorics is on the limit of what we can handle without a computer. There are only four induced models satisfying all criteria: The first is the standard model with  $C$  colors,  $C \geq 2$ ,  $SU(2) \times U(1) \times SU(C)$ , with one generations of leptons and quarks and one colorless  $SU(2)$  doublet of scalars. The three others are submodels,  $SO(2) \times U(1) \times SU(C)$ ,  $SU(2) \times U(1) \times SO(C)$ , and  $SU(2) \times U(1) \times USp(C/2)$  and must have  $C \geq 2$ ; the last submodel of course requires  $C$  even,  $C \geq 4$ .

In the following we push our classification to four summands. For simplicity we will only consider diagrams made of letter-changing arrows, i.e., we exclude arrows of type  $a\bar{a}$  because, in the first three cases, these arrows always produced degeneracy. When the algebra is simple, of course all arrows are of this type and all models were degenerate. All direct sum diagrams in cases 2 and 3 necessarily contain such arrows. For two summands, there is only one contracted, irreducible diagram, which is not a direct sum and which is made of letter changing arrows; for three summands there are 30 such diagrams.

For four summands, a well-educated computer<sup>5</sup> tells us that there are 22 contracted, irreducible diagrams made of letter-changing arrows and which are not direct sums. They are shown in Fig. 2. We have two pleasant surprises: (i) the number of these diagrams is small; (ii) there are only two ladder diagrams, diagrams 18 and 19, i.e., diagrams with vertically aligned arrows, and all other diagrams have no subdiagrams of ladder form. We will see that these other diagrams are easily dealt with.

## II. STATEMENT OF THE RESULT

Consider a finite, real,  $S^0$ -real, irreducible spectral triple whose algebra has four simple summands and the extended lift as described in Ref. 4. Consider the list of all Yang-Mills-Higgs models induced by these triples and lifts. Discard all models that have either

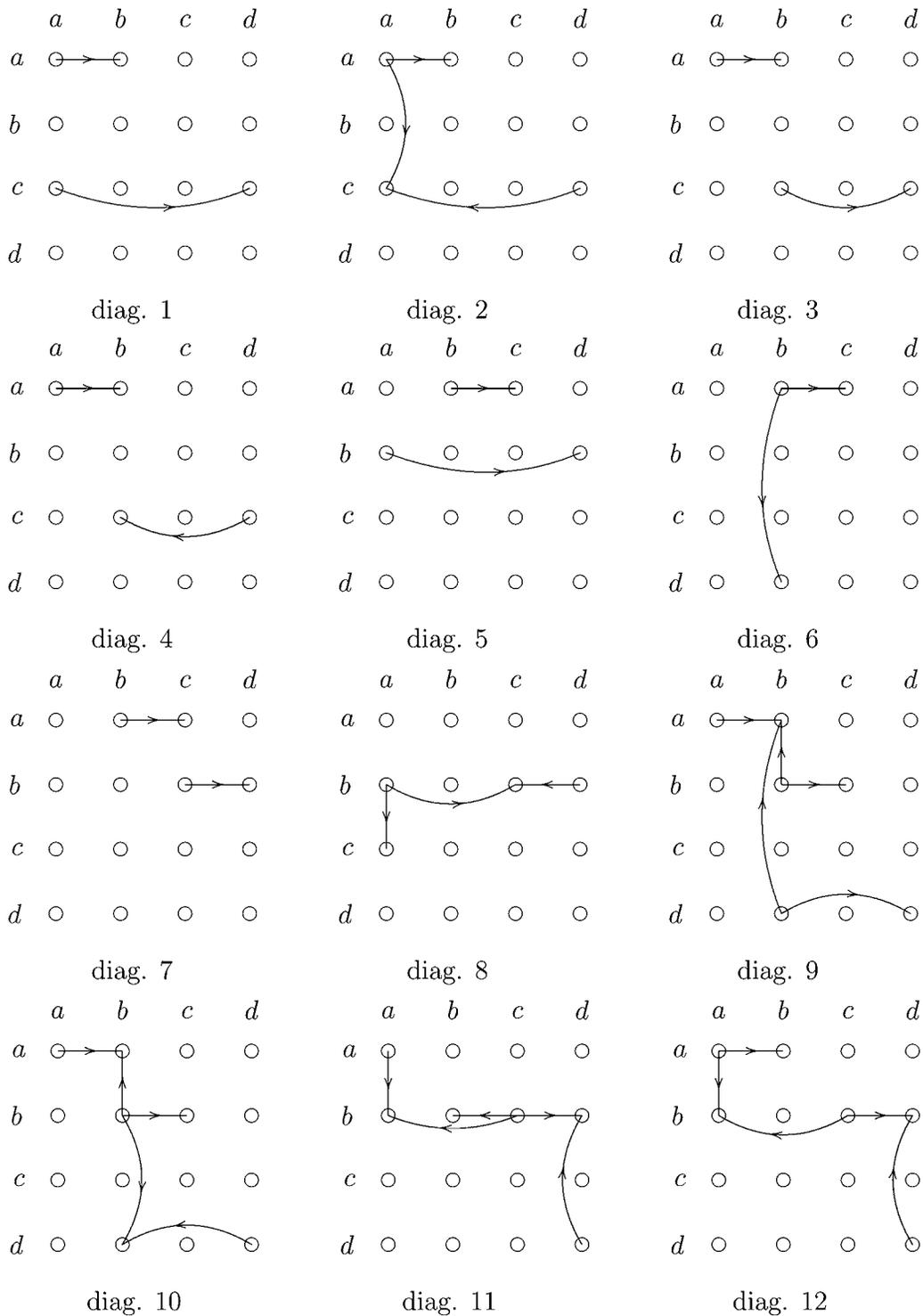
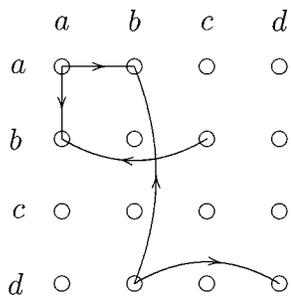
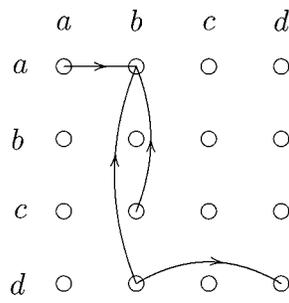

FIG. 2. Four simple summands produce 22 contracted, irreducible diagrams made of letter changing arrows and which are not direct sums.

- (i) a dynamically degenerate fermionic mass spectrum;
- (ii) Yang-Mills or gravitational anomalies;
- (iii) a fermion multiplet whose representation under the little group is real or pseudoreal,



diag. 13



diag. 14

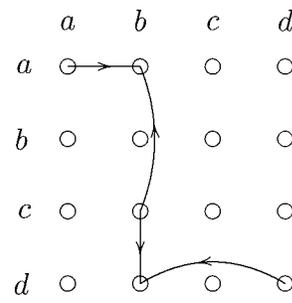

diag. 15

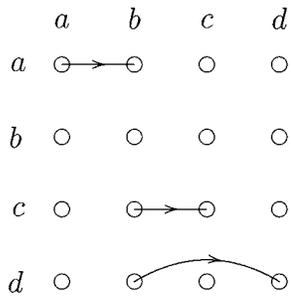

diag. 16

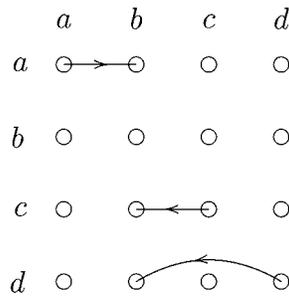

diag. 17

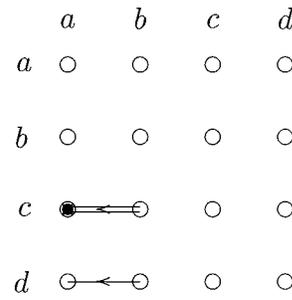

diag. 18

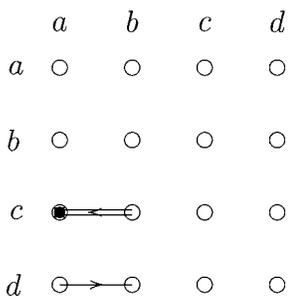

diag. 19

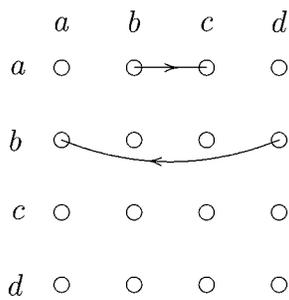

diag. 20

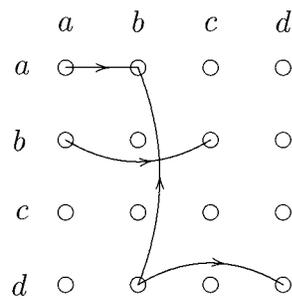

diag. 21

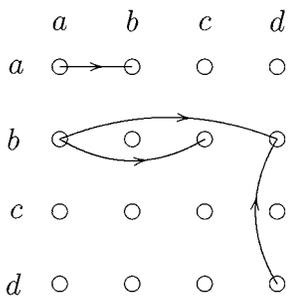

diag. 22

FIG. 2. (Continued).

(iv) or a massless fermion transforming nontrivially under the little group.

The remaining models are the following:  $C$  is the number of colors, the gauge group is on the left-hand side of the arrow, the little group on the right-hand side

$C=3, 5\dots$

$$\frac{\mathrm{SU}(2) \times \mathrm{U}(1) \times \mathrm{SU}(C)}{\mathbb{Z}_2 \times \mathbb{Z}_C} \rightarrow \frac{\mathrm{U}(1) \times \mathrm{SU}(C)}{\mathbb{Z}_C}.$$

The left-handed fermions transform according to a multiplet  $\underline{2} \otimes \underline{C}$  with hypercharge  $q/(2C)$  and a multiplet  $\underline{C}$  with hypercharge  $-q/2$ . The right-handed fermions sit in two multiplets  $\underline{C}$  with hypercharges  $q(1+C)/(2C)$  and  $q(1-C)/(2C)$  and one singlet with hypercharge  $-q$ ,  $q \in \mathbb{Q}$ . The elements in  $\mathbb{Z}_2 \times \mathbb{Z}_C$  are embedded in the center of  $\mathrm{SU}(2) \times \mathrm{U}(1) \times \mathrm{SU}(C)$  as

$$\left( \exp \frac{2\pi i k}{2} 1_2, \exp[2\pi i(Ck - 2\ell)/q], \exp \frac{2\pi i \ell}{C} 1_p \right), \quad k=0,1, \quad \ell=0,1,\dots,C-1.$$

The Higgs scalar transforms as an  $\mathrm{SU}(2)$  doublet,  $\mathrm{SU}(C)$  singlet and has hypercharge  $-q/2$ .

With the number of colors  $C=3$ , this is the standard model with one generation of quarks and leptons.

We also have in our list two submodels of the above model defined by the subgroups

$$\frac{\mathrm{SO}(2) \times \mathrm{U}(1) \times \mathrm{SU}(C)}{\mathbb{Z}_2 \times \mathbb{Z}_C} \rightarrow \frac{\mathrm{U}(1) \times \mathrm{SU}(C)}{\mathbb{Z}_C},$$

$$\frac{\mathrm{SU}(2) \times \mathrm{U}(1) \times \mathrm{SO}(C)}{\mathbb{Z}_2} \rightarrow \mathrm{U}(1) \times \mathrm{SO}(C).$$

They have the same particle content as the standard model; in the first case only the  $W^\pm$  bosons are missing, in the second case roughly half the gluons are lost.

$C=2, 4\dots$

$$\frac{\mathrm{SU}(2) \times \mathrm{U}(1) \times \mathrm{SU}(C)}{\mathbb{Z}_C} \rightarrow \frac{\mathrm{U}(1) \times \mathrm{SU}(C)}{\mathbb{Z}_C},$$

with the same particle content as for odd  $C$ . But, now we have three possible submodels

$$\frac{\mathrm{SO}(2) \times \mathrm{U}(1) \times \mathrm{SU}(C)}{\mathbb{Z}_C} \rightarrow \frac{\mathrm{U}(1) \times \mathrm{SU}(C)}{\mathbb{Z}_C},$$

$$\mathrm{SU}(2) \times \mathrm{U}(1) \times \mathrm{SO}(C) \rightarrow \mathrm{U}(1) \times \mathrm{SO}(C),$$

$$\frac{\mathrm{SU}(2) \times \mathrm{U}(1) \times \mathrm{USp}(C/2)}{\mathbb{Z}_2} \rightarrow \frac{\mathrm{U}(1) \times \mathrm{USp}(C/2)}{\mathbb{Z}_2}.$$

### electro-strong

$$\mathrm{U}(1) \times \mathrm{SU}(C) \rightarrow \mathrm{U}(1) \times \mathrm{SU}(C).$$

The fermionic content is  $\underline{C} \oplus \underline{1}$ , one quark and one charged lepton. The two fermion masses are arbitrary but different and nonvanishing. The number of colors is greater than or equal to 2, the two charges are arbitrary but vectorlike; of course the lepton charge must not vanish. There is no scalar and no symmetry breaking.

### III. DIAGRAM BY DIAGRAM

We will use the following letters to denote algebra elements and unitaries: Let  $\mathcal{A}=M_A(\mathbb{C}) \oplus M_B(\mathbb{C}) \oplus M_C(\mathbb{C}) \oplus M_D(\mathbb{C}) \ni (a, b, c, d)$ . The extended lift is defined by

$$L(u, v, w, z) := \rho(\hat{u}, \hat{v}, \hat{w}, \hat{z}) J \rho(\hat{u}, \hat{v}, \hat{w}, \hat{z}) J^{-1}, \quad (1)$$

with

$$\hat{u} := u(\det u)^{q_{11}}(\det v)^{q_{12}}(\det w)^{q_{13}}(\det z)^{q_{14}} \in U(A), \quad (2)$$

$$\hat{v} := v(\det u)^{q_{21}}(\det v)^{q_{22}}(\det w)^{q_{23}}(\det z)^{q_{24}} \in U(B), \quad (3)$$

$$\hat{w} := w(\det u)^{q_{31}}(\det v)^{q_{32}}(\det w)^{q_{33}}(\det z)^{q_{34}} \in U(C), \quad (4)$$

$$\hat{z} := z(\det u)^{q_{41}}(\det v)^{q_{42}}(\det w)^{q_{43}}(\det z)^{q_{44}} \in U(D), \quad (5)$$

and unitaries  $(u, v, w, z) \in U(M_A(\mathbb{C}) \oplus M_B(\mathbb{C}) \oplus M_C(\mathbb{C}) \oplus M_D(\mathbb{C}))$ . It is understood that, for instance, if  $A=1$  we set  $u=1$  and  $q_{j1}=0$ ,  $j=1, 2, 3, 4$ . If  $M_A(\mathbb{C})$  is replaced by  $M_A(\mathbb{R})$  or  $M_{A/2}(\mathbb{H})$ , we set  $q_{j1}=0$  and  $q_{1j}=0$ .

**Diagram 1** yields

$$\begin{aligned} \rho_L &= \begin{pmatrix} b \otimes 1_A & 0 \\ 0 & d \otimes 1_C \end{pmatrix}, & \rho_R &= \begin{pmatrix} a \otimes 1_A & 0 \\ 0 & \alpha_a \otimes 1_C \end{pmatrix}, \\ \rho_L^c &= \begin{pmatrix} 1_B \otimes \alpha' a & 0 \\ 0 & 1_D \otimes c \end{pmatrix}, & \rho_R^c &= \begin{pmatrix} 1_A \otimes \alpha' a & 0 \\ 0 & 1_A \otimes c \end{pmatrix}, \end{aligned} \quad (6)$$

and

$$\mathcal{M} = \begin{pmatrix} M_1 \otimes 1_A & 0 \\ 0 & M_2 \otimes 1_C \end{pmatrix}, \quad M_1 \in M_{B \times A}(\mathbb{C}), \quad M_2 \in M_{D \times A}(\mathbb{C}). \quad (7)$$

The parameters  $\alpha$  and  $\alpha'$  take values  $\pm 1$  and distinguish between fundamental representation and its complex conjugate:  ${}^1 a := a$ ,  ${}^{-1} a := \bar{a}$ . The color algebras consist of  $a$ 's and  $c$ 's. The  $a$ 's are broken and therefore we must have  $A=1$ . We want at most one massless Weyl fermion, which leaves us with three possibilities. The first is  $B=2$ ,  $D=1$ . The fluctuations read

$$\varphi_1 = \sum_j r_j \hat{v}_j M_1 \hat{u}_j^{-1}, \quad \varphi_2 = \sum_j r_j \hat{z}_j M_2 \alpha \hat{u}_j^{-1}. \quad (8)$$

We can decouple the two scalars  $\varphi_1$  and  $\varphi_2$  by means of the fluctuation:  $r_1 = \frac{1}{2}$ ,  $\hat{u}_1 = 1$ ,  $\hat{v}_1 = 1_2$ ,  $\hat{w}_1 = 1_C$ ,  $\hat{z}_1 = 1$ ,  $r_2 = \frac{1}{2}$ ,  $\hat{u}_2 = 1$ ,  $\hat{v}_2 = -1_2$ ,  $\hat{w}_2 = 1_C$ ,  $\hat{z}_2 = 1$ . Since the arrows  $M_1$  and  $M_2$  are disconnected, the Higgs potential is a sum of a potential in  $\varphi_1$  and of a potential in  $\varphi_2$ . The minimum is  $\hat{\varphi}_1 = \mu(4\lambda)^{-1/2} \begin{pmatrix} 1 \\ 0 \end{pmatrix}$  and  $\hat{\varphi}_2 = \mu(4\lambda)^{-1/2}$ , and the model is dynamically degenerate.

The same accidents happen for the second possibility,  $B=1$ ,  $D=2$ . We are left with the third possibility,  $B=D=1$ . Anomaly cancellations imply that the fermion couplings are vectorial:  $q_{13} = q_{23}$ ,  $q_{43} = \alpha q_{13}$ , and there is no spontaneous symmetry breaking,  $SU(C) \times U(1) \rightarrow SU(C) \times U(1)$ . The model describes electro-strong forces with one charged lepton, one quark, and no scalar. The masses of both fermions are arbitrary but nonvanishing, the electric charges are arbitrary, nonvanishing for the lepton, and the number of colors  $C$  is arbitrary,  $C \geq 2$ .

**Diagrams 3, 4, and 7** are treated in the same way and produce only the electro-strong model.

**Diagram 2** yields

$$\rho_L = \begin{pmatrix} b \otimes 1_A & 0 \\ 0 & \alpha_a \otimes 1_C \end{pmatrix}, \quad \rho_R = \begin{pmatrix} a \otimes 1_A & 0 \\ 0 & d \otimes 1_C \end{pmatrix}, \quad (9)$$

$$\rho_L^c = \begin{pmatrix} 1_B \otimes \alpha' a & 0 \\ 0 & 1_A \otimes c \end{pmatrix}, \quad \rho_R^c = \begin{pmatrix} 1_A \otimes \alpha' a & 0 \\ 0 & 1_D \otimes c \end{pmatrix},$$

and

$$\mathcal{M} = \begin{pmatrix} M_1 \otimes 1_A & 0 \\ 1_A \otimes M_3 & M_2 \otimes 1_C \end{pmatrix}, \quad M_1 \in M_{B \times A}(\mathbb{C}), \quad M_2 \in M_{A \times D}(\mathbb{C}), \quad M_3 \in M_{C \times A}(\mathbb{C}). \quad (10)$$

If  $M_3=0$  diagram 2 is treated as diagram 1. We consider the case  $M_3 \neq 0$ . Then, the first-order axiom implies  $\alpha=1$ . The color algebras consist of  $a$ 's and  $c$ 's. Both are broken and we take  $A=C=1$ . Then,  $\mathcal{M}$  is of rank two or less. If we want at most one massless Weyl fermion, we must take  $B=2$  and  $D=1$  or  $B=1$  and  $D=2$ . Anomaly cancellations then imply that the doublet of fermions does not couple to the determinant of the  $2 \times 2$  unitary, "the hypercharge of the doublet is zero." On the other hand, the little group turns out either trivial or  $U(1)$ . In the latter case the neutrino sitting in the doublet is charged under this  $U(1)$ .

**Diagram 5** has no unbroken color and fails as the first possibility of diagram 1,  $B=2, D=1$ .

**Diagram 6** has color  $a$  and  $b$ ; both are broken, implying  $A=B=1$ . Then, we must have  $C=D=1$  to avoid two or more neutrinos.

**Diagram 8** yields

$$\rho_L = \begin{pmatrix} a \otimes 1_C & 0 \\ 0 & c \otimes 1_B \end{pmatrix}, \quad \rho_R = \begin{pmatrix} a \otimes 1_A & 0 \\ 0 & d \otimes 1_C \end{pmatrix}, \quad (11)$$

$$\rho_L^c = \begin{pmatrix} 1_A \otimes \gamma c & 0 \\ 0 & 1_C \otimes b \end{pmatrix}, \quad \rho_R^c = \begin{pmatrix} 1_A \otimes b & 0 \\ 0 & 1_D \otimes b \end{pmatrix},$$

and

$$\mathcal{M} = \begin{pmatrix} 1_A \otimes M_1 & 0 \\ M_3 \otimes 1_B & M_2 \otimes 1_B \end{pmatrix}, \quad M_1 \in M_{C \times B}(\mathbb{C}), \quad M_2 \in M_{C \times D}(\mathbb{C}), \quad M_3 \in M_{C \times A}(\mathbb{C}). \quad (12)$$

We suppose that  $M_3$  does not vanish; otherwise, diagram 8 is treated as diagram 1. Broken color implies  $A=B=1$ . Neutrino counting leaves two possibilities,  $C=1$  and  $D=2$  or  $C=D=2$ . The first possibility is disposed of as in diagram 2. For the second possibility, anomaly cancellations imply that the determinants of the  $2 \times 2$  unitaries  $w$  and  $z$  do not couple to the right-handed fermions.

**Diagrams 14, 15, 16,** and **17** share the fate of diagram 6.

**Diagram 9** yields

$$\rho_L = \begin{pmatrix} b \otimes 1_A & 0 & 0 \\ 0 & c \otimes 1_B & 0 \\ 0 & 0 & d \otimes 1_D \end{pmatrix}, \quad \rho_R = \begin{pmatrix} a \otimes 1_A & 0 & 0 \\ 0 & \beta_1 b \otimes 1_B & 0 \\ 0 & 0 & \beta_2 b \otimes 1_D \end{pmatrix}, \quad (13)$$

$$\rho_L^c = \begin{pmatrix} 1_B \otimes \alpha' a & 0 & 0 \\ 0 & 1_C \otimes \beta' b & 0 \\ 0 & 0 & 1_D \otimes \delta' d \end{pmatrix}, \quad \rho_R^c = \begin{pmatrix} 1_A \otimes \alpha' a & 0 & 0 \\ 0 & 1_B \otimes \beta' b & 0 \\ 0 & 0 & 1_B \otimes \delta' d \end{pmatrix},$$

and

$$\mathcal{M} = \begin{pmatrix} M_1 \otimes 1_A & 1_B \otimes M_4 & 1_B \otimes M_5 \\ 0 & M_2 \otimes 1_B & 0 \\ 0 & 0 & M_3 \otimes 1_D \end{pmatrix},$$

with  $M_1 \in M_{B \times A}(\mathbb{C})$ ,  $M_2 \in M_{C \times D}(\mathbb{C})$ ,  $M_3 \in M_{D \times B}(\mathbb{C})$ ,  $M_4 \in M_{A \times B}(\mathbb{C})$ ,  $M_5 \in M_{A \times D}(\mathbb{C})$ . If  $M_4$  is nonzero  $\beta_1$  must be 1, and if  $M_5$  is nonzero  $\beta_2$  must be 1. From broken color and neutrino counting, we have  $A=B=D=1$  and  $C=2$ . Vanishing anomalies imply that the first and the third fermion have vectorlike hypercharges, while the hypercharges of the second fermion are zero. It is therefore neutral under the little group  $U(1)$ .

**Diagrams 10, 11, 12, and 13** fail in the same way.

**Diagram 18** produces the following triple:

$$\rho_L = \begin{pmatrix} a \otimes 1_C & 0 \\ 0 & \alpha a \otimes 1_D \end{pmatrix}, \quad \rho_R = \begin{pmatrix} b \otimes 1_C & 0 & 0 \\ 0 & \beta_1 \bar{b} \otimes 1_C & 0 \\ 0 & 0 & \beta_2 \bar{b} \otimes 1_D \end{pmatrix},$$

$$\rho_L^c = \begin{pmatrix} 1_A \otimes c & 0 \\ 0 & 1_A \otimes d \end{pmatrix}, \quad \rho_R^c = \begin{pmatrix} 1_B \otimes c & 0 & 0 \\ 0 & 1_B \otimes c & 0 \\ 0 & 0 & 1_B \otimes d \end{pmatrix},$$

and

$$\mathcal{M} = \begin{pmatrix} M_1 \otimes 1_C & M_2 \otimes 1_C & 0 \\ 0 & 0 & M_3 \otimes 1_D \end{pmatrix}, \quad M_1, M_2, M_3 \in M_{A \times B}(\mathbb{C}). \quad (14)$$

Counting neutrinos leaves two possibilities,  $A=2$  and  $B=1$ , or  $A=1$  and  $B=1$ . If the neutrino is to be neutral under the little group, we must have  $D=1$  for the first possibility and  $C=1$  for the second.

The first possibility has two  $U(1)$ 's if  $C \geq 2$  and all four algebras consist of matrices with complex entries. They are parametrized by  $\det u$  and by  $\det w$ . For  $(\alpha, \beta_1, \beta_2) = +++$ ,  $++-$ ,  $++-$ , and  $-+-$ , anomaly cancellations imply that the fermionic hypercharges of both  $U(1)$ 's are proportional

$$q_{11} = -\frac{1}{2}, \quad q_{21} = Cp, \quad q_{31} = p, \quad q_{41} = -Cp, \quad (15)$$

$$q_{13} = 0, \quad q_{23} = Cq, \quad q_{33} = q - \frac{1}{C}, \quad q_{43} = -Cq, \quad (16)$$

with  $p, q \in \mathbb{Q}$ . Consequently, one linear combination of the two generators decouples from the fermions and is absent from the spectral action. This is similar to what happens to the scalar in the electro-strong model of diagram 1. The hypercharges of the remaining generator are those of the standard model with  $C$  colors. In the remaining four cases  $(\alpha, \beta_1, \beta_2) = +-+$ ,  $--+$ ,  $+--$ , and  $---$ , all ten fermionic hypercharges vanish and the three leptons are neutral under the little group. Finally, the cases where some of the four summands consist of matrices with real or quaternionic entries are treated as in the situation with three summands, and they produce the same submodels of the standard model.

The first possibility with  $C=1$  has only one  $U(1)$ . For the four sign assignments:  $(\alpha, \beta_1, \beta_2) = +++$ ,  $++-$ ,  $++-$ , and  $-+-$ , we find anomaly free lifts with nontrivial little group. For example,

for the first assignment, we get  $q_{11}=-1/2$ ,  $q_{21}=p$ ,  $q_{31}=-p$ , and  $q_{41}=-p$ , with  $p \in \mathbb{Q}$ . All four assignments produce the electro-weak model  $(\text{SU}(2) \times \text{U}(1))/\mathbb{Z}_2 \rightarrow \text{U}(1)$  of protons, neutrons, neutrinos, and electrons.

The second possibility,  $A=B=C=1$ , contains at least one chiral lepton with vanishing hypercharge and therefore neutral under the little group.

**Diagram 19** gives the same results as diagram 18.

In **diagrams 20, 21, and 22**, the elements  $a$  and  $b$  must be matrices with complex entries to allow for conjugate representations. Without both the fundamental representation and its complex conjugate, these diagrams would violate the condition that every nonvanishing entry of the multiplicity matrix of a (blown-up) Krajewski diagram must have the same sign as its transposed element if the latter is not zero. Diagram 20 is treated and fails as diagram 2; diagrams 21 and 22 are treated and fail as diagram 13.

At this point we have exhausted all diagrams of Fig. 2.

#### IV. CONCLUSION AND OUTLOOK

For three summands there was essentially one irreducible spectral triple satisfying all items on our shopping list: the standard model with one generation of quarks and leptons and an arbitrary number of colors (greater than or equal to 2). We say “essentially” because a few submodels of the standard model can be obtained. Going to four summands adds precisely one model, the electro-strong model for one massive quark with an arbitrary number of colors and one massive, charged lepton. Note that this is the first appearance of a spectral triple without any Higgs scalar and without symmetry breaking.

We still have to prove that spectral triples in four summands involving letter-preserving arrows like  $a \bar{a}$  do not produce any model compatible with our shopping list.

We are curious to know what happens in five (and more) summands. Here, ladder diagrams do not exist and we may speculate that our present list of models exhausts our shopping list also in any number of summands.

Anyhow, two questions remain: Who ordered three colors? Who ordered three generations?

<sup>1</sup>A. Connes, *Noncommutative Geometry* (Academic, New York, 1994); A. Connes, J. Math. Phys. **36**, 6194 (1995); Commun. Math. Phys. **155**, 109 (1996); A. Chamseddine and A. Connes, *ibid.* **182**, 155 (1996).

<sup>2</sup>B. Iochum, T. Schücker, and C. Stephan, “On a classification of irreducible almost commutative geometries;” hep-th/0312276; J. Math. Phys., (in press) J.-H. Jureit and C. Stephan, “On a classification of irreducible almost commutative geometries, a second helping;” hep-th/0501134; J. Math. Phys. (in press); T. Schücker, “Krajewski diagrams and spin lifts;” hep-th/0501181.

<sup>3</sup>M. Paschke and A. Sitarz, J. Math. Phys. **39**, 6191 (1998). T. Krajewski, J. Geom. Phys. **28**, 1 (1998).

<sup>4</sup>S. Lazzarini and T. Schücker, Phys. Lett. B **510**, 277(2001).

<sup>5</sup>J.-H. Jureit and C. Stephan, “Finding the standard model of particle physics, a combinatorial problem;” hep-th/0503085.



## **ICH BIN ZU GROSSEM DANK VERPFLICHTET:**

Gerhard Grensing und Barbara Schrempp,

insbesondere

Thomas Krajewski für die tolle Zusammenarbeit,

sowie

Thomas Schücker, Christoph Stephan, Raimar Wulkenhaar und Victor Gayral,

als auch

der Friedrich-Ebert-Stiftung, insbesondere Herrn Adalbert Schlag, und dem CNRS/CPT Marseille für die Gastfreundschaft,

und zuletzt aber nicht am wenigsten

meinen Eltern, Kristina & Tina und meinen Freunden.



## **ERKLÄRUNG:**

Hiermit versichere ich, diese Dissertationsschrift unter Anleitung von Prof. Dr. G. Grensing und unter Zuhilfenahme der angegebenen Quellen angefertigt zu haben. Diese Arbeit hat weder in gleicher, noch in ähnlicher Form im Rahmen irgendeines jemals stattgefundenen Prüfungsverfahrens vorgelegen. Frühere Promotionsversuche sind von mir nicht unternommen worden.

Kiel, 09.05.2007

---

Jan-H. Jureit



## **VITA:**

JAN-HENDRIK JUREIT

geboren: 26.02.1977 in Kiel

Staatsangehörigkeit: Deutsch

Wohnort: 24146 Kiel, Jasminweg 10a

## **SCHULBILDUNG:**

- 1987-1996 Gymnasium Elmschenhagen
- 1996 Abitur

## **STUDIUM:**

- 1996-2001: Studium Physik, Christian-Albrechts-Universität zu Kiel
- 2002-2003: Diplom, Universität Dortmund
- Ab 2004: Promotion zum Thema "*A braided quasi quantum group from strings in a magnetic field & Two applications of noncommutative geometry*" bei Prof. Dr. G. Grensing, Universität Kiel in Kollaboration mit dem Centre de Physique Théorique Marseille.