

Strategic planning of a heterogenous workforce

Inauguraldissertation

zur Erlangung des akademischen Grades eines Doktors
der Wirtschafts- und Sozialwissenschaftlichen Fakultät
der Christian-Albrechts-Universität zu Kiel

vorgelegt von
Dipl.-Kfm. Martin Mundschenk
aus Soltau

Soltau, 2008

Gedruckt mit der Genehmigung der
Wirtschafts- und Sozialwissenschaftlichen Fakultät
der Christian-Albrechts-Universität zu Kiel

Dekan:	Prof. Dr. Helmut Herwartz
Erstberichterstattender:	Prof. Dr. Andreas Drexl
Zweitberichterstattender:	Prof. Dr. Dr. h.c. Sönke Albers
Tag der Abgabe der Arbeit:	7. April 2008
Tag der mündlichen Prüfung:	4. November 2008

Inhaltsverzeichnis

I	Synopsis	1
1	Anmerkungen zu den einzelnen Artikeln	3
1.1	Long-term staffing based on qualification profiles	3
1.2	Workforce planning in the printing industry	4
1.3	Workforce planning for manufacturing-to-order production	4
1.4	Holiday planning of a heterogenous workforce	4
II	The Articles in Detail	7
1	Long-term staffing based on qualification profiles	9
2	Work force planning in the printing industry	11
3	Workforce planning for manufacturing-to-order production	13
3.1	Introduction	14
3.2	Workforce structure	16
3.2.1	Homogeneous workforce	17
3.2.2	Heterogeneous workforce	17
3.3	Literature review	18
3.3.1	Overview	18
3.3.2	Lack in Literature	24
3.4	Objectives	24
3.5	Skill and assignment matrices	27
3.6	Models	29
3.6.1	Basic model	29
3.6.2	Network design	32
3.6.3	Model summary	41
3.7	Application	44

- 3.7.1 Environment 44
- 3.7.2 Data collection 45
- 3.7.3 Job statistics 45
- 3.7.4 Method 46
- 3.7.5 Determining the parameters 48
- 3.7.6 Computational results 54
- 3.7.7 Analysis of the results 54
- 3.7.8 Conclusion 59

- 4 Holiday planning of a heterogenous workforce 65**
- 4.1 Introduction 66
- 4.2 Workforce structure 68
 - 4.2.1 Homogeneous workforce 68
 - 4.2.2 Heterogeneous workforce 68
- 4.3 Literature review 69
- 4.4 Problem description 71
 - 4.4.1 Skill and assignment matrices 72
 - 4.4.2 Restrictions 73
- 4.5 Model 74
- 4.6 Testing the model 78
 - 4.6.1 Environment 78
 - 4.6.2 Data 79
 - 4.6.3 Computational results 80
- 4.7 Empirical application 83
 - 4.7.1 Restrictions and individual issues 83
 - 4.7.2 Individual preferences 83
 - 4.7.3 Operational requirements 84
 - 4.7.4 Computational approach 85
- 4.8 Conclusions 86

Teil I

Synopsis

Kapitel 1

Anmerkungen zu den einzelnen Artikeln

1.1 Long-term staffing based on qualification profiles

Dieser Artikel beschäftigt sich mit der Problemstellung der strategischen Personalplanung anhand von Qualifikationsprofilen in einem Unternehmen der Auftragsfertigung. Arbeiter können so ausgebildet sein, daß sie mehrere verschiedene Tätigkeiten absolvieren können.

Anhand eines ganzzahligen linearen Optimierungsmodells entwickeln die Autoren einen Lösungsansatz, mit dem die benötigten Qualifikationsprofile sowie die Anzahl der Arbeiter mit einem bestimmten Qualifikationsprofil bestimmt werden. Da die Qualifikationsprofile Bestandteil der Lösung und nicht exogen vorgegeben sind, wächst die Anzahl möglicher Profile exponentiell mit der Anzahl der betrieblichen Aufgabenfelder. Zur Lösung dieses Problems wird eine Spaltengenerierungstechnik angewandt, wobei das Subproblem auf einem kürzesten-Wege-Problem basiert.

Die Formulierung und Modellierung wurde anhand einer praktischer Problemstellung vom Ko-Autor Martin Mundschenk erarbeitet. Ebenso wurde durch ihn das Modell in ANSI C implementiert, getestet und angewendet.

1.2 Workforce planning in the printing industry

Dieser Beitrag beschreibt die empirische Anwendung des Personalplanungsmodells in einem Produktionsbetrieb der Druckbranche. Der wesentliche Beitrag des Ko-Autors Martin Mundschenk besteht in der Erhebung der für das Modell notwendigen Daten. Dabei wurden sowohl Personaldaten, historische Daten des Betriebsdatenerfassungssystems, sowie tarifliche Rahmendaten zusammengeführt und für die Anwendung im Modell aufbereitet. Darüber hinaus wurden durch den Ko-Autor die Berechnungen durchgeführt und für die einzelnen Jahre der Betrachtung ausgewertet und zur Ausgabe aufbereitet.

1.3 Workforce planning for manufacturing-to-order production

Dieser Artikel ist eine konsequente Weiterentwicklung des strategischen Personalplanungsmodells. Dabei wird die Dynamik der Unternehmensumwelt parametrisiert und in das Planungsmodell mit aufgenommen. Die Personalplanung startet bei der Optimierung mit dem vorhandenen Personal des Unternehmens, kann somit von einer Planungsperiode zur nächsten am Status Quo des Unternehmens ansetzen.

Die individuellen Unterschiede einzelner Personen werden für weite Bereiche der praktischen Anwendung modelliert. So werden nicht nur die Kosten der Personalakquise oder der Abfindung explizit behandelt, auch die individuellen körperlichen und geistigen Fähigkeiten, sowie Aus- und Weiterbildungskosten eines jeden Arbeiters werden berücksichtigt.

Modellierung, Implementierung sowie Anwendung wurden durch den Autoren Martin Mundschenk ausgearbeitet.

1.4 Holiday planning of a heterogenous workforce

Während die Zusammensetzung und die Qualifikationen des Personals in einem strategischen Personalplanungsmodell variabel sind, so sind sie in der mittel- und kurzfristigen Betrachtung als gegeben anzusehen. Dieser Artikel befasst sich mit der Urlaubsplanung eines Betriebes der Auftragsfertigung und knüpft somit an dem vorherigen Artikel konsequent an. Dabei fließen

die Ergebnisse des strategischen Personalplanungsmodells als Parameter in das Optimierungsmodell mit ein.

Das gemischt ganzzahlige Modell ist durch die praktischen betrieblichen Erfahrungen des Autors motiviert und anhand von empirischen Beobachtungen entwickelt worden. Somit finden viele praktische betriebliche, tarifliche und gesetzliche Restriktionen Beachtung, welche das Modell komplex werden lassen. Dennoch läßt sich das Modell für die praktische Anwendung mit Standardsoftware implementieren und lösen.

Der Autor Martin Mundschenk hat das Modell entwickelt sowie erfolgreich in einem Betrieb der Druckindustrien getestet. Die Ergebnisse des Modells sind für das Jahr 2008 für die Urlaubsplanung des untersuchten Betriebes erfolgreich angewandt worden.

Part II

The Articles in Detail

Chapter 1

Long-term staffing based on qualification profiles

Long-term staffing based on qualification profiles

Andreas Drexl, Martin Mundschenk

Institut für Betriebswirtschaftslehre, Christian-Albrechts-Universität,
Kiel, Germany, andreas.drexl@bw1.uni-kiel.de,
martin@mundschenk.de

Published in "*Mathematical Methods of Operations Research*", (2008)
68:21-47

Abstract Manpower still is one of the most expensive resources, in spite of increasing automation. While employee scheduling and rostering has been the topic of extensive research over the past decades, usually it is assumed that the demand for staff is either given or can be obtained without difficulty. In this research we close the gap between practical needs and available models and methods. In particular, we provide an integer programming model for long-term staffing decisions. The model is based on qualification profiles, the number of which grows exponentially in terms of the number of processes considered. In order to compute tight lower bounds we provide a column generation technique. The subproblem is a shortest path problem in a network where the arcs have multiple weights. Upper bounds, that is, feasible solutions are calculated by means of local search. We present computational results for randomly generated instances and empirical results for examples from practice. From these results it is evident that the bounds are tight and that substantial cost savings can be achieved.

Keywords: Work force, planning/staffing, qualification profile, column generation, local search, computational/empirical evaluation

Chapter 2

Work force planning in the printing industry

Work force planning in the printing industry

Martin Mundschenk, Andreas Drexl

Institut für Betriebswirtschaftslehre, Christian-Albrechts-Universität,
Kiel, Germany, martin@mundschenk.de,
andreas.drexl@bwl.uni-kiel.de

Published in "*International Journal of Production Research*", 45(20):4849
– 4872,
October 2007

Abstract Effectiveness in the use of the work force is often the crucial advantage in a company's long-term success over its competitors, especially in technology driven and highly competitive branches as the one considered in this article. While employee scheduling and rostering has been the topic of extensive research over the past decades, usually it is assumed that the size of the work force is either given or can be obtained without difficulty. In this research we provide an integer programming model for long-term staffing decisions. The model is based on qualification profiles, the number of which grows exponentially in terms of the number of processes considered. We present empirical results for a company from the printing branch which highlight the potential of our approach. In particular, it will be shown that applying the model lowers the total cost of the work force in the range of 26% – 39%.

Keywords: Work force planning, qualification profile, printing company, empirical results

Chapter 3

Workforce planning for manufacturing-to-order production

Workforce planning for manufacturing-to-order production

Martin Mundschenk

Institut für Betriebswirtschaftslehre, Christian-Albrechts-Universität,
Kiel, Germany, m.mundschenk@mundschenk.de

Abstract In many medium-sized companies, the size and the configuration of the workforce is one of the key factors for success. While employee scheduling and rostering has been the topic of extensive research over the past decades, usually it is assumed that the demand for staff is either given or can be obtained without difficulty. In this research we provide an integer programming model for long-term staffing decisions which fits to the needs of manufacturing-to-order companies in a wide range of real life problems. We consider the heterogeneity of each worker in terms of his abilities, wages and working time. We take the costs of workforce acquisition, dismissal and on the job training into account. And we also model overtime and temporary workers. The model is designed to consider the costs of adjusting the size and the configuration of the workforce on hand to a changing environment of the company. Thus it can be used as a managerial tool for workforce planning and development. We tested the model with historic data of a printing company's job-tracking system and determined the costs of the workforce and its adjustment over a number of consecutive years. The model delivers good results by the use of standard solvers.

Keywords: planning/staffing, qualification profile, manufacturing-to-order, heterogenous workforce, workforce development

3.1 Introduction

Even though employee scheduling has been addressed by personnel managers, operations researchers and computer scientists for more than 40 years [10], the rostering literature assumes that the demand of staff is either given or can be obtained without difficulty [17]. Wijngaard addresses the detailed short-term manpower planning as low level planning. In the higher level planning the variables are more aggregated and the planning horizon is longer. He points out that the higher level planning determines the re-

strictions (budgets) for the lower level planning [23]. Most of the literature spent on this issue deals with the problem of special branches especially the service sector, where the demand for shifts and schedules is highly constrained. On the other hand, short-term scheduling procedures affect the level of staffing that should be provided [1]. It delivers crucial information for the strategic workforce planning, like the minimum number of workers needed in certain areas of production to avoid bottlenecks. The literature dealing with this interconnectivity and providing multi stage integrated models for staffing and rostering, usually only delivers the size of the workforce needed but neglects the required skills of the individual worker (see [1], [11]).

Furthermore, there is a conceptual gap throughout the scheduling literature: The goal of generating cost minimal schedules to assign workers to shifts in consideration of varying demand of workforce over the time, neglects that workers that are not assigned to a shift in one schedule are still on the payroll of the company. When schedules are generated, the number of workers in the inventory is a fixed parameter. The demand of workforce and its cost minimal composition has to be regarded and determined over a time horizon, where the runtimes of decision variables are alike. Thus the minimal time horizon to be regarded is determined by the time needed to hire or to dismiss workers. The acquisition of workers as well as the dismissal of workers can often take several month into account. Furthermore, structural changes of the workforce inventory usually go along with extra costs, that are not taken into account in the short-term planning, but have to be considered in the long run. Changing requirements to the workforce over time caused by environmental changes of the company have also to be taken into account in a matter of workforce development.

We analyze the workforce-planning problem in a medium-sized built-to-order manufacturing organization, where various workstations are needed to produce a certain set of products. Whether production is done in a flow-shop, job-shop or open-shop environment is a crucial parameter for scheduling but not for long-term staffing. One crucial question is, if workers can be cross trained to be qualified to operate more than one workstation. Imagine the situation where each worker is qualified to operate only one workstation. Then, when demand is low at a workstation, the associated worker is idle but still causes costs for the company. If on the other hand, demand is high at another workstation, bottlenecks may occur, causing idle times at succeeding workstations. Now imagine the other extreme, where every worker is qualified to operate the whole machinery of the company. This highly qualified workforce would go along with enormous costs. Another

disadvantage would be, that no worker would have the routine of operating a specific workstation so he will not exceed a certain level on his individual learning curve.

To avoid idle workers as well as bottlenecks, we need to find a workforce structure where workers are cross trained to operate different workstations under the aspect of minimal costs.

This paper delivers models which can be applied to a wide range of built-to-order manufacturing organizations to determine the size and the qualification of the workforce. We develop mixed-integer programming models to determine the size of the workforce and the required individual skills, in order to meet predicted requirements with the goal of minimizing the total cost of workforce. We also consider the workforce development from the status quo to the desired optimum, taking into account e.g. the costs of training or severance payments.

The outline of the paper is as follows: In section 4.2 we introduce different concepts of workforce structures, found in literature. The literature is reviewed in section 3.3 and different approaches of workforce planning models are summarized. The objectives of this paper are presented in section 3.4 and the fundamental concept of skill and assignment matrices are introduced in section 4.4.1. The models are developed in a step-by-step manner in section 3.6. Finally, the application and the results of the models to a medium-sized printing company is presented in section 3.7.

3.2 Workforce structure

In the manufacturing-to-order industry, the production workflow can be very complex. A product passes a variety of different workstations until it is completely manufactured. Also, the time needed for production at a certain workstation can vary from product to product. And not every product has to pass each workstation. As a result, the total working time that emerges in a certain time horizon differs from workstation to workstation. In other words: each workstation has a different time demand. In low or medium automated industries and in office domains, workstations are operated by workers. Each worker is a provider of working time. In return, he receives a wage from the company. All workers together represent the workforce of the company.

3.2.1 Homogeneous workforce

In a wide area of the workforce planning literature, workforce is considered to be homogeneous. That means, that every worker has the same skills, the same quality and earns the same amount of money. All workers do the same job and can easily be substituted by each other. This can be found in wide areas of the service sector like call centers or postal services.

The assumption of homogeneity simplifies short term scheduling and makes long term planning superfluous in terms of workforce development or labour selection as long as the labour market has a supply of the type of worker needed.

3.2.2 Heterogeneous workforce

In the predominant part of real life, the companies workforce is heterogeneous. On the one hand there is heterogeneity on the individual level: people have different skills and interests. They work with different quality and speed. They differ in age and experience. On the other hand, the kind of work, each worker processes and the workstations he is assigned to, requires an individual qualification. Depending on the level of qualification and experience on the job, workers earn different amounts of money from the company.

Heterogeneity of workforce makes staffing very complex and addresses the domain of strategical, long term workforce planning.

3.2.2.1 Hierarchical skills

In a heterogeneous workforce, there are workers with different levels of qualification. High qualification correlates with high income. Hierarchical skills assume that high qualified workers can substitute for a lower qualified one, but not vice versa (see [9]). This means, that a high qualified worker can handle all kinds of jobs and operate all workstations that lower qualified workers, down to the lowest level, can do. The procedure in which higher skilled workers are substituted for lower skilled ones is sometimes called *downgrading* (see [6]). As an example you can think of a pilot who is scheduled to fly as a copilot because of an absence of a real copilot. The pilot still receives his full wage but performs a lower qualified job.

The assumption of hierarchical skills is pretty vague though and does not hold in many environments. Consider a factory department with a fairly high number of different workstations. All operators have the skill to

operate the workstation they are assigned to and they all earn the appropriate wage. The supervisor of that department is on the next hierarchical level and receives a higher income. Still he can not be expected to substitute for each and every worker in his department even though there are a few workstations he might be able to operate. The achievement of a higher qualified skill (like supervising) does not go hand in hand with the achievement of all skills that are on lower qualification levels.

3.2.2.2 Job switching

A different and more realistic concept of heterogeneous workforce is the concept of job switching. Job switching means that a worker is qualified and can be assigned to operate two or more workstations. All workers can be differently qualified and can substitute each other only at workstations where common qualifications exist. The highest qualification determines the wage a worker receives from the company.

In this paper we follow the concept of job switching since this is what can be observed in the manufacturing-to-order industry.

3.3 Literature review

Strategic workforce planning has not been addressed by literature to the same extent workforce scheduling has been. This is due to the fact that the allocation of workforce on hand to shifts and processes is very highly constrained and that the potential of reducing the size of the workforce is thought to be linked directly to the quality of schedules obtained by short-term workforce planning. The guiding idea of determining the size of the workforce by short-term requirements is often the fact, that human resources are regarded to be homogeneous and that the workforce inventory can be adjusted to the requirements instantly. In this chapter we review the literature with the focus on how workforce heterogeneity is discussed and how the issue of workforce planning in the strategic sense is treated. Moreover, we focus on the development of the workforce to adjust to changing requirements.

3.3.1 Overview

We analyzed the literature dealing with workforce planning. We point out, whether a model assumes heterogeneous or homogeneous workforce and whether planning is done on an long or short term basis. If the authors

assume heterogeneous workforce, we further expose the underlying concept of hierarchical skills or job switching. We also point out considerations regarding special issues like overtime, costs of acquisition, training costs, etc. At the end of this chapter we give an overview comparing the existing models of workforce planning to the one presented in this paper.

Berman et al. [8] address a scheduling problem in a complex high volume factory. They point out that their model should be considered for strategic planning only. Their objective is to schedule the workers in a manner that minimizes labor costs subject to a variety of service-level, contractual and physical constraints. They follow the concept of job switching where a worker is skilled to operate two or more workstations. The heterogeneity of the workforce is considered by taking into account different types of workers, that are skilled to operate different subsets of workstations. They use a matrix similar to the skill matrix described in section 4.4.1 to map a worker to the workstations he is able to operate. Also, they consider different productivity of types of workers at different workstations. That means that workers of a certain type process a given number of units of work during a given period of time. But they assume that workers of a certain type are homogeneous. They also take into account that workers with different qualification receive different incomes from the company. Nevertheless, the types of workers and the combination of different skills are exogenously given parameters. Thus, the optimal combination of workers and their skills can not be obtained by the model. Furthermore, workforce development is not being considered, so there is no adjustment of the workforce due to a changing environment.

Another recent paper using skill matrices was issued by Daniels et al. [13]. They point out that in production-line environments partial labor resource flexibility is a particularly important issue that is determined by the extent to which workers are cross-trained to perform a subset of the tasks occurring within the line. Their objective is to minimize the total makespan in a flow-shop environment by jointly optimizing the job sequence, the processing rate and the feasible, dynamic labor allocation. Since they treat a short-term allocation problem, the size and qualification of the workforce is given at any time. Thus, a skill matrix has to be identified, that minimizes a flow shop rescheduling problem with partial resource flexibility. In their computational experiments they only address problems where the number of workers is equal to the number of workstations and results are only presented for instances with at most 5 workers / workstations. Nevertheless, the research represents an important step towards understanding the bene-

fits of partial workforce flexibility and also towards characterizing effective ways in which workers should be cross trained.

The multi-skilled workforce optimization with non-hierarchical skills was also addressed by Eitzen et al. [15]. The problem is to schedule workers with 5 skill classifications to shifts of a power station to obtain a 12 week schedule. Every worker is supposed to have a core skill level, a supplementary skill level and sometimes an optional skill level. They formulate a generalized set-covering model, where the assignments of workers to shifts are represented by 'tours of duty' which again are represented as columns. The objective is to minimize the number of understaffed shifts. Since the number of columns increases rapidly with the number of skill levels, they present a branch-and-price method with constrained branching to solve the model to optimality. Unfortunately, the problem of overstaffing is not mentioned at all. Even though the model is used for short-term planning, an objective that penalizes overstaffing as well as understaffing would give precious information about the total size of the workforce needed to face the predicted demands. Furthermore, the number of workers and their skills are given ex ante so there is no answer to the question if schedules with higher quality could be obtained, with the same number of workers having a different skill mix.

Grinold [19] examines a longitudinal model of a manpower system, where the demand for effective manpower is determined by the state of a finite markov chain. He takes into account the size of the workforce needed and the fact that workers have to be qualified before they can be assigned to workstations in the predicted period. He formulates two quadratic objectives, one that minimizes the weighted squared error between the supply and the demand for effective manpower and one that provides a smooth flow of manpower through the system and to come as close as possible to meet the demand for effective manpower. He points out though, that the objectives ignore the costs of operating the system. Furthermore, manpower is regarded to be homogeneous. Nevertheless, the work takes into account, that the size of the workforce has to be adjusted over time to meet predicted demand and that it can not be determined by short-term requirements.

Bard [5] decomposes the configuration of the permanent workforce into three levels. In the long run, the regular workforce has to be determined with the goal to minimize personnel costs while meeting all service standards and contractual obligations. After that, adjustments have to be made on a weekly basis to account for planned leave and expected departures from assumed demand. Finally, at the day-to-day level, supervisors must deal

with unplanned absenteeism, machine breakdowns and unexpected peaks in demand. The problem is to select the right input data to configure the appropriate size of the permanent workforce and the critical objective is to manage overtime, part-time workers and temporaries, so that when volumes are high, additional costs are kept to a minimum, and when volumes are low, the permanent workforce is never idle. He points out, that if the permanent workforce is set too high, unnecessary labor costs will be incurred. Even though this statement sounds obvious, it is neglected in wide areas of the workforce planning literature. Bard's model regards the workforce to be homogeneous in terms of skills and individual capabilities and it does not treat the issue of workforce development from one planning period to the next one.

Bard [6] focuses on a long-term planning model with heterogeneous skilled workers in a hierarchical organized workforce, where downgrading is permitted. Whereas in general, skill categories are treated separately, he now relaxes the model to allow workers of a higher skill category to substitute for workers of a lower skill category. The objective is to minimize the total costs of the workforce, with high qualified workers being more expensive than low qualified workers. In his model he treats two skill levels with the note that more levels could be handled with the same approach but letting the model become unmanageable.

Emmons and Burns [16] criticize, that combinatorial results in the workforce planning literature are always based on the assumption of a single type of worker. They take workforce heterogeneity into account, but assume a hierarchical workforce. Their model's objective is to minimize the total costs of the workforce subject to scheduling constraints, under the assumption, that the requirements of each type of worker, and therefore the requirements of certain skills, are constant over the planning horizon. The assumption of hierarchical skills and the assumption that demand does not underly any stochastic components, does not make their model applicable to a wide range of real world problems.

Berman and Larson [7] observe a scenario, where the size and the composition of workforce is determined by minimizing its average daily costs. The workers are homogeneous in skills but can be employed as full-time, part-time or temporary workers. Again, they point out the fact that a system having just-in-time-personnel attempts to meet all demands for personnel at minimum cost by sharply reducing both excess worker inventory with its concomitant "paid lost time" and underage of worker inventory with its associated costs of stockout. They model absenteeism of workers following a Bernoulli probability and they consider a varying daily work-

load. The problem was motivated by a workforce planning study with a logistics firm having more than 100.000 employees, where we can assume the existence of departments with large numbers of workers having the same skills. Personal capabilities and qualifications might be neglected, when regarding thousands of workers. Nevertheless, such a model could not be applied to manufacturing-to-order companies.

Thompson and Goodale [22] treat the problem of scheduling workers with different productivity in a service organization. This aspect has not been modeled in literature so far. The problem in service organizations is, unlike in manufacturing companies, that the workforce level has to meet the stochastic demand of customer service. Having more staff than necessary is costly, since the customer-contact activities of the service staff can not be inventoried. Conversely, having fewer staff than necessary risks poor customer-service and the loss of current or future revenue. Even though that paper addresses a different problem that we do, it contributes by pointing out, that ignoring the worker as a source of variability leads to significant errors in projecting output.

Ahn et al. [2] consider a firm that employs heterogeneous workers to meet demand for its products and services. They consider the fact, that workers differ in their skills, speed and quality. They develop a discrete-space model to obtain an optimal hire-up-to / fire-down-to policy for the company to adjust the size of the workforce to meet randomly changing demand forecasts at minimal expense. They take into account the costs of acquisition and dismissal but they do not model the demand of certain skills within the regarded planning period. The different types of workers can be substituted by each other, leading to a convex cost function of the workforce. This assumption would mean, that for example a pilot could be substituted by a large enough number of stewardesses.

Cai and Li [12] present a generic algorithm for scheduling staff of mixed skills. They are motivated by the fact, that traditional research usually considers only simplified models with staff having homogeneous skills. They consider the existence of jobs requiring different skills and employees of multiple skills who can be assigned to do different types of jobs as needed. In their model, they regard two kinds of jobs and three types of workers, whereas only one type of worker can be assigned to either kind of job. As soon as the number of jobs and the possible types of workers increase, the structure of their model has to be adjusted and would lead to a complexity that is unmanageable. Further, the cost of assigning a worker to a schedule does not depend on the type of the worker, but on the shift he is assigned to.

Billionnet [9] considers a hierarchical workforce in which a higher qualified worker can substitute a lower qualified one, but not vice versa. His objective is to determine a cost minimal hierarchical workforce subject to meet scheduling constraints. He does not take into account the existence of part-time workers or overtime. Further, he neglects the fact, that workers that are not scheduled, are still on the pay roll of the company, so an optimal schedule only produces over coverage but does not save any costs.

Eveborn and Rönnqvist [18] developed a software to solve real-world scheduling problems of the service industry. Their underlying model uses a column generation technique to create a set of individual schedules that are valued with points, taking into account the overall costs of a schedule as well as the individual preferences of the employees concerning working times. They assume a heterogeneous work-force with each individual having different skills. Overtime and flexible working times are also taken into account. They assume the work-force demand as given, though. The staffing requirements might be set by the experience of managers or can come from contracts.

Azmat et. al. [3] present a MIP to schedule a single-shift workforce in a one-year time-horizon. That paper is an enhancement to Azmats and Widmers three step heuristic [4]. The determination of the size of workforce is part of their model and even the amount of overtime is determined. Scheduling is done in respect to legal constraints like the maximum shift lengths, obligations to holidays, etc. They assume that the exact demand of weekly working hours can be predicted in advance for the complete 52 weeks of the planning horizon. Furthermore the regarded workforce is assumed to be homogeneous. Nevertheless, that paper issues the mathematical computation of the total size of the workforce needed to face the demand of the planning horizon (year), instead of regarding this value as given.

Drexl and Mundschenk [14] [21] developed an optimization model based on qualification profiles to schedule an heterogeneous workforce in a manufacturing-to-order company. They considered the fact, that each worker might have to be differently qualified to satisfy the needs of the company. Their model minimizes the total annual costs of the workforce. To handle the amount of possible qualification profiles, they use a column generation approach. The subproblem to generate new columns determines a valid path thru a network, representing the workstations of the company. Their model does not consider the dynamic nature of the problem and thus neglects the costs of adjusting the workforce on hand to changing requirements. Further they do

not take into account different capabilities or individual contractual setting like annual working time of each worker.

3.3.2 Lack in Literature

The models treated in literature usually determine the size of the workforce by regarding a short interval in the production process. That way they neglect the fact, that the employment of workforce is a long-term issue or they assume that workers can be hired or fired in an ad hoc manner and that workers with desired qualifications are available at any time. Different types of workers are usually only concerned in terms of working times, whereas the variety of these types usually reduce to full-time, part-time and temporally workers.

The need to model the heterogeneity of the workforce in terms of qualification starts being adopted by literature, but models are often still rudimentary in depicting the differences in workers and in workforce requirements. Thus, the number of different skills treated by the models are low, because models get very complex by increasing the level of heterogeneity.

None of the models discussed above treats a worker as an individual factor of the production process that has to be carried over from period to period. Thus, the issue of workforce development is neglected throughout in literature. Table 3.1 gives an overview of the features treated by the models discussed above.

Since workforce planning has a long history in the service industry, where the availability of workers has to be assured at certain times of the day to guarantee service quality, workforce planning is done by constructing schedules and transferring the short-term results to a super-ordinate planning level. The advantage in the manufacturing-to-order industry is, that the demand of workforce can be shifted or inventoried to a certain extend, so that peak times can be smoothened. That way, the number of workers with a specific mix of skills can be determined on the basis of aggregated demand over the long-term planning horizon. This approach is not being regarded by research yet.

3.4 Objectives

Workforce planning is the process of gathering and analyzing information to determine variables concerning the personnel to meet the requirements of the company to achieve its objectives. From this point of view workforce

	[8]	[13]	[15]	[19]	[5]	[6]	[16]	[7]	[22]	[2]	[12]	[9]	[18]	[3]	[14]	[21]	M
Heterogeneous	•	•	•	•	•	•	•	•	•	•	•	•	•	•	•	•	•
Homogenous	•	•	•	•	•	•	•	•	•	•	•	•	•	•	•	•	•
Long term	•	•	•	•	•	•	•	•	•	•	•	•	•	•	•	•	•
Short term	•	•	•	•	•	•	•	•	•	•	•	•	•	•	•	•	•
hierarchical	•	•	•	•	•	•	•	•	•	•	•	•	•	•	•	•	•
Job switching	•	•	•	•	•	•	•	•	•	•	•	•	•	•	•	•	•
Skills	•	•	•	•	•	•	•	•	•	•	•	•	•	•	•	•	•
flexible working time	•	•	•	•	•	•	•	•	•	•	•	•	•	•	•	•	•
Individual capabilities	•	•	•	•	•	•	•	•	•	•	•	•	•	•	•	•	•
Acquisition cost	•	•	•	•	•	•	•	•	•	•	•	•	•	•	•	•	•
Cost of dismissal	•	•	•	•	•	•	•	•	•	•	•	•	•	•	•	•	•
Over time	•	•	•	•	•	•	•	•	•	•	•	•	•	•	•	•	•
On-the-job training	•	•	•	•	•	•	•	•	•	•	•	•	•	•	•	•	•
Workforce Development	•	•	•	•	•	•	•	•	•	•	•	•	•	•	•	•	•

Table 3.1: Overview of workforce planning models

planning is a substantial part of the companies over all planning process. Its essential task is to guarantee the operational availability of the personnel. Workforce planning can be divided into three fields:

Workforce requirements The amount of workers with specific skills, that are needed to meet the demand of working time in a certain time period. The future requirements have to be determined by prediction.

Workforce configuration The number of workers with given skills at a specific point in time. It is the status quo from whereon workforce development is started. The workforce configuration has to be adjusted to meet the workforce requirements.

Workforce allocation The assignment of workers to jobs and positions within the company. Workforce allocation is the link between workforce requirements and workforce configuration.

If any of the three fields is not determined for a given time period, the management of a company is in charge to do workforce planning. Table 3.2 gives an overview of the different fields of workforce planning.

	Workforce requirements	Workforce configuration	Workforce allocation
pure planning of allocation	●	●	○
pure planning of configuration	●	○	○
pure planning of assignment	○	●	○
simultaneous planning	○	○	○

Table 3.2: Types of workforce planning. ●=given, ○=to be determined

The pure allocation planning is done, when the workforce requirements and the workforce configuration are given. That way external changes to the workforce configuration (e.g. loss of personnel) can be taken into account.

The planning of the configuration assumes, that the workforce requirements are given. Changing the workforce configuration always means to change the workforce inventory from a given configuration to a desired configuration. The workforce allocation has to be re-determined every time the requirements or the configuration change.

When workforce requirements change but the workforce configuration should be held constant, pure assignment planning has to be done. This is mainly the case when the company has an over coverage of workforce, and new areas of employment are being looked for.

Simultaneous planning is done when the requirements and the configuration of the workforce are unknown and have to be determined. Note that determining the workforce configuration is usually never started from scratch, as mentioned above.

Workforce planning is a process of workforce optimization. The objectives can be formulated in a brought variety though. Thus the objectives can be to maximize the profit, the marginal return, the performance of the company, customer satisfaction, etc. Or the objectives can be to minimize costs, production time, losses, etc. Objectives of the company can also include elements of maximizing workforces' benefits.

Changing the workforce configuration is the process of adjusting the workforce inventory from a given configuration to a new one to meet changing requirements. Basically this can be done in two different ways. On the one hand, workers with desired skills can be acquired on the labour market, on the other hand, workers on hand can be trained to meet the changing requirements. The latter is called workforce development.

The application of the model developed in this paper is for simultaneous planning. Workforce requirements will be determined and the workforce configuration will be adjusted from the workforce on hand to meet the workforce requirements. The costs of adjustment and the cost of the adjusted workforce are crucial elements of the model's objective. The dynamic environment of a company and the associated implications of the workforce configuration over time are explicitly dealt with.

3.5 Skill and assignment matrices

We now introduce the concept of the skill and assignment matrix, which plays an important role in the remainder of this paper. This matrix contains the information which workers are assigned to which subset of workstations, they are qualified to operate. For convenience, we will typically refer to the skill and assignment matrix as the *skill matrix*. We refer to the paper of Daniels et. al. [13] who treat the issue of partial resource flexibility of workforce and also follow the concept of skill matrices to specify which workers are trained to operate each of the workstations.

Let $W = \{1, 2, \dots, w\}$ denote the set of workers and let $M = \{1, 2, \dots, m\}$ denote the set of workstations. We now define the $w \times m$ matrix $S = (s_{ij})$, $i \in W, j \in M$, as

$$s_{ij} = \begin{cases} 1, & \text{if worker } i \text{ is trained to operate workstation } j, \\ 0, & \text{otherwise.} \end{cases}$$

Each row of the skill matrix S corresponds to a worker $i \in W$. The set $M_i^S = \{j \in M : s_{ij} = 1\}$ is the set of workstations for which worker i is appropriately trained and to which he can be assigned. Let $m_i^S = |M_i^S|$ be the number of such workstations. We can now specify the two extreme cases where on the one hand $m_i^S = 1, i \in W$, corresponding to no flexibility at all and $m_i^S = |M|, i \in W$, on the other hand, where every worker is skilled to operate each workstation.

Similarly, for each column of S corresponding to workstation $j, j \in M$, the number of workers who are trained to operate workstation j is given by $w_j^S = |W_j^S|$, where $W_j^S = \{i \in W : s_{ij} = 1\}$.

Consider a setting with $M = 4$ workstations and $W = 4$ workers. Each workstation requires a different skill level. We assume, that workstation 1 requires the lowest and workstation 4 the highest qualification to be operated. Suppose that

$$S = \begin{pmatrix} 1 & 0 & 0 & 0 \\ 0 & 1 & 1 & 0 \\ 0 & 0 & 1 & 1 \\ 0 & 0 & 0 & 1 \end{pmatrix}.$$

In this example worker 1 is trained and assigned only to workstation 1; worker 2 is trained and assigned to workstations 2 and 3, and so on. Thus, the skill sets of the workers are $M_1^S = \{1\}$, $M_2^S = \{2, 3\}$, $M_3^S = \{3, 4\}$ and $M_4^S = \{4\}$. Note that workers 3 and 4 have the highest qualification. But since we are not following the concept of hierarchical skills, we don't suppose that they are trained to operate all workstations associated to lower levels of qualification. Even if worker 4 is actually trained to operate workstation 1, he is not assigned to work there. Moreover, even though worker 4 is not as flexible as worker 3, worker 4 spends his whole working time at workstation 4 so he can be regarded as a specialist with high potential to gain a high level on his individual learning curve to operate his workstation.

As mentioned above, different levels of qualification go with different levels of income for the workers. Let $C = \{1, 2, \dots, m\}$ denote the income that is associated to the level of qualification to operate workstation $j \in M$. Now, the income W_i^I of a worker i is determined by the highest level of qualification he owns. Suppose that in the above example $C = \{90, 95, 100, 110\}$, then the income of the workers are $W_1^I = 90$, $W_2^I = 100$ and $W_3^I = W_4^I = 110$. Thus, the costs of workforce for the company is 410.

3.6 Models

In this chapter we develop a mixed-integer programming model to determine the workforce requirements and configuration of a manufacturing-to-order company. We first introduce a basic model and define an underlying graph, representing the company whose workforce is to be optimized. We continue by extending the model to meet further real-world requirements. At the end of this chapter we summarize the extensions and present a powerful model for strategic workforce planning, that can be solved with standard solvers like CPLEX.

3.6.1 Basic model

Given is a manufacturing-to-order company with $N = \{1, 2, \dots, n\}$ jobs and $M = \{1, 2, \dots, m\}$ workstations. The number of jobs N refers to the regarded planning horizon. In the remainder of this paper, we assume that the planning horizon is one year. Each job $h \in N$ is processed in at most m steps corresponding to the m workstations. Let p_{hj} be the time required to process job h at workstation $j \in M$. Then the total time b_j , workstation j has to be operated during the planning horizon is $b_j = \sum_{h=1}^n p_{hj}$.

To operate the workstations, the company employs $W = \{1, 2, \dots, w\}$ workers. Each worker $i \in W$ offers an annual working time $a_i > 0$. Note that $\sum_{i=1}^w a_i \geq \sum_{j=1}^m b_j$ has to hold, in order to assure feasibility.

The annual working time a_i provided by each worker i , has to be allocated to the workstations, so that the annual time demand to operate each workstation is satisfied. Let $X = (x_{ij})$ be a $w \times m$ matrix, where x_{ij} denotes the allocated working time of worker i to workstation j . By allocating working time from worker i to workstation j we assume that worker i is either qualified or has to be qualified to operate workstation j . Thus, referring to the skill matrix S , introduced in section 4.4.1,

$$s_{ij} = \begin{cases} 1, & \text{if } x_{ij} > 0; \\ 0, & \text{otherwise.} \end{cases}$$

The skill matrix S is implicitly determined by allocating working time from workers to workstations. Since the income of a worker is determined by his highest qualification, the annual working time of each worker has to be allocated to the workstations in a manner, that the resulting skill sets of the workers are cost minimal and the workstations' time demands are satisfied. As a result, the size of the workforce and the set of individual skills are obtained. That is, the workforce requirements are defined (number and qualification of workers).

Consider each worker as a provider of working time and each workstation as a demander of working time. Let's now construct a directed graph $G = (V, E, c)$. The set of nodes V contains two subsets such that $V = V_a \cup V_b$. Each node of subset V_a represents a worker $i \in W$, whereas each node of subset V_b represents a workstation $j \in M$.

Each worker provides his own amount of annual working time. So in the means of transportation, it can be said, that each worker $i \in W$ offers his own commodity $z \in P$ and only his own commodity. So the size of set P is equivalent to the size of set W . Parameter a is extended with a second index z , so in the case of $i = z$ the annual working time is $a_{iz} > 0$ and $a_{iz} = 0$ otherwise. So worker $i \in W$ represented by node $i \in V_a$ has a supply of working time of a_{ii} . Workstation $j \in M$ represented by node $j \in V_b$ has a demand of working time of b_j . It is not relevant where the supply comes from, so there is only one index. The sum of working time provided must be at least the amount demanded within the graph: $\sum_{i \in V_a, z \in P} a_{iz} \geq \sum_{j \in V_b} b_j$. The purpose why working time is a heterogeneous commodity $z \in P_a$ from the view of the supplier and a homogeneous commodity from the view of the demanding workstation, is that the origin of working time has to be tracked back to the supplier throughout the network to determine the qualification profile of the supplying worker. The receiving workstation makes no difference of the origin of working time. The only matter is, that the demand of time is satisfied.

The set of arcs E are weighted with the extra wage c_{ij} a jobholder earns, if he is qualified to supply working time to workstation j when he is already qualified to work at workstation i . Within the graph G a path from a supplying node $i \in V_a$ to a number of demanding nodes $j \in V_b$ represents the qualification of a worker $i \in W$ to operate a subset $M_i^S = \{j \in M : s_{ij} = 1\}$ of the workstations. The length of such a path represents the wage

a worker earns due to his qualification. As the model gets extended later on, the length of a path will also contain the costs of workforce development.

Since the total costs that arise by providing working time to a workstation are independent from the amount x_{ijz} of time, we introduce the variable $y_{ijz} \in \{0, 1\}$ to be either 0 if no time from worker $z \in W$ is supplied to node j from node i , or 1 if there is. Parameter B is used to link y_{ijz} to x_{ijz} in constraint (3.5). It is defined to be $B = \{\max a_{iz} : \forall i \in V_a, \forall z \in P\}$. The basic model to determine the workforce requirements is formulated in (3.1) - (3.7).

$$\min \sum_{z \in P_a} \sum_{(i,j) \in E} c_{ij} y_{ijz} \quad (3.1)$$

s.t.

$$\sum_{(i,j) \in E} x_{ijz} = a_{iz} \quad \forall i \in V_a, \forall z \in P_a \quad (3.2)$$

$$- \sum_{(h,i) \in E} x_{hiz} + \sum_{(i,j) \in E} x_{ijz} \leq 0 \quad \forall i \in V_b, \forall z \in P \quad (3.3)$$

$$- \sum_{(h,i) \in E} \sum_{z \in P_a} x_{hiz} + \sum_{(i,j) \in E} \sum_{z \in P_a} x_{ijz} \leq -b_i \quad \forall i \in V_b \quad (3.4)$$

$$x_{ijz} \leq B \cdot y_{ijz} \quad \forall (i,j) \in E, \forall z \in P_a \quad (3.5)$$

$$x_{ijz} \geq 0 \quad \forall (i,j) \in E, \forall z \in P_a \quad (3.6)$$

$$y_{ijz} \in \{0, 1\} \quad \forall (i,j) \in E, \forall z \in P_a. \quad (3.7)$$

The objective function (3.1) minimizes the costs of assigning individual workers to workstations. The binary variable y_{ijz} determines whether a part of a worker's working-time is allocated to operate a certain workstation. The amount of allocated working-time does not play a role. Constraint (3.2) assures that the amount of working time, provided by worker $i \in W$, represented by node $i \in V_a$, does not exceed his contractual annual working time. Constraint (3.3) is a flow control constraint that controls the amount of working time of type $z \in P$ flowing out of node $i \in V_b$ to be at least the amount flowing in. Constraint (3.4) assures that the demand of working time b_i is satisfied in every node $i \in V_b$. Thereby, it is exiguous of which type z of working time $x_{..z}$ comes from. Constraint (3.5) links the binary variable y_{ijz} to x_{ijz} to be 1, if working-time of type $z \in P_a$ flows out of node j into node i .

3.6.2 Network design

The structure of the graph $G = (V, E, c)$ determines what kind of real world problem is to be modeled and solved. We now describe how a graph has to be set up to model characteristics of different problems. Furthermore we add extensions to our model.

3.6.2.1 Basic design

The generic structure of the graph $G = (V, E, c)$ contains a subset of supplying nodes $V_a \in V$ and a subset of demanding nodes $V_b \in V$. As mentioned above, the sum of supplied working time has to be at least the amount of demanded working time throughout the network. Otherwise the model is infeasible.

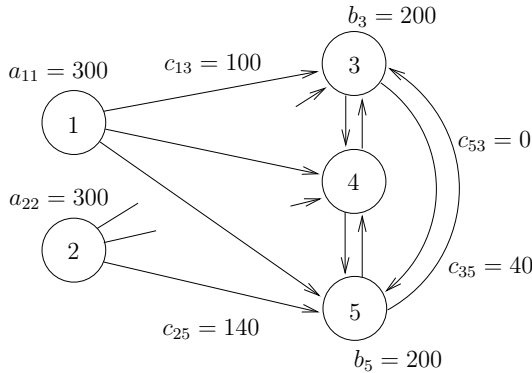

Figure 3.1: Basic structure

Figure 3.1 illustrates a scenario with two workers, represented by the supplying nodes $V_a = \{1, 2\}$ and three workstations, represented by the demanding nodes $V_b = \{3, 4, 5\}$. The working time supplied by workers 1 and 2 is 300 time units respectively. The amount of working time demanded by workstations 3, 4 and 5 is set to 200 time units respectively.

There are directed arcs from each supplying node to each demanding node. That means, that basically each worker can be assigned to each workstation to perform a part of his working time there. Furthermore, there exist directed arcs from each demanding node to each other. The

graph is complete in the subset of nodes V_b . Thus, each worker could be assigned to any further workstation to operate.

The weight c_{ij} of the arcs is set up as follows: Let's look at the graph of figure 3.1 and assume that the ability to operate workstation 3 requires a qualification that is paid 100 monetary units (MU). Thus each arc coming from a supplying node and pointing to the demanding node 3 is weighted with $c_{.3} = 100$. Let's further assume that the qualification to operate workstation 4 is refunded with 120 MU and to operate workstation 5 is refunded with 140 MU, thus the arcs from the supplying nodes to the demanding nodes are weighted accordingly.

In our model we assume that a worker with a high qualification does not receive an extra payment by achieving an additional, but lower qualification. Thus, the weight of the arcs from node 5 to node 4 and from node 5 to node 3 is valued with $c_{54} = c_{53} = 0$. Then again, a worker that achieves an additional, higher qualification, is paid according to that extra qualification. Arcs from demanding nodes with low qualification requirements to arcs with higher qualification requirements are weighted with the difference of the associated payment levels. Let's look at the arc from node 3 to node 5. The arc is weighted with $c_{35} = 140 - 100 = 40$.

Table 3.6.2.1 summarizes all data for the graph G . Solving the model (3.1)-(3.7) leads to an objective value of $F^* = 260$. Furthermore we receive the qualification and the assigned working times of each worker from the variables. Table 3.3 shows the amount of working time, each worker has to perform at the different workstations. Thus, two workers have to be employed. The resulting skill set of worker 1 has to be $M_1^S = \{1, 1, 0\}$ and the one of worker 2 has to be $M_2^S = \{1, 0, 1\}$. Since each worker is paid according to his highest qualification, worker 1 is paid 120 MU because his highest qualification is to operate workstation 4 and worker 2 is paid 140 MU because his highest qualification is to operate workstation 5.

$$a_{iz} = \begin{pmatrix} 300 & 0 \\ 0 & 300 \end{pmatrix} \quad b_i = \begin{pmatrix} 0 \\ 0 \\ 200 \\ 200 \\ 200 \end{pmatrix} \quad c_{ij} = \begin{pmatrix} 0 & \infty & 100 & 120 & 140 \\ \infty & 0 & 100 & 120 & 140 \\ \infty & \infty & 0 & 20 & 40 \\ \infty & \infty & 0 & 0 & 20 \\ \infty & \infty & 0 & 0 & 0 \end{pmatrix}$$

3.6.2.2 Reduction of the network

The network design defined above, leads to a dependency between each supplying node $i \in V_a$ and two random demanding nodes $j, k \in V_b$ as

	Workstations		
	3	4	5
worker 1	100	200	0
worker 2	100	0	200

Table 3.3: Optimal allocation of working time from the workers to the workstations

depicted in figure 3.2. We assume $t > r$. Thus, to operate workstation k , a higher qualification is needed than to operate workstation j .

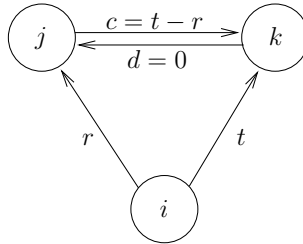

Figure 3.2: Dependency between network nodes

The costs of a path from a supplying node i via two demanding nodes j and k is $l_1 = r + t = r + t - r = t$ as well as $l_2 = t + d = t$. Both possible paths have the identical costs $l_1 = l_2$. This redundancy can be eliminated by removing the arc $d = 0$ between the demanding nodes j and k ¹. Reducing the graph from figure 3.1 leads to a network structure illustrated in figure 3.3. No possibilities of assigning working time from each supplying node to each demanding node are lost that way.

A further way to reduce the complexity of the graph is based on the fact that the weights of the arcs from each supplying node to a certain demanding node are identical. The introduction of a dummy-node $h \in V_l$ with a demand $b_h = 0$ between all supplying and all demanding nodes, reduces the number of arcs from $i \in V_a$ to $j \in V_b$ from $|V_a| \times |V_b|$ to $|V_a| + |V_b|$. The dummy-node h can be interpreted as a base qualification each worker has to have but which is not refunded.

¹Basically the arc $c = t - r$ could be removed alternatively. But we will see later on, that it is important to keep arcs with weights > 0 , when the network structure is further modified.

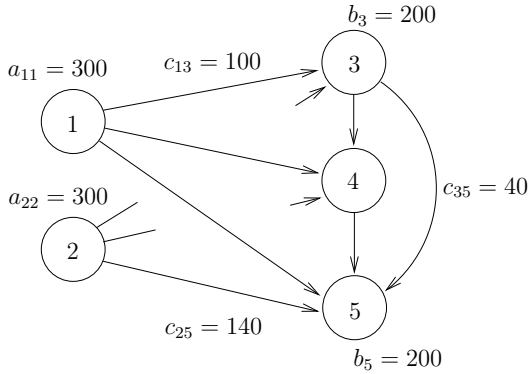

Figure 3.3: Network after the removal of redundant arcs

Now the graph from figure 3.3 can be further reduced as illustrated in figure 3.4.

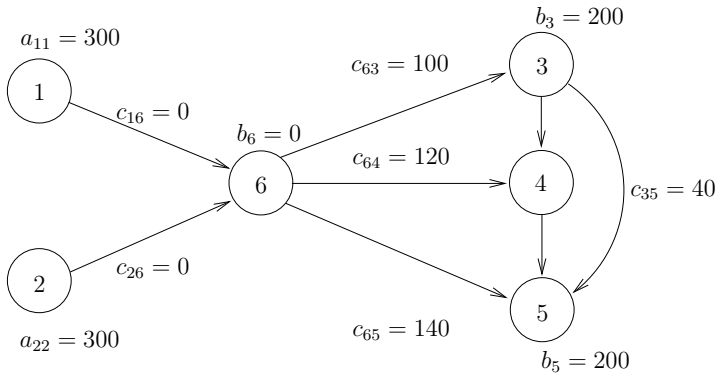

Figure 3.4: Network after the introduction of a dummy node

To avoid working time being delivered to the dummy node, the following constrained has to be added to the model:

$$- \sum_{(h,i) \in E} x_{hiz} + \sum_{(i,j) \in E} x_{ijz} = 0 \quad \forall i \in V_l, \forall z \in P_a \quad (3.8)$$

A graph to represent a scenario where each worker $i \in V_a$ might be assigned to any workstation $j \in V_b$, has a maximum number of $|V_a| + |V_b| + |V_b| \times \frac{|V_b|-1}{2}$ arcs.

3.6.2.3 Minimum number of operators

In long term staffing, it might in some cases be essential to hold a minimum number of workers l_j , qualified to operate a certain workstation j , in the workforce inventory. On the one hand production downtimes can be avoided due to absences in case of vacations or illness. On the other hand, when a workstation faces temporarily high demand, the risk of bottlenecks can be reduced. To handle the problem of assigning a minimum number of workers to one workstation, the model has to be extended by adding the following constraints.

$$\sum_{(i,j) \in E} \sum_{z \in P_a} y_{ijz} \geq l_j \quad \forall j \in V_b \quad (3.9)$$

$$\sum_{(i,j) \in E} f \cdot y_{ijz} \leq \sum_{(i,j) \in E} x_{ijz} - \sum_{(j,h) \in E} x_{jhz} \quad \forall j \in V_b, z \in P_a \quad (3.10)$$

$$\sum_{(i,j) \in E} y_{ijz} \leq 1 \quad \forall j \in V_b, z \in P_a \quad (3.11)$$

Constrained (3.9) makes sure, that the minimum number of arcs, that deliver node j with working time, is at least the minimum number of workers l_j that have to be qualified for that workstation. Constrained (3.10) restricts the variable y_{ijz} to be zero, when no working time x_{ijz} is being delivered to node i from worker z . Additionally this constraint controls the minimum working time f , a worker is assigned to a workstation over the planning horizon. This is important to guarantee the experience of operating the workstations, a worker is assigned to. Regarding the underlying network G , constrained (3.11) makes sure, that each worker z delivers working time to workstation j not over more than one arc.

Referring to the example from section 3.6.2.1 we now set $l_3 = l_4 = 2$, so that there has to be a minimum of two workers to be qualified to operate workstation 3 as well as to operate workstation 4. After solving the modified model, the resulting amount of working time delivered from the workers to the workstations can be depicted from table 3.4. In this case the objective value $F^* = 260$ remains unchanged compared to the case without the requirement of a minimum number of operators. Worker 1 now has a qualification profile of $M_1^S = \{1, 1, 1\}$ and worker 2 a qualification profile of $M_2^S = \{1, 1, 0\}$.

	Workstations		
	3	4	5
Worker 1	50	50	200
Worker 2	150	150	0

Table 3.4: Optimal distribution of working time with the requirement of a minimum number of operator at workstations 3 and 4

3.6.2.4 Full-time and part-time workers

Most models known in literature only provide the possibility to differentiate between a limited number of possible working hours that are performed by the worker. In our model we have the possibility to consider as many different working times a_{iz} as there are workers i . Because of the underlying concept of supplying nodes V_a and demanding nodes V_b , we can set the individual working time provided, to either the demands of the company or the demands of the worker.

To take into account that workers, providing different amounts of working time, go with different costs, we introduce the parameter $\lambda_z > 0$ that reflects the individual costs of each worker providing his working time z . λ_z is used as a multiplier for the parameter c_{ij} . We assume $\lambda_z = 1$ for a full time worker. We modify the objective function (3.1) to (3.12).

$$\min \sum_{z \in P_a} \sum_{(i,j) \in E} \lambda_z c_{ij} y_{ijz} \quad (3.12)$$

Furthermore, workers with the same qualification who work the same amount of time can still receive different wages due to differences in their

contracts. These differences can also be taken into account by appropriately modifying λ_z .

3.6.2.5 Individual capabilities

Not only that workers can be heterogeneous in their qualification, in their working time they provide and the payment they receive, they also might have different individual capabilities to operate different workstations. Think of workstations where filigree work has to be done. A worker with huge hands may not be the right person for that kind of job. Nevertheless he might be the right person to operate heavy machines.

We now introduce the parameter ω_{iz} as a multiplier for x_{ijz} . We can now take into account, that people have physical or mental differences. The default value is $\omega_{iz} = 1$. That means that worker $z \in W$ is able to operate workstation i at 100% speed. A worker with higher capabilities has $\omega_{iz} > 1$, someone with low capabilities at workstation i has $\omega_{iz} < 1$.

This parameter is used in constrained (3.4) and leads to the modified constrained (3.13).

$$- \sum_{(h,i) \in E} \sum_{z \in P_a} \omega_{iz} x_{hiz} + \sum_{(i,j) \in E} \sum_{z \in P_a} \omega_{iz} x_{ijz} \leq -b_i \quad \forall i \in V_b \quad (3.13)$$

If "good" values are chosen for ω_{iz} the model assigns the most efficient workers to the appropriate workstations. When it comes to workforce development, this parameter determines the possibility that worker z is trained to be qualified to operate workstation i . It can also be used to give consideration to the fact that new workers are at the beginning of their individual learning curve and thus are not as fast as experienced workers.

3.6.2.6 Workforce acquisition

Referring to section 3.6.2.5 it might be of great value for a company to hire a worker with special capabilities. We now take into account the costs of workforce acquisition Φ_z . The costs of workforce acquisition are the costs of job advertisements, assessment centers and compensation for traveling for the applicants. In section 3.6.2.2 we introduced a dummy node h to be a hub between all workers represented by the nodes $i \in V_a$ and all workstations represented by the nodes $j \in V_b$ as depicted in figure 3.4. The edge e_{ih} has to be weighted with the cost of acquisition $c_{ih} = \Phi_z$ for all

workers considered to be hired. For the workforce on hand, the weight of e_{ih} remains 0.

Note that the supplying nodes $i \in V_a$ do not only represent the workers already on hand but also the workers to be hired. As a matter of fact, the graph should always contain extra workers, since they only cause costs, when they are assigned to any workstations.

3.6.2.7 Dismissal

When the order situation is declining and the workforce on hand exceeds the needs of the company, workers have to be dismissed by the employer. Usually workers can not be dismissed without any costs. Our model can take the cost of dismissal into account by adding a few nodes to the graph.

Consider employing a worker as an alternative to not employing him. For each worker on hand we now add a demanding node $j \in V_b$ to the graph that is directly hooked up to the supplying node $i \in V_a$ representing worker i . The weight c_{ij} of the added arcs has to be set to the costs that arise if worker i is dismissed. Referring to section 3.6.2.6, similar nodes have to be added to each worker considered to be hired. In this case the weight of the added arcs is $c_{ij} = 0$. Figure 3.5 illustrates this extension.

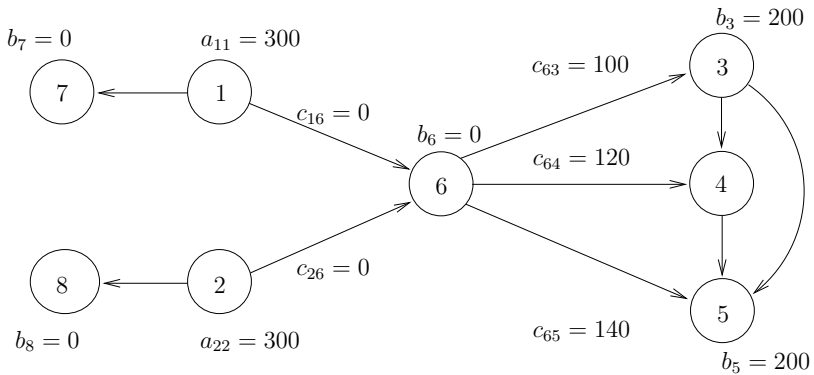

Figure 3.5: Network with alternative costs of dismissal

Note that the time demand b_j of the node representing the dismissal has to be equal to the time provided a_{ii} of worker i . In figure 3.5, a node representing dismissal was attached to each node $i \in V_a$, representing a worker. If a worker cannot be dismissed because of legal obligations or if

the company wants to keep a certain worker by any chance, then dismissal is not an alternative and no extra node has to be added.

3.6.2.8 On-the-job training

If a worker $z \in V_a$, regardless if he is to be hired or already in the workforce inventory, has to gain a further qualification to operate a workstation j , the costs for on-the-job training have to be taken into consideration. To take these costs into account, we introduce a new parameter $\mu_{jz} \geq 0$ to the objective function as depicted in (3.14).

$$\min \sum_{z \in P_a} \sum_{(i,j) \in E} (\lambda_z c_{i,j} + \mu_{jz}) y_{i,j,z} \quad (3.14)$$

The default value is $\mu_{jz} = 0$ for workers z who are already qualified to work at workstation j . Otherwise the individual costs of on-the-job training have to be taken. Since we are not following the concept of hierarchical skills, even the training for a workstation of a lower than the existing qualification can go along with extra training costs.

3.6.2.9 Overtime

In some cases, when demand of working time exceeds its supply, it might be cheaper to handle the work by overtime than by employing another worker. We now introduce a new set of nodes V_u that supply working time P_u to workstations. Further, the model has to undergo some structural modifications.

Let V_u be a set of nodes that supply working time. Let K be the set of arcs e_{ij} with $i \in V_u$ and $j \in V_b$ to connect all nodes V_u to each workstation. We now add a term to the objective function that represents the costs of the time supplied by the nodes V_u on basis of time units x_{ijz} .

$$\min \sum_{z \in P_a} \sum_{(i,j) \in E} (\lambda_z c_{ij} + \mu_{jz}) y_{ijz} + \sum_{z \in P_u} \sum_{(i,j) \in K} \lambda_z c_{ij} x_{ijz} \quad (3.15)$$

To control the amount of time that is supplied by overtime, we need to add the constrained (3.16) to our model.

$$\sum_{(i,j) \in K} x_{ijz} \leq a_{iz} \quad \forall i \in V_u, \forall z \in P_u \quad (3.16)$$

Furthermore, the overtime that is being delivered to the workstations has to be taken into account. We have to modify constrained (3.13) to:

$$\begin{aligned}
 - \sum_{(h,i) \in E} \sum_{z \in P_a} \omega_{iz} x_{hiz} + \sum_{(i,j) \in E} \sum_{z \in P_a} \omega_{iz} x_{ijz} - \\
 \sum_{(h,i) \in K} \sum_{z \in P_u} \omega_{iz} x_{hiz} \leq -b_i \quad \forall i \in V_b \quad (3.17)
 \end{aligned}$$

The variable x_{ijz} remains positive and continuous throughout the network such that

$$x_{ijz} \geq 0 \quad \forall (i,j) \in E \cup K, \forall z \in P_a \cup P_u \quad (3.18)$$

has to hold. Note that the costs c_{ij} for a worker to operate workstation j are based on annual costs. The parameter $\lambda_z, z \in P_u$, has to be determined that way, that $\lambda_z c_{ijz}$ represents the costs of one time unit overtime at workstation j . Each node $i \in V_u$ represents one pool to acquire working time on a basis of time units. Besides the option of overtime, the company can also rent workers on a basis of time units from temporary employment companies. This option would be represented by an extra node $i \in V_u$ with parameter $\lambda_z, z = i$, determined such that $\lambda_z c_{ijz}$ represents the charge for a worker.

Figure 3.6 illustrates an enhanced network $G = (V, H, c)$ with the set of nodes $V = V_a \cup V_u \cup V_b \cup V_l$ and the set of arcs $H = E \cup K$. In this example a maximum of 50 time units of overtime can be acquired within the represented company.

3.6.3 Model summary

We now summaries the model in (3.19) - (3.30) and give an overview of all parameters, sets and variables in table 3.5.

$$\min \sum_{z \in P_a} \sum_{(i,j) \in E} (\lambda_z c_{ij} + \mu_{jz}) y_{ijz} + \sum_{z \in P_u} \sum_{(i,j) \in K} \lambda_z c_{ij} x_{ijz} \quad (3.19)$$

N	Set of jobs with $i \in N$
M	Set of workstations $j \in M$
p_{ij}	Processing time of job i at workstation j
W	Set of workers $w \in W$
a_i	annual working time of worker $i \in W$
b_j	demand of working time at workstation $j \in M$
l_j	minimum number of workers at workstation $j \in M$
ω_{iz}	working efficiency of worker $z \in W$ at workstation $i \in M$
λ_z	Wage factor of worker $z \in W$
c_{ij}	cost of operating workstation j in addition to workstation i
μ_{jz}	cost of on-the-job training of worker $z \in W$ at workstation $j \in M$
Φ_i	acquisition cost of worker $i \in W$
B	sufficient large number
f	minimum number of working-time to operate a workstation, a worker is assigned to
G	Network (V, H, c)
V	Set of nodes $V_a \cup V_b \cup V_u \cup V_l$
V_a	Subset of workers
V_b	Subset of workstations
V_u	Subset of overtime suppliers
V_l	Subset of dummy nodes
H	Set of arcs $E \cup K$
c	weight of arcs
x_{ijz}	amount of working time z of worker i spent at workstation j
y_{ijz}	binary variable determining if worker i spends working time z in workstation j

Table 3.5: Model's parameters and variables

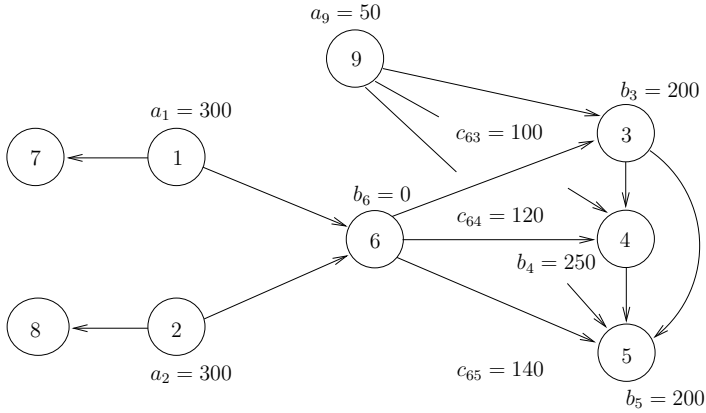

Figure 3.6: Enhanced network with overtime node $V_u = \{9\}$

s.t.

$$\sum_{(i,j) \in E} x_{ijz} = a_{iz} \quad \forall i \in V_a, \forall z \in P_a \quad (3.20)$$

$$\sum_{(i,j) \in K} x_{ijz} \leq a_{iz} \quad \forall i \in V_u, \forall z \in P_u \quad (3.21)$$

$$\sum_{(i,j) \in E} \sum_{z \in P_a} y_{ijz} \geq l_j \quad \forall j \in V_b \quad (3.22)$$

$$\sum_{(i,j) \in E} y_{ijz} \leq 1 \quad \forall j \in V_b, z \in P_a \quad (3.23)$$

$$\sum_{(i,j) \in E} f \cdot y_{ijz} \leq \sum_{(i,j) \in E} x_{ijz} - \sum_{(j,h) \in E} x_{jhz} \quad \forall j \in V_b, z \in P_a \quad (3.24)$$

$$- \sum_{(h,i) \in E} x_{hiz} + \sum_{(i,j) \in E} x_{ijz} \leq 0 \quad \forall i \in V_b, \forall z \in P_a \quad (3.25)$$

$$- \sum_{(h,i) \in E} x_{hiz} + \sum_{(i,j) \in E} x_{ijz} = 0 \quad \forall i \in V_l, \forall z \in P_a \quad (3.26)$$

$$- \sum_{(h,i) \in E} \sum_{z \in P_a} \omega_{iz} x_{hiz} + \sum_{(i,j) \in E} \sum_{z \in P_a} \omega_{iz} x_{ijz} - \quad (3.27)$$

$$\sum_{(h,i) \in K} \sum_{z \in P_u} \omega_{iz} x_{hiz} \leq -b_i \quad \forall i \in V_b$$

$$x_{ijz} \leq B \cdot y_{ijz} \quad \forall (i,j) \in E, \forall z \in P_a \quad (3.28)$$

$$x_{ijz} \geq 0 \quad \forall (i,j) \in E \cup K, \forall z \in P_a \cup P_u \quad (3.29)$$

3.7 Application

3.7.1 Environment

We applied the model to a medium-sized printing plant in northern germany. The company produces printed matters in a manufacturing-to-order manner. It owns two offset sheet fed printing machines, two offset continuous fed printing machines and one digital sheet fed printing machine.

The company meets the conditions for a successful application of our model: There are a broad variety of workstations and workers have to be cross qualified to operate the machines. Workstations require different levels of qualification which again depends on physical and mental abilities of the operators. The wage of the workers is payed according to the corresponding tariffs of the printing industry and its level depends on the qualification of the individual worker. Jobs are processed in a manufacturing-to-order manner in a job-shop environment and the workforce is scheduled in one or two shifts with annualized hours. That means, that the annual amount of working hours is fixed but the weekly amount can vary within given limits (see [20]).

The production line of the company is divided into three logical departments, as depicted in figure 4.1: pre-press, press and further processing. Each department contains a variety of workstations. The arrows from the administration towards the manufacturing departments mark the entry-points of jobs into production and the arrows between the manufacturing departments mark the processing-sequence. Usually, jobs are started in the pre-press department, but if the delivered data is ready for printing, the job can be directly processed in the press department. It also occurs that already printed material is being delivered just for further processing. In that case a job is started in the last production department.

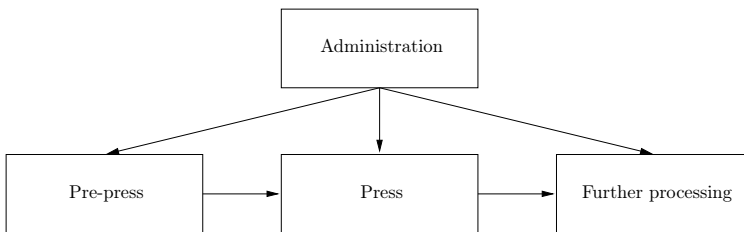

Figure 3.7: Organization of the printing plant

The heart of production are the printing machines. These machines are not only the most valuable but also the bottle-neck workstations. Thus, the administration's job scheduling is only done for the workstations belonging to the press departments. Pre-press workstations organize themselves, such that jobs are ready for printing at the time they are scheduled in the press department. The post-press workstations receive a delivery schedule from the administration to organize the job-sequence. As we will see later on, this method of organization is only possible because of the comfortable equipment of manpower the company used to have at the time of this research.

3.7.2 Data collection

We have access to extensive job data from the last seven years of the company. In this chapter we will apply the model to the historic data to analyze its performance. We will determine the optimal size and qualification of the workforce and illustrate the development of the workforce over the years. The regarded company is equipped with an electronic job-tracking system that stores all job-related data and provides information about the starting and finishing time of job i at workstation j and the worker that executed the process.

3.7.3 Job statistics

We now provide a brief analysis over several descriptive statistics of the company's job-structure. Table 3.6 gives an overview of the annual number of workstations and workers of the last seven years. The annual workload is the sum of the processing time of all jobs at all workstations that have been processed each year. The number of workers are full-time workers and the annual workforce capacity are the aggregate contractual working hours of all workers less 2% of absence due to sickness. The last column shows the ratio of workload to capacity.

The set of jobs N to be processed each year is depicted in table 3.7. The median number of days from the incoming order until delivery is between 9 and 11 days. Thus, jobs have to be scheduled in an ad hoc manner and the upcoming usage of resources is hard to be predicted.

Table 3.8 contains the mean and median weekly workload in hours from a selection of workstations from the year 2005. It also shows the minimum and maximum workload and range as well as the standard deviation. The analysis shows that the workstations' loads are very volatile. The infor-

Year	Workstations	Workers	Workload	Workforce Capacity	Ratio
2000	24	47	37621	75200	50%
2001	25	47	38115	75200	51%
2002	23	47	38162	75200	51%
2003	24	35	34333	56000	61%
2004	24	31	29202	49600	59%
2005	23	31	29760	49600	60%
2006	24	28	26438	44800	60%

Table 3.6: Annual workload and capacity

	2000	2001	2002	2003	2004	2005	2006
N	3551	3402	3137	2654	2554	2143	2253
Mean	13,1	14,2	13,4	12,9	13,3	13,0	11,9
Median	11	11	11	10	9	9	9
Std. Deviation	17,2	36,4	18,2	22,9	28,5	22,6	18,3

Table 3.7: Jobs and production time

mation about the maximum workload is especially important to set the parameter for the minimum number of workers l_j of workstation j .

A showcase of the annual distribution of workload is illustrated in figure 3.8 for workstation MAN704. The figure points out the distribution of demand over the year. Leveling the demand by shifting jobs is impossible due to huge over capacities within the printing industry. The customer is conditioned to get his jobs delivered within the above mentioned period of days. If the printer tries to shift the production of the job to a later point in time and thus delays the delivery, the customer will ask another printer to manufacture the job until the desired delivery date.

3.7.4 Method

To determine the future workforce structure, the time demand of each workstation has to be predicted for the regarded time period. Let the actual period be t , so that the workforce structure of $t + 1$ has to be determined. The model's parameters concerning the job data have to be predicted for the period $t + 1$. The parameters concerning the status quo of the workforce are taken from the actual period t . The resulting workforce structure for $t + 1$ will be next periods status quo. Figure 3.9 illustrates the approach.

Workstation	Mean	Median	Std. Dev.	Range	Min	Max
DTP	59,3	60,5	15,5	72,7	30,3	103,0
MAN706	43,2	47,5	14,4	60,5	18,3	78,8
MAN704	38,4	37,0	15,6	70,0	12,0	82,0
OPTI4	13,1	12,6	7,4	26,0	2,0	28,0
OPTI5	15,1	14,8	6,5	28,0	1,0	29,0
SAMMELHEFTER	12,2	11,3	6,1	28,1	2,0	30,1
COLLATOR	14,7	13,1	8,1	31,8	2,8	34,6
TISCH	88,5	83,8	39,4	204,2	24,0	228,2
SM52	17,0	17,3	7,0	42,5	3,9	46,4

Table 3.8: Workload statistics of a selection of workstations

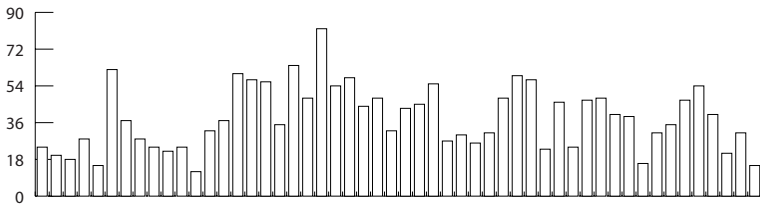

Figure 3.8: Weekly workload of workstation MAN704 in 2005

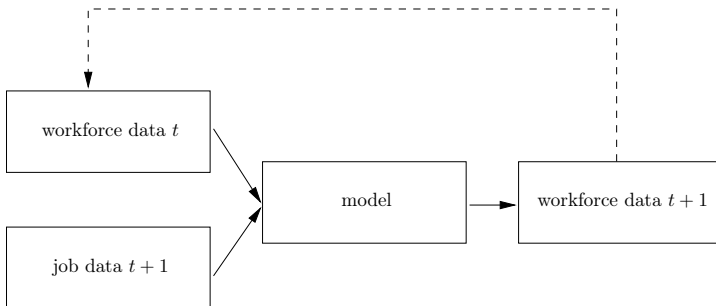

Figure 3.9: Model's input and output data

We have access to the companies complete job data as well as to the workforce data from the years 1999 to 2006. We start our model's computation in $t = 1999$ so that the workforce data is taken from the year 1999 and the job data is taken from the year $t + 1 = 2000$. The resulting workforce structure for the year 2000 will be depicted as the workforce structure $\overline{2000}$. So for our further computation the preceding results are taken as input data for the workforce structure. In $t = 2000$ the workforce structure $\overline{2000}$ will be used instead of 2000, and so on (see figure 3.10).

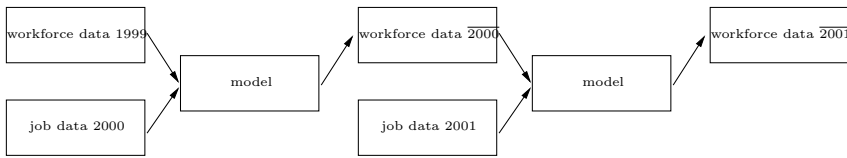

Figure 3.10: Model's input and output data

3.7.5 Determining the parameters

We will start out to determine the optimal workforce structure of the regarded company for the year 2000. As described in the previous section, we will gather the workforce data of the year 1999 and the job data for the year 2000. In this section we will illustrate how the data was collected and how the parameters were determined.

3.7.5.1 Job data

The application of our model to historic data allows us to use real world data for the number of jobs and the demand of workforce of each workstation. For this analysis we do not need to forecast any data. Thus we can make use of the detailed data provided by the job tracking system of the regarded company.

Each job receives a job number at the time it is initiated. When the job is processed, the starting time and the finishing time of each process as well as the job number, the workstation and the kind of process is stored by the operating worker via an electronic terminal in the job tracking system. The set of jobs N processed each year can be taken directly out of the database as we have already shown in table 3.7. The associated processing times p_{ij} could also be taken out of the database, being the difference between the

finishing and the starting time of each process. The set of workstations M was determined by analyzing which workstations were actually used during the regarded time period. The total demand of working time b_j at workstation $j \in M$ could be determined as described in section 3.6.

There are four workstation that are operated by a worker and an assistant. To consider the time demand for the assistants, a virtual workstation was created in the model for each real workstation that is operated with two workers. The virtual workstations time demand is equal to the time demand of the associated real workstation.

3.7.5.2 Minimum number of operators

To determine the minimum number of operators l_j needed for each workstation $j \in M$, we have to consider the job statistics. Let's first take a look at the minimum number of operators needed, if jobs could be shifted to level the demand. Let b_j be the annual demand of the regarded workstation j and let a be the annual working time of a full-time worker. Even if the parameter $l_j = 0$, the minimum number of operators for workstation j will result to be $\lceil \frac{b_j}{a} \rceil$. As we pointed out above, jobs can not be shifted to a great extend to level the demand of resources. Thus we have to segment the regarded period in sub periods to determine the minimum number of operators for each workstation l_j . We decided to perform an analysis on a weekly basis to determine the maximum time demand for each workstation $j \in M$. As already depicted in table 3.8, we determined the maximum weekly workload of each workstation. The parameter l_j is set to $l_j = \lceil \frac{b_{j\text{week}}}{a_{\text{week}}} \rceil$. Let's for example have a look at workstation TISCH. The annual time demand in the year 2005 was 4423 hours. A full-time worker works 1640 hours per year. If the demand of resources could be leveled over the year, the minimum number of operators would be $\lceil \frac{4423}{1640} \rceil = 3$. The maximum weekly time demand are 228 hours, though. Since a worker does not work more than 35 hours a week, a minimum number of $l_{TISCH} = \lceil \frac{228}{35} \rceil = 7$ operators are needed (compare[4]).

3.7.5.3 Individual capabilities

The huge number of individual worker specific parameters concerning the working efficiency ω_{jw} where determined in consultation with the managers of the departments. For the year 1999 we had to determine 24 parameters for each of the 47 workers. If a worker w was already qualified to operate a specific workstation j , we usually set $\omega_{jw} = 1$. If a worker's performance

was above-average though, the parameter was set to $\omega_{jw} > 1$. There were also workers being qualified to operate a certain workstation but who underperformed. In these cases the regarded parameters were set to $\omega_{jw} < 1$. The working efficiencies of operating a workstation a worker was qualified to at the time of this observation, ranged from $\omega_{jw} = 0.8$ up to $\omega_{jw} = 1.2$.

We want to point out, that the values for the parameters ω_{jw} are factors that specify the relation of the workers performance to the expected performance. The values of the parameters we set are only estimates, though. To achieve hard fact data, we would have had to predetermine a set of jobs to be processed at each workstation and take the time of each individual worker to complete the specific tasks. Because of the great expense of such a procedure and the bias to be expected when measuring a workers performance, we decided to use estimated values.

If a worker was not qualified to operate a specific workstation, we assumed that he would be able to operate each machine with at least 90% performance in the first year, after a training was applied. To exclude a worker from being trained to operate a specific workstation at all, his individual capability to operate that workstation was set to $\omega_{jw} = 0$. This was done, when the assignment of a worker to a specific workstation seemed to be hopeless in advance.

3.7.5.4 On-the-job training

The costs for on-the-job training are a composition of direct and indirect costs. Direct costs of training occur for materials, commercial training, costs of accommodation and travel. Indirect costs are the costs of the worker that occur while he is on training and therefore not involved in the production process. If the training is in-house and supervised by a second worker, his working time has also to be evaluated and assigned to the indirect cost of training.

Let's for example assume a worker that has to be trained to operate a workstation that he is not qualified to operate yet. The training is scheduled for two weeks, the first week at a remote training centre and the second week in the company. The in-house training is supervised by a qualified worker. We list the direct and indirect costs that would arise in such a scenario in table 3.9. In this example the total costs sum up to 3657,50 EUR

In the case of our regarded company, we had to determine the costs of on-the-job training μ_{jz} for every workstation j for all 47 workers z on hand. If a worker z is already qualified to operate workstation j , the parameter is

Description	qty	costs	sum
Working time of trainee	70	22 EUR	1540 EUR
Working time of supervisor	10	28 EUR	280 EUR
Materials		200 EUR	200 EUR
Commercial training	1	1250 EUR	1250 EUR
Travel	350	0,25 EUR	87,5 EUR
Accommodation	5	60 EUR	300 EUR
		sum:	3657,5 EUR

Table 3.9: Example of direct and indirect cost of on-the-job training

set to $\mu_{jz} = 0$. Otherwise the parameters were set to the costs of training as determined above. If a worker z is not supposed to be trained to operate a specific workstation j , the parameter is set to a sufficient large number $\mu_{jz} = B$.

3.7.5.5 Dismissal

In theory, the dismissal of a worker does not cause any costs. When a contract of employment is terminated within the period of cancellation, the worker will work until the last contractual day of work and then leave the company. In real life, the dismissal of employees due to operational aspects is tied to legal obligations. Employees to be dismissed have to be selected regarding to social aspects. We will not analyze and list all legal obligations regarding to this issue. But if a dismissal is not justified regarding to the legal obligation, a labor court usually sentences the employer to pay a compensation to the dismissed worker. As a rule of thumb the costs of dismissal can be approximated by multiplying a workers job tenure in years with half of his current monthly income. A worker with a monthly income of 2500 EUR who has worked for ten years at the company would get a compensation of 12500 EUR, if dismissed.

The cost of dismissal $diss_j$ may be higher than the annual wage of a specific worker. By taking the exact value, the model will always choose further employment instead of dismissal. To avoid this dilemma, the average annual cost of a longer time horizon has to be regarded. If we regard a strategic planning horizon of k years, then the average annual cost of a worker that will not be dismissed is $\frac{k \cdot wage_j}{k} = wage_j$ with $wage_j$ being the wage of worker j . In the same time horizon, the average annual cost of a dismissed worker will be $\frac{diss_j}{k}$. So, the average annual cost of dismissal for

a fixed time horizon has to be chosen for each worker, that can potentially be dismissed.

We set the time horizon k to determine the average annual cost of dismissal to four years. Further on, we had to consider the employees belonging to the workers' council. These workers $w \in W$ are irredeemable due to legal obligations. In these cases, the costs of dismissal are set to a sufficient large number $diss_w = B$.

3.7.5.6 Workforce acquisition

The cost Φ_w of workforce acquisition usually depends on the position to be occupied. The expenses of workforce acquisition rise with the requirements to the applicant. The costs to be considered are the costs for job advertisements, the costs for traveling expenses, the costs for assessment centers, and so on. These costs can be determined fairly good in advance.

A worker w to be occupied is treated like the workers belonging to the workforce inventory. Thus, he is part of the set of workers W . We have to set all parameters for worker w in advance. That way, the kind of worker to be hired can be controlled. The parameter a_w is to be set according to the position being a full-time or a part-time position. The costs of dismissal have to be set to $diss_w = 0$, since the regarded worker is not hired yet and not occupying him does not cause any costs.

The parameters referring to the individual capabilities and the costs of on-the job training can be set in a way to be very restrictive for our model or in a way that the needed skills of a worker to be hired are determined by it. If a worker has to be hired who is qualified to operate a certain subset of workstations, then working efficiency of worker w has to be set to

$$\omega_{jw} = \begin{cases} 1, & \text{for every workstation } j \in M \text{ the worker} \\ & \text{has to be qualified to operate,} \\ 0, & \text{for all other workstations.} \end{cases}$$

In our application we chose the least restrictive configuration. For all workers w to be hired, we set $\omega_{jw} = 1$ for all $i \in M$. That way, the model determines the qualification profile of the applicant in the way, the new worker can be employed most efficiently. In other words: the subset of workstations, the new worker w is assigned to by the model, determines the requirements for the applicant to be hired.

The costs of on-the-job training are usually set to $\mu_{jw} = 0$ for all workstations $j \in M$ and w being the worker to be hired. Only if there are workstations, a new employee can not be familiar to, μ_{jw} has to be set to the appropriate value.

3.7.5.7 Overtime

As introduced in section 3.6.2.9, a new node $w \in V_u$ is added to the network, to supply the demanding nodes $j \in V_b$ with overtime. Every supplying node of overtime is treated just like a worker and thus all the individual parameters have to be set as well.

In the regarded company, the maximum amount of overtime over all workers was set to 1000 hours per year. Thus the working time of the overtime supplying node i was set to $a_w = 1000$. The corresponding wage factor was set to $\lambda_w = \frac{1}{1640}$, to let the hourly wage correspond to the annual wage of a worker. There are no acquisition costs and no costs of dismissal, thus $\omega_{jw} = \text{diss}_w = 0$. We set the working efficiency to $\omega_{jw} = 1$ for all $j \in M$, to allow overtime at all workstations. If there are workstations $j \in M$ that have to be excluded from receiving overtime, the workforce efficiency has to be set to $\omega_{jw} = 0$.

We did not choose to engage with temporary employment companies, so the overtime supplying node was the only further node added to our network.

3.7.5.8 Costs and wages

The underlying tariff for the german printing industry is partitioned into seven wage brackets. Each wage bracket corresponds to certain tasks, a worker can execute. The more ambitious the tasks, the higher the demand to worker's qualification and thus the higher the worker's wage.

The tasks to be executed to operate each workstation $j \in M$ in the regarded company were assigned to the wage brackets, leading to an explicit declaration of how much a worker earns if he is assigned to a certain workstation.

Referring to section 3.6.2.1 we can now determine the costs c_{ij} of operating workstation j in addition to workstation i . The setup of the network is now complete.

3.7.6 Computational results

After gathering the data, we setting up the network. The graph turned out to have 70 nodes and 216 arcs. The corresponding MIP hat 17780 columns and 18820 rows.

We started our computations as described in section 3.7.4. The computations were executed with CPLEX 10.0 on a 2.5 GHz AMD cpu. When first testing the model, we started to set the time limit to 24 hours. We observed that there were no improvements of the objective values after about 15 minutes of cpu time in none of the tested problem instances, so we set the time limit to 20 minutes. Since the model is used for long-term staffing and results are not time critical, no high performing heuristics are needed for solving.

To compute the workforce structure for the year 2000 we used the job data of the regarded year and the workforce data of the year 1999. The objective value of the model results to $F = 894630$ EUR.

3.7.7 Analysis of the results

3.7.7.1 Objective value

If the results of the model would be applied to the company's workforce structure for the year 2000, the objective value is less than the actual predicted costs of the workforce. On the one hand the cost of dismissal where reduced to the average value of the next four years, so these costs have to be replaced with the actual affecting payment costs. On the other hand the sum of the wages of the workers are computed on the basis of the plain tariff wages. Depending on workforce scheduling, workers can receive surcharges on their wage, depending on the daytime they are scheduled, which will lead to higher annual expenses for the company. Minimizing these costs is addressed by short-term workforce planning.

3.7.7.2 Evaluation of the variables

In the year 1999 the company employed 44 workers. Four of these workers were part-time-workers, the rest of them were full-timers. The sum of the annual working time provided by these workers was 70022 hours, facing a demand of 37621 hours in the year 2000. Thus, there was an overcapacity of 86%.

The model's result for the year 2000 let the overcapacity almost vanish. 22 workers had to be dismissed, one full-time-worker had to be hired and

981 hours of overtime were required. On-the-job training had to be done for 20000 EUR. The working-time provided by the remaining workers sums up to 37167 hours. Adding the amount of overtime, 1,4% overcapacity was left within the company.

Table 3.10 gives an overview of the aggregated results for the year 2000. As we can see, the supply of workforce meets each workstations' demand in almost every case exactly. The apparent under-coverage of workforce at some workstations results from the fact, that some workers working-efficiency was set to a value $\omega_{jw} > 1$ for specific workstations. Let's for example take a look at workstation '46'. The worker with the number 3178 (see table 3.11) , who is assigned to work 1579 hours at that workstation, has a working-efficiency of $\omega_{46,3178} = 1,2$. Multiplying the assigned working hours with the surplus of that worker's working-efficiency computes to $1579 \cdot 0,2 = 315,8$. Thus the apparent under-coverage of 315 hours at workstation 46 is compensated by worker 3178's advantage in working efficiency.

The over-coverage of workforce regarding some other workstations can be explained as follows. On the one hand the over-coverage derives from the same circumstances than the apparent under-coverage. In some cases, workers with a working-efficiency of $\omega_{jw} < 1$ are assigned to workstation w . On the other hand, the total workforce supply is the sum of the contractual annual working time of all workers. An over-coverage of supply is assigned to arbitrary workstations by the model.

Table 3.11 contains the qualification matrix of the workforce for the year 2000. The columns represent the workstations and each row represents a worker. It can be seen, that the number of bullets in each column add up to the minimum number of workers l_i as depicted in table 3.10.

3.7.7.3 Further results

The procedure of data collection and parameter setup was repeated for each regarded period. For the following computations, the preceding results of the workforce structure was used respectively, as described in section 3.7.4. Table 4.2 shows the results for each period.

The model adjusted the workforce capacity of the company to its demand by dynamically modifying the workforce structure. The time gap is the ratio of capacity to demand. The apparent under-coverage in the year 2002 is due to the same reasons as described above, when workers with a high working-efficiency are assigned to appropriate workstations. The annual limit of 1000 hours of overtime was not reached, neither was it dis-

Workstation	i	l_i	supply	demand	Δ
Linotype-Topas-Scanner	11	2	1537	1537	0
CTP-Krause Laserstar 110	27	2	759	741	18
Plattenkopie konventional	28	2	1715	930	785
DTP (Bogen u. Endlos)	10	5	4189	4337	-148
Opti 3	30	1	1194	1194	0
Opti 4	31	1	1251	1251	0
Opti 5	32	1	1626	1626	0
Bielomatic Rollencollator	51	2	1688	1688	0
706 Hilfskraft	46H	2	2270	1930	340
Speed SM 52	41	2	1640	1640	0
MAN Roland 702	42	2	863	876	-13
MAN Roland 706	46	2	1615	1930	-315
Heidelberger Tiegel	49	1	172	172	0
Opti Hilfe	30H	3	4071	4071	0
Rollencollator Hilfskraft	51H	2	1862	1688	174
Müller-Martini Sammelhefter Hilfskraft	66H	2	1009	1009	0
Hunkeler Snapband-Automat	55	1	164	164	0
Schobercollator	50	1	55	55	0
Sped-Clect Zusammentragmasch.	64	1	362	362	0
Müller-Martini Sammelhefter	66	2	1009	1009	0
Planschneider	60	3	1500	1500	0
Falzmaschinen	62	4	2051	2365	-314
Tisch/kl.Maschinen/Vers.Bogen	68	7	4460	4460	0
Logistik-Lager Feuersozietät	88	1	1086	1086	0
			38148	37621	

Table 3.10: Aggregated results for the year 2000

	11	27	28	10	30	31	32	51	46H	41	42	46	49	30H	51H	66H	55	50	64	66	60	62	68	88	
3201																									
3200																									
3308																									
3143																									
3357																									
3196																									
3309																									
3203																									
3178																									
3215																									
3265																									
2443																									
2042																									
3046																									
3304																									
3350																									
3319																									
2335																									
2124																									
3361																									
2113																									
8888																									
overtime																									

Table 3.11: Qualification matrix of the company’s workforce for the year 2000

Year	W	Capacity	Overtime	M	P_i	Time Gap	$\frac{UB-LB}{LB}$	F
1999	44	70022						
2000	23	37167	981	24	37621	98,6%	4,00%	894.630
2001	23	37167	969	25	38115	99,9%	4,00%	850.707
2002	23	37167	513	23	38162	101%	12,00%	947.979
2003	23	37167	787	24	34333	90%	4,00%	835.554
2004	21	33887	543	24	30675	89%	3,00%	774.607
2005	20	32247	892	23	29760	90%	5,00%	745.217
2006	17	27327	102	25	26438	96%	12,00%	510.837

Table 3.12: Computational results

claimed in any period. Thus the possibility of using overtime is actively used to smoothen the fixed-step costs of hiring an additional worker.

3.7.7.4 Workforce development

To meet the changing requirements of the job-structure the company faces each period, workers have to be assignable to different workstations within each period and they have to be assignable to different workstations from period to period. Let's take a look at a resulting qualification profile of our computations. Table 3.13 shows the workstations and the working hours, worker with the number 3178 was assigned to each period. The workers' qualification profile in period 1999 covers the workstation 41, 42, 46 and 28. In the year 2001 he was trained to operate workstation 44. Thus the worker's qualifications profile is equal to the set of workstations he is assigned to over the years. The assignment profile is a subset of the qualification profile and may change each period.

The amount of working-time the worker is assigned to each workstation is not to be seen as a definite value but as the approximate share of his annual working-time he contributes to the processing of the occurring jobs.

	1999	2000	2001	2002	2003	2004	2005	2006
44 MAN Roland 704			35	35	1130	741	1123	245
41 Speed SM 52	67		35		35	899		
42 MAN Roland 702	332	60						
46 MAN Roland 706	372	1579	1570	1605	475		516	1395
28 Plattenkopie konventional	8							

Table 3.13: Changing qualification and assignment profile

3.7.8 Conclusion

We were able to adjust the supply of workforce to its demand with respect to a given flexibility of the resulting workforce structure. Regarding the workforce development, workers were assigned to workstations with respect to their individual capabilities. In our retrospective analysis, the gap between working capacity and working demand, was tightened to up to 100%. In a forecasting analysis, where time demand is approximated, it might come to bottlenecks in the operational supply of available manpower. Thus the entrepreneur is still in charge to react to upcoming shortages by extending the amount of overtime to be worked in his company or to hire temporary workers, in case they are available from the local labour market.

Bibliography

- [1] William J. Abernathy. A three-stage manpower planning and scheduling model—a service-sector example. *Operations Research*, 21(3):693–711, 1973.
- [2] Hyun-Soo Ahn, Rhonda Righter, and J. George Shanthikumar. Staffing decisions for heterogeneous workers with turnover. *Mathematical Methods of Operations Research*, 62:499–514, 2005.
- [3] Carlos S. Azmat, Tony Hürlimann, and Marino Widmer. Mixed integer programming to schedule a single-shift workforce under annualized hours. *Annals of Operations Research*, 128(1-4):199–215, 2004.
- [4] Carlos S. Azmat and Marino Widmer. A case study of single shift planning and scheduling under annualized hours: A simple three-step approach. *European Journal of Operational Research*, 153(1):148–175, 2004.
- [5] Jonathan F. Bard. Selecting the appropriate input data set when configuring a permanent workforce. *Computers and Industrial Engineering*, 47:371–389, 2004.
- [6] Jonathan F. Bard. Staff scheduling in high volume service facilities with downgrading. *IEEE Transactions*, 36:985–997, 2004.
- [7] Oded Berman and Richard C. Larson. Optimal workforce configuration incorporating absenteeism and daily workload variability. *Socio-Econ. Plann. Sci.*, 27(2):91–96, 1993.
- [8] Oded Berman, Richard C. Larson, and Edieal Pinker. Scheduling workforce an workflow in a high volume factory. *Management Science*, 43(2):158–172, 1997.

- [9] A. Billonnet. Integer programming to schedule a hierarchical workforce with variable demand. *European Journal of Operational Research*, 114:105–114, 1999.
- [10] E.K. Burke, P. Cowling, P. De Causmaecker, and G. Vanden Berghe. The state of the art of nurse rostering. *Journal of Scheduling*, 7:441–499, 2004.
- [11] R.N. Burns and M.W. Carter. Work force size and single shift schedules with variable demands. *Management Science*, 31(5):599–607, 1985.
- [12] X. Cai and K.N. Li. A generic algorithm for scheduling staff of mixed skills under multi-criteria. *European Journal of Operational Research*, (125):359–369, 2000.
- [13] Richard L. Daniels, Joseph B. Mazzola, and Dailun Shi. Flow shop scheduling with partial resource flexibility. *Management Science*, 50(5):658–669, 2004.
- [14] Andreas Drexl and Martin Mundschenk. Long-term staffing based on qualification profiles. *Mathematical Methods of Operations Research*, (to appear), 2008.
- [15] Guy Eitzen, David Panton, and Graham Mills. Multi-skilled workforce optimisation. *Annals of Operations Research*, (127):359–372, 2004.
- [16] Hamilton Emmons and Richard N. Burns. Off-day scheduling with hierarchical worker categories. *Operations Research*, 39(3):484–495, 1991.
- [17] A.T. Ernst, H. Jiang, M. Krishnamoorthy, and D. Shier. Staff scheduling and rostering: A review of applications, methods and models. *European Journal of Operational Research*, 153:23–27, 2004.
- [18] P. Egeborn and M. Rönnqvist. Scheduler – a system for staff planning. *Annals of Operations Research*, 128:21–45, 2004.
- [19] Richard C. Grinold. Manpower planning with uncertain requirements. *Operations Research*, 24(3):387–399, 1976.
- [20] R. Hung. Scheduling a workforce under annualized hours. *International Journal of Production Research*, 37(11):2419–2427, 1999.

- [21] Martin Mundschenk and Andreas Drexl. Workforce planning in the printing industry. *International Journal of Production Research*, 45(20):4849 – 4872, October 2007.
- [22] Gary M. Thompson and John C. Goodale. Variable employee productivity in workforce scheduling. *European Journal of Operational Research*, 170:376–390, 2006.
- [23] J. Wijngaard. Aggregation in manpower planning. *Management Science*, 29:1427–1435, 1983.

Chapter 4

Holiday planning of a heterogenous workforce

Holiday planning of a heterogenous workforce

Martin Mundschenk

Institut für Betriebswirtschaftslehre, Christian-Albrechts-Universität,
Kiel, Germany, m.mundschenk@mundschenk.de

Abstract In medium-sized manufacturing-to-order companies, the workforce can not be considered homogenous. In fact, workers are often cross qualified to operate different workstation and the level of heterogeneity among the workers tends to be high. When setting up shift and holiday schedules, the operational requirements of the company, the contractual restrictions as well as the individual preferences of the workers have to be considered. Particularly the heterogeneity and the associated dependencies among the workforce, make it difficult for personnel planners to schedule the workforce on hand in terms of optimality. Motivated by empirical observations, we developed a mixed integer model, to schedule a heterogeneous workforce under annualized hours. Because of the flexibility of the model to real life factors, it can be used by personnel planners to generate optimal schedules for shift an holiday planning.

Keywords: Workforce, scheduling, qualification profile, manufacturing-to-order, heterogenous, annualized hours, computational/empirical evaluation

4.1 Introduction

In medium-sized companies, heterogeneous qualifications of individual workers is a key to face the requirements of the market to satisfy varying demands. In a manufacturing-to-order company where the production of products is spread over a number of workstations, workers have to be available to operate these workstations in order to guarantee an unobstructed production process. During the last decades, the european labor markets responded to the managerial needs of flexible working time of the workforce. That way it became possible to satisfy changing demands within a planning horizon. In many industries the capacity utilization depends on different seasons of the year such that the order situation may be high or low. The "annualization" of working time helps to avoid the effects of fluctuating demands. From the view of the company, the operational task is to

schedule the workforce such that the demand is satisfied over the planning horizon in a way that does not lead to an under-coverage of workforce when demand is high and does not lead to an over-coverage when demand is low.

This research is motivated by an observation within a medium-sized printing company producing build-to-order printing matters. When it came to holiday planning, the responsible persons were unable to survey the complexity of the dependencies in-between workers with heterogeneous qualifications. The resulting holiday plans either lead to under-coverage because workers who usually work at different workstations but have the ability to substitute for each other were sent into holidays at the same time, or possibilities of substitutions were not exploited, such that workers were not allowed to take their holidays even though it might have been possible, leading to individual disaffection. Furthermore, the personal dispatchers had no tool to level the individual annual working-time. When upcoming demand of working-time was high, workers' shift-lengths were extended, leading to an accumulation of overtime. When the upcoming demand was low, the personal dispatchers missed to shorten the shift-lengths, such that overtimes were not cut back. We further observed, that when demand was low, workers started to slow down, so that a regular shift was still filled with work, instead of producing at regular speed and going home earlier.

The contribution of this paper is that it delivers a mixed integer programming model to help personal dispatchers to schedule the workforce over the year under annualized hours by taking the heterogeneity of the workforce into account. The latter plays an important role, when the weeks off planning, or holiday planning, is done. In a heterogeneous workforce, the dependencies of individual workers to substitute for each other might be highly restricted.

The outline of the paper is as follows: In section 4.2 we introduce different concepts and assumptions of the workforce structure, found in literature. The literature is reviewed in section 4.3. In section 4.4 we outline the problem and introduce skill matrices. The integer programming model is developed in section 4.5 and tested with historic data in section 4.6. We illustrate the complexity of a real life problem and show how the model is successfully applied to plan the holidays for the entire workforce of a manufacturing-to-order company in section 4.7.

4.2 Workforce structure

In the manufacturing-to-order industry, the production workflow can be very complex. A product passes a variety of different workstations until it is completely manufactured. Also, the time needed for production at a certain workstation can vary from product to product. And not every product has to pass each workstation. As a result, the total working time that emerges in a certain time horizon differs from workstation to workstation. In other words: each workstation has a different time demand. In low or medium automated industries and in office domains, workstations are operated by workers. Each worker is a provider of working time. In return, he receives a wage from the company. All workers together represent the workforce of the company.

4.2.1 Homogeneous workforce

In a wide area of the workforce planning literature, workforce is considered to be homogeneous. That means, that every worker has the same skills, the same quality and earns the same amount of money. All workers do the same job and can easily be substituted by each other. This can be found in wide areas of the service sector like call centers or postal services.

The assumption of homogeneity simplifies short term scheduling and makes long term planning superfluous in terms of workforce development or labour selection as long as the labour market has a supply of the type of worker needed.

4.2.2 Heterogeneous workforce

In the predominant part of real life, the companies workforce is heterogeneous. On the one hand there is heterogeneity on the individual level: people have different skills and interests. They work with different quality and speed. They differ in age and experience. On the other hand, the kind of work, each worker processes and the workstations he is assigned to, requires an individual qualification. Depending on the level of qualification and experience on the job, workers earn different amounts of money from the company.

Heterogeneity of workforce makes staffing very complex and addresses the domain of strategical, long term workforce planning.

4.2.2.1 Hierarchical skills

In a heterogeneous workforce, there are workers with different levels of qualification. High qualification correlates with high income. Hierarchical skills assume that high qualified workers can substitute for a lower qualified one, but not vice versa (see [5]). That means, that a high qualified worker can handle all kinds of jobs and operate all workstations that lower qualified workers, down to the lowest level, can do. The procedure in which higher skilled workers are substituted for lower skilled ones is sometimes called *downgrading* (see [4]). As an example you can think of a pilot who is scheduled to fly as a copilot because of an absence of a real copilot. The pilot still receives his full wage but performs a lower qualified job.

The assumption of hierarchical skills is pretty vague though and does not hold in many environments. Consider a factory department with a fairly high number of different workstations. All operators have the skill to operate the workstation they are assigned to and they all earn the appropriate wage. The supervisor of that department is on the next hierarchical level and receives a higher income. Still he can not be expected to substitute for each and every worker in his department even though there are a few workstations he might be able to operate. The achievement of a higher qualified skill (like supervising) does not go hand in hand with the achievement of all skills that are needed on lower qualification levels.

4.2.2.2 Job switching

A different and more realistic concept of heterogeneous workforce is the concept of job switching. Job switching means that a worker is qualified and can be assigned to operate two or more workstations. All workers can be differently qualified and can substitute each other only at workstations where common qualifications exist. The highest qualification determines the wage a worker receives from the company.

In this paper we follow the concept of job switching since this is what can be observed in the manufacturing-to-order industry.

4.3 Literature review

Generally scheduling studies in industry can be divided into two sets of approaches: *one-shift workforce problems* and *multiple-shift workforce problems*. In both cases four sub-problems are relevant (see Azmat and Widmer [3] for a literature review):

- *Regular work schedule:* Five work days per week
- *Compressed work schedule:* Three, four or three-four work days per week
- *Hierarchical workforce schedule:* Different classes of workers are taken into account (class A worker is able to perform job A, class B worker is able to perform jobs A and B, and so on).
- *Annualized hours schedule:* The number of work hours per week is not fixed, but the annual amount of work hours is fixed.

The concept of an hierarchical workforce is a subset of the concept of heterogeneous workforce, dealt with in this paper. Unlike other models, where a preset number of different groups of workers and their qualifications is given, we present a model where each worker can have individual qualifications. The mapping of the workers and their individual qualifications is done in the skill matrix, introduced in the next section. Thus our model combines the annualized hours sub-problem with an extended heterogeneous workforce schedule.

A recent paper using skill matrices was issued by Daniels et al. [7]. They point out that in production-line environments partial labor resource flexibility is a particularly important issue that is determined by the extent to which workers are cross-trained to perform a subset of the tasks occurring within the line. Their objective is to minimize the total makespan in a flow-shop environment by jointly optimizing the job sequence, the processing rate and the feasible, dynamic labor allocation. A skill matrix has to be identified, that minimizes to flow shop rescheduling problem with partial resource flexibility. In their computational experiments they only address problems where the number of workers is equal to the number of workstations and results are only presented for instances with at most 5 workers / workstations. Nevertheless, the research represents an important step towards understanding the benefits of partial workforce flexibility and also towards characterizing effective ways in which workers should be cross trained.

The multi-skilled workforce optimization with non-hierarchical skills was also addressed by Eitzen et al. [8]. The problem is to schedule workers with 5 skill classifications to shifts of a power station to obtain a 12 week schedule. Every worker is supposed to have a core skill level, a supplementary skill level and sometimes an optional skill level. They formulate a generalized set-covering model, where the assignments of workers to shifts are represented by 'tours of duty' which again are represented as columns.

The objective is to minimize the number of understaffed shifts. Since the number of columns increases rapidly with the number of skill levels, they present a branch-and-price method with constrained branching to solve the model to optimality.

Emmons and Burns [9] criticize, that combinatorial results in the workforce planning literature are always based on the assumption of a single type of worker. They take workforce heterogeneity into account, but assume a hierarchical workforce. Their model's objective is to minimize the total costs of the workforce subject to scheduling constraints and under the assumption, that the requirements of each type of worker and therefore the requirements of certain skills, are constant over the planning horizon. The assumption of hierarchical skills and the assumption that demand does not underly any stochastic components, does not make their model applicable to a wide range of real world problems.

Cai and Li [6] present a generic algorithm for scheduling staff of mixed skills. They are motivated by the fact that traditional research usually considers only simplified models with staff having homogeneous skills. They consider the existence of jobs requiring different skills and employees of multiple skills who can be assigned to do different types of jobs as needed. In their model, they regard two kinds of jobs and three types of workers, whereas only one type of worker can be assigned to either kind of job. As soon as the number of jobs and the possible types of workers increase, the structure of their model has to be adjusted and would lead to a complexity that is unmanageable.

Eveborn and Rönnqvist [10] developed a software to solve real-world scheduling problems of the service industry. Their underlying model uses a column generation technique to create a set of individual schedules that are valued with points, taking into account the overall costs of a schedule as well as the individual preferences of the employees concerning working times. They assume a heterogeneous work-force with each individual having different skills. Overtime and flexible working times are also taken into account. They assume the work-force demand as given.

4.4 Problem description

We consider a medium-sized manufacturing-to-order company with a heterogeneous workforce. Each worker can operate one or more workstations. Enterprises working under annualized hours are confronted with the problem to assign the appropriate workers to the same shift such that enough

working time is available at each workstation to handle the predicted work to manufacture the upcoming jobs. When the job-queue is known and the workforce inventory is setup to the needs of the company, a good schedule might be obtained. But what happens when workers are absence? Absences can be due to sickness or due to the contractual holiday each worker receives. Sickness can not be planned in advance of course. But the weeks-off can be. In a broad range of european industries, workers claim 30 work-days of holidays per year. That is almost 12% of all work-days of an entire year. When the workforce is heterogenous and no worker can be fully substituted by an other worker, each worker's holiday has to be carefully coordinated with all other workers' holidays. Because this issue is very complex and leads to delays or production downtimes, when it is not done carefully, many medium-sized companies tend to do plant shutdowns for a couple of weeks and send all workers into holidays at the same time.

4.4.1 Skill and assignment matrices

To understand the concept of an heterogenous workforce we now introduce the concept of the skill and assignment matrix, which are important in the remainder of this paper. This matrix contains the information which workers are assigned to which subset of workstations, they are qualified to operate. For convenience, we will typically refer to the skill and assignment matrix as the *skill matrix*. We refer to the paper of Daniels et. al. [7] who treat the issue of partial resource flexibility of workforce and also follow the concept of skill matrices to specify which workers are trained to operate each of the workstations.

Let $W = \{1, 2, \dots, w\}$ denote the set of workers and let $M = \{1, 2, \dots, m\}$ denote the set of workstations. We now define the $w \times m$ matrix $S = (s_{im})$, $i \in W, m \in M$, as

$$s_{im} = \begin{cases} 1, & \text{if worker } i \text{ is trained to operate workstation } m; \\ 0, & \text{otherwise.} \end{cases}$$

Each row of the skill matrix S corresponds to a worker $i \in W$. The set $M_i^S = \{m \in M : s_{im} = 1\}$ is the set of workstations for which worker i is appropriately trained and to which he can be assigned. Let $m_i^S = |M_i^S|$ be the number of such workstations. We can now specify the two extreme cases with $m_i^S = 1, i \in W$, on the one hand corresponding to no flexibility

at all and $m_i^S = |M|, i \in W$, on the other hand, with every worker skilled to operate each workstation.

Similarly, for each column of S corresponding to workstation $m, m \in M$, the number of workers who are trained to operate workstation m is given by $w_m^S = |W_m^S|$, where $W_m^S = \{i \in W : s_{im} = 1\}$.

Consider a setting with $M = 4$ workstations and $W = 4$ workers. Each workstation requires a different skill level. We assume, that workstation 1 requires the lowest and workstation 4 the highest qualification to be operated. Suppose that

$$S = \begin{pmatrix} 1 & 0 & 0 & 0 \\ 0 & 1 & 1 & 0 \\ 0 & 0 & 1 & 1 \\ 0 & 0 & 0 & 1 \end{pmatrix}.$$

In this example worker 1 is trained and assigned only to workstation 1; worker 2 is trained and assigned to workstations 2 and 3, and so on. Thus, the skill sets of the workers are $M_1^S = \{1\}$, $M_2^S = \{2, 3\}$, $M_3^S = \{3, 4\}$ and $M_4^S = \{4\}$. Note that workers 3 and 4 have the highest qualification. But since we are not following the concept of hierarchical skills, we don't suppose that they are trained to operate all workstations associated to lower levels of qualification. Even if worker 4 is actually trained to operate workstation 1, he is not assigned to work there. Moreover, even though worker 4 is not as flexible as worker 3, worker 4 spends his whole working time at workstation 4 so he can be regarded as a specialist with high potential to gain a high level on his individual learning curve to operate his workstation.

4.4.2 Restrictions

Since we are not following the concept of a hierarchical workforce, we have to develop a scheduling scheme that takes the different qualifications and abilities of the individual workers into account. Furthermore we have to consider overtime as well as temporary workers. To bring this research as close as possible to reality, a set of legal constraints have to be considered, that can be adjusted to the prevalent obligations of the regarded country. The following constraints are taken from Azmat and Widmer [2] and are adjusted to the legal obligations of the german tariff of the printing industry:

L1: Each worker must receive at least one day-off per week. Sunday is normally considered as day-off;

L2: Each worker must receive at least 30 days of holiday per year;

L3: Each worker has the right to receive at least three consecutive weeks of holidays a year;

L4: Companies fix holiday periods, taking into account as far as possible the worker's individual wishes;

L5: The maximal work length per week is fixed to 55 hours. The normal work time is spread over 5 days a week;

L6: When annualized hours are considered, the workload can be spread irregularly over the year;

L7: The normal work duration per year of a full-time-worker is fixed to 1820 hours: 52 weeks with 35 hours per week (as each worker receives 30 days holiday, he works in fact a maximum of 1680 hours per year).

The aim of our model is to maximally satisfy all workers individual preferences to receive certain weeks of holidays and to determine a schedule such that all legal constraints are met and that the predicted demand of workforce for each workstation is covered at each point in time within the regarded planning horizon.

4.5 Model

The approach is based on a MIP-formulation to allocate the holiday weeks for each worker. Our formulation is an adaption of Azmat's et al. [2] MIP that we have modified to schedule a heterogeneous workforce and to consider individual circumstances of each worker regarding contractual or individual issues. A valid solution of the problem delivers the information whether a worker is scheduled on a specific day during the planning horizon and how long his shift will be. Thus, a solution also contains a worker's days and weeks off, yielding to the individual holiday plan.

In a manufacturing-to-order company with random demand of working-time, the allocation of shifts and the determination of their lengths, up to 52 weeks in advance can only be an indication or a tendency. Particularly

shift lengths have to be adjusted to the upcoming demand, when it comes closer and can be predicted with more reliability. Nevertheless, holiday weeks have to be planned in advance, in order to give planning reliability to the private plans of the workers and to the operational needs of the personnel dispatcher. Table 4.1 gives an overview of the parameters and variables used in the model.

$$\min \sum_{i \in W} \sum_{j \in J_i^W} \theta_i \tau_{ij} y_{ij} + \sum_{i \in W} \sum_{j \in J_i^W} \sum_{k \in K_j} (e_{ijk}^+ + e_{ijk}^-) \quad (4.1)$$

s.t.

$$\sum_{j \in J_i^W} \sum_{k \in K_j} (\lambda_i x_{ijk} + e_{ijk}^+ - e_{ijk}^-) = a_i \quad \forall i \in W \quad (4.2)$$

$$\sum_{j \in J} \sum_{k \in K_j} (\lambda_i x_{ijk} + e_{ijk}^+ - e_{ijk}^-) = a_i \quad \forall i \in W \quad (4.3)$$

$$\lambda_i x_{ijk} + e_{ijk}^+ - e_{ijk}^- \geq 0 \quad \forall i \in W, j \in J, k \in K_j \quad (4.4)$$

$$e_{ijk}^+ \leq B \cdot x_{ijk} \quad \forall i \in W, j \in J, k \in K_j \quad (4.5)$$

$$e_{ijk}^- \leq B \cdot x_{ijk} \quad \forall i \in W, j \in J, k \in K_j \quad (4.6)$$

$$\sum_{j \in J_i^W} \sum_{k \in K_j} x_{ijk} \geq \delta_i \quad \forall i \in W \quad (4.7)$$

$$\sum_{i \in W} x_{ijk} s_{im} \geq V_{jm} \quad \forall j \in J; k \in K_j; m \in M \quad (4.8)$$

$$\sum_{i \in W} \sum_{k \in K_j} (\lambda_i x_{ijk} + e_{ijk}^+ - e_{ijk}^-) \geq d_j \quad \forall j \in J \quad (4.9)$$

$$\sum_{k \in K_j} x_{ijk} \leq |K_j| \cdot y_{ij} \quad \forall i \in W; j \in J_i^W \quad (4.10)$$

$$\sum_{j \in J_i^W} y_{ij} = \gamma_i \quad \forall i \in W \quad (4.11)$$

$$y_{ij} + y_{i(j+1)} + y_{i(j+2)} \leq 3 \cdot z_{ij} \quad \forall i \in W; j \in \hat{J}_i^W \quad (4.12)$$

$$\sum_{j \in \hat{J}_i^W} z_{ij} \leq \mu_i \quad \forall i \in W \quad (4.13)$$

$$x_{ijk}, y_{ij}, z_{ij} \in \{0, 1\} \quad \forall i \in W, j \in J, k \in K_j \quad (4.14)$$

$$0 \leq e_{ijk}^+ \leq \rho_i^+ \quad \forall i \in W, j \in J, k \in K_j \quad (4.15)$$

$$0 \leq e_{ijk}^- \leq \rho_i^- \quad \forall i \in W, j \in J, k \in K_j \quad (4.16)$$

M	set of workstations
W	set of workers
J	set of weeks within the planning horizon
J_i^W	set of weeks worker $i \in W$ can be assigned to a shift; $J_i^W \subseteq J$
\hat{J}_i^W	set of week triples within J worker $i \in W$ can take three consecutive weeks of holidays
K_j	number of operational days in week $j \in J$
a_i	annual net working time of worker $i \in W$
d_j	demand of total working time in week $j \in J$
δ_i	number of days worker $i \in W$ has to be at work within the planning horizon
γ_i	number of weeks worker $i \in W$ has to work for at least one day during the planning horizon
μ_i	number of week triples worker $i \in W$ has to work for at least one day during the planning horizon
V_{jm}	minimum number of workers at workstation $m \in M$ in week $j \in J$
s_{im}	if worker i is qualified to operate workstation m , this parameter has value 1, 0 otherwise
λ_i	regular shift length per operational day of worker $i \in W$
ρ_i^+	number of hours, a daily shift of worker $i \in W$ can be longer than his regular shift-length
ρ_i^-	number of hours, a daily shift of worker $i \in W$ can be shorter than his regular shift-length
τ_{ij}	individual preference of worker $i \in W$ to have holiday in week $j \in J$
θ_i	weight of worker i 's holiday preferences
B	a sufficiently large number
x_{ijk}	if worker i works in week j during day k , this variable takes value 1, 0 otherwise
y_{ij}	if worker i works at least one day during week j , this variable takes value 1, 0 otherwise
z_{ij}	if worker i works at least one day during three consecutive weeks ($j, j + 1$ and $j + 2$), this variable takes value 1, 0 otherwise
e_{ijk}^+	working time worker i spends more than the regular time on day k in week j
e_{ijk}^-	working time worker i spends less than the regular time on day k in week j

Table 4.1: Model's parameters and variables

The objective function (4.1) minimizes the number of weeks, each worker i has to work. That means on the other hand, that the number of complete holiday weeks are maximized. The objective function takes the individual preferences of each worker into account. High values of τ_{ij} mean a strong preference to make holidays in week j . As a matter of fact, there are seasons in the year, where people usually have a high preference to spend their holidays (e.g. during the summer vacations). When the demand of holidays is high, not everyone's wish might be satisfied. Through the parameter θ_i the weight of the worker's i preferences can be set by the personnel planner that way, that for example each year a different worker's preference will be preferably satisfied. Further the objective function minimizes the absolute value of working time spent more or less than the regular shift length by each individual worker over the year. That way, in a good schedule, workers work most of the days on duty the regular shift length of λ_i hours.

Constraint (4.2) implies that each worker i works his contractual annual hours during the weeks $j \in J_i^W$ where he is disposable. Variable x_{ijk} does not have a direct impact on the objective function but is linked to it via the variable y_{ijk} in constraint (4.10) within the set J_i^W . Further on, the value of x_{ijk} with $j \in J$ determines whether constraint (4.8) can be satisfied, meaning that a minimum number V_{jm} of workers i with qualification $m \in M$ are on duty during day $k \in K_j$. Thus, to prevent the model to set $x_{ijk} = 1$ with $j \in \{J \setminus J_i^W\}$, constraint (4.3) is required.

To guarantee linearity in the objective function, we had to decompose the variable that indicates the deviation from the regular shift length into two separate variables e_{ijk}^+ and e_{ijk}^- . Thus, constraints (4.4) had to be added to make sure, that no negative shift lengths are generated by the model. Constraints (4.5) and (4.6) guarantee that no extra time is spent at work, when worker i is not even on duty.

The model tends to compensate extra time spent on duty with days-off. If that is what the personnel planner wants, then constraint (4.7) can be neglected. Otherwise, that constraint limits the days-off of each worker i , forcing him to be scheduled for at least δ_i days within the planning horizon. If a worker has to work 70 hours within 10 days, then he can work a 10 hour shift on 7 days and take 3 days off, as long as other constraints are not offended. If $\delta_i = 9$, worker i will be scheduled to work on at least 9 days, so that he can take at most one day off.

Constraint (4.9) guarantees, that the workers on duty can face the predicted demand of workload d_j in week j . The "holiday constraints" (4.10) and (4.11) guarantee that each worker i receives exactly γ_i complete hol-

iday weeks over the year, whereas "holiday constraints" (4.12) and (4.13) assign $|J_i^W| - \mu_i$ times three consecutive holiday weeks per worker.

The binary conditions are set in constraint (4.14). Constraint (4.15) sets the limits for the time spent more than the regular working time and constraint (4.16) sets the limits to the time spend less than the regular working time for each worker i .

4.6 Testing the model

4.6.1 Environment

We applied the model to a medium-sized printing plant in northern germany. The company produces printed matters in a manufacturing-to-order manner. It owns two offset sheet fed printing machines, two offset continuous fed printing machines and one digital sheet fed printing machine.

The company meets the conditions for a successful application of our model: There are a broad variety of workstations and workers are cross qualified to operate the machines. Workstations require different levels of qualification which again depends on physical and mental abilities of the operators. As mentioned above, jobs are processed in a manufacturing-to-order manner in a job-shop environment and the number and complexity of the jobs is highly stochastically as we will see later on. The workforce is usually scheduled in one or two shifts with annualized hours. That means, that the annual amount of working hours is fixed but the weekly amount can vary within given limits (see Hung [11]).

The production line of the company is divided into three logical departments, as depicted in figure 4.1: pre-press, press and further processing. Each department contains a variety of workstations. The arrows from the administration towards the manufacturing departments mark the entry-points of jobs into production and the arrows between the manufacturing departments mark the processing-sequence. Usually, jobs are started in the pre-press department, but if the delivered data is ready for printing, the job can be directly processed in the press department. It also occurs that already printed material is being delivered just for further processing. In that case a job is started in the last production department.

The heart of production are the printing machines. These machines are not only the most valuable but also the bottle-neck workstations. Thus, the administration's job scheduling is only done for the workstations belonging to the press departments. Pre-press workstation are organized by themselves, such that jobs are ready for printing at the time they are scheduled

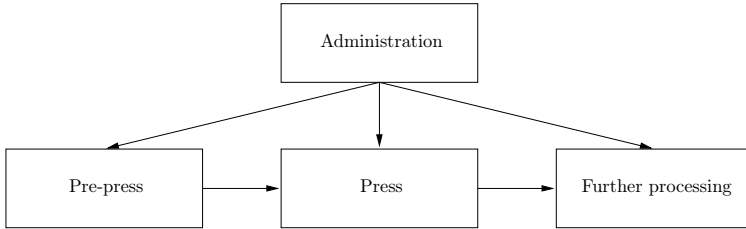

Figure 4.1: Organization of the printing plant

in the press department. The post-press workstations receive a delivery schedule from the administration to organize the job-sequence. As we will see later on, this method of organization is only possible because of the comfortable equipment of manpower the company used to have at the time of this research.

4.6.2 Data

The application of our model to historic data allows us to use real world data for the number of jobs and the demand of workforce of each workstation. For this analysis we do not need to forecast any data. Thus we can make use of the detailed data provided by the job tracking system of the regarded company.

Each job receives a job number at the time it is initiated. When the job is processed, the starting time and the finishing time of each process as well as the job number, the workstation and the kind of process is stored by the operating worker via an electronic terminal in the job tracking system. Thus, the processing times p_{ij} could be taken out of the database, so that the weekly time demand d_j could be determined without difficulty.

There are four workstation that are operated by a worker and an assistant. To consider the time demand for the assistants, a virtual workstation was created in the model for each real workstation that is operated with two workers. The virtual workstations time demand is equal to the time demand of the associated real workstation.

Table 4.2 gives an overview of the environmental data of the regarded company over seven consecutive years. The capacity is the sum of the contractual working-time a_i of all workers $i \in W$. The annual demand of working-time $P = \sum_{j \in J} d_j$ is given in the last column. Whereas the number of workstations M and the capacity are empirical data, the number

Year	W	Capacity	M	P
2000	23	38148	24	37621
2001	23	38136	25	38115
2002	23	37680	23	38162
2003	23	37954	24	34333
2004	21	34430	24	30675
2005	20	33139	23	29760
2006	17	27429	25	26438

Table 4.2: Environmental data

of workers W and the annual capacity are results of the by Mundschenk and Drexl [12]. Their model determined the cost-minimal size of the workforce and the qualification profile of each individual worker. Since the number of workers W and the capacity resulting from their computations are far more restrictive than the empirical data, we use these results because they make higher demands to the model discussed in this paper.

The planning horizon was set to one year, such that $|J| = 52$. All workers are disposable throughout the year and the number of week triples, each worker can take three consecutive weeks of holidays, was set to $|J_i^W| = 50$ for each worker i . The number of operational days was generally set to $K_j = 5$ for each week $j \in J$. If a week contains one or more public holidays, the number of operational days was reduced respectively. Every worker gets 30 days of holidays and is guaranteed a minimum of 5 complete weeks of holidays so $\gamma_i = 47 \forall i \in W$.

4.6.3 Computational results

We solved all instances for the years 2001 to 2006. We generated the model using AMPL and solved it with ILOG CPLEX 10.0 on a 2 GHz AMD Athlon CPU. All instances could be solved to optimality within five minutes of cpu time.

Figure 4.2 illustrates the aggregated results of the year 2003 on a weekly basis. In the regarded year, the demand of workforce was 34.333 hours. The workforce capacity was 37.954 hours. The weekly demand, illustrated by the black line, is the actual demand from that period, extracted from the printing companies job-tracking system.

The model was able to allocate the off-days such that all legal constraints were met. The sum of workers on holiday in week j are illustrated by the

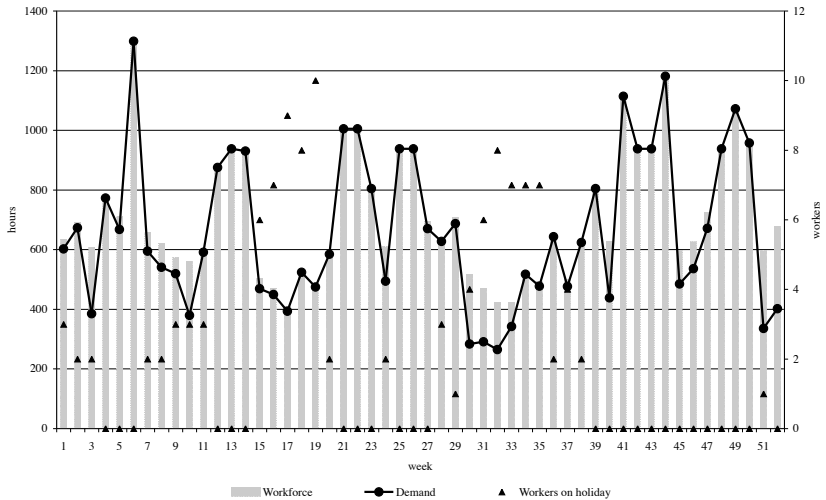

Figure 4.2: Distribution of workforce and holiday weeks in the year 2003

black triangles. The model also determined the shift lengths of each worker, such that the contractual working time was distributed over the year in a way, that the weekly demand d_j is met. The sum of the aggregated shift lengths of each week and of all workers on duty are illustrated by the gray bars. The distribution of days-off and shift lengths of an individual worker are illustrated in Figure 4.3 on a daily basis. There is no work on weekends, so there are 261 days illustrated. It can be observed, that the worker is scheduled to work the regular shift length λ_i most of the time. No shift is longer than 12 hours and none is shorter than 3 hours. The regarded worker was granted six complete weeks of holidays whereof three weeks were granted as a consecutive triple.

The most important thing is that not only the plain working time was allocated in a way, that the demand of workforce is satisfied, but the composition of the heterogeneous workers on duty met the requirement that all workstations can be operated to the extend needed.

In figure 4.4 the allocation of the weeks-off of each worker is illustrated in the rows 1 through 23. Each worker received at least three consecutive holiday weeks as well as two further complete holiday weeks. The distribution of the single days-off is not illustrated in this figure.

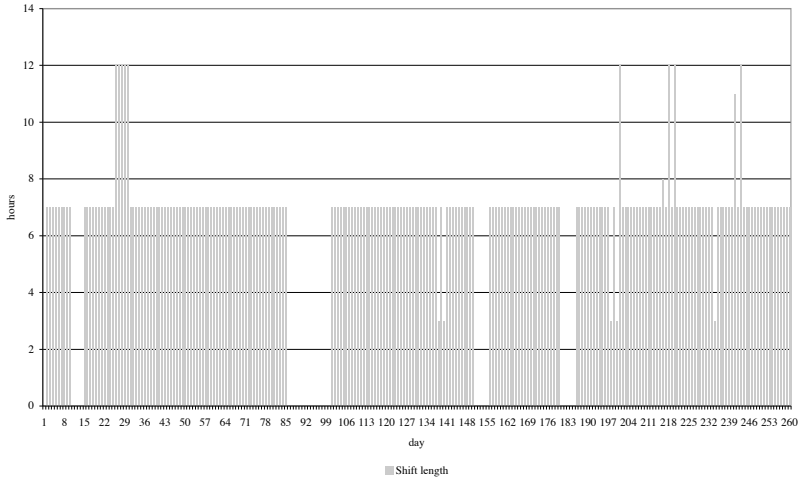

Figure 4.3: Distribution of days-off and shift lengths of a worker in the year 2003

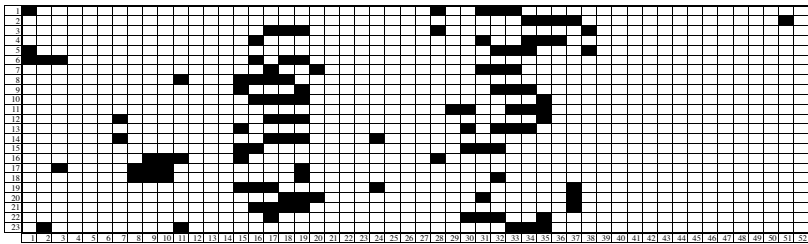

Figure 4.4: Allocation of the weeks-off of all workers in the year 2003

4.7 Empirical application

In the last section, we tested the model on historic data in a rather small environment with 24 workstations and 23 workers. Actually the regarded printing-company employs 121 workers and comprises 76 workstations. Because of the problems, described in the introduction, the holidays for the year 2008 were planned by a central instance to take all dependencies between all workers into account. In many cases we observed dependencies between workers that work in different departments and who were scheduled by different personal planners, leading to under-coverages in the past.

4.7.1 Restrictions and individual issues

The workforce had provisos against a centralized planning of their holidays, being afraid to spend their annual vacations during an unattractive time of the year. Thus, it came to an agreement between the workforce and the management, that the three consecutive weeks of holidays had to be granted within the time from may until september or during the school holidays over ester or in the autumn, unless a worker explicitly asked to take his annual vacations during a different time of the year. That meant, that $J_i^W = \{11, 19, \dots, 38, 41, 42\}$ for almost all workers.

Workers had to be considered, that retire during the planning horizon. The set of weeks, one worker can be assigned to shifts is $J_i^W = \{1, \dots, 26\}$. Another female worker will be absence for multiple month because of pregnancy, leading to a set of assignable weeks $J_i^W = \{1, \dots, 12, 48, \dots, 53\}$.

The individual data like the amount of annual working hours a_i , the individual regular shift-length λ_i and the amount of holidays to be granted, where achieved in consultation of the personnel department.

The skill matrix $S(121 \times 76)$ was determined in consultation of the department managers.

4.7.2 Individual preferences

To query the individual preferences, each worker wants to spend his holidays, all 121 workers where given a questionnaire. Each of the 53 weeks of the year 2008 had to be rated with the values

$$\tau_{ij} = \begin{cases} 0, & \text{no preference to take week } j \text{ off} \\ 1, & \text{low preference to take week } j \text{ off} \\ 2, & \text{medium preference to take week } j \text{ off} \\ 3, & \text{high preference to take week } j \text{ off.} \end{cases}$$

We observed that it was not easy for many workers to be aware of their individual preferences. Each worker was guaranteed to get five complete weeks of holidays in the year 2008. So a lot of questionnaires were completed with five weeks rated with value $\tau_{ij} = 3$ and $\tau_{ij} = 0$ for all other weeks. Because the holiday planning was not done in a question-and-answer game like workers were used to, many of them did not consider their alternatives with medium or low preference to spend their holidays. It took a while to explain the workers how to become aware of rating alternative holiday weeks. If workers prefer spending their holidays in spring or summer, these months have to be rated with $\tau_{ij} \in \{1, 2\}$. If, for example, a worker wants to spend three weeks of holidays in the summer and rates the weeks $\{32, 33, 34\}$ with $\tau_{ij} = 3$, he should also rate the adjacent weeks $\{31, 35\}$ in consideration of the case that he will not be granted the weeks with his highest preferences and his holidays might be shifted. If week $\{31\}$ is rated with $\tau_{i,31} = 1$ and week $\{35\}$ is rated with $\tau_{i,35} = 2$, the worker expresses, that he would prefer a shift towards the end of the month rather than a shift towards the beginning.

4.7.3 Operational requirements

As mentioned above, the regarded company is equipped with an electronic job-tracking system. In the departments, where this system is installed, the total demand of working time per week d_j and the minimum number of workers with a specific qualification V_{jm} can be predicted on the basis of historic data. In other departments like office domains, the requirements were determined according to the department manager or the personnel planner. To be prepared of unexpected absences due to sickness, for each workstation a minimum of 50% of the workers who are qualified to operate it, had to be on duty, even if the predicted time-demand was not enough for that amount of workers. But because of the cross qualification of almost all the workers, no one will be bored in those weeks, since they are scheduled on other workstations. In case of a drop out of a worker, his work can be handled by the workers on duty by overtime, but no worker has to cancel his holidays to jump in for the sick worker.

4.7.4 Computational approach

In this empirical application of the model we faced a set of $|M| = 76$ workstations and a set of $|W| = 121$ workers, as mentioned above. To reduce the size of the MIP, we analyzed the data set and were able to cluster the workers into 14 groups with no operational dependencies among each other. The smallest groups contained only two workers and one workstation, whereas the largest group contained 43 workers and 35 workstations. That way, the scheduling problem could be solved for each group separately, enabling us to solve a number of subproblems to optimality. Table 4.3 gives an overview of the size of the groups. All instances were solved to optimality within 300 seconds of CPU-time, using the neos-server for optimization [1].

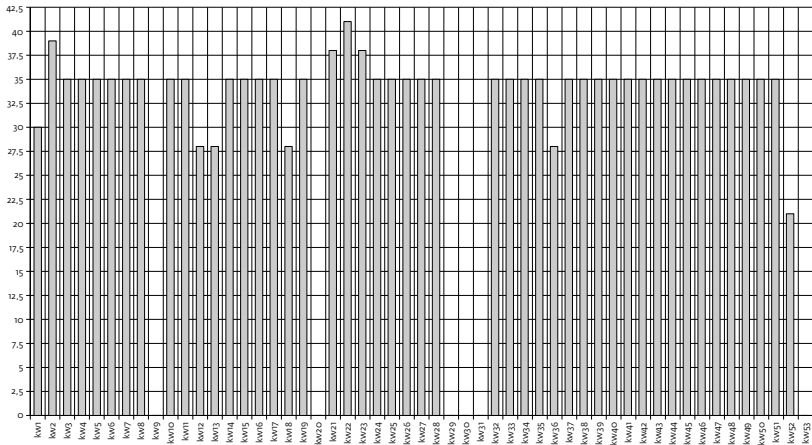

Figure 4.5: Example of a shift and holiday schedule

The results were aggregated to a weekly schedule and illustrated as a bar chart for each worker (see figure 4.5). The height of each bar corresponds to the weekly amount of working hours in a specific week. If no bar exists, a week is granted for holiday.

All 121 workers were granted at least 5 complete weeks of holidays. Only 9 workers had to accept weeks of holidays, where not all five of the weeks were rated with their highest preference. Table 4.4 shows the number of weeks $A_i = \{j \in J | \tau_{ij} = 3\}$ that were rated with $\tau_{ij} = 3$ and the subset

of these weeks $C_i = \{j \in J | \tau_{ij} = 3, y_{ij} = 1\}$ that were granted for holidays for each of the 9 mentioned workers.

Group	M	W
1	14	18
2	1	7
3	1	4
4	2	6
5	4	7
6	1	2
7	3	1
8	2	3
9	35	43
10	6	11
11	1	2
12	1	2
13	1	3
14	4	12
Σ	76	121

Table 4.3: Size of groups

i	$ A_i $	$ C_i $
1	3	1
2	6	1
3	5	2
4	4	2
5	6	3
6	6	4
7	6	4
8	6	4
9	7	4

Table 4.4: Workers with unsatisfied preferences.

It is not surprising, that the chance to get strong preferred weeks of holidays granted, if the number of such weeks is high. Additionally, the satisfaction of the workers' preferences was met in such a great extent, because many workers arranged their preferences with each other, before they filled out the questionnaire. So did a lot of the 9 workers just mentioned. These workers were surprised afterwards because they were convinced that their arrangement with the colleagues could not lead to any conflicts, such that all preferred weeks should have been granted for holidays. Particularly workers in the group with $|W| = 43$ workers were not capable of seeing the dependencies between the workers within that group and were not aware of the operational requirements of the company. Anyhow, no one can be blamed for not seeing this complexity, since it is the initial motivation for our model developed in this paper.

4.8 Conclusions

The model developed performed very well in the empirical application as well as in the application with the historical data in conjunction with the

optimized workforce inventory. In the latter case it could be observed that the weekly available working-time, scheduled by the model, fit smoothly to the weekly demand of workload. This would not be a challenge if the workforce is assumed to be homogeneous, but in a real life environment of a medium-sized manufacturing-to-order company, with a heterogenous workforce, the results are very promising. Besides the heterogeneity of each individual worker, we were able to take many real life restrictions into account, like individual annual working times, different shift-lengths or absences of individual workers over a different number of weeks.

When the empirical application was announced, there was discomfort among the workforce. Workers assumed, that the holiday schedule would be too restrictive and individual habits would not be taken into account. After the schedule was set up and announced to the workforce, prejudice against the new way of the centralized computer assisted holiday planning was rejected. The personnel planners where also very pleased with the new way of planning, saving them days of scheduling work, which usually just lead to suboptimal schedules in the past.

This paper contributes to the domain of the heterogenous workforce planning research. After the size of the workforce and the qualification of the individual worker is determined, this research closes the gap to next level of personnel planning. The next step is to develop a rostering model to assign a heterogenous workforce to workstations and processes within a shift.

Bibliography

- [1] Neos server.
- [2] Carlos S. Azmat, Tony Hürlimann, and Marino Widmer. Mixed integer programming to schedule a single-shift workforce under annualized hours. *Annals of Operations Research*, 128(1-4):199–215, 2004.
- [3] Carlos S. Azmat and Marino Widmer. A case study of single shift planning and scheduling under annualized hours: A simple three-step approach. *European Journal of Operational Research*, 153(1):148–175, 2004.
- [4] Jonathan F. Bard. Staff scheduling in high volume service facilities with downgrading. *IEE Transactions*, 36:985–997, 2004.
- [5] A. Billonnet. Integer programming to schedule a hierarchical workforce with variable demand. *European Journal of Operational Research*, 114:105–114, 1999.
- [6] X. Cai and K.N. Li. A generic algorithm for scheduling staff of mixed skills under multi-criteria. *European Journal of Operational Research*, (125):359–369, 2000.
- [7] Richard L. Daniels, Joseph B. Mazzola, and Dailun Shi. Flow shop scheduling with partial resource flexibility. *Management Science*, 50(5):658–669, 2004.
- [8] Guy Eitzen, David Panton, and Graham Mills. Multi-skilled workforce optimisation. *Annals of Operations Research*, (127):359–372, 2004.
- [9] Hamilton Emmons and Richard N. Burns. Off-day scheduling with hierarchical worker categories. *Operations Research*, 39(3):484–495, 1991.

- [10] P. Eneborn and M. Rönnqvist. Scheduler – a system for staff planning. *Annals of Operations Research*, 128:21–45, 2004.
- [11] R. Hung. Scheduling a workforce under annualized hours. *International Journal of Production Research*, 37(11):2419–2427, 1999.
- [12] Martin Mundschenk and Andreas Drexl. Heterogenous workforce planning in medium-sized manufacturing-to-order companies. *to be published*, 2008.

Lebenslauf

Name: Martin Mundschenk
 Geburtsdatum: 9. Mai 1976
 Geburtsort: Soltau
 Eltern: Dr. Wolff-Martin Mundschenk, Zeitungsverleger
 Margitta Mundschenk, Hausfrau
 Geschwister: Vera Mundschenk
 Michael Mundschenk
 Schulausbildung: 1982 – 1986 Grundschule Soltau
 1986 – 1988 Orientierungsstufe Soltau
 1988 – 1995 Gymnasium Soltau
 1992 – 1993 Auslandsaufenthalt in den USA
 und Erwerb des US-High-School Abschlusses
 Schulabschluß: Abitur mit den Leistungskursen Englisch und
 Mathematik
 Bundeswehr: 1995 – 1997 Ausbildung zum Reserveoffizier
 beim Panzerartillerielehrbataillon 95 in Munster
 Berufsausbildung: 1997 – 1999 Auszubildender zum Verlags-
 kaufmann beim Münchener Zeitungsverlag in
 München
 Studium: 1999 – 2005 BWL Studium an der Christian-
 Albrechts-Universität zu Kiel mit den Schwer-
 punkten:
 - Innovation, neue Medien und Marketing
 - Absatzwirtschaft
 - Produktion & Logistik
 Beruf: seit 2005 kaufmännischer Angestellter der
 Mundschenk Druck- und Verlagsgesellschaft
 mbH
 seit 2007 als Geschäftsführer tätig
 Promotion: November 2008