

Institut für Humanernährung und Lebensmittelkunde
Abteilung Molekulare Ernährung
Christian-Albrechts-Universität zu Kiel

**Functional and association analysis of polymorphisms in selected genes of
fat metabolism**

Dissertation
zur Erlangung des Doktorgrades
der Agrar- und Ernährungswissenschaftlichen Fakultät
der Christian-Albrechts-Universität zu Kiel
vorgelegt von
MSc Mike Böhme
Kiel
2008

Dekan: Prof. Dr. U. Latacz-Lohmann

1. Berichterstatter: Prof. Dr. F. Döring

2. Berichterstatter: Prof. Dr. G. Rimbach

Tag der mündlichen Prüfung: 10.02.2009

Gedruckt mit der Genehmigung des Dekans
der Agrar- und Ernährungswissenschaftlichen Fakultät
der Christian-Albrechts-Universität zu Kiel

Table of contents

| | |
|---|----|
| List of abbreviations | II |
| Summary | 1 |
| Zusammenfassung | 3 |
| General Introduction | 5 |
| <i>The fatty acid binding protein 2 (FABP2) promoter</i> | 5 |
| <i>The Microsomal Triglyceride Transfer Protein (MTTP)</i> | 11 |
| <i>The Prostaglandin E Synthase 2 (PTGES2)</i> | 14 |
| General Discussion | 17 |
| <i>Genotypic association of the FABP2 promoter haplotypes with BMI</i> | 17 |
| <i>Functional analysis of the FABP2 promoter haplotypes</i> | 19 |
| <i>Genotypic association of the MTTP H297Q polymorphism with BMI,</i> <i>waist circumference and total cholesterol</i> | 23 |
| <i>Genotypic association of the PTGES2 R298H polymorphism with BMI</i> | 24 |
| <i>Outlook</i> | 26 |
| References | 30 |
| Publications | 43 |

List of abbreviations

| | | | |
|---------|--|------|--|
| AA | arachidonic acid | DR | down regulator of |
| aa | amino acid | | transcription |
| ABL | abetalipoproteinemia | EPIC | European Prospective |
| Ala | alanin | | Investigation into |
| apoB | apolipoprotein B | | Cancer and Nutrition |
| ARP | apolipoprotein A1 regulatory protein | ER | endoplasmatic reticulum |
| BMD | bone mineral density | FA | fatty acid |
| BMI | body mass index | FABP | fatty acid binding protein |
| CD | cluster of differentiation | FH | familial |
| C/EBP | CCAAT enhancer binding protein | FOXA | forkhead box A |
| CEU | CEPH: Utah residents with ancestry from northern and western Europe | FTO | fat mass and obesity associated gene |
| CHB+JPT | Han Chinese in Beijing, China and Japanese in Tokyo, Japan | EGF | epidermal growth factor |
| CHD | coronary heart disease | ERR | estrogen related receptor |
| ChiP | chromatin immunoprecipitation | GATA | TF that binds to the sequence "GATA" |
| CNV | copy number variation | GATE | gamma activated transcriptional element |
| COUP | chicken ovalbumin upstream promoter | GBF | GATE binding factor |
| COX | cyclooxygenase | Gln | Glutamine |
| CRP | C-reactive protein | GLP | glucagon like peptide |
| cSNP | coding SNP | GSH | glutathione |
| CVD | cardiovascular disease | GWA | genome wide association study |
| Cys | Cysteine | H | Histidine |
| D6D | delta 6 desaturase | His | Histidine |
| dias | diastolic | HCV | hepatitis C virus |
| | | HDL | high density lipoprotein |
| | | HNF | hepatocyte nuclear factor |

List of abbreviations

| | | | |
|-------|--|-------------|---|
| HOMA | homeostatic model assessment | NF-κB | nuclear factor kappa- light-chain-enhancer of activated B cells |
| htSNP | haplotype tagging SNP | | |
| I | Isoleucine | OCT | octamer-binding TF |
| IDL | intermediate density lipoprotein | OGTT | oral glucose tolerance test |
| IFN | interferon | PAD | peripheral arterial disease |
| IL | interleukin | | |
| IMT | intima media thickness | pat | patients |
| IRS | insulin response element | PDI | protein disulfide isomerise |
| irs | insulin resistance syndrome | PG(E, G, H) | prostaglandin (E, G, H) |
| KORA | Kooperative Gesundheitsforschung in der Region Augsburg | PGC | PPAR gamma coactivator |
| LD | linkage disequilibrium | pp | post prandial |
| LDL | low density lipoprotein | PPAR | peroxisome proliferator- activated receptor |
| LRH | liver receptor homolog | PTGES | prostaglandin E synthase |
| LTA | lymphotoxin-alpha | PUFA | polyunsaturated FA |
| MAPEG | membrane associated proteins in eicosanoid and glutathione metabolism | PYY | peptide tyrosine tyrosine |
| MCR | melanocortin receptor | Q | Glutamine |
| MetS | metabolic syndrome | R | Arginine |
| MICK | Metabolic Intervention Cohort Kiel | ROBO | roundabout axon guidance receptor homolog |
| mRNA | messenger ribonucleic acid | ROS | reactive oxygen species |
| MTTP | microsomal triglyceride transfer protein | Rosi | Rosiglitazone |
| MUFA | monounsaturated FA | RXR | retinoid X receptor |
| NASH | non-alcoholic steatohepatitis | SCPSB | Scotland Coronary Prevention Study |
| | | SD | standard deviation |
| | | SFA | saturated fatty acids |
| | | SHP | small heterodimer partner |

List of abbreviations

| | |
|-------|--|
| SMAD | SMA (<i>C. elegans</i>) and mothers against decapentaplegic (<i>D. melanogaster</i>) homolog |
| SMRT | silencing mediator of retinoid and thyroid receptor |
| SNP | single nucleotide polymorphism |
| Sp | specificity protein |
| SREBP | sterol regulatory binding protein |
| STAT | signal transducer and activator of transcription |
| T | Threonine |
| T2D | type 2 diabetes mellitus |
| TCF7L | transcription factor 7-like |
| TF | transcription factor |
| TFA | trans fatty acids |
| TFH | hypothetical HeLa cell specific TF |
| TG | triglyceride |
| TGF | transforming growth factor |
| Thr | Threonine |
| TNF | tumor necrosis factor |
| UTR | untranslated region |
| VLDL | very low density lipoprotein |
| YRI | Yoruba in Ibadan, Nigeria |

Summary

The genes encoding fatty acid binding protein 2 (FABP2), microsomal triglyceride transfer protein (MTTP) and prostaglandin E synthase 2 (PTGES2) are involved in the regulation of the metabolism of dietary fat. Variants of the FABP2, MTTP and PTGES2 genes are associated with traits of the metabolic syndrome (MetS). This work expands the knowledge about the influence of the 3 gene loci on diverse MetS traits via association analysis in the KORA cohort with more than 8000 participants. Further, functional analysis of the FABP2 promoter was carried out in cell culture regarding a PPAR γ /RXR α regulation.

FABP2 mediates intestinal absorption and cytosolic transport of non-esterified long chain free fatty acids (FA) as well as their secretion into triglyceride rich chylomicrons. Further, FABP2 transports FA into the nucleus as ligands for transcription factors (TF). The FABP2 promoter comprises polymorphisms c.-80_-79insT, c.-136_-132delAGTAG, c.-168_-166delAAGinsT, c.-260G>A, c.-471G>A and c.-778G>T, which result in two haplotypes A and B. Studies in relatively small cohorts provide preliminary evidence that FABP2 promoter haplotypes are associated with type 2 diabetes (T2D) and BMI.

Here, the influence of haplotypes on BMI was examined via linear regression analysis of 8072 male and female participants of the KORA cohort. A reduction of -0.39 BMI units (p=0.02) in homozygous male FABP2 promoter haplotype B carrier was found. Carrier of haplotype B (AB+BB) showed a significant decrease in BMI of -0.19 BMI units (p=0.03). In accordance, a significant reduction in BMI of the minor haplotype carrier in the BMI point categories of 25-30 (-0.10 BMI units, p=0.03) and <30 (-0.37 BMI units, p=0.02) were found. Female carriers showed no association with BMI.

Functional analysis of haplotypes by Rosiglitazone stimulated PPAR γ /RXR α displays a 2-fold higher activity of haplotype B than A. As shown by chimeric FABP2 promoter constructs, the higher responsiveness of FABP2 haplotype B is mainly but not solely determined by polymorphism c.-471G>A. As shown by electro mobility shift assays and promoter reporter assays, OCT1 interacts with the -471 region of FABP2 promoters, induces the activities of both FABP2 promoter haplotypes and abolishes the different activities of haplotypes induced by Rosiglitazone stimulated PPAR γ /RXR α .

MTTP is a key regulator in the assembly and secretion of chylomicrons and VLDL in the intestine and in liver. Associations between MTTP variants and traits of the MetS are carried

out in relatively small cohorts and are not consistent. Seven htSNPs covering a 52 kb region of the MTTP locus and two cSNPs (I128T, H297Q) were analysed for MetS trait alteration via linear regression in 7582 participants of the KORA study cohort. A MTTP haplotype containing the minor allele of H297Q showed a significant decrease of -0.64 BMI units ($p=0.04$) in females but not in males. Only females carrying the Q-allele showed a decrease in BMI (Q-carrier: -0.26 BMI unit, $p=0.02$; Q/Q: -0.66 BMI units, $p=0.01$), waist circumference (Q-carrier: -0.66 cm, $p=0.01$; Q/Q -1.44 cm, $p=0.01$) and total cholesterol (Q-carrier: -0.05 mmol/l, $p=0.03$; Q/Q: -0.11 mmol/l, $p=0.03$). Males revealed no association with any of the three measured traits of the MetS.

PTGES2 is required for production of the antilipolytic compound prostaglandin E₂. The H-allele of the R298H polymorphism in the PTGES2 gene was associated with lower risk of T2D. To explore a PTGES2 gene influence on BMI alteration, the R298H SNP and three htSNPs covering a 20 kb gene region were analysed in the KORA study cohort with 8079 participants. A statistically significant difference in BMI between the heterozygous PTGES2 R298H genotype and the homozygous R/R genotype was found in males but not in females. Males with the R/H genotype showed a decrease in BMI of -0.30 BMI units ($p=0.02$) in comparison to R/R males. A haplotype comprising the minor allele of PTGES2 R298H showed a significant decrease of -0.19 BMI units in males ($p=0.04$) but not in females. Other haplotypes and single htSNPs were not significantly associated with BMI.

Association analysis in the KORA cohort with more than 8000 participants revealed association between BMI and polymorphisms of the FABP2 promoter and the MTTP and PTGES2 genes. The MTTP SNP H297Q and related haplotypes are also associated with waist circumference and total cholesterol. Functional analysis exhibited, that the FABP2 promoter haplotype B is 2-fold more inducible by PPAR γ /RXR α than haplotype A. This difference is caused by polymorphism c.-471G>A. In addition, OCT1 was identified as a TF regulating the FABP2 promoter. In conclusion, variants of the FABP2, MTTP and PTGES2 genes, which are involved in fat metabolism, contribute to the development of the MetS.

Zusammenfassung

Das Fettsäure-Bindungsprotein 2 (FABP2), das mikrosomalen Triglycerid-Transfer Protein (MTTP) und die Prostaglandin E Synthase 2 (PTGES2) sind beteiligt an der Regulierung des Fettstoffwechsels. Polymorphismen in den Genen vom FABP2, MTTP und PTGES2 sind mit Markern des Metabolischen Syndroms (MetS) assoziiert. Diese Arbeit erweitert das Wissen über den Zusammenhang zwischen diesen 3 Gen Bereichen und Markern des MetS auf der Basis von Assoziationsstudien in der KORA Kohorte mit mehr als 8000 Teilnehmern. Weiterhin wurde die Regulation des FABP2 Promotors durch PPAR γ /RXR α funktionell in einem Zellkulturansatz untersucht.

FABP2 reguliert die Absorption und den zytosolischen Transport von nicht veresterten langkettigen freien Fettsäuren (FS) sowie deren Einbau in Chylomikronen im Darm. Weiterhin transportiert FABP2 FS in den Zellkern, in dem diese als Liganden für Transkriptionsfaktoren fungieren. Der FABP2 Promotor zeigt die Polymorphismen c.-80_-79insT, c.-136_-132delAGTAG, c.-168_-166delAAGinsT, c.-260G>A, c.-471G>A und c.-778G>T, die in den Haplotypen A and B resultieren. Studien in kleinen Kohorten zeigten Assoziationen der FABP2 Promotor Haplotypen mit Diabetes Typ 2 (T2D) und BMI. Lineare Regressions-Analysen der beiden Haplotypen im Bezug auf den BMI von 8072 Männern und Frauen der KORA Kohorte offenbarte eine Reduktion um -0.39 BMI Einheiten (E.) (p=0.02) von homozygoten männlichen FABP2 Promotor Haplotyp B-Trägern. Generell hatten Männer mit dem Haplotyp B einen um -0.19 E. (p=0.03) signifikant erniedrigten BMI. Übereinstimmend hatten Träger des seltenen Allels eine BMI Erniedrigung in den Gruppen mit einem BMI von 25-30 (-0.10 E., p=0.03) und <30 (-0.37 E., p=0.02). Weibliche Träger des seltenen Allels zeigten keine signifikanten Assoziationen. Funktionelle Untersuchungen der FABP2 Promotor Haplotypen nach PPAR γ /RXR α Transfektion führten zu einer 2-fach erhöhten Aktivität des Haplotyps B im Vergleich zu A im Zellkulturansatz. FABP2 Promotor Chimären zeigten, dass die stärkere Aktivierbarkeit des Haplotyps B wesentlich von dem c.-471G>A SNP abhängig ist. Elektro Mobility Shift Assays und Promotor Reporter Analysen zeigten eine Promotor aktivierende Bindung von OCT1 im Bereich des c.-471 SNP. Die haplotypen-spezifische Induktion durch PPAR γ /RXR α wurde dadurch aufgehoben.

MTTP ist ein Schlüsselenzym in der Bildung und der Sekretion von Chylomikronen und VLDL im Darm und in der Leber. Assoziationsstudien zwischen MTTP SNPs und Markern

des MetS, besonders Lipid-Werten, wiesen in kleinen Kohorten widersprüchliche Ergebnisse auf. 7 htSNPs, sowie 2 cSNPs (I128T, H297Q), die eine 52 kb Region des MTTP Locus umspannen, wurden auf ihr MetS Marker veränderndes Potential mittels Linearer Regression in 7582 Teilnehmern der KORA Kohorte hin untersucht. Ausschließlich weibliche Träger eines Haplotyps mit dem seltenen Allel des H297Q SNP zeigten eine signifikante Erniedrigung des BMIs um -0.64 E. ($p=0.03$). Ausschließlich Frauen mit einem Q-Allel zeigten Verminderungen des BMIs (Q- Träger: -0.26 BMI E., $p=0.02$; Q/Q: -0.66 BMI E., $p=0.01$), des Hüftumfangs (Q- Träger: -0.66 cm, $p=0.01$; Q/Q -1.44 cm, $p=0.01$) und des gesamt Cholesterins (Q- Träger: -0.05 mmol/l, $p=0.03$; Q/Q: -0.11 mmol/l, $p=0.03$). Männliche Träger des Q-Allels wiesen keine Veränderung dieser Parameter auf.

PTGES2 bildet das antilipolytische Prostaglandin E₂. Das H-Allel des R298H SNP im PTGES2 Gen ist mit einem erniedrigten T2D Risiko assoziiert. Um den Einfluss von PTGES2 SNPs auf BMI Veränderungen zu untersuchen, wurden der R298H SNP und 3 htSNPs, welche eine 20 kb Region des PTGES2 Gens umspannen, in der KORA Kohorte mit 8079 Teilnehmern analysiert. Ein statistisch signifikanter Unterschied zwischen BMI und heterozygoten Trägern des R298H SNP im Vergleich zu Trägern des häufigen Allels wurde ausschließlich in Männern gefunden. Träger des R/H Genotyps wiesen eine Reduktion um -0.30 BMI E. ($p=0.02$) auf. Männer die einen 298H Haplotyp aufwiesen zeigten einen um -0.19 E. erniedrigten BMI ($p=0.04$). Weiteren htSNPs oder Haplotypen zeigten keine Assoziationen zu einem veränderten BMI.

Lineare Regressions-Analysen in der KORA Kohorte ($n>8000$) zeigten Assoziationen zwischen dem BMI und Polymorphismen im FABP2 Promotor und den Genen des MTTP und der PTGES2. Der MTTP H297Q SNP ist weiterhin mit Veränderungen im Hüftumfang und des Gesamt Cholesterins assoziiert. Funktionelle Analysen des FABP2 Promotors zeigten, dass die 2-fach höhere Aktivierbarkeit des Haplotyps B durch PPAR γ /RXR α durch den SNP c.-471G>A hervorgerufen wird. Zusätzlich wurde OCT1 als ein Transkriptionsfaktor identifiziert, der den FABP2 Promotor reguliert. Zusammenfassend kann gesagt werden, dass Polymorphismen in den Genen des FABP2, MTTP und PTGES2, die für den Fettstoffwechsel wichtig sind, zur Entstehung des MetS beitragen.

General introduction

The metabolic syndrome (MetS) encompasses the most prevalent diseases in the western world including obesity, glucose and insulin disturbances, dislipidemia and high blood pressure [1]. These traits are accompanied by cardiovascular disease (CVD) and type 2 diabetes mellitus (T2D). T2D incidence is projected to double to 350 million cases by the year 2030 [2, 3]. With the completion of the Human Genome Project in 2003 [4] and the International HapMap Project in 2005 [5] the possibility to identify genetic variants associated with MetS was considerably enhanced resulting in numerous candidate gene approaches. Many candidates associated with MetS traits in initial studies could not be confirmed in further populations. This multitude of (unverified) candidate genes is unlikely to be solely false positives. In fact, especially the disease-associations of polymorphisms in small cohorts strongly depend on a variety of gene-gene and/or gene-environment interactions like food composition [6].

The aim of this work was to expand the knowledge about the effects of selected polymorphisms in fat metabolism genes previously associated with traits of MetS and T2D. Therefore more than 8000 participants were genotyped in the KORA cohort for variants in the fatty acid binding protein 2 (FABP2) promoter, the gene loci of the microsomal triglyceride transfer protein (MTTP) and the prostaglandin E synthase 2 (PTGES2). Further functional analysis of the FABP2 promoter was carried out in cell culture regarding a PPAR γ /RXR α regulation.

The fatty acid binding protein 2 (FABP2) promoter

The FABP family was first described 1982 after isolation from rat liver [7]. With its function of hydrophobic molecule binding the FABP family belongs to the calycin superfamily and is conserved in vertebrates and invertebrates [8]. A more precise classification of the vertebrate cytoplasmic FABPs was made, according to the tissue in which their expression was first detected, into liver FABP (L-FABP or FABP1), intestinal FABP (I-FABP or FABP2), heart FABP (H-FABP or FABP3), adipocyte FABP (A-FABP or FABP4), epidermal FABP (E-FABP or FABP5), ileal FABP (Il-FABP or FABP6), brain FABP (B-FABP or FABP7), myelin FABP (MP2 or FABP8) and testis FABP (T-FABP or FABP9). Nonetheless, their expression is not necessarily restricted to their eponymous tissue [9].

Despite their differences in protein sequence, the molecular weight of 14 to 15 kDa and the tertiary structure are features shared by all family members. As illustrated in Fig. 1 the protein forms a twisted β -barrel surrounding a hydrophobic core, which is composed of 10 antiparallel β -strands, which are organized into 2 β -sheets oriented nearly orthogonally [10]. One end of the β -barrel is capped by a small helix-turn-helix motif. Within the β -barrel a large water-filled cavity lined with polar and hydrophobic amino acids (aa) is responsible for sequestering the carboxylate groups of fatty acids (FA) [11]. The α -helical N-terminus is mandatory for membrane interaction and therefore for overall FA transfer. Apart from the FABP classification mentioned above, these proteins can be grouped according to their binding abilities. Group 1 (FABP1 and 6) is capable of binding FA and bulky ligands such as bile acids, cholesterol and haem. Group 2 (FABP3-5 and 7-9) binds FA, retinoids and eicosanoids. Only FABP2 solely binds FA, although in a bent instead of U-shaped conformation like groups 1 and 2 [12].

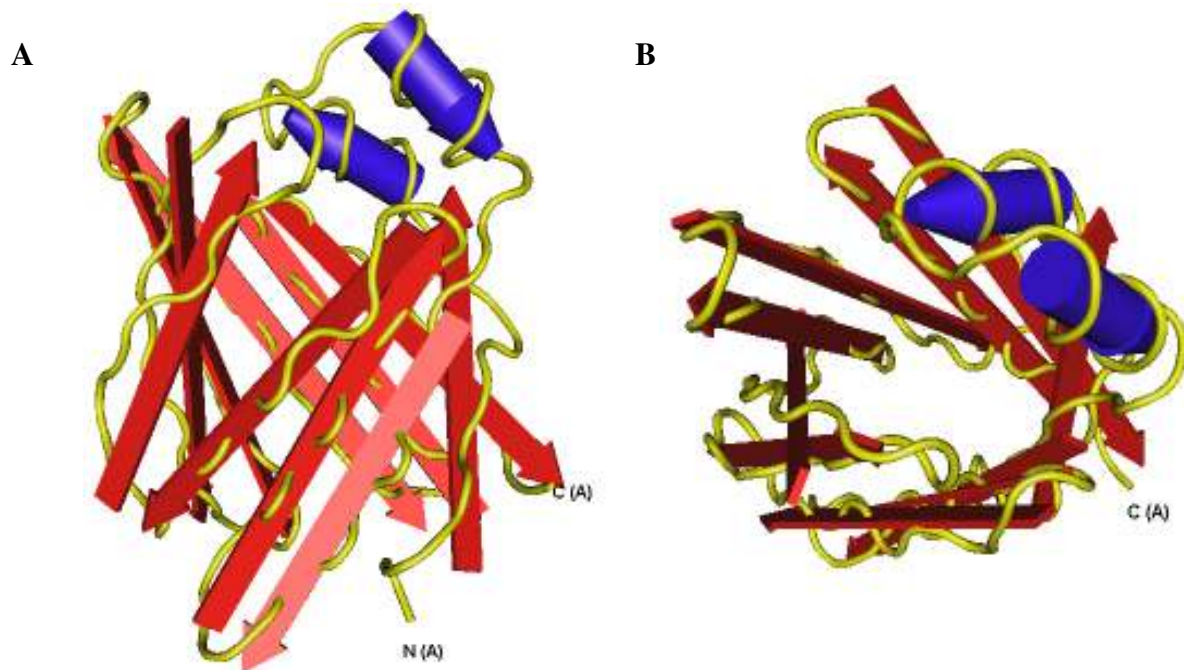

Figure 1. 3D structure of the FABP2 protein viewed from two different angles (A, B). Taken from the NCBI structure database viewed via CN3D viewer version 4.1. Red indicates β -strands, blue indicates α -helices, arrowheads indicate direction [13].

Besides passive diffusion across plasma membranes, FA translocation can also be enhanced by the fatty acid transport protein (FATP) and plasma bound FABP_(PM) [14]. The FA dissociation from the plasma membrane into the cytoplasm is increased by cytosolic FABPs, which enhance the aqueous solubility of FA [15]. In addition to FABP-mediated increase in desorption and cytoplasmic diffusion, FA can interact directly with the phospholipid bilayer

of acceptor membranes [16, 17]. Besides their function in lipid metabolism, FABPs are involved in FA-mediated gene regulation via modification, binding and activation of transcription factors (TF), modifying mRNA stability and influencing TF expression [18]. One of the most frequently mentioned TF family associated with FA regulation are the peroxisome proliferator-activated receptors (PPAR) as their regulative potential can be influenced by FABPs [19-21].

Furthermore, FABPs are relevant for cell growth and proliferation in different tissues [9]. In addition, FABP1 showed antioxidative potential in transfected liver cell lines [22].

The human FABP2 gene (OMIM accession number: 134640; GenBank: NM_000134.3) is located on chromosome 4q28-q31, contains 4 exons and codes for a 15.1 kDa protein comprising 132 aa [23].

FABP2 is expressed in the small intestine together with FABP1 and 6, whereas FABP2 is solely found intestinally [24, 25]. The highest FABP2 expression is quantified in the jejunum and decreases in the proximal duodenum and colon [23]. Maximum protein abundance is detected in the fat absorbing upper villus region, while FABP2 is not detectable in crypt cells [26]. The expression of FABP2 is up-regulated simultaneously with cell and tissue differentiation [26, 27]. Its expression is increased by FA, hormones and cytokines (e.g. butyric acid and oleic acid, insulin, leptin, phosphatidylcholine, hydrocortisone, tumor necrosis factor α (TNF α) and peptide tyrosine tyrosine (PYY)), and decreased after exposure to epidermal growth factor (EGF) in cell culture [28-30]. Mouse studies revealed an increase of FABP2 mRNA after administration of PPAR α agonists [31]. Knock out (KO) of transforming growth factor β 1 (TGF β 1) or estrogen related receptor α (ERR α) showed down-regulation of FABP2 [32]. ERR α regulation may indicate a sex specific gene expression pattern of FABP2 as seen in FABP2 KO mice. The FABP2 promoters of rat and mouse showed *cis*-binding sites for a CCAAT enhancer binding protein (C/EBP), hepatocyte nuclear factor 4 (HNF4) and the apolipoprotein A1 regulatory protein 1 (ARP1) [33]. Influence of the TF TGF β -SMAD/GATA4 on FABP2 promoter activity was also shown in mice [34]. Recently, regulation of the FABP2 promoter via the TFs HNF1 α and HNF4 α was revealed in cell culture [35, 36].

FABP2 localization is congruent with its postulated function in absorption, cellular binding and trafficking of non-esterified long-chain free FA, which are incorporated into triglyceride (TG)-rich chylomicrons for subsequent transport [8, 37, 38]. Although FABP2 seems to be

the most important protein of its family in the gut the intestinal expression of FABP1 is 5-fold higher compared to FABP2 [39]. This may be due to their different activities. The transport of FAs is markedly faster via FABP2 than via FABP1, caused by different mechanisms of interaction with acceptor model membranes. Transfer by FABP2 is mediated by protein-membrane collisional interactions while FAs have to diffuse through the aqueous phase for FABP1 binding. This is due to altered integrity of the α -helix of FABP2, which is mandatory for membrane interaction (see above) [40].

The redundancy of FABP1, 2 and 6 in intestinal cells may contribute to the inconsistent results from *in vivo* and *in vitro* studies according to FABP2 function. FABP2 overexpression in endogenously FABP1 and 2 expressing Caco-2 cells led to reduced fatty acid incorporation and secretion but to increased cellular lipid content [29, 41]. Overexpression in human intestinal epithelial cell line (HIEC-6) enhanced mitochondrial FA oxidation, cholesterol transport gene expression and influenced interaction with nuclear receptors [42]. Undifferentiated ES cells stably expressing FABP2 revealed elevated initial and maximal FA uptake and cytoplasmatic diffusion [43]. L-cell fibroblasts expressing FABP2 also exhibited increased cytoplasmatic diffusion and initial FA esterification into TG as well as elevated TG and cholesteryl ester mass [44, 45]. FABP2 KO in mice revealed altered lipid metabolism in male animals only [32]. They showed traits of the MetS such as increased body weight, elevated plasma insulin and TG. They also showed high fat diet-induced fatty liver although altered FABP1 level were not observed [46, 47]. At this, differences in FABP1 and 2 expressions between mice and humans have to be considered. While FABP2 expression is similar, human FABP1 transcript levels are 2.5-fold higher [39].

The FABP2 gene carries a G>A exchange at codon 54 (rs1799883), resulting in an Ala-allele and a Thr-allele [48]. This polymorphism has been analysed extensively with divergent results. The Thr54 allele has been associated with a variety of traits of the MetS: i) especially those concerning the FA metabolism, such as reduced HDL-cholesterol, elevated total and LDL-cholesterol, hypertriglyceridemia, increased affinity for long-chain FA, FA flux into the circulation and FA oxidation [49-52]; ii) concerning the carbohydrate metabolism, such as insulin resistance, increased fasting plasma glucose and fasting insulin [53-55]; iii) and concerning inflammation and complex diseases like elevated C-reactive protein (CRP) and interleukin 6 (IL6) level, obesity, T2D, CVD, stroke, reduced resting metabolic rate and renal diseases [56-59]. In contrast, a number of studies showed no association of the Thr54 allele with changes in BMI, total and LDL-cholesterol, hypertriglyceridemia, FA absorption rate,

lipid or glucose metabolism, insulin resistance, T2D or CVD [50, 58, 60-65]. Third, some studies revealed beneficial effects of the Thr54 polymorphism like reduced total and LDL-cholesterol, reduced total abdominal adipose tissue, lower subcutaneous abdominal fat and glucose levels, decreased systolic blood pressure and a later onset of alcoholic cirrhosis [66-69]. Porcine FABP QTLs were initially also linked to elevated fat mass [9] while recent studies with physically mapped markers stated that the FABP cluster was outside this region [70]. Divergent results may be caused by different ethnic, phenotypic and lifestyle backgrounds of study populations, with varying frequencies of the Ala54Thr polymorphism between 18% and 40% [53].

Association between FABP2 Thr54 genotypes and reduced insulin sensitivity was increased after normalisation for differences in body composition and habitual physical activity (PA) levels. Another study showed association of the Thr54 SNP with reduced insulin sensitivity only when individuals were consuming a high fat diet [71]. Interaction between the Thr54 allele, fat composition and consumption was uncovered by Dworatzek et al. They showed that Thr54 carrier had increased chylomicron cholesterol but only after administration of olive oil [72]. However, Morcillo et al. stated that the Thr54 polymorphism was associated with insulin resistance in subjects with a high intake of sunflower oil [73]. Normolipidemic Thr-carrier showed increased fasting free FA after a saturated FA (SFA) diet in contrast to homozygote Ala-carrier [74]. Furthermore, Thr-carrier had lower glucose tolerance, lower insulin action and higher lipid oxidation rates even if they were following a low fat diet [75]. Obese children with the Thr54 polymorphism displayed lower arachidonic acid (AA) and delta-6-desaturase (D6D) activity in fasting plasma [76]. AA is a pro-inflammatory stimulus, but the positive effect of low AA levels on inflammation faces the negative effect of low AA levels in PPAR γ signalling [77], since AA can act as a ligand for PPAR γ , which leads to increased insulin sensitivity [78, 79]. Other authors explained the effects on AA and D6D with the type of dietary FA ingested and not with the Ala54Thr polymorphism [73].

Functional analysis in Caco-2 cells transfected with FABP2 bearing the Thr-allele showed increased cellular FA transport and TG secretion compared to the Ala-allele [8]. Human intestinal explants homozygous for the Thr-allele showed elevated secretion of newly esterified TG and chylomicrons versus Ala-allele carrier [37].

Since the FABP2 Ala54Thr polymorphism has been analysed extensively this work focuses on the analysis of the FABP2 promoter and its polymorphisms in order to reveal a more

precise knowledge about the interaction between FABP2, lipid metabolism and traits of the MetS.

Sequencing studies of the 5' upstream promoter region of FABP2 showed insertion/deletion sites c.-80_-79insT (rs5861422), c.-136_-132delAGTAG (rs5861423) and c.-168_-166delAAGinsT (rs1973598) as well as SNPs c.-260G>A (rs6857641), c.-471G>A (rs2282688) and c.-778G>T (rs10034579). These six variants are in complete linkage disequilibrium (LD) resulting in only two haplotypes A>B with an allele frequency of 44% in Caucasians [80-82]. The FABP2 promoter haplotype B revealed a protective effect against traits of the MetS. It was associated with reduced BMI, lower postprandial TG levels and decreased risk for T2D [80, 81, 83]. Prior association studies were carried out in relatively small cohorts composed of 100-1000 participants. The first of four papers of this work addresses the association of the FABP2 promoter polymorphisms and BMI as a main trait of the MetS in a large (n=8072) population-based survey of the KORA study cohort.

→ {1} M. Böhme, H. Grallert, M. Klapper, C. Gieger, A. Fischer, I. Heid, H.-E. Wichmann, F. Döring, T. Illig, **Association between functional FABP2 promoter haplotypes and body mass index: Analyses of 8072 participants of the KORA cohort study**, *Molecular Nutrition and Food Research* 53 (2009).

Functional analysis of haplotypes showed almost 2- to 3-fold lower transcriptional activity of the rare haplotype B compared to haplotype A in Caco-2 cells [83]. This activity difference is due to decreased binding affinity of GATA5 and 6 to the c.-80_-79insT polymorphism [84]. Recently, a 2-fold higher activity of haplotype B compared to haplotype A was detected by Rosiglitazone stimulated PPAR γ /RXR α in FABP2 deficient HeLa cells [84, 85]. Accordingly, the second paper of this work investigates the functional regulation of the FABP2 promoter by Rosiglitazone stimulated PPAR γ /RXR α in different cell lines.

→ {2} M. Böhme, I. Nitz, F. Döring, M. Klapper, **Analysis of the transcriptional regulation of the FABP2 promoter haplotypes by PPAR γ /RXR α and OCT1**, *Biochim Biophys Acta* 1779 (2008) 616-21.

The Microsomal Triglyceride Transfer Protein (MTTP)

The human microsomal triglyceride transfer protein (MTTP, OMIM accession number: 157147; GenBank: NM_000253.2) is located on chromosome 4q24, contains 19 exons and codes for a 97 kDa protein comprising 876 aa residues. It belongs to a family of large lipid transfer proteins with orthologs in nematodes, fish, insects and mammals [86]. MTTP comprises four structural domains, three β -sheets (N, A, C) and one α -helix. The N-sheet and the α -helix are relevant for binding with the N-terminus of apolipoprotein B (apoB), while the A- and C-sheet form the lipid transfer/binding domain. Kinetic studies suggest that MTTP has two lipid-binding sites. The first site is probably involved in lipid transfer while the second site may have a function in membrane association. The membrane association domain, which is relevant for lipid droplet formation, consists of N- and A-sheet parts. MTTP affinity for apoB increased after lipid association, which implements interdependent domain activities [87]. MTTP encodes the large subunit (M subunit) of the heterodimeric microsomal triglyceride transfer protein (MTP). Protein disulfide isomerase (PDI, P subunit) completes the heterodimer, which plays a central role in lipid transport and lipoprotein assembly.

MTTP is abundantly expressed in the liver and intestine. Other tissues, including hematopoietic cells, synthesize less MTTP due to an alternative promoter and exon 1 (MTTPv1). The exon variation encodes an N-terminal change of 2 aa, while functional differences were not observed. The abundance of MTTP in non-apoB-expressing tissues seems to be relevant for CD1d activation [88]. However, in adipocytes MTTPv1 is primarily localized to the Golgi and therefore may have a distinct role in lipid storage in adipose tissue [89]. The MTTP promoter region contains binding sites for the overlapping insulin response element (IRS)/sterol regulatory binding proteins (SREBP) and the COUP-TFII. Both TFs promote down-regulation. The MTTP promoter is activated by HNF4 α , which is essential for hepatic expression, HNF1 α , LRH1, DR1, as well as PPAR α /RXR α and FOXA2. In addition to direct interaction of these TFs with *cis*-regions on the MTTP promoter, regulation via co-factors and environmental influences was described. PPAR γ coactivator 1 β (PGC1 β) enhanced transcription via FOXA2 and RXR α , while the small heterodimer partner (SHP) down-regulates MTTP via HNF4 α and LRH1 interaction [90].

While MTP displays orthologs in multiple kingdoms their protein function differs between invertebrates and vertebrates [86]. MTP functions in vertebrates are i) lipid transfer activity and membrane binding, ii) lipid droplet formation in the endoplasmic reticulum and iii)

apoB binding [91]. During lipid transfer MTP interacts with donor and acceptor vesicles for acquisition and delivery. The optimal lipid transfer activity was measured in the presence of neutrally charged membranes. Presence of negatively charged lipids in membranes decreased the lipid transfer activity of MTP [92]. In hepatocytes MTP was crucial for aggregation of lipid droplets and their transport from the cytosol into the Golgi and endoplasmic reticulum (ER). Further, TG content in microsomes was MTP dependent, while phosphatidylcholine concentration was independent of MTP [93, 94]. MTP is an essential chaperon for nucleation and desorption of primordial apoB-containing lipoproteins with a density under 1.063 g/ml, namely chylomicrons, LDL and VLDL [90].

MTP is involved in immune system signalling via lipidisation of CD1d, which is a major histocompatibility complex class 1 homolog presenting lipid and glycolipid antigens to natural killer T cells. MTP directly transfers phospholipids to the antigen binding cleft of CD1d in the ER and thereby facilitates rapid cytokine production [95].

The impact of polymorphisms on MTTP promoter activity and protein function were analysed comprehensively via association analysis although with contradictory results. Table 1 summarises association studies between SNPs of the MTTP locus and metabolic traits. The polymorphisms studied most extensively are the promoter SNPs c.-493G>T (rs1800591), c.-400A>T (rs1800803), c.-164T>C (rs1800804) and the coding SNP I128T (rs3816873). These SNPs are summarised based on their nearly complete linkage disequilibrium [96]. In different study populations they were associated with reduced, increased or no traits of the MetS. Functional analysis of the 128T polymorphism showed reduced thermal stability and increased cleavage of MTTP by proteolysis, which indicates a less compact fold and structural stability. This impairs apoB binding and, consequently, decreases LDL production. Accordingly, a protective effect of the 128T polymorphism and the promoter SNPs is postulated [97]. In contrast, a SREBP1a regulation of the MTTP gene via SNP c.-164T>C results in a higher activity of the rare C-allele. This promoter activity was synergistically up-regulated by the rare c.-493G>T polymorphism [98]. Furthermore, three common missense polymorphisms (Q95H (g.343G>C), Q244E (rs17599091), H297Q (rs2306985)) were described which exhibited no influence on MetS [96]. Another study comprising 9 patients with high apoB level and 7 controls were genotyped for polymorphisms in the MTTP gene. 4 out of 11 SNPs were associated with increased abdominal visceral adipose tissue and LDL-apoB. These were the previously described -400T allele, and the homozygote carrier of the new 282G/G, 933C/C and 1151A/A alleles [99].

Table 1. Associations between MTTTP SNPs and metabolic traits

| <i>polymorphism</i> | <i>traits</i> | <i>reference</i> |
|---------------------------|--|---|
| 493G>T (rs1800591) | - reduced total and LDL-cholesterol, VLDL, apoB, TG (only in FH women), IDL and LDL production rate, smaller LDL particle size, carotic IMT, pp-insulin, dias. blood pressure, T2D | middle-aged white American men [100], FH pat. [101], white UK men [96, 102], visceral obese and hyperinsulinemic Chinese men [103], Chinese TD2 pat. [104], T2D pat. [105], healthy German volunteers [106], MICK+EPIC [107] |
| c.- 400A>T (rs1800803) | - increased lipid content of VLDL, total and LDL-cholesterol, TG, FFA, apoB, apoB-48, intrahepatic TG (in T2D), plasma insulin, BMI, NASH, CHD, PAD, BMD, fibrosis, resistin and CRP, fall of HDL-C and apoA1, steatosis (HCV3-pat) | middle-aged white American men [100], Chinese TD2 pat. [104], CARDIA [108], T2D pat. [109], white American men [96, 110], NASH pat. [111, 112], SCPSB [113], Austrian PAD pat. [114], Japanese women [115], Chinese [116], Italian [117], Italian HCV3 pat. [118] |
| c.- 164T>C (rs1800804) | | |
| I128T (rs3816873) | - no association with plasma lipoproteins (total-, LDL-, HDL-cholesterol and their lipid mass), TG, apoB and AI, IRS, CHD, steatosis (HCV-pat) | white American men [110], myocardial infarction pat. [119], Framingham Offspring study [120], SCPSB [113], French-Canadian youth [62], HCV-pat. [121] |
| Q95H (g.343G>C) | - increased longevity | nonagenarians [122] |
| | - no change in lipids, lipoproteins and anthropometric variables, longevity (meta-analysis) | white UK men [96, 123], nonagenarians [124] |
| Q244E (rs17599091) | - no change in lipids, lipoproteins and anthropometric variables | white UK men [96, 123] |
| H297Q (rs2306985) | - no change in lipids, lipoproteins and anthropometric variables | white UK men [96, 123] |

Abbreviations used: BMD: bone mineral density, CARDIA: African American men, CHD: coronary hart disease, CRP: C-reactive protein, dias: diastolic, FH: familial hypercholesterolemia, HCV: hepatitis C virus, HCV3: hepatitis C virus genotype 3, IMT: intima media thickness, IRS:: insulin resistance syndrome, NASH: nonalcoholic steatohepatitis, PAD: peripheral arterial disease, pat: patients, pp: postprandial, SCPSB: Scotland Coronary Prevention Study, T2D: type 2 diabetes mellitus

The same group found an association between a homozygous c.419-420insA and the dietary fat absorption deficiency abetalipoproteinemia (ABL) in a family study [125].

Expression studies in cell culture with truncated C-terminus MTTP abolished TG transfer and deletion of a C-terminal 20 aa residue resulted in ABL [126].

Since the initial association studies were carried out with small cohorts, the third paper of this work investigates the association between MTTP variants and the MetS traits BMI, waist circumference and total cholesterol in the large KORA cohort with 7582 participants. For comprehensive locus coverage 8 haplotype-tagging SNPs (rs3811800, rs3816873, rs1057613, rs2035816, rs982424, rs2306985, rs2903202, rs1491244) comprising 52kb of the MTTP locus were examined.

→ {3} M. Böhme, H. Grallert, A. Fischer, C. Gieger, I. Nitz, I. Heid, C. Kohl, H.-E. Wichmann, T. Illig, F. Döring, **MTTP variants and body mass index, waist circumference and serum cholesterol level: Association analyses in 7582 participants of the KORA study cohort**, *Molecular Genetics and Metabolism* 95 (2008) 229-232..

The Prostaglandin E Synthase 2 (PTGES2)

The prostaglandin E synthase 2 gene isoform 1 (PTGES2, OMIM accession number: 608152; GenBank: NM_025072.4) maps to the chromosomal band 9q34.11, contains 9 exons and codes for a 33 kDa protein comprising 377 aa residues. It is required for prostaglandin E₂ (PGE₂) production from PGH₂. PGE₂ is the most common prostanoid of the eicosanoid family. It is synthesised from endogenously produced or exogenically supplied semi-essential AA, which is converted to PGG₂ and PGH₂ by cyclooxygenases (COX1 and 2). PGE₂ exerts a broad range of bioactivities like smooth muscle dilatation/contraction, sodium excretion, body temperature regulation, induction of pain, inflammation-associated bone resorption and inhibition of immune responses [127]. Beside its considered role as the principal prostaglandin in acute inflammation, PGE₂ also blocks lipolysis and induces hypertrophy in adipose tissue. Furthermore, leptin releasing properties were described [128].

Three PTGES are known. The first is the ubiquitously and constitutively expressed cytosolic (c)PTGES, which is relevant for basal PGE₂ production. The second is the inducible microsomal or membrane bound (m)PTGES1, which plays a central role in inflammation.

Due to this function, mPTGES1 is the PTGES analysed most extensively [129]. Both PTGES belong to the membrane-associated proteins involved in eicosanoid and glutathione (GSH) metabolism (MAPEG) family, unlike the third PTGES. The third (m)PTGES2 does not require GSH for activation, although its activity is enhanced by GSH and other thiol compounds. Based on sequence analysis PTGES2 showed a $^{110}\text{Cys-x-x-Cys}^{113}$ region, which is also present in thioredoxin and glutaredoxin. Since PTGES2 activity was abrogated by ^{110}Cys mutation, it can be assigned to the thioredoxin family [130].

Three PTGES2 isoforms are known, of which the isoform 1 is the most abundant. It is constitutively expressed in various tissues, including skeletal muscle, kidney, liver and adipocytes, where PTGES1 levels are low [131]. Unlike PTGES1, PTGES2 is not induced by the pro-inflammatory cytokines IL-1 β , TNF α or NF- κ B. PTGES2 promoter studies on mice showed multiple Sp1 sites and a GC box without a TATA box motif [132]. Interestingly, KO of the inflammation-stimulated COX2 gene in mice decreased PTGES2 expression, while PTGES1 expression was unaffected [133]. In an animal model of adjuvant-induced arthritis PTGES1 and COX2 level increased, while cPTGES and COX1 level were not altered, as described prior for inflammatory diseases. The PTGES2 level slightly decreased [134]. This indicates a more basal metabolic function of PTGES2 that is not primarily inflammation-dependent.

PTGES2 is identical with the gamma-activated transcriptional element (GATE) binding factor (GBF1), which is induced by interferon γ (IFN γ). Since IFN γ is a critical cytokine in viral infection, PTGES2 may still be involved in disease-related metabolism. Accordingly, PTGES2 is up-regulated in a variety of cancers. However, the strong *trans*-activating activity of GBF1 is accompanied by a weak DNA binding property [135].

Association studies between PTGES2 and MetS traits are limited. Linkage between the PTGES2 harbouring chromosomal band 9q34.11 and body weight has been described [136]. Three independent study populations showed associations between the PTGES2 R298H (rs13283456) polymorphism and reduced risk for T2D [137-139]. The promoter SNP g.-417G>T and three haplotype tagging SNPs (rs884115, rs10987883, rs4837240) showed no association with traits of the MetS [138]. Association between the R298H and reduced fasting insulin, pp-insulin after OGTT and reduced HOMA index disappeared after adjustment for BMI, though BMI was only marginally associated with the H-allele [137].

The fourth paper of this work examines if the rare H-allele contributes to BMI changes. Therefore, the association between PTGES2 R298H polymorphism and BMI in a large (n=8079) population-based survey of the KORA study cohort was analysed.

→ {4} A. Fischer, H. Grallert, M. Böhme, C. Gieger, I. Lindner, I. Heid, H.-E. Wichmann, F. Döring, T. Illig, **Association analysis between the PTGES2 R298H polymorphism and body mass index in 8079 participants of the KORA study cohort**, *Genetic Testing* (2008).

General discussion

Genotypic association of the FABP2 promoter haplotypes with BMI

Few studies have yet carried out association analysis of the FABP2 promoter and traits of the MetS. The first paper of this work explores the association of the FABP2 promoter haplotypes with BMI, a predominant component of the MetS. All previous studies were conducted in small cohorts with an average size of 150 and never more than 1300 people. For the present study, the KORA cohort with 8072 participants was used for association examination.

No association between the FABP2 promoter haplotypes and BMI was found in the study population unstratified by gender and in the female subgroup. Male subjects showed a significant reduction in BMI of -0.39 BMI units ($p=0.02$) for the homozygous FABP2 promoter haplotype B compared with homozygous haplotype A. Male carrier of haplotype B (additive model) showed a significant decrease in BMI of -0.19 BMI units ($p=0.03$). These findings were congruent with a significant reduction in BMI of the minor haplotype carrier in the BMI point categories of 25-30 (-0.10 BMI units, $p=0.03$) and <30 (-0.37 BMI units, $p=0.02$).

Significant haplotype differences were only seen after gender stratification and solely for male participants. A reduction in BMI of male haplotype B carrier is further evidence for the previously stated protective effects of the FABP2 promoter haplotype B against traits of the MetS and T2D [80, 81, 83]. Although these results are in contrast to increased BMI in female and lack of association with male BMI of non-Hispanics from Colorado (USA) [81]. These differences may partly be due to different diet composition, especially FA, as described for the FABP2 Ala54Thr polymorphism [72, 73]. Medication is not surveyed in the KORA cohort. This may confound results since pharmacologic treatment potentially influences traits of the MetS [140]. Additionally, divergent associations of the FABP2 Ala54Thr SNP and the FABP2 promoter polymorphisms in various populations may be due to a varying LD [81]. The LD (D' and r^2) between the FABP2 promoter haplotype tagging SNP c.-471G>A and the Ala54Thr polymorphism were analysed [unpublished] using Haploview 4.0 [141]. Table 2 shows D' and r^2 for the 3 HapMap supported populations CEU (CEPH: Utah residents with ancestry from northern and western Europe), YRI (Yoruba in Ibadan, Nigeria) and CHB+JPT (Han Chinese in Beijing, China and Japanese in Tokyo, Japan) [142]. Haploview analysis revealed maximal LD scores only for the CEU population and solely with the D' algorithm. Calculations with the r^2 algorithm showed no complete LD in any population of the HapMap

project. The complete LD in CEU was not confirmed by a study of Formanack and Baier, who found complete LD exclusively in Pima Indians but not in white Americans [82].

Table 2. D' and r² between the FABP2 promoter haplotype tagging SNP c.-471G>A and the FABP2 Ala54Thr polymorphism

| <i>population</i> | <i>D'</i> | <i>r²</i> |
|-------------------|-----------|----------------------|
| CEU | 1.000 | 0.491 |
| YRI | 0.926 | 0.267 |
| CHB+JPT | 0.910 | 0.559 |

Abbreviations used: CEU: (CEPH) population from Utah residents with ancestry from northern and western Europe, YRI: population from Yoruba in Ibadan, Nigeria, CHB+JPT: population from Han Chinese in Beijing, China and Japanese in Tokyo, Japan

A gender specific phenotype has previously been described in FABP2 KO mice [32], which was shown to be associated with elevated body weight, plasma insulin and TG, as well as high fat diet induced fatty liver specifically in male mice [46, 47]. It must be admitted that this is in contrast to reduced BMI of the *in vitro* less active FABP2 haplotype B.

The finding that FABP2 is associated with BMI solely in males is not implausible, since different sets of genes influence BMI in men and women. Various studies have shown estrogen- and testosterone-specific gene regulation. This highlights the impact of age as a confounding factor in association studies. Indeed, a strong age-dependent association with obesity has been shown for the gene roundabout axon guidance receptor homolog 1 (ROBO1) in several studies [143]. Besides, anatomical and physiological differences between men and women in fat distribution, insulin resistance, lipid metabolism and cardiovascular function have been described. These gender-dependent variations can result in a sex-specific phenotype [144], albeit gender-dependent and haplotype specific FABP2 regulation awaits to be functionally examined.

One possible regulative pathway may act via PPAR γ . Paper {2} shows increased haplotype B activity after Rosiglitazone stimulated PPAR γ /RXR α administration. Animal models revealed higher PPAR activity in male mice compared to females [145, 146]. This may lead to a larger activity range of ectopic expressed FABP2 haplotype B, which results in a more distinctive effect on metabolic traits.

A positive effect of increased haplotype B activity may be the regulation of the glucagon like peptide 1 (GLP1). FABP2 may not be expressed solely in enterocytes but also in GLP-expressing intestinal epithelial L-cells [Klapper, M, personal communication]. Despite its role in insulin und glucagon homeostasis GLP1 increases satiety [147]. Carriers of a more active

FABP2 haplotype are able to transport higher amounts of FA, which increase GLP1 expression resulting in earlier satiety. A gender-specific influence may exist, since GLP1 levels are lower in males [148]. Hence, haplotype-specific regulation may have more impact on low male GLP1 levels than on high female levels. In future studies FABP2 and GLP1 expression in genotyped males and females has to be analysed for validation of these hypotheses.

Paper {1} revealed a reduced BMI for non-obese but not for obese males carrying haplotype B. Hence, the FABP2 promoter haplotype B has a protective effect against overweight only as long as obesity has not occurred.

Men with increased BMI had more intra-abdominal adipose tissue than visceral adipose tissue compared to females [149]. Intra-abdominal fat is associated with increased plasma TG, fasting glucose, postprandial insulin, free FA and blood pressure, as well as with an increase in pro-inflammatory cytokines like TNF α , NF- κ B or IL6 [149-151]. Obesity is further associated with an increase in the LDL atherosclerosis marker lipoprotein(a) in men but not in women [152]. The increase in several metabolic risk factors in obese men may abolish the positive effect of the FABP2 haplotype B observed in normal weight men.

In conclusion, the first paper of this work shows association of the FABP2 promoter haplotype B with reduced BMI but only in normal weight males.

Functional analysis of FABP2 promoter haplotypes

Several studies which have analysed the distribution of polymorphisms found that functional SNPs occur in 30-60% of human promoters. They tend to cluster in close proximity, around 100 bp upstream, to the transcription start site. These data indicate that promoters may represent a major site where polymorphisms contribute to human disease [153].

Search for polymorphisms in the FABP2 promoter revealed six polymorphic sites altering the transcriptional activity of FABP2, which were associated with traits of the MetS [80, 81, 83]. Genome wide linkage scan revealed an association of the FABP2 locus with physical fitness in dizygotic female twins [154] but lacked MetS association [155-157]. A 2- to 3-fold lower activity of FABP2 promoter haplotype B in post-confluent Caco-2 cells is caused by decreased binding affinity of GATA5 and 6 to the c.-80_-79insT polymorphism [84]. Additionally, FABP2 deficient HeLa cells exhibited a 2-fold higher activity of haplotype B

than A by Rosiglitazone stimulated PPAR γ /RXR α [85]. Here, a PPAR γ binding site at position -623/-607 of the FABP2 promoter was identified via *in silico* analysis and electrophoretic mobility shift assays (EMSA). Since haplotype specific binding of PPAR γ to the FABP2 promoter was not observed this *cis*-acting element for PPAR γ can not solely account for haplotype specific regulation. Interaction with one or more TFs seems likely.

Polymorphism c.-471G>A was involved in determining different FABP2 promoter haplotype activities. However, reversal of the mutation in the opposite haplotype did not abrogate PPAR γ inductivity. More precise investigation of the region comprising polymorphism -471 via *in silico* and EMSA analysis revealed an octamer-binding TF 1 (OCT1) binding site. Transfection of OCT1 induced FABP2 promoter activity by a factor of three without haplotype specific variation. The different FABP2 promoter haplotype activities after Rosiglitazone stimulated PPAR γ /RXR α transfection were abolished after co-transfection with OCT1. Thus, high concentration of OCT1 can override the effect of PPAR γ /RXR α on different activities of FABP2 promoter haplotypes.

PPAR γ promotes the expression of FABP1 and 4 [158], albeit the relevance for Rosiglitazone dependent PPAR γ /RXR α regulation of the FABP2 promoter haplotypes has to be considered carefully. *In vivo* FABP2 is present in the small intestine [23] where PPAR α and PPAR δ , but not PPAR γ , are predominantly expressed [159]. The higher activating potential of FABP2 promoter haplotype B by PPAR γ might result in an ectopic expression of FABP2 in PPAR γ expressing tissues of haplotype B carriers. PPAR γ was associated with T2D and obesity [155-157]. Therefore, FABP2 may exhibit its influence on the MetS via PPAR γ specific ectopic regulation.

The ubiquitously expressed OCT1 plays a central role in metabolic homeostasis [160, 161]. However, the OCT1 dependent up-regulation of FABP2 promoter constructs in HeLa cells could not be confirmed in intestinal cells. Transfection of OCT1 in Caco-2 cells showed no effect on FABP2 mRNA level. Even if OCT1 seems not to be relevant for intestinal FABP2 expression, it may contribute to an ectopic expression of FABP2 in tissues with high OCT1 expression like prostate, cortex or lymphocytes [25]. A interdependence between PPAR γ /RXR α and OCT1 can be present either via direct binding of RXR with OCT1 [162], as well as via induction of OCT1 expression by PPAR γ [163].

Figure 2 discloses a working model for the interaction between TFs and the FABP2 promoter in HeLa cells. PPAR γ binds at position -623/-607 and drives haplotype specific activation via interaction with a hypothetical HeLa cell specific TF (TFH1). TFH1 binds to the promoter region around SNP c.-471G>A in a haplotype specific manner. The complex is stabilised by RXR α and Rosiglitazone (Rosi). This results in haplotype specific promoter assay activity (Fig. 2A). Co-transfection with OCT1 abolishes haplotype specific TFH1 binding. Since OCT1 increased neither FABP2 mRNA levels [2] nor luciferase promoter plasmid activity in Caco-2 cells [unpublished], PPAR γ /RXR α /OCT1 derived activity in HeLa cells seems to be regulated by another factor (TFH2) (Fig. 2B).

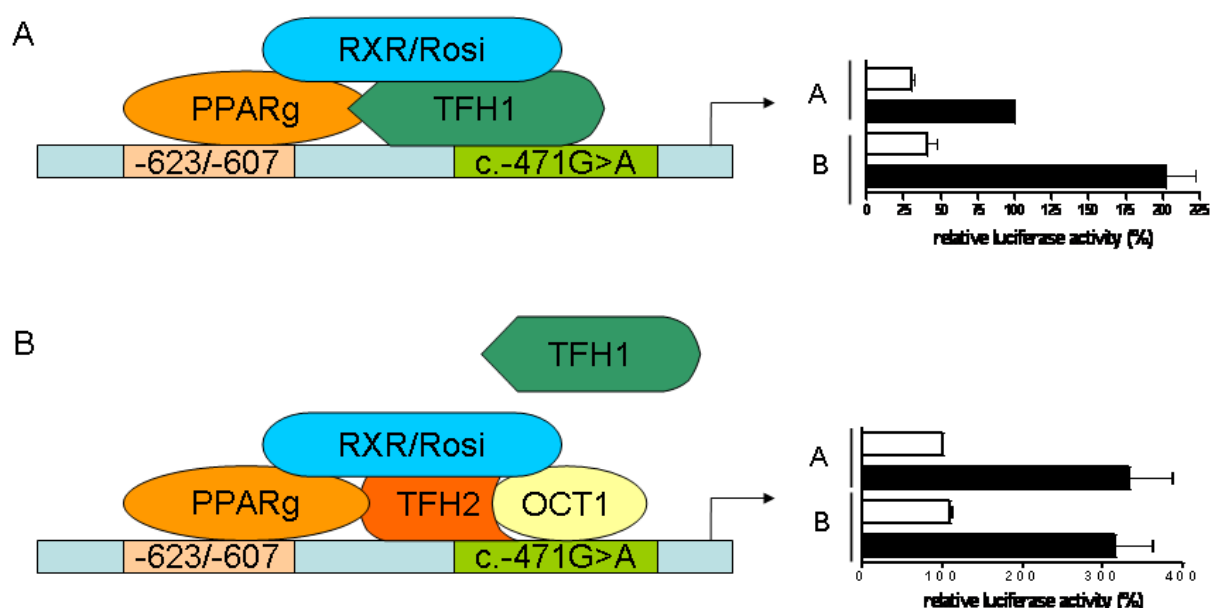

Figure 2. Working model for the HeLa cells specific TF binding to FABP2 promoter haplotypes A and B after transfection with Rosiglitazone (Rosi) stimulated A) PPAR γ /RXR α and B) PPAR γ /RXR α /OCT1. TFH1/2 abbreviates hypothetical HeLa cell specific TFs. White bars indicate basal activity of luciferase promoter constructs. Black bars show promoter activity after induction with Rosi. N=3, +SD. Refer to text for detailed explanation and to [2] for transfection procedures.

Identification of TFH1 and 2 candidates is not trivial. TFH1 has to be a TF interacting with PPAR γ and/or RXR α and competing with OCT1 for binding sites. PPAR γ activity and interaction is diverse, ranging from ligand independent transcriptional enhancer function to inhibition of gene activity, incorporated in a multifactor complex comprising several co-factors and ligands. One TFH1 candidate may be NF- κ B, since PPAR γ interacting properties, as well as overlapping binding sites with OCT1 were described for the CRP promoter [159, 164]. Overlapping with an OCT1 binding site and PPAR γ co-factor activity was also shown for AP1 on the IL5 promoter [165]. Interestingly, basal NF- κ B and AP1 activity in HeLa cells

was enhanced by TNF α administration [166]. This may indicate an enhanced ectopic activity of FABP2 haplotype B in diseases associated with an increased inflammation status, leading to an adverse feedback effect. FA induce NF- κ B and TNF α via elevated ROS production [167]. Increased NF- κ B and TNF α may enhance FABP2 expression which elevates FA transport. At this, it has to be considered that PPAR γ negatively influences the production of inflammatory cytokines such as TNF α and may slow down the self-enhancing FA-ROS-cytokine-FABP2-FA loop [159]. However, a putative up-regulation of the FABP2 haplotype B in inflammation may be in contrast to a higher haplotype A activity in healthy individuals anticipated from expression in Caco-2 cells. This has to be taken into account when recruiting patients for association studies.

Furthermore, the silencing mediator of retinoid and thyroid receptor (SMRT) regulates transcription of the oxidised LDL receptor together with PPAR γ /RXR α . SMRT may be a candidate for TFH2, since binding of OCT1 with SMRT was shown in COS-7 cells. A second candidate interacting with PPAR γ and OCT1 is the ubiquitously expressed C/EBP β [159]. So far, SMRT [168] and C/EBP β [169] have been described as transcriptional repressors, which is contrary to the activation seen in HeLa cells. Additionally, C/EBP β may be a TFH1 candidate, since transcriptional interference of OCT1 and C/EBP β was described for the androgen receptor [170]. Another interesting TFH2 candidate may be the ubiquitously expressed and in cancer up-regulated signal transducer and activator of transcription 3 (STAT3). Promoter assays revealed that the α 2-macroglobulin promoter is activated only in the presence of STAT3, even if an enhanceosome, which comprises OCT1 transactivation, is associated with the promoter region [171].

In conclusion, paper {2} revealed haplotype specific activation of the FABP2 promoter by PPAR γ . A PPAR γ binding site at position -623/-607 was identified. Haplotype specific activity is controlled via polymorphism c.-471G>A. This polymorphic site revealed no PPAR γ but OCT1 binding. Even if OCT1 induces the FABP2 promoter, it lacks haplotype specific activity. These effects were solely observed in HeLa cells but not in Caco-2 {2} and HepG2 cells [unpublished].

To elucidate the haplotype specific regulation of the FABP2 promoter via PPAR γ /RXR α and OCT1 ChIP analysis should be carried out for both haplotypes in HeLa and Caco-2 cells to reveal TFH1 and 2 candidates. Furthermore, it would be interesting to measure FABP2 mRNA and protein abundance in intestinal and adipocyte biopsies from homozygous haplotype A and B carriers for clarification of putative ectopic expression.

Genotypic association of the MTTP H297Q polymorphism with BMI, waist circumference and total cholesterol

More than four million SNPs have been identified in coding and non-coding regions of the human genome, occurring roughly every 100 to 1000 bp [153, 172]. To account for genetic variety of the MTTP locus, the third paper of this work displays association analysis with BMI, waist circumference and total cholesterol of 7 htSNPs and 2 non-synonymous cSNPs of a 52 kb MTTP locus region in the KORA cohort.

Multiple studies showed associations of the c.-493G>T, c.-400A>T, c.-164T>C and I128T SNPs and diverse traits of the MetS leading to contradictory results [96]. All studies were conducted in small cohorts with no more than several hundred participants. The KORA cohort with 7582 MTTP genotyped participants exhibits no association with the I128T polymorphism and BMI, waist circumference or plasma lipids. Functional analyses of the promoter polymorphisms and the I128T SNP displayed a combination of a high promoter activity with low protein functionality and vice versa [97, 107]. The resulting consequence of these opposing effects seems to be a neutral phenotype.

Surprisingly, the hitherto inconspicuous H297Q polymorphism revealed association to MetS traits. Stratification for gender revealed that the general reducing effect of the Q-allele in BMI (Q-carrier: -0.18 BMI unit, $p=0.01$; Q/Q: -0.43 BMI units, $p=0.01$), waist circumference (Q-carrier: -0.45 cm, $p=0.01$; Q/Q: -0.99 cm, $p=0.01$) and total cholesterol (Q-carrier: -0.04 mmol/l, $p=0.03$; Q/Q: -0.10 mmol/l, $p=0.01$) is caused by alterations in the female subgroup. Only females carrying the Q-allele showed a decrease in BMI (Q-carrier: -0.26 BMI unit, $p=0.02$; Q/Q: -0.66 BMI units, $p=0.01$), waist circumference (Q-carrier: -0.66 cm, $p=0.01$; Q/Q: -1.44 cm, $p=0.01$) and total cholesterol (Q-carrier: -0.05 mmol/l, $p=0.03$; Q/Q: -0.11 mmol/l, $p=0.03$).

In silico analysis of the His to Gln exchange at position 297 with Protean (DNASTar-Lasergene 7.0) revealed a slightly less charged and more hydrophobic MTTP protein [unpublished]. Position 297 is located in a domain relevant for lipid binding. This suggests increase in lipid acquisition which may lead to faster chylomicron and VLDL maturation in Q-allele carrier. This is consistent with observations of fat malabsorption, hepatic steatosis and insulin resistance in MTTP loss of function patients and KO mice [93, 96].

Conversely, a decrease in delivery and, hence, a retarded lipoprotein maturation is conceivable. This hypothesis may be more congruent with reduced total cholesterol levels. Cholesterol is transported to the periphery via chylomicrons, VLDL and LDL, whereby

MTTP is relevant for the assembly of these lipoproteins [173]. A second function of MTTP is lipid transport. A delay in TG transport may lead to decreased delivery of TG to the periphery especially the abdominal adipose tissue resulting in reduced waist circumference and overall BMI.

Associations with the MTTP 297Q allele were solely found in women. A female-specific more active rare -493T showed lower TG, VLDL, LDL levels and blood pressure [101, 174, 175]. Contrary, 128T allelic T2D men from the EPIC study were associated with reduced waist circumference and BMI. This was not observed in women from the EPIC cohort [107]. Since MTTP and apoB are forming a complex, protein interactions have to be considered. It has been shown that apoB mRNA and protein levels are higher in females [176, 177]. Hence, H297Q dependent MTTP activity may exhibit more pronounced effects in females than in males resulting in a larger phenotype change.

Based on functional associations, the c.-493G>T, c.-400A>T, c.-164T>C and I128T SNPs might have an overall neutral effect. This work revealed a strong impact of the H297Q SNP on lipid metabolism. Hence, it is debateable if former associations were caused by the H297Q polymorphism due to random linkage, rather than evoked by the I128T or promoter SNPs. This would explain contradictory study results mentioned above.

Future studies should analyse H297Q haplotype specific MTTP levels in males and females to reveal functional impact of this polymorphism.

In conclusion, the third paper of this work shows a new association of the MTTP H297Q polymorphism with a strong MetS phenotype. Female Q-carrier showed lower BMI, waist circumference and total cholesterol. Accordingly, re-analysis of prior associated loci can still be important to find new candidates for complex diseases.

Genotypic association of the PTGES2 R298H polymorphism with BMI

Prior studies revealed association of the PTGES2 R298H polymorphism with T2D. To elucidate a BMI mediated influence on T2D the R298H and 3 htSNPs comprising a 20 kb region of the PTGES2 gene were analysed in 8079 participants of the KORA cohort.

No association to BMI was found for the 3 htSNPs as well as for females heterozygous for the 298H allele. Only males heterozygous for the R298H polymorphism showed association with reduced BMI (R/H: -0.30 BMI units, $p=0.02$). This was confirmed by haplotype analysis.

Only a 298H containing haplotype showed a significant decrease of BMI in males (-0.19 BMI units, $p=0.04$) but not in females. Homozygous H-allele carrier displayed no association.

A protective effect of the rare H-allele was described for T2D, impaired glucose tolerance, fasting and postprandial insulin levels, HOMA indices and insulin resistance [137-139]. The fourth paper stated a BMI lowering effect of the H-allele but solely in heterozygous males.

Hypothesis generation for a H-allele dependent phenotype remains challenging, since the functions of PGE₂ are diverse. PTGES2 forms homotetramers for enzymatic activity. The R298H SNP is located in the homotetramer forming region which may result in altered enzymatic activity [130]. A heterozygous genotype might lead to a slight decrease in overall PTGES2 function causing a small reduction of PGE₂ level. PGE₂ possesses anti-lipolytic activity and induces adipocyte hypertrophy, hence a reduced PGE₂ level may result in a lower BMI [178-180]. Assuming that PTGES2 homotetramer formation is abolished or highly impaired in homozygous H-allele carrier, the lack of BMI reduction may be due to (over)compensatory up-regulation of other PTGES enzymes. Indeed, PGE₂ level were 2-fold increased in male but not in female homozygous H-allele carrier. However, a heterozygous phenotype showed no reduction of PGE₂ [181].

Gender dependent haplotype specific activity of PTGES2 is not reported until now. It was stated that PTGES genes are regulated via PPAR γ [182]. A sex specific expression profile of PPAR γ was shown earlier [145]. Further, a putative estrogen binding site in the PTGES2 promoter was examined via *in silico* analysis [181] while promoter studies are lacking.

The IFN γ induced *trans*-activating activity of PTGES2 might be influenced by the R298H polymorphism [135]. Promoter studies with both haplotypes showed only a low activating potential without a haplotype specific pattern [181].

Even if the H-allele exhibits only a small impact on overall obesity and BMI, it may contribute to a risk reduction of T2D and traits of the MetS. Future studies should analyse the gender-specific expression of the PTGES genes for the various haplotypes.

In conclusion, the fourth paper revealed that the PTGES2 R298H SNP is associated with lower BMI in males.

Outlook

Understanding the functional regulation of complex outcomes is demanding as seen for the FABP2 promoter haplotypes. Often different studies reveal opposing results. In addition to candidate gene approaches current research focuses on genome-wide association studies (GWA) to find genes with strong disease association [183]. The most consistently identified genes associated with MetS traits via GWA were transcription factor 7-like 2 (TCF7L2) for T2D [184], the fat mass and obesity associated gene (FTO) for obesity [185] and the pro-inflammatory cytokine lymphotoxin-alpha (LTA) for CVD [186]. One of the most discussed candidate genes associated with several traits of the MetS are PPAR γ [187-189] as well as the melanocortin 4 receptor (MCR4) [190].

The emerging field of GWA studies failed to show association between FABP2, MTTP or PTGES2 and traits of the MetS [184-189]. To address these apparent contradictory results, one has to look more carefully at GWAs. First, investigated traits like obesity are considered as “complex” but GWAs often associate only one SNP or cluster with specific “complex” traits. Second, assuming that these SNPs are the genetic markers with the strongest impact, they should be replicated in other GWAs. Indeed, this was only feasible for a few SNPs in diverse traits. Third, the functionality of the associated gene has to be taken into account since the most extreme p-value alone is not an adequate predictor of true effects [191]. And fourth, genes identified by GWAs tend to exert the largest effects, but account only for 5-10% of the trait variance. The majority will be more difficult to identify. This becomes apparent on traits like blood pressure which failed to show GWA associations [190].

Beyond, GWAs are far from representing the whole genome. Analysis of 3 current genome wide chips, 500k (Affimetrix) and HumanHap300/550 (Illumina), revealed low coverage especially for singleton SNPs. Singleton SNPs are SNPs that can not be predicted by other SNPs via linkage analysis and therefore expanding the chip costs disproportionately. Singleton SNPs are significantly more frequent non-synonymous, splicing site, 5' or 3'UTR than intronic or intergenic SNPs. This ascribes them a potentially higher functional importance. The tested arrays account only for ~50% of known singleton SNPs. [172]. New GWA arrays incorporate copy number variations (CNV) in their design, since CNV contribute considerably to disease traits. Admittedly, currently available arrays miss at least 20% of known CNVs [192]. With decreasing chip costs this coverage will increase in the future but has to be considered when interpreting published results.

With lower costs and higher datasets of GWAs, data analysis will play the most decisive role in the future. GWAs reveal many candidates associated with slight phenotype changes, which

are *per se* significant, while after multiple testing these candidates are declared as false positives. A GWA of 6148 Sardinians showed association with obesity of the FTO gene but not of FABP2, MTTP or PTGES2. A more detailed examination of the dataset revealed association of FABP2 with BMI (-0.10 BMI units, $p=0.03$), hip circumference (-0.11 cm, $p=0.01$) and weight (-0.08 kg, $p=0.03$) prior to multiple testing. MTTP was analysed but showed no significant associations, while PTGES2 was not examined [193]. Hence, GWAs give more insights into genetic associations, but their results still have to be carefully studied. Further, lack of prior associations in GWA between FABP2 and MetS traits are not contradictory, since most GWAs barely account for gender stratification [144]. In accordance, paper {1} shows association only in the male subgroup but not within the whole study cohort.

Table 3. Association analysis of FABP2 promoter polymorphism and the MTTP H297Q SNP with BMI

| Genotype | | Frequencies (n) | | | Unit change in BMI in kg/m^2 [95% confidence interval] (p values) | | |
|----------------|------------|-----------------|------|------|---|-------------------------------|-------------------------------|
| FABP2 promoter | MTTP Q297H | All | Men | Wom. | All | Men | Women |
| 11 | 11 | 1052 | 515 | 537 | 1 | 1 | 1 |
| 12+22 | 11 | 2049 | 1055 | 994 | 0.04 [-0.28,0.36] (0.81) | 0.01 [-0.39,0.40] (0.98) | 0.10 [-0.41,0.60] (0.70) |
| 11 | 12+22 | 1462 | 695 | 767 | -0.02 [-0.38,0.33] (0.90) | 0.14 [-0.32,0.60] (0.55) | -0.17 [-0.70,0.37] (0.53) |
| 12+22 | 12+22 | 2995 | 1491 | 1504 | -0.02 [-0.54,0.07] (0.13) | -0.30 [-0.68,0.31] (0.11) | -0.16 [-0.64,0.31] (0.51) |
| 22 | 22 | 174 | 80 | 94 | -0.91 [-1.61, -0.2] (0.01) | -0.82 [-1.75, 0.11] (0.08) | -0.99 [-2.02, 0.05] (0.06) |

FABP2 promoter (rs6857641), MTTP Q297H (rs2306985)

One advantage of GWA is the possibility to rapidly find potential gene-gene interaction candidates, which needs more preliminary results in candidate gene approaches. Since male carrier of the FABP2 promoter haplotype B and female MTTP H297Q SNP carrier both displayed reduced BMI in the KORA cohort a combined gene-gene interaction association analysis was carried out [unpublished]. Unlike anticipated, no significant association of the common genotype against one or both rare genotypes was present after gender stratification or in heterozygous individuals. Only unstratified homozygous carrier of both rare polymorphisms exhibited a BMI reducing effect (-0.91 BMI unit, $p=0.01$) (Table 3). The borderline significance in the gender subgroups (males: -0.82 BMI units, $p=0.08$; females: -0.99 BMI units, $p=0.06$) may be caused by too small subgroups (males: $n=80$; females: $n=94$). In conclusion, even if strong phenotypes could be confirmed, results from polymorphism specific regulations can not simply be summarised.

For understanding the complexity of the MetS GWAs will not be the spearhead in life science research. Future investigators will use system based approaches, consisting of GWAs and mass spectrometry in combination with computational and statistical tools leading to genomic-metabolomic-networks [190].

A genomic-metabolomic network needs to incorporate environmental factors into data interpretation to enhance result quality. While environment includes numerous variables, which could not completely be accounted for, interaction with nutrition and particularly fat is of special interest for the present candidate genes.

Independent of the total amount, the type of dietary fat became more important during the past few years. The initially recommended <30% of total energy from fat, 2.5% Ω 6 and 0.5% Ω 3 FA [194] is subdivided into <7% from saturated fat (SFA), minimal trans fat (TFA) and <200mg/d cholesterol. Multiple dietary intervention studies demonstrated beneficial effects of monounsaturated FA (MUFA) and polyunsaturated FA (PUFA) for insulin sensitivity [195]. Interestingly, in animal models MUFA substitution of SFA was not atheroprotective *per se* indicating a more complex FA interaction pattern [196]. The pro-inflammatory potential of Ω 6 as well as the anti-inflammatory potential of Ω 3 PUFAs is well established [197], nevertheless, the Ω 3-ascribed protective effect against T2D was not confirmed in meta analysis [195]. SFA level >15% of daily energy intake are associated with adverse metabolic effects. When provided moderate and balanced with PUFAs SFAs showed lipogenic, amid linkage, bioavailability enhancing, PUFA precursor, cancer prevention and apoptosis initiating characteristics ascribing SFAs new and important cell regulatory functions [198].

Nevertheless, dietary fat intervention studies are numerous with different study settings leading to divergent but often well examined outcomes. Some individuals are relatively insensitive (hypo-responders) to dietary intervention, whereas others (hyper-responders) show enhanced sensitivity [195]. This may partly be due to polymorphisms in fat metabolism genes. Variation in dietary fat-dependent gene regulation was stated earlier for the FABP2 polymorphisms [71-76], while SNP specific nutrigenetic interaction for MTP shows no associations [199] and for PTGES2 awaits elucidation. In general, FABP2 and MTP influence gene regulation via FA regulated TFs which increase transcription of FA transport/metabolism and gluconeogenesis genes but also reduce FA oxidation and carbohydrate processing genes [18, 167]. While PUFAs regulate transcription via PPARs and SREBP, SFAs strongly elevate PGC1 β , interact with HNF4, NF- κ B, C/EBP and PPAR α

[198]. PUFA ($\Omega 6$) mediated gene regulation is further influenced by PTGES2 which is relevant for AA processing [200].

Depending on the variety of dietary composition and its influence on gene regulation there are still numerous possibilities to perform candidate gene and GWA analysis.

In summary, association analysis in the KORA cohort with more than 8000 participants revealed association between BMI and polymorphisms of the FABP2 promoter and the MTTP and PTGES2 genes. The MTTP SNP H297Q and related haplotypes are also associated with waist circumference and total cholesterol. Functional analysis exhibited, that the FABP2 promoter haplotype B is 2-fold more inducible by PPAR γ /RXR α than haplotype A. This difference is caused by polymorphism c.-471G>A. In addition, OCT1 was identified as a TF regulating the FABP2 promoter. In conclusion, variants of the FABP2, MTTP and PTGES2 genes, which are involved in fat metabolism, contribute to the development of the MetS.

References

- [1] K.G. Alberti, P. Zimmet, J. Shaw, Metabolic syndrome--a new world-wide definition. A Consensus Statement from the International Diabetes Federation, *Diabet Med* 23 (2006) 469-480.
- [2] L.M. Chuang, Human genetics of the metabolic syndrome, *Asia Pac J Clin Nutr* 17 Suppl 1 (2008) 43-46.
- [3] A. Guilherme, J.V. Virbasius, V. Puri, M.P. Czech, Adipocyte dysfunctions linking obesity to insulin resistance and type 2 diabetes, *Nat Rev Mol Cell Biol* 9 (2008) 367-377.
- [4] Finishing the euchromatic sequence of the human genome, *Nature* 431 (2004) 931-945.
- [5] G.A. Thorisson, A.V. Smith, L. Krishnan, L.D. Stein, The International HapMap Project Web site, *Genome Res* 15 (2005) 1592-1593.
- [6] N. Chatterjee, Z. Kalaylioglu, R. Moslehi, U. Peters, S. Wacholder, Powerful multilocus tests of genetic association in the presence of gene-gene and gene-environment interactions, *Am J Hum Genet* 79 (2006) 1002-1016.
- [7] R.K. Ockner, J.A. Manning, J.P. Kane, Fatty acid binding protein. Isolation from rat liver, characterization, and immunochemical quantification, *J Biol Chem* 257 (1982) 7872-7878.
- [8] L.J. Baier, C. Bogardus, J.C. Sacchettini, A polymorphism in the human intestinal fatty acid binding protein alters fatty acid transport across Caco-2 cells, *J Biol Chem* 271 (1996) 10892-10896.
- [9] A. Chmurzynska, The multigene family of fatty acid-binding proteins (FABPs): function, structure and polymorphism, *J Appl Genet* 47 (2006) 39-48.
- [10] Z. Xu, D.A. Bernlohr, L.J. Banaszak, The adipocyte lipid-binding protein at 1.6-A resolution. Crystal structures of the apoprotein and with bound saturated and unsaturated fatty acids, *J Biol Chem* 268 (1993) 7874-7884.
- [11] J.M. LaLonde, M.A. Levenson, J.J. Roe, D.A. Bernlohr, L.J. Banaszak, Adipocyte lipid-binding protein complexed with arachidonic acid. Titration calorimetry and X-ray crystallographic studies, *J Biol Chem* 269 (1994) 25339-25347.
- [12] H.L. Liou, P.C. Kahn, J. Storch, Role of the helical domain in fatty acid transfer from adipocyte and heart fatty acid-binding proteins to membranes: analysis of chimeric proteins, *J Biol Chem* 277 (2002) 1806-1815.
- [13] F. Zhang, C. Lucke, L.J. Baier, J.C. Sacchettini, J.A. Hamilton, Solution structure of human intestinal fatty acid binding protein: implications for ligand entry and exit, *J Biomol NMR* 9 (1997) 213-228.
- [14] J.E. Schaffer, Fatty acid transport: the roads taken, *Am J Physiol Endocrinol Metab* 282 (2002) E239-246.
- [15] M.M. Vork, J.F. Glatz, G.J. Van Der Vusse, On the mechanism of long chain fatty acid transport in cardiomyocytes as facilitated by cytoplasmic fatty acid-binding protein, *J Theor Biol* 160 (1993) 207-222.
- [16] K.T. Hsu, J. Storch, Fatty acid transfer from liver and intestinal fatty acid-binding proteins to membranes occurs by different mechanisms, *J Biol Chem* 271 (1996) 13317-13323.
- [17] M.J. McArthur, B.P. Atshaves, A. Frolov, W.D. Foxworth, A.B. Kier, F. Schroeder, Cellular uptake and intracellular trafficking of long chain fatty acids, *J Lipid Res* 40 (1999) 1371-1383.
- [18] A. Wise, Transcriptional switches in the control of macronutrient metabolism, *Nutr Rev* 66 (2008) 321-325.

References

- [19] J.A. Madrazo, D.P. Kelly, The PPAR trio: regulators of myocardial energy metabolism in health and disease, *J Mol Cell Cardiol* 44 (2008) 968-975.
- [20] N.S. Tan, N.S. Shaw, N. Vinckenbosch, P. Liu, R. Yasmin, B. Desvergne, W. Wahli, N. Noy, Selective cooperation between fatty acid binding proteins and peroxisome proliferator-activated receptors in regulating transcription, *Mol Cell Biol* 22 (2002) 5114-5127.
- [21] C. Wolfrum, C.M. Borrmann, T. Borchers, F. Spener, Fatty acids and hypolipidemic drugs regulate peroxisome proliferator-activated receptors alpha - and gamma-mediated gene expression via liver fatty acid binding protein: a signaling path to the nucleus, *Proc Natl Acad Sci U S A* 98 (2001) 2323-2328.
- [22] G. Wang, Y. Gong, J. Anderson, D. Sun, G. Minuk, M.S. Roberts, F.J. Burczynski, Antioxidative function of L-FABP in L-FABP stably transfected Chang liver cells, *Hepatology* 42 (2005) 871-879.
- [23] D.A. Sweetser, S.M. Hauff, P.C. Hoppe, E.H. Birkenmeier, J.I. Gordon, Transgenic mice containing intestinal fatty acid-binding protein-human growth hormone fusion genes exhibit correct regional and cell-specific expression of the reporter gene in their small intestine, *Proc Natl Acad Sci U S A* 85 (1988) 9611-9615.
- [24] L.B. Agellon, M.J. Toth, A.B. Thomson, Intracellular lipid binding proteins of the small intestine, *Mol Cell Biochem* 239 (2002) 79-82.
- [25] A.I. Su, T. Wiltshire, S. Batalov, H. Lapp, K.A. Ching, D. Block, J. Zhang, R. Soden, M. Hayakawa, G. Kreiman, M.P. Cooke, J.R. Walker, J.B. Hogenesch, A gene atlas of the mouse and human protein-encoding transcriptomes, *Proc Natl Acad Sci U S A* 101 (2004) 6062-6067.
- [26] H.M. Shields, M.L. Bates, N.M. Bass, C.J. Best, D.H. Alpers, R.K. Ockner, Light microscopic immunocytochemical localization of hepatic and intestinal types of fatty acid-binding proteins in rat small intestine, *J Lipid Res* 27 (1986) 549-557.
- [27] J.I. Gordon, N. Elshourbagy, J.B. Lowe, W.S. Liao, D.H. Alpers, J.M. Taylor, Tissue specific expression and developmental regulation of two genes coding for rat fatty acid binding proteins, *J Biol Chem* 260 (1985) 1995-1998.
- [28] N. Dube, E. Delvin, W. Yotov, C. Garofalo, M. Bendayan, J.H. Veerkamp, E. Levy, Modulation of intestinal and liver fatty acid-binding proteins in Caco-2 cells by lipids, hormones and cytokines, *J Cell Biochem* 81 (2001) 613-620.
- [29] C. Darimont, N. Gradoux, A. de Pover, Epidermal growth factor regulates fatty acid uptake and metabolism in Caco-2 cells, *Am J Physiol* 276 (1999) G606-612.
- [30] K. Mochizuki, K. Suruga, E. Yagi, S. Takase, T. Goda, The expression of PPAR-associated genes is modulated through postnatal development of PPAR subtypes in the small intestine, *Biochim Biophys Acta* 1531 (2001) 68-76.
- [31] K. Motojima, Differential effects of PPARalpha activators on induction of ectopic expression of tissue-specific fatty acid binding protein genes in the mouse liver, *Int J Biochem Cell Biol* 32 (2000) 1085-1092.
- [32] G. Vassileva, L. Huwyler, K. Poirier, L.B. Agellon, M.J. Toth, The intestinal fatty acid binding protein is not essential for dietary fat absorption in mice, *Faseb J* 14 (2000) 2040-2046.
- [33] S.M. Cohn, T.C. Simon, K.A. Roth, E.H. Birkenmeier, J.I. Gordon, Use of transgenic mice to map cis-acting elements in the intestinal fatty acid binding protein gene (Fabpi) that control its cell lineage-specific and regional patterns of expression along the duodenal-colonic and crypt-villus axes of the gut epithelium, *J Cell Biol* 119 (1992) 27-44.
- [34] N.S. Belaguli, M. Zhang, M. Rigi, M. Aftab, D.H. Berger, Cooperation between GATA4 and TGF-beta signaling regulates intestinal epithelial gene expression, *Am J Physiol Gastrointest Liver Physiol* 292 (2007) G1520-1533.

References

- [35] M. Klapper, M. Bohme, I. Nitz, F. Doring, Transcriptional regulation of the fatty acid binding protein 2 (FABP2) gene by the hepatic nuclear factor 1 alpha (HNF-1alpha), *Gene* 416 (2008) 48-52.
- [36] M. Klapper, M. Bohme, I. Nitz, F. Doring, The human intestinal fatty acid binding protein (hFABP2) gene is regulated by HNF-4alpha, *Biochem Biophys Res Commun* 356 (2007) 147-152.
- [37] E. Levy, D. Menard, E. Delvin, S. Stan, G. Mitchell, M. Lambert, E. Ziv, J.C. Feoli-Fonseca, E. Seidman, The polymorphism at codon 54 of the FABP2 gene increases fat absorption in human intestinal explants, *J Biol Chem* 276 (2001) 39679-39684.
- [38] J.B. Lowe, J.C. Sacchettini, M. Laposata, J.J. McQuillan, J.I. Gordon, Expression of rat intestinal fatty acid-binding protein in *Escherichia coli*. Purification and comparison of ligand binding characteristics with that of *Escherichia coli*-derived rat liver fatty acid-binding protein, *J Biol Chem* 262 (1987) 5931-5937.
- [39] H.R. Kim, S.W. Park, H.J. Cho, K.A. Chae, J.M. Sung, J.S. Kim, C.P. Landowski, D. Sun, A.M. Abd El-Aty, G.L. Amidon, H.C. Shin, Comparative gene expression profiles of intestinal transporters in mice, rats and humans, *Pharmacol Res* 56 (2007) 224-236.
- [40] G.R. Franchini, J. Storch, B. Corsico, The integrity of the alpha-helical domain of intestinal fatty acid binding protein is essential for the collision-mediated transfer of fatty acids to phospholipid membranes, *Biochim Biophys Acta* 1781 (2008) 192-199.
- [41] A. Gedde-Dahl, M.A. Kulseth, T. Ranheim, C.A. Drevon, A.C. Rustan, Reduced secretion of triacylglycerol in CaCo-2 cells transfected with intestinal fatty acid-binding protein, *Lipids* 37 (2002) 61-68.
- [42] A. Montoudis, E. Seidman, F. Boudreau, J.F. Beaulieu, D. Menard, M. Elchebly, G. Mailhot, A.T. Sane, M. Lambert, E. Delvin, E. Levy, Intestinal fatty acid binding protein regulates mitochondrion beta-oxidation and cholesterol uptake, *J Lipid Res* 49 (2008) 961-972.
- [43] B.P. Atshaves, W.B. Foxworth, A. Frolov, J.B. Roths, A.B. Kier, B.K. Oetama, J.A. Piedrahita, F. Schroeder, Cellular differentiation and I-FABP protein expression modulate fatty acid uptake and diffusion, *Am J Physiol* 274 (1998) C633-644.
- [44] D.R. Prows, E.J. Murphy, F. Schroeder, Intestinal and liver fatty acid binding proteins differentially affect fatty acid uptake and esterification in L-cells, *Lipids* 30 (1995) 907-910.
- [45] D.R. Prows, E.J. Murphy, D. Moncecchi, F. Schroeder, Intestinal fatty acid-binding protein expression stimulates fibroblast fatty acid esterification, *Chem Phys Lipids* 84 (1996) 47-56.
- [46] L.B. Agellon, L. Li, L. Luong, R.R. Uwiera, Adaptations to the loss of intestinal fatty acid binding protein in mice, *Mol Cell Biochem* 284 (2006) 159-166.
- [47] L.B. Agellon, L. Drozdowski, L. Li, C. Iordache, L. Luong, M.T. Clandinin, R.R. Uwiera, M.J. Toth, A.B. Thomson, Loss of intestinal fatty acid binding protein increases the susceptibility of male mice to high fat diet-induced fatty liver, *Biochim Biophys Acta* 1771 (2007) 1283-1288.
- [48] L.J. Baier, J.C. Sacchettini, W.C. Knowler, J. Eads, G. Paolisso, P.A. Tataranni, H. Mochizuki, P.H. Bennett, C. Bogardus, M. Prochazka, An amino acid substitution in the human intestinal fatty acid binding protein is associated with increased fatty acid binding, increased fat oxidation, and insulin resistance, *J Clin Invest* 95 (1995) 1281-1287.
- [49] J.R. Galluzzi, L.A. Cupples, J.D. Otvos, P.W. Wilson, E.J. Schaefer, J.M. Ordovas, Association of the A/T54 polymorphism in the intestinal fatty acid binding protein with variations in plasma lipids in the Framingham Offspring Study, *Atherosclerosis* 159 (2001) 417-424.

References

- [50] C.H. Kim, S.K. Yun, D.W. Byun, M.H. Yoo, K.U. Lee, K.I. Suh, Codon 54 polymorphism of the fatty acid binding protein 2 gene is associated with increased fat oxidation and hyperinsulinemia, but not with intestinal fatty acid absorption in Korean men, *Metabolism* 50 (2001) 473-476.
- [51] Y. Takakura, K. Yoshioka, T. Umekawa, A. Kogure, H. Toda, T. Yoshikawa, T. Yoshida, Thr54 allele of the FABP2 gene affects resting metabolic rate and visceral obesity, *Diabetes Res Clin Pract* 67 (2005) 36-42.
- [52] K.S. Vimalaswaran, V. Radha, V. Mohan, Thr54 allele carriers of the Ala54Thr variant of FABP2 gene have associations with metabolic syndrome and hypertriglyceridemia in urban South Indians, *Metabolism* 55 (2006) 1222-1226.
- [53] B.C. Albala, R.B. Jimenez, B.F. Perez, G.C. Liberman, [Fatty acid binding protein 2 (FABP-2) polymorphism, obesity and insulin resistance], *Rev Med Chil* 134 (2006) 372-379.
- [54] C. Albala, A. Villarroel, J.L. Santos, B. Angel, L. Lera, C. Liberman, H. Sanchez, F. Perez-Bravo, FABP2 Ala54Thr polymorphism and diabetes in Chilean elders, *Diabetes Res Clin Pract* 77 (2007) 245-250.
- [55] K.C. Chiu, L.M. Chuang, A. Chu, C. Yoon, Fatty acid binding protein 2 and insulin resistance, *Eur J Clin Invest* 31 (2001) 521-527.
- [56] L.H. Canani, C. Capp, D.P. Ng, S.G. Choo, A.L. Maia, G.B. Nabinger, K. Santos, D. Crispim, I. Roisemberg, A.S. Krolewski, J.L. Gross, The fatty acid-binding protein-2 A54T polymorphism is associated with renal disease in patients with type 2 diabetes, *Diabetes* 54 (2005) 3326-3330.
- [57] D.A. de Luis, M.G. Sagrado, R. Aller, O. Izaola, R. Conde, Influence of ALA54THR polymorphism of fatty acid-binding protein 2 on obesity and cardiovascular risk factors, *Horm Metab Res* 39 (2007) 830-834.
- [58] L.C. Gomez, S.M. Real, M.S. Ojeda, S. Gimenez, L.S. Mayorga, M. Roque, Polymorphism of the FABP2 gene: a population frequency analysis and an association study with cardiovascular risk markers in Argentina, *BMC Med Genet* 8 (2007) 39.
- [59] E. Martinez-Lopez, B. Ruiz-Madrigal, I. Hernandez-Canaveral, A. Panduro, Association of the T54 allele of the FABP2 gene with cardiovascular risk factors in obese Mexican subjects, *Diab Vasc Dis Res* 4 (2007) 235-236.
- [60] M. Miller, J. Rhyne, H. Chen, V. Beach, R. Ericson, K. Luthra, M. Dwivedi, A. Misra, APOC3 promoter polymorphisms C-482T and T-455C are associated with the metabolic syndrome, *Arch Med Res* 38 (2007) 444-451.
- [61] F. Perez-Bravo, M. Fuentes, B. Angel, H. Sanchez, E. Carrasco, J.L. Santos, L. Lera, C. Albala, Lack of association between the fatty acid binding protein 2 (FABP2) polymorphism with obesity and insulin resistance in two aboriginal populations from Chile, *Acta Diabetol* 43 (2006) 93-98.
- [62] S. Stan, M. Lambert, E. Delvin, G. Paradis, J. O'Loughlin, J.A. Hanley, E. Levy, Intestinal fatty acid binding protein and microsomal triglyceride transfer protein polymorphisms in French-Canadian youth, *J Lipid Res* 46 (2005) 320-327.
- [63] A.T. Erkkila, V. Lindi, S. Lehto, K. Pyorala, M. Laakso, M.I. Uusitupa, Variation in the fatty acid binding protein 2 gene is not associated with markers of metabolic syndrome in patients with coronary heart disease, *Nutr Metab Cardiovasc Dis* 12 (2002) 53-59.
- [64] E. Tahvanainen, M. Molin, S. Vainio, L. Tiret, V. Nicaud, E. Farinero, L. Masana, C. Ehnholm, Intestinal fatty acid binding protein polymorphism at codon 54 is not associated with postprandial responses to fat and glucose tolerance tests in healthy young Europeans. Results from EARS II participants, *Atherosclerosis* 152 (2000) 317-325.

References

- [65] H.H. Lei, J. Coresh, A.R. Shuldiner, E. Boerwinkle, F.L. Brancati, Variants of the insulin receptor substrate-1 and fatty acid binding protein 2 genes and the risk of type 2 diabetes, obesity, and hyperinsulinemia in African-Americans: the Atherosclerosis Risk in Communities Study, *Diabetes* 48 (1999) 1868-1872.
- [66] N.L. Duarte, S. Colagiuri, T. Palu, X.L. Wang, D.E. Wilcken, Obesity, Type II diabetes and the Ala54Thr polymorphism of fatty acid binding protein 2 in the Tongan population, *Mol Genet Metab* 79 (2003) 183-188.
- [67] C. Lara-Castro, G.R. Hunter, J.C. Lovejoy, B.A. Gower, J.R. Fernandez, Association of the intestinal fatty acid-binding protein Ala54Thr polymorphism and abdominal adipose tissue in African-American and Caucasian women, *J Clin Endocrinol Metab* 90 (2005) 1196-1201.
- [68] M.L. Salguero, R.E. Leon, A. Santos, S. Roman, J.E. Segura-Ortega, A. Panduro, The role of FABP2 gene polymorphism in alcoholic cirrhosis, *Hepatol Res* 33 (2005) 306-312.
- [69] D.A. de Luis, R. Aller, O. Izaola, M.G. Sagrado, R. Conde, Influence of ALA54THR polymorphism of fatty acid binding protein 2 on lifestyle modification response in obese subjects, *Ann Nutr Metab* 50 (2006) 354-360.
- [70] I. Szczerbal, A. Chmurzynska, M. Switonski, Cytogenetic mapping of eight genes encoding fatty acid binding proteins (FABPs) in the pig genome, *Cytogenet Genome Res* 118 (2007) 63-66.
- [71] E.P. Weiss, M.D. Brown, A.R. Shuldiner, J.M. Hagberg, Fatty acid binding protein-2 gene variants and insulin resistance: gene and gene-environment interaction effects, *Physiol Genomics* 10 (2002) 145-157.
- [72] P.D. Dworatzek, R.A. Hegele, T.M. Wolever, Postprandial lipemia in subjects with the threonine 54 variant of the fatty acid-binding protein 2 gene is dependent on the type of fat ingested, *Am J Clin Nutr* 79 (2004) 1110-1117.
- [73] S. Morcillo, G. Rojo-Martinez, F. Cardona, L. Almaraz Mde, L. de Adana Mde, I. Esteva, I. Cardona, F. Soriguer, Effect of the interaction between the fatty acid binding protein 2 gene Ala54Thr polymorphism and dietary fatty acids on peripheral insulin sensitivity: a cross-sectional study, *Am J Clin Nutr* 86 (2007) 1232-1237.
- [74] C. Marin, F. Perez-Jimenez, P. Gomez, J. Delgado, J.A. Paniagua, A. Lozano, B. Cortes, Y. Jimenez-Gomez, M.J. Gomez, J. Lopez-Miranda, The Ala54Thr polymorphism of the fatty acid-binding protein 2 gene is associated with a change in insulin sensitivity after a change in the type of dietary fat, *Am J Clin Nutr* 82 (2005) 196-200.
- [75] E.P. Weiss, J. Brandauer, O. Kulaputana, I.A. Ghiu, C.R. Wohn, D.A. Phares, A.R. Shuldiner, J.M. Hagberg, FABP2 Ala54Thr genotype is associated with glucoregulatory function and lipid oxidation after a high-fat meal in sedentary nondiabetic men and women, *Am J Clin Nutr* 85 (2007) 102-108.
- [76] T. Okada, N. Sato-Furuhashi, F. Iwata, H. Mugishima, The interaction between intestinal fatty acid-binding protein 2 polymorphism and delta-6 desaturase activity in obese children, *Am J Clin Nutr* 87 (2008) 1066-1067; author reply 1067.
- [77] S. Mariotto, Y. Suzuki, T. Persichini, M. Colasanti, H. Suzuki, O. Cantoni, Cross-talk between NO and arachidonic acid in inflammation, *Curr Med Chem* 14 (2007) 1940-1944.
- [78] N.K. Verma, J. Singh, C.S. Dey, PPAR-gamma expression modulates insulin sensitivity in C2C12 skeletal muscle cells, *Br J Pharmacol* 143 (2004) 1006-1013.
- [79] C. Nugent, J.B. Prins, J.P. Whitehead, J.M. Wentworth, V.K. Chatterjee, S. O'Rahilly, Arachidonic acid stimulates glucose uptake in 3T3-L1 adipocytes by increasing GLUT1 and GLUT4 levels at the plasma membrane. Evidence for involvement of

References

- lipoxygenase metabolites and peroxisome proliferator-activated receptor gamma, *J Biol Chem* 276 (2001) 9149-9157.
- [80] K. Geschonke, M. Klempt, N. Lynch, S. Schreiber, S. Fenselau, J. Schrezenmeir, Detection of a promoter polymorphism in the gene of intestinal fatty acid binding protein (I-FABP), *Ann N Y Acad Sci* 967 (2002) 548-553.
- [81] C.M. Damcott, E. Feingold, S.P. Moffett, M.M. Barmada, J.A. Marshall, R.F. Hamman, R.E. Ferrell, Variation in the FABP2 promoter alters transcriptional activity and is associated with body composition and plasma lipid levels, *Hum Genet* 112 (2003) 610-616.
- [82] M.L. Formanack, L.J. Baier, Variation in the FABP2 promoter affects gene expression: implications for prior association studies, *Diabetologia* 47 (2004) 349-351.
- [83] Y. Li, E. Fisher, M. Klapper, H. Boeing, A. Pfeiffer, J. Hampe, S. Schreiber, B. Burwinkel, J. Schrezenmeir, F. Doring, Association between functional FABP2 promoter haplotype and type 2 diabetes, *Horm Metab Res* 38 (2006) 300-307.
- [84] M. Klapper, M. Bohme, I. Nitz, F. Doring, Type 2 diabetes-associated fatty acid binding protein 2 promoter haplotypes are differentially regulated by GATA factors, *Hum Mutat* 29 (2008) 142-149.
- [85] U. Helwig, D. Rubin, M. Klapper, Y. Li, M. Nothnagel, U.R. Folsch, F. Doring, S. Schreiber, J. Schrezenmeir, The association of fatty acid-binding protein 2 A54T polymorphism with postprandial lipemia depends on promoter variability, *Metabolism* 56 (2007) 723-731.
- [86] P. Rava, M.M. Hussain, Acquisition of triacylglycerol transfer activity by microsomal triglyceride transfer protein during evolution, *Biochemistry* 46 (2007) 12263-12274.
- [87] M.M. Hussain, J. Iqbal, K. Anwar, P. Rava, K. Dai, Microsomal triglyceride transfer protein: a multifunctional protein, *Front Biosci* 8 (2003) s500-506.
- [88] S.K. Dougan, P. Rava, M.M. Hussain, R.S. Blumberg, MTP regulated by an alternate promoter is essential for NKT cell development, *J Exp Med* 204 (2007) 533-545.
- [89] P.J. Mohler, M.Y. Zhu, A.M. Blade, A.J. Ham, G.S. Shelness, L.L. Swift, Identification of a novel isoform of microsomal triglyceride transfer protein, *J Biol Chem* 282 (2007) 26981-26988.
- [90] M.M. Hussain, P. Rava, X. Pan, K. Dai, S.K. Dougan, J. Iqbal, F. Lazare, I. Khatun, Microsomal triglyceride transfer protein in plasma and cellular lipid metabolism, *Curr Opin Lipidol* 19 (2008) 277-284.
- [91] P. Bradbury, C.J. Mann, S. Kochl, T.A. Anderson, S.A. Chester, J.M. Hancock, P.J. Ritchie, J. Amey, G.B. Harrison, D.G. Levitt, L.J. Banaszak, J. Scott, C.C. Shoulders, A common binding site on the microsomal triglyceride transfer protein for apolipoprotein B and protein disulfide isomerase, *J Biol Chem* 274 (1999) 3159-3164.
- [92] A. Atzel, J.R. Wetterau, Mechanism of microsomal triglyceride transfer protein catalyzed lipid transport, *Biochemistry* 32 (1993) 10444-10450.
- [93] M. Raabe, M.M. Veniant, M.A. Sullivan, C.H. Zlot, J. Bjorkegren, L.B. Nielsen, J.S. Wong, R.L. Hamilton, S.G. Young, Analysis of the role of microsomal triglyceride transfer protein in the liver of tissue-specific knockout mice, *J Clin Invest* 103 (1999) 1287-1298.
- [94] Y. Wang, K. Tran, Z. Yao, The activity of microsomal triglyceride transfer protein is essential for accumulation of triglyceride within microsomes in McA-RH7777 cells. A unified model for the assembly of very low density lipoproteins, *J Biol Chem* 274 (1999) 27793-27800.
- [95] Y. Sagiv, L. Bai, D.G. Wei, R. Agami, P.B. Savage, L. Teyton, A. Bendelac, A distal effect of microsomal triglyceride transfer protein deficiency on the lysosomal recycling of CD1d, *J Exp Med* 204 (2007) 921-928.

References

- [96] H. Ledmyr, F. Karpe, B. Lundahl, M. McKinnon, C. Skoglund-Andersson, E. Ehrenborg, Variants of the microsomal triglyceride transfer protein gene are associated with plasma cholesterol levels and body mass index, *J Lipid Res* 43 (2002) 51-58.
- [97] H. Ledmyr, L. Ottosson, M. Sunnerhagen, E. Ehrenborg, The Ile128Thr polymorphism influences stability and ligand binding properties of the microsomal triglyceride transfer protein, *J Lipid Res* 47 (2006) 1378-1385.
- [98] D. Rubin, A. Schneider-Muntau, M. Klapper, I. Nitz, U. Helwig, U.R. Folsch, J. Schrezenmeir, F. Doring, Functional analysis of promoter variants in the microsomal triglyceride transfer protein (MTTP) gene, *Hum Mutat* 29 (2008) 123-129.
- [99] M.T. Berthier, A. Houde, A.M. Paradis, P. Couture, D. Gaudet, J.P. Despres, M.C. Vohl, Molecular screening of the microsomal triglyceride transfer protein: association between polymorphisms and both abdominal obesity and plasma apolipoprotein B concentration, *J Hum Genet* 49 (2004) 684-690.
- [100] F. Karpe, B. Lundahl, E. Ehrenborg, P. Eriksson, A. Hamsten, A common functional polymorphism in the promoter region of the microsomal triglyceride transfer protein gene influences plasma LDL levels, *Arterioscler Thromb Vasc Biol* 18 (1998) 756-761.
- [101] L. Bjorn, T.P. Leren, L. Ose, A. Hamsten, F. Karpe, A functional polymorphism in the promoter region of the microsomal triglyceride transfer protein (MTP -493G/T) influences lipoprotein phenotype in familial hypercholesterolemia, *Arterioscler Thromb Vasc Biol* 20 (2000) 1784-1788.
- [102] B. Lundahl, C. Skoglund-Andersson, M. Caslake, D. Bedford, P. Stewart, A. Hamsten, C.J. Packard, F. Karpe, Microsomal triglyceride transfer protein -493T variant reduces IDL plus LDL apoB production and the plasma concentration of large LDL particles, *Am J Physiol Endocrinol Metab* 290 (2006) E739-745.
- [103] J. St-Pierre, I. Lemieux, I. Miller-Felix, D. Prud'homme, J. Bergeron, D. Gaudet, A. Nadeau, J.P. Despres, M.C. Vohl, Visceral obesity and hyperinsulinemia modulate the impact of the microsomal triglyceride transfer protein -493G/T polymorphism on plasma lipoprotein levels in men, *Atherosclerosis* 160 (2002) 317-324.
- [104] L. Chen, G. Yoshino, E. Maeda, S. Zeng, Effect of microsomal triglyceride transfer protein gene polymorphism in the promoter region on dyslipidemia in type 2 diabetic subjects, *Chin Med J (Engl)* 116 (2003) 215-217.
- [105] C. Phillips, K. Mullan, D. Owens, G.H. Tomkin, Microsomal triglyceride transfer protein polymorphisms and lipoprotein levels in type 2 diabetes, *Qjm* 97 (2004) 211-218.
- [106] A.C. Sposito, S. Gonbert, G. Turpin, M.J. Chapman, J. Thillet, Common polymorphism in the MTP promoter attenuates the dyslipidemic and proatherogenic effects of excess body weight, *Arterioscler Thromb Vasc Biol* 24 (2004) e143.
- [107] D. Rubin, U. Helwig, M. Pfeuffer, S. Schreiber, H. Boeing, E. Fisher, A. Pfeiffer, S. Freitag-Wolf, U.R. Foelsch, F. Doering, J. Schrezenmeir, A common functional exon polymorphism in the microsomal triglyceride transfer protein gene is associated with type 2 diabetes, impaired glucose metabolism and insulin levels, *J Hum Genet* 51 (2006) 567-574.
- [108] S.H. Juo, Z. Han, J.D. Smith, L. Colangelo, K. Liu, Common polymorphism in promoter of microsomal triglyceride transfer protein gene influences cholesterol, ApoB, and triglyceride levels in young african american men: results from the coronary artery risk development in young adults (CARDIA) study, *Arterioscler Thromb Vasc Biol* 20 (2000) 1316-1322.
- [109] S. Bernard, S. Touzet, I. Personne, V. Lapras, P.J. Bondon, F. Berthezene, P. Moulin, Association between microsomal triglyceride transfer protein gene polymorphism and

- the biological features of liver steatosis in patients with type II diabetes, *Diabetologia* 43 (2000) 995-999.
- [110] B. Lundahl, A. Hamsten, F. Karpe, Postprandial plasma ApoB-48 levels are influenced by a polymorphism in the promoter of the microsomal triglyceride transfer protein gene, *Arterioscler Thromb Vasc Biol* 22 (2002) 289-293.
- [111] C. Namikawa, Z. Shu-Ping, J.R. Vyselaar, Y. Nozaki, Y. Nemoto, M. Ono, N. Akisawa, T. Saibara, M. Hiroi, H. Enzan, S. Onishi, Polymorphisms of microsomal triglyceride transfer protein gene and manganese superoxide dismutase gene in non-alcoholic steatohepatitis, *J Hepatol* 40 (2004) 781-786.
- [112] R. Gambino, M. Cassader, G. Pagano, M. Durazzo, G. Musso, Polymorphism in microsomal triglyceride transfer protein: a link between liver disease and atherogenic postprandial lipid profile in NASH? *Hepatology* 45 (2007) 1097-1107.
- [113] H. Ledmyr, A.D. McMahon, E. Ehrenborg, L.B. Nielsen, M. Neville, H. Lithell, P.W. MacFarlane, C.J. Packard, F. Karpe, The microsomal triglyceride transfer protein gene-493T variant lowers cholesterol but increases the risk of coronary heart disease, *Circulation* 109 (2004) 2279-2284.
- [114] W. Schgoer, P. Eller, T. Mueller, I. Tancevski, A. Wehinger, H. Ulmer, A. Sandhofer, A. Ritsch, M. Haltmayer, J.R. Patsch, The MTP -493TT genotype is associated with peripheral arterial disease: results from the Linz Peripheral Arterial Disease (LIPAD) Study, *Clin Biochem* 41 (2008) 712-716.
- [115] Y. Yamada, F. Ando, H. Shimokata, Association of polymorphisms in CYP17A1, MTP, and VLDLR with bone mineral density in community-dwelling Japanese women and men, *Genomics* 86 (2005) 76-85.
- [116] R.S. Li, R.X. Yin, W.X. Lin, D.Z. Yang, [Relationship between the polymorphism of microsomal triglyceride transfer protein gene and the level of serum lipids in Guangxi Heiyi Zhuang population], *Zhonghua Yi Xue Za Zhi* 85 (2005) 2492-2496.
- [117] R. Gambino, S. Bo, G. Musso, B. Uberti, N. Alemanno, F. Ghione, S. Guidi, E. Tiozzo, V. Chiusano, L. Gentile, M. Durazzo, G. Pagano, M. Cassader, Microsomal triglyceride transfer protein 493-T variant is associated with resistin levels and C-reactive protein, *Clin Biochem* 40 (2007) 1219-1224.
- [118] R. Zampino, D. Ingrosso, E. Durante-Mangoni, R. Capasso, M.F. Tripodi, L. Restivo, V. Zappia, G. Ruggiero, L.E. Adinolfi, Microsomal triglyceride transfer protein (MTP) -493G/T gene polymorphism contributes to fat liver accumulation in HCV genotype 3 infected patients, *J Viral Hepat* (2008).
- [119] S.M. Herrmann, O. Poirier, V. Nicaud, A. Evans, J.B. Ruidavets, G. Luc, D. Arveiler, C. Bao-Sheng, F. Cambien, Identification of two polymorphisms in the promoter of the microsomal triglyceride transfer protein (MTP) gene: lack of association with lipoprotein profiles, *J Lipid Res* 39 (1998) 2432-2435.
- [120] P. Couture, J.D. Otvos, L.A. Cupples, P.W. Wilson, E.J. Schaefer, J.M. Ordovas, Absence of association between genetic variation in the promoter of the microsomal triglyceride transfer protein gene and plasma lipoproteins in the Framingham Offspring Study, *Atherosclerosis* 148 (2000) 337-343.
- [121] J.M. Petit, D. Masson, A. Minello, L. Duvillard, F. Galland, B. Verges, P. Gambert, P. Hillon, Lack of association between microsomal triglyceride transfer protein gene polymorphism and liver steatosis in HCV-infected patients, *Mol Genet Metab* 88 (2006) 196-198.
- [122] B.J. Geesaman, E. Benson, S.J. Brewster, L.M. Kunkel, H. Blanche, G. Thomas, T.T. Perls, M.J. Daly, A.A. Puca, Haplotype-based identification of a microsomal transfer protein marker associated with the human lifespan, *Proc Natl Acad Sci U S A* 100 (2003) 14115-14120.

References

- [123] P.J. Talmud, J. Palmen, G. Miller, S.E. Humphries, Effect of microsomal triglyceride transfer protein gene variants (-493G > T, Q95H and H297Q) on plasma lipid levels in healthy middle-aged UK men, *Ann Hum Genet* 64 (2000) 269-276.
- [124] M. Beekman, G.J. Blauw, J.J. Houwing-Duistermaat, B.W. Brandt, R.G. Westendorp, P.E. Slagboom, Chromosome 4q25, microsomal transfer protein gene, and human longevity: novel data and a meta-analysis of association studies, *J Gerontol A Biol Sci Med Sci* 61 (2006) 355-362.
- [125] M.T. Berthier, P. Couture, A. Houde, A.M. Paradis, A. Sammak, A. Verner, J.P. Depres, C. Gagne, D. Gaudet, M.C. Vohl, The c.419-420insA in the MTP gene is associated with abetalipoproteinemia among French-Canadians, *Mol Genet Metab* 81 (2004) 140-143.
- [126] T.M. Narcisi, C.C. Shoulders, S.A. Chester, J. Read, D.J. Brett, G.B. Harrison, T.T. Grantham, M.F. Fox, S. Povey, T.W. de Bruin, et al., Mutations of the microsomal triglyceride-transfer-protein gene in abetalipoproteinemia, *Am J Hum Genet* 57 (1995) 1298-1310.
- [127] J.Y. Park, M.H. Pillinger, S.B. Abramson, Prostaglandin E2 synthesis and secretion: the role of PGE2 synthases, *Clin Immunol* 119 (2006) 229-240.
- [128] J.N. Fain, C.W. Leffler, S.W. Bahouth, A.M. Rice, S.A. Rivkees, Regulation of leptin release and lipolysis by PGE2 in rat adipose tissue, *Prostaglandins Other Lipid Mediat* 62 (2000) 343-350.
- [129] M. Murakami, I. Kudo, Prostaglandin E synthase: a novel drug target for inflammation and cancer, *Curr Pharm Des* 12 (2006) 943-954.
- [130] T. Yamada, J. Komoto, K. Watanabe, Y. Ohmiya, F. Takusagawa, Crystal structure and possible catalytic mechanism of microsomal prostaglandin E synthase type 2 (mPGES-2), *J Mol Biol* 348 (2005) 1163-1176.
- [131] M. Murakami, K. Nakashima, D. Kamei, S. Masuda, Y. Ishikawa, T. Ishii, Y. Ohmiya, K. Watanabe, I. Kudo, Cellular prostaglandin E2 production by membrane-bound prostaglandin E synthase-2 via both cyclooxygenases-1 and -2, *J Biol Chem* 278 (2003) 37937-37947.
- [132] G. Yang, L. Chen, Y. Zhang, X. Zhang, J. Wu, S. Li, M. Wei, Z. Zhang, M.D. Breyer, Y. Guan, Expression of mouse membrane-associated prostaglandin E2 synthase-2 (mPGES-2) along the urogenital tract, *Biochim Biophys Acta* 1761 (2006) 1459-1468.
- [133] F. Bosetti, R. Langenbach, G.R. Weerasinghe, Prostaglandin E2 and microsomal prostaglandin E synthase-2 expression are decreased in the cyclooxygenase-2-deficient mouse brain despite compensatory induction of cyclooxygenase-1 and Ca²⁺-dependent phospholipase A2, *J Neurochem* 91 (2004) 1389-1397.
- [134] D. Claveau, M. Sirinyan, J. Guay, R. Gordon, C.C. Chan, Y. Bureau, D. Riendeau, J.A. Mancini, Microsomal prostaglandin E synthase-1 is a major terminal synthase that is selectively up-regulated during cyclooxygenase-2-dependent prostaglandin E2 production in the rat adjuvant-induced arthritis model, *J Immunol* 170 (2003) 4738-4744.
- [135] J. Hu, Q. Meng, S.K. Roy, A. Raha, J. Hu, J. Zhang, K. Hashimoto, D.V. Kalvakolanu, A novel transactivating factor that regulates interferon-gamma-dependent gene expression, *J Biol Chem* 277 (2002) 30253-30263.
- [136] A.F. Wilson, R.C. Elston, L.D. Tran, R.M. Siervogel, Use of the robust sib-pair method to screen for single-locus, multiple-locus, and pleiotropic effects: application to traits related to hypertension, *Am J Hum Genet* 48 (1991) 862-872.
- [137] I. Lindner, U. Helwig, D. Rubin, A. Fischer, B. Marten, S. Schreiber, F. Doring, J. Schrezenmeir, Prostaglandin E synthase 2 (PTGES2) Arg298His polymorphism and parameters of the metabolic syndrome, *Mol Nutr Food Res* 51 (2007) 1447-1451.

References

- [138] I. Nitz, E. Fisher, H. Grallert, Y. Li, C. Gieger, D. Rubin, H. Boeing, J. Spranger, I. Lindner, S. Schreiber, W. Rathmann, H. Gohlke, A. Doring, H.E. Wichmann, J. Schrezenmeir, F. Doring, T. Illig, Association of prostaglandin E synthase 2 (PTGES2) Arg298His polymorphism with type 2 diabetes in two German study populations, *J Clin Endocrinol Metab* 92 (2007) 3183-3188.
- [139] E. Fisher, I. Nitz, I. Lindner, D. Rubin, H. Boeing, M. Mohlig, J. Hampe, S. Schreiber, J. Schrezenmeir, F. Doring, Candidate gene association study of type 2 diabetes in a nested case-control study of the EPIC-Potsdam cohort - role of fat assimilation, *Mol Nutr Food Res* 51 (2007) 185-191.
- [140] J.L. Hawkins, M.D. Robbins, L.C. Warren, D. Xia, S.F. Petras, J.J. Valentine, A.H. Varghese, I.K. Wang, T.A. Subashi, L.D. Shelly, B.A. Hay, K.T. Landschulz, K.F. Geoghegan, H.J. Harwood, Jr., Pharmacologic inhibition of site 1 protease activity inhibits sterol regulatory element-binding protein processing and reduces lipogenic enzyme gene expression and lipid synthesis in cultured cells and experimental animals, *J Pharmacol Exp Ther* 326 (2008) 801-808.
- [141] J.C. Barrett, B. Fry, J. Maller, M.J. Daly, Haploview: analysis and visualization of LD and haplotype maps, *Bioinformatics* 21 (2005) 263-265.
- [142] The International HapMap Project, *Nature* 426 (2003) 789-796.
- [143] J. Lasky-Su, H.N. Lyon, V. Emilsson, I.M. Heid, C. Molony, B.A. Raby, R. Lazarus, B. Klanderman, M.E. Soto-Quiros, L. Avila, E.K. Silverman, G. Thorleifsson, U. Thorsteinsdottir, F. Kronenberg, C. Vollmert, T. Illig, C.S. Fox, D. Levy, N. Laird, X. Ding, et al., On the replication of genetic associations: timing can be everything! *Am J Hum Genet* 82 (2008) 849-858.
- [144] J.J. McCarthy, Gene by sex interaction in the etiology of coronary heart disease and the preceding metabolic syndrome, *Nutr Metab Cardiovasc Dis* 17 (2007) 153-161.
- [145] P. Ciana, A. Biserni, L. Tatangelo, C. Tiveron, A.F. Sciarroni, L. Ottobri, A. Maggi, A novel peroxisome proliferator-activated receptor responsive element-luciferase reporter mouse reveals gender specificity of peroxisome proliferator-activated receptor activity in liver, *Mol Endocrinol* 21 (2007) 388-400.
- [146] M. Jalouli, L. Carlsson, C. Ameen, D. Linden, A. Ljungberg, L. Michalik, S. Eden, W. Wahli, J. Oscarsson, Sex difference in hepatic peroxisome proliferator-activated receptor alpha expression: influence of pituitary and gonadal hormones, *Endocrinology* 144 (2003) 101-109.
- [147] P.L. Brubaker, Y. Anini, Direct and indirect mechanisms regulating secretion of glucagon-like peptide-1 and glucagon-like peptide-2, *Can J Physiol Pharmacol* 81 (2003) 1005-1012.
- [148] A.A. Vaag, J.J. Holst, A. Volund, H.B. Beck-Nielsen, Gut incretin hormones in identical twins discordant for non-insulin-dependent diabetes mellitus (NIDDM)--evidence for decreased glucagon-like peptide 1 secretion during oral glucose ingestion in NIDDM twins, *Eur J Endocrinol* 135 (1996) 425-432.
- [149] C. Couillard, N. Bergeron, D. Prud'homme, J. Bergeron, A. Tremblay, C. Bouchard, P. Mauriege, J.P. Despres, Gender difference in postprandial lipemia: importance of visceral adipose tissue accumulation, *Arterioscler Thromb Vasc Biol* 19 (1999) 2448-2455.
- [150] F.E. von Eyben, E. Mouritsen, J. Holm, P. Montvilas, G. Dimcevski, G. Suci, I. Helleberg, L. Kristensen, R. von Eyben, Intra-abdominal obesity and metabolic risk factors: a study of young adults, *Int J Obes Relat Metab Disord* 27 (2003) 941-949.
- [151] O. Hamdy, S. Porramatikul, E. Al-Ozairi, Metabolic obesity: the paradox between visceral and subcutaneous fat, *Curr Diabetes Rev* 2 (2006) 367-373.
- [152] C. Posadas-Romero, A. Hernandez-Ono, J. Zamora-Gonzalez, G. Cardoso-Saldana, L. Yamamoto-Kimura, O.R. Brito-Zurita, Differential effects of obesity with and without

References

- hyperinsulinemia on plasma lipoprotein(a) concentrations in men, *Metabolism* 50 (2001) 178-183.
- [153] G.A. Maston, S.K. Evans, M.R. Green, Transcriptional regulatory elements in the human genome, *Annu Rev Genomics Hum Genet* 7 (2006) 29-59.
- [154] M.H. De Moor, T.D. Spector, L.F. Cherkas, M. Falchi, J.J. Hottenga, D.I. Boomsma, E.J. De Geus, Genome-wide linkage scan for athlete status in 700 British female DZ twin pairs, *Twin Res Hum Genet* 10 (2007) 812-820.
- [155] T.M. Frayling, Genome-wide association studies provide new insights into type 2 diabetes aetiology, *Nat Rev Genet* 8 (2007) 657-662.
- [156] S. Ichihara, Y. Yamada, Genetic factors for human obesity, *Cell Mol Life Sci* (2007).
- [157] C.M. Lindgren, M.I. McCarthy, Mechanisms of Disease: genetic insights into the etiology of type 2 diabetes and obesity, *Nat Clin Pract Endocrinol Metab* (2008).
- [158] N.H. Haunerland, F. Spener, Fatty acid-binding proteins--insights from genetic manipulations, *Prog Lipid Res* 43 (2004) 328-349.
- [159] J.N. Feige, L. Gelman, L. Michalik, B. Desvergne, W. Wahli, From molecular action to physiological outputs: peroxisome proliferator-activated receptors are nuclear receptors at the crossroads of key cellular functions, *Prog Lipid Res* 45 (2006) 120-159.
- [160] N.N. Luchina, I.V. Krivega, E.V. Pankratova, Human Oct-1L isoform has tissue-specific expression pattern similar to Oct-2, *Immunol Lett* 85 (2003) 237-241.
- [161] M. Doucleff, G.M. Clore, Global jumping and domain-specific intersegment transfer between DNA cognate sites of the multidomain transcription factor Oct-1, *Proc Natl Acad Sci U S A* (2008).
- [162] T. Kakizawa, T. Miyamoto, K. Ichikawa, A. Kaneko, S. Suzuki, M. Hara, T. Nagasawa, T. Takeda, J. Mori, M. Kumagai, K. Hashizume, Functional interaction between Oct-1 and retinoid X receptor, *J Biol Chem* 274 (1999) 19103-19108.
- [163] D. Bruemmer, F. Yin, J. Liu, J.P. Berger, T. Sakai, F. Blaschke, E. Fleck, A.J. Van Herle, B.M. Forman, R.E. Law, Regulation of the growth arrest and DNA damage-inducible gene 45 (GADD45) by peroxisome proliferator-activated receptor gamma in vascular smooth muscle cells, *Circ Res* 93 (2003) e38-47.
- [164] B. Voleti, A. Agrawal, Regulation of basal and induced expression of C-reactive protein through an overlapping element for OCT-1 and NF-kappaB on the proximal promoter, *J Immunol* 175 (2005) 3386-3390.
- [165] M.A. Thomas, V.A. Mordvinov, C.J. Sanderson, The activity of the human interleukin-5 conserved lymphokine element 0 is regulated by octamer factors in human cells, *Eur J Biochem* 265 (1999) 300-307.
- [166] X. Jiang, M. Norman, X. Li, Use of an array technology for profiling and comparing transcription factors activated by TNFalpha and PMA in HeLa cells, *Biochim Biophys Acta* 1642 (2003) 1-8.
- [167] L.R. Silveira, J. Fiamoncini, S.M. Hirabara, J. Procopio, T.D. Cambiaghi, C.H. Pinheiro, L.R. Lopes, R. Curi, Updating the effects of fatty acids on skeletal muscle, *J Cell Physiol* 217 (2008) 1-12.
- [168] T. Kakizawa, T. Miyamoto, K. Ichikawa, T. Takeda, S. Suzuki, J. Mori, M. Kumagai, K. Yamashita, K. Hashizume, Silencing mediator for retinoid and thyroid hormone receptors interacts with octamer transcription factor-1 and acts as a transcriptional repressor, *J Biol Chem* 276 (2001) 9720-9725.
- [169] E.N. Hatada, S. Chen-Kiang, C. Scheidereit, Interaction and functional interference of C/EBPbeta with octamer factors in immunoglobulin gene transcription, *Eur J Immunol* 30 (2000) 174-184.

References

- [170] C.S. Song, M.H. Jung, S.C. Kim, T. Hassan, A.K. Roy, B. Chatterjee, Tissue-specific and androgen-repressible regulation of the rat dehydroepiandrosterone sulfotransferase gene promoter, *J Biol Chem* 273 (1998) 21856-21866.
- [171] L. Lerner, M.A. Henriksen, X. Zhang, J.E. Darnell, Jr., STAT3-dependent enhanceosome assembly and disassembly: synergy with GR for full transcriptional increase of the alpha 2-macroglobulin gene, *Genes Dev* 17 (2003) 2564-2577.
- [172] X. Ke, M.S. Taylor, L.R. Cardon, Singleton SNPs in the human genome and implications for genome-wide association studies, *Eur J Hum Genet* 16 (2008) 506-515.
- [173] E. Ikonen, Mechanisms for cellular cholesterol transport: defects and human disease, *Physiol Rev* 86 (2006) 1237-1261.
- [174] A.B. Garcia-Garcia, C. Gonzalez, J.T. Real, J.J. Martin de Llano, V. Gonzalez-Albert, M. Civera, F.J. Chaves, J.F. Ascaso, R. Carmena, Influence of microsomal triglyceride transfer protein promoter polymorphism -493 GT on fasting plasma triglyceride values and interaction with treatment response to atorvastatin in subjects with heterozygous familial hypercholesterolaemia, *Pharmacogenet Genomics* 15 (2005) 211-218.
- [175] Y. Yamada, F. Ando, H. Shimokata, Association of a microsomal triglyceride transfer protein gene polymorphism with blood pressure in Japanese women, *Int J Mol Med* 17 (2006) 83-88.
- [176] C. Ameen, J. Oscarsson, Sex difference in hepatic microsomal triglyceride transfer protein expression is determined by the growth hormone secretory pattern in the rat, *Endocrinology* 144 (2003) 3914-3921.
- [177] J.R. Ruiz, F.B. Ortega, L.A. Moreno, J. Warnberg, M. Gonzalez-Gross, M.D. Cano, A. Gutierrez, M.J. Castillo, Reference values for serum lipids and lipoproteins in Spanish adolescents: the AVENA study, *Soz Präventivmed* 51 (2006) 99-109.
- [178] B. Richelsen, Factors regulating the production of prostaglandin E2 and prostacyclin (prostaglandin I2) in rat and human adipocytes, *Biochem J* 247 (1987) 389-394.
- [179] B. Richelsen, Prostaglandins in adipose tissue--with special reference to triglyceride metabolism, *Dan Med Bull* 38 (1991) 228-244.
- [180] B. Richelsen, S.B. Pedersen, T. Moller-Pedersen, J.F. Bak, Regional differences in triglyceride breakdown in human adipose tissue: effects of catecholamines, insulin, and prostaglandin E2, *Metabolism* 40 (1991) 990-996.
- [181] I. Lindner, Association and functional analyses of selected fatty acid metabolism gene polymorphisms regarding insulin resistance, Mathematisch Naturwissenschaftliche Fakultät, Christian-Albrechts-Universität, Kiel, 2008.
- [182] M. Mendez, M.C. LaPointe, PPARgamma inhibition of cyclooxygenase-2, PGE2 synthase, and inducible nitric oxide synthase in cardiac myocytes, *Hypertension* 42 (2003) 844-850.
- [183] J. Kaiser, Genomic databases. NIH goes after whole genome in search of disease genes, *Science* 311 (2006) 933.
- [184] R. Sladek, G. Rocheleau, J. Rung, C. Dina, L. Shen, D. Serre, P. Boutin, D. Vincent, A. Belisle, S. Hadjadj, B. Balkau, B. Heude, G. Charpentier, T.J. Hudson, A. Montpetit, A.V. Pshezhetsky, M. Prentki, B.I. Posner, D.J. Balding, D. Meyre, et al., A genome-wide association study identifies novel risk loci for type 2 diabetes, *Nature* 445 (2007) 881-885.
- [185] A. Hinney, T.T. Nguyen, A. Scherag, S. Friedel, G. Bronner, T.D. Muller, H. Grallert, T. Illig, H.E. Wichmann, W. Rief, H. Schafer, J. Hebebrand, Genome wide association (GWA) study for early onset extreme obesity supports the role of fat mass and obesity associated gene (FTO) variants, *PLoS ONE* 2 (2007) e1361.

References

- [186] E.J. Topol, J. Smith, E.F. Plow, Q.K. Wang, Genetic susceptibility to myocardial infarction and coronary artery disease, *Hum Mol Genet* 15 Spec No 2 (2006) R117-123.
- [187] P. Holvoet, Relations between metabolic syndrome, oxidative stress and inflammation and cardiovascular disease, *Verh K Acad Geneeskd Belg* 70 (2008) 193-219.
- [188] S. Ichihara, Y. Yamada, Genetic factors for human obesity, *Cell Mol Life Sci* 65 (2008) 1086-1098.
- [189] D.K. Sanghera, L. Ortega, S. Han, J. Singh, S.K. Ralhan, G.S. Wander, N.K. Mehra, J.J. Mulvihill, R.E. Ferrell, S.K. Nath, M.I. Kamboh, Impact of nine common type 2 diabetes risk polymorphisms in Asian Indian Sikhs: PPAR γ 2 (Pro12Ala), IGF2BP2, TCF7L2 and FTO variants confer a significant risk, *BMC Med Genet* 9 (2008) 59.
- [190] A.J. Lusis, A.D. Attie, K. Reue, Metabolic syndrome: from epidemiology to systems biology, *Nat Rev Genet* 9 (2008) 819-830.
- [191] D. Shriner, L.K. Vaughan, M.A. Padilla, H.K. Tiwari, Problems with genome-wide association studies, *Science* 316 (2007) 1840-1842.
- [192] G.M. Cooper, T. Zerr, J.M. Kidd, E.E. Eichler, D.A. Nickerson, Systematic assessment of copy number variant detection via genome-wide SNP genotyping, *Nat Genet* (2008).
- [193] A. Scuteri, S. Sanna, W.M. Chen, M. Uda, G. Albai, J. Strait, S. Najjar, R. Nagaraja, M. Orru, G. Usala, M. Dei, S. Lai, A. Maschio, F. Busonero, A. Mulas, G.B. Ehret, A.A. Fink, A.B. Weder, R.S. Cooper, P. Galan, et al., Genome-wide association scan shows genetic variants in the FTO gene are associated with obesity-related traits, *PLoS Genet* 3 (2007) e115.
- [194] G. Wolfram, New reference values for nutrient intake in Germany, Austria and Switzerland (DACH-Reference Values), *Forum Nutr* 56 (2003) 95-97.
- [195] J. Lopez-Miranda, P. Perez-Martinez, C. Marin, F. Fuentes, J. Delgado, F. Perez-Jimenez, Dietary fat, genes and insulin sensitivity, *J Mol Med* 85 (2007) 213-226.
- [196] J.M. Brown, G.S. Shelness, L.L. Rudel, Monounsaturated fatty acids and atherosclerosis: opposing views from epidemiology and experimental animal models, *Curr Atheroscler Rep* 9 (2007) 494-500.
- [197] A.P. Simopoulos, The omega-6/omega-3 fatty acid ratio, genetic variation, and cardiovascular disease, *Asia Pac J Clin Nutr* 17 Suppl 1 (2008) 131-134.
- [198] V. Rioux, P. Legrand, Saturated fatty acids: simple molecular structures with complex cellular functions, *Curr Opin Clin Nutr Metab Care* 10 (2007) 752-758.
- [199] J. Lopez-Miranda, C. Williams, D. Lairon, Dietary, physiological, genetic and pathological influences on postprandial lipid metabolism, *Br J Nutr* 98 (2007) 458-473.
- [200] D.L. Bryan, K.D. Forsyth, P.H. Hart, R.A. Gibson, Polyunsaturated fatty acids regulate cytokine and prostaglandin E₂ production by respiratory cells in response to mast cell mediators, *Lipids* 41 (2006) 1101-1107.

Research Article

Association between functional FABP2 promoter haplotypes and body mass index: Analyses of 8072 participants of the KORA cohort study

Mike Böhme¹, Harald Grallert², Maja Klapper¹, Christian Gieger², Alexandra Fischer¹, Iris Heid², H.-Erich Wichmann², Frank Döring¹ and Thomas Illig²

¹ Institute of Human Nutrition and Food Science, Molecular Nutrition, Christian-Albrecht-University, Kiel, Germany

² Institute of Epidemiology, German Research Centre for Environmental Health, Helmholtz Centre Munich, Munich, Germany

Studies in relatively small cohorts provide preliminary evidence that functional fatty acid binding protein 2 (FABP2) promoter haplotypes are associated with type 2 diabetes and BMI. Here, we studied the influence of the haplotypes on BMI by using 8072 male and female participants of the Kooperative Gesundheitsforschung in der Region Augsburg (KORA) cohort. By linear regression analysis, we found in males a reduction of -0.39 BMI units (95% CI: -0.73 , -0.05 , $p = 0.024$) in homozygous FABP2 promoter haplotype B carriers. Carriers of haplotype B showed a significant decrease in BMI of -0.19 BMI units (95% CI: -0.35 , -0.02 , $p = 0.027$). In accordance, a significant reduction in BMI of the minor haplotype carriers in the BMI point categories of 25–30 (BMI units: -0.10 , 95% CI: -0.18 , -0.01 , $p = 0.03$) and <30 (BMI units: -0.37 , 95% CI: -0.67 , -0.07 , $p = 0.02$) were found. In summary, the minor FABP2 promoter haplotype B contributes to a reduced BMI in men. This provides evidence that functional FABP2 contributes to multifactorially regulated body weight.

Keywords: BMI / FABP2 gene / KORA / Promoter polymorphism

Received: June 8, 2008; revised: July 24, 2008; accepted: July 27, 2008

1 Introduction

The human fatty acid binding protein 2 (FABP2) gene (*FABP2*, NM_000134.2) is exclusively expressed in the intestine during development and cell differentiation in absorptive cells of the upper villus region [1–3]. Although the specific function of FABP2 is still not fully elucidated, the protein is proposed to be involved in fat absorption by binding and intracellular transport of newly absorbed non-esterified long-chain free fatty acids, which are finally assembled and secreted in triglyceride-rich chylomicrons [4, 5]. FABP2 also mediates fatty acid signalling by transferring fatty acids to the nucleus as ligands for transcription factors, such as peroxisome proliferator-activated receptors

(PPARs) [6, 7] and seems to be involved in regulation of cell proliferation and differentiation [8, 9]. More recently, an antioxidant function was shown [10, 11].

Based on a huge number of association studies in different human populations, *FABP2* is described as a candidate gene for the metabolic syndrome [12–16]. Sequencing studies [13, 14, 16] revealed that the 5' upstream promoter region of *FABP2* contains insertion/deletion sites c. -80 –79insT (rs5861422), c. -136 –132delAGTAG (rs5861423) and c. -168 –166delAAGinsT (rs1973598) as well as c. -260 G > A (rs6857641), c. -471 G > A (rs2282688) and c. -778 G > T (rs10034579) single nucleotide polymorphisms (SNPs). For explanation of sequence variation nomenclature refer to den Dunnen and Antonarakis, 2000 [17]. These six variants are in complete linkage disequilibrium resulting in only two haplotypes A > B. As demonstrated by us [16] and others [14] the rare *FABP2* promoter haplotype B, with an allele frequency in Caucasians of 44% [16], showed almost 2–3-fold lower transcriptional activity than haplotype A in Caco2 cells. Recently, we showed that this different activity is due to decreased binding affinity of GATA-5 and -6 to the c. -80 –79insT polymorphism [18]. The *FABP2* promoter haplotypes were associated with postpran-

Correspondence: Professor Frank Döring, Molecular Nutrition, Institute for Human Nutrition and Food Science, University of Kiel, Heinrich-Hecht-Platz 10, 24118 Kiel, Germany

E-mail: sek@molnut.uni-kiel.de

Fax: +49-431-880-5658

Abbreviations: FABP2, fatty acid binding protein 2; KORA, Kooperative Gesundheitsforschung in der Region Augsburg; MONICA, multinational MONItoring of trends and determinants in Cardiovascular disease; PPAR, peroxisome proliferator-activated receptor

dial triglyceride levels [15], type 2 diabetes [16] and BMI [13]. Since, these studies were done in relatively small cohorts composed of 500–1000 participants and functional intervention studies are still lacking, the associations remain disputable. In the present study, we analysed the data of a large ($n = 8072$) population-based survey from 1994 to 2001 of the Kooperative Gesundheitsforschung in der Region Augsburg (KORA) study cohort regarding the association between *FABP2* promoter haplotypes and BMI.

2 Materials and methods

2.1 Study population

In the Southern German region of Augsburg including the city of Augsburg and the two surrounding counties, population-based surveys of the 25–74 years old population in groups of age range of 5 years were implemented in 1984 as part of the WHO multinational MONItoring of trends and determinants in CARdiovascular disease (MONICA) project and continued since, 1996 within the KORA platform. The aims of the surveys were to describe the prevalence of common diseases and their risk factors in a representative sample of the adult general population. The current study included the survey of the years 1994–1995 (MONICA S3) including 4856 participants and the survey of the years 1999–2001 (KORA S4) including 4261 participants yielding 9117 recruited participants. The study population of S3 and S4 consisted of all German residents of the Augsburg region who were born between 1920 and 1975 identified through the public record office. More than 99.5% of the participants were Caucasian. The high standards of the WHO MONICA project applied to both surveys. All study participants underwent a standardized interview, a physical examination and blood withdrawal by trained staff and signed a consent form of the Bavarian Ethics committee and the Ethics committee of the University of Munich. For determination of body weight and height, participants were asked to remove shoes and heavy clothing. The weight measurements were done with a calibrated body weight scale (SECA 709) and were carried out with an accuracy of 0.1 kg. The body height was read to the nearest 0.5 cm on a body height scale. BMI (kg/m^2) was calculated as weight in kilograms divided by height in square meters. The pooled data analysis included 8072 individuals with complete information on age, sex, BMI and genotypes. The range of BMI was 14–57 kg/m^2 and the gender distribution was equal. There was no overlap between the two surveys by design. Detail characteristics of the study cohorts were described elsewhere [19, 20].

2.2 Genotyping

The 5' upstream promoter region of *FABP2* containing insertion/deletion sites c.–80_–79insT (rs5861422), c.–

136_–132delAGTAG (rs5861423) and c.–168_–166delAA-GinsT (rs1973598) as well as c.–260G > A (rs6857641), c.–471G > A (rs2282688) and c.–778G > T (rs10034579) is in complete linkage disequilibrium resulting in only two haplotypes A > B. *FABP2* promoter haplotypes were genotyped based on htSNP c.–260G > A (rs6857641) using a MALDI TOF MS system (Sequenom, Mass EXTEND, San Diego, USA), with the 5' Capture Primer ACGTTGGATGAACAATCTTCAGACGGCATG and the 3' Capture Primer ACGTTGGATGTGAGAAGCATACCTATTCTG.

2.3 Statistical methods

We used a linear regression model with BMI as continuous outcome for both studies combined; the unit change in BMI by the DNA variants was estimated. Haplotype analysis was carried out with the statistical software R (V. 2.3.1. including haplo.stats package) using the haplo.glm procedure. This procedure performs an iterative two-step estimation-maximization (EM)-algorithm, with the posterior probabilities of pairs of haplotypes *per* subject used as weights to update the regression coefficients, and the regression coefficients used to update the posterior probabilities. Haplotypes were included into the regression model all at once except the most common haplotype. Using the expected number of copies of haplotype implies an additive model for each haplotype. Statistics were gender-stratified because sex-specific associations of *FABP2* polymorphisms were described [21, 22].

3 Results and discussion

As shown in Table 1, in the whole study population as well as in female subjects no associations between *FABP2* promoter haplotypes and BMI were found. In male subjects, we observed a significant reduction in BMI of -0.39 BMI units (95% CI: -0.73 , -0.05 , $p = 0.024$) for the homozygous *FABP2* promoter haplotype B compared with homozygous haplotype A (wild type). Carriers of haplotype B (A/B + B/B) showed a significant decrease in BMI of -0.19 BMI units (95% CI: -0.35 , -0.02 , $p = 0.027$). These findings were congruent with a significant reduction in BMI of the minor haplotype carriers (A/B + B/B) in the BMI point categories of 25–30 (BMI units: -0.10 , 95% CI: -0.18 , -0.01 , $p = 0.03$) and <30 (BMI units: -0.37 , 95% CI: -0.67 , -0.07 , $p = 0.02$).

The presented analysis of 8072 participants confirmed and extended previously data in humans that the rare *FABP2* promoter haplotype B has a protective effect on metabolic traits like type 2 diabetes [16]. Though, previously an increase in BMI was found in female non-Hispanics from Colorado (USA) [13] and no decrease in male whites similar to our results. These differences may partly be due to different diet composition, especially fatty acids,

Table 1. Frequencies of *FABP2* promoter genotypes (AA, AB, BB) and their associations with BMI as continuous variable *via* linear regression

| | Frequencies | | | Unit change in BMI in kg/m ² [95% confidence interval] (<i>p</i> -values) | | |
|---------------------------------------|-------------|------|-------|---|--------------------------------------|------------------------------------|
| | All | Men | Women | All | Men | Women |
| <i>By genotype</i> | | | | | | |
| All | 8072 | 4002 | 4070 | | | |
| AA | 2695 | 1293 | 1402 | | | |
| AB | 3974 | 1997 | 1977 | -0.047 [-0.26, 0.16] (0.66) | -0.140 [-0.4, 0.12] (0.29) | 0.048 [-0.28, 0.38] (0.78) |
| BB | 1403 | 712 | 691 | -0.206 [-0.49, 0.07] (0.15) | -0.392 [-0.73, -0.05] (0.024) | -0.004 [-0.44, 0.43] (0.99) |
| B ^{a)} | 5377 | 2709 | 2668 | -0.094 [-0.23, 0.04] (0.18) | -0.188 [-0.35, -0.02] (0.027) | 0.007 [-0.21, 0.22] (0.95) |
| <i>By WHO BMI cat.^{a)}</i> | | | | | | |
| 18.5–25 | 2729 | 1044 | 1685 | -0.041 [-0.12, 0.04] (0.33) | 0.011 [-0.11, 0.13] (0.86) | -0.072 [-0.18, 0.04] (0.21) |
| 25–30 | 3507 | 2105 | 1402 | -0.067 [-0.13, 0] (0.049) | -0.098 [-0.18, -0.01] (0.025) | -0.021 [-0.13, 0.09] (0.71) |
| 30–35 | 1355 | 695 | 660 | 0.037 [-0.07, 0.14] (0.51) | 0.056 [-0.09, 0.2] (0.46) | 0.017 [-0.14, 0.17] (0.83) |
| 35–40 | 334 | 116 | 218 | 0.029 [-0.19, 0.24] (0.79) | 0.111 [-0.28, 0.5] (0.57) | -0.011 [-0.27, 0.25] (0.93) |
| <i>By obesity status^{a)}</i> | | | | | | |
| <30 | 6282 | 3159 | 3123 | -0.16 [-0.39, 0.07] (0.17) | -0.37 [-0.67, -0.07] (0.017) | 0.01 [-0.33, 0.36] (0.94) |
| 330 | 1790 | 843 | 947 | -0.06 [-0.15, 0.03] (0.17) | -0.10 [-0.22, 0.02] (0.10) | -0.02 [-0.16, 0.12] (0.76) |

Results are the β estimate (linear regression) with 95% confidence interval and *p*-values. All calculations were adjusted for age and sex. The main results are in bold.

a) Additive model.

in the two cohorts. Additional, neither this nor the study from Damcott *et al.* 2003 [13] were adjusted for medication treatment of participants, which might have an impact on fatty acid metabolism and lead to divergent results.

Differences in associations of the *FABP2* promoter haplotypes with metabolic traits may result from strong but not total linkage disequilibrium of the promoter haplotype B with the Thr allele of the *FABP2* Ala54Thr polymorphism with an LD = 0.9 [13]. Associations with the Thr allele and metabolic traits showed controversial results. The Thr allele was associated with increased fasting lipid metabolism, intra-abdominal fat, C reactive protein, IL6, lipoprotein a, fasting insulin concentration, fasting fatty acid oxidation and decreased insulin sensitivity, reduced glucose uptake and obesity [23–29]. Further studies showed no influence of the Ala54Thr polymorphism on fasting and postprandial insulin, glucose or triglyceride levels, fat distribution and weight loss [30–35]. Other studies found associations with reduced subcutaneous adipose tissue, systolic blood pressure and glucose levels [31, 36]. These studies were carried out in populations with different ethnic, phenotypic and lifestyle backgrounds. This contributes in addition to putative changes in LD between the promoter and exon polymorphism in these different races to diverse associations.

Further, our data revealed a reduced BMI for nonobese but not for obese males carrying haplotype B. Hence, the *FABP2* promoter haplotype B may bear prevention against overweight as long as obesity has not been occurred.

At a first glance, the observed sexual dimorphism shows inconsistencies with the phenotype of *FABP2* knock out

mice [37]. Male mice lacking *FABP2* have higher body weight than wild type animals [37]. Here, a reduced BMI is associated with the *FABP2* promoter haplotype B which showed lower basal activity than haplotype A in cell culture experiments [13, 14, 16, 18, 38]. Assuming a functional connection of *FABP2* gene expression and BMI we tempt to speculate that the *FABP2* promoter haplotype B is *in vivo* more active in males than in females. This is supported by reports demonstrating higher activity of PPARs in male animals compared to females [39, 40] and higher responsiveness of *FABP2* promoter haplotype B than A to PPAR γ /RXR α as recently stated by us and others [41, 42]. The physiological mechanism by which the *FABP2* promoter influences BMI remains obscure. A possible pathway is the complex and still incomplete understood interaction between diabetes type 2 and obesity [27, 43]. *FABP2* is not solely expressed in enterocytes but also in GLP expressing intestinal epithelial L-cells [44]. The anti-diabetic hormones GLP-1 and GLP-2 are expressed after fat ingestion and could influence insulin sensitivity and *via* glucose metabolism the triglyceride metabolism in peripheral cells. Of course our hypothesis has to be tested by comparing the *FABP2* expression levels from human males and females.

4 Concluding remarks

We obtained evidence in a population-based sample comprising 8072 participants that the minor *FABP2* promoter haplotype B contribute to a reduced body weight in men.

This work was financially supported by the BMBF project 'Fat and Metabolism' – gene variations, gene regulation and gene function (AZ 0312823B).

The authors have declared no conflict of interest.

5 References

- [1] Cohn, S. M., Simon, T. C., Roth, K. A., Birkenmeier, E. H., Gordon, J. I., Use of transgenic mice to map cis-acting elements in the intestinal fatty acid binding protein gene (Fabpi) that control its cell lineage-specific and regional patterns of expression along the duodenal-colonic and crypt-villus axes of the gut epithelium, *J. Cell Biol.* 1992, 119, 27–44.
- [2] Gordon, J. I., Elshourbagy, N., Lowe, J. B., Liao, W. S., *et al.*, Tissue specific expression and developmental regulation of two genes coding for rat fatty acid binding proteins, *J. Biol. Chem.* 1985, 260, 1995–1998.
- [3] Sweetser, D. A., Birkenmeier, E. H., Klisak, I. J., Zollman, S., *et al.*, The human and rodent intestinal fatty acid binding protein genes. A comparative analysis of their structure, expression, and linkage relationships, *J. Biol. Chem.* 1987, 262, 16060–16071.
- [4] Baier, L. J., Bogardus, C., Sacchettini, J. C., A polymorphism in the human intestinal fatty acid binding protein alters fatty acid transport across Caco-2 cells, *J. Biol. Chem.* 1996, 271, 10892–10896.
- [5] Levy, E., Menard, D., Delvin, E., Stan, S., *et al.*, The polymorphism at codon 54 of the FABP2 gene increases fat absorption in human intestinal explants, *J. Biol. Chem.* 2001, 276, 39679–39684.
- [6] Wolfrum, C., Borrmann, C. M., Borchers, T., Spener, F., Fatty acids and hypolipidemic drugs regulate peroxisome proliferator-activated receptors alpha – and gamma-mediated gene expression via liver fatty acid binding protein: A signaling path to the nucleus, *Proc. Natl. Acad. Sci. USA* 2001, 98, 2323–2328.
- [7] Tan, N. S., Shaw, N. S., Vinckenbosch, N., Liu, P., *et al.*, Selective cooperation between fatty acid binding proteins and peroxisome proliferator-activated receptors in regulating transcription, *Mol. Cell Biol.* 2002, 22, 5114–5127.
- [8] Khan, S. H., Sorof, S., Liver fatty acid-binding protein: Specific mediator of the mitogenesis induced by two classes of carcinogenic peroxisome proliferators, *Proc. Natl. Acad. Sci. USA* 1994, 91, 848–852.
- [9] Schroeder, F., Atshaves, B. P., Starodub, O., Boedeker, A. L., *et al.*, Expression of liver fatty acid binding protein alters growth and differentiation of embryonic stem cells, *Mol. Cell Biochem.* 2001, 219, 127–138.
- [10] Wang, G., Gong, Y., Anderson, J., Sun, D., *et al.*, Antioxidative function of L-FABP in L-FABP stably transfected Chang liver cells, *Hepatology* 2005, 42, 871–879.
- [11] Rajaraman, G., Wang, G. Q., Yan, J., Jiang, P., *et al.*, Role of cytosolic liver fatty acid binding protein in hepatocellular oxidative stress: Effect of dexamethasone and clofibrate treatment, *Mol. Cell Biochem.* 2007, 295, 27–34.
- [12] Weiss, E. P., Brown, M. D., Shuldiner, A. R., Hagberg, J. M., Fatty acid binding protein-2 gene variants and insulin resistance: Gene and gene-environment interaction effects, *Physiol. Genomics* 2002, 10, 145–157.
- [13] Damcott, C. M., Feingold, E., Moffett, S. P., Barmada, M. M., *et al.*, Variation in the FABP2 promoter alters transcriptional activity and is associated with body composition and plasma lipid levels, *Hum. Genet.* 2003, 112, 610–616.
- [14] Formanack, M. L., Baier, L. J., Variation in the FABP2 promoter affects gene expression: Implications for prior association studies, *Diabetologia* 2004, 47, 349–351.
- [15] Geschonke, K., Klempt, M., Lynch, N., Schreiber, S., *et al.*, Detection of a promoter polymorphism in the gene of intestinal fatty acid binding protein (I-FABP), *Ann. N. Y. Acad. Sci.* 2002, 967, 548–553.
- [16] Li, Y., Fisher, E., Klapper, M., Boeing, H., *et al.*, Association between functional FABP2 promoter haplotype and type 2 diabetes, *Horm. Metab. Res.* 2006, 38, 300–307.
- [17] den Dunnen, J. T., Antonarakis, S. E., Mutation nomenclature extensions and suggestions to describe complex mutations: A discussion, *Hum. Mutat.* 2000, 15, 7–12.
- [18] Klapper, M., Bohme, M., Nitz, I., Doring, F., Type 2 diabetes-associated fatty acid binding protein 2 promoter haplotypes are differentially regulated by GATA factors, *Hum. Mutat.* 2008, 29, 142–149.
- [19] Heid, I. M., Vollmert, C., Hinney, A., Doring, A., *et al.*, Association of the 1031 MC4R allele with decreased body mass in 7937 participants of two population based surveys, *J. Med. Genet.* 2005, 42, e21.
- [20] Heid, I. M., Vollmert, C., Kronenberg, F., Huth, C., *et al.*, Association of the MC4R V103I polymorphism with the metabolic syndrome: The KORA Study, *Obesity (Silver Spring)* 2008, 16, 369–376.
- [21] Fisher, E., Li, Y., Burwinkel, B., Kuhr, V., *et al.*, Preliminary evidence of FABP2 A54T polymorphism associated with reduced risk of type 2 diabetes and obesity in women from a German cohort, *Horm. Metab. Res.* 2006, 38, 341–345.
- [22] Gastaldi, M., Diziere, S., Defoort, C., Portugal, H., *et al.*, Sex-specific association of fatty acid binding protein 2 and microsomal triacylglycerol transfer protein variants with response to dietary lipid changes in the 3-mo Medi-RIVAGE primary intervention study, *Am. J. Clin. Nutr.* 2007, 86, 1633–1641.
- [23] Guettier, J. M., Georgopoulos, A., Tsai, M. Y., Radha, V., *et al.*, Polymorphisms in the fatty acid-binding protein 2 and apolipoprotein C-III genes are associated with the metabolic syndrome and dyslipidemia in a South Indian population, *J. Clin. Endocrinol. Metab.* 2005, 90, 1705–1711.
- [24] Marin, C., Perez-Jimenez, F., Gomez, P., Delgado, J., *et al.*, The Ala54Thr polymorphism of the fatty acid-binding protein 2 gene is associated with a change in insulin sensitivity after a change in the type of dietary fat, *Am. J. Clin. Nutr.* 2005, 82, 196–200.
- [25] Nakanishi, S., Yamane, K., Kamei, N., Okubo, M., Kohno, N., The effect of polymorphism in the intestinal fatty acid-binding protein 2 gene on fat metabolism is associated with gender and obesity amongst nondiabetic Japanese-Americans, *Diabetes Obes. Metab.* 2004, 6, 45–49.
- [26] Yamada, K., Yuan, X., Ishiyama, S., Koyama, K., *et al.*, Association between Ala54Thr substitution of the fatty acid-binding protein 2 gene with insulin resistance and intra-abdominal fat thickness in Japanese men, *Diabetologia* 1997, 40, 706–710.
- [27] Mericq, V., Iniguez, G., Martinez, A., Avila, A., *et al.*, Ala54Thr polymorphism of the fatty acid-binding protein 2 gene (intestinal-type FABP) is associated with changes in insulin sensitivity in SGA pubertal girls, *J. Pediatr. Endocrinol. Metab.* 2008, 21, 117–125.

- [28] de Luis, D. A., Sagrado, M. G., Aller, R., Izaola, O., Conde, R., Influence of ALA54THR polymorphism of fatty acid-binding protein 2 on obesity and cardiovascular risk factors, *Horm. Metab. Res.* 2007, 39, 830–834.
- [29] Albala, C., Santos, J. L., Cifuentes, M., Villarroya, A. C., *et al.*, Intestinal FABP2 A54T polymorphism: Association with insulin resistance and obesity in women, *Obes. Res.* 2004, 12, 340–345.
- [30] de Luis, D. A., Sagrado, M. G., Izaola, O., Terroba, M. C., *et al.*, Influence of Ala54Thr polymorphism of fatty acid-binding protein-2 on clinical results of biliopancreatic diversion, *Nutrition* 2008, 24, 300–304.
- [31] Lara-Castro, C., Hunter, G. R., Lovejoy, J. C., Gower, B. A., Fernandez, J. R., Association of the intestinal fatty acid-binding protein Ala54Thr polymorphism and abdominal adipose tissue in African-American and Caucasian women, *J. Clin. Endocrinol. Metab.* 2005, 90, 1196–1201.
- [32] Pihlajamaki, J., Rissanen, J., Heikkinen, S., Karjalainen, L., Laakso, M., Codon 54 polymorphism of the human intestinal fatty acid binding protein 2 gene is associated with dyslipidemias but not with insulin resistance in patients with familial combined hyperlipidemia, *Arterioscler. Thromb. Vasc. Biol.* 1997, 17, 1039–1044.
- [33] Rissanen, J., Pihlajamaki, J., Heikkinen, S., Kekalainen, P., *et al.*, The Ala54Thr polymorphism of the fatty acid binding protein 2 gene does not influence insulin sensitivity in Finnish nondiabetic and NIDDM subjects, *Diabetes* 1997, 46, 711–712.
- [34] Sipilainen, R., Uusitupa, M., Heikkinen, S., Rissanen, A., Laakso, M., Variants in the human intestinal fatty acid binding protein 2 gene in obese subjects, *J. Clin. Endocrinol. Metab.* 1997, 82, 2629–2632.
- [35] Tahvanainen, E., Molin, M., Vainio, S., Tiret, L., *et al.*, Intestinal fatty acid binding protein polymorphism at codon 54 is not associated with postprandial responses to fat and glucose tolerance tests in healthy young Europeans. Results from EARS II participants, *Atherosclerosis* 2000, 152, 317–325.
- [36] de Luis, D. A., Aller, R., Izaola, O., Sagrado, M. G., Conde, R., Influence of ALA54THR polymorphism of fatty acid binding protein 2 on lifestyle modification response in obese subjects, *Ann. Nutr. Metab.* 2006, 50, 354–360.
- [37] Vassileva, G., Huwyler, L., Poirier, K., Agellon, L. B., Toth, M. J., The intestinal fatty acid binding protein is not essential for dietary fat absorption in mice, *FASEB J.* 2000, 14, 2040–2046.
- [38] Klapper, M., Bohme, M., Nitz, I., Doring, F., Type 2 diabetes-associated fatty acid binding protein 2 promoter haplotypes are differentially regulated by GATA factors, *Hum. Mutat.* 2008, 29, 142–149.
- [39] Ciana, P., Biserni, A., Tatangelo, L., Tiveron, C., *et al.*, A novel peroxisome proliferator-activated receptor responsive element-luciferase reporter mouse reveals gender specificity of peroxisome proliferator-activated receptor activity in liver, *Mol. Endocrinol.* 2007, 21, 388–400.
- [40] Jalouli, M., Carlsson, L., Ameen, C., Linden, D., *et al.*, Sex difference in hepatic peroxisome proliferator-activated receptor alpha expression: Influence of pituitary and gonadal hormones, *Endocrinology* 2003, 144, 101–109.
- [41] Helwig, U., Rubin, D., Kiosz, J., Bitter, W., *et al.*, The effects of retinol on postprandial parameters in men with different FABP2 promoter haplotypes, *Horm. Metab. Res.* 2007, 39, 237–243.
- [42] Bohme, M., Nitz, I., Doring, F., Klapper, M., Analysis of the transcriptional regulation of the FABP2 promoter haplotypes by PPARgamma/RXRalpha and Oct-1, *Biochim. Biophys. Acta* 2008, 1779, 616–621.
- [43] Romao, I., Roth, J., Genetic and environmental interactions in obesity and type 2 diabetes, *J. Am. Diet. Assoc.* 2008, 108, S24–S28.
- [44] Brubaker, P. L., Anini, Y., Direct and indirect mechanisms regulating secretion of glucagon-like peptide-1 and glucagon-like peptide-2, *Can. J. Physiol. Pharmacol.* 2003, 81, 1005–1012.



Analysis of the transcriptional regulation of the *FABP2* promoter haplotypes by PPAR γ /RXR α and Oct-1

Mike Böhme, Inke Nitz, Frank Döring, Maja Klapper*

Molecular Nutrition, Institute of Human Nutrition and Food Science, Christian-Albrechts-University of Kiel, Heinrich-Hecht-Platz 10, D-24118 Kiel, Germany

ARTICLE INFO

Article history:

Received 4 December 2007

Received in revised form 2 June 2008

Accepted 17 June 2008

Available online 21 June 2008

Keywords:

FABP2

PPAR γ

Oct-1

Promoter analysis

EMSA

ABSTRACT

Variants of the human intestinal fatty acid binding protein 2 gene (*FABP2*) are associated with traits of the metabolic syndrome. Relevant *FABP2* promoter polymorphisms c.-80_-79insT, c.-136_-132delAGTAG, c.-168_-166delAAGinsT, c.-260G>A, c.-471G>A, and c.-778G>T result in two haplotypes A and B. Activation of haplotypes by rosiglitazone stimulated PPAR γ /RXR α leads to 2-fold higher activity of haplotype B than A. As shown by chimeric *FABP2* promoter constructs, the higher responsiveness of *FABP2* haplotype B is mainly but not solely determined by polymorphism c.-471G>A. As shown by EMSA and promoter-reporter assays, Oct-1 interacts with the -471 region of *FABP2* promoters, induces the activities of both *FABP2* promoter haplotypes and abolishes the different activities of haplotypes induced by rosiglitazone activated PPAR γ /RXR α . In conclusion, our findings suggest a functional role of PPAR γ /RXR α and Oct-1 in the regulation of the *FABP2* gene.

© 2008 Elsevier B.V. All rights reserved.

1. Introduction

The human fatty acid binding protein 2 gene (*FABP2*, GenBank: NM_000134.2) is located on chromosome 4q28-q31, contains four exons and codes for a 15.1-kDa protein comprising 132 amino acid residues [1]. It is expressed in the intestine with highest cellular concentrations in the jejunum [2,3]. *FABP2* is involved in intestinal fat absorption [4–6]. A huge number of studies in different human populations revealed associations between the minor allele of the *FABP2* Ala54Thr polymorphism and risk parameters of insulin resistance [7]. Functional studies showed increased binding affinity of the variant protein to long-chain fatty acids [8]. More recently [9–11], single nucleotide polymorphisms and insertion/deletion sites c.-80_-79insT, c.-136_-132delAGTAG, c.-168_-166delAAGinsT and SNPs -260G>A, c.-471G>A and c.-778G>T were identified in the 5' upstream promoter region of *FABP2*. These polymorphisms are in complete linkage disequilibrium resulting in only two haplotypes A>B. *FABP2* promoter haplotypes were associated with postprandial triglyceride levels [12], BMI [9] and type 2 diabetes [11]. In accordance with the association studies, male *FABP2* knock-out mice showed key symptoms of the metabolic syndrome [13,14]. Therefore, the expression level of *FABP2* seems to be critical for insulin sensitivity and triglyceride metabolism. Thus, the transcriptional regulation of the *FABP2* gene is of special interest. In the present study we focus on the regulation of *FABP2* promoter haplotypes by PPAR γ /RXR α and Oct-1.

2. Materials and methods

2.1. Cell culture

HeLa and CaCo2 cells were purchased from German National Resource Centre for Biological Material (DSMZ, Braunschweig, Germany). Cells were maintained in MEM (Invitrogen, Carlsbad, CA, USA), supplemented with 10% (HeLa) or 20% (CaCo2) fetal calf serum (Invitrogen) and 1 mM non-essential amino acids (PAA, Cölbe, Germany) in a humidified incubator at 37 °C under an atmosphere of 5% CO₂. Cells were passaged at pre-confluent densities by use of 0.05% trypsin/5 mM EDTA (Biochrom AG, Berlin, Germany) solution every 2–3 days.

2.2. *FABP2* promoter luciferase constructs

The dual luciferase system was used (Promega, Madison, WI, USA). Cloning procedures were performed using Gateway Technology (Invitrogen), described previously [11,15].

2.3. Chimera constructs

Mutations in haplotype A (pGL4.10[luc2]-*FABP2*(A)) and haplotype B (pGL4.10[luc2]-*FABP2*(B)) containing promoter constructs were introduced to generate chimeras with single polymorphisms of haplotype B in the background of haplotype A (A-xB) and vice versa (B-xA). Single polymorphism exchange chimera constructs are shortly named as follows: for exchange of polymorphism c.-80_-79insT of haplotype A (rs5861422): A-80B; for c.-136_-132delAGTAG

* Corresponding author. Tel.: +049 431 8805661; fax: +049 431 8805658.
E-mail address: klapper@molnut.uni-kiel.de (M. Klapper).

(rs5861423): A-136B; for c.-168_-166delAAGinsT (rs1973598): A-168B, c.-260G>A (rs6857641): A-260B c.-471G>A (rs2282688): A-471B; c.-778G>T (rs10034579): A-778B and vice versa. Mutation of a putative PPAR γ binding site at -623/-607 upstream of the translation start site was introduced into the haplotype A (pGL4.10[luc2]-FABP2(A)) and haplotype B (pGL4.10[luc2]-FABP2(B)) containing promoter by exchange of a 4 base core region from CTAT to AGCG named Amut and Bmut, respectively. Introduction of mutations was performed using Quick Change in vitro mutagenesis Kit (Stratagene, La Jolla, CA, USA). All primers were purchased from MWG Biotech AG (Ebersberg, Germany). Sequences of primers are available on request. Verification of constructs was performed by sequencing.

2.4. Expression plasmids

The cDNAs of PPAR γ 2 and RXR α were kindly provided by Dr. T. Weitzel (University Medical Centre Hamburg-Eppendorf, Germany). Cloning procedures were performed using Gateway Technology

(Invitrogen) with the pcDNA-Dest40 destination vector as described previously [11,15,16]. The expression plasmids pcDNA3HA-Oct-1 and its empty control vector were a gift from H. Singh (University Chicago, IL, USA).

2.5. Transient transfections and reporter assays

Transient transfections were performed with FuGene6 (Roche, Basel, Switzerland) according to the manufacturers instructions. 4×10^3 HeLa cells were plated in 96-well plates. Cells were transfected with 30 ng (Figs. 1–2) or 25 ng (Fig. 3) pGL4.10[luc2]-FABP2-Promoter constructs or pGL4.10[luc2] as negative control and 3 ng pGL4.74 [hRLuc/TK] vector encoding *Renilla* luciferase as internal control. For co-transfection with PPAR γ /RXR α 33 ng (Figs. 1–2) or 25 ng (Fig. 3) Dest40-PPAR γ and RXR α expression vectors and 25 ng Dest40 empty control vector (Fig. 3) were used. For co-transfection with Oct-1 25 ng pcDNA3HA-Oct-1 and 75 ng empty pcDNA3HA vector were added. Co-transfection with PPAR γ /RXR α /Oct-1 was carried out with 25 ng of each plasmid vector. The PPAR γ /RXR α complex was activated 24 h

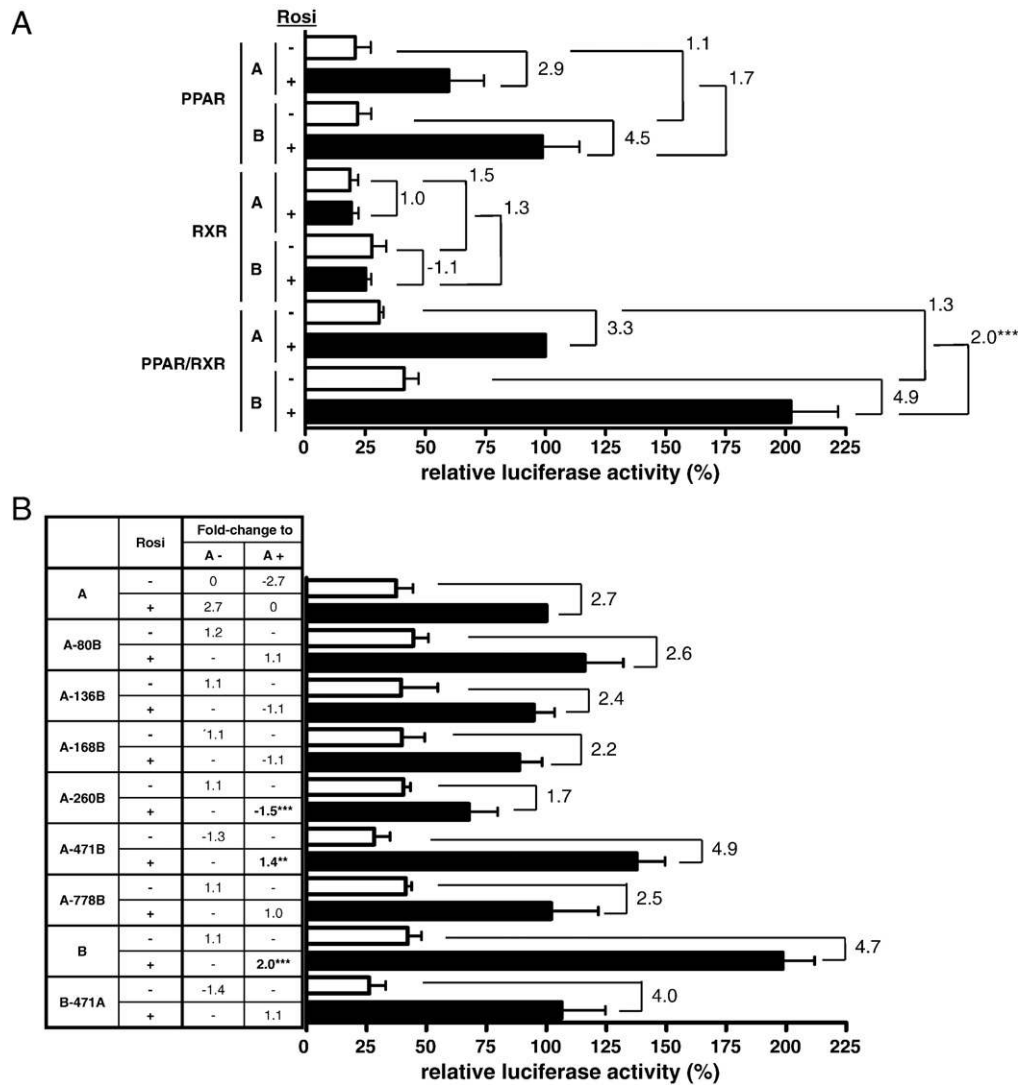

Fig. 1. Reporter activities of FABP2 promoter haplotypes and from it derived chimeras in HeLa cells were assessed 48 h after co-transfection with PPAR γ and/or RXR α and 24 h after activation with rosiglitazone (Rosi) (+) or DMSO control (-) using dual luciferase assay. The *Firefly* luciferase activities were normalized to *Renilla* luciferase activities and are given as relative luciferase activities in % of FABP2 promoter haplotype A. Each experiment was performed in triplicate for each sample. The results are expressed as mean \pm SEM for three independent experiments. *** $p < 0.001$, ** $p < 0.01$, * $p < 0.05$, as compared with haplotype A activity in all figures. (A) Luciferase activities of FABP2 promoter haplotypes (A, B) co-transfected with PPAR γ , RXR α or PPAR γ /RXR α are shown. (B) Alleles of each polymorphism in the FABP2 promoter haplotypes A>B are given. The positions of polymorphisms c.-80_-79insT (rs5861422), c.-136_-132delAAGAGT (rs5861423), c.-168_-166delAAGinsT (rs1973598), c.-260G>A (rs6857641), c.-471G>A (rs2282688), and c.-778G>T (rs10034579) are named as -80, -136, -168, -260, -471, and -778, respectively.

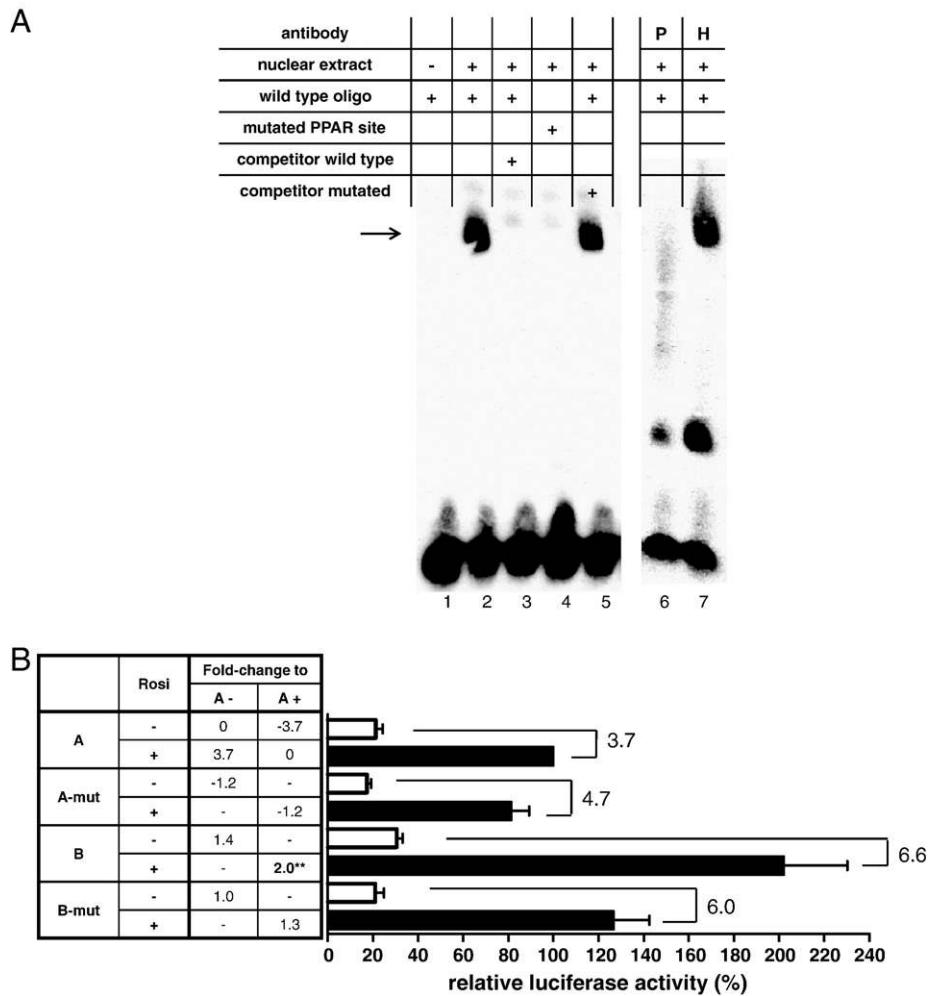

Fig. 2. (A) Differential interaction of PPAR γ with the FABP2 promoter region -623/-607 was analyzed with EMSA. Nuclear extract isolated from HeLa cells transfected with PPAR γ /RXR α were used for each binding reaction (no extract was added in lane 1) with biotinylated wild type oligos (lanes 1–3, 5–7) or mutated PPAR γ binding site oligo (lane 4). A specific shift was diminished by 100-fold excess of unlabeled oligo (lane 3) but not by unlabeled mutated PPAR γ binding site oligo (lane 4), indicated with an arrow. Super shift assays were carried out with antibodies against PPAR γ (P, lane 6) and HNF4 α (H, lane 7). (B) Reporter activities of FABP2 promoter haplotypes (A, B) and from it derived chimeras with a mutated PPAR γ core binding site at position -619/-616 were assessed in HeLa cells 48 h after co-transfection with PPAR γ /RXR α and 24 h after activation with rosiglitazone (Rosi) (+) or DMSO control (-) using dual luciferase assay.

after co-transfection with medium containing 1% NEAA, 1% BSA and 2 μ M rosiglitazone or DMSO as negative control. Luciferase activities were measured 48 h after transfection by Dual-Luciferase® Reporter Assay System (Promega). Relative luciferase activities of negative control pGL4.10[luc2] were determined for each condition and were subtracted from corresponding activities for pGL4.10[luc2]-FABP2-Promoter constructs. Each experiment was repeated at least three times, and each sample was studied in triplicate.

2.6. Electrophoretic mobility shift assay (EMSA)

EMSA was done as previously described [15,17]. The oligonucleotide sequences for position -629/-602 are 5'-GTCAGTGGCCTATCACCATT-CAGGATC-3' for the wild type and 5'-GTCAGTGGCAGCGCACCATTCAG-GATC-3' for the mutated PPAR γ binding site oligo, and for position -488/-447 are 5'-GAAAACGAATCTTATTAACCTTTAGCTTTTCAACTGTATTTC-3' for the wild type and 5'-GAAAACGAATCTTATTAACGGGGCCTTTT-CAACTGTATTTC-3' for the mutated Oct-1 binding site oligo, respectively. The mutated core binding sites are underlined; the base -471 is italicized. Antibodies against PPAR γ 2 (sc-22020) and HNF4 α (sc-6547x) were purchased from Santa Cruz (Heidelberg, Germany) and for Oct-1 self-made by C. Brunner (University Ulm, Germany) and added to a final concentration of 1 μ g (PPAR γ) and 2 μ g (Oct-1 and HNF4 α).

2.7. Real time RT-PCR

For RNA analysis 5.2×10^4 CaCo2 cells were plated in 6-well plates and transfected with 4 μ g pcDNA3HA-Oct-1 or solely Fugene 6 as control. Total RNA was extracted 48 h and 120 h after confluent growth with the RNeasy Kit (Qiagen, Hilden, Germany). CDNA synthesis of 1 μ g total RNA was done with Omniscript RT (Qiagen). Real time PCR was performed with a 7300 Real-Time PCR system (Applied Biosystems, Foster City, CA, USA) using QuantiTect SYBR Green PCR Kit (Qiagen). Primers were designed with the Primer3 online tool [18] and purchased from MWG Biotech AG. Sequences are available upon request. To determine the relationship between cycle number (C_T) and mRNA levels the $\Delta\Delta C_T$ method was conducted using 18S as control gene. All procedures were carried out according to manufactures instructions.

2.8. Statistical analyses

Statistical analyses were performed with GraphPad Prism 4 (GraphPad Software, Inc., San Diego, CA) using ANOVA and unpaired *t*-tests. The differences between haplotype A and B activities were tested with two-tailed *t*-tests. For comparison of chimera activities with haplotype A we used one-tailed *t*-tests because we hypothesized that activities of the chimera promoter constructs have to be above

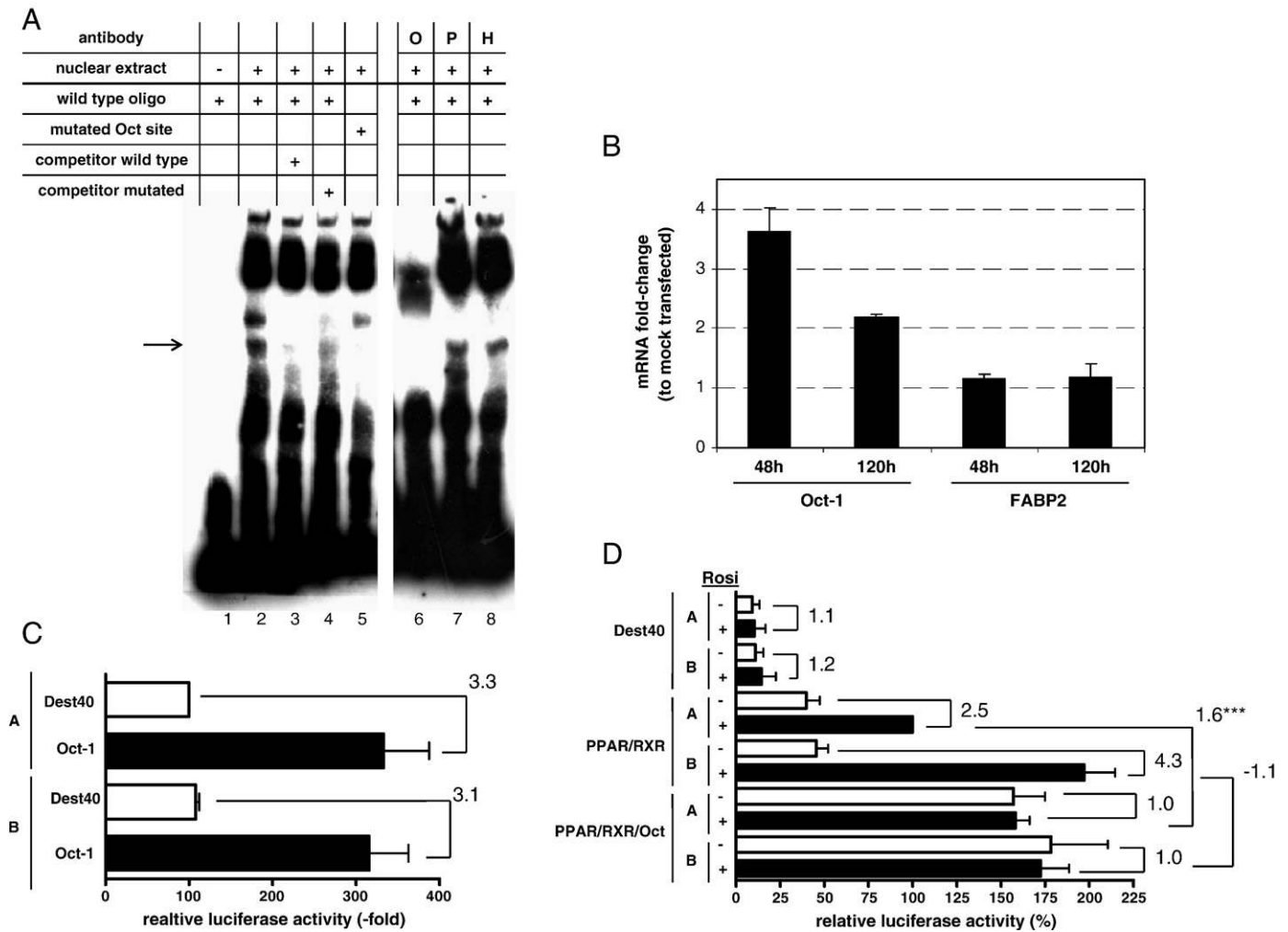

Fig. 3. (A) Differential interaction of Oct-1 with FABP2 promoter region containing the allele A of polymorphisms c.-471G>A (rs2282688) was analyzed with EMSA. Nuclear extract isolated from HeLa cells was used for each binding reaction (no extract was added in lane 1) with biotinylated haplotype A oligonucleotides (lanes 1–4, 6–8) or biotinylated mutated Oct-1 binding site oligonucleotide (lane 5). A specific shift was diminished by 100-fold excess of unlabeled haplotype A oligo (lane 3) but not by unlabeled mutated Oct-1 binding site oligo (lane 4), indicated with an arrow. Super shift assay was carried out with an antibody against Oct-1 (O, lane 6) and control antibodies against PPAR γ (P, lane 7) and HNF4 α (H, lane 8). (B) Gene expression of Oct-1 and FABP2 in Caco2 cells was assessed 72 h after co-transfection and 48 h or 120 h after post-confluence with Oct-1 using SYBR green RT-PCR. Results are expressed as mean \pm SEM for two independent experiments. (C) Reporter activities of FABP2 promoter haplotypes (A, B) in HeLa cells were assessed 48 h after co-transfection with empty control vector Dest40 or Oct-1 using dual luciferase assay. The *Firefly* luciferase activities were normalized to *Renilla* luciferase activities and are given as relative luciferase activities in % of Dest40 transfected FABP2 promoter haplotype A. (D) Reporter activities of FABP2 promoter haplotypes (A, B) in HeLa cells were assessed 48 h after co-transfection with empty control vector Dest40, PPAR γ /RXR α , or PPAR γ /RXR α /Oct-1 and 24 h after activation with rosiglitazone (Rosi) (+) or DMSO control (-) using dual luciferase assay.

promoter activities of haplotype A. All values were expressed as means \pm SEM. Significant differences were considered for p values less than 0.05.

3. Results

3.1. The polymorphism c.-471G>A of FABP2 promoter haplotypes is involved in determining different activities of FABP2 promoter haplotypes induced by rosiglitazone activated PPAR γ /RXR α

As published recently [19], activation of FABP2 promoter haplotypes by rosiglitazone stimulated PPAR γ /RXR α leads to higher activity of haplotype B than A. As shown in Fig. 1A, the rosiglitazone stimulated PPAR γ /RXR α induced absolute activity (AA) of haplotype B is 2.0-fold higher than haplotype A. The induction ratio (IR) between unstimulated and rosiglitazone stimulated PPAR γ /RXR α induced activity is 3.3 for haplotype A and 4.9 for haplotype B. To identify the causal polymorphism(s) for this haplotype difference, we sequentially introduced alleles of FABP2 haplotype B into A (A-xB) and compared

the rosiglitazone stimulated PPAR γ /RXR α induced activities of resulting FABP2 promoter chimeras with those of haplotype A and B. As shown in Fig. 1B, AA of FABP2 promoter chimeras A-80B (1.1-fold compared to A), A-136B (-1.1-fold), A-168B (-1.1-fold), and A-778B (1.1-fold) is similar to haplotype A (1.0-fold). AA of chimera A-471B (1.4-fold) is between haplotype B (2-fold) and A (1.0-fold). The opposite chimeras B-471A (1.1-fold) showed similar AA than haplotype A. Comparison of IRs revealed that chimera A-471B (4.9-fold) exhibits similar IR than haplotype B (4.7-fold). The IR of the opposite chimera B-471A (4.0-fold) is more similar to haplotype B (4.7-fold) than A (2.7-fold). Thus, we reasoned that the polymorphism c.-471G>A of FABP2 promoter haplotypes is involved in determining rosiglitazone stimulated PPAR γ /RXR α induced activities of haplotype A and B.

3.2. Identification of a PPAR γ binding site at position -623/-607 of the FABP2 promoter

A TRANSFAC Professional database search revealed a putative PPAR γ binding site at position -623/-607 of the FABP2 promoter. This

site was tested for PPAR γ binding using EMSA. As shown in Fig. 2A, with a –629/–602 probe we obtained a shift (arrow, lane 2) when using nuclear extract from HeLa cells transfected with PPAR γ /RXR α . 100-fold molar excess of the unlabeled probe (lane 3) but not a mutated probe (lane 5) abolished the shift. A labeled probe with a mutated PPAR γ core binding site did not display a shift (lane 4). A super shift assay with an antibody against PPAR γ (lane 6) but not HNF4 α (lane 7) abrogated the shift. To explore the functional importance of the –623/–607 region for FABP2 promoter haplotype difference, promoter–reporter analysis with haplotype mutants was done. As shown in Fig. 2B, incorporation of a 4 bp mutation into the core sequence of PPAR γ -consensus at position –619/–616 leads to a reduction of the AA of FABP2 promoter haplotypes by a factor of –1.2 (haplotype A) and –1.6 (B), respectively. Mutation of the putative PPAR γ binding site shows a small decrease or increase in IR for haplotype A (from 3.7-fold to 4.7-fold) and B (6.6-fold to 6.0-fold). Taken together, the identified PPAR γ binding site at positions –623/–607 of the FABP2 promoter is functional but its influence on the rosiglitazone stimulated PPAR γ /RXR α induced activity of FABP2 promoter haplotypes is limited.

3.3. Oct-1 binds to a FABP2 promoter region containing the c.471G>A polymorphism and abolishes the different activities of FABP2 promoter haplotypes induced by rosiglitazone activated PPAR γ /RXR α

A putative Oct-1 binding site in the FABP2 promoter region containing the c.471G>A polymorphism was found by TRANSFAC Professional database search. To see if the –471 region shows binding of the ubiquitous expressed Oct-1 [20], electro mobility shift and super shift assays were performed with nuclear protein extracts from HeLa cells. As shown in Fig. 3A, with a FABP2 promoter probe containing the –471 region we observed a specific signal (lane 2, arrow), which could be displaced with the unlabeled probe (lane 3). This total displacement was not observed by a competitor with a mutation in the Oct-1 core binding site at positions –470/–467 (lane 4). Only unspecific binding was generated by a labeled probe with the mutated Oct-1 binding site (lane 5). A super shift assay with an antibody against Oct-1 (lane 6), but not PPAR γ (lane 7) and HNF4 α (lane 8), abolished the specific shift completely. Differences in binding affinity to –471G and –471A probes could not be detected by a gradually increasing excess of unlabeled probes (data not shown). Next, we determined the influence of Oct-1 on FABP2 mRNA expression in intestinal CaCo2 cells. As shown in Fig. 3B, a 2–3.5-fold over-expression of Oct-1 has no influence on mRNA steady level of FABP2. In order to reveal the effect of Oct-1 on the transcriptional activity of FABP2 promoter haplotypes we performed promoter–reporter analysis. As shown in Fig. 3C, Oct-1 causes similar activation of FABP2 promoter haplotype A and B. In the presence of PPAR γ /RXR α , Oct-1 induces the basal activity of FABP2 promoter haplotype A and B to the same level (Fig 3D). These basal activities could not be induced by rosiglitazone. AA of haplotype A was significantly enhanced (1.6-fold) by Oct-1, whereas AA of haplotype B was not altered (fold-change –1.1). Thus, Oct-1 abolishes the different activities in FABP2 promoter haplotypes induced by rosiglitazone activated PPAR γ /RXR α .

4. Discussion

The FABP2 promoter haplotypes are associated with traits of the metabolic syndrome in candidate gene approaches [9,11,12]. Though, in genome-wide association studies the FABP2 locus was linked with physical fitness in DZ female twins [21] but not with type 2 diabetes and related traits [22–24]. As shown previously by us [11] and others [9,10], the basal transcription of the rare FABP2 promoter haplotype B is about 2–3-fold lower than the common

haplotype A in FABP2 expressing post-confluent Caco2 cells. Recently, we showed that this different activity is due to decreased binding affinity of GATA factors to the c.-80_-79insT polymorphism [17]. Interestingly, in FABP2 non-expressing HeLa cells activation of FABP2 promoters by PPAR γ /RXR α lead to higher activity of haplotype B in comparison to A [19]. In the present study, this higher responsiveness of FABP2 promoter haplotype B was investigated in more detail. At first glance, the rosiglitazone dependent PPAR γ /RXR α induced different activities of FABP2 promoter haplotypes seem not to be important *in vivo* since FABP2 is expressed in the small intestine [2] where PPAR α and PPAR δ are predominantly expressed [25]. Whereas, the higher activating potential of FABP2 promoter haplotype B might result in an ectopic expression of FABP2 in PPAR γ expressing tissues of haplotype B carriers. This might explain the FABP2 promoter association with diabetes type 2 [11], since PPAR γ is expressed in pancreatic beta cells [26]. Further, PPAR γ was associated in genome-wide association studies with type 2 diabetes and obesity [22–24], which might contribute to FABP2 associations. Thus, pancreatic beta cells and adipocytes from FABP2 promoter haplotype B carriers should be used to test this hypothesis.

By means of reporter assays, we measured the rosiglitazone stimulated PPAR γ /RXR α induced absolute activities (AA) as well as the induction ratio (IR) between un-stimulated and rosiglitazone stimulated PPAR γ /RXR α induced activities of FABP2 haplotype A, B and haplotype chimeras. We found that polymorphism c.-471G>A is involved in determining different AA and IR of FABP2 promoter haplotypes. We have to admit, that the AA of chimera A-471B and the IR of B-471A are not in complete accordance to the corresponding haplotypes B and A, respectively. Therefore, other polymorphism than c.-471G>A or a combination of polymorphisms could be involved in determining different responsiveness of FABP2 promoter haplotypes. Surprisingly, a functional PPAR γ binding site was not found in the –471 region but at position –623/–607 of the FABP2 promoter. Based on EMSA, we identified a PPAR γ binding site at position –623/–607 of the FABP2 promoter. Activation of –623/–607 promoter mutants by PPAR γ /RXR α revealed that this site has limited or no influence on the activity of haplotype A or B, respectively. Thus, the functionality and importance of the –623/–607 PPAR γ binding site is questionable. Further PPAR γ binding sites seem to be relevant for the induction of FABP2 promoter haplotype activity by PPAR γ .

So far, Oct-1 has been described as an important transcription factor for genes involved in immune system regulation [27]. The expression of housekeeping genes encoding histone H2B or snRNA is also dependent on Oct-1 [28]. In the present study we identified FABP2 as a potential target gene of Oct-1. The activity of FABP2 promoter haplotypes is induced by Oct-1 by factor of three. Furthermore, the region of the FABP2 promoter containing the c.-471G>A polymorphism interacts with Oct-1. Interestingly, Oct-1 abolishes the different activities in FABP2 promoter haplotypes induced by rosiglitazone activated PPAR γ /RXR α . Thus, high concentration of Oct-1 can override the effect of PPAR γ /RXR α on different activities of FABP2 promoter haplotypes. In contrast to the promoter–reporter assays in HeLa cells, we found no effect of Oct-1 on FABP2 mRNA steady level in CaCo2 cells. Thus, our findings seem to be not relevant for intestinal FABP2 expression but could be important for an ectopic expression of FABP2 in PPAR γ /RXR α and Oct-1 expressing tissues. Of course, *ex vivo* or *in vivo* approaches are necessary to test this hypothesis. Based on our findings, a functional interaction of PPAR γ /RXR α and Oct-1 can be also considered. Supportively, a link between fat metabolism and Oct-1 was revealed by direct interaction between RXR and Oct-1 [29]. More indirectly, PPAR γ induces the expression of the Oct-1 [30]. In conclusion, our findings suggest a functional role of PPAR γ /RXR α and Oct-1 in the regulation of the FABP2 gene.

Acknowledgements

This work was financially supported by the BMBF-Project “Fat and Metabolism – gene variation, gene regulation and gene function” (AZ 0312823B). We thank Y. Dignal and D. Stengel for excellent technical assistance. We thank Dr. T. Weitzel for providing PPAR γ and RXR α plasmids, Dr. C. Brunner for the Oct-1 antibody and Dr. H. Singh for the Oct-1 expression plasmid.

References

- [1] D.A. Sweetser, E.H. Birkenmeier, I.J. Klisak, S. Zollman, R.S. Sparkes, T. Mohandas, A. J. Lusis, J.I. Gordon, The human and rodent intestinal fatty acid binding protein genes. A comparative analysis of their structure, expression, and linkage relationships, *J. Biol. Chem.* 262 (1987) 16060–16071.
- [2] D.A. Sweetser, S.M. Hauff, P.C. Hoppe, E.H. Birkenmeier, J.I. Gordon, Transgenic mice containing intestinal fatty acid-binding protein-human growth hormone fusion genes exhibit correct regional and cell-specific expression of the reporter gene in their small intestine, *Proc. Natl. Acad. Sci. U S A* 85 (1988) 9611–9615.
- [3] S.M. Cohn, T.C. Simon, K.A. Roth, E.H. Birkenmeier, J.I. Gordon, Use of transgenic mice to map *cis*-acting elements in the intestinal fatty acid binding protein gene (Fabpi) that control its cell lineage-specific and regional patterns of expression along the duodenal-colonic and crypt-villus axes of the gut epithelium, *J. Cell. Biol.* 119 (1992) 27–44.
- [4] J.B. Lowe, J.C. Sacchettini, M. Laposata, J.J. McQuillan, J.I. Gordon, Expression of rat intestinal fatty acid-binding protein in *Escherichia coli*. Purification and comparison of ligand binding characteristics with that of *Escherichia coli*-derived rat liver fatty acid-binding protein, *J. Biol. Chem.* 262 (1987) 5931–5937.
- [5] E. Levy, D. Menard, E. Delvin, S. Stan, G. Mitchell, M. Lambert, E. Ziv, J.C. Feoli-Fonseca, E. Seidman, The polymorphism at codon 54 of the FABP2 gene increases fat absorption in human intestinal explants, *J. Biol. Chem.* 276 (2001) 39679–39684.
- [6] L.J. Baier, C. Bogardus, J.C. Sacchettini, A polymorphism in the human intestinal fatty acid binding protein alters fatty acid transport across Caco-2 cells, *J. Biol. Chem.* 271 (1996) 10892–10896.
- [7] E.P. Weiss, M.D. Brown, A.R. Shuldiner, J.M. Hagberg, Fatty acid binding protein-2 gene variants and insulin resistance: gene and gene–environment interaction effects, *Physiol. Genomics* 10 (2002) 145–157.
- [8] L.J. Baier, J.C. Sacchettini, W.C. Knowler, J. Eads, G. Paolisso, P.A. Tataranni, H. Mochizuki, P.H. Bennett, C. Bogardus, M. Prochazka, An amino acid substitution in the human intestinal fatty acid binding protein is associated with increased fatty acid binding, increased fat oxidation, and insulin resistance, *J. Clin. Invest.* 95 (1995) 1281–1287.
- [9] C.M. Damcott, E. Feingold, S.P. Moffett, M.M. Barmada, J.A. Marshall, R.F. Hamman, R.E. Ferrell, Variation in the FABP2 promoter alters transcriptional activity and is associated with body composition and plasma lipid levels, *Hum. Genet.* 112 (2003) 610–616.
- [10] M.L. Formanack, L.J. Baier, Variation in the FABP2 promoter affects gene expression: implications for prior association studies, *Diabetologia* 47 (2004) 349–351.
- [11] Y. Li, E. Fisher, M. Klapper, H. Boeing, A. Pfeiffer, J. Hampe, S. Schreiber, B. Burwinkel, J. Schrezenmeir, F. Doring, Association between functional FABP2 promoter haplotype and type 2 diabetes, *Horm. Metab. Res.* 38 (2006) 300–307.
- [12] K. Geschonke, M. Klempt, N. Lynch, S. Schreiber, S. Fenselau, J. Schrezenmeir, Detection of a promoter polymorphism in the gene of intestinal fatty acid binding protein (I-FABP), *Ann. N. Y. Acad. Sci.* 967 (2002) 548–553.
- [13] G. Vassileva, L. Huwyler, K. Poirier, L.B. Agellon, M.J. Toth, The intestinal fatty acid binding protein is not essential for dietary fat absorption in mice, *Faseb. J.* 14 (2000) 2040–2046.
- [14] L.B. Agellon, L. Li, L. Luong, R.R. Uwiera, Adaptations to the loss of intestinal fatty acid binding protein in mice, *Mol. Cell. Biochem.* 284 (2006) 159–166.
- [15] M. Klapper, M. Bohme, I. Nitz, F. Doring, The human intestinal fatty acid binding protein (hFABP2) gene is regulated by HNF-4 α , *Biochem. Biophys. Res. Commun.* (2007).
- [16] I. Nitz, F. Doring, J. Schrezenmeir, B. Burwinkel, Identification of new acyl-CoA binding protein transcripts in human and mouse, *Int. J. Biochem. Cell. Biol.* 37 (2005) 2395–2405.
- [17] M. Klapper, M. Bohme, I. Nitz, F. Doring, Type 2 diabetes-associated fatty acid binding protein 2 promoter haplotypes are differentially regulated by GATA factors, *Hum. Mutat.* (2007).
- [18] S. Rozen, H. Skaletsky, Primer3 on the WWW for general users and for biologist programmers, *Methods Mol. Biol.* 132 (2000) 365–386.
- [19] U. Helwig, D. Rubin, M. Klapper, Y. Li, M. Nothnagel, U.R. Folsch, F. Doring, S. Schreiber, J. Schrezenmeir, The association of fatty acid-binding protein 2 A54T polymorphism with postprandial lipemia depends on promoter variability, *Metabolism* 56 (2007) 723–731.
- [20] I. Kemler, W. Schaffner, Octamer transcription factors and the cell type-specificity of immunoglobulin gene expression, *Faseb. J.* 4 (1990) 1444–1449.
- [21] M.H. De Moor, T.D. Spector, L.F. Cherkas, M. Falchi, J.J. Hottenga, D.I. Boomsma, E.J. De Geus, Genome-wide linkage scan for athlete status in 700 British female DZ twin pairs, *Twin. Res. Hum. Genet.* 10 (2007) 812–820.
- [22] T.M. Frayling, Genome-wide association studies provide new insights into type 2 diabetes aetiology, *Nat. Rev. Genet.* 8 (2007) 657–662.
- [23] S. Ichihara, Y. Yamada, Genetic factors for human obesity, *Cell Mol Life Sci* (2007).
- [24] C.M. Lindgren, M.I. McCarthy, Mechanisms of disease: genetic insights into the etiology of type 2 diabetes and obesity, *Nat. Clin. Pract. Endocrinol. Metab.* (2008).
- [25] J.N. Feige, L. Gelman, L. Michalik, B. Desvergne, W. Wahli, From molecular action to physiological outputs: peroxisome proliferator-activated receptors are nuclear receptors at the crossroads of key cellular functions, *Prog. Lipid. Res.* 45 (2006) 120–159.
- [26] E.K. Kim, K.B. Kwon, B.S. Koo, M.J. Han, M.Y. Song, E.K. Song, M.K. Han, J.W. Park, D. G. Ryu, B.H. Park, Activation of peroxisome proliferator-activated receptor-gamma protects pancreatic beta-cells from cytokine-induced cytotoxicity via NF kappaB pathway, *Int. J. Biochem. Cell. Biol.* 39 (2007) 1260–1275.
- [27] N.N. Luchina, I.V. Krivega, E.V. Pankratova, Human Oct-1L isoform has tissue-specific expression pattern similar to Oct-2, *Immunol Lett* 85 (2003) 237–241.
- [28] E.V. Pankratova, E.V. Sytina, N.N. Luchina, I.V. Krivega, The regulation of the Oct-1 gene transcription is mediated by two promoters, *Immunol. Lett.* 88 (2003) 15–20.
- [29] T. Kakizawa, T. Miyamoto, K. Ichikawa, A. Kaneko, S. Suzuki, M. Hara, T. Nagasawa, T. Takeda, J. Mori, M. Kumagai, K. Hashizume, Functional interaction between Oct-1 and retinoid X receptor, *J. Biol. Chem.* 274 (1999) 19103–19108.
- [30] D. Bruemmer, F. Yin, J. Liu, J.P. Berger, T. Sakai, F. Blaschke, E. Fleck, A.J. Van Herle, B.M. Forman, R.E. Law, Regulation of the growth arrest and DNA damage-inducible gene 45 (GADD45) by peroxisome proliferator-activated receptor gamma in vascular smooth muscle cells, *Circ. Res.* 93 (2003) e38–e47.

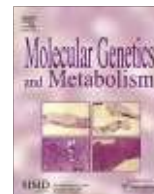

MTTP variants and body mass index, waist circumference and serum cholesterol level: Association analyses in 7582 participants of the KORA study cohort

Mike Böhme^a, Harald Grallert^b, Alexandra Fischer^b, Christian Gieger^b, Inke Nitz^a, Iris Heid^b, Christine Kohl^a, H.-Erich Wichmann^b, Thomas Illig^b, Frank Döring^{a,*}

^aInstitute of Human Nutrition and Food Science, Molecular Nutrition, Christian-Albrecht-University, Heinrich-Hecht-Platz 10, 24118 Kiel, Germany

^bInstitute of Epidemiology, German Research Centre for Environmental Health, Helmholtz Centre, Munich, Germany

ARTICLE INFO

Article history:

Received 16 September 2008

Accepted 16 September 2008

Available online 23 October 2008

Keywords:

MTTP Polymorphisms

BMI

Waist circumference

Total cholesterol

KORA study cohort

ABSTRACT

The microsomal triglyceride transfer protein (MTTP) is a key regulator in the assembly and secretion of chylomicrons and very low density lipoprotein (VLDL) in the intestine and in liver. Associations between MTTP variants and traits of the metabolic syndrome are carried out in relatively small cohorts and are not consistent.

We analysed MTTP polymorphisms in 7582 participants of the KORA study cohort. Seven htSNPs covering a 52 kb region of the MTTP locus and two cSNPs (I128T, H297Q) were selected.

A MTTP haplotype containing the minor allele of H297Q showed a significant decrease of -0.636 (95% CI: $-1.226, -0.046$; $p = 0.035$) BMI units in females but not in males. In comparison to homozygous H-carriers for the major allele of the MTTP H297Q polymorphism, homozygous Q297Q carriers showed a significant decrease in BMI of -0.425 BMI units (95% CI: $-0.74, -0.12$; $p = 0.007$), in waist circumference of -0.990 cm (95% CI: $1.74, -0.24$; $p = 0.01$) and in total cholesterol of -0.039 mmol/l (95% CI: $-0.07, 0$; $p = 0.03$). Heterozygous Q-carriers displayed a reduction in BMI of -0.183 BMI unit (95% CI: $-0.33, -0.04$; $p = 0.012$), in waist circumference of -0.45 cm (95% CI: $0.8, -0.1$; $p = 0.01$) and in total cholesterol of -0.103 mmol/l (95% CI: $-0.18, -0.03$; $p = 0.01$). Gender stratified statistics revealed a significant reduction of -0.657 BMI units (95% CI: $-1.14, -0.18$; $p = 0.007$), -1.437 cm waist circumference (95% CI: $-2.55, -0.32$; $p = 0.01$) and -0.052 mmol/l total cholesterol (95% CI: $-0.1, -0.01$; $p = 0.03$) for females homozygous for the Q297Q polymorphism. Females carrying the Q-allele showed a decrease of -0.259 BMI unit (95% CI: $-0.48, -0.04$; $p = 0.023$), -0.662 cm waist circumference (95% CI: $-1.18, -0.14$; $p = 0.01$) and -0.111 mmol/l total cholesterol (95% CI: $-0.21, -0.01$; $p = 0.03$).

Our association analysis in a large population based study cohort provides evidence that the minor allele of the MTTP H297Q polymorphism is associated with lower BMI, waist circumference and total cholesterol in females but not in males.

© 2008 Elsevier Inc. All rights reserved.

Introduction

The microsomal triglyceride transfer protein (MTTP, OMIM accession number: 157147; GenBank: NM_000253.2) gene is located on chromosome 4q24, contains nineteen exons and codes for a 97.4 kDa protein comprising 876 amino acid residues. MTTP is expressed in the liver, the small intestine and the heart. It plays a critical role in the assembly and secretion of very low density lipoproteins (VLDLs) and chylomicrons [1,2]. In the MTTP gene common regulatory ($-493G > T$, $-400A > T$, $-164T > C$) and nonsynonymous (I128T, H297Q) polymorphisms were described [3]. Polymorphisms $-493G > T$ (rs1800591), $-400A > T$ (rs1800803), $-164T > C$ (rs1800804) and I128T (rs3816873) are in complete linkage

disequilibrium in Caucasian [3,4]. Several studies indicated that the minor alleles of these polymorphisms are associated with lower LDL levels and protect against risk parameters of the metabolic syndrome [3,5–14]. Opposite or no associations were found in other studies [15–22]. Since these initial association studies were carried out in relatively small cohorts, we analysed MTTP variants regarding their associations to traits of the metabolic syndrome in 7582 participants of the KORA study cohort (S3, S4).

Material and methods

Study population

In the Southern German region of Augsburg including the city of Augsburg and the two surrounding counties, population-based

* Corresponding author. Fax: +49 431 880 5658.

E-mail address: sek@molnut.uni-kiel.de (M. Böhme).

surveys of the 25–74 year old population in groups of age range of 5 years were implemented in 1984 as part of the WHO MONICA (multinational MONItoring of trends and determinants in Cardiovascular disease) project and continued since 1996 within the KORA (Kooperative Gesundheitsforschung in der Region Augsburg) platform. The aims of the surveys were to describe the prevalence of common diseases and their risk factors in a representative sample of the adult general population. The current study included the survey of the years 1994–1995 (MONICA S3) including 4856 participants and the survey of the years 1999–2001 (KORA S4) including 4261 participants yielding 9117 recruited participants. The study population of S3 and S4 consisted of all German residents of the Augsburg region who were born between 1920 and 1975 identified through the public record office. More than 99.5% of the participants were Caucasian. The high standards of the WHO MONICA project applied to both surveys. All study participants underwent a standardized interview, a physical examination, and blood withdrawal by trained staff and signed a consent form of the Bavarian Ethics committee and the Ethics committee of the University of Munich. For determination of body weight and height, participants were asked to remove shoes and heavy clothing. The weight measurements were done with a calibrated body weight scale (SECA 709) and were carried out with an accuracy of 0.1 kg. The body height was read to the nearest 0.5 cm on a body height scale. BMI (kg/m^2) was calculated as weight in kilograms divided by height in square meters. The pooled data analysis included only 7582 individuals out of 9117, because complete information on age, sex, BMI and 9 genotypes were not available for the whole group. There was no overlap between the two surveys by design.

Genotyping

Genotyping was performed using a MALDI TOF MS system (Sequenom, Mass EXTEND, San Diego, USA). Haplotype tagging SNPs (htSNPs) with a minor allele frequency >0.1 were selected in order to cover the whole MTTP gene locus (52 kb). The selection was based on Haploview 3.2 [23]. Coding SNPs (cSNPs) rs3816873 (I128T) and rs2306985 (H297Q) were selected based on previous studies and suggested functionality [3,4,13]. Sequences of primers and assay probes are available on request.

Statistical methods

We used a linear regression model with BMI as continuous outcome for both studies combined; the unit change in BMI by the DNA variants was estimated. Haplotype analysis was carried out with the statistical software R (V. 2.3.1. including haplo.stats package) using the haplo.glm procedure. This procedure performs

an iterative two-step Estimation-Maximization (EM)-algorithm, with the posterior probabilities of pairs of haplotypes per subject used as weights to update the regression coefficients, and the regression coefficients used to update the posterior probabilities. Haplotypes were included into the regression model all at once except the most common haplotype. Using the expected number of copies of haplotype implies an additive model for each haplotype.

Results

In order to analyse the association between MTTP variants and anthropometric risk parameters, seven htSNPs (rs1503777, rs3811800, rs105763, rs2035816, rs982424, rs2903202, rs1491244) and two nonsynonymous cSNPs (rs3816873, rs2306985) were genotyped in 9117 participants of the KORA study cohort (S3, S4). htSNPs with a minor allele frequency >0.1 were selected in order to cover the whole MTTP gene locus (52 kb). Coding SNPs (cSNPs) rs3816873 (I128T) and rs2306985 (H297Q) were selected based on previous studies and suggested functionality [3,4,13]. Details of the study cohort were published recently [24,25]. In short, the participants were 25–74 years of age, the range of BMI was 14–57 kg/m^2 and approximately 50% were female. The selected htSNPs comprise a 52 kb region of the MTTP locus. The selected cSNPs lead to an amino acid exchange from I128 to T128 (rs3816871) and H297 to Q297 (rs2306985), respectively. The two other known cSNPs Q95H and Q244E of the MTTP gene were not genotyped because of their low frequencies. Haplotypes were computed with the nine htSNPs and cSNPs. As shown in Table 1, we identified nine haplotypes with frequencies between 2.7 and 53.0%. The minor allele frequencies of I128T and H297Q were 27.2 and 35.96%, respectively. Next, we analyzed associations between MTTP haplotypes (Table 1) or single SNPs (Table 2) with BMI, waist circumference and total cholesterol by linear regression analysis. Gender-stratified statistics were also done.

As shown in Table 1, haplotype VII showed a significant decrease of -0.636 (95% CI: $-1.226, -0.046$; $p = 0.035$) BMI units in females but not in males in comparison to the major haplotype I. Other haplotypes were not significantly associated with BMI. With the exception of H297Q, we found no appreciable association of BMI, waist circumference and cholesterol levels with single MTTP SNPs. Compared with homozygous H-carriers (H297H) for the major allele of the MTTP H297Q polymorphism, homozygous Q297Q carriers showed a significant decrease in BMI of -0.425 BMI units (95% CI: $-0.74, -0.12$; $p = 0.007$) and in waist circumference of -0.990 cm (95% CI: $1.74, -0.24$; $p = 0.01$) in the whole study group (Table 2). Carriers of the minor allele of MTTP H297Q SNP showed a significant reduction in BMI of -0.183 BMI unit (95% CI: $-0.33, -0.04$; $p = 0.012$) and waist circumference of

Table 1
Associations of MTTP haplotypes with BMI as continuous variable

| Haplotypes | Frequencies | | | | Unit change in BMI in kg/m^2 [95% confidence interval] (<i>p</i> values) | | |
|-----------------|-------------|---------|-----------|-----------|---|--------------------------------------|--|
| | All (%) | Men (%) | Women (%) | | All ^a | Men ^b | Women ^b |
| I, 212212112 | 53.0 | 53.7 | 52.3 | | | | |
| II, 212112212 | 13.5 | 13.3 | 13.7 | I vs II | -0.143 [$-0.362, 0.077$] (0.204) | -0.023 [$-0.248, 0.293$] (0.87) | -0.305 [$-0.624, 0.014$] (0.061) |
| III, 121112112 | 11.0 | 10.9 | 11.1 | I vs III | 0.144 [$-0.092, 0.379$] (0.232) | 0.050 [$-0.237, 0.337$] (0.733) | 0.265 [$-0.084, 0.614$] (0.136) |
| IV, 221122221 | 5.9 | 5.8 | 5.9 | I vs IV | -0.090 [$-0.402, 0.221$] (0.569) | -0.044 [$-0.429, 0.342$] (0.825) | -0.168 [$-0.627, 0.291$] (0.472) |
| V, 121112221 | 3.8 | 3.7 | 3.9 | I vs V | -0.275 [$-0.65, 0.11$] (0.151) | -0.172 [$-0.642, 0.298$] (0.473) | -0.299 [$-0.840, 0.242$] (0.278) |
| VI, 221122222 | 3.2 | 3.2 | 3.1 | I vs VI | 0.009 [$-0.403, 0.420$] (0.967) | -0.134 [$-0.631, 0.363$] (0.596) | 0.156 [$-0.426, 0.738$] (0.598) |
| VII, 222111212 | 3.1 | 2.9 | 3.3 | I vs VII | -0.379 [$-0.794, 0.036$] (0.073) | -0.077 [$-0.595, 0.442$] (0.771) | -0.636 [$-1.226, -0.046$] (0.035) |
| VIII, 222112212 | 2.8 | 2.7 | 2.9 | I vs VIII | -0.106 [$-0.54, 0.328$] (0.631) | -0.096 [$-0.629, 0.438$] (0.725) | -0.114 [$-0.709, 0.481$] (0.708) |
| IX, 122111212 | 2.7 | 2.7 | 2.7 | I vs IX | -0.33 [$-0.772, 0.113$] (0.144) | -0.462 [$-1.002, 0.078$] (0.094) | -0.221 [$-0.804, 0.362$] (0.458) |

Results are the beta estimate (linear regression) with 95% confidence interval and *p* values. Haplotype designation: the allele with the higher prevalence is denoted with a, the minor allele with b. The order of polymorphisms corresponds to their position in the 5' to 3' direction of the gene: rs1503777, rs3811800, rs3816873 (I128T), rs105763, rs2035816, rs982424, rs2306985 (H297Q), rs2903202, rs1491244. The main results are in bold.

Table 2

Associations of MTTP H297Q genotypes with BMI, waist circumference and total cholesterol as continuous variable

| Genotypes | Frequencies | | | Unit change in BMI in kg/m ² [95% confidence interval] (p values) | | |
|--------------------------|-------------|--------|----------|--|-----------------------------|--------------------------------------|
| | All(n) | Men(n) | Women(n) | All | Men | Women |
| <i>BMI</i> | | | | | | |
| HH | 3115 | 1585 | 1530 | | | |
| HQ | 3481 | 1716 | 1765 | −0.106 [−0.32, 0.1] (0.32) | −0.143 [−0.4, 0.11] (0.27) | −0.072 [−0.4, 0.26] (0.67) |
| QQ | 986 | 479 | 507 | −0.425 [−0.74, −0.12] (0.007) | −0.200 [−0.58, 0.18] (0.31) | −0.657 [−1.14, −0.18] (0.007) |
| Q ^a | 4467 | 2195 | 2295 | −0.183 [−0.33, −0.04] (0.012) | −0.112 [−0.29, 0.06] (0.21) | −0.259 [−0.48, −0.04] (0.023) |
| <i>Waist</i> | | | | | | |
| HH | 3120 | 1589 | 1531 | | | |
| HQ | 3488 | 1720 | 1768 | −0.334 [−0.84, 0.17] (0.20) | −0.162 [−0.83, 0.51] (0.64) | −0.509 [−1.27, 0.25] (0.19) |
| QQ | 989 | 483 | 506 | −0.990 [−1.74, −0.24] (0.01) | −0.561 [−1.57, 0.44] (0.27) | −1.437 [−2.55, −0.32] (0.01) |
| Q ^a | 4477 | 2203 | 2274 | −0.450 [−0.8, −0.1] (0.01) | −0.246 [−0.71, 0.22] (0.30) | −0.662 [−1.18, −0.14] (0.01) |
| <i>Total cholesterol</i> | | | | | | |
| HH | 3132 | 1590 | 1542 | | | |
| HQ | 3507 | 1723 | 1784 | −0.007 [−0.06, 0.04] (0.78) | 0.03 [−0.05, 0.11] (0.45) | −0.046 [−0.11, 0.02] (0.21) |
| QQ | 994 | 484 | 510 | −0.103 [−0.18, −0.03] (0.01) | −0.103 [−0.22, 0.01] (0.08) | −0.111 [−0.21, −0.01] (0.03) |
| Q ^a | 4501 | 2207 | 2294 | −0.039 [−0.07, 0] (0.03) | −0.028 [−0.08, 0.02] (0.30) | −0.052 [−0.1, −0.01] (0.03) |

Results are the beta estimate (linear regression) with 95% confidence interval and p values. The main results are in bold.

^a additive model.

−0.45 cm (95% CI: 0.8, −0.1; p = 0.01). Gender stratified statistics revealed a significant reduction of −0.657 BMI units (95% CI: −1.14, −0.18; p = 0.007) and waist circumference of −1.437 cm (95% CI: −2.55, −0.32; p = 0.01) for females homozygous for the Q297Q polymorphism. Females carrying the Q-allele showed a decrease of −0.259 BMI unit (95% CI: −0.48, −0.04; p = 0.023) and waist circumference of −0.662 cm (95% CI: −1.18, −0.14; p = 0.01). These associations were not observed in males.

Association of total cholesterol with the Q-allele showed a reduction of −0.0391 mmol/l (95% CI: −0.07, 0; p = 0.03) (Table 2). Homozygous carriers displayed a total cholesterol reduction of −0.103 mmol/l (95% CI: −0.18, −0.03; p = 0.01). After stratification for gender, female but not male Q-allele carrier had a −0.052 mmol/l (95% CI: −0.1, −0.01; p = 0.03) lower total cholesterol. Female homozygous carriers exhibited a total cholesterol reduction of −0.111 mmol/l (95% CI: −0.21, −0.01; p = 0.03). No association between the H297Q polymorphism and HDL- or LDL-cholesterol was observed (data not shown).

Discussion

MTTP is a key regulator of chylomicron and VLDL assembly and secretion in the intestine and in liver. Loss of function mutations in the MTTP gene lead to a truncated protein and cause abetalipoproteinemia [26], fat malabsorption [27], hypercholesterolemia [6] and hepatic steatosis [28]. Functional studies of MTTP promoter haplotypes comprising SNPs −493G > T (rs1800591), −400A > T (rs1800803) and −164T > C (rs1800804) revealed two fold lower activity of the major haplotype −493G/−400A/−164T in comparison to the minor haplotype −493T/−400T/−164C [4]. Further, the major allele of MTTP I128T confers increased functionality of the protein [29]. The functional promoter and I128T polymorphisms are in complete linkage disequilibrium: Therefore, the resulting two functional MTTP haplotypes A and B contain combinations of a high (low) promoter activity and low (high) protein functionality. The overall consequences of this opposite effects are not known. However, studies of polymorphism −493G > T which covered the two functional haplotypes showed positive, negative, or no associations with traits of the metabolic syndrome [3,5–14].

Here we analyzed seven htSNPs as well as two common cSNP in the MTTP gene for associations with BMI, waist circumference, and total cholesterol in a large population based study cohort comprising 7582 participants [24,25]. The selected SNPs cover a 52 kb MTTP gene region and contain the functional haplotypes as well

as cSNP H297Q. We found no association between BMI, waist circumference, or total cholesterol and I128T which represent the functional haplotypes A and B. Our finding supports the idea that the overall effects of these haplotypes are neutral. To our surprise, the largely unnoted cSNP H297Q [3] showed association with BMI, waist circumference and total cholesterol, whereupon the minor Q-allele carrier showed a general reducing effect. Thus, it seems to be fruitful to reanalyse published results as shown for the association between MTTP H297Q SNP and traits of the metabolic syndrome. An exchange of His to Gln at position 297 results in a change of a weakly basic to a neutral side chain making this side more hydrophobic. Amino acid residue 297 is located in a domain relevant for lipid binding, suggesting functionality of H297Q SNP. Of course, functional studies are necessary to test this hypothesis.

A direct link between MTTP functionality and BMI or waist circumference is not apparent. However an interaction with total cholesterol is plausible, since MTTP is relevant for chylomicron and VLDL maturation via apoB binding. Accordingly, involvement of the MTTP gene in the development of fat malabsorption, hepatic steatosis and insulin resistance were demonstrated in patients with loss of function mutations in the MTTP gene [3,27] as well as in MTTP knock-out mice [28,30]. Associations with the MTTP H297Q polymorphism were only found in females. A sex-specific response of the MTTP −493G > T to dietary lipid changes was described recently [31]. MTTP and apoB are building a complex, therefore protein interactions have to be considered. It was shown that apoB mRNA and protein levels are higher in females [32,33]. Accordingly, altered MTTP activity by H297Q polymorphism may have more pronounced effects in females than in males resulting in a stronger phenotype change.

In conclusion, our association analysis in a large population based study cohort provides evidence that the minor allele of the MTTP H297Q polymorphism is associated with lower BMI, waist circumference and total cholesterol in females but not in males.

References

- [1] P. Bradbury, C.J. Mann, S. Kochl, T.A. Anderson, S.A. Chester, J.M. Hancock, P.J. Ritchie, J. Amey, G.B. Harrison, D.G. Levitt, L.J. Banaszak, J. Scott, C.C. Shoulders, A common binding site on the microsomal triglyceride transfer protein for apolipoprotein B and protein disulfide isomerase, *J. Biol. Chem.* 274 (1999) 3159–3164.
- [2] H. Hirokane, M. Nakahara, S. Tachibana, M. Shimizu, R. Sato, Bile acid reduces the secretion of very low density lipoprotein by repressing microsomal triglyceride transfer protein gene expression mediated by hepatocyte nuclear factor-4, *J. Biol. Chem.* 279 (2004) 45685–45692.

- [3] H. Ledmyr, F. Karpe, B. Lundahl, M. McKinnon, C. Skoglund-Andersson, E. Ehrenborg, Variants of the microsomal triglyceride transfer protein gene are associated with plasma cholesterol levels and body mass index, *J. Lipid. Res.* 43 (2002) 51–58.
- [4] D. Rubin, A. Schneider-Muntau, M. Klapper, I. Nitz, U. Helwig, U.R. Folsch, J. Schrezenmeir, F. Doring, Functional analysis of promoter variants in the microsomal triglyceride transfer protein (MTP) gene, *Hum. Mutat.* (2007).
- [5] F. Karpe, B. Lundahl, E. Ehrenborg, P. Eriksson, A. Hamsten, A common functional polymorphism in the promoter region of the microsomal triglyceride transfer protein gene influences plasma LDL levels, *Arterioscler. Thromb. Vasc. Biol.* 18 (1998) 756–761.
- [6] L. Bjorn, T.P. Leren, L. Ose, A. Hamsten, F. Karpe, A functional polymorphism in the promoter region of the microsomal triglyceride transfer protein (MTP -493G/T) influences lipoprotein phenotype in familial hypercholesterolemia, *Arterioscler. Thromb. Vasc. Biol.* 20 (2000) 1784–1788.
- [7] S. Bernard, S. Touzet, I. Personne, V. Lapras, P.J. Bondon, F. Berthezene, P. Moulin, Association between microsomal triglyceride transfer protein gene polymorphism and the biological features of liver steatosis in patients with type II diabetes, *Diabetologia* 43 (2000) 995–999.
- [8] J. St-Pierre, I. Lemieux, I. Miller-Felix, D. Prud'homme, J. Bergeron, D. Gaudet, A. Nadeau, J.P. Despres, M.C. Vohl, Visceral obesity and hyperinsulinemia modulate the impact of the microsomal triglyceride transfer protein -493G/T polymorphism on plasma lipoprotein levels in men, *Atherosclerosis* 160 (2002) 317–324.
- [9] H. Ledmyr, A.D. McMahon, E. Ehrenborg, L.B. Nielsen, M. Neville, H. Lithell, P.W. MacFarlane, C.J. Packard, F. Karpe, The microsomal triglyceride transfer protein gene-493T variant lowers cholesterol but increases the risk of coronary heart disease, *Circulation* 109 (2004) 2279–2284.
- [10] C. Phillips, K. Mullan, D. Owens, G.H. Tomkin, Microsomal triglyceride transfer protein polymorphisms and lipoprotein levels in type 2 diabetes, *Qjm* 97 (2004) 211–218.
- [11] A.B. Garcia-Garcia, C. Gonzalez, J.T. Real, J.J. Martin de Llano, V. Gonzalez-Albert, M. Civera, F.J. Chaves, J.F. Ascaso, R. Carmena, Influence of microsomal triglyceride transfer protein promoter polymorphism -493 GT on fasting plasma triglyceride values and interaction with treatment response to atorvastatin in subjects with heterozygous familial hypercholesterolaemia, *Pharmacogenet. Genomics* 15 (2005) 211–218.
- [12] Y. Yamada, F. Ando, H. Shimokata, Association of a microsomal triglyceride transfer protein gene polymorphism with blood pressure in Japanese women, *Int. J. Mol. Med.* 17 (2006) 83–88.
- [13] D. Rubin, U. Helwig, M. Pfeuffer, S. Schreiber, H. Boeing, E. Fisher, A. Pfeiffer, S. Freitag-Wolf, U.R. Folsch, F. Doring, J. Schrezenmeir, A common functional exon polymorphism in the microsomal triglyceride transfer protein gene is associated with type 2 diabetes impaired glucose metabolism and insulin levels, *J. Hum. Genet.* 51 (2006) 567–574.
- [14] B. Lundahl, C. Skoglund-Andersson, M. Caslake, D. Bedford, P. Stewart, A. Hamsten, C.J. Packard, F. Karpe, Microsomal triglyceride transfer protein -493T variant reduces IDL plus LDL apoB production and the plasma concentration of large LDL particles, *Am. J. Physiol. Endocrinol. Metab.* 290 (2006) E739–745.
- [15] S. Stan, M. Lambert, E. Delvin, G. Paradis, J. O'Loughlin, J.A. Hanley, E. Levy, Intestinal fatty acid binding protein and microsomal triglyceride transfer protein polymorphisms in French-Canadian youth, *J. Lipid. Res.* 46 (2005) 320–327.
- [16] S.M. Herrmann, O. Poirier, V. Nicaud, A. Evans, J.B. Ruidavets, G. Luc, D. Arveiler, C. Bao-Sheng, F. Cambien, Identification of two polymorphisms in the promoter of the microsomal triglyceride transfer protein (MTP) gene: lack of association with lipoprotein profiles, *J. Lipid. Res.* 39 (1998) 2432–2435.
- [17] P. Couture, J.D. Otvos, L.A. Cupples, P.W. Wilson, E.J. Schaefer, J.M. Ordovas, Absence of association between genetic variation in the promoter of the microsomal triglyceride transfer protein gene and plasma lipoproteins in the Framingham Offspring Study, *Atherosclerosis* 148 (2000) 337–343.
- [18] M.T. Berthier, A. Houde, A.M. Paradis, P. Couture, D. Gaudet, J.P. Despres, M.C. Vohl, Molecular screening of the microsomal triglyceride transfer protein: association between polymorphisms and both abdominal obesity and plasma apolipoprotein B concentration, *J. Hum. Genet.* 49 (2004) 684–690.
- [19] S.H. Juo, Z. Han, J.D. Smith, L. Colangelo, K. Liu, Common polymorphism in promoter of microsomal triglyceride transfer protein gene influences cholesterol, ApoB, and triglyceride levels in young african american men: results from the coronary artery risk development in young adults (CARDIA) study, *Arterioscler. Thromb. Vasc. Biol.* 20 (2000) 1316–1322.
- [20] B. Lundahl, A. Hamsten, F. Karpe, Postprandial plasma ApoB-48 levels are influenced by a polymorphism in the promoter of the microsomal triglyceride transfer protein gene, *Arterioscler. Thromb. Vasc. Biol.* 22 (2002) 289–293.
- [21] L. Chen, G. Yoshino, E. Maeda, S. Zeng, Effect of microsomal triglyceride transfer protein gene polymorphism in the promoter region on dyslipidemia in type 2 diabetic subjects, *Chin. Med. J.(Engl)* 116 (2003) 215–217.
- [22] R.S. Li, R.X. Yin, W.X. Lin, D.Z. Yang, [Relationship between the polymorphism of microsomal triglyceride transfer protein gene and the level of serum lipids in Guangxi Heiyi Zhuang population], *Zhonghua Yi Xue Za Zhi* 85 (2005) 2492–2496.
- [23] J.C. Barrett, B. Fry, J. Maller, M.J. Daly, Haploview: analysis and visualization of LD and haplotype maps, *Bioinformatics* 21 (2005) 263–265.
- [24] I.M. Heid, C. Vollmert, A. Hinney, A. Doring, F. Geller, H. Lowel, H.E. Wichmann, T. Illig, J. Hebebrand, F. Kronenberg, Association of the 1031 MC4R allele with decreased body mass in 7937 participants of two population based surveys, *J. Med. Genet.* 42 (2005) e21.
- [25] I.M. Heid, C. Vollmert, F. Kronenberg, C. Huth, D.P. Ankerst, A. Luchner, A. Hinney, G. Bronner, H.E. Wichmann, T. Illig, A. Doring, J. Hebebrand, Association of the MC4R V103I polymorphism with the metabolic syndrome: the KORA Study, *Obesity* 16 (2008) 369–376. Silver Spring.
- [26] E. Di Leo, S. Lancellotti, J.Y. Penacchioni, A.B. Cefalu, M. Averna, L. Pisciotto, S. Bertolini, S. Calandra, C. Gabelli, P. Tarugi, Mutations in MTP gene in abeta- and hypobeta-lipoproteinemia, *Atherosclerosis* 180 (2005) 311–318.
- [27] R. Vongsuvan, A.J. Hooper, J.C. Coakley, J.S. Macdessi, E.V. O'Loughlin, J.R. Burnett, K.J. Gaskin, Novel mutations in abetalipoproteinaemia and homozygous familial hypobetalipoproteinaemia, *J. Inherit. Metab. Dis.* 30 (2007) 990.
- [28] M. Raabe, M.M. Veniant, M.A. Sullivan, C.H. Zlot, J. Bjorkegren, L.B. Nielsen, J.S. Wong, R.L. Hamilton, S.G. Young, Analysis of the role of microsomal triglyceride transfer protein in the liver of tissue-specific knockout mice, *J. Clin. Invest.* 103 (1999) 1287–1298.
- [29] H. Ledmyr, L. Ottosson, M. Sunnerhagen, E. Ehrenborg, The Ile128Thr polymorphism influences stability and ligand binding properties of the microsomal triglyceride transfer protein, *J. Lipid. Res.* 47 (2006) 1378–1385.
- [30] Y. Xie, E.P. Newberry, S.G. Young, S. Robine, R.L. Hamilton, J.S. Wong, J. Luo, S. Kennedy, N.O. Davidson, Compensatory increase in hepatic lipogenesis in mice with conditional intestine-specific Mtp deficiency, *J. Biol. Chem.* 281 (2006) 4075–4086.
- [31] M. Gastaldi, S. Diziere, C. Defoort, H. Portugal, D. Lairon, M. Darmon, R. Planells, Sex-specific association of fatty acid binding protein 2 and microsomal triacylglycerol transfer protein variants with response to dietary lipid changes in the 3-mo Medi-RIVAGE primary intervention study, *Am. J. Clin. Nutr.* 86 (2007) 1633–1641.
- [32] C. Ameen, J. Oscarsson, Sex difference in hepatic microsomal triglyceride transfer protein expression is determined by the growth hormone secretory pattern in the rat, *Endocrinology* 144 (2003) 3914–3921.
- [33] J.R. Ruiz, F.B. Ortega, L.A. Moreno, J. Warnberg, M. Gonzalez-Gross, M.D. Cano, A. Gutierrez, M.J. Castillo, Reference values for serum lipids and lipoproteins in Spanish adolescents: the AVENA study, *Soz. Präventivmed* 51 (2006) 99–109.

Genetic Testing

Genetic Testing: <http://mc.manuscriptcentral.com/genetic-testing>

Association analysis between the PTGES2 R298H polymorphism and body mass index in 8079 participants of the KORA study cohort

| | |
|-------------------------------|---|
| Journal: | Genetic Testing |
| Manuscript ID: | GTE-2008-0111 |
| Manuscript Type: | Original Articles |
| Date Submitted by the Author: | 22-Sep-2008 |
| Complete List of Authors: | Fischer, Alexandra; Institute of Nutrition and Food Science, Molecular Nutrition Grallert, Harald; Institute of Epidemiology Böhme, Mike; Institute of Nutrition and Food Science, Molecular Nutrition Gieger, Christan; Institute of Epidemiology Boomgaarden, Inka; Institute of Nutrition and Food Science, Molecular Nutrition Heid, Iris; Institute of Epidemiology Wichmann, H.-.; Institute of Epidemiology Döring, Frank; Institute of Nutrition and Food Science, Molecular Nutrition Illig, Thomas; Institute of Epidemiology |
| Keyword: | Genetic Testing, Human Genetics, Metabolic, Mutation Detection |
| | |

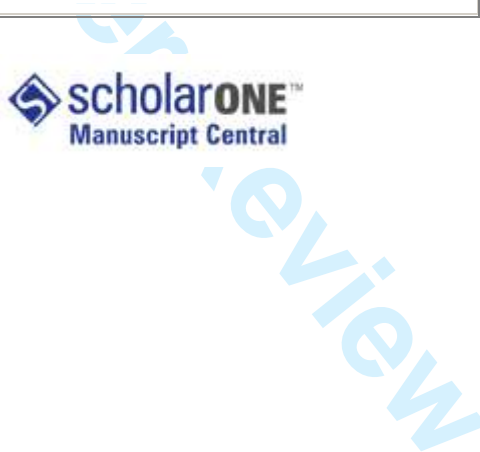

Fischer et al. PTGES2 R298H and BMI

Association analysis between the PTGES2 R298H polymorphism and body mass index in 8079 participants of the KORA study cohort

Alexandra Fischer¹, Harald Grallert², Mike Böhme¹, Christian Gieger², Inka Boomgaarden¹, Iris Heid², H.-Erich Wichmann², Frank Döring¹, Thomas Illig²

¹Institute of Human Nutrition and Food Science, Molecular Nutrition, Christian-Albrecht-University, Kiel, Germany

²Institute of Epidemiology, German Research Centre for Environmental Health, Helmholtz Centre Munich, Germany

Running Title: PTGES2 R298H and BMI

Keywords: PTGES2 gene; non-synonymous polymorphism; KORA; BMI

Correspondence:

Prof. Dr. Frank Döring, Molecular Nutrition, Institute for Human Nutrition and Food Science, University of Kiel, Heinrich-Hecht-Platz 10, 24118 Kiel, Germany; E-mail: sek@molnut.uni-kiel.de, Tel: +49-431-880-5657 Fax: +49-431-880-5658

Abbreviations: PTGES2: Prostaglandin E2 Synthase 2; htSNPs: Haplotype Single Nucleotide Polymorphisms; KORA: Kooperative Gesundheitsforschung in der Region Augsburg; BMI: Body Mass Index; PGE₂: Prostaglandin E₂; WHO MONICA: multinational MONItoring of trends and determinants in Cardiovascular disease; PPAR γ : peroxisome proliferator-activated receptor gamma

Fischer et al. PTGES2 R298H and BMI

Abstract

Context: The H-allele of the R298H polymorphism in the Prostaglandin E Synthase 2 (PTGES2) gene was associated with lower risk of diabetes type 2.

Aim: In order to explore the association between the PTGES2 R298H SNP and BMI, we analysed the R298H SNP (rs13283456) and three htSNPs (rs884115, rs10987883, rs4837240) covering a 20 kb gene region in population based surveys of the KORA study cohort with 8079 participants.

Results: A statistically significant difference in BMI between the heterozygous PTGES2 R298H genotype and the homozygous R/R genotype was found in males but not in females. Males with the R/H genotype showed a decrease in BMI of -0.30 BMI units (95% CI: -0.55, -0.04, $p=0.02$) in comparison to R/R males. A haplotype comprising the minor allele of PTGES2 R298H showed a significant decrease of -0.23 BMI units in males (-0.45, -0.02; $p=0.04$) but not in females. Other haplotypes and single htSNPs were not significantly associated with BMI.

Conclusion: We found a marginal but significant influence of the PTGES2 298H SNP on BMI in a large population based study.

Fischer et al. PTGES2 R298H and BMI

Introduction

Prostaglandin E₂ (PGE₂) is produced in diverse tissues and is involved in a number of biological processes including inhibition of lipolysis, induction of hypertrophy of adipose tissue and leptin secretion (Gaskins et al. 1989; Fain et al. 2001; Serhan and Levy 2003; Murakami and Kudo 2004). PGE₂ is synthesized by PGE₂ synthases (PTGES) in concert with phospholipase A₂ and cyclooxygenases. Three PTGES isoforms are known. The microsomal PTGES (PTGES1) is mainly involved in inflammation, whereas the role of the cytosolic PTGES is uncertain (Gaskins et al. 1989; Murakami and Kudo 2004). The membrane-associated PTGES2 is mainly expressed in tissues such as adipocytes with low PTGES1 levels and is not inducible by inflammation (Tanikawa et al. 2002). The PTGES2 (NM_025072) gene maps to the chromosomal band 9q34.11, which was significantly associated with body weight (Wilson et al. 1991). Recently, we showed in three independent study populations that the PTGES2 R298H (rs13283456) polymorphism is associated with type 2 diabetes and related traits (Fisher et al. 2007; Lindner et al. 2007; Nitz et al. 2007). Whether the rare H-allele contributes to body mass index (BMI) remained questionable. Therefore, we analyzed the PTGES2 R298H SNP with BMI in large (n=8079) populations based surveys (S3, S4) of the KORA study cohort.

Material and Methods

Study population

In the Southern German region of Augsburg including the city of Augsburg and the two surrounding counties, population-based surveys of the 25-74 year old population in groups of age range of 5 years were implemented in 1984 as part of the WHO MONICA (multinational MONItoring of trends and determinants in Cardiovascular disease) project and continued since 1996 within the KORA (Kooperative Gesundheitsforschung in der Region Augsburg) platform. The aims of the surveys were to describe the prevalence of common diseases and their risk factors in a representative sample of the adult general population. The current study included the survey of the years 1994-1995 (MONICA S3) including 4856 participants and the survey of the years 1999-2001 (KORA S4) including 4261

1 Fischer et al. PTGES2 R298H and BMI

2
3 participants yielding 9117 recruited participants. The study population of S3 and S4 consisted of all
4
5 German residents of the Augsburg region who were born between 1920 and 1975 identified through
6
7 the public record office. More than 99.5% of the participants were Caucasian. The high standards of
8
9 the WHO MONICA project applied to both surveys. All study participants underwent a standardized
10
11 interview, a physical examination, and blood withdrawal by trained staff and signed a consent form of
12
13 the Bavarian Ethics committee and the Ethics committee of the University of Munich. For
14
15 determination of body weight and height, participants were asked to remove shoes and heavy
16
17 clothing. The weight measurements were done with a calibrated body weight scale (SECA 709) and
18
19 were carried out with an accuracy of 0.1 kg. The body height was read to the nearest 0.5 cm on a body
20
21 height scale. BMI (kg/m²) was calculated as weight in kilograms divided by height in square meters.
22
23 The pooled data analysis included 8079 individuals with complete information on age, sex, BMI and
24
25 genotypes. There was no overlap between the two surveys by design.
26
27
28
29
30

31 **Genotyping**

32
33 Genotyping was performed using a MALDI TOF MS system (Sequenom, Mass EXTEND, San
34
35 Diego, USA). Sequence information of the *PTGES2* gene (ID: 80142) was derived from Genbank
36
37 (www.ncbi.nlm.nih.gov). As described (Nitz et al. 2007), the R298H SNP (rs13283456) was
38
39 identified by re-sequencing and htSNPs were selected by analysing a 20 kb region comprising
40
41 *PTGES2* (Chrom 9: pos. 127.952.200-127.972.200) using Haploview 3.2. HtSNPs with a minor allele
42
43 frequency >0.1 (rs10987883, rs4837240, rs884115) were obtained from CEPH HapMap data release
44
45 21 (www.hapmap.org). Sequences of primers and assay probes are available on request.
46
47
48
49

50 **Statistical methods**

51
52 We used a linear regression model with BMI as continuous outcome for both studies combined; the
53
54 unit change in BMI by the DNA variants was estimated. Haplotype analysis was carried out with the
55
56 statistical software R (V. 2.3.1. including haplo.stats package) using the haplo.glm procedure. This
57
58 procedure performs an iterative two-step Estimation-Maximization (EM)-algorithm, with the posterior
59
60 probabilities of pairs of haplotypes per subject used as weights to update the regression coefficients,

1 Fischer et al. PTGES2 R298H and BMI

2
3 and the regression coefficients used to update the posterior probabilities. Haplotypes were included
4
5 into the regression model all at once except the most common haplotype. Using the expected number
6
7 of copies of haplotype implies an additive model for each haplotype.
8
9

10 11 12 13 14 **Results**

15
16 A total of 8079 subjects of the KORA study cohort (S3, S4) were genotyped for the PTGES2 R298H
17
18 SNP. Three htSNPs (rs884115, rs10987883, rs4837240) covering a 20 kb region of the PTGES2 gene
19
20 were also genotyped. The participants were 25-74 years of age, approximately half were male and the
21
22 range of BMI was 14-57 kg/m². More details of the study cohort were described elsewhere (Heid et al.
23
24 2005). Gender-stratified statistics of the BMI and their associations to the PTGES2 R298H SNP as
25
26 well as haplotypes are provided in table 1. For the three htSNPs, we found no significant associations
27
28 to BMI (not shown). In females, no significant association between PTGES2 genotypes and BMI was
29
30 observed. We found a statistically significant difference in BMI between heterozygous PTGES2
31
32 R298H males and males homozygous for the major allele (R/R). R/H males showed a decrease in
33
34 BMI of -0.30 BMI units (95% CI: -0.55, -0.04, p= 0.02) in comparison to R/R males. This result was
35
36 congruent with the association between BMI and haplotype II, which covered the minor allele of
37
38 R298H. This haplotype showed a significant decrease of -0.19 BMI units (-0.37, -0.01; p=0.04) for
39
40 the whole study population and -0.23 BMI units (-0.45, -0.02; p=0.04) in males. There was no
41
42 association with haplotypes detected in females. Other haplotypes were not significantly associated
43
44 with BMI. Further, no linkage of the R298H polymorphism with obesity status (BMI>30) or waist to
45
46 hip ratio was observed (not shown).
47
48
49
50
51
52
53
54

55 **Discussion**

56
57 The metabolite of PTGES2 PGE₂ possesses anti-lipolytic activity, induces hypertrophy in adipose
58
59 tissue and is involved in secretion of leptin (Richelsen 1987; Gaskins et al. 1989; Richelsen 1991;
60
Richelsen et al. 1991; Fain et al. 2000; Fain et al. 2001; Serhan and Levy 2003; Murakami and Kudo

1 Fischer et al. PTGES2 R298H and BMI

2
3 2004). These characteristics, the linkage of the 9q34.11 PTGES2 gene region with body weight
4
5 (Wilson et al. 1991) and the association between PTGES2 R298H SNP and traits of the metabolic
6
7 syndrome (Fisher et al. 2007; Lindner et al. 2007; Nitz et al. 2007) raise the PTGES2 gene as a
8
9 candidate gene for obesity. On the other hand, genome-wide association studies did not ennoble
10
11 PTGES2 as a prime candidate for obesity (Herbert et al. 2006; Frayling et al. 2007; Scuteri et al.
12
13 2007; Liu et al. 2008). In order to unravel the influence of genetic variance of PTGES2 on body
14
15 weight, we used a large population based study cohort comprising 8079 participants. Based on this
16
17 large association study, a reduced BMI of -0.30 BMI units was observed in males heterozygous for
18
19 the PTGES2 R298H SNP. A haplotype comprising the minor allele of R298H was also associated
20
21 with a reduced BMI. Thus, the PTGES2 298H allele leads to a slight reduction of the BMI in males. A
22
23 protective effect of the H-allele was also described for diabetes type 2, impaired glucose tolerance,
24
25 fasting and postprandial insulin levels and HOMA indices for β -cell function and insulin resistance
26
27 (Herbert et al. 2006; Frayling et al. 2007; Scuteri et al. 2007; Liu et al. 2008). The BMI lowering
28
29 effect of the His-allele was solely observed in heterozygous but not in homozygous males. Although
30
31 this specific association remain ambiguous, based on functional considerations suggestive hypotheses
32
33 can be formulated. We assumed that the heterozygous genotype leads to a slight reduction in overall
34
35 PTGES2 function causing a reduced PGE₂ level. This could result in a lower BMI, because PGE₂
36
37 possesses anti-lipolytic activity and induces adipocyte hypertrophy (Richelsen 1987; Richelsen 1991;
38
39 Richelsen et al. 1991). An even stronger reduction of PGE₂ levels in homozygous carriers of the
40
41 PTGES2 298H allele may induces compensatory up-regulation of other PTGES2 enzymes. The
42
43 reason for a specific protection of the PTGES2 298H allele in males might be caused by gender-
44
45 specific PGE₂ levels which might be regulation by transcriptional repression of PTGES genes via
46
47 PPAR γ (Mendez and LaPointe 2003) since PPAR γ is regulated in a sex specific manner (Ciana et al.
48
49 2007). However, this polymorphism has only a small impact on overall BMI status, although, the H-
50
51 allele may contribute to a risk-reduction of diabetes type 2 and related traits.
52
53

54 In future functional studies it would be interesting to analyse the gender specific connections between
55
56 lipolysis, BMI and the PTGES2 R298H. In conclusion, our results in a large population based study
57
58 cohort provide evidence that the PTGES2 298H allele is associated with lower BMI.
59
60

Fischer et al. PTGES2 R298H and BMI

Acknowledgement

This work was financially supported by the BMBF Project “Fat and Metabolism – gene variations, gene regulation and gene function” (AZ 0312823B).

Author Disclosure Statement

There is no conflict of interest that any author should disclose. A. F. was responsible for collecting and evaluation of the data, genotyping and writing various parts of the manuscript. H.G., M.B., C.G., I.B. and I.H. were involved in data collection and data management. H.-E. W., F.D. and T.I. were the principle investigators, responsible for the study design and assisted in manuscript preparation. No competing financial interests exist.

Fischer et al. PTGES2 R298H and BMI

References

- Ciana P, Biserni A, Tatangelo L, Tiveron C, Sciarroni AF, Ottobrini L, Maggi A (2007) A novel peroxisome proliferator-activated receptor responsive element-luciferase reporter mouse reveals gender specificity of peroxisome proliferator-activated receptor activity in liver. *Mol Endocrinol* 21:388-400
- Fain JN, Leffler CW, Bahouth SW, Rice AM, Rivkees SA (2000) Regulation of leptin release and lipolysis by PGE2 in rat adipose tissue. *Prostaglandins Other Lipid Mediat* 62:343-350
- Fain JN, Leffler CW, Cowan GS, Jr., Buffington C, Pouncey L, Bahouth SW (2001) Stimulation of leptin release by arachidonic acid and prostaglandin E(2) in adipose tissue from obese humans. *Metabolism* 50:921-928
- Fisher E, Nitz I, Lindner I, Rubin D, Boeing H, Mohlig M, Hampe J, Schreiber S, Schrezenmeir J, Doring F (2007) Candidate gene association study of type 2 diabetes in a nested case-control study of the EPIC-Potsdam cohort - role of fat assimilation. *Mol Nutr Food Res* 51:185-191
- Frayling TM, Timpson NJ, Weedon MN, Zeggini E, Freathy RM, Lindgren CM, Perry JR, et al. (2007) A common variant in the FTO gene is associated with body mass index and predisposes to childhood and adult obesity. *Science* 316:889-894
- Gaskins HR, Hausman DB, Martin RJ, Hausman GJ (1989) Evidence for abnormal prostaglandin synthesis in obese Zucker rat adipose cell cultures. *J Nutr* 119:458-462
- Heid IM, Vollmert C, Hinney A, Doring A, Geller F, Lowel H, Wichmann HE, Illig T, Hebebrand J, Kronenberg F (2005) Association of the 103I MC4R allele with decreased body mass in 7937 participants of two population based surveys. *J Med Genet* 42:e21
- Herbert A, Gerry NP, McQueen MB, Heid IM, Pfeufer A, Illig T, Wichmann HE, Meitinger T, Hunter D, Hu FB, Colditz G, Hinney A, Hebebrand J, Koberwitz K, Zhu X, Cooper R, Ardlie K, Lyon H, Hirschhorn JN, Laird NM, Lenburg ME, Lange C, Christman MF (2006) A common genetic variant is associated with adult and childhood obesity. *Science* 312:279-283

1 Fischer et al. PTGES2 R298H and BMI

2 Lindner I, Helwig U, Rubin D, Fischer A, Marten B, Schreiber S, Doring F, Schrezenmeir J (2007)

3
4 Prostaglandin E synthase 2 (PTGES2) Arg298His polymorphism and parameters of the metabolic
5
6 syndrome. *Mol Nutr Food Res* 51:1447-1451

7
8 Liu YJ, Liu XG, Wang L, Dina C, Yan H, Liu JF, Levy S, Papasian CJ, Drees BM, Hamilton JJ,
9
10 Meyre D, Delplanque J, Pei YF, Zhang L, Recker RR, Froguel P, Deng HW (2008) Genome-wide
11
12 association scans identified CTNBL1 as a novel gene for obesity. *Hum Mol Genet*

13
14 Mendez M, LaPointe MC (2003) PPARgamma inhibition of cyclooxygenase-2, PGE2 synthase, and
15
16 inducible nitric oxide synthase in cardiac myocytes. *Hypertension* 42:844-850

17
18 Murakami M, Kudo I (2004) Recent advances in molecular biology and physiology of the
19
20 prostaglandin E2-biosynthetic pathway. *Prog Lipid Res* 43:3-35

21
22 Nitz I, Fisher E, Grallert H, Li Y, Gieger C, Rubin D, Boeing H, Spranger J, Lindner I, Schreiber S,
23
24 Rathmann W, Gohlke H, Doring A, Wichmann HE, Schrezenmeir J, Doring F, Illig T (2007)
25
26 Association of prostaglandin E synthase 2 (PTGES2) Arg298His polymorphism with type 2 diabetes
27
28 in two German study populations. *J Clin Endocrinol Metab* 92:3183-3188

29
30 Richelsen B (1987) Factors regulating the production of prostaglandin E2 and prostacyclin
31
32 (prostaglandin I2) in rat and human adipocytes. *Biochem J* 247:389-394

33
34 Richelsen B (1991) Prostaglandins in adipose tissue--with special reference to triglyceride
35
36 metabolism. *Dan Med Bull* 38:228-244

37
38 Richelsen B, Pedersen SB, Moller-Pedersen T, Bak JF (1991) Regional differences in triglyceride
39
40 breakdown in human adipose tissue: effects of catecholamines, insulin, and prostaglandin E2.
41
42 *Metabolism* 40:990-996

43
44 Scuteri A, Sanna S, Chen WM, Uda M, Albai G, Strait J, Najjar S, Nagaraja R, Orru M, Usala G, Dei
45
46 M, Lai S, Maschio A, Busonero F, Mulas A, Ehret GB, Fink AA, Weder AB, Cooper RS, Galan P,
47
48 Chakravarti A, Schlessinger D, Cao A, Lakatta E, Abecasis GR (2007) Genome-wide association scan
49
50 shows genetic variants in the FTO gene are associated with obesity-related traits. *PLoS Genet* 3:e115

51
52 Serhan CN, Levy B (2003) Success of prostaglandin E2 in structure-function is a challenge for
53
54 structure-based therapeutics. *Proc Natl Acad Sci U S A* 100:8609-8611

1 Fischer et al. PTGES2 R298H and BMI

2 Tanikawa N, Ohmiya Y, Ohkubo H, Hashimoto K, Kangawa K, Kojima M, Ito S, Watanabe K (2002)

3 Identification and characterization of a novel type of membrane-associated prostaglandin E synthase.

4 Biochem Biophys Res Commun 291:884-889

5 Wilson AF, Elston RC, Tran LD, Siervogel RM (1991) Use of the robust sib-pair method to screen for

6 single-locus, multiple-locus, and pleiotropic effects: application to traits related to hypertension. Am J

7 Hum Genet 48:862-872

8
9
10
11
12
13
14
15
16
17
18
19
20
21
22
23
24
25
26
27
28
29
30
31
32
33
34
35
36
37
38
39
40
41
42
43
44
45
46
47
48
49
50
51
52
53
54
55
56
57
58
59
60

For Peer Review

1 Fischer et al. PTGES2 R298H and BMI

2
3 Alexandra Fischer,

4
5 Tel: +49-431-880-5657 Fax: +49-431-880-5658, fischer@molnut.uni-kiel.de

6
7
8
9 Harald Grallert,

10
11 Tel: +49 89 3187 1195 Fax: +49 89 3187 4567, harald.grallert@helmholtz-muenchen.de

12
13
14
15 Mike Böhme,

16
17 Tel: +49-431-880-5657 Fax: +49-431-880-5658, mboehme@molnut.uni-kiel.de

18
19
20
21
22 Christian Gieger,

23
24 Tel: +49 (0)89/3187-4106 Fax: +49 (0)89/3187-3380, christian.gieger@helmholtz-muenchen.de

25
26
27
28
29 Inka Boomgaarden,

30
31 Tel: +49-431-880-5657 Fax: +49-431-880-5658, boomgaarden@molnut.uni-kiel.de

32
33
34
35 Iris Heid,

36
37 Tel: +49 (0)89/3187-3084 Fax: +49 (0)89/3187-3380, heid@helmholtz-muenchen.de

38
39
40
41
42 H.-Erich Wichmann,

43
44 Tel: +49 89 3187 4066 Fax: +49 89 3187 4499, wichmann@helmholtz-muenchen.de

45
46
47
48
49 Frank Döring,

50
51 Tel: +49-431-880-5657 Fax: +49-431-880-5658, sek@molnut.uni-kiel.de

52
53
54
55 Thomas Illig,

56
57 Tel: +49 (0)89/3187-4249 Fax: +49 (0)89/3187-4567, illig@helmholtz-muenchen.de

1 Fischer et al. PTGES2 R298H and BMI
2

3 Reviewer:
4
5
6
7
8

9 Kikuko Watanabe
10

11 Division of Life Science, Graduate School of Integrated Science and Art, University of East Asia, 2-1
12

13 Ichinomiyaakuen, Shimonoseki, Yamaguchi 751-8503, Japan
14

15 watanabe@toua-u.ac.jp
16
17
18
19

20 Robert Y. L. Zee
21

22 Laboratory of Genetic and Molecular Epidemiology, Center for Cardiovascular Disease Prevention, Brigham
23

24 and Women's Hospital, 900 Commonwealth Avenue East, Boston, MA 02215, USA
25

26 rzee@rics.bwh.harvard.edu
27
28
29
30

31 Francesca Bosetti
32

33 Brain Physiology and Metabolism Section, NIA NIH, 9000 Rockville Pike, Bldg. 10, Rm. 6N202, Bethesda,
34

35 MD 20892, USA
36

37 frances@mail.nih.gov
38
39
40
41
42
43
44
45
46
47
48
49
50
51
52
53
54
55
56
57
58
59
60

Table 1. Frequencies of PTGES2 R298H genotypes (R/R, R/H, H/H) and haplotypes and their associations with BMI as continuous variable via linear regression

| | Frequencies | | | Comparison | Unit change in BMI in kg/m ² [95 % confidence interval] (p values) | | |
|-------------------|-------------|------|-------|-------------------------------|---|------------------------------------|----------------------------|
| | All | Men | Women | | All | Men | Women |
| <i>Genotypes</i> | n | n | n | | | | |
| all | 8079 | 4013 | 4066 | | | | |
| R/R | 5203 | 2620 | 2583 | | | | |
| R/H | 2549 | 1228 | 1321 | R/R vs R/H | -0.17 [-0.37, 0.04] (0.11) | -0.30 [-0.55, -0.04] (0.02) | -0.03 [-0.35, 0.29] (0.87) |
| H/H | 327 | 165 | 162 | R/R vs H/H | -0.15 [-0.64, 0.33] (0.54) | 0.01 [-0.58, 0.60] (0.97) | -0.37 [-1.14, 0.39] (0.34) |
| R/H+H/H | 2876 | 1393 | 1483 | R/R vs H-carrier ¹ | -0.13 [-0.3, 0.04] (0.13) | -0.17 [-0.38, 0.03] (0.10) | -0.09 [-0.35, 0.17] (0.50) |
| <i>Haplotypes</i> | % | % | % | | | | |
| I, 1222 | 63.1 | 63.6 | 62.6 | | | | |
| II, 1212 | 19.7 | 19.3 | 20.2 | I vs II | -0.19 [-0.37, -0.01] (0.04) | -0.23 [-0.45, -0.02] (0.04) | -0.13 [-0.41, 0.14] (0.34) |
| III, 2121 | 10.6 | 10.3 | 11.0 | I vs III | -0.09 [-0.31, 0.14] (0.46) | -0.18 [-0.46, 0.10] (0.20) | 0.06 [-0.30, 0.41] (0.75) |
| IV, 2222 | 3.5 | 3.5 | 3.5 | I vs IV | 0.01 [-0.37, 0.40] (0.95) | -0.14 [-0.61, 0.34] (0.57) | 0.09 [-0.52, 0.69] (0.78) |

Results are the beta estimate (linear regression) with 95 % confidence interval and p values adjusted for age. ¹ additive model. Haplotype designation: the allele with the higher prevalence is denoted with 1, the minor allele with 2. The order of polymorphisms corresponds to their position in the 5' to 3' direction of the gene: rs884115, rs13283456 (R298H), rs10987883, rs4837240. The main results are in bold.

Lebenslauf

Mike Böhme

Geboren am 09.01.1980 in Soltau

Staatsangehörigkeit: deutsch

- Seit 04/2006 Doktorand, Institut für Humanernährung und Lebensmittelkunde, Abteilung Molekulare Ernährung (Prof. Dr. F. Döring), CAU, Kiel
- März 2006 MSc in Ernährungswissenschaften, Abteilung Molekulare Ernährung (Prof. Dr. F. Döring), Titel: "Functional analysis of promoter polymorphism in the gene encoding intestinal fatty acid binding protein 2 (FABP2)" CAU, Kiel
- 04/2004 – 03/2006 Student der Ernährungswissenschaften (MSc), CAU, Kiel
- 07/2003 – 03/2004 Erasmuns-Student für „Human Nutrition and Education“, Trinity College and St. Catherine’s College, Dublin, Irland
- Juli 2003 BSc in Ernährungswissenschaften, Institut für Toxikologie und Pharmakologie (Dr. H. Kruse), CAU, Kiel
- 10/2000 – 07/2003 Student der Ernährungswissenschaften (BSc), CAU, Kiel
- Juni 1999 Allgemeine Hochschulreife
- 08/1993 – 06/1999 Gymnasium Helene-Lange-Schule, Hannover

Erklärung

Hiermit erkläre ich an Eides statt, dass ich die vorliegende Dissertation mit dem Titel

„Functional and association analysis of polymorphisms in selected genes of fat metabolism“

selbständig und ohne unerlaubte Hilfe angefertigt habe und dass ich die Arbeit noch keinem anderen Fachbereich bzw. noch keiner anderen Fakultät vorlegt habe.

Mike Böhme

Danksagung

Ich bedanke mich bei Prof. Dr. Frank Döring für die Möglichkeit meine Promotion in seiner Abteilung durchzuführen. Sein unkomplizierter Umgang, sowie die mir entgegengebrachten Freiheiten und sein Vertrauen unterstützen und stärken mich während meiner gesamten Zeit in seiner Arbeitsgruppe.

Bei Prof. Dr. Gerald Rimbach bedanke ich mich für die Begutachtung meiner Dissertation.

Dr. Maja Klapper möchte ich dafür danken, dass sie stets ein offenes Ohr für meine fachbezogenen Fragen hatte und mir mit Rat zur Seite stand.

Dr. Inka Boomgaarden und Dr. Christina Vock danke ich sowohl für die angenehme „doktoriale“ Atmosphäre als auch für die Hilfe bei manch einem Problem in Labor und Büro.

Besonderer Dank gilt meinen Eltern, Irmtraud und Dieter Böhme, die mich mein ganzes Leben über bei meinen Entscheidungen uneingeschränkt unterstützt haben und an mich glauben.

Esther Wilhelm möchte ich danken, für die Kraft und die Freude, die sie in mein Leben bringt und mir hilft auch aus einem schlechten Labortag mit neuem Mut in einen neuen zu starten.

Weiterhin bedanke ich mich bei allen „Molnuts“, vor allem bei Daniela Hallack und Yvonne Dignal, für die offene und freundliche, aber auch professionelle und kritische Atmosphäre, sowie für alles was ich von ihnen und durch sie in meiner Zeit in der Abteilung für Molekulare Ernährung lernen durfte.