

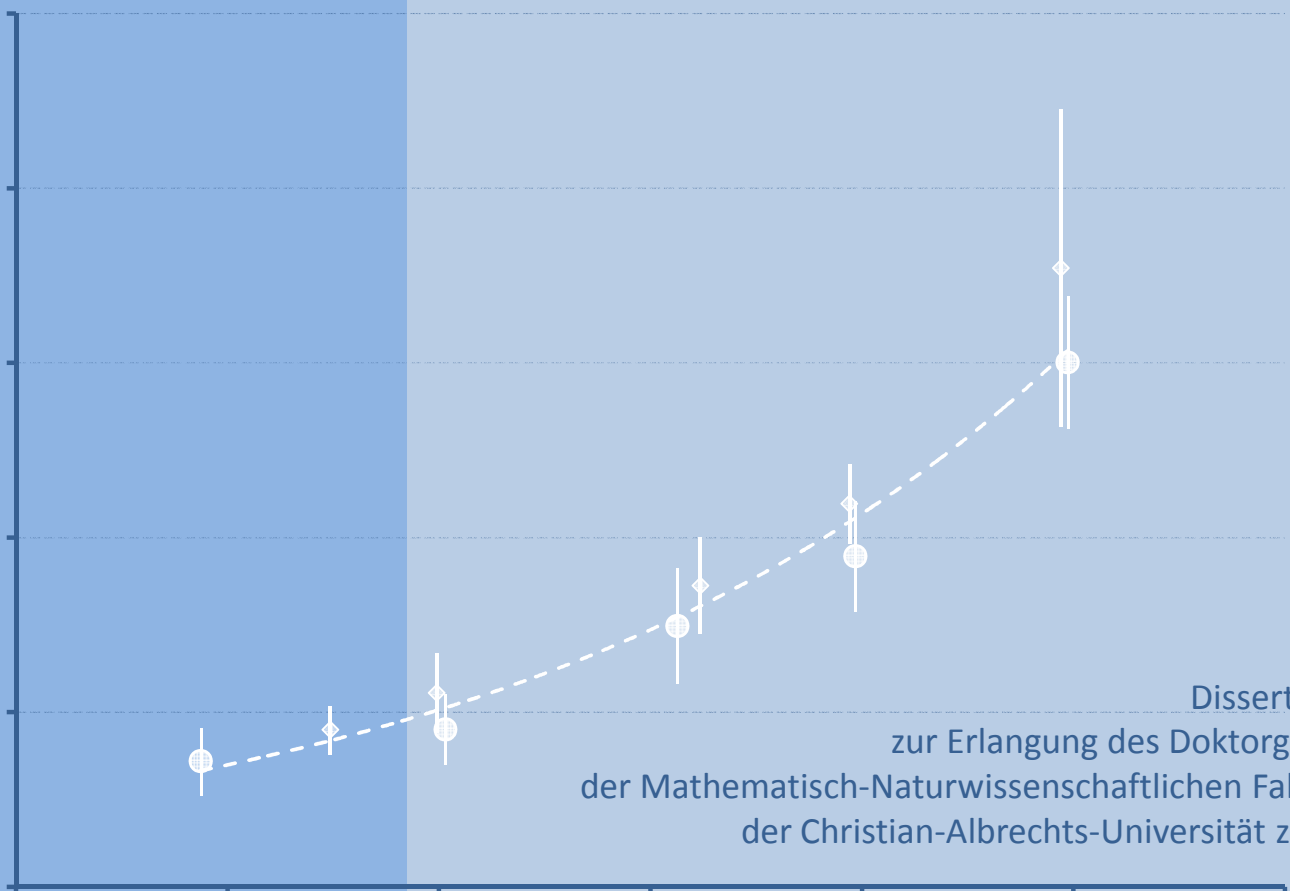


## Sensitivity of *A. islandica* and *M. edulis* towards Environmental Changes:

A Threat to the Bivalves - an Opportunity for Palaeo-Climatology?

Sensitivität von *A. islandica* und *M. edulis* gegenüber Umweltveränderungen:

Eine Gefahr für die Muscheln - eine Chance für die Paläoklimatologie?



Dissertation  
zur Erlangung des Doktorgrades  
der Mathematisch-Naturwissenschaftlichen Fakultät  
der Christian-Albrechts-Universität zu Kiel

Kiel 2009

vorgelegt von Claas Hiebenthal

**Sensitivity of *A. islandica* and *M. edulis* towards  
Environmental Changes:**

A Threat to the Bivalves -  
an Opportunity for Palaeo-Climatology?

**Sensitivität von *A. islandica* und *M. edulis* gegenüber Umweltveränderungen:**

Eine Gefahr für die Muscheln - eine Chance für die Paläoklimatologie?

Dissertation  
zur Erlangung des Doktorgrades  
der Mathematisch-Naturwissenschaftlichen Fakultät  
der Christian-Albrechts-Universität zu Kiel

**Kiel 2009**

**vorgelegt von Claas Hiebenthal**

Referent: Prof. Dr. Martin Wahl

Korreferent/in:

Tag der mündlichen Prüfung:

Zum Druck genehmigt: Kiel,

gez.

*Für Anne*



# Contents

Zusammenfassung	9
Summary	11
Introduction	13
Climate Change and Ocean Acidification in the Baltic Sea	13
Species, Physiology, Shell Formation, Shell Stability and Predator-Prey Interaction	14
Species Subject to this Work	14
Physiological Stress	14
Shell Formation	15
Shell Stability and Predator-Prey Interactions	17
Element / Calcium Isotope Ratios	18
Objectives	18
Chapter 1	21
Shell Growth, Fitness and Cellular Stress in Western Baltic Sea Bivalves <i>Mytilus edulis</i> (L.) and <i>Arctica islandica</i> (L.)	
Chapter 2	35
Experimentally determined Shell Chemistry Characteristics ( $\Delta^{44/40}\text{Ca}$ , $D_{\text{Mg}}$ and $D_{\text{Sr}}$ ) of young <i>Mytilus edulis</i> L. and <i>Arctica     islandica</i> L. as possible Tracer for SST and Salinity	
Chapter 3	57
Ocean Acidification and Ocean Warming: How western Baltic Sea Bivalves <i>Mytilus edulis</i> (L.) and <i>Arctica islandica</i> (L.) can cope with CO <sub>2</sub> -provoked Changes	

Chapter 4	81
Mg / Ca and Sr / Ca ratios in shells of young <i>Mytilus edulis</i> L. and <i>Arctica islandica</i> L. formed under different temperatures and levels of acidification	
Chapter 5	95
Defence Capability of Western Baltic Sea Bivalves <i>Mytilus</i> <i>edulis</i> (L.) and <i>Arctica islandica</i> (L.) at two Global Change Scenarios	
Synthesis and Conclusions	107
Danksagung	113
References	115
Curriculum Vitae	135
Erklärung	139

## Abbreviations used in this thesis:

ACC	:	amorphous calcium carbonate
ANOVA	:	analysis of variance
CI	:	condition index (here: CI = wet soft tissue weight <sub>(frozen)</sub> / dry shell weight)
c <sub>T</sub> room	:	constant temperature room
d	:	day
$\delta^{44/40}\text{Ca}$	:	calcium isotope ratio: $\delta^{44/40}\text{Ca}_{\text{sample}} = [({}^{44}\text{Ca} / {}^{40}\text{Ca})_{\text{sample}} / ({}^{44}\text{Ca} / {}^{40}\text{Ca})_{\text{NIST}} - 1] * 1000$
$\Delta^{44/40}\text{Ca}$	:	calcium isotope fractionation between fluid and solid: $\Delta^{44/40}\text{Ca} = \delta^{44/40}\text{Ca}_{\text{sample}} - \delta^{44/40}\text{Ca}_{\text{treatment water}}$
D <sub>Mg</sub>	:	distribution coefficient of magnesium
D <sub>Sr</sub>	:	distribution coefficient of strontium
DIC	:	dissolved inorganic carbon
ECRM	:	a limestone CRM (certified reference material) containing Mg/Ca
EPF	:	extrapallial fluid
eq.	:	equation
ICP-OES	:	inductively coupled plasma optical emission spectrometry
n	:	number of replicates
NIST	:	National Institute of Standards and Technology
pCO <sub>2</sub>	:	CO <sub>2</sub> partial pressure
RFI	:	relative fluorescent intensity
ROS	:	reactive oxygen species (O <sub>2</sub> <sup>-</sup> , H <sub>2</sub> O <sub>2</sub> , OH <sup>-</sup> )
SAL	:	salinity
s.d.	:	standard deviation = square root of the variance of n
s.e.	:	standard error = s.d. divided by the square root of n
SEMO	:	surface entrapment model
SST	:	sea surface temperature
SW	:	seawater
T	:	temperature



TA	:	total alkalinity
MC-TIMS	:	multi-collector thermal ionization mass spectrometry
$\Omega_{\text{aragonite}}$	:	(sea)water saturation state with respect to aragonite
$\Omega_{\text{calcite}}$	:	(sea)water saturation state with respect to calcite
v/v	:	volume per volume
w/v	:	weight per volume
XANES	:	x-ray Absorption Near Edge Spectroscopy
yr	:	year

## Zusammenfassung

Als bedeutendes Treibhausgas verursacht CO<sub>2</sub> globale Klimaerwärmung, die wiederum Veränderungen von anderen Klimaparametern wie Niederschlag und Salinität nach sich zieht. Zusätzlich versauern die Meere, da etwa ein Drittel des atmosphärischen CO<sub>2</sub> vom Oberflächenwasser absorbiert wird.

Für Muscheln ist die Schalenbildung ein ressourcenaufwändiger Prozess, der folglich empfindlich auf umweltbedingten Stress reagieren sollte. Veränderung des pCO<sub>2</sub>, der Salinität und der Temperatur des Wassers könnten als physiologische Stressoren wirken und Fitness, Muskelstärke, Schalenwachstum und -stabilität, also letztendlich die ökologische Performance der Muschel verringern.

Zur Verbesserung von Klimamodellen muss die Klimageschichte verstanden werden. Das Verhältnis stabiler Kalzium (Ca)-Isotope und divalenter Ca-Substituenten (z.B. Mg und Sr) in Muschelschalen ist abhängig von Wassertemperaturen und könnte deshalb theoretisch als Archiv vergangener Meerwasserklimate genutzt werden.

In zwei 2-faktoriellen Experimenten (Temperatur vs. Salinität, Temperatur vs. pCO<sub>2</sub>) wurde in dieser Arbeit der Einfluss von Wassertemperatur, Salinität und pCO<sub>2</sub> auf Schalenwachstum, Mortalität, Verfärbung (Condition Index = Weichkörpergewicht / Schalengewicht), Lipofuszingehalt des Weichkörpers (per Fluorometrie), Schalenstabilität (per Texture Analyzer) sowie auf das Verhältnis von Mg / Ca und Sr / Ca (per optischer Emissionsspektrometrie) und Kalziumisotopenfraktionierung ( $\Delta^{44/40}\text{Ca}$ , per Massenspektrometrie) in Muschelschalen der beiden Arten *Arctica islandica* und *Mytilus edulis* untersucht. Zudem wurde die Verteidigungsfähigkeit von *M. edulis* gegen Prädation durch den Seestern *Asteria rubens* in einem Fütterungsexperiment getestet.

Lipofuszinakkumulation, Wachstums- und Sterblichkeitsraten zeigen an, dass es sich bei *M. edulis* eher um eine Brackwasserart handelt. Unabhängig von der jeweiligen Salinitätsstufe hängen Verfärbung und Wachstum dieser Art aber stark von der Temperatur ab. Bezüglich der Schalenstabilität von *M. edulis* wird in der Ostsee voraussichtlich ein positiver Temperatureffekt über einen negativen Salinitätseffekt überwiegen. *A. islandica* ist eine an hohe Salinitäten und niedrige Temperaturen angepasste Art. Dies konnte einerseits durch Mortalität und Wachstumsraten (Salinität) und Lipofuszinakkumulation, Verfärbung und Schalenstabilität (Temperatur) gezeigt werden. Beide in dieser Arbeit untersuchten Muschelarten sind äußerst unempfindlich gegenüber Versauerung bis zu einem pCO<sub>2</sub> von etwa 1400  $\mu\text{atm}$ . Zudem änderte der Seestern *A. rubens* sein Fraßverhalten gegenüber unter sauren Bedingungen gehälterten Muscheln nicht. In der Summe werden steigende Temperaturen und sinkende Salinitäten voraussichtlich die Verbreitungsgrenzen von

## Zusammenfassung

*M. edulis* und *A. islandica* in Richtung stärker saliner und kälterer Bereiche in der westlichen Ostsee verschieben.

Die meisten in dieser Arbeit untersuchten Muschelschalen-Charakteristika können nur mit einer streng biologisch kontrollierten Schalenbildung erklärt werden. Der  $D_{Sr}$ -Proxy für Meerwasser Sr / Ca -Verhältnisse (*M. edulis*) bzw. für Salinitäten (*A. islandica*) ist bei beiden Arten anwendbar. Der  $\Delta^{44/40}Ca$ -Temperaturproxy weist bei *A. islandica* eine flache Steigung auf, jedoch unabhängig von der Salinität.  $\Delta^{44/40}Ca$  in *M. edulis* Schalen kann unseren Ergebnissen zu Folge nicht als Temperaturproxy verwendet werden. Das Mg / Ca-Verhältnis im Kalzit von *M. edulis* steigt sehr stetig und exponentiell mit steigender Temperatur an, wird aber zusätzlich von Salinität und  $pCO_2$  des Wassers beeinflusst.

## Summary

As a major green house gas, CO<sub>2</sub> causes global warming which further induces changes in other climate parameters like precipitation and salinity. Additionally as about one-third of the atmospheric CO<sub>2</sub> is absorbed by surface waters, the oceans become acidified.

Bivalve shell production is costly and should therefore be sensitive to environmental stress. Water pCO<sub>2</sub>, salinity and temperature changes may be factors that increase physiological stress and thus, can reduce fitness, muscle strength, shell growth, shell stability and finally the bivalves' ecological performance.

The improvement of climate models requires a better understanding of climate history. The ratios of stable Ca isotopes and of divalent substituents of Ca (e.g. Mg and Sr) in bivalve shells depend on seawater temperatures and can therefore theoretically be used as archives of past seawater climates.

In two 2-factorial experimental approaches (temperature vs. salinity, temperature vs. pCO<sub>2</sub>), this work investigates the influence of water temperature, salinity and pCO<sub>2</sub> on shell growth, mortality, condition index ( $C_i = \text{soft tissue weight} / \text{shell weight}$ ), lipofuscin content in the soft tissue (by fluorometry), shell stability (with a texture analyzer), shell Mg / Ca and Sr / Ca ratios (by optical emission spectrometry) and shell Ca isotope fractionation ( $\Delta^{44/40}\text{Ca}$ , by mass spectrometry) of the two bivalve species *Arctica islandica* and *Mytilus edulis*. Additionally, in a feeding assay, we tested the defence capability of *M. edulis* towards predation by starfish *Asterias rubens*.

Lipofuscin accumulation, growth rates and mortalities indicate that *M. edulis* is rather an estuarine than a fully marine species. Independent of the respective salinity, however, condition and growth of this species are strongly controlled by temperature. In the Baltic Sea, a positive temperature effect on shell stability will presumably be stronger than a negative salinity effect. *A. islandica* is a species adapted to high salinity and low temperatures. This could be shown by mortalities and growth rates (salinity) on the one hand and by lipofuscin accumulation, condition index and shell stability (temperature) on the other hand. Both bivalve species that were under investigation in this thesis are largely insensitive to acidifications up to a water pCO<sub>2</sub> of about 1400  $\mu\text{atm}$ . Also, the starfish *A. rubens* did not change its feeding behaviour on *M. edulis* that were cultured under acidic conditions. Increasing temperature and decreasing salinity, in summary, will most likely shift distributions of *M. edulis* and *A. islandica* in the Baltic Sea towards the higher-saline and cooler North-Western areas.

## Summary

It became obvious that most of the shell chemistry characteristics investigated in this study can only be explained by a tightly biologically controlled shell formation. The  $D_{Sr}$  proxy for seawater Sr / Ca ratios (*M. edulis*) respectively for salinity (*A. islandica*) is applicable in both species. The Ca isotope ( $\Delta^{44/40}Ca$ )-temperature proxy in *A. islandica* has a shallow slope but is independent of salinity.  $\Delta^{44/40}Ca$  in *M. edulis* shells, with regard to our results cannot be used as a temperature proxy. Mg / Ca in *M. edulis* calcite, however, increases very consistently and exponentially with temperature, though Mg / Ca is influenced by salinity and water  $pCO_2$ , too.

## Introduction

### **Climate Change and Ocean Acidification in the Baltic Sea**

Massive anthropogenic release of carbon dioxide (CO<sub>2</sub>) into the atmosphere - mainly due to land use and the burning of fossil fuels - causes two major modifications of the marine environment. Firstly, as a major green house gas, CO<sub>2</sub> contributes to global warming that further causes changes in average wind speed, precipitation, ice cover and salinity (Hupfer and Tinz 1996; Omstedt *et al.* 2000; Babarro and de Zwaan 2002; Lehmann *et al.* 2002; Walther *et al.* 2002; Meier 2006; Denman *et al.* 2007). Secondly, as about one-third of the emitted CO<sub>2</sub> is absorbed by the World's oceans, the water pH decreases. The latter causes a shift in the water's inorganic carbon equilibrium towards higher CO<sub>2</sub> and lower carbonate ion (CO<sub>3</sub><sup>2-</sup>) concentrations and therefore the calcium carbonate (CaCO<sub>3</sub>) saturation state is lowered (Caldeira and Wickett 2003; Feely *et al.* 2004; Sabine *et al.* 2004). Present oceanic surface waters are supersaturated with respect to calcite and aragonite, the thermodynamically stable polymorphs of CaCO<sub>3</sub>. Already within the next 40 years, however, high-latitude oceans are proposed to become undersaturated with respect to aragonite (Orr *et al.* 2005; Cao and Caldeira 2008).

In the Baltic Sea, water temperature increases of 2.6 to 5 °C within the next 100 years were projected as well as salinity decreases of -1.6 to -4.2 due to higher precipitation (Graham 2004; Meier 2006). Atmospheric CO<sub>2</sub> concentrations are expected to further rise to values between 750 and 1000 ppm by the year 2100 and CO<sub>2</sub> partial pressures (pCO<sub>2</sub>) will reach levels of more than 1500 µatm (1500 ppm) between the years 2100 and 2200 (Wigley *et al.* 1996). These changes have the potential to alter ecosystems and shift species distribution limits. The consequences of changes in temperature, salinity and water pCO<sub>2</sub> on two important Baltic Sea bivalve species are subject of this thesis.

## **Species, Physiology, Shell Formation and Stability and Predator-Prey Interaction**

### Species Subject to this Work

*Arctica islandica* L. and *Mytilus edulis* L. are widespread species in the North Atlantic as well as in the Baltic Sea (Loosanoff 1953; Theede *et al.* 1969; Gosling 1992; Bers 2006).

*A. islandica*. The Ocean Quahog *A. islandica* lives in the sandy sea bottom (e.g. (Witbaard and Bergman 2003). It reaches its Eastern limit of distribution in the Baltic Sea's Arcona Basin (von Oertzen 1973). In the Kiel Bight (Brey 1990) and Mecklenburg Bight (Zettler 2001) it dominates the soft-bottom community below the halocline (~15 m), with respect to biomass and production. In Kiel Bight 40 % of the annual cod (*Gadus morhua*) production between 1970 and 1985 were estimated to depend on *A. islandica* (Brey 1990). *A. islandica* is extremely long-lived. The age of one specimen was determined to be 374 years (Schöne *et al.* 2005). This represents the highest age reported from an individual animal as yet.

*M. edulis*. The Blue Mussel *M. edulis* lives attached to hard substrata (Seed and Suchanek 1992) or as loose beds on sandy substrata (Lozan *et al.* 1996). *M. edulis* can reach very high abundances (Kautsky 1982; Wahl 2001). In some areas of the Baltic Sea this species makes up to 80 % of the animal biomass (Jansson and Kautsky 1977; Suchanek 1985; Reusch and Chapman 1997). Additionally, *M. edulis* acts as an important ecosystem engineer: Mussel beds provide substratum and shelter for various other species and stabilize soft bottom sediments (Tsuchiya and Nishihira 1986; Kautsky and Evans 1987; Lohse 1993; Lozan *et al.* 1996; Seed, R. 1996; Commito *et al.* 2005). Finally, as a highly efficient filter feeder, *M. edulis* is a main trophic link between phytoplankton and benthos and significantly reduces water turbidity (Kautsky 1981; Kautsky and Evans 1987; Lozan *et al.* 1996).

### Physiological Stress

Physiologically stressful conditions can lead to an increase in the cellular generation of reactive oxygen species (ROS:  $O_2^-$ ,  $H_2O_2$ ,  $OH^-$ ). These can cause increased cellular damage if free radical defence mechanisms like antioxidant enzymes (e.g. catalase or superoxide dismutase) or low molecular antioxidants (e.g. glutathione) are insufficient (Abele and Puntarulo 2004). Furthermore, proteasomes and lysosomes can partly remove or repair damaged cell structures. However, this repair is not complete and waste accumulation is not entirely avoided. Lipofuscin consists of the incompletely degraded damaged cell structures, mainly proteins and lipids. It accumulates in cell lysosomes, where it is virtually indigestible (Terman 2001; Brunk and Terman 2002). The "aging pigment" lipofuscin increases continuously with age (Bluhm *et al.* 2001; Leeuwenburgh *et al.* 1994; Philipp *et al.* 2005;

Sheehy *et al.* 1994; Sukhotin *et al.* 2002; Zielinski and Pörtner 2000) and even allows comparing aging processes in different species.

Next to age, also different environmental stressors have been shown to increase lipofuscin accumulation (e.g. Totaro *et al.* 1986; Regoli 1992; Abele *et al.* 1998; Au and Wu 2001; Bocchetti and Regoli 2006; Guerlet *et al.* 2007). However, studies conducted so far on the influence of temperature on lipofuscin accumulation in different tissues of fish (Hill and Womersley 1993), crustaceans (Sheehy *et al.* 1995; Tully *et al.* 2000; Kodama *et al.* 2006), gastropods (Abele *et al.* 1998) and bivalves (Hole *et al.* 1995; Kagley *et al.* 2003; Petrovic *et al.* 2004; Guerlet *et al.* 2007) show inconsistent (increasing, decreasing or unimodal) relationships.

Detrimental effects of acidified seawater on the reproduction, performance, physiological responses and also the amount of muscle tissue of calcifying organisms like crustaceans, pteropods, echinoderms, corals, foraminifera, coccolithophorids, coralline algae and bivalves were found in recent studies (Michaelidis *et al.* 2005; Orr *et al.* 2005; Shirayama and Thornton 2005; Berge *et al.* 2006; Langer *et al.* 2006; Atkinson and Cuet 2008; Kuffner *et al.* 2008; Kurihara 2008; Wood *et al.* 2008; Moy *et al.* 2009). In addition, higher temperature increases metabolism rates of poikilotherm animals. The resulting higher CO<sub>2</sub> production can further increase detrimental effects of acidification (Michaelidis *et al.* 2005; Gazeau *et al.* 2007). Finally, acidification is suspected to narrow thermal niches and therefore modulate temperature distribution limits (Pörtner 2008).

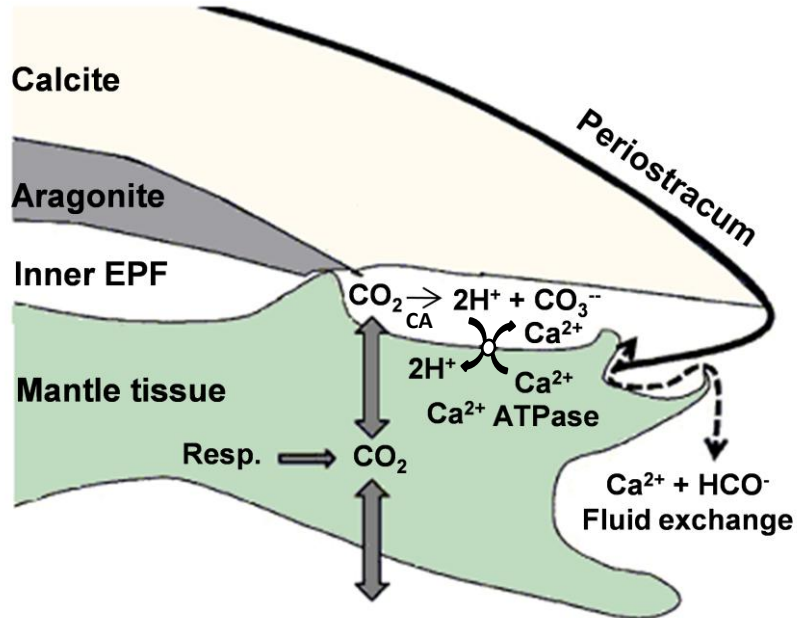
## Shell Formation

Growth rates and stability of bivalves' major defence organ, the shell, were found to depend on the environmental factors temperature and salinity (Malone and Dodd 1967; Remane and Schlieper 1971; Seed, R 1976; Kautsky 1982; Kautsky *et al.* 1990). In bivalves, the inorganic shell material calcium carbonate (CaCO<sub>3</sub>) precipitates from a compartment that is separated from the external medium by the old shell, the periostracum, and the outer mantle margin (Wilbur and Saleuddin 1983, **figure I.1**). This extrapallial space is proposed to be divided into an inner and outer section (Wheeler 1992; Vander Putten *et al.* 2000). It contains the extrapallial fluid (EPF) that includes several organic compounds (proteins, glycoprotein, carbohydrates), which are associated to the mineralization process (Hattan *et al.* 2001; Yin *et al.* 2005). For example, carbonic anhydrase is known to catalyse shell formation (**fig. I.1**) (Wilbur and Saleuddin 1983); its activity can change with the organism's physiological state.

During precipitation, Ca and bicarbonate (HCO<sub>3</sub><sup>-</sup>) combine to form CaCO<sub>3</sub>. While bicarbonate ions (HCO<sub>3</sub><sup>-</sup>) are suggested to enter the EPF by diffusion through the mantle, for Ca passive and active transport mechanism are discussed, e.g. a Ca<sup>2+</sup> / 2H<sup>+</sup> ATPase in the mantle epithel, (**fig. I.1**, McConnaughey and Gillikin 2008). However, the shells do not solely



consist of  $\text{CaCO}_3$ . The  $\text{CaCO}_3$  crystals develop in a so-called organic matrix, which has been considered a catalyser of nucleation as well as a determinant of crystal orientation, size and type (Wilbur and Saleuddin 1983; Zhang and Zhang 2006)



**Figure I.1.** Bivalve shell formation. After McConnaughey and Gillikin (2008): The cross section through a mussel shell (morphology by Vander Putten *et al.* 2000) shows likely transport routes for calcium and inorganic carbon to and from the extrapallial fluid (EPF) from which calcium carbonate precipitates, catalysed by carbonic anhydrase (CA).

## Shell Stability and Predator-Prey Interactions

Next to fish, crabs and sea stars feed on *A. islandica* (Brey 1990; Cargnelli *et al.* 1999). Predation by starfish and crabs also primarily controls the abundance of mussels *M. edulis* in the Baltic Sea (Reusch and Chapman 1997; Laudien and Wahl 1999). Therefore, the abilities to fend off crab and starfish predation are key determinants of both bivalves' Baltic Sea distributions.

Many starfish and crab predators prefer relative small sized mussels as prey, which are easier to open and not likely to damage the crabs' claws (Juanes 1992; Reusch and Chapman 1997; Leonard *et al.* 1999). It follows that faster growth will allow an earlier escape from predation by these species (Elner and Hughes 1978; Palmer 1981; Boulding 1984; Enderlein and Wahl 2004).

Further, shell stability determines the susceptibility of bivalves to many shell-cracking predators like birds and crabs (Elner and Hughes 1978; Kautsky *et al.* 1990; Nagarajan *et al.* 2006). For example, besides prey shape and shell thickness, the shell stability is a significant attribute on which the shore crab *Carcinus maenas* bases its foraging behaviour (Beadman *et al.* 2003).

As shell growth rates and shell stability are affected by both, salinity and temperature, (Remane and Schlieper 1971; Kautsky 1982; Tedengren and Kautsky 1986) they are likely to be affected by the predicted environmental changes. Finally, a recent study found that reduced levels of salinity might shift the preferred prey size for crabs towards larger mussels (Kossak 2006).

Other predators, such as the common starfish *Asterias rubens*, do not obtain mussel prey by a crushing, but a pulling mode of opening the valves. Thus, muscle strength of both, predator and prey, determines the preferred prey size of *A. rubens*. As environmental stress may not only influence the shell growth and stability, but also the development of muscles of marine bivalves. Wood *et al.* (2008) found that ocean acidification may even increase the rate of calcification in brittle stars, but decreases the amount of muscle tissue produced. If this holds true for other organisms, such as bivalves, it could have an influence on the feeding by shell-opening predators, like starfish.

Hence, the predicted increase in water pCO<sub>2</sub> and temperature and the decrease in salinity (Caldeira and Wickett 2003; Feely *et al.* 2004; Sabine *et al.* 2004; Denman *et al.* 2007) can be expected to influence the bivalves' susceptibility to predation and finally shift species distribution.

## Element / Calcium and Calcium Isotope Ratios

The improvement of climate models requires a better understanding of climate history. As reliable historical observations are rare, diagenetically stable archives with high resolution over decades and centuries are needed to reconstruct past climate scenarios. Recent studies show that seawater temperatures modulate several bivalve shell chemistry characteristics, which therefore can theoretically be used as proxies for paleo-climata.

For example, element ratios (Mg / Ca, Sr / Ca) in bivalve shells can depend on seawater temperatures (Klein *et al.* 1996; Lazareth *et al.* 2003; Freitas *et al.* 2005; Immenhauser *et al.* 2005; Freitas *et al.* 2008). But the reliability of these shell chemistry characteristics as proxies for environmental parameters appears to be rather weak. Metabolic effects are proposed to be too strong (Vander Putten *et al.* 2000; Immenhauser *et al.* 2005; Freitas *et al.* 2008) and the bivalve biomineralization processes too poorly understood (Heinemann *et al.* 2008). Still, Wanamaker *et al.* (Wanamaker *et al.* 2008) found promising Mg / Ca- and Sr / Ca-temperature relationships in *M. edulis* shells at a (low) salinity of 23.

Moreover, calcium isotope ratios ( $\delta^{44/40}\text{Ca}$ ) were addressed as a proxy for paleo-temperatures in coccolithophores (Gussone *et al.* 2006; Langer *et al.* 2007), foraminifers (Nägler *et al.* 2000; Gussone *et al.* 2003; Heuser *et al.* 2005; Sime *et al.* 2005; Hippler *et al.* 2006; Hippler *et al.* 2007; Kozdon 2007) and corals (Böhm *et al.* 2006). Studies of calcium isotopes in bivalve shells are, however, still infrequent (Immenhauser *et al.* 2005; Heinemann *et al.* 2008). Immenhauser *et al.* (2005) conducted measurements of  $\delta^{44/40}\text{Ca}$  in the fossil rudist bivalve *Vaccinites ultimus* and Heinemann *et al.* (2007) measured calcite and aragonite of three *M. edulis* individuals from three different salinity regimes.

## Objectives

In two experimental approaches, this study investigates the influence of three main aspects of global change on the performance and selected shell chemistry characteristics of the two bivalve species *Arctica islandica* and *Mytilus edulis*.

The interdisciplinary character of this thesis allowed combining aspects of different scientific fields in ecological experiments that simulate changes in temperatures, salinity and pCO<sub>2</sub>. Thus, it was possible to investigate bivalves on different magnifications from whole individuals and their defence capability towards predators via individual fitness and cellular stress to elemental and even isotopic composition of the shell, however, without claiming to elucidate all aspects of physiology and biogenic calcium carbonate precipitation in this context.

As effects of different environmental factors on bivalve shell growth can interact (e.g. Kossak 2006) this may be the case for the effects of temperature, salinity and water pCO<sub>2</sub> on physiological and shell chemistry parameters, too. Consequently, both bivalve species were cultured in each two fully crossed 2-factorial experimental setups (setup 1: temperature vs. salinity; setup 2: temperature vs. pCO<sub>2</sub>). Thereby, it was possible to explore the potential sensitivity of temperature effects towards acidification and salinity as well as differences in the strength of acidification and salinity effects at different temperatures.

The results are presented in five chapters:

In chapter 1, the effects of changes in salinity and temperature on shell growth, condition index (soft tissue weight<sub>(frozen)</sub> / dry shell weight), mortality and cellular stress of young individuals of *A. islandica* and *M. edulis* from the Baltic Sea was assessed. The aim was to investigate whether the predicted increase in temperature and decrease in salinity in the Baltic Sea may influence the performance of the bivalve species investigated.

In chapter 2, a deeper glimpse into the elemental and isotopic composition of bivalve shells was taken, using mass spectroscopy and mass spectrometry. The animals were cultured in the same experimental setup as in chapter 1. Aim of the measurements was to assess the applicability of two element / calcium ratios (Mg / Ca and Sr / Ca) and calcium isotope fractionation ( $\Delta^{44/40}\text{Ca}$ ) as proxies to reconstruct past seawater climates at different salinities.

In the second experimental setup, in chapter 3, similar as in chapter 1, the influence of a changed seawater climate on the performance of Baltic Sea *A. islandica* and *M. edulis* was investigated again, this time taking into account ocean acidification and rising temperatures.

By mass spectroscopic analysis of the elemental shell composition (Mg / Ca and Sr / Ca) of bivalves cultured in this second experiment, the reproducibility of promising element-temperature relationships found in chapter 3 could be tested as well as the elemental compositions' sensitivity toward water pCO<sub>2</sub>. The results are presented in chapter 4.

Finally, subject of chapter 5 are the effects of CO<sub>2</sub>-driven ocean climate changes on the performance of the bivalves *A. islandica* and *M. edulis* in an ecological context. First, the bracing stability of bivalve shells from both experimental setups was tested to explore effects of changes in temperature, salinity and acidification on the bivalves' defence capability towards shell-braking predators. In a second step, a feeding essay was conducted to reveal possible effects of acidification and temperature changes on the defence capability of *M. edulis* against shell-opening predators, here the starfish *Asterias rubens*.



## Chapter 1

### Shell Growth, Fitness and Cellular Stress in Western Baltic Sea Bivalves *Mytilus edulis* (L.) and *Arctica islandica* (L.)

Chapter 1 was submitted under the same title to the Journal of Experimental Marine Biology and Ecology.

#### Abstract

Bivalve shell production, including the organic matrix and calcification, is costly and should therefore be sensitive to environmental stress. Salinity and temperature changes may be stressors that force the organism to invest more energy into ion regulation or the repair of cellular damages caused by an increased generation of reactive oxygen species (ROS: O<sub>2</sub><sup>-</sup>, H<sub>2</sub>O<sub>2</sub>, OH<sup>-</sup>) under elevated temperatures.

In the present study the effect of both environmental factors (salinity and temperature) on shell growth, fitness (condition index and mortality) and cellular stress of young individuals of *M. edulis* and *A. islandica* from the Baltic Sea was assessed. We conducted two 2-factorial, fully crossed experiments with the factors temperature (4, 10, 16, 20 and 25 °C for *M. edulis* and 4, 10 and 16 °C for *A. islandica*) and salinity (15, 25 and 35).

Our results show that cellular stress of both species increased primarily with temperature but the influence on fitness and growth was stronger in *M. edulis* compared to *A. islandica*. Results of lipofuscin accumulation, growth rate and mortality indicate that *M. edulis* is rather an estuarine than a high saline species. The resistance of this species towards high temperature stress is highest at intermediate salinities (SAL 25). Mortality and growth rate data of *A. islandica* indicate a high saline species. *A. islandica* will suffer from future desalination in the estuarine Baltic Sea whereas North Sea individuals will be more affected by increased temperatures.

#### 1.1 Introduction

Bivalves' shell growth rates depend on both biotic and abiotic environmental factors such as food availability, competition for space, wave exposure, light, pH, temperature or salinity (Malone and Dodd 1967; Seed 1976; Bayne and Worrall 1980; Kautsky 1982; Wefer and Berger 1991; Wong and Levinton 2004). In general, shell production, including the organic matrix and calcification, is costly (Palmer 1992; Irie and Iwasa 2005). Therefore, it should be sensitive to environmental stress, as energy has to be allocated from shell production to

stress response processes, e.g. cellular repair mechanisms. Salinity and temperature changes may be such stressors that force the animal to invest more energy into ion regulatory processes or the repair of oxidized cellular components caused by an increased generation of reactive oxygen species (ROS:  $O_2^-$ ,  $H_2O_2$ ,  $OH^-$ ) at higher temperatures (Sukhotin *et al.* 2002).

However, in *M. edulis*, shells growth increased in two laboratory experiments with higher temperatures (up to 20 °C) (Almada-Villela *et al.* 1982; Reuter 2004) and also in *A. islandica* shell growth was found to increase between 1 and 12 °C (Witbaard *et al.* 1997).

The influence of salinity on bivalve growth varies between species. Shell growth of *M. edulis* strongly depends on salinity (Kautsky 1982; Almada-Villela 1984; Tedengren and Kautsky 1986; Seed and Suchanek 1992; Reuter 2004) and was recently found to peak at an intermediate salinity of 24 (Kossak 2006). Estimations of shell growth of young *A. islandica* from the estuarine Baltic Sea (Brey 1990) are similar or even higher than those from the North Atlantic (Schone *et al.* 2005b).

Under physiologically stressful conditions an increase in ROS generation rate can lead to increased lipid and protein oxidation in marine invertebrates (Abele and Puntarulo 2004). The damaged cell structures can be partly removed and repaired e.g. by proteasomes and lysosomes. However, the repair is never complete and can result in waste accumulation. The “aging pigment” lipofuscin represents such incompletely degraded damaged cell structures, mainly proteins and lipids (30 – 70 % and 20 – 50 % respectively). It accumulates in the lysosomes, where it is practically indigestible (Terman 2001; Brunk and Terman 2002b).

An increase in lipofuscin accumulation under different environmental stressors has been found in studies on non-molluscs (Totaro *et al.* 1986; Au *et al.* 1999; Au and Wu 2001), non-bivalve molluscs (Abele *et al.* 1998) and already in several studies about different bivalve species (Regoli 1992; Mathew and Damodaran 1997; Byrne and O'Halloran 2000; Bocchetti and Regoli 2006; Guerlet *et al.* 2007), and it can be used as a biomarker for oxidative cell damage (Winston 1991; Brunk and Terman 2002b; Brunk and Terman 2002a; Philipp *et al.* 2005; Philipp *et al.* 2006). In *M. edulis*, the accumulation of lipofuscin has been found to be enhanced by mixed pollutants (Krishnakumar *et al.* 1994; Krishnakumar *et al.* 1997; Kagley *et al.* 2003; Aarab *et al.* 2008), copper (Hole *et al.* 1993; Dondero *et al.* 2006), a polycyclic aromatic hydrocarbon (McVeigh *et al.* 2006) and pollution due to nano-particles (Koehler *et al.* 2008), demonstrating the suitability of this histo-chemical parameter as an universal stress proxy.

Studies on the influence of temperature on lipofuscin accumulation in fish (Hill and Womersley 1993; Valenzano *et al.* 2006), crustaceans (Sheehy *et al.* 1995; O'Donovan and Tully 1996; Tully *et al.* 2000; Sheehy 2002; Kodama *et al.* 2006), gastropods (Abele *et al.*

1998) and bivalves (Hole *et al.* 1995; Kagley *et al.* 2003; Petrovic *et al.* 2004; Guerlet *et al.* 2007) showed inconsistent results. Only one study addressed the effect of salinity-caused stress on lipofuscin accumulation and found no effect of salinity in *M. galloprovincialis* (Petrovic *et al.* 2004).

In the present study the effect of salinity and temperature on shell growth, fitness (condition and mortality) and cellular stress of young individuals of two bivalve species from the Baltic Sea was assessed. Our aim was to investigate whether the predicted increase in temperature and decrease in salinity in the Baltic Sea due to climate change (Denman *et al.* 2007) leads to increased physiological stress which may influence the competitiveness or susceptibility to predation of bivalves and, ultimately, could shift their limits of distribution.

The investigated bivalve species, *Arctica islandica* L. and *Mytilus edulis* L., live in the North Atlantic as well as in the Baltic Sea (Loosanoff 1953; Theede *et al.* 1969; Gosling 1992; Bers 2006). While *A. islandica* burrows in the sandy sea bottom, *M. edulis* is attached to hard substrata (Seed and Suchanek 1992; Witbaard and Bergman 2003) or forms loose beds on sandy substrata.

*M. edulis* can reach high abundances (Kautsky 1982; Wahl 2001) and can make up to 80 % of the animal biomass in some areas of the Baltic Sea (Jansson and Kautsky 1977; Suchanek 1985; Reusch and Chapman 1997; Wahl 2001; Enderlein and Wahl 2004). As it integrates several biotic and abiotic stressors, its growth is suggested to be a suitable parameter for assessments of the ecological state of the environment (Riisgard and Randlov 1981).

*A. islandica* is very long-lived (Schone *et al.* 2005a) and its shells are used as climate archives (Weidman *et al.* 1994; Schone *et al.* 2005a; Dunca *et al.* 2006). *A. islandica* occurs in the whole North Atlantic region (Loosanoff 1953; Dahlgren *et al.* 2000) and reaches its eastern limit of distribution in the Baltic Sea in the Arcona Basin (von Oertzen 1973). In Kiel Bight (Brey 1990) and Mecklenburg Bight (Zettler 2001), with respect to biomass and production, it dominates soft-bottom communities below the halocline (15 m). About 40 % of the annual cod (*Gadus morhua*) production in Kiel Bight between 1970 and 1985 was estimated to depend on *A. islandica* (Brey 1990).



## 1.2 Materials and Methods

Young *M. edulis* specimens were collected in Kiel Fjord. Individual shell height (measured from the umbo to the opposite side of the shell) ranged between 13.3 to 26.5 mm ( $19.0 \pm 2.23$  s.d.). *A. islandica* specimens were dredged at the station "Süderfahrt" (54°32.6' N, 10°42.1' E) west of Fehmarn Island in Kiel Bight, Baltic Sea. Animals' height ranged between 12.1 and 33.0 mm ( $20.4 \pm 2.23$  s.d.).

*Experimental design.* We conducted two 2-factorial, fully crossed experiments with the factors temperature and salinity (ANOVA-model:  $X_{ijk} = \mu + T_i + SAL_j + T_iSAL_j + e_{k(ij)}$ ). Treatment levels were 4, 10, 16, 20 and 25 °C for *M. edulis* and 4, 10 and 16 °C for *A. islandica* regarding temperature and 15, 25 and 35 regarding salinity. The level of replication was 4.

*Culture.* Bivalves were cultured at the Leibniz-Institute of Marine Sciences IFM-GEOMAR, Kiel, Germany, in 96 temperature-insulated 4-l-containers (10 individuals (ind.) of *M. edulis* respectively 7 ind. of *A. islandica* in each container) and fed 5 days a week with 0.5 ml / ind. / d of a concentrated living-phytoplankton suspension (DT's Premium Blend, DT's Plankton Farm, Sycamore, IL) containing *Nannochloropsis oculata* (40 %), *Phaeodactylum tricornutum* (40 %) and *Chlorella* sp. (20 %) and an algal biomass (dry weight) of approx. 2.91 g / l, resulting in 0.015 g / ind. / d. One eighth of the water volume per aquarium (1 / 2 L) was exchanged twice a week. Temperature (logged with HOBO® Onset Computer Corporation, Pocasset, MA, temperature loggers, **table 1.1**) and salinity (measured with WTW conductometer, cond 330i, WTW GmbH, Weilheim, Germany) were kept stable for the experimental duration of 15 weeks. Salinity levels were set by mixing fresh Baltic seawater with either ion exchanged water (to obtain SAL 15) or artificial marine salt (SEEUASAL GmbH, Münster, Germany, SAL 25 and SAL 35). The animals were allowed to slowly adapt to the respective treatments: starting from a salinity of 17, salinity was changed by max. 1 unit per day and, subsequently, starting from 15 °C, temperature was changed by max. 1 °C per day until treatment conditions were reached.

Bivalves that died during the experimental phase were replaced by new specimen to keep the animal density constant. These newly introduced individuals were not considered for further analysis.

**Table 1.1:** Measured temperatures of treatments, means and standard deviations ( $\sigma$ ):

treatment level:		4 °C	10 °C	16 °C	20 °C	25 °C
<i>A. islandica</i>	mean ( °C):	4.1	10.1	15.7	-	-
	s.d.:	0.2	0.3	0.6	-	-
<i>M. edulis</i>	mean ( °C):	4.4	10.2	15.6	19.9	24.9
	s.d.:	0.1	0.1	0.9	0.3	0.1

*Data collection.* Animals were marked individually and shell height (see above) measured after the acclimatisation phase (duration depended on treatment levels) to the nearest 0.02 mm using a calliper. Animals were measured at the start and then every month throughout the experiment.

After a 15 week period, the whole soft tissue of the best grown animal of each basin (best grown individuals were chosen as for the determination of shell chemistry characteristics sufficient amounts of shell material was needed, chapter 2) was removed from the shells and deep-frozen at -80 °C. Individual soft tissue weight was determined by weighing the frozen sample. Shells were air dried (7 days at 20 °C) and the weight of the shells recorded.

The condition index ( $C_i$ ) was calculated as  $C_i = \text{wet soft tissue weight}_{(\text{frozen})} / \text{dry shell weight}$ . For comparison of different  $C_i$  s see Davenport and Chen (1987).

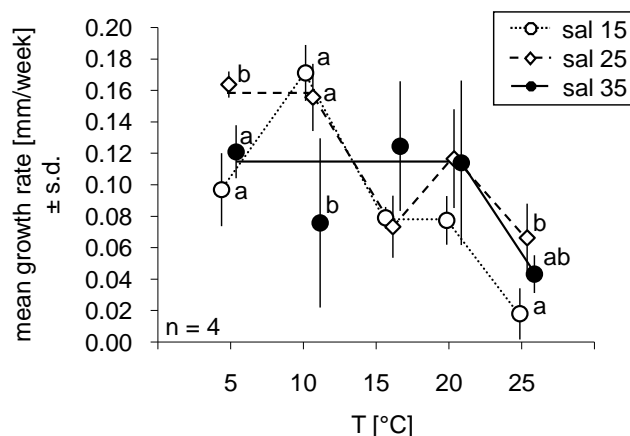
Lipofuscin contents were determined by an extraction method modified after Vernet et al. (1988) at the Alfred Wegener Institute in Bremerhaven, Germany. Frozen soft tissue material was ground in liquid nitrogen and homogenised (1:20 w/v) in a chloroform-methanol solution (2:1 v/v). The homogenate was mixed with 100 mM  $\text{MgCl}_2$  solution (1 ml per each 4 ml of chloroform-methanol). After 15 min centrifugation at 2000 g and 0 °C, the chloroform phase was collected and mixed with distilled water (1 ml per 4 ml initial chloroform-methanol), centrifuged as above again, and the chloroform phase collected and measured in the fluorometer. An emission spectrum was obtained at an excitation wavelength of 350 nm. The fluorescence intensity of each sample was then determined at the emission maximum of 480 nm. According to Hill and Womersley (1993), lipofuscin contents were expressed as relative fluorescent intensity (RFI) using 0.1  $\mu\text{g}$  quinine sulphate per ml 1 N  $\text{H}_2\text{SO}_4$  as standard and were corrected by the incubation time and experimental start length of the individual bivalves:  $\text{RFI}_{\text{corr}} = \text{RFI} / (\text{incubation time} * \text{start length})$ .

*Data analyses.* Data representing percentage values, namely mortality values, were arcsine transformed. Not normally distributed data or those of unequal variances were (square root-, 4<sup>th</sup>- root or log-) transformed to meet the necessary assumptions for an ANOVA. In 4 cases no transformation was successful. Here, the significance level  $\alpha$  was lowered from 0.05 to 0.01 to reduce the risk of type-1 errors (Glasby 1998). Data were analysed for significant differences by 2-factorial ANOVA and, in case of clear trends, by linear or quadratic regression. Differences between single treatment levels were identified by Tukey HSD post-hoc test. All statistical tests were provided by Statistica 8.0 software package.

### 1.3 Results

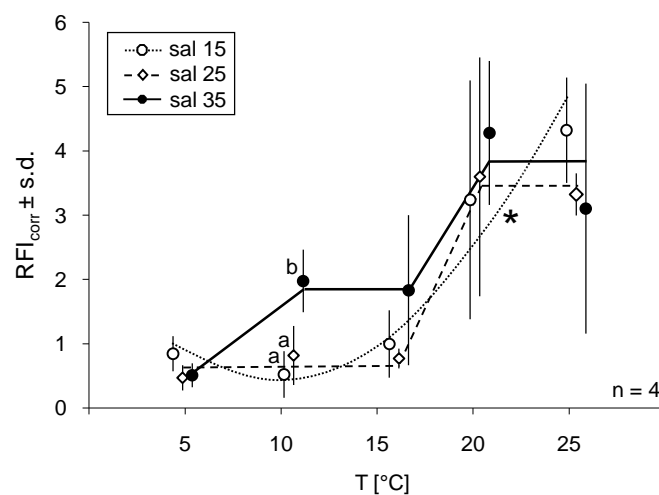
#### *M. edulis*

*Growth.* The effects of temperature (**tab. 1**) and salinity on shell growth of *M. edulis* (**fig. 1.1A**) significantly interacted with each other (2-fact. ANOVA,  $F = 6.08$ ,  $p < 0.001$ ). Still, for all salinities (SAL 15, 25 and 35), growth rate was lowest at the highest temperature, 25 °C. However, at SAL 15, shell growth showed a unimodal regression and peaked at 10 °C ( $R^2 = 0.68$ ,  $F = 18.13$ ,  $p < 0.001$ ). At SAL 25, shell growth decreased with increasing temperature (linear regression,  $R^2 = 0.58$ ,  $F = 24.59$ ,  $p < 0.001$ ) being interrupted by a drop at 16 °C. Finally, at SAL 35 we found a significant growth reduction only at 25 °C. **Figure 1.1** also shows that salinity only influenced shell growth at 3 of the 5 temperatures: (i) at 4 °C we found an optimum growth at salinity 25, (ii) at 10 °C and salinity 35 shell growth was reduced compared to lower salinities and (iii) at 25 °C shell growth increased from salinity 15 to salinity 25 and then decreased again to an intermediate value at salinity 35.



**Figure 1.1:** *M. edulis* shell growth [mm/week]. Mean growth rate of all individuals in the culture basins. Horizontal lines and equal letters indicate statistically equal groups with respect to temperature and salinity, respectively. Error bars show standard deviations.

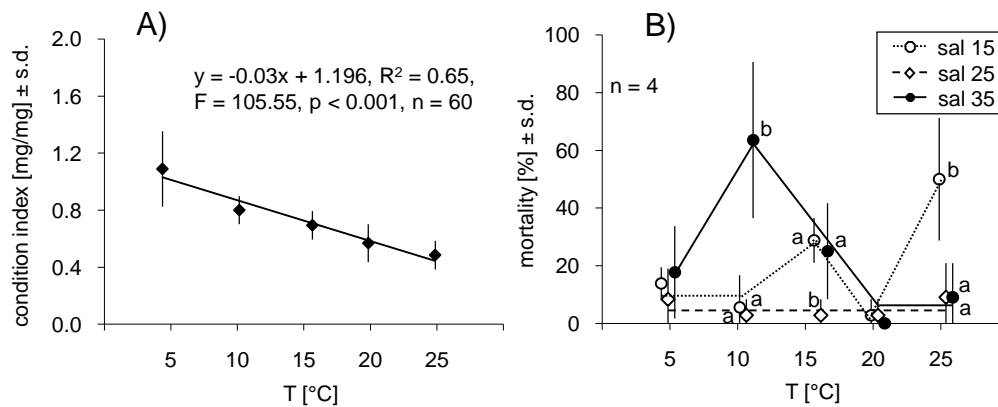
**Stress.** Lipofuscin levels ( $RFI_{corr}$ ) in *M. edulis* soft tissue increased with temperature under all three salinity conditions (**fig. 1.2**). Salinity had a direct increasing effect on the lipofuscin content only at 10 °C but it significantly modulated the overall strong temperature effect (interaction: 2-fact. ANOVA,  $F = 2.74$ ,  $p = 0.015$ ). At salinity 15, the increase of  $RFI_{corr}$  from 4 °C to 25 °C followed a quadratic curve ( $R^2 = 0.72$ ,  $F = 21.89$ ,  $p < 0.001$ ). At salinity 25,  $RFI_{corr}$  remained low from 4 °C to 16 °C and then increased to a higher level at 20 °C and 25 °C. Finally, at salinity 35, the lipofuscin content in the bivalves increased from 4 °C to a plateau between 10 °C and 16 °C and peaked at 20 °C. Lipofuscin contents were inversely related to shell growth ( $r = -0.40$ ,  $p = 0.001$ ).



**Figure 1.2:** Relative fluorescence intensity emitted by the aging pigment lipofuscin in *M. edulis* soft tissue. Original values were corrected by incubation time and shell length at the start of the experiment. Horizontal lines and equal letters indicate statistically equal groups with respect to temperature and salinity, respectively. Error bars show standard deviations. \* = significant regression at salinity 15 with  $R^2 = 0.72$ ,  $p < 0.001$ , model:  $y = 0.0139x^2 - 0.2188x + 1.4315$ ,  $n = 20$ .

**Fitness.** The condition index ( $C_i$ ) of *M. edulis* was not influenced by salinity (2-fact. ANOVA,  $F = 2.61$ ,  $p = 0.085$ ) but linearly decreased with increasing temperatures (**fig. 1.3A**, linear regression,  $R^2 = 0.65$ ,  $F = 105.55$ ,  $p < 0.001$ ).  $C_i$  was positively correlated to shell growth ( $r = 0.37$ ,  $p = 0.003$ ) and negatively to lipofuscin accumulation ( $r = -0.58$ ,  $p < 0.001$ ).

Mortality of *M. edulis* showed an inconsistent pattern (interaction: 2-fact. ANOVA,  $F = 3.09$ ,  $p = 0.007$ ; **fig. 1.3B**). At salinity 25, mortality was generally low. At salinity 15, mortality showed peaks at 16 °C and at 25 °C and at salinity 35 a clear maximum of the mortality with 63.54 % ( $\pm 27.08 \sigma$ ) was found at 10 °C. Still, mortality was inversely related to shell growth ( $r = -0.44$ ,  $p < 0.001$ ).

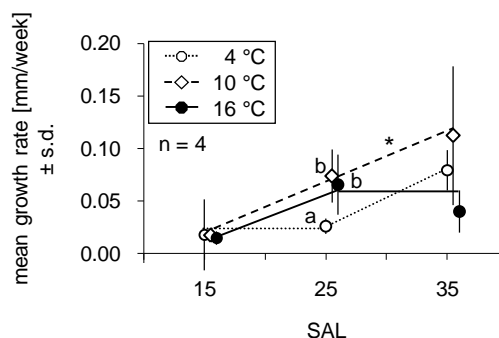


**Figure 1.3:** *M. edulis* fitness parameters A) condition index ( $C_i$  = soft tissue weight [mg] / shell weight [mg]) and B) mortality [%]. In B), horizontal lines and equal letters indicate statistically equal groups with respect to temperature and salinity, respectively. Error bars show standard deviations.

*A. islandica*

**Growth.** The main salinity effect on shell growth of *A. islandica* was partly blurred by a significant temperature effect at salinity 25 (interaction: 2-fact. ANOVA,  $F = 3.12$ ,  $p = 0.03$ ; **fig. 1.4**). Here, the bivalves grew less at 4 °C than at higher temperatures.

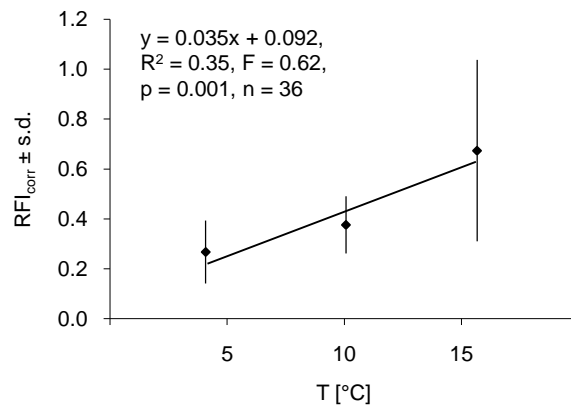
At 4 °C, growth was highest at salinity 35. At 10 °C, it increased linearly with higher salinity (linear regression,  $R^2 = 0.66$ ,  $F = 18.95$ ,  $p = 0.001$ ). At 16 °C, finally, shell growth increased, parallel to the values at 10 °C, from salinity 15 to salinity 25 but then remained at that level.



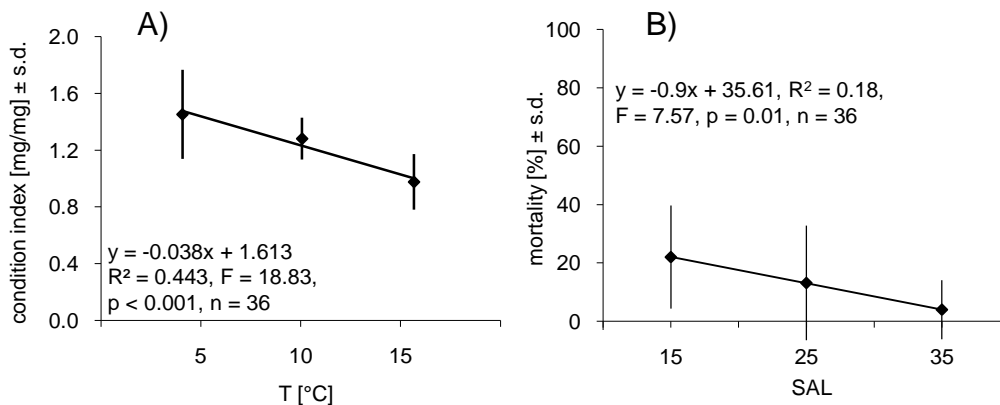
**Figure 1.4:** *A. islandica* shell growth [mm/week]. Mean growth rate of all individuals in the culture basins. Horizontal lines and equal letters indicate statistically equal groups with respect to temperature and salinity, respectively. Error bars show standard deviations.

\* = Significant regression:  $R^2 = 0.66$ ,  $p = 0.001$ ,  $y = 0.005x - 0.052$ ,  $n = 12$ .

**Stress.** The Lipofuscin content ( $RFI_{corr}$ ) in the soft tissue of *A. islandica* (mean of all:  $0.44 \pm 0.08$  se) was generally lower than in *M. edulis* (mean of temperatures 4 °C, 10 °C and 16 °C:  $0.97 \pm 0.20$  se, t-test:  $t: 3.72$ ,  $p < 0.001$ ) and increased linearly from 4 °C to 16 °C (**fig. 1.5**; linear regression:  $R^2 = 0.35$ ,  $F = 13.62$ ,  $p = 0.001$ ). Salinity did not influence  $RFI_{corr}$  of *A. islandica*.



**Figure 1.5:** Relative fluorescence intensity emitted by the aging pigment Lipofuscin in *A. islandica* soft tissue. Original values were corrected by incubation time and shell length at the start of the experiment. Error bars show standard deviations.



**Figure 1.6:** *A. islandica* fitness parameters A) condition index ( $C_i$  = soft tissue weight [mg] / shell weight [mg]) and B) mortality [%]. Error bars show standard deviations.

**Fitness.** Like in *M. edulis*, the  $C_i$  of *A. islandica* was not influenced by salinity (2-fact. ANOVA,  $F = 1.07$ ,  $p = 0.365$ ) but linearly decreased with temperature (**fig. 1.6A**, linear regression,  $R^2 = 0.43$ ,  $F = 18.83$ ,  $p < 0.001$ ). Additionally, the  $C_i$  was negatively correlated to  $RFI_{corr}$  ( $r = -0.68$ ,  $p < 0.001$ ).

Mortality of *A. islandica* of all treatments decreased, despite high variances, significantly with higher salinity (**fig. 1.6**; 2-fact. ANOVA,  $F = 3.61$ ,  $p = 0.04$ ).

## 1.4 Discussion

*Growth.* After Kautsky (1982), *M. edulis* growth rates can have large variations (2.2 mm / yr - 50 mm / 18 month resp. ca. 0.04 – 0.64 mm / week) being mainly controlled by salinity, temperature and food supply.

In the present study, we found highest growth rates of *M. edulis* at the lowest temperatures of the two lowest salinities (SAL 15: 10 °C, SAL 25: 4 and 10 °C). In both salinity treatments (15 and 25) shell growth decreased more or less constantly with increasing temperatures. At high salinity (35), growth remained unchanged at an intermediate level until it dropped at the highest incubation temperature of 25 °C.

Despite the relatively steep growth reduction at a temperature higher than 20 °C, our results contradict the findings of Almada-Villela *et al.* (1982, 1984) and Reuter (2004) who found increasing shell growth with higher temperature (between 3 and 20 °C) and higher salinity (between 12 and 32). The unimodal growth-salinity relationship (SAL 12 – 34) found by Kossak (2006) could only be found at the extreme temperatures (4 and 25 °C) of our experiment and not as a general pattern. But in cases of significant salinity effects, growth was never at the highest level at salinity 35, suggesting optimal salinities for *M. edulis* at estuarine conditions. Indeed, with the exception of 16 °C, mean growth rates at salinity 25 were always highest or statistically equal to the highest values, corroborating Kossak's (2006) findings. The same study, however, showed that a positive effect of temperature on shell growth only appeared under very high phytoplankton concentrations (double of typical present day concentration). At normal food concentrations the mean growth at the increased temperature treatment was indeed lower than at the normal present day temperature, which matches our results. Additionally, Jörgensen *et al.* (1990) explained that the filtration rate of *M. edulis* increases, independently of the bivalve's physiology, with higher temperature as the viscosity of the water decreases. This may explain higher growth rates at higher temperatures only if the latter corresponds with increased phytoplankton availability which can but does not need to be the case in natural environments. Page and Hubbard (1987) already showed that temperature and growth of *M. edulis* are not directly correlated but, via phytoplankton supply, linked. This could partly be corroborated here, as the absence of a positive effect of higher temperatures on growth rates might be due to equal food supply at all temperatures.

In the present study *M. edulis* growth rate was comparably low over all temperatures and salinities (on average < 0.2 mm / week). Despite reasonable food supply, this might be due to nutritional limitation because of the artificial food composition and / or pulse-like feeding.

In contrast to *M. edulis*, growth in *A. islandica* was mainly regulated by salinity and not by temperature. Still, our findings are not in contrast to the temperature dependence found by Witbaard *et al.* (1997) as at high salinities (35) both studies show higher mean shell growth at about 10 °C than at about 5 °C. The reduced mean shell growth we found at 16 °C corroborates the distribution limit of 16 °C observed in the field (Cargnelli *et al.* 1999; Witbaard and Bergman 2003).

Increasing salinities resulted in an increase in growth. This effect was clearest at 10 °C, while at low temperatures (4 °C) it set in only at salinity 25 and at high temperatures (16 °C) it stopped already at salinity 25.

*Cellular Stress.* In both species, lipofuscin accumulation increased strongly with temperature. This fact convenes our expectations as in ectothermal organisms metabolic rates have been found to increase with increasing temperature (e.g. Clarke, 2003). Higher metabolism bears the risk of an increase in free radical production leading to higher oxidative cellular damage (Sukhotin *et al.* 2002). The observed increase in lipofuscin accumulation with increasing temperature indicates that indeed under higher temperature regimes cellular damage takes place in *M. edulis* and *A. islandica*. Free radical defence mechanisms like antioxidant enzymes (e.g. catalase or superoxide dismutase) or low molecular antioxidants (e.g. glutathione) were seemingly not able to prevent oxidative cellular damage. Further, lipofuscin represents irreversibly damaged cellular structures. Thus, cellular repair mechanisms in *M. edulis* and *A. islandica* were not sufficient to repair and remove damaged structures from the cell, leading to the increase in lipofuscin.

In contrast to our findings, an inverse relationship between lipofuscin accumulation and temperature was found in *M. galloprovincialis* (Petrovic *et al.* 2004). Lipofuscin, however, was measured in digestive tissues and not in the complete soft body, as in the present study. Lipofuscin measurements of bivalve digestive gland have been used in several studies to identify environmental effects (e.g. pollution) on the animals' cellular integrity (Moore 1990; Byrne and O'Halloran 2000). While in postmitotic or low proliferating tissues like muscle or nervous tissue lipofuscin accumulates permanently in the cells, lipofuscin accumulation in the high proliferating digestive gland is more flexible and can be removed from the tissue. Digestive gland lipofuscin concentrations might thus rather reflect the acute state of lipofuscin accumulation. In digestive gland cells of the Antarctic limpet *Nacella concinna*, higher lipofuscin accumulation rates were found when kept under short-term high-temperature regimes (Abele *et al.* 1998). Long-term effects of temperature on lipofuscin accumulation rates in postmitotic neuronal tissue in crayfish were investigated by Sheehy (2002). He conducted an experiment in which animals were kept at different



temperature regimes over 25 month. A clear positive correlation of temperature and lipofuscin accumulation was observed in that study.

In the present study lipofuscin content was measured in whole animals, including all tissues of different proliferation rate, and thus is likely to reflect long term trends in lipofuscin accumulation. Our results indicate that in both species higher lipid and protein oxidation rates can be expected with anthropogenic increase of seawater temperature - at least in the absence of an adaptation on the population level. This may lead to a decrease in growth as more energy might be needed for cellular maintenance. Furthermore, increased lipofuscin accumulation has the potential to alter physiological processes like proteasome activity (Sitte *et al.* 2000) or lysosomal activity, which could then lead to a higher vulnerability towards other environmental stressors, e.g. salinity changes.

In general, for the investigation of bivalve cellular stress induced by long-term changes of environmental conditions, lipofuscin accumulation in the whole body seems to be a well-working and easy tool. In both investigated species it correlated negatively with the condition index. Still, only in *M. edulis* lipofuscin content was also negatively correlated to growth. Therefore, every species, whose lipofuscin accumulation is considered as a stress proxy, needs to be accurately validated and calibrated.

The overall lower lipofuscin accumulation in *A. islandica* compared to *M. edulis* is in line with previous findings for an Icelandic *A. islandica* population. Protein oxidation concentrations (protein carbonyls) and lipofuscin concentrations were far lower in *A. islandica* (Strahl *et al.* 2007) compared to other bivalve species (Philipp and Abele, in review). This might result from the high level of antioxidant capacity found in the Iceland *A. islandica* (Abele *et al.* 2008), which might also hold true for the Baltic Sea population. Additionally, metabolism of different *A. islandica* populations (including Baltic Sea) was found to be generally lower compared to other bivalve species (Begum *et al.*, in review), which most likely results in a generally lower free radical production and could further explain the observed low accumulation of oxidative damage.

Lipofuscin accumulation in *A. islandica* was only influenced by temperature whereas in *M. edulis* salinity had an effect on lipofuscin accumulation, too. At lower temperatures (4, 10 and 16 °C), lipofuscin concentrations were stable in *M. edulis* at salinity 15 and 25. At salinity 35 however, lipofuscin accumulation increased significantly in animals held at 10 °C compared to 4 °C. Higher salinity might probably lead to a higher basic metabolism in *M. edulis* adapted to the low salinity regime of Kiel Bay due to increased ion regulation. Due to this salinity-related increase in metabolism, the threshold at which the amount of free radical production exceeds cellular defence and repair capacity might be reached at lower temperatures.

*Fitness.* In *M. edulis* shell growth as well as the condition index decreased with higher temperatures. This shows that at high stress levels, soft tissue grew even less than the shell.

The condition index of *A. islandica* was decreased with temperature and was inversely related to lipofuscin accumulation. This shows the bivalves indeed were suffering from stress at higher temperatures, however, not to an extent that growth would have been significantly reduced.

In both species, higher mortality coincided with lower growth rates. In *A. islandica*, this appeared to be the general trend, both parameters depending on salinity, without leading to a significant correlation. Whereas in *M. edulis*, treatment combinations with high cellular stress levels had lower growth rates and at the same time higher mortalities, as well. Low mortality of *M. edulis* at salinity 25 mirrors the maximum growth rates at this salinity under extreme temperatures (4 and 25 °C) in our study.

Together with the observation of higher robustness of *M. edulis* towards temperature induced cellular stress and highest growth rates at salinities lower than 35, the reduced mortalities at salinity 25 adds confidence to the assumption of *M. edulis* being rather an estuarine than a fully marine species (Kossak 2006). Additionally, *M. edulis*' fitness, cellular stress and growth rates are mainly controlled by temperature. This demonstrates the relative robustness of this species against changes in salinities that often occur in shallow estuarine environments. However, if, as predicted, in the future temperatures exceeding 20 °C will occur more often, competitiveness of *M. edulis* may be reduced due to increased cellular damage which consumes resources that would otherwise be available for growth or reproduction. The resistance towards this temperature-induced stress will be highest at intermediate salinities (SAL 25), e.g. of the Kattegat region.

In contrast to *M. edulis*, *A. islandica* appears to be a high saline species as we found lowest mortalities and highest growth rates at salinity 35. From our results we infer that the predicted further desalination of the Baltic Sea by higher precipitation will result in lower growth rates and higher mortalities of the Baltic Sea *A. islandica* population and in a shift of the distribution limit north-westwards towards the higher-saline Kattegat and North Sea region. Additionally, higher temperatures will increase cellular damage that weakens the condition of *A. islandica* independently of the salinity regime. Especially in relatively warm high-saline regimes like the North Sea this can lead to reduced growth and competitiveness of the *A. islandica* population.

*Conclusion.* Cellular stress of both species increased primarily with temperature. It showed only a correlation with growth of *M. edulis* and not of *A. islandica*. As it correlated well with the condition index of both species, it appears to be an applicable stress proxy for ecological studies of both bivalve species, though.

Lipofuscin accumulation, growth rates and mortalities indicate that *M. edulis* is rather an estuarine than a high-saline species. Condition index and growth of this species are mainly controlled by temperature. In future, *M. edulis* will suffer more often from temperatures higher than 20 °C. The resistance towards this temperature stress will be highest at intermediate salinities (SAL 25), e.g. of the Kattegat region.

Mortality and growth rates data of *A. islandica* speak for a high saline species. Baltic Sea *A. islandica* will suffer from future desalination in the estuarine Baltic Sea whereas North Sea individuals will be more affected by higher temperatures in the high saline but relatively warm North Sea.

## Chapter 2

### Experimentally determined Shell Chemistry Characteristics ( $\Delta^{44/40}\text{Ca}$ , $D_{\text{Mg}}$ and $D_{\text{Sr}}$ ) of young *Mytilus edulis* L. and *Arctica islandica* L. as possible Tracer for SST and Salinity

#### Abstract

Recent studies indicate that the ratio of stable Ca isotopes and the ratio of divalent substituents of Ca (Mg, Sr) in bivalve shells depend on environmental seawater temperatures and can therefore theoretically be used as proxies for paleo-climata.

In this study, we investigated the influence of temperature and salinity regimes on calcium isotope fractionation ( $\Delta^{44/40}\text{Ca}$ ) and  $D_{\text{Mg}}$  and  $D_{\text{Sr}}$  in shells of cultured bivalves (*M. edulis* and *A. islandica*). In a fully crossed 2-factorial (temperature vs. salinity) experiment, the bivalves were allowed to grow for 15 weeks under tightly controlled conditions. Newly grown shell material was probed and analysed by thermal ionisation mass spectrometry (TIMS) and optical emission spectrometry (ICP-OES).

Concerning the 3 proxies evaluated in this study, the  $D_{\text{Sr}}$  proxy for seawater Sr / Ca composition (*M. edulis*) respectively salinity (*A. islandica*) seems to be the most reliable. Still, in *A. islandica* shells, it can be blurred by temperature effects at low salinities. In *M. edulis* calcite,  $D_{\text{Mg}}$  correlates well with seawater temperatures but it is also influenced by salinity.

Ca isotope ratios in *A. islandica* relate well with temperature (with a shallow slope of 0.011 ‰ per °C) and are independent of salinity. With regard to our results, Ca isotope ratios in *M. edulis* shells cannot be used as a paleo-temperature proxy.

Overall, calcitic shells of *M. edulis* appear to provide better element ratio proxies ( $D_{\text{Mg}}$  for temperature and  $D_{\text{Sr}}$  for seawater Sr / Ca) and aragonitic shells of *A. islandica* the better Ca isotope-temperature proxy.

## 2.1 Introduction

The improvement of climate models requires a better understanding of climate history. As reliable historical observations are rare, diagenetically stable archives with high resolution over decades and centuries are needed to reconstruct past climate scenarios.

Recent studies show that several bivalve shell chemistry characteristics depend on seawater temperatures and can therefore theoretically be used as proxies for paleo-climata. Stable oxygen isotopes ( $\delta^{18}\text{O}$ ) in the Blue Mussel *Mytilus edulis*, for example, were found to be a strong paleo-thermometer, in particular as no vital effects (age, size, growth rates, and populations) were found to blur the close relationship with temperature (Wanamaker *et al.* 2007). Still, as the carbonate is precipitated in isotopic equilibrium with the ambient seawater with respect to oxygen, changes in seawater  $\delta^{18}\text{O}$  are recorded, too. As  $\delta^{18}\text{O}$  in seawater correlates with salinity, this can lead, e.g., to an overestimation of peak temperatures when high temperatures coincide with high rainfalls (Klein *et al.* 1996a; Immenhauser *et al.* 2005) or other precipitation or evaporation events.

With the aim of compensating this weakness of the  $\delta^{18}\text{O}$ -temperature proxy by a multi-proxy approach, the reliability of minor element ratios (Mg / Ca, Sr / Ca) as proxies for environmental parameters was already addressed in studies on different recent and fossil bivalve species (Klein *et al.* 1996a; Klein *et al.* 1996b; Hendry *et al.* 2001; Holmden and Hudson 2003; Lazareth *et al.* 2003; Freitas *et al.* 2005; Immenhauser *et al.* 2005; Freitas *et al.* 2008; Surge and Lohmann 2008). To date, however, most studies found rather weak relationships. The authors emphasized the limitations of these element ratio proxies since metabolic effects are thought to be too strong (Vander Putten *et al.* 2000; Immenhauser *et al.* 2005; Freitas *et al.* 2008) and biomineralization processes are still too poorly understood (Heinemann *et al.* 2008). However, in a recent study, Wanamaker *et al.* (2008) found strong relationships of Mg / Ca and Sr / Ca with temperature in *M. edulis* shells – yet only at a relatively low salinity of 23.

Additionally, some studies addressed calcium isotope ratios as a new proxy for paleo-temperatures in coccolithophores (Gussone *et al.* 2006; Langer *et al.* 2007), foraminifers (Näglér *et al.* 2000; Gussone *et al.* 2003; Heuser *et al.* 2005; Sime *et al.* 2005; Hippler *et al.* 2007a; Kozdon 2007) and corals (Böhm *et al.* 2006), but studies of calcium isotopes in bivalve shells are still rare (Immenhauser *et al.* 2005; Hippler *et al.* 2007b; Heinemann *et al.* 2008). Immenhauser *et al.* (2005) conducted measurements of  $\delta^{44/40}\text{Ca}$  in a fossil specimen of the Cretaceous rudist bivalve *Vaccinites ultimus*. Heinemann *et al.* (2008) measured calcite and aragonite of three *M. edulis* individuals from 3 different salinity regimes.

Though it is essential to validate and calibrate every single species being considered as proxy for environmental conditions, no experimental calibration of calcium isotopes in bivalve shells with controlled environmental factors has been published so far. Additionally, the attempts to calibrate the minor element ratios Mg / Ca and Sr / Ca in bivalve shells mentioned above either measured only few specimens or used a too low independent replication of controlled treatment factors to warrant statistically robust results.

In this study, *Arctica islandica* (L.) and *Mytilus edulis* (L.) were cultured in constant temperature laboratories under tightly controlled environmental conditions for 15 weeks to assess the influence of water temperature on the ratio of stable Ca isotopes ( $\delta^{44/40}\text{Ca}$ ) and on the proportion of the two divalent Ca substituents Mg and Sr.

The two bivalve species selected are long lived, relatively large and grow fast enough to provide sufficient amounts of shell material within a few months. Both species live in the North Atlantic Ocean as well as in the estuarine Baltic Sea (Loosanoff 1953; Theede *et al.* 1969; Gosling 1992; Bers 2006) – *A. islandica* in the sandy sea bottom and *M. edulis* attached to hard substrata or as loose beds on sandy substrata.

As *M. edulis*' calcification rate depends on temperature and salinity (Malone and Dodd 1967) and as it is known that effects of different environmental parameters on bivalve shell growth can interact (e.g. Kossak 2007), this may also be the case with regard to Ca isotope and Ca substituent ratios (Heinemann *et al.* 2008; Wanamaker *et al.* 2008).

Therefore, the shell chemistry characteristics of *A. islandica* and *M. edulis* were evaluated in fully crossed 2-factorial (temperature vs. salinity) experiments to explore the possible sensitivity of temperature effects towards salinity.

## 2.2 Materials and Methods

**Culture.** For a 15 week period, individually marked *M. edulis* and *A. islandica* specimens were cultured under different temperature treatments (*Mytilus*: 4, 10, 16, 20 and 25°C, *Arctica*: 4, 10 and 16 °C) in constant temperature basins at IFM-GEOMAR in Kiel, Germany. The young *M. edulis* specimens, collected in the Kiel fjord, had an individual height (measured from the umbo to the opposite side of the shell) of 10.09 to 21.52 mm. *A. islandica* specimens were dredged at the station “Süderfahrt” (54°32.6’ N, 10°42.1’ E) west of Fehmarn Island in Kiel Bight, Baltic Sea. *A. islandica* initial height was between 10.19 and 26.81 mm.

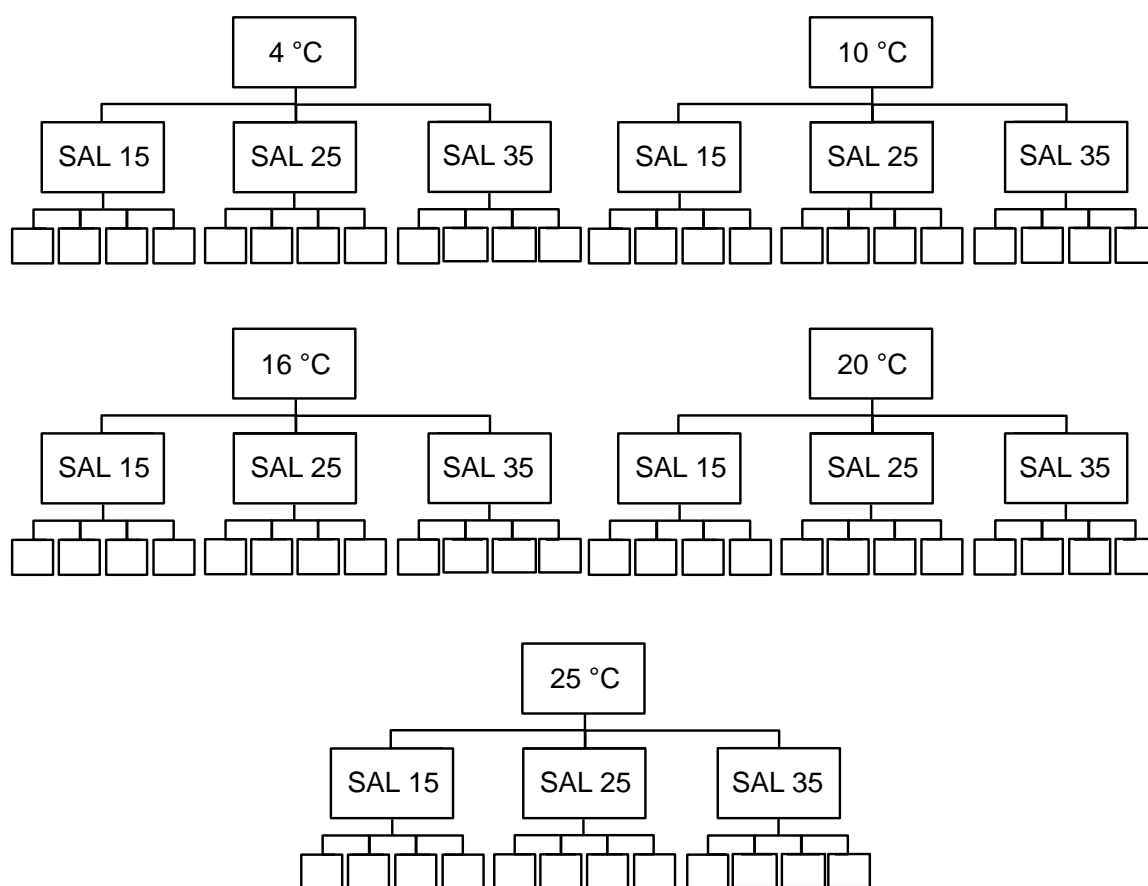
Bivalves were fed 5 days a week with 0.5 ml / animal / d (approximately 15 mg algal biomass (dry weight) / animal / d) of a concentrated living-phytoplankton suspension (DT’s Premium Blend). Temperatures in experimental basins were logged with HOBO® (Onset Computer Corporation, Pocasset, MA) temperature loggers (**tab. 2.1**).

Treatments of salinities 15, 25 and 35 were realized in 12 4-l-containers nested within each temperature basin (**fig. 2.1**). Salinity levels were set by mixing fresh Baltic seawater with either ion exchanged water (SAL 15) or artificial sea salt (SAL 25 and SAL 35, salt: SEEQUASAL). Level of replication was 4.

**Table 2.1:** Measured mean temperatures of treatments and standard deviations (s.d.):

	treatment level:	4 °C	10 °C	16 °C	20 °C	25 °C
A. islandica	mean:	4.1	10.1	15.7	-	-
	s.d.:	0.2	0.3	0.6		
M. edulis	mean:	4.4	10.2	15.6	19.9	24.9
	s.d.:	0.1	0.1	0.9	0.3	0.1

**Treatment water conditions.** Ca, Mg and Sr concentrations in the treatment water were measured by inductively coupled plasma optical emission spectrometry (ICP-OES) and Ca isotope composition by multi-collector thermal ionization mass spectrometry (MC-TIMS, Thermo Finnigan TRITON T1) at IFM-GEOMAR in Kiel in the beginning (20.10.2006) and at the end (11.03.2007) of the experiment. Beforehand, for Ca isotope measurements, the calcium in the water samples was isolated from potentially interfering elements (e.g. K, Sr, Mg) by cation exchange and HCl elution (Amini 2007; Heinemann *et al.* 2008).



**Figure 2.1:** Experimental design: At each of the five temperature levels the bivalve were culture in (4, 10, 16, 20 and 25 °C) three salinity treatments (15, 25 and 35) were realised. All temperature-salinity treatment combinations were replicated four times. For *A. islandica*, only temperature levels 4 to 16 °C were implemented.

*Data collection.* Shell growth of the 96 cultured bivalves was monitored by repeated measurements of shell length. The animal's soft tissue was removed and the shell material that was grown since the start of the experiment (only calcite at *M. edulis* shells) was cut from the old shell, using a cut-off wheel.

Ca isotopes were measured by MC-TIMS at IFM-GEOMAR, Kiel, for each of the 96 independently grown individual bivalves. For this, 2 mg of Ca carbonate of the sampled shell margins was dissolved in 2.2 N hydrochloric acid. For single measurements, aliquots corresponding to ~300 ng Ca were taken and potentially remaining organic fractions oxidized with 30% H<sub>2</sub>O<sub>2</sub>. The measuring procedure followed Heuser *et al.* (2002) using a <sup>43</sup>Ca / <sup>48</sup>Ca double spike and the international NIST SRM 915a calcium standard for normalization.  $\delta^{44/40}\text{Ca}$  was calculated as  $\delta^{44/40}\text{Ca}_{\text{sample}} = [({}^{44}\text{Ca} / {}^{40}\text{Ca})_{\text{sample}} / ({}^{44}\text{Ca} / {}^{40}\text{Ca})_{\text{NIST}} - 1] * 1000$  (Eisenhauer *et al.* 2004). Data are presented here as  $\Delta^{44/40}\text{Ca}$ , with  $\Delta^{44/40}\text{Ca} = \delta^{44/40}\text{Ca}_{\text{sample}} - \delta^{44/40}\text{Ca}_{\text{treatment water}}$ , representing the fractionation between dissolved and



solid Ca. The  $\delta^{44/40}\text{Ca}_{\text{treatment water}}$  was  $1.83 \pm 0.09 \text{ ‰}$  (s.d.) relative to  $\delta^{44/40}\text{Ca}_{\text{NIST}}$  at salinity 15,  $1.71 \pm 0.08 \text{ ‰}$  (s.d.) at salinity 25 and  $1.59 \pm 0.08 \text{ ‰}$  (s.d.) at salinity 35, respectively. Differences were caused by the different amount of artificial sea-salt in the three treatments. Standard deviations (s.d.) indicate variations of the water samples ( $n = 16$ ). The external precision for the NIST SRM 915a standard over the whole measuring period was  $0.003 \text{ ‰}$  (s.d.,  $n = 93$ ). The 2 s.e. precision of repeated sample aliquot analyses was always  $< 0.15 \text{ ‰}$ .

The samples were analyzed for Ca, Mg and Sr elemental concentrations by ICP-OES at the Institute of Geosciences at Kiel University. For this purpose, an aliquot of each dissolved sample was dried and re-dissolved in 2 %  $\text{HNO}_3$ . The mean precision (2 s.e.) of repeated measures of the ECRM 752-1 standard was  $0.002 \text{ mmol / mol}$  for Sr / Ca and  $0.004 \text{ mmol / mol}$  for Mg / Ca. The element ratios differed in the solution used for the three salinity treatments (Mg / Ca:  $4712.0 \text{ mmol / mol} \pm 0.12$  (s.d.) at SAL 15,  $5896.7 \text{ mmol / mol} \pm 0.05$  (s.d.) at SAL 25 and  $6344.5 \text{ mmol / mol} \pm 0.14$  (s.d.) at SAL 35; Sr / Ca:  $7.48 \text{ mmol / mol} \pm 0.18$  (s.d.) at SAL 15,  $6.27 \text{ mmol / mol} \pm 0.74$  (s.d.) at SAL 25 and  $5.67 \text{ mmol / mol} \pm 0.17$  (s.d.) at SAL 35). Therefore, Mg and Sr data are presented as distribution coefficients,  $D_{\text{Me}} = (\text{Me} / \text{Ca}_{\text{solid}}) / (\text{Me} / \text{Ca}_{\text{fluid}})$ .

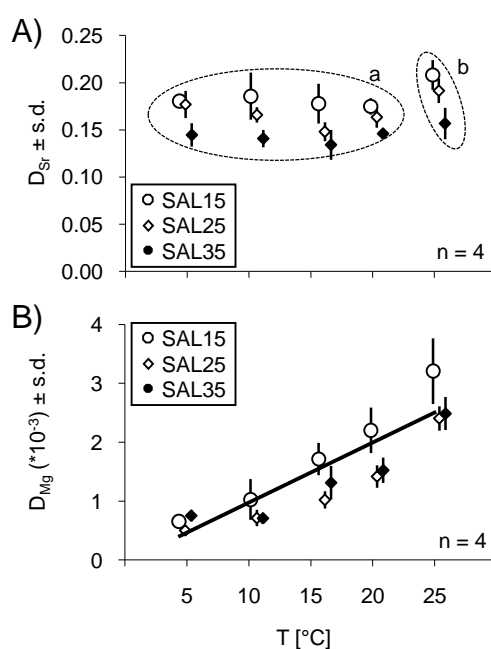
*Data analyses.* Not normally distributed data or datasets of unequal variances were square root-, 4<sup>th</sup>- root or log- transformed to meet the necessary assumptions for an ANOVA. In the case of an ineffective transformation the significance level  $\alpha$  was lowered to 0.01 to reduce the risk of type-1 errors (Glasby 1998). Data were analysed for statistically significant effects and interactions of treatment factors by 2-factorial ANOVA and, in case of clear trends, by linear regression. Differences between single treatment levels were identified by Tukey HSD post-hoc test. All statistical tests were provided by Statistica 8.0 software package.

## 2.3 Results

*M. edulis*. Distribution coefficients of ( $D_{Mg}$ ) in *M. edulis* calcite shells were significantly influenced by the salinity treatment (2-fact. ANOVA,  $F = 25.08$ ,  $p < 0.001$ ). Concerning all temperature treatments higher than 4 °C, average  $D_{Mg}$  was higher (37 %) at salinity 15 than at 25 and 35 (fig. 2.2B). Also, for all salinity conditions (15, 25 and 35),  $D_{Mg}$  linearly increased with temperature from 4 °C to 25 °C (fig. 2.2B, eq. 2.1).

$$D_{Mg} (*10^{-3}) = 0.098(\pm 0.015) * T - 0.026(\pm 0.250), \quad (2.1)$$

$$R^2 = 0.75, F = 170.32, p < 0.001, \text{ errors: } 95\% \text{ CI, } n = 60.$$

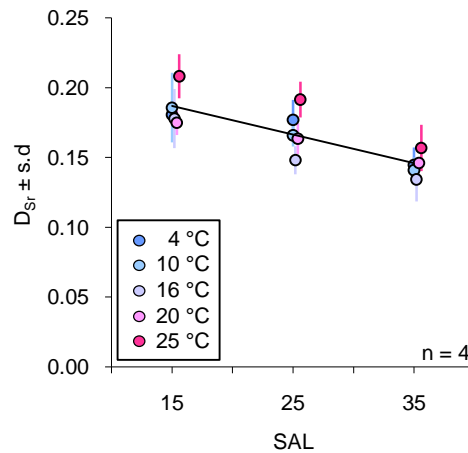


**Figure 2.2:**  $D_{Sr}$  (A) and  $D_{Mg}$  (B) in shells of *M. edulis* in dependence of temperature. Equal letters in A) indicate significantly equal groups with respect to temperature. Error bars show standard deviations (s.d.) of measured individuals (n). Bold line in B): significant linear regression for all salinity conditions (15, 25 and 35) with  $R^2 = 0.75$ ,  $p < 0.001$ . Model ( $\pm 95\%$  CI):  $D_{Mg} (*10^{-3}) = 0.098(\pm 0.015) * T - 0.026(\pm 0.250)$ ,  $n = 60$ .

For all temperature treatments (4, 10, 16, 20 and 25 °C), distribution coefficients of Sr ( $D_{Sr}$ ) in *M. edulis* shells, in contrast to  $D_{Mg}$ , decreased linearly from salinity 15 to 35 (**fig. 2.2A and 2.3**):

$$D_{Sr} = -0.0020(\pm 0.0005) * SAL - 0.217(\pm 0.014), \quad (2.2)$$

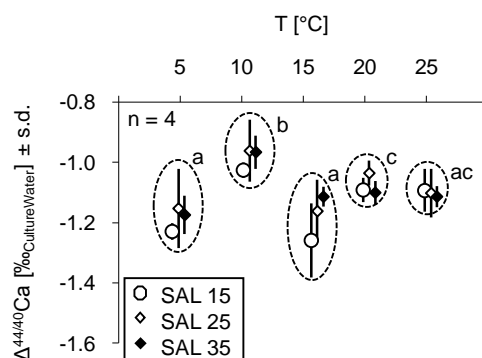
$$R^2 = 0.50, F = 57.22, p < 0.001, \text{ errors: } 95\% \text{ CI, } n = 60.$$



**Figure 2.3:**  $D_{Sr}$  in shells of *M. edulis* in dependence of salinity and temperature treatments (4, 10, 16, 20 and 25 °C). Error bars show standard deviations (s.d.) of measured individuals (n). Significant linear regression for all temperature conditions (4, 10, 16, 20 and 25 °C) with  $R^2 = 0.50$  and  $p < 0.001$ . Model ( $\pm 95\%$  CI):  $D_{Sr} = -0.0020(\pm 0.0005) * SAL - 0.217(\pm 0.014)$ ,  $n = 60$ .

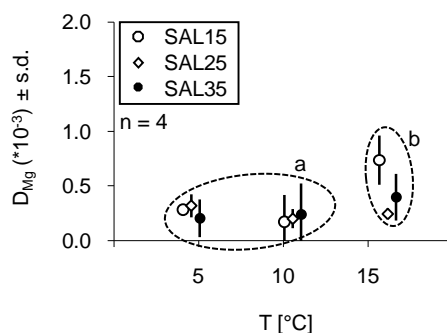
$D_{Sr}$  was slightly increased (15 %) at 25 °C compared to lower temperatures (**fig. 2.2A and 2.3**, 2-fact. ANOVA,  $F = 8.84$ ,  $p < 0.001$ ). In *M. edulis* shell calcite,  $D_{Sr}$  and  $D_{Mg}$  correlated significantly with each other ( $r = 0.40$ ,  $p = 0.002$ ).

Calcium isotope fractionation ( $\Delta^{44/40}Ca$ ) of all measurements of *M. edulis* calcite ranged between -0.82 ‰ and -1.38 ‰, with an average of  $-1.11 \pm 0.10$  ‰ (s.d.). It was influenced by both, temperature and salinity (2-fact. ANOVA, temperature:  $F = 15.43$ ,  $p < 0.001$ , salinity:  $F = 3.46$ ,  $p = 0.040$ ). **Figure 5** shows a minor salinity effect at temperatures 4, 10 and 16 °C with slightly (4%) stronger mean fractionation at salinity 15 compared to salinities 25 and 35. Single temperature effects were stronger, but without a clear trend, either (**fig. 2.4**). In *M. edulis*,  $\Delta^{44/40}Ca$  was not correlated to one of the measured element distribution coefficients ( $D_{Mg}$ :  $r = 0.10$ ,  $p = 0.460$ ;  $D_{Sr}$ :  $r = 0.15$ ,  $p < 0.255$ ).



**Figure 2.4:** Calcium isotope fractionation ( $\Delta^{44/40}\text{Ca}$ ) in shells of *M. edulis* in dependence of temperature and salinity. Different letters indicate significantly different groups with respect to temperature. Error bars show standard deviations (s.d.) of measured individuals (n).

*A. islandica*.  $D_{\text{Mg}}$  in *A. islandica* aragonite shells appeared to be influenced by salinity (2-fact. ANOVA,  $F = 5.40$ ,  $p = 0.011$ ). However, this 'effect' was identified to be an artefact produced by inhomogeneous variances due to two high outliers at salinity 15 (Levene's test:  $p = 0.050$ ). For all salinities (15, 25 and 35) average  $D_{\text{Mg}}$  increased (70%) between temperatures 10 and 16 °C (**fig. 2.5**, 2-fact. ANOVA,  $F = 4.80$ ,  $p < 0.016$ ).



**Figure 2.5:**  $D_{\text{Mg}}$  in shells of *A. islandica* in dependence of temperature and salinity. Different letters indicate significantly different groups with respect to temperature. Error bars show standard deviations (s.d.) of measured individuals (n).

The  $D_{Sr}$  declined with salinity, except for the 4 °C treatment (**fig. 2.6**, interaction: 2-factor. ANOVA,  $F = 13.21$ ,  $p < 0.001$ ). At 4 °C, the values increased between salinity 15 and 25 (ANOVA,  $F = 17.26$ ,  $p < 0.001$ ). At 10 °C and 16 °C, however,  $D_{Sr}$  decreased with high significance linearly from salinity 15 to 35. In addition, the two curves are not statistically different (confidence intervals of slopes and intercepts overlap with the resp. other mean):

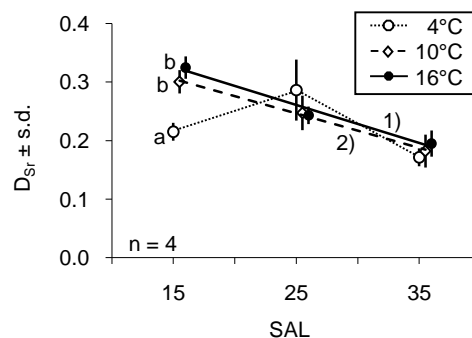
$$16 \text{ } ^\circ\text{C}: \quad D_{Sr} = -0.0065(\pm 0.0016) * \text{SAL} - 0.42(\pm 0.04), \quad (2.3)$$

$$R^2 = 0.89, F = 84.97, p < 0.001, \text{ errors: } 95\% \text{ CI, } n = 12.$$

$$10 \text{ } ^\circ\text{C}: \quad D_{Sr} = -0.0059(\pm 0.0017) * \text{SAL} - 0.39(\pm 0.05), \quad (2.4)$$

$$R^2 = 0.85, F = 55.35, p < 0.001, \text{ errors: } 95\% \text{ CI, } n = 12.$$

At salinity 15, finally, we found the only direct temperature effect on  $D_{Sr}$ : The values at 10 °C and 16 °C were significantly higher (31%) than at 4 °C (ANOVA,  $F = 54.66$ ,  $p < 0.001$ ) resulting in a linear relationship (**eq. 2.5**). Like in *M. edulis*, in *A. islandica*,  $D_{Sr}$  and  $D_{Mg}$  ( $r = 0.56$ ,  $p < 0.001$ ) were significantly correlated to each other.



**Figure 2.6:**  $D_{Sr}$  in shells of *A. islandica* in dependence of salinity. Different letters indicate significantly different groups with respect to temperature. Error bars show standard deviations (s.d.) of measured individuals. Significant linear regression results as follows ( $\pm$  95% CI):

- 1) 16 °C:  $D_{Sr} = -0.0065(\pm 0.0016) * \text{SAL} - 0.42 (\pm 0.04)$ ,  $R^2 = 0.89$ ,  $F = 84.97$ ,  $p < 0.001$ ,  $n = 12$ .
- 2) 10 °C:  $D_{Sr} = -0.0059(\pm 0.0017) * \text{SAL} - 0.39 (\pm 0.05)$ ,  $R^2 = 0.85$ ,  $F = 55.35$ ,  $p < 0.001$ ,  $n = 12$ .

$$D_{Sr} = 0.0094(\pm 0.0028) * T + 0.187(\pm 0.031), \quad (2.5)$$

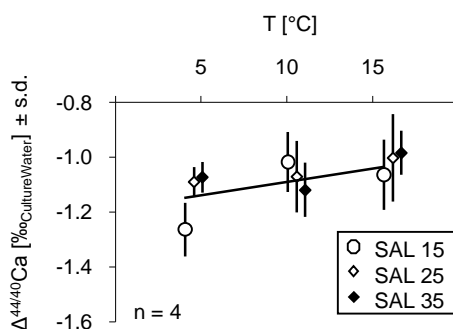
$$R^2 = 0.85, F = 56.21, p < 0.001, \text{ errors: } 95\% \text{ CI, } n = 12.$$

$\Delta^{44/40}\text{Ca}$  in *A. islandica* shell material ranged from -0.76 ‰ to -1.33 ‰. The average calcium isotope fractionation ( $\Delta^{44/40}\text{Ca}$ ) of  $-1.06 \pm 0.10$  ‰ (s.d.) we measured in all shells of *A. islandica* cannot be statistically distinguished from those in shells of *M. edulis* ( $-1.11 \pm 0.10$  ‰ (s.d.)), T-test,  $t = -1.83$ ,  $p = 0.072$ ). *A. islandica*  $\Delta^{44/40}\text{Ca}$  only depended on temperature (**fig. 2.7**), increasing linearly from 4 °C to 16 °C:

$$\Delta^{44/40}\text{Ca} = 0.011(\pm 0.008) * T - 1.19(\pm 0.09), \quad (2.6)$$

$R^2 = 0.19$ ,  $F = 8.18$ ,  $p = 0.007$ , errors: 95% CI,  $n = 36$ .

Additionally, in *A. islandica* aragonite,  $\Delta^{44/40}\text{Ca}$  correlated significantly with the Mg / Ca ratio ( $r = 0.39$ ,  $p = 0.019$ ) but not with  $D_{\text{Mg}}$  ( $r = 0.27$ ,  $p = 0.112$ ) or  $D_{\text{Sr}}$  ( $r = 0.06$ ,  $p = 0.747$ ).



**Figure 2.7:** Calcium isotope fractionation ( $\Delta^{44/40}\text{Ca}$ ) in shells of *A. islandica* in dependence of temperature. Error bars show standard deviations (s.d.) of measured individuals.

Significant linear regression for all salinities (15, 25 and 35) with  $R^2 = 0.19$  and  $p = 0.007$ .

Model ( $\pm 95\%$  CI):  $\Delta^{44/40}\text{Ca} = 0.011(\pm 0.008) * T - 1.19(\pm 0.09)$ ,  $n = 36$ .

**Table 2.2.** Results of ICP-OES and TIMS measurements: *M. edulis* data. Standard deviations (s.d.) represent variation between measured individuals of the same treatment combination (temperature and salinity).

temperature	salinity	n = (no. of individuals measured)	Mg/Ca [mmol/mol] ( $\pm$ s.d.)	$D_{Mg}$ [‰] ( $\pm$ s.d.)	Sr/Ca [mmol/mol] ( $\pm$ s.d.)	$D_{Sr}$ [‰] ( $\pm$ s.d.)	$\Delta^{44/40}Ca$ [‰] ( $\pm$ s.d.)
4 °C	15	4	3.09 ( $\pm$ 0.43)	$0.65 \cdot 10^{-3}$ ( $\pm$ 0.09)	1.35 ( $\pm$ 0.05)	0.18 ( $\pm$ 0.01)	-1.23 ( $\pm$ 0.03)
	25	4	2.95 ( $\pm$ 0.37)	$0.50 \cdot 10^{-3}$ ( $\pm$ 0.06)	1.11 ( $\pm$ 0.09)	0.18 ( $\pm$ 0.01)	-1.15 ( $\pm$ 0.13)
	35	4	4.77 ( $\pm$ 0.62)	$0.75 \cdot 10^{-3}$ ( $\pm$ 0.10)	0.82 ( $\pm$ 0.07)	0.14 ( $\pm$ 0.01)	-1.17 ( $\pm$ 0.06)
10 °C	15	4	4.84 ( $\pm$ 1.63)	$1.03 \cdot 10^{-3}$ ( $\pm$ 0.35)	1.39 ( $\pm$ 0.19)	0.19 ( $\pm$ 0.02)	-1.03 ( $\pm$ 0.03)
	25	4	4.20 ( $\pm$ 0.81)	$0.71 \cdot 10^{-3}$ ( $\pm$ 0.14)	1.04 ( $\pm$ 0.05)	0.17 ( $\pm$ 0.01)	-0.96 ( $\pm$ 0.10)
	35	4	4.48 ( $\pm$ 0.43)	$0.71 \cdot 10^{-3}$ ( $\pm$ 0.07)	0.80 ( $\pm$ 0.05)	0.14 ( $\pm$ 0.01)	-0.97 ( $\pm$ 0.06)
16 °C	15	4	8.08 ( $\pm$ 1.29)	$1.71 \cdot 10^{-3}$ ( $\pm$ 0.27)	1.33 ( $\pm$ 0.16)	0.18 ( $\pm$ 0.02)	-1.26 ( $\pm$ 0.12)
	25	4	6.02 ( $\pm$ 0.86)	$1.02 \cdot 10^{-3}$ ( $\pm$ 0.15)	0.93 ( $\pm$ 0.06)	0.15 ( $\pm$ 0.01)	-1.16 ( $\pm$ 0.10)
	35	4	8.32 ( $\pm$ 1.82)	$1.31 \cdot 10^{-3}$ ( $\pm$ 0.29)	0.76 ( $\pm$ 0.09)	0.13 ( $\pm$ 0.02)	-1.11 ( $\pm$ 0.03)
20 °C	15	4	10.37 ( $\pm$ 1.82)	$2.20 \cdot 10^{-3}$ ( $\pm$ 0.39)	1.31 ( $\pm$ 0.07)	0.17 ( $\pm$ 0.01)	-1.09 ( $\pm$ 0.04)
	25	4	8.36 ( $\pm$ 1.12)	$1.42 \cdot 10^{-3}$ ( $\pm$ 0.19)	1.02 ( $\pm$ 0.07)	0.16 ( $\pm$ 0.01)	-1.04 ( $\pm$ 0.04)
	35	4	9.67 ( $\pm$ 1.35)	$1.52 \cdot 10^{-3}$ ( $\pm$ 0.21)	0.83 ( $\pm$ 0.01)	0.15 ( $\pm$ 0.003)	-1.10 ( $\pm$ 0.04)
25 °C	15	4	15.11 ( $\pm$ 2.64)	$3.21 \cdot 10^{-3}$ ( $\pm$ 0.56)	1.56 ( $\pm$ 0.12)	0.21 ( $\pm$ 0.02)	-1.09 ( $\pm$ 0.07)
	25	4	14.18 ( $\pm$ 1.22)	$2.40 \cdot 10^{-3}$ ( $\pm$ 0.21)	1.20 ( $\pm$ 0.08)	0.19 ( $\pm$ 0.01)	-1.10 ( $\pm$ 0.08)
	35	4	15.78 ( $\pm$ 1.77)	$2.49 \cdot 10^{-3}$ ( $\pm$ 0.28)	0.89 ( $\pm$ 0.09)	0.16 ( $\pm$ 0.02)	-1.11 ( $\pm$ 0.03)

**Table 2.3.** Results of ICP-OES and TIMS measurements: *A. islandica* data. Standard deviations (s.d.) represent variation between measured individuals of the same treatment combination (temperature and salinity).

temperature	salinity	n = (no. of individuals measured)	Mg/Ca [mmol/mol] ( $\pm$ s.d.)	$D_{Mg}$ [‰] ( $\pm$ s.d.)	Sr/Ca [mmol/mol] ( $\pm$ s.d.)	$D_{Sr}$ [‰] ( $\pm$ s.d.)	$\Delta^{44/40}Ca$ [‰] ( $\pm$ s.d.)
4 °C	15	4	1.33 ( $\pm$ 0.06)	$0.28 \cdot 10^{-3}$ ( $\pm$ 0.01)	1.61 ( $\pm$ 0.12)	0.22 ( $\pm$ 0.02)	-1.26 ( $\pm$ 0.10)
	25	4	1.89 ( $\pm$ 0.63)	$0.32 \cdot 10^{-3}$ ( $\pm$ 0.11)	1.79 ( $\pm$ 0.33)	0.29 ( $\pm$ 0.05)	-1.09 ( $\pm$ 0.05)
	35	4	1.31 ( $\pm$ 1.08)	$0.21 \cdot 10^{-3}$ ( $\pm$ 0.17)	0.97 ( $\pm$ 0.09)	0.17 ( $\pm$ 0.02)	-1.07 ( $\pm$ 0.06)
10 °C	15	4	1.62 ( $\pm$ 1.18)	$0.34 \cdot 10^{-3}$ ( $\pm$ 0.25)	2.25 ( $\pm$ 0.15)	0.30 ( $\pm$ 0.02)	-1.02 ( $\pm$ 0.11)
	25	4	1.18 ( $\pm$ 0.51)	$0.20 \cdot 10^{-3}$ ( $\pm$ 0.09)	1.55 ( $\pm$ 0.18)	0.25 ( $\pm$ 0.03)	-1.07 ( $\pm$ 0.13)
	35	4	1.51 ( $\pm$ 1.81)	$0.24 \cdot 10^{-3}$ ( $\pm$ 0.28)	1.03 ( $\pm$ 0.16)	0.18 ( $\pm$ 0.03)	-1.12 ( $\pm$ 0.10)
16 °C	15	4	3.47 ( $\pm$ 1.06)	$0.74 \cdot 10^{-3}$ ( $\pm$ 0.22)	2.43 ( $\pm$ 0.14)	0.32 ( $\pm$ 0.02)	-1.06 ( $\pm$ 0.13)
	25	4	1.44 ( $\pm$ 0.30)	$0.24 \cdot 10^{-3}$ ( $\pm$ 0.05)	1.52 ( $\pm$ 0.09)	0.24 ( $\pm$ 0.01)	-1.00 ( $\pm$ 0.16)
	35	4	2.53 ( $\pm$ 1.35)	$0.40 \cdot 10^{-3}$ ( $\pm$ 0.21)	1.10 ( $\pm$ 0.13)	0.19 ( $\pm$ 0.02)	-0.98 ( $\pm$ 0.08)

## 2.4 Discussion

In both bivalve species, and therefore in each one example of biogenic aragonite and calcite,  $D_{Sr}$  was stronger controlled by salinity and  $D_{Mg}$  by temperature. In *M. edulis* shells (prismatic calcite layer) these salinity and temperature effects were consistent and not blurred by the resp. other factor. In *A. islandica* (aragonite)  $D_{Mg}$  increased only from 10 to 16 °C. Additionally, at salinity 15,  $D_{Sr}$  was also influenced by temperature.

$\Delta^{44/40}Ca$  in *A. islandica* shell material increased independently of salinity with higher temperatures. In *M. edulis* shells, in contrast, besides single significant differences, no clear  $\Delta^{44/40}Ca$ -temperature or  $\Delta^{44/40}Ca$ -salinity relationship was found.

### Magnesium

*M. edulis*. The Mg in the extra-pallial fluid (EPF) was observed to inhibit bivalve calcite precipitation (Wilbur and Bernhardt 1984). This inhibition was suggested to be the major reason for an active control of Mg concentrations in the EPF that keeps Mg / Ca at about modern seawater conditions of 5200 mmol / mol (Crenshaw 1972; Heinemann *et al.* 2008). However, the existence of such a control was mainly derived from its failure at very high Mg concentrations in treatment water (Lorens and Bender 1980). Additionally, if only



considering Mg concentrations, high-Mg calcite (>10 mol% Mg) or aragonite would precipitate inorganically in the EPF (Mucci and Morse 1984; Morse *et al.* 1997; Stanley 2006; Morse *et al.* 2007). Still, *M. edulis* precipitates low-Mg calcite (<2 mol% Mg). Therefore, it is obvious that Mg incorporation in bivalve's calcite is mainly controlled by a different mechanism. If there is a control of Mg / Ca in the EPF, like suggested by Lorens and Bender (1980), it plays only a minor role for calcite precipitation.

Increasing  $D_{Mg}$  in calcite with higher temperatures can be explained inorganically (Katz 1973; Oomori *et al.* 1987; Rosenberg and Hughes 1991; Lopez *et al.* 2009) and was found in several bivalve (**tab. 2.4**), foraminifera and other taxa before (Elderfield and Ganssen 2000). The  $D_{Mg}$ -temperature relationship we found in *M. edulis* calcite (**eq. 2.1**, **fig. 2.2B**) has an intermediate slope (if translated into Mg / Ca vs. temperature: 0.54 mmol / mol per °C, **tab. 2.4**) compared to other studies with *M. edulis* or other calcitic bivalve species (0.2 to 0.7 mmol / mol per °C). Also the intercept is of intermediate value ( $-0.11 \pm 1.14$  mmol / mol (95% CI)), if not considering the very high Mg / Ca values of a single recent study (Wanamaker *et al.* 2008), and confidence intervals of the intercept overlap with errors published in the other studies. The highest intercept in Wanamaker *et al.* (2008: 10.0 mmol / mol at the high-saline treatment of 31), however, appears to be due to low values at the high temperature treatment, that produced a low slope (0.37 mmol / mol per °C) and not due to overall extreme values. Still, the intercepts at the two lower salinity treatments were also comparably high (2.7 mmol / mol at salinity 28 and 3.6 mmol / mol at salinity 23). Wanamaker *et al.* (2008) proposed ontogenetic effects as possible explanation for the high Mg / Ca intercepts. The *M. edulis* specimens used in our study, though, were of similar age and size and showed an Mg / Ca intercept that is comparable to all the other studies (including adult bivalves) as well as a strong Mg / Ca temperature relationship ( $R^2 = 0.81$ ) independently of our (compared to Wanamaker *et al.* 2008) wider range of salinity.

**Table 4:** Bivalve calcite Mg / Ca temperature (T) relationships measured by other studies:

Study	species	equation (Mg / Ca [mmol / mol])	R <sup>2</sup>
this study	<i>M. edulis</i> (~2 years old)	$Mg / Ca = 0.542 (\pm 0.07) \times T - 0.107 (\pm 1.14)$	0.81
Freitas <i>et al.</i> 2008	<i>M. edulis</i> (~2 years old)	$Mg / Ca = 0.242 (\pm 0.07) \times T + 1.349 (\pm 1.03)$	0.38
		$Mg / Ca = 0.320 (\pm 0.07) \times T + 1.286 (\pm 1.06)$	0.57
Wanamaker <i>et al.</i> 2008	<i>M. edulis</i> (~2 years old)	$Mg / Ca = 0.75 (\pm 0.22) \times T + 5.44 (\pm 0.31)$	0.47
Vander Putten <i>et al.</i> 2000	<i>M. edulis</i> (~2 years old)	$Mg / Ca = 0.70 (\pm 0.02) \times T - 0.63 (\pm 0.29)$ (only before spring bloom)	0.83
Klein <i>et al.</i> 1996b	<i>M. trossulus</i> (adult)	$Mg / Ca = 0.30 (\pm 0.04) \times T + 2.25 (\pm 0.63)$	0.74
Surge and Lohmann 2008	<i>Crassostrea virginica</i> (adult)	$Mg / Ca = 0.72 (\pm n/a) \times T - 0.23 (\pm n/a)$ (only last year of growth)	0.30
Freitas <i>et al.</i> 2005	<i>Pinna nobilis</i> (adult)	$Mg / Ca = 17.16 (\pm 1.95) \times e^{0.022 (\pm 0.004) \times T}$ (only first 4.5 years of growth)	0.62

Additionally, like at low temperatures in the study performed by Wanamaker *et al.* (2008), we found significantly higher  $D_{Mg}$  values at high salinity (35) compared to our intermediate-salinity treatment (25, **fig. 2.2B**). This is in contrast to Dodd (1965) who found an inverse relationship between salinity and the fraction of magnesite ( $MgCO_3$ ) in *M. edulis* prismatic (calcite) shell layer. Still, in our study,  $D_{Mg}$  was highest at salinity 15 and the difference of  $D_{Mg}$  was 3.8 times higher between salinity 15 and 25 (0.55) than between 25 and 35 (0.15). Therefore, our results rather confirm the findings of Dodd (1965) than those of Wanamaker *et al.* (2008).

After Zhong and Mucci (1989) the  $D_{Mg}$  in inorganic calcite decreases with increasing salinity of the parent seawater solutions. As a possible explanation for this effect, they suggest the lower sulphate concentrations at low salinity that enhance Mg incorporation (Mucci *et al.* 1989). With respect to bivalve calcification, polysaccharide associated sulphates play an important role as  $CaCO_3$  nucleation catalyser in the organic matrix (Addadi *et al.* 1987; Lopes-Lima *et al.* 2005). As Crenshaw *et al.* (1972) found similar sulphate ion concentrations in the EPF as in seawater, it is possible that lower sulphate concentrations in the less-saline treatments were mirrored in the EPF, too, and increased the calcite  $D_{Mg}$ . Additionally, high  $D_{Mg}$  values at high salinity (35) might mirror the higher water Mg / Ca at our higher salinity treatments (Lorens and Bender 1980). A trade-off between the two mechanisms could result in higher  $D_{Mg}$  at low salinity (due to reduced

sulphate concentrations) as well as at high salinity (due to increased Mg / Ca in the EPF). Whereas at intermediate salinity, both mechanisms favour a lower  $D_{Mg}$ .

However, this remains speculative as we did not measure sulphates in the treatment water or the EPF. Also, due to their different setup, higher Mg / Ca ratios in the treatment water cannot explain the salinity effect of Wanamaker *et al.* (2008). Finally, even though in iso-osmotic invertebrates, like marine bivalves, salinity changes are mirrored by changes in the osmotic value of extra-cellular fluids (Shumway 1977), the dependency of the EPF elemental composition on the seawater element ratios is questionable (Heinemann *et al.* 2008) and remains to be investigated.

*A. islandica*. The maximum mean Mg / Ca values (3.47 mmol / mol, **tab. 2.3**) we found in *A. islandica* shells were high, compared to those published in studies with data from shells grown in natural environments (Toland *et al.* 2000; Epplé 2004; Foster *et al.* 2008). Additionally, these studies found a seasonality of Mg / Ca patterns but no correlation with temperature, salinity or growth. Foster *et al.* (2008) concluded from their measurements with X-ray Absorption Near Edge Spectroscopy (XANES) that Mg is not substituted in bivalves aragonite but rather found in the organic matrix or amorphous calcium carbonate (ACC). However, the indirect indications still need to be proved by measurements of Mg potentially bound to the soluble and insoluble inorganic matrix. Moreover, ACC, to our knowledge, was only detected in bivalve larval shells (Weiss *et al.* 2002; Wilt 2005) and pearls (Jacob *et al.* 2008).

Still, we cannot exclude that Mg originally associated to the soluble organic matrix contaminated the sample solutions and produced our comparably high Mg / Ca ratios.

In inorganic aragonite, Mg / Ca was observed to be inversely related to precipitation temperature (Gaetani and Cohen 2006). Since we have found in *A. islandica* aragonite that  $D_{Mg}$  increased with temperature (**fig. 2.5**) another, biological, factor than the direct temperature effect mainly controlled incorporation of Mg. Interestingly, in both species, *M. edulis* and *A. islandica*,  $D_{Mg}$  only started to increase between 10 and 16 °C. Additionally, the  $D_{Mg}$  of *M. edulis* at 25 °C is not in line with the linear relationship, either and Freitas *et al.* (2005) proposed an exponential Mg / Ca-temperature relationship for *Pinna nobilis* (**tab. 2.4**). Also, very recent measurements with XANES indicate that Mg is bond to the organic matrix in *M. edulis* calcite, too (Clarke *et al.* 2009). Therefore, possibly the same non-linear operating temperature-dependent biological mechanism controls the Mg incorporation into the shell of various bivalve species.

In any case, the effect in *A. islandica* shells appears to be too weak to recognize temperature controlled  $D_{Mg}$  patterns in naturally grown shells.  $D_{Mg}$  temperature relationships of other aragonite bivalve species are more promising. Takesue and Van Geen (2004) found a significant correlation ( $r = 0.71$ ) of Mg / Ca and temperature in aragonite bivalve shells of *Protothaca staminea*, that had a clear and rather steep slope (0.23 per °C).

In our experiment, Mg / Ca of the treatment water increased with higher salinity (see Materials and Methods section) and Oomori *et al.* (1987) state that increasing fluid Mg / Ca could slightly reduce aragonite  $D_{Mg}$ . However, as Oomori *et al.* (1987) did not measure aragonite samples in our range of the treatment water Mg / Ca (4.7 – 6.3 mol/mol) we cannot seriously compare the two studies.

Nevertheless, if the  $D_{Mg}$  incorporation in *A. islandica* shells is strongly controlled by a biological mechanism, the latter might be temperature-dependent but insensitive to salinity and treatment water Mg / Ca.

#### Strontium

A positive linear correlation was observed between Sr / Ca and Mg / Ca of both organically and inorganically precipitated marine calcite. It was explained by the incorporation of the Mg ion into the calcite crystal structure that causes deformations and thus creates sites where the larger Sr ion can be incorporated (Mucci and Morse 1984; Carpenter and Lohmann 1992). Here, we can confirm this correlation for  $D_{Sr}$  and  $D_{Mg}$  in *M. edulis* calcite and *A. islandica* aragonite, even though the relations appear to be rather weak (*M. edulis*:  $r = 0.40$ , *A. islandica*:  $r = 0.56$ ) as the main factors controlling the two minor element ratios ( $D_{Mg}$ : temperature,  $D_{Sr}$ : salinity) differed.

*M. edulis*.  $D_{Sr}$  respectively Sr / Ca in inorganically precipitated calcite is weakly inverse related to temperature (Gaetani and Cohen 2006; Tang *et al.* 2008b). The examination of Sr / Ca temperature relationships of calcitic bivalves in the literature, however, reveals inconsistent results: Dodd (1965) and Lerman (1965) found a correlation of Sr / Ca and temperature in *M. edulis* prismatic layer resp. in *Crassostrea virginica* and *C. rhizophorae* but Vander Putten *et al.* (2000, in *M. edulis*) and Freitas *et al.* (2005, in *Pinna nobilis*) could not confirm this relationship. However, two recent studies (Freitas *et al.* 2008, Wanamaker *et al.* 2008) also found weak relationships in *M. edulis* and *Pecten maximus*. Additionally, Wanamaker (2008) showed that the strength of the relationship can depend on the salinity background as they found the strongest dependence of Sr / Ca on temperature ( $R^2 = 0.75$ ) at comparably low salinity (23).

The results of our study cannot confirm the latter interaction as over a wider range of salinities (15 to 35) we found only a weak  $D_{Sr}$  temperature relationship in *M. edulis*. However, at higher temperature levels (20 - 25 °C)  $D_{Sr}$  increased significantly (**fig. 2.2A**) which can be interpreted as corroboration for the relationships found in earlier studies.

The clear decrease of  $D_{Sr}$  with higher salinity that we found in *M. edulis* calcite (**fig. 2.3, eq. 2.2**) appears to be in contrast to previous findings of Sr / Ca not being correlated to salinity (Dodd 1965). Also, Klein *et al.* (1996a) found Sr / Ca in *M. trossulus* primarily controlled by mantle metabolic activity. In our study, however, shell growth (chapter 1) and therefore probably mantle metabolic rate of *M. edulis* was mainly controlled by temperature and  $D_{Sr}$  was not.

However, in the treatment water of this study Sr concentrations remained equal from salinity 15 to salinity 35 but Ca concentrations increased, resulting in lower Sr / Ca ratios at higher salinities. Therefore, our findings corroborate earlier data showing that the concentration of Sr in the calcite shells of *M. edulis* and two oyster species increases with increasing Sr / Ca ratio in the water (Lerman 1965; Lorens and Bender 1980).

*A. islandica*. Like in calcite, in marine aragonitic bivalve shells Sr / Ca is supposed to be strongly controlled by biological factors (Palacios *et al.* 1994; Purton *et al.* 1999; Gillikin *et al.* 2005). Still, in *M. edulis* and *Mya arenaria* aragonite Sr / Ca was found to be inversely related to temperature (Dodd 1965; Palacios *et al.* 1994). This would be in line with findings from inorganic precipitation experiments (Kinsman and Holland 1969 ; Dietzel *et al.* 2004; Gaetani and Cohen 2006). However, in our study we found the opposite pattern in *A. islandica* aragonite that was precipitated at low salinity:  $D_{Sr}$  was higher at 10 and 16 °C compared to 4 °C (**fig. 2.6, eq. 2.5**), corroborating a strong biological control.

$D_{Sr}$  in inorganic aragonite was found unaffected by salinity between 5 and 44 (Zhong and Mucci 1989). Still, evidence was found that Sr / Ca in bivalve aragonite is

inversely related to salinity (Dodd 1965). This could be confirmed for *A. islandica* by a strong relationship at temperatures 10 and 16 °C (**fig. 2.6, eq. 2.3 and 2.4**).

Overall, the temperature and salinity effects we found in this study, support the hypothesis of strong biological control of *A. islandica* shell  $D_{Sr}$ .

### $\Delta^{44/40}Ca$

Several studies have addressed Ca isotope fractionation during inorganic calcite formation and discussed different models to explain the results (Gussone *et al.* 2003; Lemarchand *et al.* 2004; Marriott *et al.* 2004; Fantle and DePaolo 2005). However, recently, Tang *et al.* (2008a) successfully applied the surface entrapment model (SEMO, Watson 2004) to Ca isotope fractionation. According to this model, strong fractionation only occurs at the surface layer of the calcite crystal. The fractionation can happen due to stronger bond of  $^{44}Ca$  in the solution, preferential adsorption of  $^{40}Ca$  to the surface and higher diffusion rates of  $^{40}Ca$  at the liquid-solid transition. As the crystal grows, the isotopically lighter surface layer is incorporated into the newly formed crystal, while a re-equilibration towards heavier Ca isotopes takes place due to ion diffusion (Tang *et al.* 2008a). By this model, the authors were able to combine the kinetic diffusion, rate-controlled, equilibrium fractionation and adsorption-controlled steady state models of previous studies. Differences to the results of Lemarchand *et al.* (2004) with respect to the precipitation rate dependence were explained on the basis of different Ca supply to the crystal surface layer due to the experimental setup.

In biological systems, calcium was observed to become isotopically lighter as it moves through the food chain (Skulan *et al.* 1997; Skulan and DePaolo 1999; DePaolo 2004). Different slopes of Ca isotope fractionation temperature relationships in two foraminifera species (*O. universa* and *G. sacculifer*) were suggested to be due to a dehydration of the  $Ca^{2+}$ -aquocomplex by *G. sacculifer* before calcification takes place (Gussone *et al.* 2003).

Heinemann *et al.* (2008) proposed an interaction of the precipitation of aragonite and calcite if they occur in the same compartment (here: the EPF of *M. edulis*) resulting in the comparably low offset (0.15 to 0.31 ‰) they found between the two  $CaCO_3$  polymorphs. In that study, aragonite Ca appeared to be less fractionated ( $\Delta^{44/40}Ca = -1.33$  ‰) than in other aragonite species (Gussone *et al.* 2005: mean  $\Delta^{44/40}Ca = -1.64$  ‰ at 15 °C and  $-1.43$  ‰ at 30 °C). Here, we found that the mean calcium isotope ratios ( $\Delta^{44/40}Ca$ ) in calcite prismatic layer of *M. edulis* shells ( $\Delta^{44/40}Ca = -1.11 \pm 0.10$  ‰ s.d.) and aragonite shells of *A. islandica* ( $\Delta^{44/40}Ca = -1.06 \pm 0.10$  ‰ s.d.) are statistically equal. Still, the mean fractionation of our calcite samples ( $-1.11$  ‰  $\pm 0.10$  s.d.) agrees within uncertainties with the values in Heinemann *et al.* (2008,  $-0.89$  ‰  $\pm 0.17$ , s.d.). The same is the case for the

aragonite samples (T-Tests, calcite:  $t = -2.13$ ,  $p = 0.163$ , aragonite:  $t = 0.96$ ,  $p = 0.425$ ). Additionally, Hippler *et al.* (2007) presented  $\Delta^{44/40}\text{Ca}$  data of *M. edulis* calcite ( $-1.18 \text{‰} \pm 0.14 \text{ s.d.}$ ) and *A. islandica* aragonite ( $-1.28 \text{‰} \pm 0.10 \text{ s.d.}$ ) grown under natural conditions in the North Sea that are statistically equal, too. It appears that Ca isotopes in aragonite of the bivalves *M. edulis* and *A. islandica* are in general less fractionated than in other aragonite-precipitating taxa.

The correlation of  $\text{Mg} / \text{Ca}$  and  $\Delta^{44/40}\text{Ca}$  that was found in the fossil calcite of *V. ultimus* (Immenhauser *et al.* 2005) could not be supported for calcite layers of *M. edulis* shells in this study but for aragonite shells of *A. islandica*.

*M. edulis*. Tang *et al.* (2008a) showed that both, temperature and precipitation rate, control Ca isotope fractionation in calcite precipitation, with the relative contribution of the one factor depending on the other: at low temperatures they found a strong impact of precipitation rate, at high precipitation rates a strong temperature control. Overall, fractionation of Ca isotopes in calcite increases with higher precipitation rate and lower temperature.

According to Tang *et al.* (2008a) we should have found weaker fractionation with higher temperatures. Our results of *M. edulis* calcite, however, cannot corroborate the inorganic models. Therefore, a biological mechanism, conceivably like described by Gussone *et al.* (2003, 2006; see above), clearly controls Ca isotope fractionation.

An explanation of the slightly increased fractionation at our low salinity treatment (15, **fig. 2.4**) could arise from the ratio of different passages of Ca into the EPF. In contrast to passive intercellular diffusion of Ca, the transport via active Ca pumps can be considered probable to cause isotope fractionation (Böhm *et al.* 2006; Gussone *et al.* 2006). Crenshaw (1972) measured a slightly increased Ca concentration in the EPF, assuming that bivalves keep it high to raise the Ca carbonate saturation state and allow precipitation under naturally acidic conditions (see chapter 3). At reduced salinity the fraction of active passages is possibly increased by higher pumping rates to keep the Ca concentration in the EPF high. This might explain the observed higher fractionation.

*A. islandica*. Just recently, Niedermayer *et al.* (2009) showed that Ca isotope fractionation in inorganic precipitated aragonite is rather independent of the precipitation rate. Our findings in *A. islandica* aragonite are in line with this inorganic observation as  $\Delta^{44/40}\text{Ca}$  was mainly controlled by temperature and shell growth by salinity.

Additionally, our *A. islandica* shell material showed a clear temperature dependency of  $\Delta^{44/40}\text{Ca}$  similar to some other (non-bivalve) marine aragonite and calcite species and inorganic aragonite (e.g. Gussone *et al.* 2005). The mean slope of the  $\Delta^{44/40}\text{Ca}$  temperature

relationship we found in *A. islandica* ( $0.011 \pm 0.008$  ‰ per °C, 95% CI) was statistically equal to the aragonite slope of Gussone *et al.* (2005,  $0.017 \pm 0.006$  ‰ per °C, 95% CI). The independence of salinity further increases the reliability of the  $\Delta^{44/40}\text{Ca}$  temperature relationship in *A. islandica* shell material.

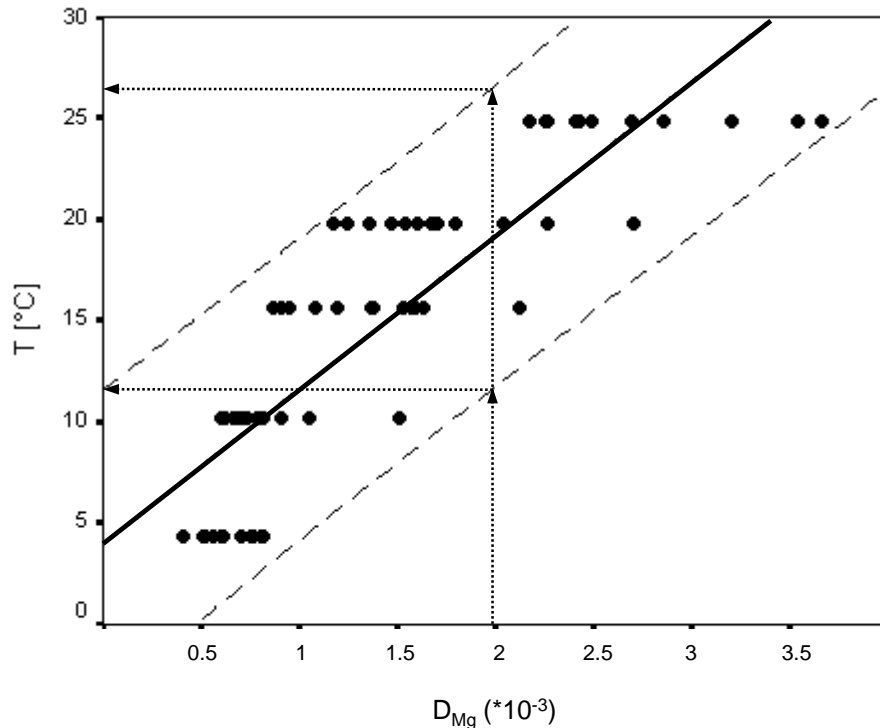
#### Conclusion and implications for proxy-use

Interactions between temperature and salinity with respect to their influence on bivalve shell parameters (*A. islandica*: growth rate and  $D_{\text{Sr}}$ ) could be found, emphasising the importance of multi-factorial experiments. The variation of measured shell chemistry characteristics between individual bivalves cultured at the same temperature and salinity shows that reasonable replication is essential when using bivalve shells as paleo-climate proxies. Concerning the 3 proxies evaluated in this study, the  $D_{\text{Sr}}$  proxy for seawater Sr / Ca composition (*M. edulis*) respectively salinity (*A. islandica*) seems to be the most reliable, even though in *A. islandica* shells, it can be blurred by temperature effects at low salinities. In *M. edulis* calcite,  $D_{\text{Mg}}$  correlates well with seawater temperatures and the slope is rather steep. But again: adequate replication is necessary, as individual variation is high. This becomes obvious by the large confidence intervals of the temperature- $D_{\text{Mg}}$  relationship (eq. 2.7, fig. 2.8).

$$T \text{ [}^\circ\text{C]} = 7.61(\pm 1.17) * D_{\text{Mg}} (* 10^{-3}) + 4.00 (\pm 1.93) \quad (2.7)$$

$$R^2 = 0.75, F = 170.32, p < 0.001, \text{ errors: 95\% CI, } n = 60.$$





**Figure 2.8.** Temperature in dependence of  $D_{Mg}$  derived from shells of *M. edulis*. Bold line: significant linear regression for all salinity conditions (15, 25 and 35) with  $R^2 = 0.75$ ,  $p < 0.001$ . Model ( $\pm 95\%$  CI):  $T [^\circ\text{C}] = 7.61(\pm 1.17) * D_{Mg} (* 10^{-3}) + 4.00 (\pm 1.93)$ ,  $n = 60$ . Dashed lines represent 95% confidence margins. Dotted errors: A  $D_{Mg}$  of 2 corresponds to a temperature between 12 and 25 °C.

Finally, Ca isotope ratios in *A. islandica* related well with temperature (with a shallow slope of 0.011 ‰ per °C) and are independent of salinity. With regard to our results, Ca isotope ratios in *M. edulis* shells cannot be used as a paleo-temperature proxy.

Even though the  $D_{Mg}$  temperature relationship in *M. edulis* calcite could be explained inorganically it appears to rather be a biologically controlled mechanism. Strong biological control of  $\Delta^{44/40}\text{Ca}$  and  $D_{Sr}$  was also found as the observed temperature and salinity patterns cannot be explained by inorganic models. A threshold can be assumed between 10 °C and 20 °C for both species investigated in this study, from where the incorporation of Mg respectively Sr starts to increase. Therefore, an exponential relationship might be a better model than a linear one to describe  $D_{Mg}$  and  $D_{Sr}$  patterns in *M. edulis* and *A. islandica* shells (see chapter 4).

Overall, *M. edulis* calcite shells appear to provide the better proxies with respect to  $D_{Mg}$  and  $D_{Sr}$  and *A. islandica* aragonite shells the better Ca isotope proxy.

## Chapter 3

### Ocean Acidification and Ocean Warming: How western Baltic Sea Bivalves *Mytilus edulis* (L.) and *Arctica islandica* (L.) can cope with CO<sub>2</sub>-provoked Changes

#### Abstract

Acidification of the World's oceans, caused by anthropogenic release of carbon dioxide (CO<sub>2</sub>) into the atmosphere, lowers the calcium carbonate (CaCO<sub>3</sub>) saturation state which was shown to be detrimental to reproduction, performance and shell formation and of marine calcifying organisms.

As bivalve shell production is costly, it should be sensitive to environmental stress. The aim of this study was to investigate whether the predicted combination of increased temperature and acidification leads to increased physiological stress that may influence the performance of two bivalve species *M. edulis* and *A. islandica*. As physiological effects of temperature and acidification are strongly suspected to interact with each other, we did not explore them separately but in fully-crossed 2-factorial experiments.

We were able to show that the two bivalve species subject to this study are able to resist a mean water pCO<sub>2</sub> of up to 1377 µatm for several months, independently of the water temperature. Under projected higher temperatures, the future competitiveness of *M. edulis* and *A. islandica* can be reduced. If competing species or important predators suffer stronger from ocean acidification, the abundance of two bivalve species might even increase.

#### 3.1 Introduction

Increased anthropogenic release of carbon dioxide (CO<sub>2</sub>) into the atmosphere, mainly due to land use and burning of fossil fuels, will result in an acidification of the World's oceans to a pH of about 7.3 within 300 years (Caldeira and Wickett 2003; Sabine *et al.* 2004; Denman *et al.* 2007). But if observations from a recent eight-year study at a site at the North American West Coast (Wootton *et al.* 2008) hold true for other regions, the acidification process might be even much faster.

Seawater acidification shifts the inorganic carbon equilibria towards higher CO<sub>2</sub> and lower carbonate ion (CO<sub>3</sub><sup>2-</sup>) concentrations and therefore lowers the calcium carbonate (CaCO<sub>3</sub>) saturation state (e.g. Feely *et al.* 2004). At present, oceanic surface waters are still

supersaturated with respect to calcite and aragonite, the thermodynamically stable polymorphs of CaCO<sub>3</sub>. However, by the year 2050 high-latitude oceans are projected to become undersaturated with respect to aragonite (Orr *et al.* 2005; Cao and Caldeira 2008) which has the potential to drastically change marine ecosystems (Fabry *et al.* 2008; Martin *et al.* 2008; Wootton *et al.* 2008; Moy *et al.* 2009).

Recent studies showed significant effects of acidified seawater on reproduction, performance and physiological responses of calcifying organisms like crustaceans, pteropods, echinoderms, corals, foraminifera, coccolithophorids and coralline algae (e.g. Orr *et al.* 2005; Shirayama and Thornton 2005; Langer *et al.* 2006; Atkinson and Cuet 2008; Kuffner *et al.* 2008; Kurihara 2008; Moy *et al.* 2009). Also, mortality, shell growth and metabolism rate of mussels *Mytilus edulis* and *M. galloprovincialis* were found to be sensitive towards acidification (Bamber 1990; Michaelidis *et al.* 2005; Berge *et al.* 2006). However, these detrimental effects all appeared at pH-values of < 7.4. In contrast, Gazeau *et al.* (2007) found in a short term experiment (hours of exposition) reduced calcification of *M. edulis* already at higher pH-values (< 8.0), while shell dissolution also appears to start only between pH 7.5 and 7.4 (resp. pCO<sub>2</sub> 1800 - 2400, Michaelidis *et al.* 2005; Gazeau *et al.* 2007, Heinemann pers. comm.). To our knowledge, until now no studies about the effects of acidification on *A. islandica* or other exclusively aragonite-forming marine bivalves were conducted.

Additionally, the increase of atmospheric CO<sub>2</sub> will increase sea surface temperatures (Denman *et al.* 2007). A mean increase of 2.6 to 5.0 °C within the next 100 years was projected for the Baltic Sea by Meier (2006).

Higher temperature increases metabolism rates and results in higher CO<sub>2</sub> production and can therefore increase detrimental effects of acidification (Michaelidis *et al.* 2005; Gazeau *et al.* 2007). On the other hand, acidification is suspected to shift temperature distribution limits and narrow thermal niches (Pörtner 2008).

As bivalve shell production, including the organic matrix and calcification, is costly (Palmer 1992; Irie and Iwasa 2005), it should be sensitive to environmental stress. In stressed animals, energy has to be allocated from shell production to stress response processes, e.g. cellular repair mechanisms. Temperature changes may be such stressors that force the animal to invest more energy into the repair of oxidized cellular components caused by an increased generation of reactive oxygen species (ROS: O<sub>2</sub><sup>-</sup>, H<sub>2</sub>O<sub>2</sub>, OH<sup>-</sup>) at higher temperatures (Abele *et al.* 2002) and leaving less energy for shell growth.

Still, *M. edulis* shells growth increased in laboratory experiments until temperatures as high as 20 °C (Almada-Villela *et al.* 1982; Reuter 2004). *A. islandica* distribution limit appears to be around 16 °C (Cargnelli *et al.* 1999; Witbaard and Bergman 2003).

Physiologically stressful conditions like high temperatures increase ROS generation rate and can result in accumulation of the “aging pigment” lipofuscin in the lysosomes (Abele and Puntarulo 2004). Therefore, in previous studies an increase in lipofuscin accumulation under different environmental stressors was used as a biomarker for stress-induced oxidative cell damage (Winston 1991; Brunk and Terman 2002a; Brunk and Terman 2002b; Philipp *et al.* 2005; Philipp *et al.* 2006). However, studies on the influence of temperature on lipofuscin accumulation in bivalves (Hole *et al.* 1995; Kagley *et al.* 2003; Petrovic *et al.* 2004; Guerlet *et al.* 2007) showed inconsistent results.

In the present study the effect of pCO<sub>2</sub>, pH and temperature on shell growth, fitness (condition and mortality) and cellular stress of young individuals of two bivalve species from the Baltic Sea was assessed. *Mytilus edulis* (L.) lives attached to hard substrata or forms loose beds on sandy substrata. It can appear in enormous abundances (Kautsky 1982; Wahl 2001) and can make up to 80 % of the animal biomass in some areas of the Baltic Sea (Jansson and Kautsky 1977; Suchanek 1985; Reusch and Chapman 1997; Wahl 2001). *Arctica islandica* (L.) burrows in the sandy sea bottom. It reaches its eastern limit of distribution in the Baltic Sea in the Arcona Basin (von Oertzen 1973). In Kiel Bight (Brey 1990) and Mecklenburg Bight (Zettler 2001), with respect to biomass and production, it dominates soft-bottom communities below the halocline (15 m).

Our aim was to investigate whether the predicted combination of an increase in temperature and acidification of the World's Oceans (Caldeira and Wickett 2003; Feely *et al.* 2004; Denman *et al.* 2007) leads to increased physiological stress which may influence the performance of the two bivalve species investigated. As physiological effects of temperature and acidification are strongly suspected to interact with each other (Pörtner 2008), we did not explore them separately but for both species in one fully-crossed 2-factorial experiment each.

## 3.2 Materials and Methods

### Preliminary study

First, to test the acidification of seawater with CO<sub>2</sub>-enriched air in small containers and to explore the effect of a high CO<sub>2</sub> environment on *M. edulis* growth we run a preliminary experiment. Young *M. edulis* specimens were collected in Kiel Fjord. After acclimatization to laboratory conditions (16.5 °C ± 0.5 s.d., salinity 12.7 - 13.0) each 7 individually marked bivalves (height: 23.2 mm ± 0.73 s.d.) were placed into eight 10-l-containers four of which were aerated with normal air (about 380 µatm CO<sub>2</sub>) the remaining four with CO<sub>2</sub>-enriched air (3118 µatm ± 62 s.d. CO<sub>2</sub>). Each culture container was part of one closed circuit system containing 36 l of sea water. The treatment water was subject to constant recirculation to

warrant a turnover rate of about 8 hours. Pressure in the sealed circuit systems was maintained at normal conditions by means of an overflow mechanism allowing excess air / gas to leave the system.

Mussels were fed with a live phytoplankton mixture 'DT's Live Marine Phytoplankton-Premium Reef Blend' consisting of three marine algae (values given in percentage of volume; personal communication with manufacturer Dennis Tagrin): *Phaeodactylum tricornutum* (40 %), *Nannochloropsis oculata* (40 %) and *Chlorella sp.* (20 %). Algae dry weight was measured to be 2.9 g / l culture medium. About 0.6 ml culture medium per day corresponded to a daily feeding of ca. 1.7 mg algae dry weight per mussel.

Dead mussels were removed from the containers and their length measured. Water was not changed, hence excretion products not removed throughout the experiment. This was in order to be able to monitor changes in total alkalinity and required a sufficient amount of water and a mussel density small enough to compensate for the effects excretion products may cause.

On a daily basis,  $\text{pH}_{\text{NBS}}$  (calibration with NIST buffers) and temperature were measured (multimeter Multi 350i, sensor: Sen Tix 41, WTW GmbH, Weilheim, Germany). Water samples were taken at the beginning, in the middle (after 20 days) and the end (after 40 days) of the experiment and subsequently total alkalinity (TA) was measured by potentiometric titration. Precipitation of 1 mole of calcium carbonate ( $\text{CaCO}_3$ ) consumes 2 moles of bicarbonate ( $\text{HCO}_3^-$ ) and therefore decreases TA by 2 equivalents. It follows that net calcification rates ( $G$  [ $\text{mmol CaCO}_3 / (\text{g}_{\text{dry weight}} * \text{d})$ ]) can be estimated using the equation (Smith and Key 1975; Gazeau *et al.* 2007):

$$G = - \Delta \text{TA} / 2 \quad (3.1)$$

The program CO2Sys (Lewis and Wallace 1998) was used to compute the parameters of the seawater carbonate system. At starting conditions (i.e. not accounting for biochemical processes arising during the experiment, e.g. bacterial growth, excretion products etc.), equilibration with the artificial atmosphere within the high- $\text{CO}_2$  group was calculated to cause a  $\text{pH}_{\text{NBS}}$  of 7.34, whereas the low- $\text{CO}_2$  group was expected to assume a pH of 8.14. One circuit system had to be excluded from further contemplation within the 3118  $\mu\text{atm}$  group, because of too high  $\text{pH}_{\text{NBS}}$  values due to leakages in the experimental construction. Achieved average  $\text{pH}_{\text{NBS}}$  was 8.03 ( $\pm 0.04$  se) within the 380  $\mu\text{atm}$  treatment and 7.26 ( $\pm 0.05$  se) within the 3118  $\mu\text{atm}$  treatments.

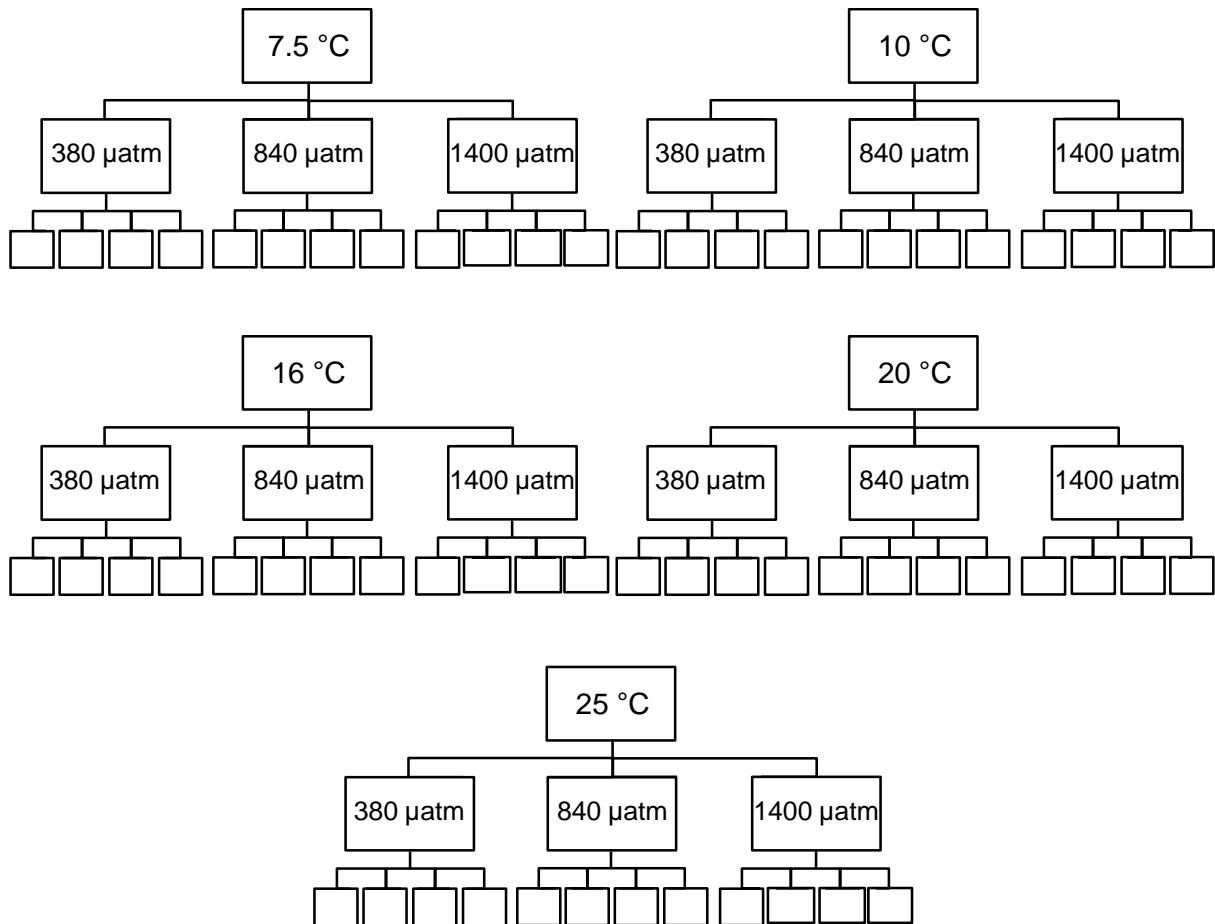
Height of the mussels was determined to the nearest 0.02 mm at the start and end of the experiment using a calliper. T-tests were performed to reveal differences between normal-air and  $\text{CO}_2$ -enriched-air treatments.

### Main experiment

Young *M. edulis* specimens were, again, collected in Kiel Fjord. Individual shell height (measured from the umbo to the opposite side of the shell) ranged between 13.5 to 23.8 mm (17.4 mm  $\pm$  1.6 s.d.). *A. islandica* specimens were dredged at the station “Süderfahrt” (54°32.6' N, 10°42.1' E) west of Fehmarn Island in Kiel Bight, Baltic Sea. Animals' height ranged between 10.1 and 20.7 mm (15.9 mm  $\pm$  1.5 s.d.).

*Experimental design.* For both species we each conducted a 2-factorial, fully crossed experiment with factors temperature and pCO<sub>2</sub> (ANOVA-model:  $X_{ijk} = \mu + T_i + \text{pCO}_{2j} + T_i \text{pCO}_{2j} + e_{k(ij)}$ ). Applied temperature levels were 7.5, 10, 16, 20 and 25 °C for *M. edulis* and 7.5, 10 and 16 °C for *A. islandica* (**fig. 3.1**).

Atmospheric CO<sub>2</sub> concentrations are projected to increase to values between 750 and 1000 ppm (pCO<sub>2</sub> = 750 - 1000  $\mu$ atm) in 2100 and will reach levels of more than 1500 ppm between the years 2100 and 2200 (Wigley *et al.* 1996). Therefore, next to a control of 380  $\mu$ atm we chose 840 and 1400  $\mu$ atm as acidification treatments representing realistic future pCO<sub>2</sub> scenarios. The level of replication was 4 (**fig. 3.1**).



**Figure 3.1:** Experimental design: At each of the five temperature levels the bivalve were culture in (7.5, 10, 16, 20 and 25 °C) three water pCO<sub>2</sub> treatments (380, 840 and 1400 µatm) were realised. All temperature-pCO<sub>2</sub> treatment combinations were replicated four times. For *A. islandica*, only temperature levels 7.5 to 16 °C were implemented.

**Culture.** Bivalves *M. edulis* and *A. islandica* were cultured in constant temperature rooms (c<sub>T</sub> rooms) at the Leibniz-Institute of Marine Sciences IFM-GEOMAR, Kiel, Germany, in 96 temperature-insulated 4-l-containers (10 individuals (ind.) in each container) and fed 5 days a week with 0.5 ml / ind. / d of a concentrated living-phytoplankton suspension (DT's Premium Blend, DT's Plankton Farm, Sycamore, IL, see preliminary study) containing an algal biomass of approx. 2.91 g / l, resulting in about 15 mg / ind. / d.

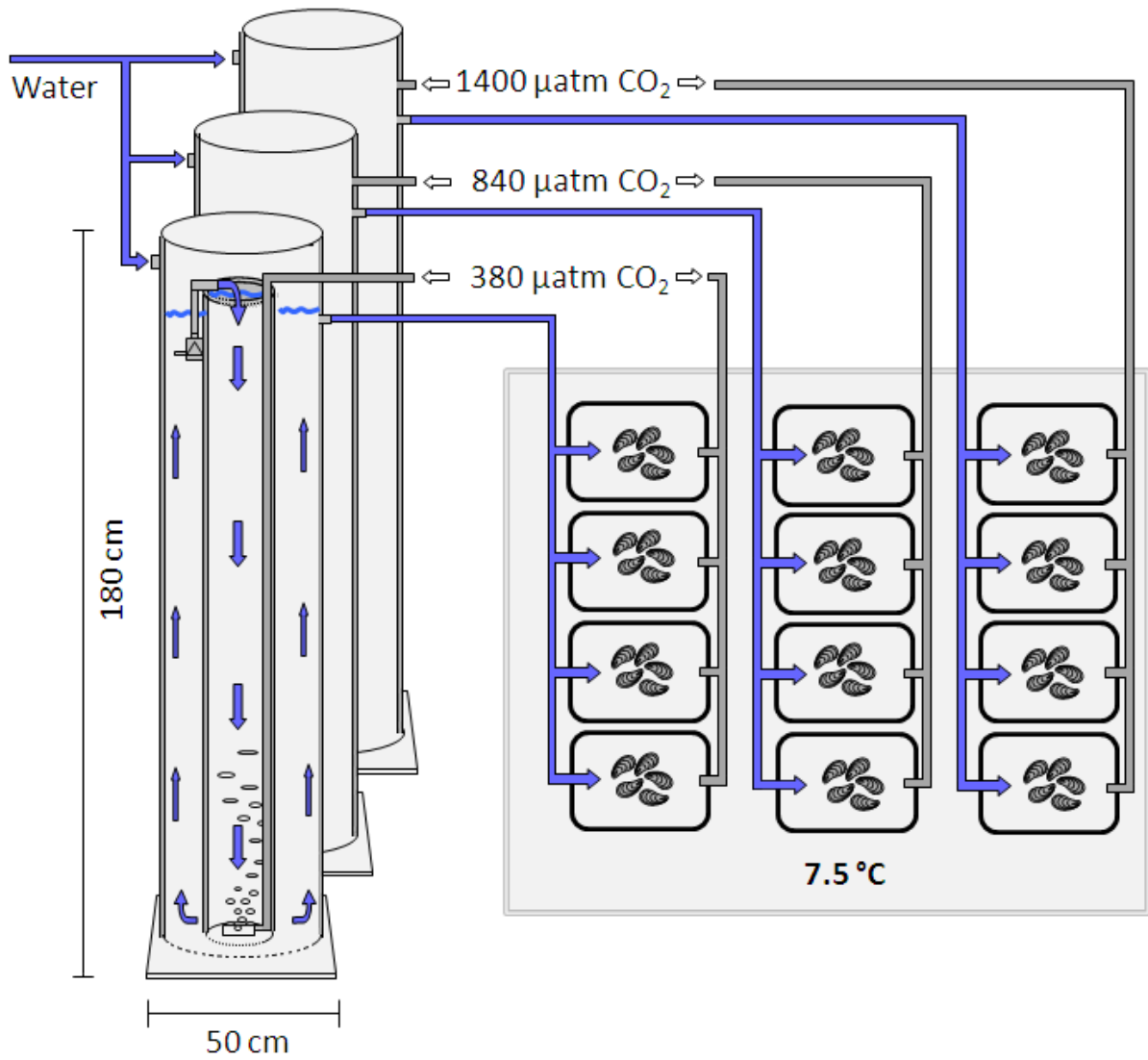
To optimize water quality, water was constantly exchanged by a flow-through system. Water flow rates in each container were 9 l / h assuring an exchange of the treatment water within < 1/2 h. After addition of phytoplankton food, the water flow was stopped to allow the animals to feed. After two hours the treatment water was cleared and the water flow was started again. About 2 cm of sandy substrate were placed at the bottom of the *A. islandica* containers to allow the animals to burry.

Treatments of  $p\text{CO}_2$  were realized in 12 4-l-containers nested within each temperature basin (**fig. 3.1** and **3.2**). Gas mixtures containing different partial pressures of  $\text{CO}_2$  were provided by a central air- $\text{CO}_2$ -mixing device at the IFM-GEOMAR (Bleich *et al.* 2008). This  $\text{CO}_2$  manipulation facility is able to constantly measure ambient  $p\text{CO}_2$  and to inject  $\text{CO}_2$  into the air that is pumped to different laboratories. The amount of injected  $\text{CO}_2$  is steadily adapted to one of 5 different desired  $p\text{CO}_2$  levels (of which only 2 were used in this study - additionally to the normal air used for the  $380 \mu\text{atm}$  treatment) and to the amount of air needed. Resulting  $p\text{CO}_2$  values in the treatment air were measured with a GDZ 401 infrared  $\text{CO}_2$  analyzer (HTK, Hamburg, Germany). Mean  $p\text{CO}_2$  appeared to be  $391.2 \mu\text{atm}$  ( $\pm 21.0$  s.d.) at the  $380 \mu\text{atm}$  treatment,  $868.9 \mu\text{atm}$  ( $\pm 32.4$  s.d.) at the  $840 \mu\text{atm}$  treatment and  $1358.2 \mu\text{atm}$  ( $\pm 52.5$  s.d.) at the  $1400 \mu\text{atm}$  treatment.

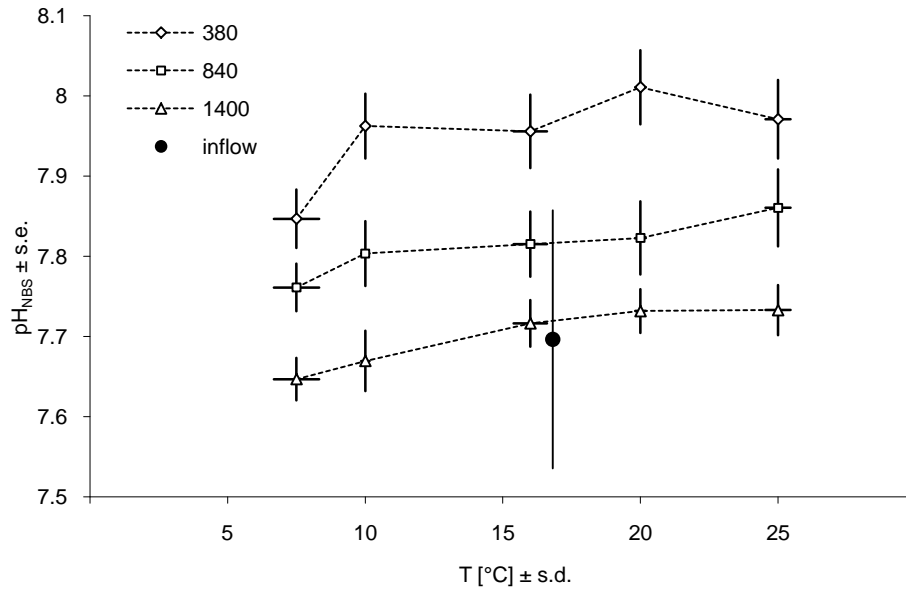
To assure sufficient water acclimatisation to the desired temperature and  $p\text{CO}_2$  levels, water of the 15 treatment combinations was pre-conditioned in 15 300-l-cylinders installed upstream of the culture containers. For conditioning efficiency a counter current system was implemented in these cylinders (**fig. 3.2**). Cylinder flow-through rates were  $160 \text{ l/h}$  of air- $\text{CO}_2$ -mixture and  $36 \text{ l/h}$  of water. Final water conditioning took place in the treatment basins that were also heated or cooled and aerated with air or air- $\text{CO}_2$ -mixture.

$\text{pH}_{\text{NBS}}$  of the seawater at the institute's jetty, of the inflow water in the institute's  $c_T$  rooms and of the treatment water was regularly measured 3 days a week with a WTW pH meter (pH 330i, sensor: Sen Tix 81, WTW GmbH, Weilheim, Germany). Dissolved inorganic carbon (DIC) and total alkalinity (TA) were measured at the IFM-GEOMAR 3 times during the experimental period. Right after sampling, water samples were poisoned with saturated  $\text{HgCl}_2$  solution. TA values of the treatment water were determined by potentiometric open-cell titration with hydrochloric acid (Gran 1952; Dickson, A. *et al.* 2007) on a VINDTA (Versatile INstrument for the Determination of Titration Alkalinity, MARIANDA, Kiel, Germany) autoanalyzer. DIC values were measured coulometrically after Dickson *et al.* (2007) on a SOMMA (Single-Operator Multi-Metabolic Analyzer, University of Rhode Island, Kingston, RI) autoanalyzer. Dickson sea water standard served as reference material (Dickson *et al.* 2003). With the gained information,  $p\text{CO}_2$  (**fig. 3.4**) and saturation state with respect to calcite ( $\Omega_{\text{Calcite}}$ ) and aragonite ( $\Omega_{\text{Aragonite}}$ ) of the treatment water could be calculated (Lewis and Wallace 1998, **fig. 3.5**).

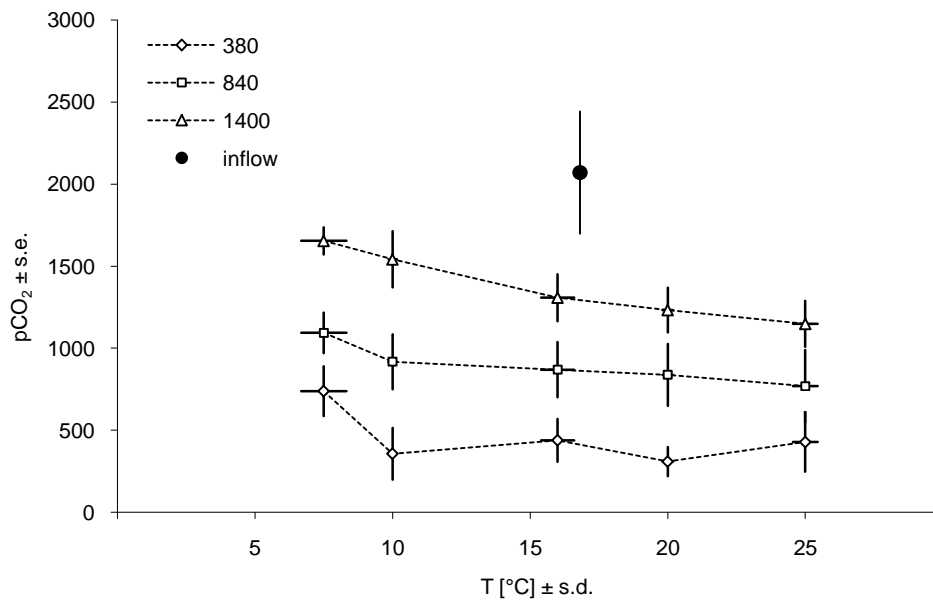




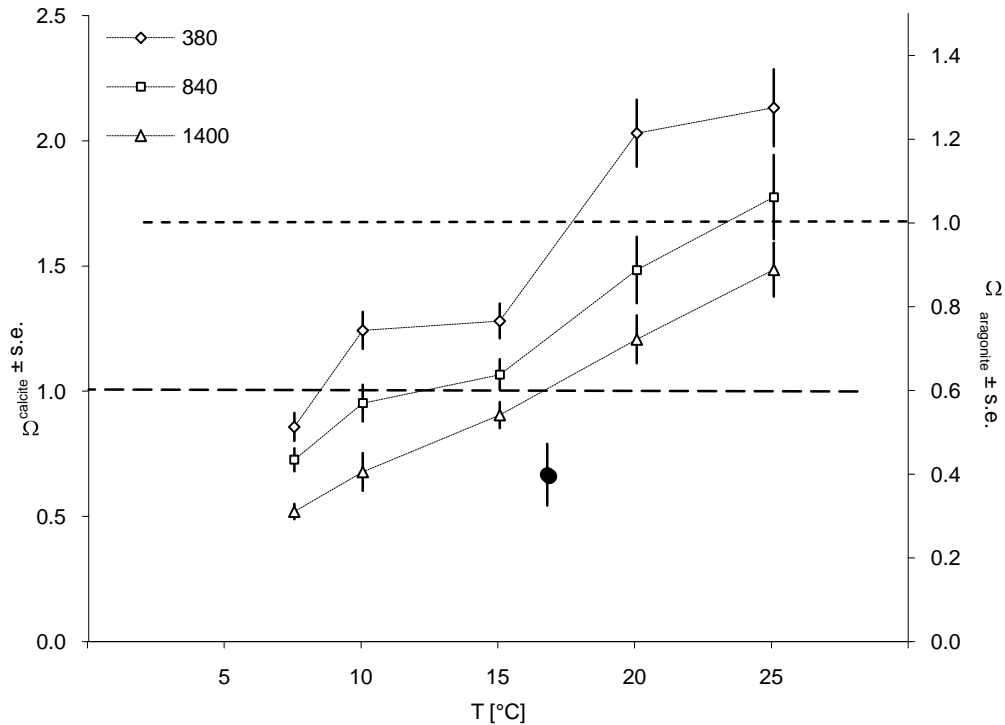
**Figure 3.2:** Acidification treatment displayed for one temperature level (7.5 °C). Water is pre-conditioned (with respect to temperature and water pCO<sub>2</sub>) in counter-current cylinders and runs into treatment containers where final water conditioning takes place. For clarity, the twelve treatment containers nested in the insulated temperature basin, are displayed sorted by acidification treatment. In the original setup, they were arranged randomly.



**Figure 3.3:** Measured pH<sub>NBS</sub> values of treatments, means and standard errors (s.e.).

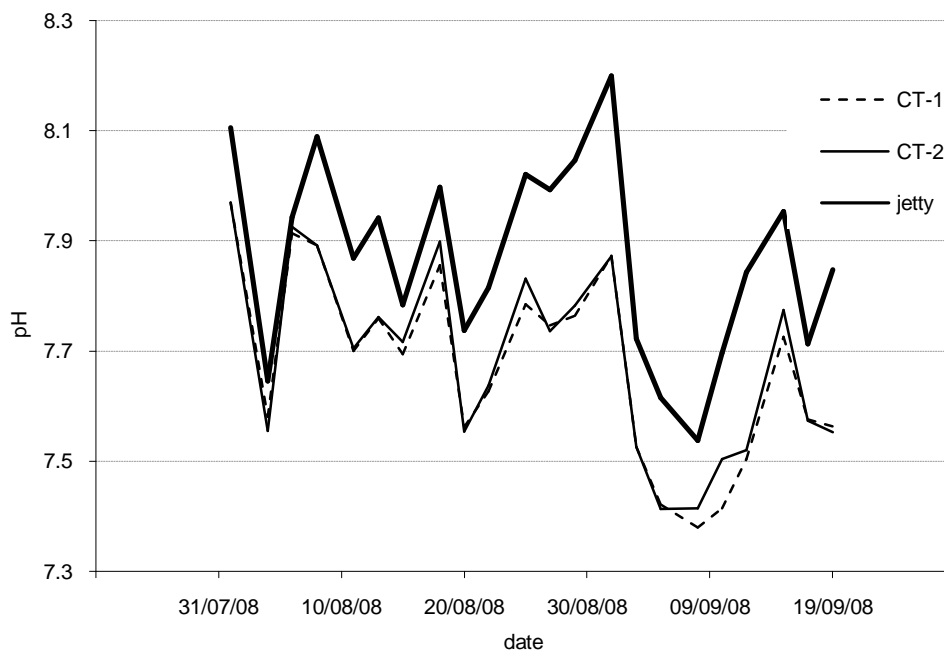


**Figure 3.4:** Calculated pCO<sub>2</sub> levels of treatments, means and errors (s.e.).



**Figure 3.5:** Calculated calcite ( $\Omega_{\text{calcite}}$ ) and aragonite ( $\Omega_{\text{aragonite}}$ ) saturation states of treatments, means and standard errors (s.e.).

Measurements of seawater  $\text{pH}_{\text{NBS}}$  at the institute's jetty and of inflow water in the  $c_T$  rooms show strong natural  $\text{pH}_{\text{NBS}}$  variations with values down to 7.54 at the jetty that are followed by the water in the institute's laboratories (**fig. 3.6**). However, on the way into the  $c_T$  rooms the water is additionally acidified, probably due to oxidative activity of microorganisms in the pipes and filtering system, leading to even lower minimum  $\text{pH}_{\text{NBS}}$  values of 7.38. The major  $\text{pH}_{\text{NBS}}$  changes could be buffered by the pre-conditioning cylinders (see above and **fig. 3.2**) and therefore be excluded from the experimental containers (**fig. 3.3**). Still, the high  $\text{pCO}_2$  saturation that is mirrored by low  $\text{pH}_{\text{NBS}}$  values could not in all cases be completely removed by the experimental setup, leading to an increased mean (for all temperature levels)  $\text{pCO}_2$  of 453.5  $\mu\text{atm}$  ( $\pm 75.0$  se) in the water at the 380  $\mu\text{atm}$  treatment. Mean water  $\text{pCO}_2$  of all temperature levels was 897.0  $\mu\text{atm}$  ( $\pm 54.7$  se) at the 840  $\mu\text{atm}$  and 1376  $\mu\text{atm}$  ( $\pm 95.5$  se) at the 1400  $\mu\text{atm}$  treatment.



**Figure 3.6:** Measured pH values at the institute's jetty and in constant temperature rooms (CT) during the experimental period.

Temperature (logged with HOBO<sup>®</sup> Onset Computer Corporation, Pocasset, MA temperature loggers, **fig. 3.3** or **3.4**) was kept stable for the experimental duration of 13 weeks.

The animals were allowed to slowly adapt to the respective treatments: starting from natural  $p\text{CO}_2$  of about  $380 \mu\text{atm}$ ,  $\text{CO}_2$  regulation of the  $840 \mu\text{atm}$  and  $1400 \mu\text{atm}$  treatment was reached within 15 days. Subsequently, starting from  $15 \text{ }^\circ\text{C}$ , temperature was changed by max.  $1 \text{ }^\circ\text{C}$  per day until treatment conditions were reached.

Bivalves that died during the experimental phase were replaced by new specimen to keep the animal density constant. These newly introduced individuals were not considered for further analysis.

*Data collection.* Animals were marked individually and shell height (see above) measured after the acclimatisation phase to the nearest  $0.02 \text{ mm}$  using a calliper. Animals were measured at the start and monthly throughout the experiment.

After 13 weeks, the whole soft tissue of one animal with an average increment of growth of each culture basin were removed from the shells and deep-frozen at  $-80 \text{ }^\circ\text{C}$ . Lipofuscin contents were determined by an extraction method modified after Vernet *et al.* (1988). For detailed sample preparation see chapter 1. Next, the fluorescence intensity of each sample was determined at the emission maximum of  $480 \text{ nm}$  (excitation at  $350 \text{ nm}$ ). According to Hill and Womersley (1993), lipofuscin concentrations were expressed as

relative fluorescent intensity (RFI) using 0.1 µg quinine sulphate per ml 1 N H<sub>2</sub>SO<sub>4</sub> as standard and were corrected by the incubation time and experimental start length (even though an age effect was expected to be low at the time spans considered here) of the individual bivalves:  $RFI_{corr} = RFI / (\text{inc. time} \times \text{start length})$ .

Shells of the individuals used for lipofuscin measurements were used for shell stability tests presented in chapter 4. The fastest grown animal of each culture basin was removed, too, as it was needed for shell chemistry analysis presented in chapter 5. Soft tissues of the remaining animals were also removed and wet soft tissue weight was measured. After drying for 24 h at 80 °C dry soft tissue weight and dry shell weight were measured, too. The condition index ( $C_i$ ) was calculated as  $C_i = \text{dry soft tissue weight} / \text{dry shell weight}$ . For comparison of different  $C_i$  s see Davenport and Chen (1987).

*Data analyses.* Data representing percentage values, namely mortality values, were arcsine transformed. Not normally distributed data or those of unequal variances were box-cox transformed to meet the necessary assumptions for an ANOVA. Mortality values were analysed by non-parametric Scheirer-Ray-Hare-Test as they were still not normally distributed after transformation. In another case no transformation was successful to reach equal variances. Here, the significance level  $\alpha$  was lowered from 0.05 to 0.01 to reduce the risk of type-1 errors (Glasby 1998). Data were analysed for significant differences by 2-factorial ANOVA and, in case of clear trends, by linear or quadratic regression. Differences between single treatment levels were identified by Tukey HSD post-hoc test. All statistical tests were provided by Statistica 8.0 software package.

### 3.3 Results

#### ***M. edulis***

##### Preliminary study

Though seawater in the high-dose CO<sub>2</sub> treatment turned out to be heavily undersaturated with respect to aragonite and calcite ( $\Omega_{\text{aragonite}} = 0.29$ ;  $\Omega_{\text{calcite}} = 0.5$ ), no anticipated immediate dissolution of the shells was apparent in living mussels. However, at shells of dead mussels we observed macroscopically visible signs of dissolution from the inner side, where no periostracum covers the calcium carbonate.

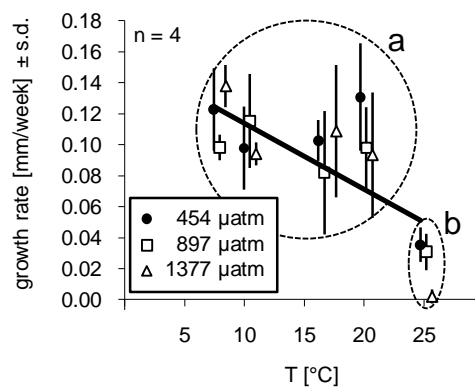
At starting conditions, TA was 2188.4 µmol / kg seawater (SW) in both treatments. By the end of the experimental phase, mean TA within the 380 µatm treatment was decreased to 2136.2 µmol / kg SW ( $\pm 35.5$  s.d.) corresponding to a net calcification rate of 0.232 ( $\pm$

0.155 s.d.) mmol CaCO<sub>3</sub> / (g<sub>dry weight</sub> \* d). Parallel, TA increased to 2239.6 μmol / kg SW (± 33.2 s.d.) in the 3118 μatm treatment corresponding to a negative net calcification rate of -0.423 (± 0.288 s.d.) mmol CaCO<sub>3</sub> / (g<sub>dry weight</sub> \* d).

Growth increments were very small (<0.03 mm / week) in all circuit systems and not significantly different in the high-pCO<sub>2</sub> treatment compared to the control (T-test, t = 0.50, p = 0.64). Mortality, however, was significantly increased at the high-dose CO<sub>2</sub> treatment (38.10 % ± 21.82 s.d., control: 3.57 % ± 7.14 s.d., T-test: t = -3.04, p = 0.029).

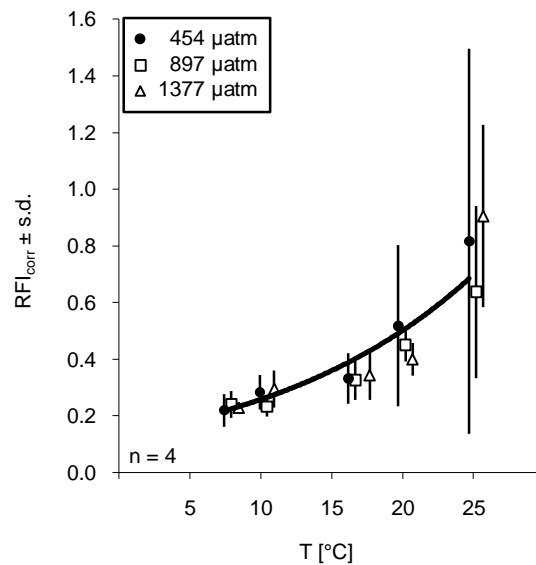
### Main experiment

PH<sub>NBS</sub> of the treatment water (**fig. 3.3**) was highly correlated to the pCO<sub>2</sub> in the treatment air (r<sub>pH</sub> = -0.94, p < 0.001). As it was calculated from the pH<sub>NBS</sub>, this held also true for water pCO<sub>2</sub> (**fig. 3.4**, r<sub>pCO2</sub> = 0.94, p < 0.001). With respect to calcite, the treatment water was undersaturated only at 7.5 °C at the 380 μatm treatment, up to 10 °C at the 840 μatm treatment and up to 16 °C at the 1400 μatm treatment (**fig. 3.5**). With respect to aragonite, however, almost all treatment combinations were undersaturated. Only at temperatures higher than 20 °C at the 380 μatm treatment and at 25 °C of the 840 μatm treatment Ω<sub>aragonite</sub> was equal to or greater than 1. Still, both bivalve species were able to significantly build up shell material at all treatments (**fig. 3.7** and **3.11**).



**Figure 3.7:** *M. edulis* shell growth. Mean growth rate<sub>(mm)</sub> of all individuals in the culture basins in dependence of temperature and water pCO<sub>2</sub>. Different letters indicate significantly different groups with respect to temperature. Error bars show standard deviations (s.d.) of measured individuals (n). Bold line: significant linear regression for all water pCO<sub>2</sub> conditions (454, 897 and 1377 μatm) with R<sup>2</sup> = 0.39 and p < 0.001. Model: y = -0.0042x + 0.1556, n = 60.

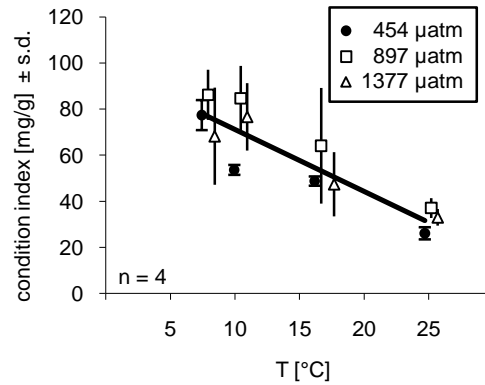
**Growth.** Shell growth of *M. edulis* (**fig. 3.7**) was not influenced by the acidification treatment but it decreased with higher temperature (linear regression, R<sup>2</sup> = 0.39, F = 37.45, p < 0.001). This effect was mainly caused by the strong growth reduction (on average 79 %) at 25 °C (2-fact. ANOVA, F = 11.95, p < 0.001).



**Figure 3.8:** Relative fluorescence intensity emitted by aging pigment lipofuscin in *M. edulis* soft tissue in dependence of temperature and water pCO<sub>2</sub>. Original values were corrected by incubation time and shell length at the start of the experiment. Error bars show standard deviations (s.d.) of measured individuals (n). Bold line: significant exponential regression for all water pCO<sub>2</sub> conditions (454, 897 and 1377 µatm) with  $R^2 = 0.59$  and  $p < 0.001$ . Model:  $y = 0.141 * e^{0.594x}$ ,  $n = 60$ .

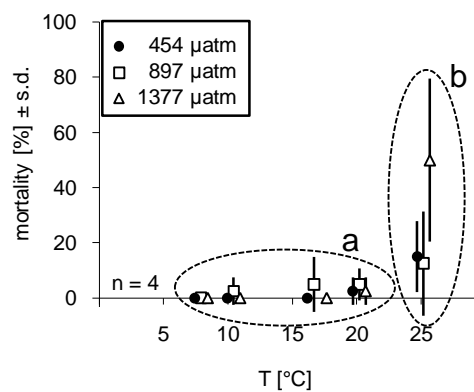
**Cellular Stress.** Lipofuscin accumulation in *M. edulis* increased exponentially from 7.5 to 25 °C (exponential regression,  $R^2 = 0.59$ ,  $F = 81.92$ ,  $p < 0.001$ , **fig. 3.8**) but was not influenced by the acidification treatment (2-fact. ANOVA,  $F = 0.50$ ,  $p = 0.609$ ).

**Fitness.** The condition index ( $C_i$ ) of *M. edulis* was influenced by pCO<sub>2</sub> (2-fact. ANOVA,  $F = 5.48$ ,  $p = 0.011$ ) as well as by temperature (2-fact. ANOVA,  $F = 30.46$ ,  $p < 0.001$ ; **fig. 3.9**). At 10 and 25 °C, it was significantly higher (on average 26 %) at 897 µatm CO<sub>2</sub> compared to 454 µatm. For all pCO<sub>2</sub> treatments (454, 897 and 1377 µatm), *M. edulis*  $C_i$  linearly decreased with increasing temperatures (linear regression,  $R^2 = 0.61$ ,  $F = 53.61$ ,  $p < 0.001$ ).  $C_i$  was positively correlated to shell growth ( $r = 0.56$ ,  $p = 0.001$ ).



**Figure 3.9:** *M. edulis* condition index ( $C_i$  = soft tissue [mg] / shell weight [mg]) in dependence of temperature and water  $p\text{CO}_2$ . Error bars show standard deviations of measured individuals (n). Bold line: significant linear regression for all water  $p\text{CO}_2$  conditions (454, 897 and 1377  $\mu\text{atm}$ ) with  $R^2 = 0.61$  and  $p < 0.001$ . Model:  $y = -2.62x + 96.18$ ,  $n = 60$ .

Mortality of *M. edulis* did not significantly increase between 7.5 and 20 °C but drastically (on average 1671 %) between 20 and 25 °C (2-fact. Sheirer-Ray-Hare test,  $F = 26.29$ ,  $p < 0.001$ ; **fig. 3.10**). Additionally, mortality was inversely related to shell growth ( $r = -0.58$ ,  $p < 0.001$ ) and  $C_i$  ( $r = -0.46$ ,  $p < 0.005$ ).

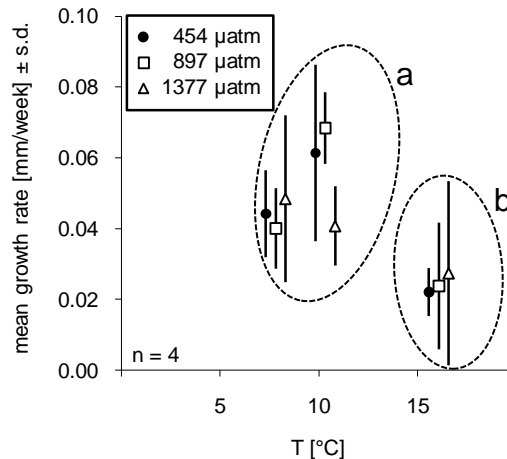


**Figure 3.10:** *M. edulis* mortality in dependence of temperature and water  $p\text{CO}_2$ . Different letters indicate statistically different groups with respect to temperature. Error bars show standard deviations of measured individuals.



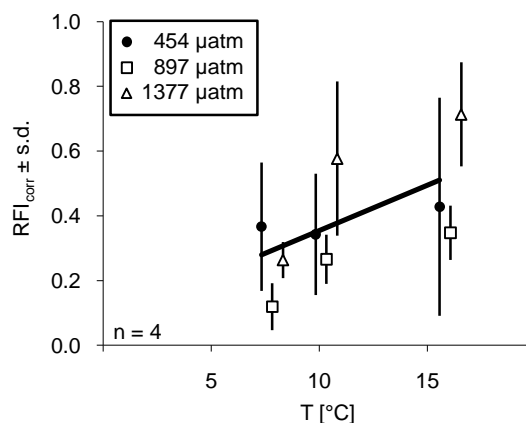
**A. islandica**

**Growth.** As in *M. edulis*, only temperature influenced the growth of *A. islandica* (2-fact. ANOVA,  $F = 10.6$ ,  $p < 0.001$ ; **fig. 3.11**). *A. islandica* shell growth decreased (on average 52 %) from 10 to 16 °C.



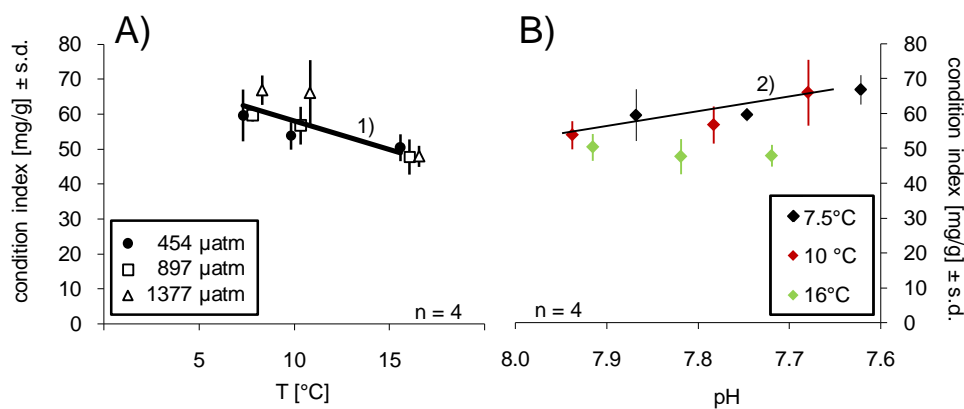
**Figure 3.11:** *A. islandica* shell growth. Mean growth rate (mm/week) of all individuals in the culture basins in dependence of temperature and water pCO<sub>2</sub>. Different letters indicate statistically different groups with respect to temperature. Error bars show standard deviations of measured individuals.

**Cellular Stress.** For all pCO<sub>2</sub> treatments (454, 897 and 1377 µatm), lipofuscin accumulation in *A. islandica* soft body increased linearly with temperature (**fig. 3.12**, linear regression,  $R^2 = 0.18$ ,  $F = 7.55$ ,  $p = 0.010$ ). Additionally, at all temperature levels (7.5, 10 and 16 °C), lipofuscin accumulation was significantly higher (on average 74 %) at a water pCO<sub>2</sub> of 1377 µatm compared to 897 µatm (**fig. 3.12**, 2-fakt. ANOVA,  $F = 8.34$ ,  $p = 0.002$ ).



**Figure 3.12:** Relative fluorescence intensity emitted by aging pigment lipofuscin in *A. islandica* soft tissue in dependence of temperature and water pCO<sub>2</sub>. Original values were corrected by incubation time and shell length at the start of the experiment. Error bars show standard deviations (s.d.) of measured individuals ( $n$ ). Bold line: significant linear regression for all water pCO<sub>2</sub> conditions (454, 897 and 1377 µatm) with  $R^2 = 0.18$  and  $p = 0.010$ . Model:  $y = 0.031x + 0.042$ ,  $n = 36$ .

*Fitness.* For all pCO<sub>2</sub> treatments (454, 897 and 1377 µatm), the C<sub>i</sub> of *A. islandica* linearly decreased from 7.5 to 16 °C (**fig. 3.13A**; linear regression: R<sup>2</sup> = 0.48, F = 30.98, p < 0.001). Additionally, at the two lower temperature levels (7.5 and 10 °C), the C<sub>i</sub> was negatively correlated to the treatment water pH (**fig. 3.13B**, r = -0.60, p = 0.002). Mortality of *A. islandica* however, was independent of both temperature and water pCO<sub>2</sub> (2-factor. Sheirer-Ray-Hare test, F = 0.23, p = 0.89 resp. F = 1.48, p = 0.48). Still, it was negatively correlated to shell growth (r = -0.38, p = 0.024).

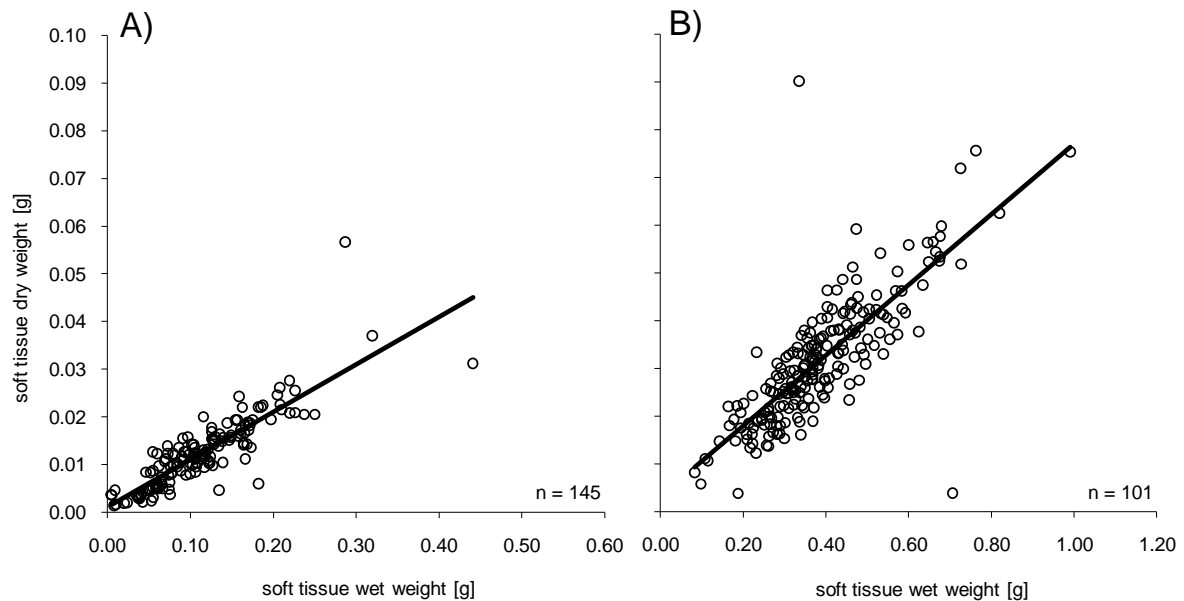


**Figure 3.13:** *A. islandica* condition index (C<sub>i</sub> = soft tissue [mg] / shell weight [g]) in dependence of temperature and water pCO<sub>2</sub> (A) and pH (B). Error bars show standard deviations. Error bars show standard deviations (s.d.) of measured individuals.

1) Significant linear regression for all water pCO<sub>2</sub> conditions (454, 897 and 1377 µatm) with R<sup>2</sup> = 0.48 and p < 0.001. Model:  $y = -1.82x + 76.22$ , n = 36.

2) Significant linear correlation for temperatures 7.5 and 10 °C with r = 0.60, p = 0.002. Model:  $y = -39.05x + 364.0$ , n = 24.

Wet weight and dry weight of *M. edulis* (r = 0.84, p < 0.001, **fig. 3.14A**) and *A. islandica* (r = 0.74, p < 0.00, **fig. 3.14A**) soft tissue were well correlated, demonstrating the good comparability of the CIs used here and in chapter 1.



**Figure 3.14:** Correlations of soft tissue dry weight [g] and soft tissue wet weight [g] in *M. edulis* (A) and *A. islandica* (B).

A) *M. edulis*: linear correlation with  $y = 0.100x + 0.001$ ,  $r = 0.84$ ,  $p < 0.001$

B) *A. islandica*: linear correlation with:  $y = 0.074x + 0.003$ ,  $r = 0.74$ ,  $p < 0.001$

### 3.4 Discussion

**Growth.** Both species, *M. edulis* and *A. islandica*, were able to produce significant amounts of shell material over the whole range of treatments even though most treatment combinations were undersaturated with respect to aragonite and - at high  $p\text{CO}_2$  and low temperature treatments - also with respect to calcite. Together with the fact that growth of both species decreased with temperatures higher than 10 °C while the saturation state increased, we found strong evidence that bivalve shell growth is independent of the seawater  $\text{CaCO}_3$  saturation state ( $\Omega_{\text{aragonite}}$ : 0.31 to 1.32  $\Omega_{\text{calcite}}$ : 0.52 to 2.13) and  $p\text{CO}_2$  level between 454 and 1377  $\mu\text{atm}$ .

Gazeau *et al.* (2007) found that *M. edulis* shells dissolve at  $p\text{CO}_2$  values exceeding 1800  $\mu\text{atm}$ . Here, shell dissolution could not be observed in the main study but only in the preliminary study at a very high  $p\text{CO}_2$  of 3120  $\mu\text{atm}$ , where negative calcification rates occurred as measured by increasing total alkalinity. Overall very low growth rates in the preliminary study (about 1 / 10 of the growth in the main experiment) represent a general high stress or low nutrition level that probably blurred any acidification effects on shell growth that would have been expected at a  $\text{pH}_{\text{NBS}}$  of 7.26.

The independence of shell growth rates of water pCO<sub>2</sub> at all temperature levels of our main experiment, however, corroborates earlier findings of Berge *et al.* (2005) and Michaelidis *et al.* (2005). Both studies found detrimental effects on shell growth to appear at a lower pH<sub>NBS</sub> (< 7.4) than it was reached here (> 7.6).

Declining shell growth rates with higher temperatures and steep growth reduction at 25 °C corroborate similar findings presented in chapter 1 even though the experimental setup was different. We explain this pattern by the equal food supply over all temperature levels that did not meet increased nutrition requirements of higher metabolic rates at higher temperatures (see chapter 1, Page and Hubbard 1987; Jörgensen *et al.* 1990; Kossak 2006).

In contrast to *M. edulis* but again corroborating findings of chapter 1, growth of *A. islandica* was less influenced by temperature. It peaked at 10 °C which supports previous results (Witbaard and Bergman 2003) and which we also found at salinities higher than 25 in the experiment presented in chapter 1. The very low growth at 16 °C agrees well with the observed distribution limit at the same temperature (Cargnelli *et al.* 1999; Witbaard and Bergman 2003).

Importantly, these findings show that, with respect to shell growth, *M. edulis*' and *A. islandica*'s sensitivity towards acidification does not change within the range of the temperatures applied.

*Cellular stress and shell formation.* As in chapter 1, in both *M. edulis* and *A. islandica*, lipofuscin accumulation increased with temperature. Increasing temperature can induce oxidative cellular damage due to an increase in free radical production (Abele *et al.* 2002) and may lead to the observed increase in lipofuscin in *M. edulis* and *A. islandica* soft tissue.

In contrast to chapter 1, average lipofuscin accumulation in *A. islandica* ( $0.38 \pm 0.23$  s.d.) was not significantly lower compared to *M. edulis* ( $0.41 \pm 0.28$  s.d.). Here, the overall amount of lipofuscin accumulated in *M. edulis* was much lower than in chapter 1 ( $2.04 \pm 1.67$  s.d.). In both experiments, the bivalves were of similar size and collected at the same time of the year (end of March / begin of April). Therefore, we explain the difference in lipofuscin accumulation by an overall better water quality due to the flow-through setup as lipofuscin accumulation in *M. edulis* is known to be sensitive to water quality (Aarab *et al.* 2008; Kagley *et al.* 2003; Krishnakumar *et al.* 1994; Krishnakumar *et al.* 1997).

However, similar shapes of the lipofuscin-temperature relationship of *M. edulis* and statistically equal slopes (chapter 1:  $0.035 \pm 0.019$  95% CI, this study:  $0.031 \pm 0.023$  95% CI) of the lipofuscin accumulation in *A. islandica* in both experiments show the good reproducibility of this proxy for temperature stress.

The slightly reduced lipofuscin accumulation of *A. islandica* at the intermediate acidification treatment cannot easily be explained physiologically. Michaelidis *et al.* (2005)

measured reduced metabolic rates in *M. galloprovincialis* only at a pH lower than 7.3 and the results of our study do not indicate that *A. islandica* is more sensitive towards acidification than *M. edulis*. Still, *A. islandica* is known to strongly reduce its metabolism under anoxic conditions (Oeschger 1990) and it might already be slightly reduced at a rather weak level of acidification. *A. islandica* metabolism might then be increased again to assure shell formation if conditions get even more acidic. However, this remains speculative and further investigations of *A. islandica*'s physiology in dependence of changes in environmental pCO<sub>2</sub> are required to judge this pattern.

Bivalve molluscs were postulated to be able to at least partially compensate for acidosis (Burnett 1997) via an up-regulation of extracellular bicarbonate and Ca<sup>2+</sup> which would consequentially increase the calcium carbonate saturation state ( $\Omega$ ). The bicarbonate and calcium ions are thought to be provided by dissolving bivalve shell material (Crenshaw and Neff 1969). However, in all acidification treatments of the main experiment we found positive shell growth rates. Additionally, in recent experiments, no bicarbonate- or Ca<sup>2+</sup>-driven control could be found in *M. edulis* (Thomsen 2008). The author proposes low metabolic rates of mussels that can be maintained without using a pH-sensitive oxygen binding pigment, to allow the animals to do without the maintenance of a constant pH. Additionally, in *M. edulis* extrapallial fluid (EPF) the pH decreases when valves are closed (e.g. during low tides) and *M. edulis* haemolymph and EPF pH<sub>NBS</sub> were measured to be less than 7.6 already at "normal" environmental water conditions (pH<sub>NBS</sub> 8.1, Crenshaw 1972; Thomsen 2008, Heinemann pers. comm.). This gives confidence to the assumption that the animals are rather robust against acidosis without being able to actively compensate for it. Similar is true for *A. islandica* as this species is known to regularly keep its shells closed for days during which it stays buried (Taylor 1976). In this time the haemolymph pH decreases from 7.64 ("normal" value) to 7.47 (Taylor 1976).

Still, the question remains how bivalves are able to precipitate CaCO<sub>3</sub> under acidic conditions. One obvious explanation was already discussed in chapter 2: As *M. edulis* is able to precipitate low-magnesium calcite (< 2 mol%) under high-magnesium conditions (Mg / Ca around 5200 mmol / mol) in the EPF and as in both bivalve species shell chemistry parameters do not follow models of inorganic CaCO<sub>3</sub> precipitation, the bivalves' shell formation has to be strongly biologically controlled. Especially two morphological features of the shell forming apparatus are discussed to allow the animals' calcification even under inorganically unfavourable conditions: (i) the organic matrix and (ii) the division of the EPF into two compartments.

The organic matrix of mollusc shells is supposed to build the framework in which calcification takes place (e.g. Bøggild 1930; Wilbur and Saleuddin 1983, Zhang and Zhang 2006). Also, at bivalve shell calcification polysaccharide-associated sulphates catalyse

CaCO<sub>3</sub> precipitation in the organic matrix (chapter 2, Addadi *et al.* 1987; Lopes-Lima *et al.* 2005).

The division of the extra-pallial space at the bivalves' pallial line into an inner and an outer partition (Wilbur and Saleuddin 1983; Vander Putten *et al.* 2000) reduces the respective volume of EPF that has to become supersaturated with respect to calcite or aragonite. Especially the outer extra-pallial space can be considered to be only a small gap between the outer pallial edge, the periostracum and the inner shell. Hypothesised Ca<sup>2+</sup> / 2H<sup>+</sup> exchange at the mantle epithel (chapter 1, Carré *et al.* 2006; Oliveira *et al.* 2008) therefore should be able to increase the pH and Ca<sup>2+</sup> concentration to reach supersaturation at least of calcite, even at environmental pH of less than 7.6 (McConnaughey and Gillikin 2008). As we found positive growth rates under hypercapnia also for *A. islandica*, this species appears to be able to raise pH and Ca<sup>2+</sup> concentration even to a level of aragonite supersaturation. At the same time as calcification takes place in the outer EPF, passive carbonate dissolution can happen at the shell surface at the inner extra-pallial space (Findlay *et al.* 2009 in review).

It has to be mentioned, though, that the effective partition into inner and outer EPF is still under debate and in Ca isotope distributions ( $\Delta^{44/40}\text{Ca}$ ) Heinemann *et al.* (2008) found evidence of *M. edulis* calcite and aragonite being precipitated from the same fluid.

*Fitness.* Additionally to *M. edulis* shell growth, also the condition index (C<sub>i</sub>) decreased with higher temperatures due to even stronger decreasing growth or increasing disintegration of the soft body (see discussion in chapter 1, Kautsky 1982). This corroborates findings of Michaelidis *et al.* (2005) who also found parallel reduced growth of shell and soft tissue of *M. galloprovincialis*, however, with increasing pCO<sub>2</sub>.

An only slightly increased C<sub>i</sub> at our intermediate pCO<sub>2</sub> treatment results from statistically insignificant lower mean shell weights (2-fakt.ANOVA: F = 2.3, p = 0.122) and similarly weak and also statistically insignificantly increases in mean soft tissue weights (2-fakt. ANOVA: F = 2.0, p = 0.145). The calculated higher C<sub>i</sub> can therefore be interpreted as a combination of (i) the beginning of a trend towards reduced calcification and (ii) a slightly better condition of the animals. Gazeau (2007) found reduced calcification already at low acidification, too. Additionally, the mean pH of the intermediate pCO<sub>2</sub> (7.81) treatment was close to the one at the institute's jetty (7.87). Therefore, the higher soft tissue at intermediate water pCO<sub>2</sub> might indicate an adaptation of *M. edulis* to comparably acidic conditions in their natural environment. Comparisons with *M. edulis* populations from less acidic regions could reveal if this would be a general physiological characteristic of *M. edulis* or an adaptation of the local population.

As in chapter 1, the  $C_i$  of *A. islandica* decreased with higher temperature and, at lower temperatures (7.5 and 10 °C), in this study with higher pHs, too. This increasing  $C_i$  with lower pH results from two different weak effects at the two low temperature treatments (7.5 and 10 °C). At 7.5 °C, mean soft tissue dry weight showed a (statistically insignificant) increasing trend with lower pH ( $r = -0.44$ ,  $p = 0.149$ ). At 10 °C, however, mean shell dry weight showed a (statistically insignificant) decreasing trend with lower pH ( $r = 0.52$ ,  $p = 0.085$ ). The respective other parameter (shell dry weight at 7.5 °C, soft tissue dry weight at 10 °C) remained the same at all pH levels. Like in *M. edulis*, the former can indicate an adaptation of the local *A. islandica* population to the environmental situation, where oxygen deficiencies that coincide with low pH levels occur regularly in summer (Weigelt 1986; Christmas and Jordan 1987; Hansen *et al.* 1999). At optimal growth temperatures around 10 °C, however, shell growth differences caused by a pH gradient might become visible that are too low to be resolved at lower growth rates.

Mortalities of both bivalve species were negatively correlated to growth rates and *M. edulis* mortality also to  $C_i$ . In *M. edulis* all three parameters were mainly controlled by temperature. *M. edulis* mortality only increased significantly with  $p\text{CO}_2$  at the high-dose treatment (3120  $\mu\text{atm}$ ) of the preliminary study, corroborating results from other studies (Bamber 1990; Berge *et al.* 2006). However, obviously, as the effects on growth rates and  $C_i$ , the acidification effect on mortality of *M. edulis* does not increase when temperatures get disadvantageous for the bivalve. In *A. islandica* only single high mortalities occurred at the natural distribution limit temperature of 16 °C where growth rates were lowest. Within the here applied range of 380 to 1400  $\mu\text{atm}$   $p\text{CO}_2$  *A. islandica* does not appear to be more sensitive towards acidification than *M. edulis*.

## Conclusion

The temperature effects presented in chapter 1 could be supported in this study. It is shown that temperatures of 25 °C strongly reduce performance of *M. edulis* whereas *A. islandica* competitiveness is already reduced at 16 °C. However, bivalves suffering from extreme temperatures did not show increased sensitivity towards acidification. For both species investigated in this study, besides very weak trends of reduced shell weight, no indication of a direct detrimental effect of an acidification level likely to be reached within the next 100 years could be identified. Also, increased  $p\text{CO}_2$  did not modulate temperature sensitivities.

$\text{CO}_2$  partial pressures of 16 000 and even 80 000  $\mu\text{atm}$  have been reported from anoxic zones and hydrothermal vents, respectively (Childress *et al.* 1993; Knoll *et al.* 1996). But high  $p\text{CO}_2$  and low pH levels can also be considered as normal at less exotic

environments. In rock pools oxygen at night is consumed and replaced by CO<sub>2</sub> (Truchot and Duhameljouve 1980; Morris and Taylor 1983), volcanic activity can acidify shallow water areas (Hall-Spencer *et al.* 2008; Martin *et al.* 2008), also shallow salt marshes can become hypercapnic (Cochran and Burnett 1996) and at upwelling zones high-pCO<sub>2</sub> water ascends to the ocean surface (Feely *et al.* 2004). Additionally, due to respiration of organic matter from rivers, pCO<sub>2</sub> in estuaries was reported to reach extreme high levels, e.g. 5 700 µatm in the Scheldt, Netherlands (Frankignoulle *et al.* 1996). Still, only a limited extrapolation from observations at local sites to global scale was stated to be reasonable (Riebesell 2008). However, if summing up the different coastal areas, a large number of the World's coastal regions are subject to at least temporal strong natural acidification. Therefore, in all these regions, species must have developed ways to resist a certain amount of hypercapnia (Burnett 1997).

Of course, this adaptation does not necessarily include a resistance to long-term changes of mean water pCO<sub>2</sub> that occurs from anthropogenic increase of atmospheric pCO<sub>2</sub> or pollution of estuaries. Here, we were able to show that the two bivalve species subject to this study, that originate in the estuarine Baltic Sea, are able to resist a mean water pCO<sub>2</sub> of up to 1377 µatm for several months, independently of water temperature. Comparably low metabolic rates that allow the bivalves to do without a pH-sensitive oxygen-binding pigment in the haemolymph as well as a biologically controlled calcification obviously contribute to this robustness towards acidification.

Under the projected higher temperatures, the future competitiveness of *M. edulis* and *A. islandica* might be reduced. But if competing species or important predators (e.g. crabs and starfish) suffer more strongly from ocean acidification, the abundance of the two bivalve species might even increase in comparably cold regions.





## Chapter 4

### Mg / Ca and Sr / Ca ratios in shells of young *Mytilus edulis* L. and *Arctica islandica* L. formed under different temperatures and levels of acidification

#### Abstract

The reconstruction of paleo-climate requests diagenetically stable archives with high resolution over years to decades. Bivalve shell element ratios (Mg / Ca, Sr / Ca) depend on seawater temperatures and can therefore theoretically be used as proxies for past climate scenarios.

Anthropogenic release of carbon dioxide (CO<sub>2</sub>) into the atmosphere results in an acidification of the World's oceans and shell growth of bivalves was found to be sensitive towards this acidification. As effects of different environmental parameters on bivalve shell growth can interact, this may also be the case for shell element ratios (Mg / Ca, Sr / Ca). Consequently, in this study, Mg / Ca and Sr / Ca ratios in *A. islandica* and *M. edulis* shells were evaluated in fully-crossed 2-factorial (temperature vs. pCO<sub>2</sub>) experiments to explore the possible sensitivity of temperature effects towards acidification.

We were able to reproduce the Mg / Ca temperature relationship in *M. edulis* calcite found in chapter 2. However, variation between bivalve individuals as well as the influence of water acidification state at high temperature (25 °C) sum up to a significant amount of variance. We propose an exponential shape of the Mg / Ca-temperature dependency that can be explained by biological control overlapping inorganic Mg incorporation. This Mg / Ca-temperature model is remarkably similar to a relationship that was observed in foraminifera. In both bivalve species, Sr / Ca was independent of water pCO<sub>2</sub>. Increasing Sr / Ca in *M. edulis* shells at temperatures higher than 16 °C is probably a secondary effect of the exponential increase of Mg / Ca. In *A. islandica* aragonite, only Sr / Ca slightly linearly increased with temperature.

## 4.1 Introduction

To reconstruct past climate scenarios, diagenetically stable archives with high resolution over years to decades are needed. Recent studies show that bivalve shell element ratios (Mg / Ca, Sr / Ca) depend on seawater temperatures and can therefore be theoretically used as proxies for paleo-climate (Klein *et al.* 1996a; Klein *et al.* 1996b; Hendry *et al.* 2001; Holmden and Hudson 2003; Lazareth *et al.* 2003; Freitas *et al.* 2005; Immenhauser *et al.* 2005; Freitas *et al.* 2008; Surge and Lohmann 2008). The reliability of these shell chemistry characteristics as proxies for environmental parameters, however, was found to be rather weak. It was emphasized that metabolic effects are probably too strong (Vander Putten *et al.* 2000; Immenhauser *et al.* 2005; Freitas *et al.* 2008) and biomineralization processes too poorly understood (Heinemann *et al.* 2008). Still, in a recent study, Wanamaker *et al.* (2008) found promising relationships of Mg / Ca and Sr / Ca in *M. edulis* shells with temperature, although at a relatively low salinity of 23 only.

In this study, the two bivalve species *Arctica islandica* (L.) and *Mytilus edulis* (L.) were kept in a lab experiment under controlled environmental conditions to measure the influence of water temperature on the two divalent Ca substituents Mg and Sr.

Increased anthropogenic release of carbon dioxide (CO<sub>2</sub>) into the atmosphere will result in an acidification of the World's oceans to a pH of about 7.3 within the next 300 years (Caldeira and Wickett 2003; Sabine *et al.* 2004). Mortality, metabolism rate and shell growth of *Mytilus edulis* and *M. galloprovincialis* were found to be sensitive towards ocean acidification (Bamber 1990; Michaelidis *et al.* 2005; Berge *et al.* 2006). Additionally, Gazeau *et al.* (2007) found reduced calcification of *M. edulis* already at comparably high pH-values of < 8.0. in a short term experiment (hours of exposition).

It is known that effects of different environmental parameters on bivalve shell growth can interact (e.g. Kossak 2007) and that this may also be the case for Ca substituent systems (Heinemann *et al.* 2008; Wanamaker *et al.* 2008). Therefore, it is possible that the effects of temperature and acidification on shell chemistry characteristics of *A. islandica* and *M. edulis* interact, too. Consequently, Mg / Ca and Sr / Ca ratios in *A. islandica* and *M. edulis* shells were evaluated in fully crossed 2-factorial (temperature vs. pCO<sub>2</sub>) experiments to explore the possible sensitivity of temperature effects towards acidification.

## 4.2 Methods

*Culture.* Individually marked bivalves (*M. edulis* and *A. islandica*) were cultured in temperature-insulated basins at the Leibniz-Institute of Marine Sciences IFM-GEOMAR, Kiel, Germany. The animals were allowed to slowly adapt to the respective treatments: starting from natural pCO<sub>2</sub> of about 380 µatm, stable pCO<sub>2</sub> of the high-CO<sub>2</sub> treatments (840 and 1400 µatm) was reached within 15 days. Subsequently, starting from 15 °C, temperature was changed by a max. of 1 °C per day until treatment conditions were reached. Temperatures of 7.5, 10, 16, 20 and 25 °C (only 7.5 – 16 for *A. islandica*) were kept stable for the experimental duration of 13 weeks.

Treatments of pCO<sub>2</sub> were realized in 12 4-l-containers nested within each temperature basin (see chapter 3). In each container, 10 individuals of *M. edulis* and *A. islandica*, respectively, were cultured. Water was constantly exchanged by a flow through system, assuring an exchange of the treatment water in the containers within < 1 / 2 h. Air of different pCO<sub>2</sub> was provided by a central air-CO<sub>2</sub>-mixing device (Bleich *et al.* 2008). To assure water acclimatisation to the desired temperature and pCO<sub>2</sub> levels, water of all 15 treatment combinations was pre-conditioned in 15 300-l-cylinders installed upstream of the culture containers. Resulting pCO<sub>2</sub> values in the treatment air were measured with a GDZ 401 infrared CO<sub>2</sub> analyzer (HTK, Hamburg, Germany). Dissolved inorganic carbon (DIC) and total alkalinity (TA) of the treatment water were measured three times during the experimental period. TA values were determined by potentiometric open-cell titration with hydrochloric acid (Dickson *et al.* 2007) on a VINDTA (Versatile INSTRUMENT for the Determination of Titration Alkalinity, MARIANDA, Kiel, Germany) autoanalyzer. DIC values were measured coulometrically after Dickson *et al.* (2007) on a SOMMA (Single-Operator Multi-Metabolic Analyzer, University of Rhode Island, Kingston, RI) autoanalyzer. Treatment water pH was measured 3 days a week with a WTW pH meter (pH 330i, sensor: Sen Tix 81, WTW GmbH, Weilheim, Germany). With this information pCO<sub>2</sub> and saturation states with respect to calcite ( $\Omega_{\text{Calcite}}$ ) and aragonite ( $\Omega_{\text{Aragonite}}$ ) of the treatment water could be calculated (Lewis and Wallace 1998, **tab. 4.1**).

**Table 4.1:** Mean pCO<sub>2</sub> and pH and CaCO<sub>3</sub> saturation state ( $\Omega$ ) levels of the three acidification treatments. Errors are standard deviations (s.d.) or, if representing the variation of the means of 5 different temperature treatments over time, standard errors (s.e.).

treatment	[ $\mu$ atm]:	380	840	1400
pCO <sub>2</sub> air	[ $\mu$ atm]:	391.2 $\pm$ 21.0 s.d.	868.9 $\pm$ 32.4 s.d.	1358.2 $\pm$ 52.5 s.d.
pCO <sub>2</sub> water	[ $\mu$ atm]:	453.5 $\pm$ 75.0 s.e.	897.0 $\pm$ 54.7 s.e.	1376 $\pm$ 95.5 s.e.
pH <sub>NBS</sub> :		7.95 $\pm$ 0.03 s.e.	7.81 $\pm$ 0.01 s.e.	7.70 $\pm$ 0.02 s.e.
$\Omega_{\text{calcite}}$		1.51 $\pm$ 0.23 s.e.	1.20 $\pm$ 0.17 s.e.	0.96 $\pm$ 0.16 s.e.
$\Omega_{\text{aragonite}}$		0.92 $\pm$ 0.14 s.e.	0.73 $\pm$ 0.11 s.e.	0.58 $\pm$ 0.10 s.e.

For further information about culturing conditions see detailed descriptions in chapter 3. Bivalves that died during the experimental phase were replaced by new specimen to keep the animal density constant. These newly introduced individuals were not considered for further analysis.

*Data collection.* Shell growth of the 96 independently cultured bivalves was monitored by repeated measures of shell length and subsequently weighing of the sampled shell material newly grown since last measurement of length (see chapter 2).

To detect Mg / Ca and Sr / Ca in the bivalve shells, samples were taken at the shell margin newly formed under experimental conditions (only calcite at *M. edulis* shells). To measure Mg / Ca and Sr / Ca ratios, the samples were analyzed for Ca, Mg and Sr elemental concentrations by inductively coupled plasma optical emission spectrometry (ICP-OES) at the Institute of Geosciences at Kiel University. For this purpose, a portion of each sample was dissolved in 2 % HNO<sub>3</sub>. Mean resulting measuring error (2 s.e.) of repeated measures of the ECRM 752-1 standard was 0.0003 mmol / mol for Sr / Ca and 0.007 mmol / mol for Mg / Ca.

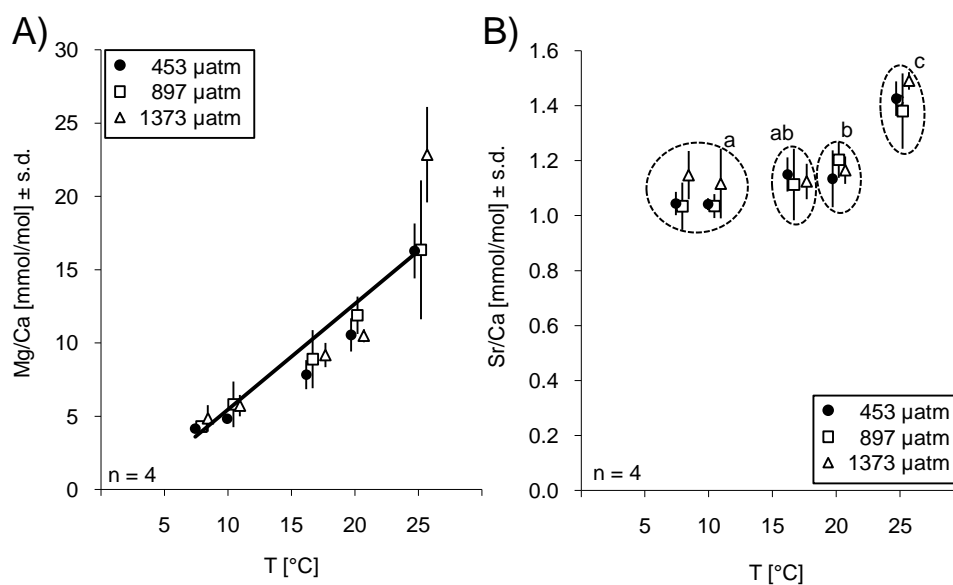
*Data analyses.* Not normally distributed data were Box-Cox transformed to meet the necessary assumptions for an ANOVA. Data were analysed for statistically significant effects and interactions of treatment factors by 2-factorial ANOVA and, in case of clear trends, by linear or exponential regression. Differences between single treatment levels were identified by Tukey HSD post-hoc test. All statistical tests were provided by Statistica 8.0 software package.

## 4.3 Results

*M. edulis*. For all pCO<sub>2</sub> treatments (453, 897 and 1376 µatm) Mg / Ca ratios strongly increased with temperature (eq. 4.1, fig. 4.1A) from 7.5 °C to 25 °C. Additionally, at 25 °C, Mg / Ca in *M. edulis* calcite shells was higher at a water pCO<sub>2</sub> of 1376 compared to 453 µatm (2-fakt. ANOVA, F = 5.29, p = 0.009, fig. 4.1A).

$$\text{Mg / Ca} (*10^{-3}) = 0.764(\pm 0.107) * T - 2.313(\pm 1.797), \quad (4.1)$$

$$R^2 = 0.78, F = 204.78, p < 0.001, \text{ errors: } 95\% \text{ CI, } n = 60.$$



**Figure 4.1.** Minor element ratios in *M. edulis* calcite: Mg / Ca (A) and Sr / Ca (B) in dependence of temperature and water pCO<sub>2</sub>. Equal letters in B) indicate significantly equal groups. Error bars indicate standard deviations (s.d.) of measured individuals (n).

Bold line in A): significant linear regression for all pCO<sub>2</sub> conditions (453, 897 and 1376 µatm) with R<sup>2</sup> = 0.78 and p < 0.001. Model (± 95% CI): Mg/Ca [mmol/mol] = 0.764(±0.107) \* T - 2.313(±1.797), n = 60.

Sr / Ca in *M. edulis* shells was not influenced by the acidification treatment. However, Sr / Ca ratios increased (30 %) with temperature between 16 °C and 25 °C (2-fact. ANOVA, F = 26.63, p < 0.001, fig. 4.1B). In *M. edulis* shell calcite, Sr / Ca and Mg / Ca strongly correlated with each other (r = 0.88, p < 0.001).

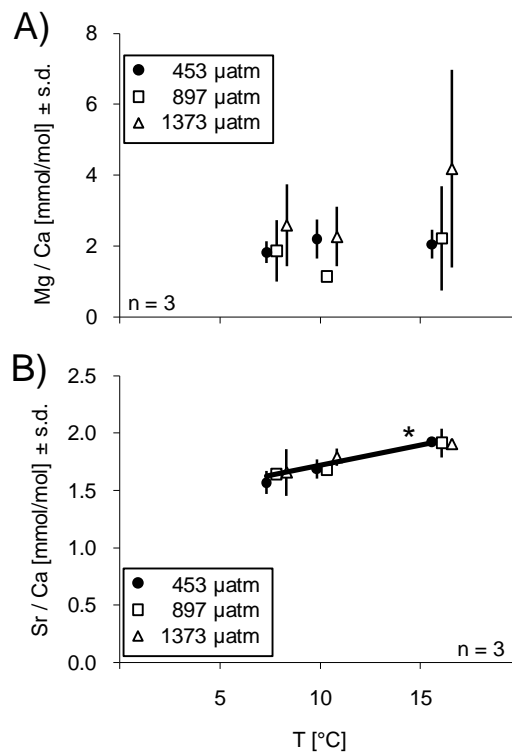
In this study, Mg / Ca in *A. islandica* aragonite shells (fig. 4.2A) was neither influenced by temperature nor by water pCO<sub>2</sub>.

Sr / Ca was, again, not influenced by acidification (2-fact. ANOVA, F = 1.72, p = 0.198) but linearly increased from 7.5 to 16 °C (linear regression, eq. 4.2, fig. 4.2B). Like in *M. edulis*

calcite, in *A. islandica* aragonite, Sr / Ca and Mg / Ca ( $r = 0.39$ ,  $p = 0.043$ ) correlated significantly with each other.

$$(Sr / Ca * 1000) = 0.035(\pm 0.010) * T + 1.37(\pm 0.12), \quad (4.2)$$

$$R^2 = 0.66, F = 47.90, p < 0.001, \text{ errors: } 95\% \text{ CI, } n = 27.$$



**Figure 4.2.** Minor element ratios in *A. islandica* aragonite: Mg / Ca (A) and Sr / Ca (B) in dependence of temperature and water pCO<sub>2</sub> treatments. Error bars indicate standard deviations (s.d.) of measured individuals (n).

Bold line in A): significant linear regression for all pCO<sub>2</sub> conditions (453, 897 and 1376 μatm) with  $R^2 = 0.66$ ,  $p < 0.001$ . Model ( $\pm$  95% CI):  $Sr/Ca \text{ [mmol/mol]} = 0.035(\pm 0.010) * T + 1.37(\pm 0.12)$ ,  $n = 27$ .

**Table 4.2.** Results of ICP-OES and TIMS measurements: *M. edulis* data. Standard deviations (s.d.) represent variation between measured individuals of the same treatment combination (temperature and salinity).

temperature	mean pCO <sub>2</sub> (water) [μatm]	n = (no. of individuals measured)	<i>M. edulis</i>		<i>A. islandica</i>	
			Mg/Ca [mmol/mol] (±s.d.)	Sr/Ca [mmol/mol] (±s.d.)	Mg/Ca [mmol/mol] (±s.d.)	Sr/Ca [mmol/mol] (±s.d.)
7.5 °C	454	4	4.12 (±0.27)	1.04 (±0.04)	1.83 (±0.30)	1.57 (±0.10)
	897	4	4.29 (±0.43)	1.03 (±0.09)	1.87 (±0.87)	1.64 (±0.04)
	1376	4	4.85 (±0.91)	1.15 (±0.09)	2.59 (±1.15)	1.66 (±0.21)
10 °C	454	4	4.83 (±0.001)	1.04 (±0.02)	2.20 (±0.56)	1.69 (±0.08)
	897	4	5.81 (±1.55)	1.04 (±0.04)	1.15 (±0.13)	1.68 (±0.02)
	1376	4	5.72 (±0.89)	1.12 (±0.13)	2.26 (±0.84)	1.79 (±0.08)
16 °C	454	4	7.84 (±0.99)	1.15 (±0.06)	2.05 (±0.41)	1.92 (±0.01)
	897	4	8.89 (±1.98)	1.11 (±0.13)	2.22 (±1.48)	1.91 (±0.13)
	1376	4	9.17 (±0.82)	1.12 (±0.06)	4.19 (±2.79)	1.91 (±0.04)
20 °C	454	4	10.55 (±1.12)	1.13 (±0.10)		
	897	4	11.89 (±1.27)	1.20 (±0.07)		
	1376	4	10.49 (±0.44)	1.17 (±0.05)		
25 °C	454	4	16.28 (±1.88)	1.43 (±0.06)		
	897	4	16.36 (±4.74)	1.38 (±0.14)		
	1376	4	23.32 (±5.39)	1.49 (±0.03)		

## 4.4 Discussion

### Magnesium

*M. edulis*. The linear increase of Mg / Ca in calcite with higher temperatures can in principle be explained inorganically (Katz 1973; Oomori *et al.* 1987; Rosenberg and Hughes 1991; Lopez *et al.* 2009). However, biological control is suspected to mainly control the incorporation of Mg into *M. edulis* shells as Mg / Ca-temperature relationships found in other studies strongly vary (chapter 2: tab. 2.4). Additionally, high amounts of Mg are probably bond to the organic matrix (Clarke *et al.* 2009) and evidence was found that the true relationship is rather an exponential than a linear one (chapter 2).

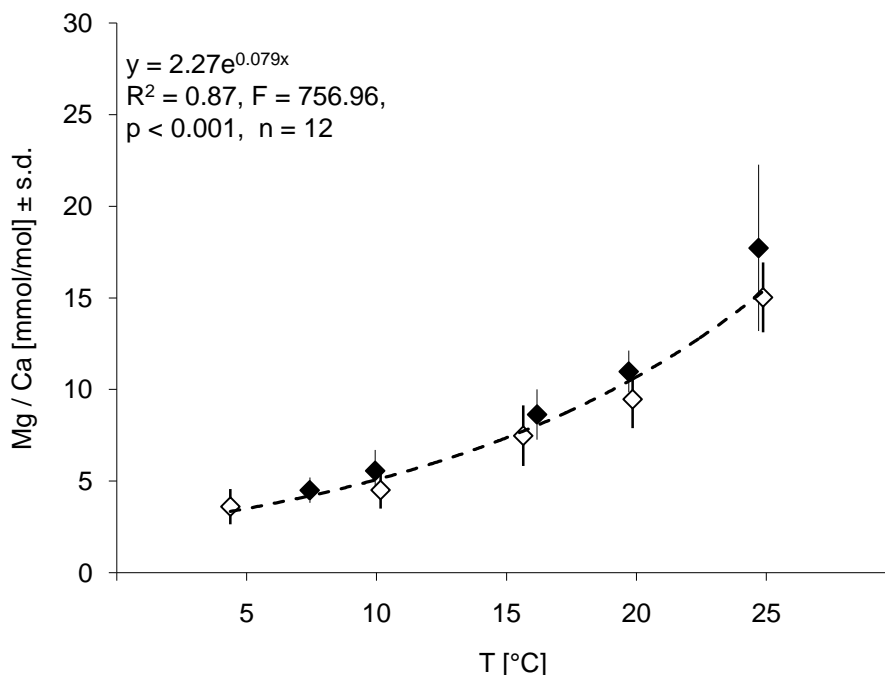


On a first glimpse, the Mg / Ca-temperature relationship we found in *M. edulis* calcite (**eq. 4.1, fig. 4.1A**) has a high slope (0.764 mmol / mol per °C) and a very low intercept (-2.15 mmol / mol) compared to results from chapter 2 and other studies with *M. edulis* or other calcitic bivalve species (see chapter 2: tab. 2.4, slopes: 0.24 to 0.75 mmol / mol per °C, intercepts: - 0.63 to 5.44 mmol / mol). **Figure 4.3** shows, however, that this was mainly due to the lack of a 4 °C treatment in this study and that Mg / Ca ratios between 10 and 25 °C of this study and in chapter 2 match very well. Finally, an exponential model gives a very good fit to the combined data of both experiments (**fig. 4.3**):

$$\text{Mg / Ca (*10}^{-3}\text{)} = 2.27(\pm 0.38) e^{0.079(\pm 0.008)T}, \quad (4.3)$$

$R^2 = 0.87, F = 756.96, p < 0.001, \text{ errors: } 95\% \text{ CI, } n = 120.$

The exponential increase of *M. edulis* shell Mg / Ca of 7.9 % per °C is statistically equal to findings of Kisakürek *et al.* (2008: 8 % exponential increase) from foraminiferean calcite. This assumes that the same mechanism controls the temperature dependent Mg incorporation into calcitic shells of bivalves and foraminifera, however with different overall Mg / Ca magnitudes at similar temperatures (Kisakürek *et al.* 2008: Mg / Ca of 2.5 to 6.4 mmol / mol at temperatures 18 to 30 °C). Still, in the calcitic bivalve *Pinna nobilis*, a lower exponential increase of Mg / Ca (2 % per °C) was found while the overall Mg / Ca was much higher than in foraminifera and in *M. edulis* (Freitas *et al.* 2005, chapter 2, tab.2: intercept of 17.2). Therefore, the slope of the exponential temperature relationship in biogenic calcite might be inversely related to the overall amount of incorporated Mg in the respective taxa.



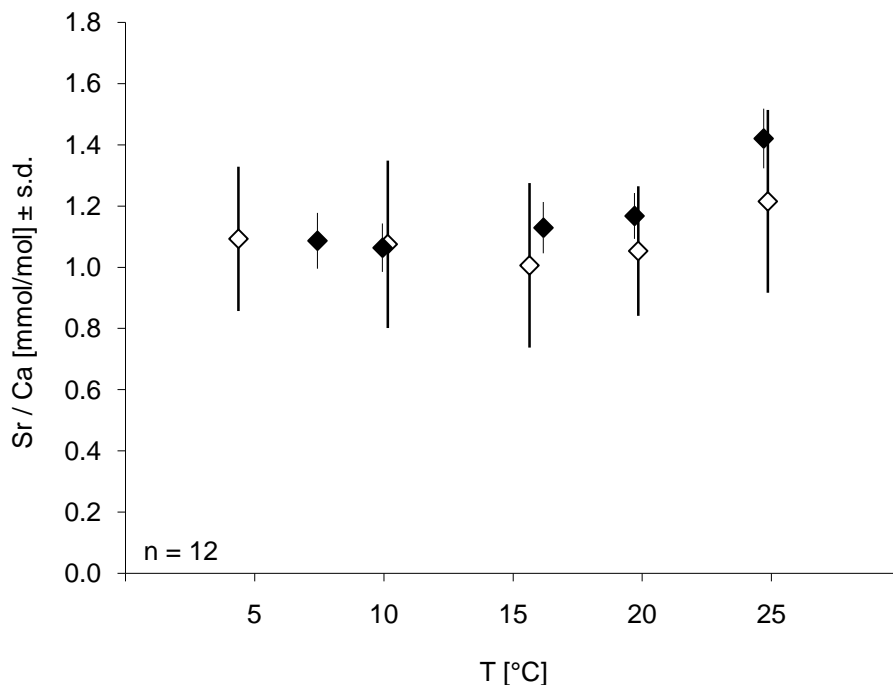
**Figure 4.3.** Mg / Ca ratios in *M. edulis* calcite: Open diamonds (◇) represent data from chapter 1 (all salinity treatments (15, 25 and 35) pooled) and closed diamonds (◆) from this study (all pCO<sub>2</sub> treatments (453, 897 and 1376 µatm) pooled). Error bars indicate standard deviations (s.d.) of measured individuals (n).

The observation that at temperatures around 25 °C (in Kisakürek *et al.* (2008) at 27 °C) in both, the bivalve *M. edulis* and the foraminifera *Globigerinoides ruber* (white), Mg / Ca is increased by acidification of the treatment water, adds additional confidence in an equal mechanism of Mg incorporation into foraminifera and bivalve calcite.

*A. islandica*. The maximum mean Mg / Ca value (4.19 mmol / mol, **tab. 4.2**) found in *A. islandica* shells in this study was even higher than in chapter 2 (3.47 mmol / mol). Notwithstanding our results in chapter 2 but in line with other studies of *A. islandica* shells grown in natural environments (Toland *et al.* 2000; Epplé 2004; Foster *et al.* 2008), this time we found no significant relationship between Mg / Ca and temperature (**fig. 4.2A**). This shows that the Mg / Ca-temperature relationship is much less robust in *A. islandica* aragonite shells than in *M. edulis* calcite shells. If, as proposed in chapter 2, the same biological mechanism is involved in Mg incorporation into *A. islandica* aragonitic and *M. edulis* calcitic shells, a possible explanation arises from the fact that in inorganic aragonite the temperature relationship of Mg / Ca was observed to have the opposite (inverse) direction (Gaetani and Cohen 2006) than the suggested biological relationship (positive).

## Strontium

The positive linear correlation between Sr / Ca and Mg / Ca can be explained by the incorporation of the Mg ion into the calcite crystal structure that causes deformations that facilitate the incorporation of the larger Sr ion (Mucci and Morse 1984; Carpenter and Lohmann 1992). Here, as in chapter 2, we can confirm this correlation for *M. edulis* calcite and *A. islandica* aragonite (*M. edulis*:  $r = 0.88$ , *A. islandica*:  $r = 0.39$ ). In *M. edulis* both, Sr / Ca and Mg / Ca, were controlled by temperature whereas in *A. islandica* only Sr / Ca was controlled by temperature. Therefore, the control of Sr / Ca and Mg / Ca ratios by other factors (e.g. temperature, pCO<sub>2</sub> and salinity) appears to determine the strength of the Sr / Ca-Mg / Ca correlation.



**Figure 4.4.** Sr / Ca ratios in *M. edulis* calcite: Open diamonds (◇) represent data from chapter 1 (all salinity treatments (15, 25 and 35) pooled) and filled diamonds (◆) from this study (all pCO<sub>2</sub> treatments (453, 897 and 1376  $\mu$ atm) pooled). Error bars indicate standard deviations (s.d.) of measured individuals (n).

*M. edulis*.  $D_{Sr}$  respectively Sr / Ca in inorganically precipitated calcite is weakly inversely related to temperature (Gaetani and Cohen 2006; Tang *et al.* 2008). Sr / Ca-temperature relationships in calcitic bivalves, however, were inconsistent with a tendency towards a positive correlation (see discussion in chapter 2 with regard to Dodd 1965, Lerman 1965, Vander Putten *et al.* 2000, Freitas *et al.* 2005, Freitas *et al.* 2008 and Wanamaker *et al.* 2008). Here, we found a slightly stronger positive Sr / Ca-temperature relationship in *M. edulis* than in the study reported in chapter 2, but again only at higher temperature levels (16 - 25 °C, **fig. 4.4**).

Inorganic linear effects of temperature (negative correlation) would favour decreasing Sr / Ca ratios with higher temperatures. Due to the results found in this study as well as in chapter 2, we propose that this effect is reversed, as exponentially increasing Mg / Ca ratios (**fig. 4.3, eq. 4.3**) increasingly catalyse Sr incorporation.

The pattern of increasing Sr / Ca with temperatures higher than 16 °C in *M. edulis* calcite is, again, in line with findings from *G. ruber* (Kisakürek *et al.* 2008: 21 to 30 °C). Additionally, the independence of Sr / Ca of the treatment water pCO<sub>2</sub> appears to be equal in both taxa. Therefore, altogether, strong confidence was found that a similar or even the same biological mechanism controls calcite precipitation in bivalves and foraminifera.

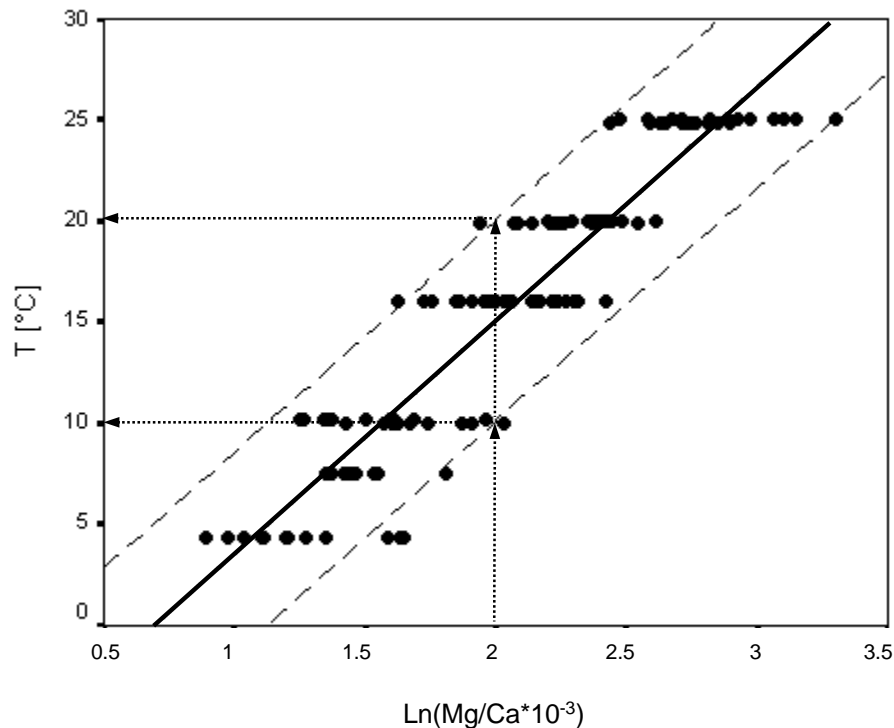
*A. islandica*. In *M. edulis* and *Mya arenaria* aragonite Sr / Ca was found to decrease with increasing temperature (Dodd 1965; Palacios *et al.* 1994). This would be in line with findings from inorganic aragonite precipitation experiments (Kinsman and Holland 1969; Dietzel *et al.* 2004; Gaetani and Cohen 2006). However, we found increasing Sr / Ca in *A. islandica* aragonite from 7.5 to 16 °C (**fig. 4.2B, eq. 4.2**), corroborating the results from the low salinity treatment in chapter 2. Again, this supports the assumption of a strong biological impact.

## Conclusion and implications for proxy-use

As we were able to reproduce in this study the Mg / Ca temperature relationship in *M. edulis* calcite found in chapter 2, this appears to be a robust proxy for paleo-temperatures. However, variation between bivalve individuals as well as changes in water acidification state (this study) and salinity (chapter 2) sum up to a significant amount of variance that has to be taken into account. Merging the Mg/Ca data of both studies into an exponential relationship, however, substantially reduced the uncertainty range of temperature within the here applied temperature margins from about 15 to 10 °C (eq. 4.4, fig. 4.5, chapter 2: fig. 2.8).

$$T [^{\circ}\text{C}] = 11.51(\pm 0.83) * \text{Ln}(\text{Mg}/\text{Ca} * 10^{-3}) - 8.06 (\pm 1.74) \quad (4)$$

$$R^2 = 0.87, F = 753.98, p < 0.001, \text{ errors: } 95\% \text{ CI. CI, } n = 120.$$



**Figure 4.5.** Temperature in dependence of  $\text{Ln}(\text{Mg}/\text{Ca} * 10^{-3})$  in shells of *M. edulis*. Bold line: significant linear regression for all salinity conditions (15, 25 and 35) with  $R^2 = 0.87$ ,  $p < 0.001$ . Model ( $\pm 95\%$  CI):  $T [^{\circ}\text{C}] = 11.51(\pm 0.83) * \text{Ln}(\text{Mg}/\text{Ca} * 10^{-3}) - 8.06 (\pm 1.74)$ ,  $n = 120$ . Dashed lines represent 95% confidence margins. Dotted errors: A  $\text{Ln}(\text{Mg}/\text{Ca} * 10^{-3})$  of 2 corresponds to a temperature between 10 and 20 °C.

The exponential shape of the Mg / Ca-temperature dependency can be explained by a biological control that overlaps the inorganic Mg incorporation. We found a model that is remarkably similar to a relationship that was observed in foraminifera *G. ruber* (Kisakürek *et al.* 2008). Additionally, the Mg / Ca-pH and the Sr / Ca-temperature and Sr / Ca-pH patterns were very similar to those in tests of *G. ruber*. This strongly suggests a general pattern for biogenic calcite precipitation.

Increasing Sr / Ca at temperatures higher than 16 °C is probably a secondary effect of the exponential increase of Mg / Ca that facilitates Sr incorporation into calcite. Anyway, the effect appears to be too weak and too heavily blurred by other factors (especially salinity; chapter 2) to be used as a proxy for sea surface temperatures (SST).

In *A. islandica* aragonite, only Sr / Ca slightly linearly increased with temperature. Although Sr / Ca was not influenced by water pCO<sub>2</sub>, the shallow slope in combination with a strong sensitivity towards salinity (chapter 2) strongly limit its potential for SST reconstructions.



## Chapter 5

### Defence Capability of Western Baltic Sea Bivalves *Mytilus edulis* (L.) and *Arctica islandica* (L.) at two Global Change Scenarios

#### Abstract

Shell stability and adductor muscle strength are important determinants of bivalves' susceptibility to predation by crabs and sea stars. Predicted ocean acidification, temperature increase and reduced salinity may alter bivalve shell stability.

Temperature can influence shell stabilities of *M. edulis* and *A. islandica*, however, with opposite directions. Shell stability of *M. edulis* increased with temperature whereas *A. islandica* shell stability decreased. Low salinity reduced shell stability only of *M. edulis* and only at low to moderate temperatures (4 - 16 °C). With respect to their defence capability against shell-braking predators, both species were insensitive towards the applied acidification.

As ocean acidification and higher temperatures possibly decrease the amount of muscle tissue produced, we tested whether these factors may reduce the defence capability of *M. edulis* towards predation by *A. rubens*. Temperature and hypercapnia, however, did not modify the ability of *M. edulis* to defend itself against predation by *A. rubens*.

In the Baltic Sea the positive effect of higher temperatures on shell stability is expected to be stronger than the negative effect of lower salinities. Thus, the prolonged persistence of *M. edulis* in the window of vulnerability towards predation by shell-cracking predators, caused by reduced shell growth, can at least partially be compensated. In addition to reduced shell growth, reduced shell stability at higher temperatures will decrease the defence capability of *A. islandica* – independently of the salinity regime.



## 5.1 Introduction

The susceptibility of bivalves to predators like birds, crabs and sea stars is determined by - besides other characteristics such as prey shape and shell thickness - adductor muscle strength and shell stability (Elner 1978; Kautsky *et al.* 1990; Nagarajan *et al.* 2006). On the one hand, changes in muscle strength are likely to affect the vulnerability towards predators, such as the common sea star *Asterias rubens* (L.), that use a pulling mode of shell opening. Changes in shell stability, on the other hand, affect the consumption rate by predators that crack the shell, such as crabs and birds.

In Baltic mussels, shell stability was postulated to be affected by both salinity and temperature (Remane and Schlieper 1971; Kautsky *et al.* 1990). Indeed, in measurements of Kossak (2006), shell stability of *Mytilus edulis* (L.) increased at higher salinities with temperature and at higher temperatures with salinity. Additionally, in a lab experiment, the two crab species *Carcinus maenas* (L.) and *Rhithropanopeus harrisii tridentatus* (Buitendijk and Holtuis 1949) chose relatively larger mussels as prey when both, predator and prey, were exposed to reduced salinity (Kossak 2006). Witbaard and Klein (1994) measured shell stability of *Arctica islandica* (L.) and found larger shells (> 4 cm) to be significantly stronger than smaller ones (< 4 cm). To our knowledge, no other measurements on the stability of *A. islandica* shell have been published to date.

Surprisingly, no publication on the effect of acidified seawater on shell stability of bivalves (or any other organism) could be found, either.

Environmental stress may not only influence shell stability, but also the muscle development of marine organisms. Wood *et al.* (2008) found that ocean acidification may even increase the rate of calcification in brittle stars, but decreases the amount of muscle tissue produced. If this holds true for other organisms such as bivalves, too, this could have an influence on the predation by the starfish *A. rubens*.

In the present study, the interactive effects of changes in salinity and temperature respectively acidification and temperature on shell stability of young individuals of *M. edulis* and *A. islandica* from the Baltic Sea was assessed. Also, in a second step, a feeding assay was conducted to reveal the effects of acidification and temperature on the defence capability of *M. edulis* against predation by *A. rubens*.

Our aim was to investigate whether the predicted increase in water pCO<sub>2</sub> and temperature and the decrease in salinity (Caldeira and Wickett 2003; Sabine *et al.* 2004; Denman *et al.* 2007) may influence the susceptibility to predation of bivalves.

Both bivalve species investigated, *A. islandica* and *M. edulis*, live in the North Atlantic as well as in the Baltic Sea (Loosanoff 1953; Theede *et al.* 1969; Gosling 1992; Bers 2006).

*A. islandica* burrows in the sandy sea bottom, while *M. edulis* is attached to hard substrata (Seed and Suchanek 1992; Witbaard and Bergman 2003) or forms loose beds on sandy substrata. Both species play key roles in the ecosystem of the Baltic Sea as they can dominate shallow water (*M. edulis*, (Kautsky 1982; Wahl 2001)) respectively soft bottom communities below the halocline (15 m, *A. islandica*, (Brey 1990)) and are important prey e.g. for shore crabs, star fish and cod (Elner 1978; Brey 1990; Kautsky *et al.* 1990).

## 5.2 Materials and Methods

Young *M. edulis* specimens were collected in the Kiel Fjord. *A. islandica* specimens were dredged at the station “Süderfahrt” (54°32.6' N, 10°42.1' E) west of Fehmarn Island in Kiel Bight, Baltic Sea.

*Experimental design.* For both species, we conducted two 2-factorial fully crossed experiments each, one with factors temperature and salinity (ANOVA-model:  $X_{ijk} = \mu + T_i + SAL_j + T_iSAL_j + e_{k(ij)}$ ) and one with factors temperature and pCO<sub>2</sub> (ANOVA-model:  $X_{ijk} = \mu + T_i + pCO_{2j} + T_i pCO_{2j} + e_{k(ij)}$ ). In the first experiment, the temperature-salinity experiment, temperature levels were 4, 10, 16, 20 and 25 °C for *M. edulis* and 4, 10 and 16 °C for *A. islandica*. Salinity levels were 15, 25 and 35 for both species. In the second experiment, the temperature-pCO<sub>2</sub> experiment, applied temperatures were 7.5, 10, 16, 20 and 25 °C for *M. edulis* and 7.5, 10 and 16 °C for *A. islandica*. In both experiments the level of replication was 4.

*Culture.* In both experimental setups, individually marked bivalves were cultured at the Leibniz-Institute of Marine Sciences IFM-GEOMAR, Kiel, Germany, in temperature-insulated 4-l-containers. The animals were allowed to slowly adapt to the respective treatments: in experiment 1, starting from a salinity of 17, salinity was changed by max. 1 unit per day and, subsequently, starting from 15 °C, temperature was changed by max. 1 °C per day until treatment conditions were reached. In experiment 2, starting from natural pCO<sub>2</sub> of about 380 µatm, CO<sub>2</sub> regulation of the 840 µatm and 1400 µatm treatment was reached within 15 days. The temperature adaptation resembled that of experiment 1. Temperatures were kept stable for the experimental duration of 15 (exp.1) respectively 13 (exp. 2) weeks.

In experiment 1, in each container 10 individuals of *M. edulis* respectively 7 individuals of *A. islandica* were cultured. One eighth of the water volume per aquarium (1 / 2 l) was exchanged twice a week. Salinity levels were set by mixing fresh Baltic seawater with either ion exchanged water (to obtain SAL 15) or artificial marine salt (SEQUASAL GmbH, Münster, Germany; SAL 25 and SAL 35).

In experiment 2, in each container 10 individuals of *M. edulis* respectively of *A. islandica* were cultured. Water was constantly exchanged by a flow-through system, assuring an exchange of the treatment water within < 1 / 2 h. Air of different pCO<sub>2</sub> levels was provided by a central air-CO<sub>2</sub>-mixing device at the IFM-GEOMAR (Bleich *et al.* 2008). To assure sufficient water acclimatisation to desired temperature and pCO<sub>2</sub> levels, water of the 15 treatment combinations was pre-conditioned in 15 300-l-cylinders installed upstream to the culture containers. Resulting pCO<sub>2</sub> values in the treatment air were measured with a GDZ 401 CO<sub>2</sub> measuring device (HTK, Hamburg, Germany). Dissolved inorganic carbon (DIC) and total alkalinity (TA) were measured three times during the experimental period. TA values of the treatment water were determined by potentiometric open-cell titration with hydrochloric acid (Gran 1952; Dickson *et al.* 2007) on a VINDTA (Versatile INstrument for the Determination of Titration Alkalinity, MARIANDA, Kiel, Germany) autoanalyzer. DIC values were measured coulometrically after (Dickson *et al.* 2007) on a SOMMA (Single-Operator Multi-Metabolic Analyzer, University of Rhode Island, Kingston, RI) autoanalyzer. Treatment water pH<sub>NBS</sub> was regularly measured 3 times a week with a WTW pH meter (pH 330i, sensor: Sen Tix 81, WTW GmbH, Weilheim, Germany). With the gained information, pCO<sub>2</sub> and saturation state with respect to calcite ( $\Omega_{\text{Calcite}}$ ) and aragonite ( $\Omega_{\text{Aragonite}}$ ) of the treatment water could be calculated (Lewis and Wallace 1998), chapter 4, tab. 4.1).

For further information about culturing conditions please read detailed descriptions in chapters 1 and 3. Bivalves that died during the experimental phase were replaced by new specimens to keep the animal density constant. These newly introduced individuals were not considered for further analysis.

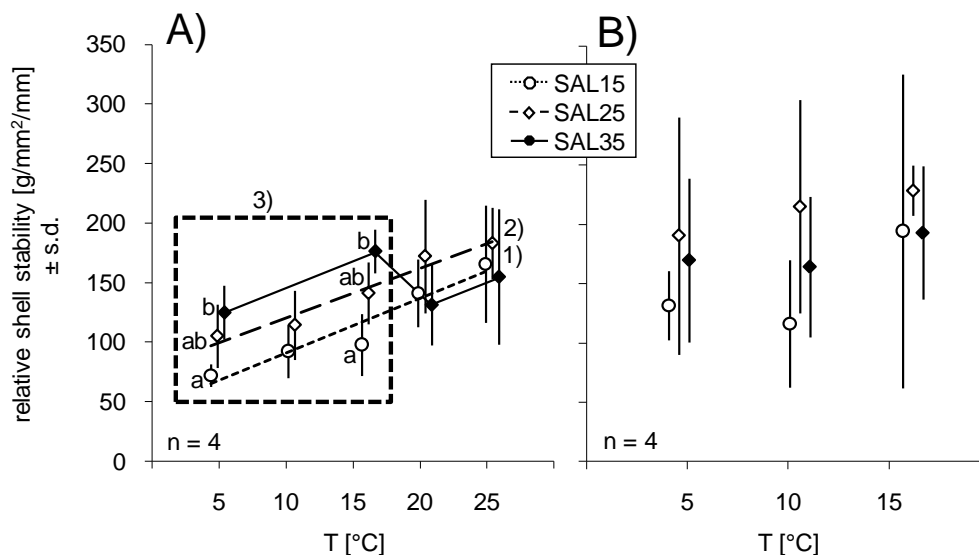
*Data collection.* After the end of each experimental period, individual shell height was measured to the nearest 0.02 mm using a calliper. Shell stability of one individual that showed average growth of each container was measured with a TA-XT2 texture analyzer (WINOPAL Forschungsbedarf GmbH, Ahnsbeck, Germany). In this measuring technique, the non-marked valve is laid on its opening side and, by a spike at the point of maximum valve convexity, gradually force is added until the valve brakes. Breaking force (shell stability) is expressed as g / mm<sup>2</sup>. Additionally, we divided the shell stability by the individual shell height to correct for mussel size (Kossak 2006): relative shell stability = breaking force [g / mm<sup>2</sup>] / mm.

Additionally, a feeding assay was conducted using *M. edulis* from 7.5, 16, and 20 °C and all three pCO<sub>2</sub> treatments of experiment 2 (380, 840 and 1400 µatm). The mussels were offered as prey to freshly caught individuals of the starfish *A. rubens* (3 - 4 cm arm length). The assay was run in 18 2-l-feeding containers. Water flow-through rates were 0.35 l / h, experimental temperature was ca. 10 °C and air pCO<sub>2</sub> was ca. 380 µatm. In each feeding container nine mussels of approximately equal size (17 - 23 mm) cultured at the same temperature were offered to one starfish, with three mussels of each of the three pCO<sub>2</sub> treatments. Level of replication was six. The mussels consumed by each starfish were counted after three days.

*Data analyses.* Not normally distributed shell stability data were Box-Cox transformed to meet the necessary assumptions for an ANOVA. Shell stability data were analysed for significant differences by 2-factorial ANOVA and, in case of clear trends, by linear regression. Differences between single treatment levels were identified by Tukey HSD post-hoc test. All these statistical tests were provided by Statistica 8.0 software package. In the feeding assay, however, choice of bivalves from different pCO<sub>2</sub> treatments by the same starfish was not independent. Therefore we used a Resampling test, provided by the PopTools software package, to determine significant temperature or pCO<sub>2</sub> effects.

## 5.3 Results

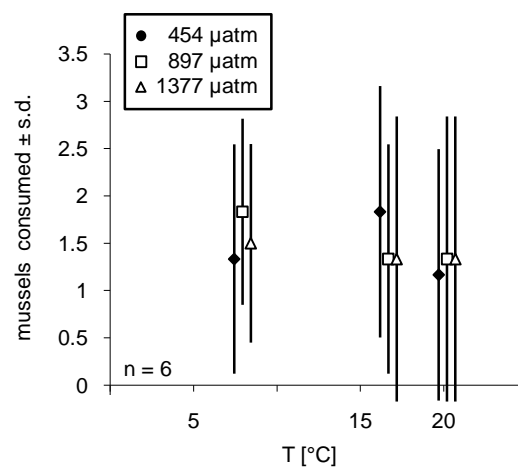
*Experiment 1: salinity vs. temperature.* Mean *M. edulis* shell stabilities of all temperatures and salinities were, though lower, in a similar range ( $132.6 \text{ g / mm}^2 / \text{mm} \pm 43.6 \text{ s.d.}$ ) as the ones measured by Kossak (2006:  $147.7 \text{ g / mm}^2 / \text{mm} \pm 48.0 \text{ s.d.}$ , t-test,  $t = -2.18$ ,  $p = 0.030$ ), showing the good comparability of the two different measuring devices. In this study the effects of temperature and salinity on shell stability of *M. edulis* (**fig. 5.1A**) significantly interacted with each other (2-fact. ANOVA,  $F = 2.76$ ,  $p = 0.030$ ). Shell stability linearly increased with temperature at salinity 15 and 25 (**fig. 5.1A: 1**) and 2)). Additionally, at temperatures 4 to 16 °C, shell stability increased with salinity from 15 to 35. This was not the case at higher temperatures (**fig. 5.1A: 3**). *A. islandica* shell stabilities (**fig. 5.1B**, on average  $178.2 \text{ g / mm}^2 / \text{mm} \pm 76.2 \text{ s.d.}$ ) in experiment 1 were significantly higher than those of *M. edulis* (t-test,  $t = -3.54$ ,  $p < 0.001$ ) but were neither influenced by temperature nor by salinity (2-fact. ANOVA, temperature:  $F = 1.22$ ,  $p = 0.311$ ; salinity:  $F = 2.25$ ,  $p = 0.125$ ).



**Figure 5.1.** Mean relative shell stability of *M. edulis* (A) and *A. islandica* (B) cultured under different temperatures and salinities. Different letters in A) indicate significantly different groups with respect to salinity. Error bars represent standard deviations of measured individuals (n).  
 1) Significant linear regression at salinity 15 with  $R^2 = 0.66$  and  $p < 0.001$ . Model:  $y = 4.6x + 46.5$ ,  $n = 20$ .  
 2) Significant linear regression at salinity 25 with  $R^2 = 0.45$  and  $p = 0.001$ . Model:  $y = 4.1x + 77.8$ ,  $n = 20$ .  
 3) Significant linear regression for temperatures 4 to 16 °C with  $R^2 = 0.42$  and  $p < 0.001$ . Model:  $y = 2.9x + 43.7$ ,  $n = 32$ .

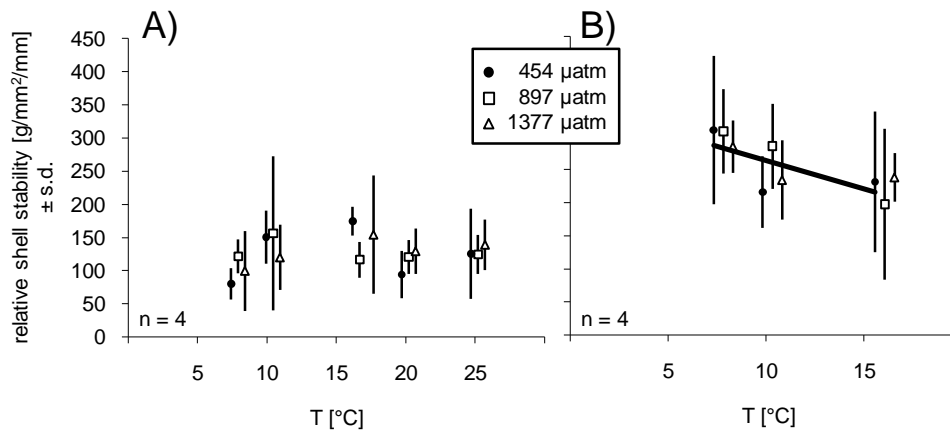
*Experiment 2: pCO<sub>2</sub> vs. temperature.* Average shell stabilities of *M. edulis* (127.1 g / mm<sup>2</sup> / mm ± 52.0 s.d.) were practically equal to the ones in experiment 1 (t-test, t = 0.60, p = 0.548) even though 2 / 3 of the bivalves were living under hypercapnic conditions. However, the pCO<sub>2</sub> treatment did not have any effect on the mussels' shell stability (2-fact. ANOVA, F = 0.03, p = 0.975). Additionally, in experiment 2 no temperature effect could be found (2-fact. ANOVA, F = 1.70, p = 0.167).

No temperature or acidification effect on prey preferences of *A. rubens* could be found in the feeding assay, either (**fig. 5.2**, Resampling, temperature: p >> 0.05, pCO<sub>2</sub>: p >> 0.05).



**Figure 5.2.** Mean number of *M. edulis* individuals consumed by *A. rubens*. Mussels were cultured under different temperatures and pCO<sub>2</sub> levels. Error bars represent standard deviations.

*A. islandica* mean shell stabilities (255.5 g / mm<sup>2</sup> / mm ± 78.7 s.d.) in experiment 2 were on average 77.3 g/mm<sup>2</sup>/mm higher than those in experiment 1 (t-test, t = -4.13, p < 0.001) and, like shell stabilities of *M. edulis*, not influenced by the pCO<sub>2</sub> treatment (**fig. 5.3B**, 2-fakt. ANOVA, F = 0.08, p = 0.919). However, in experiment 2, shell stabilities of *A. islandica* decreased linearly with higher temperatures (**fig. 5.3A**).



**Figure 5.3.** Mean relative shell stability of *M. edulis* (A) and *A. islandica* (B) cultured under different temperatures and pCO<sub>2</sub> levels. Error bars represent standard deviations of measured individuals (n). Bold line in B): significant linear regression for all pCO<sub>2</sub> levels (454, 897 and 1377 µatm) with R<sup>2</sup> = 0.15 and p = 0.021. Model:  $y = -9.56x + 359.13$ , n = 20.

#### 5.4 Discussion

In general, the positive influence of both, higher temperature and higher salinity, on shell stability of *M. edulis* corroborates previous findings of Kossak (2006) and other studies (Remane and Schlieper 1971; Kautsky *et al.* 1990). However, the interactions found here and in Kossak (2006) are contrary: We found increasing shell stability with increasing *salinity* only at low and Kossak (2006) at high *temperatures*, and we found increasing shell stability with increasing *temperature* only at low and Kossak (2006) at high *salinities*. These differences can partially be explained by the different experimental setups. While in our experiment, bivalves were cultured for 15 weeks at constant temperatures (up to 25 °C) and salinities, in Kossak (2006) the temperature treatments were weekly adapted to natural temperature changes in Kiel Bight and did not exceed 17 °C, even in the high temperature treatment. However, in experiment 2 shell stability was temperature-independent. Thus, the temperature effect appears to interact with factors that were not controlled in our two experiments.

From lipofuscin accumulation, growth rates and mortalities, we concluded that *M. edulis* is rather an estuarine than a high-saline species (chapter 1). In addition, the mussels' resistance towards a long-term application of high temperatures (>20 °C) was obviously lower at the high-salinity treatment (35) than at lower salinity (15 and 25), too.

Many starfish and crab predators prefer relatively small-sized mussels as prey, which are easier to open and not likely to damage the crabs' claws (Juanes 1992; Reusch and Chapman 1997; Leonard *et al.* 1999). It follows that faster growth will allow an earlier

escape from predation (Einer 1978; Boulding 1984; Palmer 1992; Enderlein and Wahl 2004). In experiment 1, temperature-induced cellular stress decreased *M. edulis*' growth rate but was positively correlated to shell stability ( $r = 0.53$ ,  $p = 0.001$ , chapter 1). It can be speculated that temperature-induced higher shell stability partially compensates for the increased susceptibility to predation due to slower growth. Following this argument, the fact that in the second experiment (chapter 3 and 4) shell stability did not increase with temperature, can be explained by a lower temperature-induced growth reduction of *M. edulis*.

The insensitivity of *M. edulis* shell stability towards the applied hypercapnia shows that the mussels are not only able to precipitate calcite and grow under acidified conditions (chapter 3). Also, the animals' shells are obviously not thinned by dissolution to an extent that significantly weakens their stability. Therefore, we assume that *M. edulis* is able to obtain conditions in the inner EPF (chapter 3) that do not favour aragonite dissolution even if pH values of the EPF as well as of haemolymph and external medium are comparably low ( $< 7.7$ ).

Kautsky (1990) showed that the starfish *A. rubens* prefers weaker mussels as prey. However, we found no effect of temperature on the consumption of *M. edulis* by *A. rubens*. It appears that higher temperatures (chapter 3) did not weaken the strength of the mussels' adductor muscles – at least not to an extent that would have been resolvable by the feeding assay conducted here. The additional absence of an acidification effect on the defence capability of *M. edulis* against *A. rubens* nevertheless adds more confidence to the assumption that *M. edulis* was not suffering under the  $p\text{CO}_2$  treatments applied here (chapter 3).

While *A. islandica* shell growth was strongly influenced by salinity (chapter 1), this bivalves' shell stability was not. In experiment 1, low temperature only slightly decreased shell growth at salinity 25 (chapter 1) and did not influence shell stability. In contrast, in experiment 2, high temperature strongly reduced shell growth between 10 and 16 °C. Additionally, in this experiment, shell stability decreased linearly with temperature from 7.5 to 16 °C. Therefore, temperature only reduced *A. islandica* shell stability when it strongly reduced shell growth at the same time (experiment 2, chapter 3).

The latter is in opposite to the patterns found in *M. edulis* where shell stability increased while shell growth decreased. Thus shell growth rate and stability of both bivalve species are probably not linked via the same mechanism.

As shell stability of *A. islandica*, like of *M. edulis*, was insensitive to hypercapnia, the bivalve appears to be able to obtain EPF conditions that rather favour aragonite precipitation than dissolution, even at a  $p\text{CO}_2$  of 1376  $\mu\text{atm}$ . This might be considered



surprising as the mean aragonite saturation state in all pCO<sub>2</sub> treatments was less than 1 (down to 0.5 at 7.5 °C, chapter 3) under these conditions. However, as at the bivalves' natural environment similar acidic conditions occur frequently (Weigelt 1986; Christmas and Jordan 1987; Hansen *et al.* 1999), they obviously developed the ability to cope with these situations without dissolving the shell to an extent that reduces its defence potential.

### Conclusion

Temperature can influence shell stabilities of *M. edulis* and *A. islandica*, however, with opposite directions. Low salinity reduced shell stability only of *M. edulis* and only at low to moderate temperatures (4 - 16 °C). With respect to their defence capability both species were insensitive towards the acidification applied. Finally, temperature and hypercapnia did not modify the ability of *M. edulis* to defend itself against predation by *A. rubens*. In contrast, Kossak (2006) showed that reduced shell stability at lower salinity can shift the preferred size classes of shell-cracking predators, such as the shore crab *C. maenes*, towards larger mussels. As at low to moderate temperatures (4 - 16 °C) lower salinity reduces *M. edulis* shell stability, predicted desalination in the estuarine Baltic Sea (Denman *et al.* 2007) can have detrimental effects on the *M. edulis* populations. Additionally, *M. edulis* growth rates drastically decrease if salinity becomes less than 25 and summer temperatures higher than 20 °C (chapter 1 and 3). Higher temperatures, however, can increase *M. edulis* shell stability. If salinity changes are not too strong, this can potentially compensate for the higher susceptibility towards predation due to reduced growth rates. Absolute changes of temperature and salinity in the respective region might determine whether *M. edulis* shell stability in- or decreases and thus whether reduced growth can partially be compensated or if shells do not only grow less but also become weaker. Assuming maximum predicted changes (Graham 2004; Meier 2006), salinity will be less reduced (~3) in the Eastern than in the Central and Western Baltic (~6) whereas temperature changes are expected to be rather similar (~4.5 °C in the Eastern and ~5.4 °C in the Central and Western Baltic).

Taking into account the shell stability-salinity and shell stability-temperature relationships we found in experiment 1 (**fig. 5.1A: 1 and 3**)), we can roughly compare the effects of temperature and the salinity in a Baltic Sea scenario: In the Eastern Baltic the reduced salinity would result in an average shell stability decrease of 12 g / mm<sup>2</sup> / mm whereas the higher temperature would cause an average shell stability increase of 22.5 g / mm<sup>2</sup> / mm. In the Central and Western Baltic, however, the average shell stability decrease due to reduced salinity would be 18 g / mm<sup>2</sup> / mm. The positive temperature effect would be 27 g / mm<sup>2</sup> / mm.

Therefore, in both scenarios the absolute change would be very similar (around 10 g / mm<sup>2</sup> / mm). This is due to the steeper slope of the temperature-shell stability relationship compared to the salinity-shell stability relationship. It follows that in the whole Baltic Sea, the positive temperature effect on *M. edulis* shell stability can be stronger than the negative salinity effect. The prolonged persistence of *M. edulis* in the window of vulnerability towards predation by shell-cracking predators, caused by reduced shell growth, could in this case be at least partially compensated by stronger shells. However, if, as in experiment 2, a positive temperature effect is missing, the susceptibility of *M. edulis* towards predation will most probably be increased by lower salinity. Therefore, more research is needed to elucidate factors that interact with temperature before reasonable predictions can be made.

In chapters 1 and 3 we showed that higher temperatures exceeding 10 °C can be detrimental to *A. islandica* growth rate. Even below the halocline, these temperatures are likely to be reached more often in the future. In addition, reduced shell stability of *A. islandica* at higher temperatures would decrease the defence capability of this species – independently of the salinity regime.



## Synthesis

Anthropogenic release of carbon dioxide (CO<sub>2</sub>) into the atmosphere largely modifies the marine environment in two ways: (i) as a major green house gas, CO<sub>2</sub> causes global warming that further induces changes in other climate parameters like precipitation and salinity (Denman 2007), (ii) the oceans become acidified as about one-third of the atmospheric CO<sub>2</sub> is absorbed by surface waters (Caldeira and Wickett 2003).

To predict consequences of these changes in global water climate on marine communities, two major questions need to be answered: (i) how drastic will these changes be? And (ii) how will key species react to the combined changes?

Bivalves' cellular stress, fitness, shell growth, defence capability and elemental and isotopic shell composition all can be influenced by water climate parameters such as temperature, salinity and pCO<sub>2</sub>.

Thus, concerning their respective habitats, *M. edulis* and *A. islandica* potentially can contribute to answering both of the questions above. Firstly, because bivalves like *M. edulis* and *A. islandica* can dominate marine benthic communities (e.g. Kautsky 1982, Zettler *et al.* 2001) and can therefore be considered as key species for these areas whose performance can be used as a parameter for assessments of the ecological state of their environment. Secondly, the improvement of climate models that predict future climate change requires a better understanding of climate history. As historical observations are rare, diagenetically stable archives are needed to reconstruct past climate scenarios. Recent studies show that several bivalve shell chemistry characteristics depend on seawater temperatures and can therefore theoretically be used as proxies for paleo-climata.

One of the goals of the present work was to investigate whether the predicted increases in temperature and water pCO<sub>2</sub> and the decrease in salinity may influence the performance or susceptibility to predation of Baltic Sea bivalves and could shift their limits of distribution. The second aim was to test two element ratios (Mg / Ca and Sr / Ca) as well as calcium isotope fractionation ( $\Delta^{44/40}\text{Ca}$ ) for their potential to reconstruct sea surface temperatures.

In an interdisciplinary attempt of ecology, physiology and bio-geochemistry, this thesis substantially contributes to the knowledge about bivalves' performance and chemical shell composition in an environment of changing salinity, pCO<sub>2</sub> and temperature.

The results of the experiments presented here show that cellular stress, measured as lipofuscin accumulation, of both species increases primarily with temperature. Temperature-induced oxidative cellular damage due to an increase in free radical production (Abele et al., 2002) leads to an increase in lipofuscin accumulation in *M. edulis* and *A. islandica* soft tissue and reduces the bivalves' fitness. The influence of this temperature-induced stress on growth is stronger in *M. edulis* than in *A. islandica*, the latter's growth being mainly controlled by salinity.

Additionally, in both species the condition index (soft tissue weight / shell weight) can decrease with higher temperatures due to strongly decreasing growth or increasing disintegration of the soft body. The lack of increased nutrition at higher temperatures in this study is probably the reason for this observed pattern as higher energy expenses due to increased metabolic rates could not be met. The condition of *A. islandica* decreased at lower temperatures (7.5 and 10 °C) and additionally slightly with higher pH

Results of lipofuscin accumulation, growth rate and mortality show that *M. edulis* is a species adapted to cold and rather estuarine environments. Also, their resistance towards high temperature stress is highest at intermediate salinities (SAL 25). In contrast, mortality and growth rate data indicate that *A. islandica* is a high saline species with optimum growth at around 10 °C.

Both species, *M. edulis* and *A. islandica*, are able to produce significant amounts of shell material even if the surrounding water is acidified and undersaturated with respect to aragonite and calcite. In fact, in this study, growth of both species decreased with temperatures while the saturation state increased. Altogether, the here presented results of shell growth, cellular stress, condition and mortality show that the investigated bivalves are, independently of the temperature, largely insensitive towards changes in seawater pCO<sub>2</sub> or saturations states that can be expected within the next 200 years. Comparably low metabolic rates that allow the bivalves to resign a pH-sensitive oxygen binding pigment in the haemolymph as well as biologically controlled calcification probably make *M. edulis* and *A. islandica* robust to acidification.

Water temperature can influence shell stabilities of *M. edulis* and *A. islandica*, however, with opposite directions. While, at salinities 15 to 25, shells of *M. edulis* can get more stable with higher temperatures, shells of *A. islandica* rather get less stable with higher temperatures – independently of the salinity. Low salinity reduces shell stability of *M. edulis* only and only at temperatures of less than 20 °C. With respect to shell stability, both species are insensitive towards the here applied acidification. Finally, temperature and hypercapnia do not modify the adductor muscle strength of *M. edulis* and thus its defence capability against predation by the starfish *Asterias rubens*.

In both bivalves, *M. edulis* and *A. islandica*, magnesium incorporation into the shell is controlled by temperature. The Mg-temperature relationship, however, is stronger and more consistent in *M. edulis* than in *A. islandica* shells. When pooling the Mg / Ca data of the two conducted experiments, a relationship with an exponential increase (7.9 %) that is statistically equal to one found in foraminifera (8 %) was found. Yet, also salinity and pCO<sub>2</sub> influence Mg / Ca in *M. edulis*.

Furthermore, in both species the incorporation of strontium into the shell was controlled by salinity and temperature but not by the acidification treatment. In *M. edulis* these effects were consistent: the distribution coefficient of Sr ( $D_{Sr}$ ) increased at temperatures higher than about 15 °C and decreased with decreasing seawater Sr / Ca ratio. Whereas in *A. islandica*  $D_{Sr}$  only at a salinity of 15 increased with temperature and decreased only with salinity at applied temperatures higher than 4 °C.

Calcium isotope fractionation ( $\Delta^{44/40}Ca$ ) appears to be different in *M. edulis* and *A. islandica*: In *M. edulis* shells no clear  $\Delta^{44/40}Ca$ -temperature or  $\Delta^{44/40}Ca$ -salinity relationship was found but in *A. islandica* shell material  $\Delta^{44/40}Ca$  decreased with a shallow slope (0.011 ‰ per °C), with higher temperatures, independently of salinity..

## Conclusion

Lipofuscin accumulation, growth rates and mortalities indicate that *M. edulis* is rather an estuarine than a fully marine species. Independent of the respective salinity, condition and growth of this species are mainly controlled by temperature. In future, *M. edulis* will suffer from increased temperatures, especially if they exceed 20 °C. The resistance towards the temperature-induced stress will be highest at intermediate salinities (25), e.g. of the Baltic Kattegat region.

Further, at high temperatures, low salinities reduce *M. edulis* shell growth and at temperatures of less than 20 °C also shell stability. However, if, like predicted for the Baltic Sea, reduced salinities will coincide with higher temperatures, the positive temperature effect on shell stability can be stronger than the negative salinity effect. In the high saline North Sea, conversely, no positive effect of temperature on shell stability can be expected.

*A. islandica* is a species adapted to high salinity and low temperatures. This could be shown by mortalities and growth rates (salinity) on the one hand and by lipofuscin accumulation, condition index and shell stability (temperature) on the other hand. Therefore, Baltic Sea *A. islandica* will suffer from future desalination as well as from higher temperatures.

Both bivalve species investigated in this work are largely insensitive to acidifications up to a water  $p\text{CO}_2$  of about 1400  $\mu\text{atm}$ . Thus, if competing species or important predators are less robust to ocean acidification, the competitiveness of *A. islandica* and *M. edulis* might even increase in comparably cold and at least intermediate saline regions.

Little is known, however, about the influence of ocean acidification on food webs. In this study, starfish *A. rubens* did not change its feeding behaviour on *M. edulis* that were cultured under acidic conditions. In addition, very recent experiments show that *A. rubens* cultured under acidified conditions fed significantly less on mussels of all sizes, but did not prefer mussels of a different size class compared to starfish raised under control conditions (Appelhans pers. com.). Also, suspension feeders like bivalves could profit from higher phytoplankton availability due to  $\text{CO}_2$  fertilisation. On the other hand, if early life stages of bivalves are more sensitive towards acidification, the competitiveness might even be reduced more strongly than it can be expected from higher temperatures and lower salinities.

It has to be stated, though, that a large number of coastal areas are upwelling areas, estuaries, intertidal rocky shores with rock pools, salt marshes or sites influenced by volcanic activity (Morris and Taylor 1983; Frankignoulle *et al.* 1996; Cochran and Burnett 1996; Feely *et al.* 2004; Martin *et al.* 2008; Hall-Spencer *et al.* 2008). In all of these areas acidic conditions of different extent occur regularly. Species living in these regions must have developed a certain resistance towards hypercapnia (Burnett 1997) and potentially are as insensitive to expected ocean acidification as the two bivalves subject to this study.

Only the  $D_{\text{Sr}}$  proxy for seawater Sr / Ca ratios (*M. edulis*) respectively salinity (*A. islandica*) appears to be applicable in both species. The Ca isotope ( $\Delta^{44/40}\text{Ca}$ ) proxy in *A. islandica* has a shallow slope but is independent of salinity and shell growth rate.  $\Delta^{44/40}\text{Ca}$  in *M. edulis* shells, with regard to the results presented in this work, cannot be used as a sea surface temperature proxy. *M. edulis* shells, however, appear to provide another very robust proxy: Mg / Ca in *M. edulis* calcite increases exponentially with temperature. As this Mg / Ca temperature relationship was reproduced in the second experimental setup as well as in a different study in foraminifera, it can be considered very reliable even though Mg / Ca is also influenced by salinity and water  $p\text{CO}_2$ .

Strong biological control must have caused the  $\Delta^{44/40}\text{Ca}$  and  $D_{\text{Sr}}$  patterns we found that cannot be explained by inorganic models. Also, the exponential shape of the Mg / Ca temperature relationship can be best explained by a biological control that overlaps the linear increasing inorganic Mg incorporation into the shell. Increasing Sr / Ca at temperatures higher than 15 °C, however, is probably a secondary effect of the exponential increase of Mg / Ca that eases Sr incorporation into calcite.

In summary, it became obvious that most of the shell chemistry characteristics investigated in this study can only be explained by a tightly biologically controlled shell formation that does allow the bivalves to precipitate calcium carbonate under hypercapnic conditions. Increasing temperature and decreasing salinity, however, will most likely shift distributions of *M. edulis* and *A. islandica* in the Baltic Sea towards the higher-saline and cooler North-Western areas. Little is known about the biologically controlled calcium carbonate precipitation, but with respect to Mg / Ca ratios in *M. edulis* and Ca isotope fractionation in *A. islandica*, the bivalve shells appear to provide useful proxies for the reconstruction of past sea surface temperatures.

### Outlook

During this work it became obvious that very little is known about the cellular and molecular mechanisms that control bivalve calcification. The identification of a  $\text{Ca}^{2+} / \text{H}^+$  pumping system in the bivalve mantle epithel would be of great help in this context. Comparably easy measurements of Mg contents in the soluble and insoluble organic matrix could proof indirect observations by XANES and be useful to explain the Mg incorporation into the shell. Also, the proof of the existence of an inner and an outer extrapallial space together with an organic and inorganic discrimination of the fluids would add confidence to recent models of bivalve shell formation. Finally, comparisons of bivalve populations from different acidic environments (or different stable environments with respect to water  $\text{pCO}_2$ ) would give information if the (in-) sensitivity towards hypercapnia is an adaptation of local populations or a species-inherent attribute.





## Danksagung

Die vorliegende Arbeit wurde im Rahmen des European Scientific Foundation (ESF)-Projekts CASIOPEIA durchgeführt und durch die Deutsche Forschungsgemeinschaft DFG, Projektnummer: Ei272/20-1/-2, finanziert.

Viele Menschen haben mich mit Ratschlag und Einsatz sowie mit ihrer konstruktiven Kritik unterstützt und damit zum Gelingen dieser Arbeit beigetragen.

Besonderer Dank gilt den Professoren Martin Wahl und Anton Eisenhauer als tolle Betreuer, Unterstützer und Diskussionspartner.

Ich danke Penpag Reuter für ihre wesentlichen Versuchsplanungen und Vorbereitungen, die sie leistete, bevor sie erkannte, dass sie dieses Projekt mit neugeborenen Zwillingen nicht würde durchführen können.

Mein größter Dank gilt folgenden drei Personen, die erheblich zur Komplettierung dieser Arbeit beigetragen haben:

Mandy Kierspel hat mich während der letzten drei Jahre mit großem Einsatz in für sie teilweise schwierigen Zeiten unterstützt. Sie hat unermüdlich Muscheln markiert und aufbereitet, Muschelschalen präpariert, Schalenproben eingewogen, gelöst und für die Massenspektrometrie vorbereitet. Außerdem hat sie die Lipofuszinmessungen des zweiten Versuchs durchgeführt. Ohne Mandys Hilfe wäre diese Arbeit so nicht möglich gewesen

Florian Böhm hat mich mit großartiger Geduld an seinem enormem Wissen teilhaben lassen und mich so tiefer in die marine Biogeochemie eingeführt.

Eva Phillip half bei der Muschelaufbereitung und brachte mir sehr viel rund um Lipofuszinakkumulierung und deren Messung sowie über Muschelphysiologie bei

Ich danke weiter sehr:

- Agnes Heinemann für Vorbereitung und Durchführung von Karbonatchemiemessungen (DIC und TA), gelegentliches Füttern und große Nervenhilfe
- Ana Kolevica und Folkmar Hauff für die Einführung in und Hilfe bei Kalziumisotopenmessungen an der TIMS
- Basak Kisakürek for great help in the middle of the night in difficult situations with the TIMS and for chocolate in a serious chocolate crisis
- Dieter Garbe-Schönberg und Karin Kissling für die Einführung in und Durchführung von Messungen der Elementverhältnisse mit ICP-OES
- Frank Melzner für sehr viele Tips zur Physiologie der Ozeanversauerung
- Frank Wendler für immer wieder große Hilfe rund um die Klimakammern
- Helgi Mempel für CO<sub>2</sub>-Messwerte in der Behandlungsluft, sowie für Handschuhe und ein Fluorometerhandbuch
- Jan Fietzke für intellektuellen Input zur Schalenchemie der Muscheln

## Danksagung

- João Canning-Clode for various English verbalisations that clearly helped to improve the manuscripts
- Mark Lenz für große Unterstützung in Fragen der Statistik
- Renate Schütt für das zügige Messen des Condition Index der Muscheln im zweiten Versuch
- Silvia Hardenberg für die Messungen von Lipofuszin im ersten Experiment und Doris Abele für Laborkapazitäten
- Susann Grobe für die Messung von Karbonatchemieparametern (DIC und TA)
- Ute Kossak für Hilfe bei der Muschelhaltung und für das Überlassen ihrer Schalenstabilitätsdaten als Vergleichsbasis; sowie
- Yasmin Appelhans für die Durchführung des Fütterungsversuchs und Erklärung des Texture Analysers

Außerdem danke ich Alexa Caduff, Christian Pansch, Gitta Spindler, Nina Blöcher, Sven Rohde und Valeria Bers für großartige Hilfe beim Versuchsauf- und abbau, Wasserwechsel, beim Markieren, Haltern und Füttern der Muscheln sowie bei der Muschelaufbereitung.

Ich möchte auch Annika Regulin, Henrike Hammann, Mareike Hamman und Matthias Bunzel für hervorragendes wochenlanges zuverlässiges Füttern, Wasserwechseln, Becken säubern, pH und Salinität Messen danken.

Abschließend möchte ich meinen Eltern und Schwiegereltern herzlich für ihre große moralische Unterstützung und praktische Entlastung, z.B. als Babysitter, danken –

und Inga für gigantische Hilfe in den letzten Tagen und Wochen, für unsere Partnerschaft und dafür, dass sie da war und ist.

## References

- Aarab, N., D. M. Pampanin, A. Naevdal, K. B. Oysaed, L. Gastaldi and R. K. Bechmann** (2008). "Histopathology alterations and histochemistry measurements in mussel, *Mytilus edulis* collected offshore from an aluminium smelter industry (Norway)." *Marine Pollution Bulletin* 57(6-12): 569-574.
- Abele, D., B. Burlando, A. Viarengo and H. O. Pörtner** (1998). "Exposure to elevated temperatures and hydrogen peroxide elicits oxidative stress and antioxidant response in the Antarctic intertidal limpet *Nacella concinna*." *Comparative Biochemistry and Physiology B-Biochemistry & Molecular Biology* 120(2): 425-435.
- Abele, D., K. Heise, H. O. Pörtner and S. Puntarulo** (2002). "Temperature dependence of mitochondrial function and production of reactive oxygen species in the intertidal mud clam *Mya arenaria*." *Journal of Experimental Biology* 205(13): 1831-1841.
- Abele, D. and S. Puntarulo** (2004). "Formation of reactive species and induction of antioxidant defence systems in polar and temperate marine invertebrates and fish." *Comparative Biochemistry and Physiology a-Molecular & Integrative Physiology* 138(4): 405-415.
- Abele, D., J. Strahl, T. Brey and E. E. R. Philipp** (2008). "Imperceptible senescence: Ageing in the ocean quahog *Arctica islandica*." *Free Radical Research* 42(5): 474-480.
- Addadi, L., J. Moradian, E. Shay, N. G. Maroudas and S. Weiner** (1987). "A Chemical-Model for the Cooperation of Sulfates and Carboxylates in Calcite Crystal Nucleation - Relevance to Biomineralization." *Proceedings of the National Academy of Sciences of the United States of America* 84(9): 2732-2736.
- Almada-Villela, P. C.** (1984). "The Effects of Reduced Salinity on the Shell Growth of Small *Mytilus edulis*." *Journal of the Marine Biological Association of the United Kingdom* 64(1): 171-182.
- Almada-Villela, P. C., J. Davenport and L. D. Gruffydd** (1982). "The Effects of Temperature on the Shell Growth of Young *Mytilus edulis* L." *Journal of Experimental Marine Biology and Ecology* 59(2-3): 275-288.
- Amini, M.** (2007). The role of high- and low-temperature ocean crust alteration for the marine calcium budget. Kiel, Germany, Christian-Albrechts-University.
- Atkinson, M. J. and P. Cuët** (2008). "Possible effects of ocean acidification on coral reef biogeochemistry: topics for research." *Marine Ecology-Progress Series* 373: 249-256.
- Au, D. W. T. and R. S. S. Wu** (2001). "A field study on EROD activity and quantitative hepatocytological changes in an immature demersal fish." *Environmental Pollution* 115(1): 23-32.
- Au, D. W. T., R. S. S. Wu, B. S. Zhou and P. K. S. Lam** (1999). "Relationship between ultrastructural changes and EROD activities in liver of fish exposed to Benzo[a]pyrene." *Environmental Pollution* 104(2): 235-247.

## References

- Babarro, J. M. F. and A. de Zwaan** (2002). "Influence of abiotic factors on bacterial proliferation and anoxic survival of the sea mussel *Mytilus edulis* L." *Journal of Experimental Marine Biology and Ecology* 273(1): 33-49.
- Bamber, R. N.** (1990). "The Effects of Acidic Seawater on 3 Species of Lamellibranch Mollusk." *Journal of Experimental Marine Biology and Ecology* 143(3): 181-191.
- Bayne, B. L. and C. M. Worrall** (1980). "Growth and Production of Mussels *Mytilus edulis* from 2 Populations." *Marine Ecology-Progress Series* 3(4): 317-328.
- Beadman, H., R. Caldow, M. Kaiser and R. Willows** (2003). "How to toughen up your mussels: using mussel shell morphological plasticity to reduce predation losses." *Marine Biology* 142: 487-494.
- Berge, J., G. Johnsen, F. Nilsen, B. Gulliksen, D. Slagstad and D. M. Pampanin** (2006). "The *Mytilus edulis* population in Svalbard: how and why." *Marine Ecology-Progress Series* 309: 305-306.
- Berge, J. A., B. Bjerkeng, O. Pettersen, M. T. Schaanning and S. Oxnevad** (2006). "Effects of increased sea water concentrations of CO<sub>2</sub> on growth of the bivalve *Mytilus edulis* L." *Chemosphere* 62(4): 681-687.
- Bers, A. V.** (2006). Antifouling Protection at Different Scales - Multiple defence in *Mytilus edulis* and the global performance of mytilid microtopographies Kiel, Kiel: 80.
- Bleich, M., F. Melzner, C. Hiebenthal, H. Mempel, K. Schulz, U. Riebesell, M. Wahl, F. Sommer, U. Sommer, A. Form, U. Piatkowski, R. Hanel, D. Piepenburg, M. Spindler, A. Eisenhauer, A. Franke, V. Möller, G. Baumert and C. Clemmesen-Bockelmann** (2008). Poster: Kiel CO<sub>2</sub> manipulation experimental facility (KICO<sub>2</sub>). Second Symposium on The Ocean in a High-CO<sub>2</sub> World. Monaco.
- Bluhm, B. A., T. Brey and M. Klages** (2001). "The autofluorescent age pigment lipofuscin: key to age, growth and productivity of the Antarctic amphipod *Waldeckia obesa* (Chevreux, 1905)." *Journal of Experimental Marine Biology and Ecology* 258(2): 215-235.
- Bocchetti, R. and F. Regoli** (2006). "Seasonal variability of oxidative biomarkers, lysosomal parameters, metallothioneins and peroxisomal enzymes in the Mediterranean mussel *Mytilus galloprovincialis* from Adriatic Sea." *Chemosphere* 65(6): 913-921.
- Bøggild, O. B.** (1930). "The shell structure of the mollusks." *Det Kongelige Danske Videnskabernes Selskabs Skrifter, Naturvidenskabelige og Matematiske Afdeling* 9.R kke(II.2): 231-325, pl. I-XV.
- Böhm, F., N. Gussone, A. Eisenhauer, W. C. Dullo, S. Reynaud and A. Paytan** (2006). "Calcium isotope fractionation in modern scleractinian corals." *Geochimica Et Cosmochimica Acta* 70(17): 4452-4462.
- Booth, C. E., D. G. McDonald and P. J. Walsh** (1984). "Acid-Base-Balance in the Sea Mussel, *Mytilus edulis* 1. Effects of Hypoxia and Air-Exposure on Hemolymph Acid-Base Status." *Marine Biology Letters* 5(6): 347-358.

- Boulding, E.** (1984). "Crab-resistant features of shell-burrowing bivalves: decreasing vulnerability by increasing handling time." *Journal of Experimental Marine Biology and Ecology* 76: 201-223.
- Brey, T., Arntz, W. E., Pauly, D., Rumohr, H.** (1990). "*Arctica (Cyprina) islandica* in Kiel Bay (Western Baltic): growth, production and ecological significance." *J Exp. Mar. Biol. Ecol.* 136: 217-235.
- Brunk, U. T. and A. Terman** (2002). "Lipofuscin: Mechanisms of age-related accumulation and influence on cell function." *Free Radical Biology and Medicine* 33(5): 611-619.
- Brunk, U. T. and A. Terman** (2002). "The mitochondrial-lysosomal axis theory of aging - Accumulation of damaged mitochondria as a result of imperfect autophagocytosis." *European Journal of Biochemistry* 269(8): 1996-2002.
- Burnett, L. E.** (1997). "The Challenges of Living in Hypoxic and Hypercapnic Aquatic Environments." *American Zoologist* 37(6): 633-640.
- Byrne, P. A. and J. O'Halloran** (1999). "Aspects of assaying sediment toxicity in Irish estuarine ecosystems." *Marine Pollution Bulletin* 39(1-12): 97-105.
- Byrne, P. A. and J. O'Halloran** (2000). "Acute and sublethal toxicity of estuarine sediments to the manila clam, *Tapes semidecussatus*." *Environmental Toxicology* 15(5): 456-468.
- Caldeira, K. and M. E. Wickett** (2003). "Anthropogenic carbon and ocean pH." *Nature* 425(6956): 365-365.
- Cao, L. and K. Caldeira** (2008). "Atmospheric CO<sub>2</sub> stabilization and ocean acidification." *Geophysical Research Letters* 35(19): -.
- Cargnelli, L. M., S. J. Griesbach, D. B. Packer and E. Weissberger** (1999). Ocean quahog *Arctica islandica*, life history and habitat characteristics, NOAA Tech Memo NMFS-NE-148.
- Carpenter, S. J. and K. C. Lohmann** (1992). "Sr/Mg Ratios of Modern Marine Calcite - Empirical Indicators of Ocean Chemistry and Precipitation Rate." *Geochimica Et Cosmochimica Acta* 56(5): 1837-1849.
- Carré, M., I. Bentaleb, O. Bruguier, E. Ordinola, N. T. Barrett and M. Fontugne** (2006). "Calcification rate influence on trace element concentrations in aragonitic bivalve shells: Evidences and mechanisms." *Geochimica Et Cosmochimica Acta* 70(19): 4906-4920.
- Childress, J. J., R. W. Lee, N. K. Sanders, H. Felbeck, D. R. Oros, A. Toulmond, D. Desbruyeres, M. C. Kennicutt and J. Brooks** (1993). "Inorganic Carbon Uptake in Hydrothermal Vent Tubeworms Facilitated by High Environmental pCO<sub>2</sub>." *Nature* 362(6416): 147-149.
- Christmas, J. and S. Jordan** (1987). Biological monitoring of selected oyster bars in the lower Choptank. Dissolved oxygen in the Chesapeake Bay. G. MackKiernan. College park, Maryland, Maryland Sea Grant: 125-128.

## References

- Clarke, A.** (2003). "Costs and consequences of evolutionary temperature adaptation." *Trends in Ecology & Evolution* 18(11): 573-581.
- Clarke, L., A. Finch, T. Huthwelker, L. Foster, H. Kennedy, C. Richardson and H. Steaggles** (2009). XANES determination of magnesium speciation in shells of two marine bivalve molluscs. EGU General Assembly 2009, Vienna.
- Cochran, R. E. and L. E. Burnett** (1996). "Respiratory responses of the salt marsh animals, *Fundulus heteroclitus*, *Leiostomus xanthurus*, and *Palaemonetes pugio* to environmental hypoxia and hypercapnia and to the organophosphate pesticide, azinphosmethyl." *Journal of Experimental Marine Biology and Ecology* 195(1): 125-144.
- Commito, J. A., E. A. Celano, H. J. Celico, S. Como and C. P. Johnson** (2005). "Mussels matter: postlarval dispersal dynamics altered by a spatially complex ecosystem engineer." *Journal of Experimental Marine Biology and Ecology* 316(2): 133-147.
- Crenshaw, M.** (1972). "The inorganic composition of molluscan extrapallial fluid." *Biological Bulletin* 143: 506-512.
- Crenshaw, M. and J. Neff** (1969). "Decalcification at the mantle-shell interface in mollusks." *American Zoologist* 9: 881-889.
- Dahlgren, T. G., J. R. Weinberg and K. M. Halanych** (2000). "Phylogeography of the ocean quahog (*Arctica islandica*): influences of paleoclimate on genetic diversity and species range." *American Zoologist* 40(6): 989-989.
- Davenport, J. and Z. Chen** (1987). "A comparison of methods for the assessment of condition in the mussel (*Mytilus edulis* L.)." *J. Moll. Stud.* 53(293-297).
- Denman, K. L., G. Brasseur, A. Chidthaisong, P. Ciais, P. M. Cox, R. E. Dickinson, D. Hauglustaine, C. Heinze, E. Holland, D. Jacob, U. Lohmann, S. Ramachandran, P. L. da Silva Dias, S. C. Wofsy and X. Zhang** (2007). Couplings between Changes in the Climate System and Biogeochemistry. *Climate Change 2007: The Physical Science Basis. Contribution of Working Group I to the Fourth Assessment Report of the Intergovernmental Panel on Climate Change*. S. Solomon, D. Qin, M. Manning et al. Cambridge, Cambridge University Press. United Kingdom and New York, NY, USA. 4.
- DePaolo, D. J.** (2004). "Calcium isotopic variations produced by biological, kinetic, radiogenic and nucleosynthetic processes." *Geochemistry of Non-Traditional Stable Isotopes* 55: 255-288.
- Dickson, A., C. Sabine and J. Christian** (2007). Guide to best practices for ocean CO<sub>2</sub> measurements. PICES Special Publication 3, IOCCP Report No. 8.191 pp.
- Dickson, A. G., J. D. Afghan and G. C. Anderson** (2003). "Reference materials for oceanic CO<sub>2</sub> analysis: a method for the certification of total alkalinity." *Marine Chemistry* 80(2-3): 185-197.
- Dietzel, M., N. Gussone and A. Eisenhauer** (2004). "Co-precipitation of Sr<sup>2+</sup> and Ba<sup>2+</sup> with aragonite by membrane diffusion of CO<sub>2</sub> between 10 and 50 degrees C." *Chemical Geology* 203(1-2): 139-151.

- Dodd, J.** (1965). "Environmental control of strontium and magnesium in *Mytilus*." *Geochimica et Cosmochimica Acta* 29: 385-398.
- Dondero, F., A. Dagnino, H. Jonsson, F. Capri, L. Gastaldi and A. Viarengo** (2006). "Assessing the occurrence of a stress syndrome in mussels (*Mytilus edulis*) using a combined biomarker/gene expression approach." *Aquatic Toxicology* 78: S13-S24.
- Dunca, E., H. Mutvei, B. Schöne and S. Baden** (2006). "Retrospective Environmental Biomonitoring using *Arctica islandica* shells: Comparison of Different Analytical techniques." EOS, Transactions, American Geophysical Union [EOS Trans. Am. Geophys. Union]. 87(36).
- Dwyer, J. J. and L. E. Burnett** (1996). "Acid-base status of the oyster *Crassostrea virginica* in response to air exposure and to infections by *Perkinsus marinus*." *Biological Bulletin* 190(1): 139-147.
- Eisenhauer, A., T. F. Nagler, P. Stille, J. Kramers, N. Gussone, B. Bock, J. Fietzke, D. Hippler and A. D. Schmitt** (2004). "Proposal for international agreement on Ca notation resulting from discussions at workshops on stable isotope measurements held in Davos (Goldschmidt 2002) and Nice (EGS-AGU-EUG 2003)." *Geostandards and Geoanalytical Research* 28(1): 149-151.
- Elderfield, H. and G. Ganssen** (2000). "Past temperature and delta O-18 of surface ocean waters inferred from foraminiferal Mg/Ca ratios." *Nature* 405(6785): 442-445.
- Elnor, R. W. and R. N. Hughes** (1978). "Energy Maximization in Diet of Shore Crab, *Carcinus maenas*." *Journal of Animal Ecology* 47(1): 103-116.
- Enderlein, P. and M. Wahl** (2004). "Dominance of blue mussels versus consumer-mediated enhancement of benthic diversity." *Journal of Sea Research* 51(2): 145-155.
- Epplé, V.** (2004). High-resolution climate reconstruction for Holocene based on growth chronologies of bivalve *Arctica islandica* from the North Sea. Bremen, Germany, University of Bremen: 90.
- Fabry, V. J., B. A. Seibel, R. A. Feely and J. C. Orr** (2008). "Impacts of ocean acidification on marine fauna and ecosystem processes." *ICES J. Mar. Sci.* 65(3): 414-432.
- Fantle, M. S. and D. J. DePaolo** (2005). "Variations in the marine Ca cycle over the past 20 million years." *Earth and Planetary Science Letters* 237(1-2): 102-117.
- Feely, R. A., C. L. Sabine, K. Lee, W. Berelson, J. Kleypas, V. J. Fabry and F. J. Millero** (2004). "Impact of anthropogenic CO<sub>2</sub> on the CaCO<sub>3</sub> system in the oceans." *Science* 305(5682): 362-366.
- Findlay, H., H. Wood, M. Kendall, J. Spicer, R. Twitchett and S. Widdicombe** (2009, review). "Calcification, a physiological process to be considered in the context of the whole organism." *Biogeosciences Discussions* 6: 2267-2284.
- Foster, L., A. Finch, N. Allison, C. Andersson and L. Clarke** (2008). "Mg in aragonitic bivalve shells: Seasonal variations and mode of incorporation in *Arctica islandica*." *Chemical Geology* 254: 113-119.



**Frankignoulle, M., I. Bourge and R. Wollast** (1996). "Atmospheric CO<sub>2</sub> fluxes in a highly polluted estuary (the Scheldt)." *Limnol. Oceanogr.* 41(2): 365-369.

**Freitas, P., L. J. Clarke, H. Kennedy, C. Richardson and F. Abrantes** (2005). "Mg/Ca, Sr/Ca, and stable-isotope (delta O-18 and delta C-13) ratio profiles from the fan mussel *Pinna nobilis*: Seasonal records and temperature relationships." *Geochemistry Geophysics Geosystems* 6: -.

**Freitas, P. S., L. J. Clarke, H. A. Kennedy and C. A. Richardson** (2008). "Inter- and intra-specimen variability masks reliable temperature control on shell Mg/Ca ratios in laboratory- and field-cultured *Mytilus edulis* and *Pecten maximus* (bivalvia)." *Biogeosciences* 5(5): 1245-1258.

**Gaetani, G. A. and A. L. Cohen** (2006). "Element partitioning during precipitation of aragonite from seawater: A framework for understanding paleoproxies." *Geochimica Et Cosmochimica Acta* 70(18): 4617-4634.

**Gazeau, F., C. Quiblier, J. M. Jansen, J. P. Gattuso, J. J. Middelburg and C. H. R. Heip** (2007). "Impact of elevated CO<sub>2</sub> on shellfish calcification." *Geophysical Research Letters* 34(7).

**Gillikin, D. P., A. Lorrain, J. Navez, J. W. Taylor, E. Keppens, W. Baeyens and F. Dehairs** (2005). "Strong biological controls on Sr/Ca ratios in aragonitic marine bivalve shells." *Geochemistry Geophysics Geosystems* 6: -.

**Glasby, T. M.** (1998). "Estimating spatial variability in developing assemblages of epibiota on subtidal hard substrata." *Marine and Freshwater Research* 49(5): 429-437.

**Gosling, E.** (1992). *Systematics and Geographic Distribution of Mytilus. The Mussel Mytilus: Ecology, Physiology, Genetics and Culture.* E. Gosling. Amsterdam, Elsevier Science Publishers B.V. 25: 20.

**Graham, P.** (2004). "Climate Change Effects on River Flow to the Baltic Sea." *Ambio* 33: 235-241.

**Gran, G.** (1952). "Determination of the equivalence point in potentiometric titrations of seawater with hydrochloric acid." *Oceanologia Acta* 5: 209-218.

**Guerlet, E., K. Ledy, A. Meyer and L. Giamberini** (2007). "Towards a validation of a cellular biomarker suite in native and transplanted zebra mussels: A 2-year integrative field study of seasonal and pollution-induced variations." *Aquatic Toxicology* 81(4): 377-388.

**Gussone, N., F. Böhm, A. Eisenhauer, M. Dietzel, A. Heuser, B. M. A. Teichert, J. Reitner, G. Worheide and W. C. Dullo** (2005). "Calcium isotope fractionation in calcite and aragonite." *Geochimica Et Cosmochimica Acta* 69(18): 4485-4494.

**Gussone, N., A. Eisenhauer, A. Heuser, M. Dietzel, B. Bock, F. Böhm, H. J. Spero, D. W. Lea, J. Bijma and T. F. Nagler** (2003). "Model for kinetic effects on calcium isotope fractionation (delta Ca-44) in inorganic aragonite and cultured planktonic foraminifera." *Geochimica Et Cosmochimica Acta* 67(7): 1375-1382.

- Gussone, N., G. Langer, S. Thoms, G. Nehrke, A. Eisenhauer, U. Riebesell and G. Wefer** (2006). "Cellular calcium pathways and isotope fractionation in *Emiliania huxleyi*." *Geology* 34(8): 625-628.
- Gutowska, M. A., H. O. Pörtner and F. Melzner** (2008). "Growth and calcification in the cephalopod *Sepia officinalis* under elevated seawater pCO<sub>2</sub>." *Marine Ecology-Progress Series* 373: 303-309.
- Hall-Spencer, J. M., R. Rodolfo-Metalpa, S. Martin, E. Ransome, M. Fine, S. M. Turner, S. J. Rowley, D. Tedesco and M. C. Buia** (2008). "Volcanic carbon dioxide vents show ecosystem effects of ocean acidification." *Nature* 454(7200): 96-99.
- Hansen, H. P., H. C. Giesenhausen and G. Behrends** (1999). "Seasonal and long-term control of bottom-water oxygen deficiency in a stratified shallow-water coastal system." *ICES Journal of Marine Science* 56: 65-71.
- Hattan, S. J., T. M. Laue and N. D. Chasteen** (2001). "Purification and characterization of a novel calcium-binding protein from the extrapallial fluid of the mollusc, *Mytilus edulis*." *Journal of Biological Chemistry* 276(6): 4461-4468.
- Heinemann, A., J. Fietzke, A. Eisenhauer and K. Zumholz** (2008). "Modification of Ca isotope and trace metal composition of the major matrices involved in shell formation of *Mytilus edulis*." *Geochemistry Geophysics Geosystems* 9: -.
- Hendry, J. P., W. T. Perkins and T. Bane** (2001). "Short-term environmental change in a Jurassic lagoon deduced from geochemical trends in aragonite bivalve shells." *Geological Society of America Bulletin* 113(6): 790-798.
- Heuser, A.** (2002). Variations of Calcium Isotopes ( $\delta^{44}\text{Ca}$ ) in Foraminifera over the past 24 Ma. Kiel, CAU. PhD: 109.
- Heuser, A., A. Eisenhauer, F. Böhm, K. Wallmann, N. Gussone, P. N. Pearson, T. F. Nagler and W. C. Dullo** (2005). "Calcium isotope ( $\delta^{44}\text{Ca}$ ) variations of Neogene planktonic foraminifera." *Paleoceanography* 20(2): -.
- Hill, K. T. and C. Z. Womersley** (1993). "Interactive Effects of Some Environmental and Physiological Variables on Fluorescent Age Pigment Accumulation in Brain and Heart Tissues of an Aquatic Poikilotherm." *Environmental Biology of Fishes* 37(4): 397-405.
- Hippler, D., A. Eisenhauer and T. F. Nagler** (2006). "Tropical Atlantic SST history inferred from Ca isotope thermometry over the last 140ka." *Geochimica Et Cosmochimica Acta* 70(1): 90-100.
- Hippler, D., M. Kluender, R. Witbaard, D. Buhl, D. Richter, D. Frei and A. Immenhauser** (2007). Environmental versus biological controls on multi-proxy records from bivalve shell carbonate. AGU Fall Meeting, San Francisco.
- Hippler, D., R. Kozdon, K. F. Darling, A. Eisenhauer and T. F. Nägler** (2007). "Calcium isotopic composition of high-latitude proxy carrier *Neogloboquadrina pachyderma* (sin.)." *Biogeosciences Discuss* 4: 3301-3330.
- Hole, L. M., M. N. Moore and D. Bellamy** (1993). "Age-Related Cellular Reactions to Copper in the Marine Mussel *Mytilus edulis*." *Marine Ecology-Progress Series* 94(2): 175-179.

## References

- Hole, L. M., M. N. Moore and D. Bellamy** (1995). "Age-Related Cellular and Physiological Reactions to Hypoxia and Hyperthermia in Marine Mussels." *Marine Ecology-Progress Series* 122(1-3): 173-178.
- Holmden, C. and J. D. Hudson** (2003). "Sr-86/Sr-86 and Sr/Ca investigation of Jurassic mollusks from Scotland: Implications for paleosalinities and the Sr/Ca ratio of seawater." *Geological Society of America Bulletin* 115(10): 1249-1264.
- Hupfer, P. and B. Tinz** (1996). *Warnsignale aus der Ostsee*. J. Lozan, R. Lampe, W. Matthäuset al. Berlin, Parey: 385.
- Immenhauser, A., T. F. Nagler, T. Steuber and D. Hippler** (2005). "A critical assessment of mollusk O-18/O-16, Mg/Ca, and Ca-44/Ca-40 ratios as proxies for Cretaceous seawater temperature seasonality." *Palaeogeography Palaeoclimatology Palaeoecology* 215(3-4): 221-237.
- Irie, T. and Y. Iwasa** (2005). "Optimal growth pattern of defensive organs: the diversity of shell growth among mollusks." *American Naturalist* 165(6): 727-727.
- Jacob, D. E., A. L. Soldati, R. Wirth, J. Huth, U. Wehrmeister and W. Hofmeister** (2008). "Nanostructure, composition and mechanisms of bivalve shell growth." *Geochimica Et Cosmochimica Acta* 72(22): 5401-5415.
- Jansson, A.-M. and N. Kautsky** (1977). Quantitative survey of hard bottom communities in a Baltic archipelago. *Biology of benthic organisms*. 11th Europ. Symp. Mar. Biol., Galway, Oct. 1976 B. F. Keegan, P. O'Ceidigh and P. J. S. Boaden. Oxford, Perg. Press: 359-366.
- Jørgensen, C. B., P. S. Larsen and H. U. Riisgard** (1990). "Effects of Temperature on the Mussel Pump." *Marine Ecology-Progress Series* 64(1-2): 89-97.
- Juanes, F.** (1992). "Why Do Decapod Crustaceans Prefer Small-Sized Molluscan Prey." *Marine Ecology-Progress Series* 87(3): 239-249.
- Kagley, A. N., R. G. Snider, P. K. Krishnakumar and E. Casillas** (2003). "Assessment of seasonal variability of cytochemical responses to contaminant exposure in the blue mussel *Mytilus edulis* (complex)." *Archives of Environmental Contamination and Toxicology* 44(1): 43-52.
- Katz, A.** (1973). "The interaction of magnesium with calcite during crystal growth at 25 to 90°C and one atmosphere." *Geochimica et Cosmochimica Acta* 37: 1563-1586.
- Kautsky, N.** (1981). "On the trophic role of the blue mussel (*Mytilus edulis* L.) in a Baltic coastal ecosystem and the fate of the organic matter produced by the mussels." *Kieler Meeresforschung, Sonderheft* 5: 454-461.
- Kautsky, N.** (1982). "Growth and Size Structure in a Baltic *Mytilus edulis* Population." *Marine Biology* 68: 117-133.
- Kautsky, N. and S. Evans** (1987). "Role of Biodeposition by *Mytilus edulis* in the Circulation of Matter and Nutrients in a Baltic Coastal Ecosystem." *Marine Ecology-Progress Series* 38(3): 201-212.

- Kautsky, N., K. Johannesson and M. Tedengren** (1990). "Genotypic and phenotypic differences between Baltic and North Sea populations of *Mytilus edulis* evaluated through reciprocal transplantations. I. Growth and morphology." Marine Ecology Progress Series 59: 203-210.
- Kinsman, D. and H. Holland** (1969). "The coprecipitation of cations with CaCO<sub>3</sub>: IV. The coprecipitation of Sr<sup>2+</sup> with aragonite between 16° and 96°." Geochimica et Cosmochimica Acta 33: 1-17.
- Kisakürek, B., A. Eisenhauer, F. Böhm, D. Garbe-Schonberg and J. Erez** (2008). "Controls on shell Mg/Ca and Sr/Ca in cultured planktonic foraminiferan, *Globigerinoides ruber* (white)." Earth and Planetary Science Letters 273(3-4): 260-269.
- Klein, R. T., K. C. Lohmann and C. W. Thayer** (1996). "Bivalve skeletons record sea-surface temperature and  $\delta^{18}\text{O}$  via Mg/Ca and  $^{18}\text{O}/^{16}\text{O}$  ratios." Geology 24: 415-418.
- Klein, R. T., K. C. Lohmann and C. W. Thayer** (1996). "Sr/Ca and C-13/C-12 ratios in skeletal calcite of *Mytilus trossulus*: Covariation with metabolic rate, salinity, and carbon isotopic composition of seawater." Geochimica Et Cosmochimica Acta 60(21): 4207-4221.
- Knoll, A. H., R. K. Bambach, D. E. Canfield and J. P. Grotzinger** (1996). "Comparative earth history and Late Permian mass extinction." Science 273(5274): 452-457.
- Kodama, K., H. Shiraishi, M. Morita and T. Horiguchi** (2006). "Verification of lipofuscin-based crustacean ageing: seasonality of lipofuscin accumulation in the stomatopod *Oratosquilla oratoria* in relation to water temperature." Marine Biology 150(1): 131-140.
- Koehler, A., U. Marx, K. Broeg, S. Bahns and J. Bressling** (2008). "Effects of nanoparticles in *Mytilus edulis* gills and hepatopancreas - A new threat to marine life?" Marine Environmental Research 66(1): 12-14.
- Kossak, U.** (2006). How climate change translates into ecological change: impacts of warming and desalination on prey properties and predator-prey interactions in the Baltic Sea. Kiel, Germany, Christian-Albrechts-Universität. Ph.D. thesis: 97 pp.
- Kozdon, R.** (2007).  $\delta^{44}\text{Ca}/^{40}\text{Ca}$ , Mg/Ca and  $\delta^{18}\text{O}$  ratios of planktonic foraminifera from the Nordic Seas. Kiel, University of Kiel: 86.
- Krishnakumar, P. K., E. Casillas and U. Varanasi** (1994). "Effect of Environmental Contaminants on the Health of *Mytilus edulis* from Puget-Sound, Washington, USA .1. Cytochemical Measures of Lysosomal Responses in the Digestive Cells Using Automatic Image-Analysis." Marine Ecology-Progress Series 106(3): 249-261.
- Krishnakumar, P. K., E. Casillas and U. Varanasi** (1997). "Cytochemical responses in the digestive tissue of *Mytilus edulis* complex exposed to microencapsulated PAHs or PCBs." Comparative Biochemistry and Physiology C-Pharmacology Toxicology & Endocrinology 118(1): 11-18.
- Kuffner, I. B., A. J. Andersson, P. L. Jokiel, K. S. Rodgers and F. T. Mackenzie** (2008). "Decreased abundance of crustose coralline algae due to ocean acidification." Nature Geoscience 1(2): 114-117.

## References

- Kurihara, H.** (2008). "Effects of CO<sub>2</sub>-driven ocean acidification on the early developmental stages of invertebrates." *Marine Ecology-Progress Series* 373: 275-284.
- Langer, G., M. Geisen, K. H. Baumann, J. Klas, U. Riebesell, S. Thoms and J. R. Young** (2006). "Species-specific responses of calcifying algae to changing seawater carbonate chemistry." *Geochemistry Geophysics Geosystems* 7: -.
- Langer, G., N. Gussone, G. Nehrke, U. Riebesell, A. Eisenhauer and S. Thoms** (2007). "Calcium isotope fractionation during coccolith formation in *Emiliania huxleyi*: Independence of growth and calcification rate." *Geochemistry Geophysics Geosystems* 8: -.
- Laudien, J. and M. Wahl** (1999). "Indirect effects of epibiosis on host mortality: Seastar predation on differently fouled mussels." *Marine Ecology-Pubblicazioni Della Stazione Zoologica Di Napoli I* 20(1): 35-47.
- Lazareth, C. E., E. Vander Putten, L. Andre and F. Dehairs** (2003). "High-resolution trace element profiles in shells of the mangrove bivalve *Isognomon ehippium*: a record of environmental spatio-temporal variations?" *Estuarine Coastal and Shelf Science* 57(5-6): 1103-1114.
- Leeuwenburgh, C., R. Fiebig, R. Chandwaney and L. L. Ji** (1994). "Aging and Exercise Training in Skeletal-Muscle - Responses of Glutathione and Antioxidant Enzyme-Systems." *American Journal of Physiology* 267(2): R439-R445.
- Lehmann, A., W. Krauss and H. H. Hinrichsen** (2002). "Effects of remote and local atmospheric forcing on circulation and upwelling in the Baltic Sea." *Tellus Series a-Dynamic Meteorology and Oceanography* 54(3): 299-316.
- Lemarchand, D., G. T. Wasserburg and D. A. Papanastassiou** (2004). "Rate-controlled calcium isotope fractionation in synthetic calcite." *Geochimica Et Cosmochimica Acta* 68(22): 4665-4678.
- Leonard, G. H., M. D. Bertness and P. O. Yund** (1999). "Crab predation, waterborne cues, and inducible defenses in the blue mussel, *Mytilus edulis*." *Ecology* 80(1): 1-14.
- Lerman, A.** (1965). "Strontium and Magnesium in Water and in *Crassostrea* Calcite." *Science* 150(3697): 745 - 751.
- Lewis, E. and D. Wallace** (1998). Program Developed for CO<sub>2</sub> System Calculations. ORNL/CDIAC-105. Carbon Dioxide Information Analysis Center, Oak Ridge National Laboratory, U.S. Department of Energy. Oak Ridge, Tennessee.
- Lindinger, M. I., D. J. Lauren and D. G. McDonald** (1984). "Acid-Base-Balance in the Sea Mussel, *Mytilus edulis* .3. Effects of Environmental Hypercapnia on Intracellular and Extracellular Acid-Base-Balance." *Marine Biology Letters* 5(6): 371-381.
- Lohse, D. P.** (1993). "The Importance of Secondary Substratum in a Rocky Intertidal Community." *Journal of Experimental Marine Biology and Ecology* 166(1): 1-17.
- Loosanoff** (1953). "Reproductive cycle in *Cyprina islandica*." *Biol. Bull. mar. biol. Lab.* 104: 146-155.

- Lopes-Lima, M., I. Ribeiro, R. A. Pinto and J. Machado** (2005). "Isolation, purification and characterization of glycosaminoglycans in the fluids of the mollusc *Anodonta cygnea*." *Comparative Biochemistry and Physiology a-Molecular & Integrative Physiology* 141(3): 319-326.
- Lopez, O., P. Zuddas and D. Faivre** (2009). "The influence of temperature and seawater composition on calcite crystal growth mechanisms and kinetics: Implications for Mg incorporation in calcite lattice." *Geochimica Et Cosmochimica Acta* 73(2): 337-347.
- Lorens, R. B. and M. L. Bender** (1980). "The Impact of Solution Chemistry on *Mytilus edulis* Calcite and Aragonite." *Geochimica Et Cosmochimica Acta* 44(9): 1265-1278.
- Lozan, J., R. Lampe, W. Matthäus, E. Rachor, H. Rumohr and H. v. Westernhagen** (1996). *Warnsignale aus der Ostsee*. J. Lozan, R. Lampe, W. Matthäus et al. Berlin, Parey: 385.
- Malone, P. and J. Dodd** (1967). "Temperature and salinity effects on calcification rate in *Mytilus edulis* and its paleoecological implicatons." *Limnol. Oceanogr.* 12.(3): 432-436.
- Marriott, C. S., G. M. Henderson, N. S. Belshaw and A. W. Tudhope** (2004). "Temperature dependence of delta Li-7, delta Ca-44 and Li/Ca during growth of calcium carbonate." *Earth and Planetary Science Letters* 222(2): 615-624.
- Martin, S., R. Rodolfo-Metalpa, E. Ransome, S. Rowley, M. C. Buia, J. P. Gattuso and J. Hall-Spencer** (2008). "Effects of naturally acidified seawater on seagrass calcareous epibionts." *Biology Letters* 4(6): 689-692.
- Mathew, S. and R. Damodaran** (1997). "Lipofuscin as physiological indicator of heavy metal stress in *Sunetta scripta* (yellow clam) and *Perna viridis* (green mussel)." *Indian Journal of Marine Sciences* 26(1): 64-67.
- McConnaughey, T. A. and D. P. Gillikin** (2008). "Carbon isotopes in mollusk shell carbonates." *Geo-Marine Letters* 28(5-6): 287-299.
- McVeigh, A., M. Moore, J. I. Allen and P. Dyke** (2006). "Lysosomal responses to nutritional and contaminant stress in mussel hepatopancreatic digestive cells: A modelling study." *Marine Environmental Research* 62: S433-S438.
- Meier, H. E. M.** (2006). "Baltic Sea climate in the late twenty-first century: a dynamical downscaling approach using two global models and two emission scenarios." *Climate Dynamics* 27(1): 39-68.
- Michaelidis, B., C. Ouzounis, A. Palaras and H. O. Pörtner** (2005). "Effects of long-term moderate hypercapnia on acid-base balance and growth rate in marine mussels *Mytilus galloprovincialis*." *Marine Ecology-Progress Series* 293: 109-118.
- Moore, M. N.** (1990). "Lysosomal Cytochemistry in Marine Environmental Monitoring." *Histochemical Journal* 22(4): 187-191.
- Morris, S. and A. Taylor** (1983). "Diurnal and seasonal variation in physico-chemical conditions within intertidal rock pools." *Estuarine Coastal and Shelf Science* 17: 339-355.

## References

- Morse, J., R. Arvidson and A. Lüttge** (2007). "Calcium Carbonate Formation and Dissolution." *Chemical Reviews* 107, : 342-381.
- Morse, J. W., Q. W. Wang and M. Y. Tsio** (1997). "Influences of temperature and Mg:Ca ratio on CaCO<sub>3</sub> precipitates from seawater." *Geology* 25(1): 85-87.
- Moy, A., W. Howard, S. Bray and T. Trull** (2009). "Reduced calcification in modern Southern Ocean planktonic foraminifera." *Nature Geoscience* 2, : 276 - 280.
- Mucci, A., R. Canuel and S. J. Zhong** (1989). "The Solubility of Calcite and Aragonite in Sulfate-Free Seawater and the Seeded Growth-Kinetics and Composition of the Precipitates at 25-Degrees-C." *Chemical Geology* 74(3-4): 309-320.
- Mucci, A. and J. W. Morse** (1984). "The Solubility of Calcite in Seawater Solutions of Various Magnesium Concentration, It=0.697-M at 25-Degrees-C and One Atmosphere Total Pressure." *Geochimica Et Cosmochimica Acta* 48(4): 815-822.
- Nagarajan, R., S. E. G. Lea and J. D. Goss-Custard** (2006). "Seasonal variations in mussel, *Mytilus edulis* L. shell thickness and strength and their ecological implications." *Journal of Experimental Marine Biology and Ecology* 339(2): 241-250.
- Nägler, T. F., A. Eisenhauer, A. Müller, C. Hemleben and J. Kramers** (2000). "The delta<sup>44</sup>Ca-temperature calibration on fossil and cultured *Globigerinoides sacculifer*. New tool for reconstruction of past sea surface temperatures." *Geochemistry Geophysics Geosystems* 1(9): 2000GC000091.
- Niedermayr, A., M. Dietzel, S. Köhler, F. Böhm, B. Kiskürek and A. Eisenhauer** (2009). Sr Incorporation and Calcium Isotopic Fractionation during Calcium Carbonate Precipitation. EGU General Assembly 2009.
- O'Donovan, V. and O. Tully** (1996). "Lipofuscin (age pigment) as an index of crustacean age: Correlation with age, temperature and body size in cultured juvenile *Homarus gammarus* L." *Journal of Experimental Marine Biology and Ecology* 207(1-2): 1-14.
- Oliveira, P. F., A. R. da Costa and H. G. Ferreira** (2008). "A mathematical model of the proton balance in the outer mantle epithelium of *Anodonta cygnea* L." *Journal of Membrane Biology* 223(2): 59-72.
- Omstedt, A., B. Gustafsson, J. Rodhe and G. Walin** (2000). "Use of Baltic Sea modelling to investigate the water cycle and the heat balance in GCM and regional climate models." *Climate Research* 15(2): 95-108.
- Oomori, T., H. Kaneshima, Y. Maezato and Y. Kitano** (1987). "Distribution Coefficient of Mg<sup>2+</sup> Ions between Calcite and Solution at 10-50-Degrees-C." *Marine Chemistry* 20(4): 327-336.
- Orr, J. C., V. J. Fabry, O. Aumont, L. Bopp, S. C. Doney, R. A. Feely, A. Gnanadesikan, N. Gruber, A. Ishida, F. Joos, R. M. Key, K. Lindsay, E. Maier-Reimer, R. Matear, P. Monfray, A. Mouchet, R. G. Najjar, G. K. Plattner, K. B. Rodgers, C. L. Sabine, J. L. Sarmiento, R. Schlitzer, R. D. Slater, I. J. Totterdell, M. F. Weirig, Y. Yamanaka and A. Yool** (2005). "Anthropogenic ocean acidification over the twenty-first century and its impact on calcifying organisms." *Nature* 437(7059): 681-686.

- Page, H. M. and D. M. Hubbard** (1987). "Temporal and Spatial Patterns of Growth in Mussels *Mytilus edulis* on an Offshore Platform - Relationships to Water Temperature and Food Availability." *Journal of Experimental Marine Biology and Ecology* 111(2): 159-179.
- Palacios, R., J. M. Orensanz and D. A. Armstrong** (1994). "Seasonal and Lifelong Variation of Sr/Ca Ratio in Shells of *Mya arenaria* from Grays-Harbor (Washington) - an Ancillary Criterion in Demographic-Studies." *Estuarine Coastal and Shelf Science* 39(4): 313-327.
- Palmer, A. R.** (1981). "Predator Errors, Foraging in Unpredictable Environments and Risk - the Consequences of Prey Variation in Handling Time Versus Net Energy." *American Naturalist* 118: 908-915.
- Palmer, A. R.** (1992). "Calcification in Marine Mollusks - How Costly Is It?" *Proceedings of the National Academy of Sciences of the United States of America* 89(4): 1379-1382.
- Petrovic, S., L. Semencic, B. Ozretic and M. Ozretic** (2004). "Seasonal variations of physiological and cellular biomarkers and their use in the biomonitoring of north Adriatic coastal waters (Croatia)." *Marine Pollution Bulletin* 49(9-10): 713-720.
- Philipp, E., T. Brey, O. Heilmayer, D. Abele and H. O. Pörtner** (2006). "Physiological ageing in a temperate and a polar swimming scallop." *Marine Ecology-Progress Series* 307: 187-198.
- Philipp, E., T. Brey, H. O. Pörtner and D. Abele** (2005). "Chronological and physiological ageing in a polar and a temperate mud clam." *Mechanisms of Ageing and Development* 126(5): 598-609.
- Pörtner, H. O.** (2008). "Ecosystem effects of ocean acidification in times of ocean warming: a physiologist's view." *Marine Ecology Progress Series* 373: 203-217.
- Pörtner, H. O., A. Reipschläger and N. Heisler** (1998). "Acid-base regulation, metabolism and energetics in *Sipunculus nudus* as a function of ambient carbon dioxide level." *Journal of Experimental Biology* 201(1): 43-55.
- Purton, L. M. A., G. A. Shields, M. D. Brasier and G. W. Grime** (1999). "Metabolism controls Sr/Ca ratios in fossil aragonitic mollusks." *Geology* 27(12): 1083-1086.
- Regoli, F.** (1992). "Lysosomal Responses as a Sensitive Stress Index in Biomonitoring Heavy-Metal Pollution." *Marine Ecology-Progress Series* 84(1): 63-69.
- Remane, A. and C. Schlieper** (1971). *Biology of brackish waters*. New York, Toronto, Sydney, Wiley Interscience Division, John Wiley & Sons, Inc.pp.
- Reusch, T. B. H. and A. R. O. Chapman** (1997). "Persistence and space occupancy by subtidal blue mussel patches." *Ecological Monographs* 67(1): 65-87.
- Reuter, P.** (2004). *Einfluss klimarelevanter Faktoren auf das Wachstum der Miesmuschel (*Mytilus edulis*)*. Kiel, University of Kiel. Diploma thesis: 56.
- Riebesell, U.** (2008). "Climate change - Acid test for marine biodiversity." *Nature* 454(7200): 46-47.



## References

- Riisgard, H. and A. Randlov** (1981). "Energy budgets, Growth and Filtration Rates in *Mytilus edulis* at different Algal concentrations." *Marine Biology* 61: 227-234.
- Rosenberg, G. D. and W. W. Hughes** (1991). "A Metabolic Model for the Determination of Shell Composition in the Bivalve Mollusk, *Mytilus edulis*." *Lethaia* 24(1): 83-96.
- Sabine, C. L., R. A. Feely, N. Gruber, R. M. Key, K. Lee, J. L. Bullister, R. Wanninkhof, C. S. Wong, D. W. R. Wallace, B. Tilbrook, F. J. Millero, T. H. Peng, A. Kozyr, T. Ono and A. F. Rios** (2004). "The oceanic sink for anthropogenic CO<sub>2</sub>." *Science* 305(5682): 367-371.
- Schöne, B. R., J. Fiebig, M. Pfeiffer, R. Gless, J. Hickson, A. L. A. Johnson, W. Dreyer and W. Oschmann** (2005). "Climate records from a bivalved Methuselah (*Arctica islandica*, Mollusca; Iceland)." *Palaeogeography Palaeoclimatology Palaeoecology* 228(1-2): 130-148.
- Schöne, B. R., S. D. Houk, A. D. F. Castro, J. Fiebig, W. Oschmann, I. Kroncke, W. Dreyer and F. Gosselck** (2005). "Daily growth rates in shells of *Arctica islandica*: Assessing sub-seasonal environmental controls on a long-lived bivalve mollusk." *Palaios* 20(1): 78-92.
- Seed, R.** (1976). *Ecology. Marine Mussels*. B. L. Bayne. Cambridge, Cambridge University Press: 13-65.
- Seed, R.** (1996). "Patterns of biodiversity in the macro-invertebrate fauna associated with mussel patches on rocky shores." *Journal of the Marine Biological Association of the United Kingdom* 76(1): 203-210.
- Seed, R. and T. Suchanek** (1992). *Population and community ecology of Mytilus. The mussel Mytilus: ecology, physiology, genetics and culture*. E. Gosling. Amsterdam, Elsevier Science Publishers: 87-170.
- Sheehy, M. R. J.** (2002). "Role of environmental temperature in aging and longevity: insights from neurolipofuscin." *Archives of Gerontology and Geriatrics* 34(3): 287-310.
- Sheehy, M. R. J., J. G. Greenwood and D. R. Fielder** (1994). "More Accurate Chronological Age-Determination of Crustaceans from Field Situations Using the Physiological Age Marker, Lipofuscin." *Marine Biology* 121(2): 237-245.
- Sheehy, M. R. J., J. G. Greenwood and D. R. Fielder** (1995). "Lipofuscin as a Record of Rate of Living in an Aquatic Poikilotherm." *Journals of Gerontology Series a-Biological Sciences and Medical Sciences* 50(6): B327-B336.
- Shirayama, Y. and H. Thornton** (2005). "Effect of increased atmospheric CO<sub>2</sub> on shallow water marine benthos." *Journal of Geophysical Research-Oceans* 110(C9).
- Shumway, S.** (1977). "Effect of Salinity Fluctuation on the Osmotic Pressure and Na<sup>+</sup>, Ca<sup>2+</sup> and Mg<sup>2+</sup> Ion Concentrations in the Hemolymph of Bivalve Molluscs." *Marine Biology* 41: 153-177.

- Sime, N. G., C. L. De La Rocha and A. Galy** (2005). "Negligible temperature dependence of calcium isotope fractionation in 12 species of planktonic foraminifera." *Earth and Planetary Science Letters* 232(1-2): 51-66.
- Sitte, N., M. Huber, T. Grune, A. Ladhoff, W. D. Doecke, T. Von Zglinicki and K. J. A. Davies** (2000). "Proteasome inhibition by lipofuscin/ceroid during postmitotic aging of fibroblasts." *Faseb Journal* 14(11): 1490-1498.
- Skulan, J. and D. J. DePaolo** (1999). "Calcium isotope fractionation between soft and mineralized tissues as a monitor of calcium use in vertebrates." *Proceedings of the National Academy of Sciences of the United States of America* 96(24): 13709-13713.
- Skulan, J., D. J. DePaolo and T. L. Owens** (1997). "Biological control of calcium isotopic abundances in the global calcium cycle." *Geochimica Et Cosmochimica Acta* 61(12): 2505-2510.
- Smith, S. V. and G. S. Key** (1975). "Carbon-Dioxide and Metabolism in Marine Environments." *Limnol. Oceanogr.* 20(3): 493-495.
- Stanley, S. M.** (2006). "Influence of seawater chemistry on biomineralization throughout phanerozoic time: Paleontological and experimental evidence." *Palaeogeography Palaeoclimatology Palaeoecology* 232(2-4): 214-236.
- Strahl, J., E. Philipp, T. Brey, K. Broeg and D. Abele** (2007). "Physiological aging in the Icelandic population of the ocean quahog *Arctica islandica*." *Aquatic Biology* 1(1): 77-83.
- Suchanek, T. H.** (1985). *Mussels and their role in structuring rocky shore communities. The Ecology of Rocky Coasts.* P. G. Moore and R. Seed. London, Hodder & Stoughton: 70-96.
- Sukhotin, A. A., D. Abele and H. O. Pörtner** (2002). "Growth, metabolism and lipid peroxidation in *Mytilus edulis*: age and size effects." *Marine Ecology-Progress Series* 226: 223-234.
- Surge, D. and K. C. Lohmann** (2008). "Evaluating Mg/Ca ratios as a temperature proxy in the estuarine oyster, *Crassostrea virginica*." *Journal of Geophysical Research-Biogeosciences* 113(G2): -.
- Takesue, R. K. and A. Van Geen** (2004). "Mg/Ca, Sr/Ca, and stable isotopes in modern and holocene *Protothaca staminea* shells from a northern California coastal upwelling region." *Geochimica Et Cosmochimica Acta* 68(19): 3845-3861.
- Tang, J. W., M. Dietzel, F. Böhm, S. J. Kohler and A. Eisenhauer** (2008). " $\text{Sr}^{2+}/\text{Ca}^{2+}$  and  $\text{Ca}^{44}/\text{Ca}^{40}$  fractionation during inorganic calcite formation: II. Ca isotopes." *Geochimica Et Cosmochimica Acta* 72(15): 3733-3745.
- Tang, J. W., S. J. Kohler and M. Dietzel** (2008). " $\text{Sr}^{2+}/\text{Ca}^{2+}$  and  $\text{Ca}^{44}/\text{Ca}^{40}$  fractionation during inorganic calcite formation: I. Sr incorporation." *Geochimica Et Cosmochimica Acta* 72(15): 3718-3732.
- Taylor, A.** (1976). "The cardiac Responses to Shell Opening and Closure in the Bivalve *Arctica islandica* (L.)." *Journal of Experimental Biology* 64: 751-759.

## References

- Tedengren, M. and N. Kautsky** (1986). "Comparative-Study of the Physiology and Its Probable Effect on Size in Blue Mussels (*Mytilus edulis* L.) from the North-Sea and the Northern Baltic Proper." *Ophelia* 25(3): 147-155.
- Terman, A.** (2001). "Garbage catastrophe theory of aging: imperfect removal of oxidative damage?" *Redox Report* 6(1): 15-26.
- Theede, H., A. Ponat, K. Hiroki and C. Schlieper** (1969). "Studies on the resistance of marine bottom invertebrates to oxygen-deficiency and hydrogen sulphide." *Mar. Biol.* 2: 325-337.
- Thomsen, J.** (2008). Ion and acid-base regulation in marine invertebrates in response to altered carbonate system parameters. Kiel, University of Kiel: 63.
- Toland, H., B. Perkins, N. Pearce, F. Keenan and M. J. Leng** (2000). "A study of sclerochronology by laser ablation ICP-MS." *Journal of Analytical Atomic Spectrometry* 15(9): 1143-1148.
- Totaro, E. A., V. Cuombo and F. A. Pisanti** (1986). "Influence of environmental stress on lipofuscin production." *Archives of Gerontology and Geriatrics* 5(4): 343-349.
- Truchot, J. P. and A. Duhameljouve** (1980). "Oxygen and Carbon-Dioxide in the Marine Inter-Tidal Environment - Diurnal and Tidal Changes in Rockpools." *Respiration Physiology* 39(3): 241-254.
- Tsuchiya, M. and M. Nishihira** (1986). "Islands of *Mytilus edulis* as a Habitat for Small Intertidal Animals - Effect of *Mytilus* Age Structure on the Species Composition of the Associated Fauna and Community Organization." *Marine Ecology-Progress Series* 31(2): 171-178.
- Tully, O., V. O'Donovan and D. Fletcher** (2000). "Metabolic rate and lipofuscin accumulation in juvenile European lobster (*Homarus gammarus*) in relation to simulated seasonal changes in temperature." *Marine Biology* 137(5-6): 1031-1040.
- Valenzano, D. R., E. Terzibasi, A. Cattaneo, L. Domenici and A. Cellerino** (2006). "Temperature affects longevity and age-related locomotor and cognitive decay in the short-lived fish *Nothobranchius furzeri*." *Aging Cell* 5(3): 275-278.
- Vander Putten, E., F. Dehairs, E. Keppens and W. Baeyens** (2000). "High resolution distribution of trace elements in the calcite shell layer of modern *Mytilus edulis*: Environmental and biological controls." *Geochimica Et Cosmochimica Acta* 64(6): 997-1011.
- Vernet, M., J. R. Hunter and R. D. Vetter** (1988). "Accumulation of Age Pigments (Lipofuscin) in 2 Cold-Water Fishes." *Fishery Bulletin* 86(2): 401-407.
- von Oertzen, J.-a., Schulz, S.** (1973). "Beitrag zur geographischen Verbreitung und ökologischen Existenz von Bivalviern in der Ostsee." *Beitr. Meereskunde* 32: 75-88.
- Wahl, M.** (2001). "Small scale variability of benthic assemblages: biogenic neighborhood effects." *Journal of Experimental Marine Biology and Ecology* 258(1): 101-114.

**Walther, G. R., E. Post, P. Convey, A. Menzel, C. Parmesan, T. J. C. Beebee, J. M. Fromentin, O. Hoegh-Guldberg and F. Bairlein** (2002). "Ecological responses to recent climate change." *Nature* 416(6879): 389-395.

**Wanamaker, A. D., K. J. Kreutz, H. W. Borns, D. S. Introne, S. Feindel, S. Funder, P. D. Rawson and B. J. Barber** (2007). "Experimental determination of salinity, temperature, growth, and metabolic effects on shell isotope chemistry of *Mytilus edulis* collected from Maine and Greenland." *Paleoceanography* 22(2): -.

**Wanamaker, A. D., K. J. Kreutz, T. Wilson, H. W. Borns, D. S. Introne and S. Feindel** (2008). "Experimentally determined Mg/Ca and Sr/Ca ratios in juvenile bivalve calcite for *Mytilus edulis*: implications for paleotemperature reconstructions." *Geo-Marine Letters* 28(5-6): 359-368.

**Watson, E. B.** (2004). "A conceptual model for near-surface kinetic controls on the trace-element and stable isotope composition of abiogenic calcite crystals." *Geochimica Et Cosmochimica Acta* 68(7): 1473-1488.

**Weidman, C. R., G. A. Jones and K. C. Lohmann** (1994). "The Long-Lived Mollusk *Arctica islandica* - a New Paleoceanographic Tool for the Reconstruction of Bottom Temperatures for the Continental Shelves of the Northern North-Atlantic Ocean (Vol 99, Pg 18,305, 1994)." *Journal of Geophysical Research-Oceans* 99(C11): 22753-22753.

**Weigelt, M., Rumohr, H.** (1986). "Effects of wide-range oxygen depletion on benthic fauna and demersal fish in Kiel Bay 1981-1983." *Meeresforsch.* 31: 124-136.

**Weiss, I. M., N. Tuross, L. Addadi and S. Weiner** (2002). "Mollusc larval shell formation: Amorphous calcium carbonate is a precursor phase for aragonite." *Journal of Experimental Zoology* 293(5): 478-491.

**Wheeler, A.** (1992). Mechanisms of molluscan shell formation. Calcification in biological systems. E. Bonucci. Boca Raton, Florida, CRC: 179-216.

**Wigley, T. M. L., R. Richels and J. A. Edmonds** (1996). "Economic and environmental choices in the stabilization of atmospheric CO<sub>2</sub> concentrations." *Nature* 379(6562): 240-243.

**Wilbur, K.** (1964). Shell formation and regeneration. *Physiology of the Mollusca* 1. K. Wilbur and C. Yonge. New York, Academic Press: 243-282.

**Wilbur, K. and A. Saleuddin** (1983). Shell formation. *The Mollusca*. K. Wilbur. New York, London Academic Press. 4 Physiology Part 1: 235 ff.

**Wilbur, K. M. and A. M. Bernhardt** (1984). "Effects of Amino-Acids, Magnesium, and Molluscan Extrapallial Fluid on Crystallization of Calcium-Carbonate - Invitro Experiments." *Biological Bulletin* 166(1): 251-259.

**Wilt, F. H.** (2005). "Developmental biology meets materials science: Morphogenesis of biomineralized structures." *Developmental Biology* 280(1): 15-25.

**Winston, G. W.** (1991). "Oxidants and Antioxidants in Aquatic Animals." *Comparative Biochemistry and Physiology C-Pharmacology Toxicology & Endocrinology* 100(1-2): 173-176.

## References

- Witbaard, R. and M. J. N. Bergman** (2003). "The distribution and population structure of the bivalve *Arctica islandica* L. in the North Sea: what possible factors are involved?" *Journal of Sea Research* 50(1): 11-25.
- Witbaard, R., R. Franken and B. Visser** (1997). "Growth of juvenile *Arctica islandica* under experimental conditions." *Helgolander Meeresuntersuchungen* 51(4): 417-431.
- Wong, W. H. and J. S. Levinton** (2004). "Culture of the blue mussel *Mytilus edulis* (Linnaeus, 1758) fed both phytoplankton and zooplankton: a microcosm experiment." *Aquaculture Research* 35(10): 965-969.
- Wood, H. L., J. I. Spicer and S. Widdicombe** (2008). "Ocean acidification may increase calcification rates, but at a cost." *Proceedings of the Royal Society B-Biological Sciences* 275(1644): 1767-1773.
- Wootton, J. T., C. A. Pfister and J. D. Forester** (2008). "Dynamic patterns and ecological impacts of declining ocean pH in a high-resolution multi-year dataset." *Proceedings of the National Academy of Sciences of the United States of America* 105(48): 18848-18853.
- Yin, Y., J. Huang, M. L. Paine, V. N. Reinhold and N. D. Chasteen** (2005). "Structural characterization of the major extrapallial fluid protein of the mollusc *Mytilus edulis*: Implications for functions." *Biochemistry* 44(31): 10720-10731.
- Zettler, M. L., Bönsch, R., Gosselck, F.** (2001). "Distribution, abundance and some population characteristics of the ocean quahog, *Arctica islandica* (Linnaeus, 1767), in the Mecklenburg Bight (Baltic Sea)." *Journal of Shellfish Research* 20: 161-169.
- Zhang, R. and C. Zhang** (2006). "Matrix Proteins in the Outer Shells of Molluscs." *Mar Biotechnol* 8(6): 572-86.
- Zhong, S. and A. Mucci** (1989). "Calcite and aragonite precipitation from seawater solutions of various salinities: Precipitation rates and overgrowth compositions." *Chemical Geology* 78: 283-299.
- Zielinski, S. and H. O. Pörtner** (2000). "Oxidative stress and antioxidative defense in cephalopods: a function of metabolic rate or age?" *Comparative Biochemistry and Physiology B-Biochemistry & Molecular Biology* 125(2): 147-160.

**Origin of pictures:**

**McConnaughey and Gillikin (2008):** figure I.1

**Frerk, Inga and Hiebenthal, Claas:** front page, figure 2.1 and figure 3.1

**Frerk, Inga, Kossak, Ute and Hiebenthal, Claas:** figure 3.2

## References

# Curriculum Vitae

## **Claas Hiebenthal**

geboren am 23. November 1976 in Stade

Staatsangehörigkeit: deutsch

Holtenauer Straße 109

24105 Kiel

## **Ausbildung und Berufliche Tätigkeiten**

- |                     |  |
|---------------------|--|
| seit 01/2006        | Promotion am IFM-GEOMAR, Kiel<br>dabei 5-monatige Elternzeit   |
| 05 bis 12/2005      | wissenschaftlicher Zeitangestellter in verschiedenen Projekten<br>am Leibniz Institut für Meereswissenschaften (IFM-GEOMAR)<br>in Kiel   |
| 09/2003 bis 11/2004 | Diplomarbeit: „Struktur und Diversität von<br>Aufwuchsgemeinschaften unter verschiedenen Störungs- und<br>Nährstoffregimes“<br>dabei 6-monatiger Forschungsaufenthalt in Südafrika |
| 10/1999 bis 03/2005 | Studium der Biologie an der Christian-Albrechts-Universität<br>Kiel<br>Hauptfach: Zoologie<br>Nebenfächer: biologische Meereskunde, Informatik                                     |
| 10/1998 bis 09/1999 | Studium der Biologie an der Georg-August-Universität<br>Göttingen  |
| 05/1996             | Abitur mit den Leistungskursen Mathematik und Biologie   |





Diese Arbeit wurde geprägt durch die interdisziplinäre und sehr interaktive Zusammenarbeit mit Kollegen und Kolleginnen aus mariner Biogeochemie, Physiologie und Benthosökologie.

**Kapitel 1** wurde unter dem Titel „Shell Growth, Fitness and Cellular Stress in Western Baltic Sea Bivalves *Mytilus edulis* (L.) and *Arctica islandica* (L.)“ mit Eva Philipp, Anton Eisenhauer und Martin Wahl als Koautoren zur Veröffentlichung bei der Fachzeitschrift *Journal of Experimental Marine Biology and Ecology* eingereicht.

Die Veröffentlichung der Kapitel 2 bis 5 ist mit folgenden Koautoren geplant:

**Kapitel 2:** Experimentally determined Shell Chemistry Characteristics ( $\Delta^{44/40}\text{Ca}$ ,  $D_{\text{Mg}}$  and  $D_{\text{Sr}}$ ) of young *Mytilus edulis* L. and *Arctica islandica* L. as possible Tracer for SST and Salinity

Florian Böhm, Anton Eisenhauer, Dieter Garbe-Schönberg und Martin Wahl

**Kapitel 3:** Ocean Acidification and Ocean Warming: How western Baltic Sea Bivalves *Mytilus edulis* (L.) and *Arctica islandica* (L.) can cope with CO<sub>2</sub>-provoked Changes

Eva Philipp, Anton Eisenhauer, Michael Tessmann und Martin Wahl

**Kapitel 4:** Mg / Ca and Sr / Ca ratios in shells of young *Mytilus edulis* L. and *Arctica islandica* L. formed under different temperatures and levels of acidification

Florian Böhm, Anton Eisenhauer und Dieter Garbe-Schönberg

**Kapitel 5:** Defence Capability of Western Baltic Sea Bivalves *Mytilus edulis* (L.) and *Arctica islandica* (L.) at two Global Change Scenarios

Yasmin Appelhans, Anton Eisenhauer und Martin Wahl



## Erklärung

Hiermit erkläre ich, dass diese Arbeit selbständig von mir angefertigt wurde und keine weiteren als die angegebenen Hilfsmittel und Quellen verwendet wurden. Ich habe bisher keinen anderen Promotionsversuch unternommen, und diese Arbeit hat weder ganz noch teilweise im Rahmen eines anderen Prüfungsverfahrens vorgelegen. Bei der Erstellung dieser Abhandlung habe ich mich an die Regeln guter wissenschaftlicher Praxis gehalten.