

**Significance of the third hypervariable region of the antibody
heavy (H) chain for antigen-specificity and expression of idiotypes
during the thymus-dependent immune response**

A dissertation submitted to the Faculty of Mathematics and Natural
Sciences of the Christian Albrechts University in order to acquire a
doctoral degree in biochemistry

by

Ahmad Trad

Kiel

September 2009

First reviewer: Prof. Dr. Stefan Rose-John

Second reviewer: Prof. Dr Thomas Roeder

Date of the examination: 10.11.2009

Approved for printing:

Dean

To my parents

Summary

Antigen-induced lymphocytic (adaptive) immune responses rely on a complex contact- and cytokine-mediated interplay of different cells. Hapten-carrier complexes as antigens have been employed to elaborate many characteristic features of this process, *e.g.* action of antigen-presenting cells, specificity of T (TCR) and B (BCR) cell antigen receptors, collaboration of T and B lymphocytes, function of T cell subpopulations, generation and selection of the primary repertoire, immune maturation through somatic hypermutation, class switch recombination and isotype regulation, to name the most important ones. One of the best explored antibody responses is that of BALB/c mice to the hapten 2-phenyl-oxazolone (phOx) after coupling to the thymus-dependent (TD) carrier chicken serum albumin (CSA). The latter response is characterized by the dominant Ox1 idiotype (Id_{Ox1}) which is encoded by the canonical VH171/V κ 072 gene combination and contains the typical amino acid sequence aspartic acid-arginine-glycine (DRG) in the middle of the third complementarity-determining region of the heavy chain (HCDR3). The affinity of Id_{Ox1} antibodies is 10-100-times higher than that of non- Id_{Ox1} antibodies and immune maturation is primarily based on the accumulation of somatic mutations in Id_{Ox1} antibodies. During memory responses, however, there is a repertoire shift to non- Id_{Ox1} antibodies encoded by alternative VH and/or VL genes. The propensity of non- Id_{Ox1} antibodies for somatic mutations is known.

According to the selection theory, many of these characteristics depend on the antigen-specificity of the antigen-binding site (paratope) of the BCR. In principle, two different processes participate in the generation of the BCR repertoire during the antigen-independent differentiation in the bone marrow, *i.e.* on the one hand, the recombination of the genomic variable (V), diversity-enhancing (D) and joining (J) genes and, on the other, a non-genetic enhancement of this genetic repertoire during V(D)J recombination by the action of three different enzyme systems. Exonucleases cut off terminal nucleotides, repair enzymes generate palindromic sequences (P nucleotides) and terminal deoxynucleotidyl-transferase (TdT) adds non-template nucleotides (N nucleotides) at random. In this way, an enormous non-genetic diversity is created at HCDR3 being large enough to allow efficient immune responses even when only a single VH and VL gene is available.

The experiments on the humoral anti-phOx response of DH mutant BALB/c mice, described in the present communication, were performed to elucidate how HCDR3-related non-genetic

and V gene-encoded genetic variability contribute to the thymus-independent type 2 (TI-2) and the TD response, primary TD repertoire, Id_{Ox1} dominance, class switch recombination, somatic hypermutation and immune maturation during memory TD responses. Two mutant BALB/c strains were available which harbored only one single DH gene in their genome instead of 13 DH genes in BALB/c wildtype (WT) mice. The DH gene segment of Δ D-iD mice codes for charged amino acids in HCDR3 while that of Δ D-D μ FS mice codes for hydrophobic amino acids. The phOx-Ficoll-induced TI-2 and the phOx-CSA-induced TD immune response of both strains were compared with that of BALB/c WT mice and analyzed at the level of single antibody-forming plasma cells and serum anti-phOx antibody formation. The quality of the TD response was analyzed with the aid of hybridoma monoclonal antibodies generated after early and late primary, secondary and tertiary immunization.

The following results were obtained:

A Quantitative aspects of the humoral anti-phOx immune response in DH mutant mice

- 1.) The analysis with fluorescence-activated cell sorting (FACS) revealed that the numbers of total nucleated cells, lymphocytes as well as T and B cells in the bone marrow of both mutant strains were comparable to BALB/c WT mice.
- 2.) However, in the spleens of Δ D-iD and Δ D-D μ FS mice, numbers of total mononuclear cells as well as both lymphocyte subpopulations were reduced to values of lower than 50 % of those found in WT mice.
- 3.) It is a striking result that the genetic alteration in both strains of mice also affects T cells although the genetic alteration is restricted to Ig genes and can thus not directly affect the germ line repertoire of TCR. In relation to and in accord with published data, this allows concluding that the T cell repertoire is indirectly controlled by B lymphocytes.
- 4.) The total immunoglobulin concentrations were reduced for IgM in Δ D-iD but not Δ D-D μ -FS mice while the IgG immunoglobulin class was clearly reduced in both strains.
- 5.) In contrast to these results, the background numbers of IgM but not IgG anti-phOx antibody-secreting cells were significantly *enhanced* in both DH mutant strains.
- 6.) The phOx-Ficoll-induced TI-2 response was comparable for the IgM and delayed for the IgG antibody response.
- 7.) The IgM production during the primary phOx-CSA-induced TD response was delayed and remained at lower maximal levels before falling back to similar low levels as in WT mice. IgG titers were severely suppressed during the entire primary response and remained at this lower level after secondary immunization.

B VH/VL sequence analysis of monoclonal hybridoma antibodies from the different phases of the humoral anti-phOx immune response in DH mutant mice

Genetic analysis of the phOx-reactive repertoire of Δ D-D μ FS mice

In the early primary response, the Id_{Ox1} gene combination is rarely used and not at all dominant. Antibodies with 5-100-times higher affinities than the normally dominant Id_{Ox1} occur. Usage of reading frame 1 (RF1), coding for hydrophobic amino acids, is counter selected during the generation of the primary repertoire of Δ D-D μ FS mice. The length of the middle portion HCDR3 varied from 1-12 amino acids. This may suggest that it is not of prime importance for the phOx-specificity. The more D gene nucleotides were eliminated by exonucleases during VDJ recombination in the course of generation of the pre-immune repertoire, the shorter the HCDR3 length will be.

In contrast to wildtype mice, the late primary anti-phOx antibodies contain an astonishingly high number of 56% non-switched IgM antibodies. Since a dominant clonotype did also **not** develop at this time point, this process obviously depends on the available DH gene repertoire and can not or only very rarely be generated from the non-natural DH gene of Δ D-D μ FS mice. An immune maturation is indicated by enhanced mutation rates in IgG antibodies, but the mutations do not accumulate in a particular clone. These antibodies preferably used germ line-related HCDR3 nucleotides sequences, but 'tried to avoid' RF1.

Antibodies obtained after secondary immunization showed again that class switch recombination is impaired in this mouse strain, that the phOx-specific B cell repertoire develops at random, that immune maturation occurs in individual, but not all Δ D-D μ FS mice and that a few individual mice may even generate Id_{Ox1} antibodies. The HCDR3 sequence (CAR-DGG-AYW) of one these Id_{Ox1} antibodies probably derived from the canonical Id_{Ox1} sequence CAR-DRG-AYW. Hence, although Δ D-D μ FS mice can generate the VH171/V κ 072 Id_{Ox1} gene combination, the Id_{Ox1}-specific DRG motive in the middle of HCDR3 can either not or only extremely rarely be generated.

An impaired class switch recombination is even observed after tertiary immunization since about one third of the established antibodies were of the IgM class. Id_{Ox1} antibodies did also not dominate the tertiary TD response. Instead, about one third of IgG antibodies were encoded by the VH/VL gene combination VH158/V κ 115 which has already been observed as a major clone in a memory response of BALB/c WT mice. During all phases (1° to 3°) of the TD anti-phOx response, Δ D-D μ FS mice 'try to avoid' coding of HCDR3 in RF1 causing hydrophobic amino acids. Instead, RF2 usage and generation of new nucleotide sequences during recombination favor HCDR3 loops which are rich in glycine and tyrosine.

Genetic analysis of the phOx-reactive repertoire of Δ D-iD mice with a charged HCDR3

In the early primary response of Δ D-iD mice, the restriction to a single DH gene segment coding for charged amino acids changed the pattern of VH/VL combinations and led to the appearance of some hitherto not observed variable genes. Neither Id_{Ox1} nor other clonotypes dominated. In some IgM and IgG antibodies affinities were enhanced by factors of 5-10. The bias against RF1 usage is not as pronounced as in Δ D-D μ FS mice. RF2 is not really dominant and in most of the antibodies the reading frame could not be assigned. These antibodies have shorter D-region lengths. B cells seem to escape the usage of charged HCDR3-loops by shifting the RF and an increased loss of nucleotides at the termini of DH gene, so that 53 % of the HCDR3 intervals contained no germ line-encoded DH nucleotides. Hydrophilic HCDR3 loops are strongly favored. Sequence comparisons showed that the Id_{Ox1} specificity relies not only on the DRG motive in the HCDR3 loop, but is also influenced in its 3-dimensional structure by other parts of the molecule.

The genetic repertoire of the late primary response of Δ D-iD mice is quite heterogeneous and there is again no dominant VH/VL gene combination. Id_{Ox1} antibodies were not observed. As in Δ D-D μ FS mice, a high amount of IgM-secreting cells at this time point indicates impaired class switch recombination in Δ D-iD mice. These late IgM-secretors showed almost no somatic mutations. Hence, the restriction in Δ D-iD mice to a single DH gene coding for charged amino acids in HCDR3 drastically inhibits the early immune maturation. The bias against RF1 usage was not as pronounced as in Δ D-D μ FS mice. RF2 and RF3 are least frequently used and antibodies with germ line non-related HCDR3 sequences are rather common. Non-assignable reading frames code for shorter D-region lengths. Late primary anti-phOx antibodies of Δ D-iD mice use mainly hydrophilic amino acids in HCDR3.

In the secondary response, it is again astonishing that an IgM antibody could be isolated already 3 days after secondary immunization with the TD antigen phOx-CSA. Enhanced mutations and an increased affinity of the IgG antibody indicated that secondary antibodies in Δ D-iD mice are derived from an immune matured repertoire.

In the tertiary response of Δ D-iD mice, a high percentage of naïve, non-mutated and non-matured IgM antibodies were obtained which thus resemble IgM antibodies from the primary response. In contrast to anti-phOx antibodies from earlier stages of TD immune responses, tertiary antibodies contained again VH171/V κ 072-encoded IgM and IgG Id_{Ox1} antibodies. The IgG Id_{Ox1} antibody contained somatic mutations and was affinity-matured. However, the Id_{Ox1} clonotype was not dominant and there was *no* other dominant clone. Usage of RF1

in HCDR3 was suppressed, but not avoided. RF2 and RF3 were not used and in a rather high proportion of antibodies, HCDR3 reading frames could not be assigned. Tertiary antibodies as those from earlier phases of the response reveal a selection of hydrophilic HCDR3-loops. The obtained sequences confirmed that the original Id_{Ox1} motive DRG is completely associated with the VHOx1 gene VH171.

Hence, the findings in the anti-phOx response of the 2 DH mutant mouse strains Δ D-D μ FS and Δ D-iD mice allow the following general conclusions:

- 1.) Under the conditions of a single artificial DH gene, the enzymatically created extraordinary variability at the third hypervariable region becomes visible. The data confirm previous findings that neutral amino acids like tyrosine and glycine are preferred in HCDR3.
- 2.) Since the T cell-mediated class switch-recombination as well as the expression of dominant B cell clonotypes obviously depends on the available DH genes it can be concluded that both processes are not only antigen-driven. This supports the further argument that T cells are involved in the selection of particular B cell clones and that this selection depends in a hitherto unknown way on particular HCDR3 sequences.
- 3.) A comparison with a large panel of anti-phOx antibodies from BALB/c WT mice (44 VH and 40 VL genes) revealed that DH mutant mice made use of 28 more VH and 12 more VL genes.

Further work in Δ D-D μ FS and Δ D-iD DH mutant mice, in comparison to BALB/c WT mice, must elucidate the precise T cell involvement in regulation of class switch recombination and HCDR3-dependent selection of IgG-secreting B cell clones.

Zusammenfassung

Antigen-induzierte lymphozytäre (adaptive) Immunantworten beruhen auf komplexen kontakt- und zytokin-vermittelten Wechselwirkungen verschiedener Zellen. Vielfach wurden Hapten-Träger-Komplexe als Antigene eingesetzt, die verschiedenen charakteristischen Funktionen der einzelnen Komponenten dieses Prozesses zu entschlüsseln, z. B. die Wirkung der antigen-präsentierenden Zellen, Spezifität der T- (TCR) und B (BCR) Zell Antigenrezeptoren, die Kooperation von T- und B-Lymphozyten, die Funktion der Subpopulationen der T-Zellen, die Entstehung und Selektion des primären Repertoires, die Immunreifung durch somatische Hypermutationen, den Klassenwechsel und die Isotypregulation, um die wichtigsten zu nennen. Eine der am besten erforschten Antikörper-Antworten ist die in BALB/c-Mäusen gegen das Hapten 2-phenyl-oxazolone (phOx) nach Kopplung an das thymus-abhängige (TD) Trägerprotein Hühnerserum-Albumin (CSA). Die Immunantwort gegen phOx-CSA ist durch den dominierenden Ox1 Idiotype (Id_{Ox1}) gekennzeichnet, der von der kanonischen VH171/V κ 072 Genkombination kodiert wird und die typische Aminosäure-Sequenz Asparaginsäure-Arginin-Glycin (DRG) in der Mitte der dritten hypervariablen Region der schweren Kette (HCDR3) enthält. Die Affinität der Id_{Ox1} -Antikörper ist 10-100-fach höher als die der Non- Id_{Ox1} -Antikörper und die Immunreifung beruht in erster Linie auf der Anhäufung von somatischen Mutationen in Id_{Ox1} -Antikörpern. Während der Gedächtnisantwort gibt es jedoch eine Repertoireverschiebung zu Non- Id_{Ox1} -Antikörpern, die durch alternative VH- und/oder VL-Gene kodiert sind. Die Neigung von Non- Id_{Ox1} -Antikörpern für die somatischen Mutationen ist bekannt.

Nach der Selektionstheorie hängen viele dieser Eigenschaften von der Antigen-Spezifität der Antigen-Bindungsstelle (Paratop) des BCR ab. Grundsätzlich sind zwei verschiedene Prozesse an der Entstehung des Antikörper-Repertoires während der antigen-unabhängigen Differenzierung im Knochenmark beteiligt, nämlich einmal die Rekombination der genomischen variablen (V), die Diversität erhöhenden (D) und der verbindenden (J) Gene und zum anderen eine nicht-genetische Erweiterung dieses genetischen Repertoires während V(D)J-Rekombination durch die Wirkung von drei verschiedenen Enzym-Systemen. Exonucleasen schneiden terminale Nukleotide ab, Reparatur-Enzyme generieren palindromische Sequenzen (P-Nukleotide) und die terminale Deoxynukleotidyl-Transferase (TDT) fügt zufällig nicht-kodierte Nukleotide (N-Nukleotide) hinzu. Auf diese Weise wird in der HCDR3 eine enorme nicht-genetische Diversität geschaffen, die ausreicht, eine effiziente Immunantwort zu ermöglichen, selbst wenn nur ein einziges VH- und VL-Gen vorhanden sind.

In der vorliegenden Arbeit werden Experimente zur humoralen Anti-phOx-Immunantwort von zwei transgenen BALB/c-Mäusestämmen beschrieben, welche jeweils nur ein DH-Gen enthalten. Ziel dieser Untersuchungen war es zu bestimmen, welchen Anteil die in HCDR3 beobachtete nicht-genetische und die auf VH/VL-Genen beruhende genetische Variabilität haben: an der thymus-unabhängigen Typ 2 (TI-2) und der thymus-abhängigen Immunantwort, dem primären TD-Repertoire, der Id_{Ox1}-Dominanz, dem Klassenwechsel, der somatischen Hypermutation und der Immunreifung während der TD Gedächtnisantwort. Zwei Mutanten des BALB/c-Mäusestammes standen zur Verfügung, die statt der 13 DH-Gene in BALB/c Wildtyp-Mäusen nur ein einziges DH-Gen in ihrem Genom tragen. Das DH-Gensegment der Δ D-iD Mäuse kodiert für geladene Aminosäuren in der HCDR3, während das DH-Gen der Δ D-D μ FS Mäuse für hydrophobe Aminosäuren kodiert. Die phOx-Ficoll-induzierte TI-2 und die phOx-CSA-induzierte TD-Immunantwort der beiden Stämme wurden auf der Ebene der einzelnen antikörper-bildenden Zellen und der Serum-anti-phOx Antikörperbildung analysiert und mit denen in BALB/c Wildtyp-Mäusen verglichen. Die Qualität der TD Immunantwort wurde mit Hilfe monoklonaler Antikörper, welche aus Hybridomen gewonnen wurden, analysiert, die nach früher und später primärer, sekundärer und tertiärer Immunisierung durch Zellfusion hergestellt wurden.

Die folgenden Ergebnisse wurden erhalten:

A Quantitative Aspekte der humoralen Anti-phOx Immunantwort in DH –Mutanten-Mäusen

- 1.) Die Analyse mittels Durchflusszytometrie (FACS) ergab, dass die Gesamtzahl der kernhaltigen Zellen, Lymphozyten sowie T- und B-Zellen, im Knochenmark der beiden Mutantenstämme vergleichbar war mit denen in BALB/c Wildtyp-Mäusen.
- 2.) Allerdings war die Gesamtzahl der mononukleären Zellen, ebenso wie der beider Lymphozyten-Subpopulationen in der Milz von Δ D-iD und Δ D-D μ FS Mäusen auf Werte von weniger als 50 % der Wildtyp-Mäuse reduziert.
- 3.) Bemerkenswerterweise wirkte sich die genetische Veränderung in beiden Mäusestämmen auch auf T-Zellen aus, obwohl die genetische Veränderung auf die Immunglobulin-Gene beschränkt ist und deshalb keine direkte Auswirkung auf das TCR-Keimbahn-Repertoire

haben kann. Das Ergebnis in Zusammenhang mit den publizierten Daten erlaubt die Schlussfolgerung, dass die B-Lymphozyten das T-Zell-Repertoire indirekt kontrollieren.

- 4.) Die IgM-Immunglobulin-Konzentrationen waren im Serum von ΔD -iD, nicht aber in ΔD D μ FS-Mäusen verringert, während die der IgG-Immunglobulin-Klasse deutlich in beiden Stämmen reduziert war.
- 5.) Im Gegensatz dazu war die Zahl der 'background' IgM-anti-phOx Antikörper-sezernierende Zellen in beiden DH Mutantenstämmen deutlich erhöht, nicht aber der IgG-sezernierenden Zellen.
- 6.) Verglichen mit BALB/c-Wildtypmäusen war die phOx-Ficoll-induzierte TI-2 Antwort vergleichbar für IgM, während die für IgG sich verzögert entwickelte.
- 7.) Die IgM-Produktion während der primären phOx-CSA- induzierten TD-Antwort verlief verzögert und blieb auf niedrigeren Maximalwerten, bevor sie auf ein ähnliches Niveau wie bei Wildtyp-Mäusen zurückfiel. IgG-Titer waren während der gesamten primären Antwort stark supprimiert und verblieben auf diesem niedrigen Niveau auch nach sekundärer Immunisierung.

B VH/VL Sequenzanalyse von monoklonalen Hybridom-Antikörpern aus den verschiedenen Phasen der humoralen Anti-phOx Immunantwort in DH Mutante Mäusen

Genetische Analyse des phOx-reaktiven Repertoires in ΔD -D μ FS Mäusen

In der frühen primären Immunantwort der ΔD -D μ FS-Mäuse (RF1 kodiert für hydrophobe HCDR3 Aminosäuren) wurde die Id_{Ox1} Genkombination VH171/V κ 072 selten benutzt und dominierte in keiner Weise. Antikörper traten auf, die 5–100-fach höhere Affinität als die normalerweise dominierenden Id_{Ox1}-Antikörper besaßen. Die Verwendung des RF1 war im primären Repertoire in ΔD D μ FS-Mäusen stark eingeschränkt. Die Länge des mittleren Teils des HCDR3 variierte von 1-12 Aminosäuren. Dies könnte darauf hindeuten, dass HCDR3 nicht von zentraler Bedeutung für die phOx-Spezifität ist. Je mehr Nukleotide vom DH-Gen durch Exonukleasen während der Entwicklung des Prä-Immunrepertoires durch VDJ Rekombination eliminiert werden, desto mehr verkürzt sich die Länge der HCDR3.

Im Gegensatz zu Wildtyp-Mäusen enthielten die späten primären Anti-phOx Antikörper einen erstaunlich hohen Anteil von 56 % IgM-Antikörpern. Da sich auch zu diesem Zeitpunkt kein dominanter Klon entwickelt hatte, folgt, dass eine solche Auswahl offensichtlich von dem zur Verfügung stehenden DH-Gen-Repertoire abhängt. Der Id_{Ox1}-Klon kann entweder gar nicht oder nur sehr selten aus dem artifiziellen DH-Gen der ΔD -D μ FS-Mäuse generiert werden. Dass eine Immunreifung stattgefunden hatte, wird durch eine erhöhte Anzahl von Mutationen

in IgG-Antikörpern angezeigt, aber die Mutationen sind nicht in einem bestimmten Klon akkumuliert. Die HCDR3-Nukleotidsequenzen basieren bevorzugt auf dem DH-Keimbahnen, RF1 ist aber unterrepräsentiert.

Antikörper, die nach sekundärer Immunisierung erhalten wurden, zeigten, dass die erneute Rekombination beim Klassenwechsel in diesen Mäusen beeinträchtigt ist, sich das phOx-spezifische B-Zell-Repertoire zufällig entwickelte, die Immunreifung in einzelnen aber nicht in allen Δ D-D μ FS Mäuse ablief und einzelne Mäuse sogar Id_{Ox1}-Antikörper mit der VH171/V κ -072 Gen-Kombination bilden können. Die HCDR3-Sequenz (CAR-DGG-AYW) eines dieser Id_{Ox1}-Antikörper leitet sich wahrscheinlich von der kanonischen Id_{Ox1}-Sequenz CAR-DRG-AYW ab. Das Id_{Ox1} spezifische DRG-Motiv in der Mitte der HCDR3 kann aber entweder gar nicht oder nur äußerst selten gebildet werden.

Eine Beeinträchtigung des Klassenwechsels war sogar nach tertiärer Immunisierung zu beobachten, denn etwa ein Drittel der etablierten Antikörper gehörte zur IgM-Klasse. Id_{Ox1}-Antikörper dominierten auch nicht in der tertiären TD Immunantwort. Stattdessen wurde über ein Drittel der IgG-Antikörper von der VH/VL-Gen Kombination VH158/V κ 115 kodiert, welche bereits einmal als ein dominanter Klon während der Gedächtnisantwort in BALB/c Wildtyp-Mäusen beobachtet worden war. In allen Phasen der primären bis tertiären Anti-phOx TD-Immunantwort in Δ D-D μ FS-Mäusen war die Kodierung der HCDR3 in RF1, welche hydrophobe Aminosäuren bedingt, unterrepräsentiert. Stattdessen führten die Verwendung des RF2 und die Bildung von keimbahn-unabhängigen Nukleotidsequenzen zu HCDR3-Schleifen, die reich an Glycin und Tyrosin sind.

Genetische Analyse des phOx-reaktiven Repertoires der Δ D-iD-Mäuse

In den frühen primären Antwort der Δ D-iD-Mäuse, deren in RF1 translatiertes DH-Gen für geladene HCDR3-Aminosäuren kodiert, war das Muster der VH/VL-Kombinationen geändert, und es wurden bisher nicht beobachtete V-Gene benutzt. Es dominierten aber weder Id_{Ox1}-Antikörper noch andere Klonotypen. Einige IgM- und IgG-Antikörper hatten 5-10-fach höhere Affinitäten als die normalerweise höchst-affinen Id_{Ox1}-Antikörper. Die Tendenz gegen eine Verwendung des RF1 war nicht so ausgeprägt wie in Δ D-D μ FS-Mäusen. Allerdings war auch RF2 nicht wirklich dominant, und in den meisten Antikörpern konnte der Leserahmen nicht zugeordnet werden. Die D-Regionen dieser Antikörper waren kürzer als es sonst beobachtet wird. Die B-Zellen scheinen die Verwendung von geladenen HCDR3-Schleifen einmal durch eine Verlagerung des Leserasters und zum anderen durch einen erhöhten Verlust von Nukleotiden an beiden Enden des DH-Gens zu vermeiden, so dass etwa 53 % der HCDR3-

Segmente keine keimbahn-kodierten Nukleotide enthalten. Dagegen sind hydrophile HCDR3-Schleifen stark begünstigt. Sequenzvergleiche zeigten, dass die Id_{Ox1}-Spezifität nicht nur durch das DRG-Motiv in der HCDR3-Schleife bedingt ist, sondern auch durch die 3-dimensionale Struktur anderer Teile des Moleküls beeinflusst wird.

Das genetische Repertoire der späteren primären Antwort der Δ D-iD-Mäuse ist sehr heterogen, und es zeigt wieder keine dominierende VH/VL Gen-Kombination. Id_{Ox1}-Antikörper wurden nicht beobachtet. Wie in Δ D-D μ FS-Mäusen zeigte der hohe Anteil an IgM-sezernierenden Zellen zu diesem Zeitpunkt, daß der Klassenwechsel auch in Δ D-iD-Mäusen beeinträchtigt ist. Die fast vollständig fehlenden somatischen Mutationen in diesen späten IgM-Antikörpern zeigen, daß die Beschränkung in Δ D-iD-Mäusen auf ein einziges DH-Gen, welches für geladene HCDR3-Aminosäuren kodiert, auch die frühe Immunreifung hemmt. Die Nicht-Verwendung des RF1 war nicht so ausgeprägt wie in Δ D D μ FS-Mäusen. RF2 und RF3 wurden am wenigsten verwendet, und Antikörper mit keimbahn-unabhängigen HCDR3-Sequenzen waren am häufigsten. Letztere Antikörper besaßen wiederum kürzere D-Regionen, und die späten primären Anti-phOx-Antikörper der Δ D-iD-Mäuse besaßen hauptsächlich hydrophile HCDR3-Aminosäuren.

In der sekundären Antwort erstaunte es wieder, dass ein IgM-Antikörper bereits 3 Tage nach Immunisierung mit dem TD-Antigen phOx-CSA isoliert werden konnte. Vermehrte Mutationen und eine erhöhte Affinität des IgG-Antikörpers weisen darauf hin, dass sekundäre Antikörper in Δ D-iD-Mäusen sich aus einem immungereiften Repertoire entwickeln.

In der tertiären Antwort der Δ D-iD-Mäuse wurde ebenfalls ein hoher Prozentsatz an naiven, unmutierten und ungereiften IgM-Antikörpern erhalten, die damit IgM-Antikörpern der primären Immunantwort ähneln. Im Gegensatz zu Anti-phOx-Antikörper aus früheren Phasen der TD-Immunantwort, waren unter den tertiären Antikörpern wieder VH171/V κ 072-kodierte IgM und IgG Id_{Ox1}-Antikörper zu finden. Der IgG Id_{Ox1}-Antikörper enthielt somatische Mutationen und war immungereift. Allerdings waren Id_{Ox1}-Antikörper nicht dominant, und es gab auch *keine* anderen dominanten Klone. Die Verwendung des RF1 in HCDR3 war zwar stark vermindert, aber nicht völlig unterdrückt. RF2 und RF3 wurden nicht benutzt, und in einem recht hohen Anteil von Antikörpern konnte das verwendete HCDR3-Leseraster nicht zugeordnet werden. Wie es auch schon in den frühen Phasen der TD-Immunantwort beobachtet worden war, zeigten die tertiären Antikörper eine Tendenz zu hydrophilen HCDR3-Schleifen. Die erhaltenen Sequenzen bestätigten, dass das ursprüngliche Id_{Ox1}-Motiv DRG vollständig mit der VHOx1 gene VH171 assoziiert ist.

Die Beobachtungen zur Anti-phOx-Immunantwort in den beiden DH-transgenen Mäusestämmen ΔD -D μ FS und ΔD -iD erlauben die folgenden allgemeinen Schlussfolgerungen:

- 1.) Unter den Bedingungen eines einzigen künstlichen DH-Genes wurde die außergewöhnliche Variabilität in der dritten hypervariablen Region der schweren Immunglobulinkette, welche durch die Wirkung von 3 Enzymsystemen bedingt ist, sichtbar. Die Daten bestätigen frühere Ergebnisse, dass neutrale Aminosäuren wie Tyrosin und Glycin in HCDR3 bevorzugt werden.
- 2.) Da sowohl die durch T-Zellen vermittelte erneute Genrekombination des Klassenwechsels als auch die Entwicklung eines dominanten B-Zellklons offensichtlich von den verfügbaren DH-Genen abhängt, kann man schließen, dass beide Prozesse nicht nur durch eine durch das Antigen vermittelten Selektion angetrieben werden. Dies unterstützt das weitere Argument, dass T-Zellen an der Auswahl von bestimmten B-Zell-Klonen beteiligt sind und dass diese Auswahl in einer bisher unbekanntem Art und Weise von bestimmten HCDR3-Sequenzen abhängig ist.
- 3.) Ein Vergleich mit einer großen Gruppe der Anti-phOx-Antikörpern von BALB/c Wildtypmäusen (44 VH- und 40 VL-Gene) ergab, dass in den DH-transgenen Mäusen weitere 28 VH- und 12 VL-Gene benutzt werden.

Es sind weitere Arbeiten in ΔD -iD und ΔD -D μ FS DH-transgenen Mäusen und der Vergleich mit BALB/c Wildtypmäusen erforderlich, die genaue Beteiligung der T-Zellen an der Regulation des Klassenwechsels und der HCDR3-abhängigen Selektion der IgG-sezierenden B-Zellklone aufzuklären.

Table of contents

Summary	I
Zusammenfassung	VI
Table of contents	XII
1 Introduction	1
1.1 Innate and adaptive immunity	1
1.2 Structure of B cell antigen receptor	4
1.3 Immunoglobulin-coding genes	6
1.3.1 Organization of the immunoglobulin λ and κ gene loci	7
1.3.2 Genomic organization of the heavy chain locus	8
1.4 Contribution immunoglobulin variable genes to the structure of variable regions	10
1.5 Structure of the third hypervariable region of heavy chain (HCDR3)	10
1.6 B cell development	13
1.7 Antibody response	14
1.8 Internal processing of antigen-induced immune responses	15
1.9 Characteristic features of the anti-phOx immune response in BALB/c mice	16
1.10 Mice carrying single DH gene segments	18
1.11 Aim of the work	20
2 Materials and methods	21
2.1 Materials	21
2.1.1 Buffer and media	21
2.1.2 Chemicals and instruments (all companies in Germany)	23
2.1.3 Antibodies	24
2.2 Methods	25
2.2.1 Mice	25
2.2.2 Preparation of hapten carrier complex (phOx-CSA)	25
2.2.3 Immunization	25
2.2.4 Collection of blood samples	26
2.2.5 Cell culture	26
2.2.6 Counting of cells	26
2.2.7 Thawing of cells	27
2.2.8 Freezing of Cells	27
2.2.9 Cell fusion	27
2.2.10 Determination of hybridomas secreting phOx-specific antibodies	28
2.2.11 Isolation of total RNA	29
2.2.12 Synthesis of complementary DNA	29
2.2.13 Polymerase chain reaction (PCR)	30
2.2.14 Agarose gel electrophoresis of DNA	31
2.2.15 Isolation of DNA from agarose	32
2.2.16 Determination nucleic acid concentration	33
2.2.17 DNA sequencing	33
2.2.18 Determination of serum anti-phOx antibody titers	33
2.2.19 Determination of relative affinity of phOx specific Abs	33
2.2.20 Idiotypic determination of phOx specific antibodies	34
2.2.21 Flow cytometric measurement	34
2.2.22 Flow cytometric staining of dead cells with 7-Amino-actinomycin D	35
2.2.23 Flow cytometric analysis	35
2.2.24 The enzyme-linked immunospot assay (Elispot)	36

2.2.25	Statistical analysis	36
2.2.26	Hydropathicity of the HCDR3.....	36
3	Results	37
3.1	Composition of B and T cell compartments in mutant mouse strains	37
3.2	Comparison of phOx-specific background plasma cells and serum antibody concentrations	42
3.3	Comparison of the humoral anti-phOx immune response in D-mutant and wildtype BALB/c mice.....	43
3.4	Analysis of variable genes of anti-phOx antibodies generated in Δ D-D μ FS and Δ D-iD mice	49
3.5	Genetic analysis of phOx-reactive antibodies generated from Δ D-D μ FS mice	50
3.5.1	Genetic analysis of the phOx-reactive repertoire of Δ D-D μ FS mice	50
3.5.1.1	Analysis of primary anti-phOx antibodies	51
3.5.1.2	Analysis of late primary anti-phOx antibodies	59
3.5.1.3	Analysis of secondary anti-phOx antibodies	63
3.5.1.4	Analysis of tertiary anti-phOx antibodies	68
3.5.2	Genetic analysis of the phOx-reactive repertoire of Δ D-iD mice.....	75
3.5.2.1	Analysis of early primary anti-phOx antibodies	75
3.5.2.2	Analysis of late primary anti-phOx antibodies	80
3.5.2.3	Analysis of secondary anti-phOx antibodies	85
3.5.2.4	Analysis of tertiary anti-phOx antibodies	87
4	Discussion	93
4.1	B cell development in DH mutant mice.....	97
4.2	Humoral immune responses in DH mutant mice	98
4.3	Comparison of anti-phOx repertoires in wildtype and DH mutant mice	100
4.4	D gene segments and homogeneity of immune responses.....	102
4.5	Selection of reading frames	109
4.6	Concluding remarks	112
5	References	113
6	Abbreviations.....	122
7	Appendix	124
	Acknowledgements.....	150
	Curriculum vitae	151
	Publications.....	152
	Declaration	153

1 Introduction

The immune system fulfills two major tasks, namely protection against foreign harmful invaders on the one hand and preservation of the inner integrity of the organism on the other. A variety of mechanisms enables the organism to fight infections by identifying and killing microbial pathogens which range from viruses to parasitic worms. A prerequisite for this action is that the immune system has to distinguish them from the organism's normal cells and tissues. Hence, the immune system has to and can distinguish *'Self'* from *'Non-Self'*. This ability not only allows the elimination of potentially harmful *'Non-Self'* molecules and microbes, but also to recognize and destroy abnormal cells that derive from host tissues by malignant transformation.

To survive a pathogenic challenge, several mechanisms have evolved that recognize and neutralize pathogens. Even unicellular organisms have rich arsenals of mechanisms for protection, such as restriction endonucleases [1]. Other basic immune mechanisms evolved in ancient eukaryotes and remain in their modern descendants, such as plants, fish, reptiles, insects, birds and mammals. These mechanisms include various antimicrobial peptides such as defensins [2], pattern recognition receptors, and the complement system. More sophisticated mechanisms, however, developed relatively recently with the evolution of vertebrates [3]. The immune systems of vertebrates enclose innate and adaptive immunity and consist of many types of proteins, cells, tissues, and organs which interact in an elaborate and dynamic network.

1.1 Innate and adaptive immunity

The mammalian body is susceptible to infection by many pathogens which, after contacting the host, establish a focus of infection. Since the pathogens differ greatly in their surface proteins and mechanisms of pathogenesis, hosts developed two defense systems, namely innate and adaptive immune responses. Both responses are able to distinguish *Self* from *Non-Self* but with different degree of specificity. Also the mechanisms of antigen recognition by both innate and adaptive immunity are very diverse. Cooperation between both types of immune responses is required to achieve optimal responses against pathogens.

Innate immunity represents the first line of host defense through effector mechanisms that act immediately on contact with the pathogen at any time. Innate immunity is relatively non-specific for a particular pathogen. Anatomic barriers like skin and physiologic conditions like low pH values of the stomach inhibit the entrance of pathogens and protect against viral and

bacterial colonization. Bacteria, viruses, and parasites that overcome this barrier are faced immediately with tissue macrophages equipped with surface receptors (*e.g.* Toll-like receptor) that recognize a limited number of molecular patterns common to a wide variety of pathogens [4]. This, in turn, leads to an inflammatory response, which causes the accumulation of phagocytic monocytes, neutrophils and macrophages at the site of infection [5].

Since the mechanisms of innate immune responses do not develop a memory, they are incapable to improve their ability to resist a subsequent challenge with either the same or a different pathogen. These mechanisms prevent the vast majority of infections from becoming established or to develop further to a state of disease. However, innate responses often fail to clear the infection. In that case, dendritic cells, macrophages and other antigen presenting cells (APC), activated in the early innate immune response, help to initiate the development of adaptive immune responses [6, 7].

Adaptive immune responses are carried out by B and T lymphocytes which can, in principle, interact with *Non-Self* as well as *Self* molecules with membrane-bound antigen-receptors, *i.e.* the B cell antigen-receptor (BCR) and the T cell antigen-receptor (TCR). Antigens are recognized by BCR and TCR in two fundamentally different ways. BCR is a membrane-bound immunoglobulin = antibody (see below) which can directly interact with the antigenic molecule. The TCR is composed of 2 polypeptide chains, being either α plus β or γ plus δ . This allows the classification of two large subpopulations of T cells. While $\gamma\delta$ T cells are able to recognize antigens directly (like B cells), $\alpha\beta$ T cells can only do so when peptide fragments of protein antigens are bound to major histocompatibility (MHC) molecules. Protein antigens can be taken up and degraded to peptide fragments by antigen-presenting cells (APC) of the innate immune system as well as B lymphocytes. Hence, $\alpha\beta$ T cells recognize inner peptides of proteins while B cells recognize the surface of antigens. Since lymphocytes express a huge repertoire of antigen-receptors, adaptive responses to pathogens are highly specific for particular molecules of such microbes and this interaction can provide long-lasting memory cell-mediated protection. Thus, a second attack with the same pathogen induces an adaptive response that develops much faster and stronger than the first.

Like innate immunity, adaptive immunity has the ability to distinguish between *Self* from *Non-Self* and responds, under normal physiological conditions, only to *Non-Self* molecules. However, occasionally, the system fails to make this distinction and reacts destructively

against the host's own molecules, giving rise to autoimmune diseases. In addition, many foreign molecules entering the body are harmless *per se*, but can activate pathogenic immune reactions under special conditions. Allergic conditions such as hay fever and asthma are examples of these deleterious adaptive immune responses against normally harmless foreign molecules.

Another distinction concerning adaptive immune responses carried out by B and T lymphocytes is that they mediate two broad classes of immune responses, humoral and cell-mediated responses, respectively. In the humoral response, antigen-activation of B cells induces their differentiation into plasma cells which secrete huge amounts of antibodies which circulate with the bloodstream. The protective function of these antibodies can be ascribed to different mechanisms. a) The binding of antibodies can inactivate viruses and microbial toxins by blocking their ability to bind to receptors on host cells. b) The formation of antigen-antibody complexes (immune complexes – IC) can activate secondary effector functions, *i.e.* activation of the complement system or marking invading pathogens for destruction, mainly by making it easier for phagocytic cells of the innate immune system to ingest them via cell membrane receptors for the constant Fc part of the antibody (Fc receptors = FcR) or complement receptors like those for C3b. c) Moreover, the formation of IC may induce further activation of T lymphocytes which supports the differentiation into memory T as well as B cells.

Cell-mediated or cellular immunity is mediated by cytotoxic T lymphocytes (CTL) which are able to kill virus-infected and tumor cells [8, 9]. Moreover, B cell responses to protein antigens need the help from T cells. Thus, proteins are so-called thymus-dependent (TD) antigens which induce CD4⁺ T helper (T_H) cells. Their interaction with B cells depends on recognition of an antigenic peptide presented by MHC class II molecules on the membrane of the B cell. Helper T cells can further be subdivided into T_H1 cells secreting as major cytokines interleukin 2 (IL-2) and interferon γ (IFN- γ) and T_H2 cells secreting cytokines like IL-4, -5, -10 and -13 [10]. This cytokine network decides, for instance, about class switch recombination from primarily activated IgM-producing plasma cells to different IgG subclasses, mutual inhibition of T_H cell subpopulations and regulatory feedback to antigen-presenting cells. This complex cellular interplay is, in addition, regulated by CD8⁺ suppressor / regulatory T cells [11].

1.2 Structure of B cell antigen receptor

The B cell antigen receptor, immunoglobulin or membrane-bound antibody, is a heterodimeric protein composed of two heavy (H) chains which are connected via disulfide bonds and two light (L) chains each of which is likewise bound via disulfide bridges to one of the H chains. The prototypic Y-shaped structure of the secreted form of an antibody is depicted Fig. 1. Thus, the transmembrane domains are omitted. Both chains are composed of one or more constant regions (or domains) that define their class- and subclass-dependent effector functions and one variable region that determines antigen specificity and affinity [12]. Immunoglobulins exist in several isotypic variants, the antibody classes IgM, IgD, IgG, IgA and IgE which are characterized by the constant parts of the heavy chains. They are designated μ for IgM, δ for IgD, γ for IgG, α for IgA and ϵ for IgE antibodies. In addition, IgG can be subdivided in 4 subclasses, namely IgG1-4 in humans and IgG1, 2a, 2b and 3 in mice. IgA appears in 2 subclasses, IgA1 and 2. There are 2 types of L chains named κ (kappa) and λ (lambda).

Each of the variable domains of the heavy chain (VH) and the light chain (VL) contain 3 hypervariable (hv) or complementarity-determining regions (CDR). Since the immunoglobulin domains are folded in a secondary structure with 2 β -folds, the CDRs of each chain point into one direction. Together, they form the antigen-binding site = paratope which recognizes and binds the antigenic determinant = epitope. The location of the paratope-forming 3 VL and 3 VH CDRs are depicted in Fig. 2. The third CDR of the heavy chain (HCDR3) is especially important for a specific binding of the antigen. Together with the LCDR3, HCDR3 forms the center of the paratope. The immune system is able to create an extraordinary variability at HCDR3 (see below). Whereas variable domains allow specific recognition of the antigen, constant domains define the effector functions [12]. The C domains are directly germ line encoded, whereas V domains are created *de novo* by means of a complex series of gene rearrangement events in developing B cells [13].

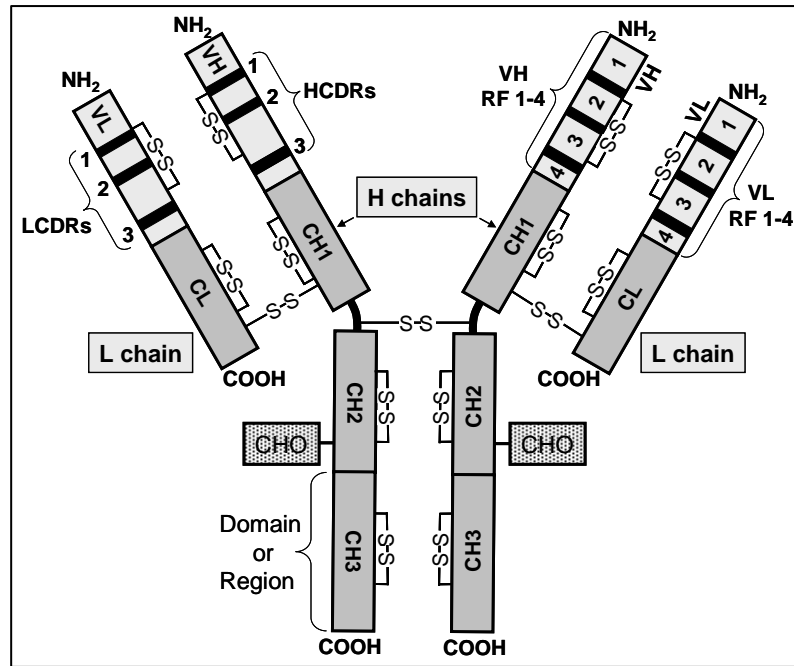

Figure 1

Schematic drawing of a typical antibody molecule

Each antibody consists of four polypeptides: two heavy and two light chains held together by disulfide bridges (S-S). The variable (VL and VH) domain gives the antibody its specificity for binding, while the constant domains (CL, CH1, CH2, and CH3) determine the antibody isotype. The variable region is further subdivided into hypervariable (hv) or complementarity-determining regions (CDR) and framework (FR) regions. Within light and heavy chains, there are three CDR regions: CDR 1, 2 and 3 and four FR regions: FR1, 2, 3, and 4 which separate the hv regions. The 6 CDRs in the N-terminal (NH₂) V domain of both H and L chains form the antigen binding site, whereas at the C-terminal (COOH) of CH domain is the Fc region which mediates different physiological effector functions of antibodies. All antibodies are glycosylated at conserved positions in their constant regions. The carbohydrates are indicated by (CHO).

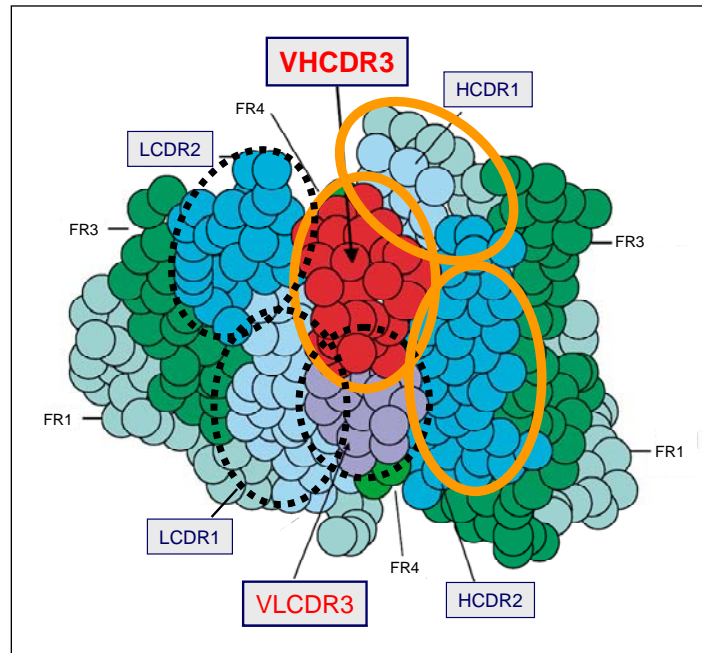

Figure 2

Schematic drawing of antigen binding site

The framework regions (FRs) form beta-sheet structures which hold the complementary-determining regions (CDRs) of L (black dotted ellipsis) and H (orange ellipsis) chains in the correct position to form the antigen binding site or paratope. The CDR3s of L and H chains make up the center of antigen binding site and they are surrounded by LCDR1 and 2 from one site, and from other site by HCDR1 and 2. The paratope makes various contacts with epitope (adpted from [29])

1.3 Immunoglobulin-coding genes

The adaptive immune system is remarkable for its ability to respond to a seemingly unlimited variety and number of antigens, including synthetic antigens which do not occur in nature. This characteristic depends on the capacity of lymphocytes to create highly diversified antigen receptor repertoires [13]. The variable regions of the 2 polypeptide chains of B as well as T cell antigen receptors are encoded in different ways. One chain of the antigen receptor, *i.e.* the BCR light chain and the TCR α chain, is encoded by variable genes (coding for about 100 amino acids) and smaller J gene segments (coding for about 10 amino acids) which, after recombination, enable joining with the constant genes. The other chain of antigen receptors, *i.e.* BCR heavy chain and the TCR β chain, is likewise encoded by variable genes and J gene segments, but between both genetic elements there are small diversity-enhancing D gene segments interspersed.

1.3.1 Organization of the immunoglobulin λ and κ gene loci

Each genetic locus coding for one of the three constant regions, *i.e.* λ and κ light chains and the heavy chain, has its own group of variable genes. This is due to the fact that the different genetic loci for Ig λ , Ig κ and IgH chains are located on different chromosomes.

The mouse λ locus on chromosome 16 contains only three functional V_λ genes ($V_{\lambda 1}$, $V_{\lambda 2}$ and $V_{\lambda 3}$) and two C_λ genes, each with its associated J_λ gene segments [14]. The organization of the λ locus also allows for few rounds of V_λ - J_λ rearrangement, in this case between an up-stream V_λ and a downstream J_λ - C_λ cluster. V_λ elements are flanked by 'two-turn' spacers and J_λ by 'one turn' spacers (Fig. 3), limiting the likelihood of V_κ - J_λ or V_λ - J_κ rearrangements. Because of the few variable genes in this locus, λ -encoded antibodies contribute very little to the germ line repertoire. This correlates to the minimal occurrence of only 5 % of antibodies with λ L-chains while the rest of 95 % contains κ L-chains.

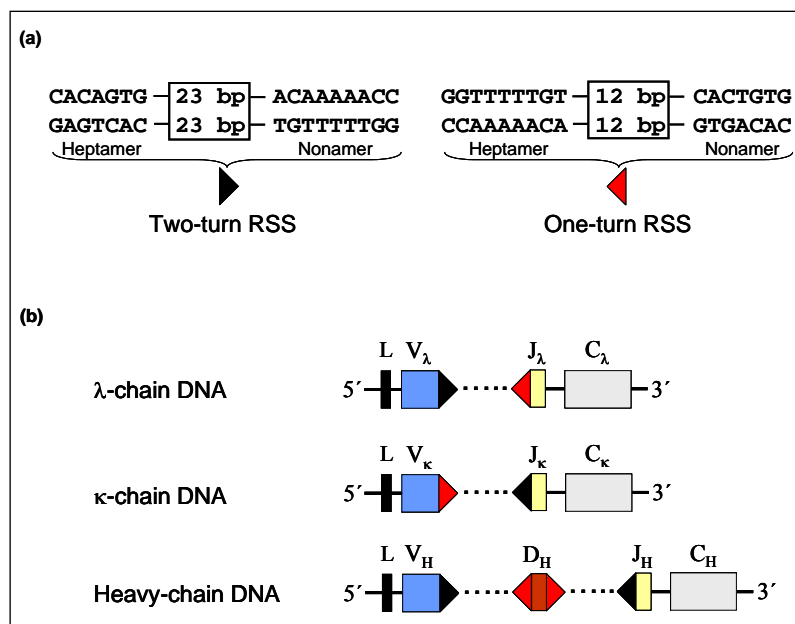

Figure 3

Recombination signal sequences

(a) DNA nucleotide sequences of recombination signal-sequences. Each recombination signal sequence contains a conserved heptamer (7 nucleotides) and a conserved nonamer (9 nucleotides) motif separated by a 'spacer' of either 12 (one-turn) or 23 (two-turn) base pairs.

(b) Location of RSSs in germ-line immunoglobulin DNA. Each V and J chains is jointed with one RSS (one-turn or two-turn depends on the isotype) at 3' and 5', respectively, whereas the D_H segment is flanked by one-turn RSS at 3' as well as one-turn at 5' for joining to the J gene segment and the V gene.

The mouse V_{κ} locus is located on chromosome 6 and contains up to 211 expressed V_{κ} gene segments [14]. The J_{κ} locus contains four functional genes ($J_{\kappa 1}$, $J_{\kappa 2}$, $J_{\kappa 4}$, $J_{\kappa 5}$). $J_{\kappa 3}$ is a non-functional pseudo-gene. The mouse κ locus contains only one C_{κ} element. Joining of one of the V_{κ} genes with one of the J_{κ} segments is mediated by recombination signal sequences (RSS) at the 3' end of V_{κ} genes and 5' end of J_{κ} (Fig. 3) [15]. As in the λ locus, the RSS contain a highly conserved heptamer sequence separated from a less conserved nonamer sequence by 12 or 22/23 base pair intervals termed spacers. Each spacer region serves to separate the heptamer and nonamer sequences by either one (12 base pairs) or two (22/23 base pairs) turns of the DNA helix. Rearrangement of a 'one-turn' spacer with a 'two turn' spacer is strongly favored. In contrast to the λ locus, the V_{κ} genes are flanked by a 'one-turn' spacer and J_{κ} gene segments are flanked by a 'two-turn' spacer (Fig. 3). Each of the V_{κ} gene segments has the potential to rearrange with any one of the J_{κ} gene segments. V_{κ} genes, as well as V_H and V_{λ} , can be grouped into families of related sequences that by definition share greater than 80 % identity with each other. Expressed V_{κ} genes in mouse can be grouped into eighteen families that contain as few as one and as many as 22 different elements. The members of these families are partially clustered in the locus, and a large number of them is inverted in relation to their orientation to the J_{κ} gene segments. The organization of the κ locus provides abundant opportunity for multiple rearrangements. Up to three rounds of sequential upstream V_{κ} to downstream J_{κ} recombination can occur by deletion and inversion.

1.3.2 Genomic organization of the heavy chain locus

The murine IgH locus spans approximately 3 Mb near the telomeric end of chromosome 12. The V_H genes lie about 100 kb 5' of the J_H segments, and the distance between two adjacent V_H genes is 12-15 kb [16]. It has to be stressed that, among the various strains of mice, there is considerable variation in the number as well as the sequence of the IgH gene segments. In BALB/c mice (one of the best characterized mouse strains), more than 700 genes can be grouped into 15 different families arrayed over 2.7 Mb. V_H genes that lie closer to the D_H gene segments have been termed proximal whereas V_H genes lying further upstream have been termed distal (Fig. 4) [14]. V_H and J_H gene segments are flanked by 'two-turn' spacers (Fig. 3), whereas D_H gene segments are flanked by 'one-turn' spacers. The D_H gene segments have the potential to be read in any of six different reading frames, depending on whether rearrangement proceeds by deletion or by inversion. Fusions of 2 D gene segments (D - D fusions) have also been observed, but they are rare. Importantly, the 3' terminus of a

VH gene contains an embedded cryptic heptamer sequence that is mostly preserved after initial V/D/J rearrangement. This sequence can be used to replace a particular VH gene sequence. Such a replacement is named receptor editing when happening during the antigen-independent differentiation in the bone marrow, but receptor revision when it takes place in the periphery after stimulation by antigen [17, 18].

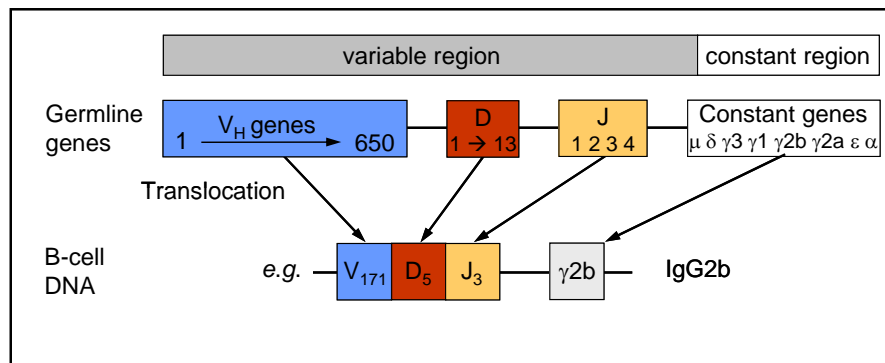

Figure 4

Construction of heavy chains

The heavy chain of an antibody is composed of V and C domains. The BALB/c genome includes 650 V_H genes, 13 D_H segments, 4 J_H gene segments, and 8 constant genes (μ, δ, γ3, γ1, γ2b, γ2a, ε, and α). A functional heavy chain of a mature B cell is encoded by one particular V_H (blue), one D_H (red), one J_H (orange) and a constant gene. In this example, V_H 171, D_H 5 and J_H 3 are joined to γ2b constant domain to generate an IgG2b antibody.

The members of the murine V_H and D_H families tend to be located in clusters of related sequences. This contrasts to the situation in humans, where in both the V_H and the D_H loci, family members are interspersed within other families. Murine members of the V_H5 (7183) and V_H2 (Q52) families are J_H proximal, whereas genes of the V_H1 family are most distal and account for more than 50 % of the active V_H repertoire. Studies of the Ig repertoire suggested that the V_H1 family of C57BL/6 mouse consists of ~ 200 closely related members [19]. However, the exact number of V_H1 genes of BALB/c mouse remained unclear [20-22].

The BALB/c haploid genome contains 13 active D_H and a cluster of four active J_H segments, which are located about 7 kb 5' of the C_H genes [22], while the C57BL/6 haploid genome contains only an estimated 101 functional V_H, 9 D_H, and 4 J_H gene segments. The D_H gene segments can be grouped into four families: (a) DFL which in BALB/c mice consists of the 16.1 and 16.2 gene segments and in C57BL/6 only of DFL16.1, (b) DSP consists of nine gene segments in BALB/c, but only six in C57BL/6, (c) the singleton DST4 gene segment and (d)

DQ52. DFL16.1 is most distal from JH (80 kb), whereas DQ52 is adjacent to JH1 (ca. 1 kb) [23, 24].

The mouse C_H gene locus consists of the eight constant genes in the following order: 5'- C_μ - C_δ - $C_{\gamma 3}$ - $C_{\gamma 1}$ - $C_{\gamma 2b}$ - $C_{\gamma 2a}$ - C_ϵ - C_α -3' that cluster in a 200-kb region and code for μ , δ , $\gamma 3$, $\gamma 1$, $\gamma 2b$, $\gamma 2a$, ϵ and α chains. In the mouse C_H gene locus there are no stop codon-containing conserved pseudogenes [22, 25].

1.4 Contribution immunoglobulin variable genes to the structure of variable regions

The VH region is encoded by the three separate DNA segments VH, DH, and JH genes or gene segments [26]. Consequently, the complete active VH domain is generated by two somatic recombinations, VH-DH and DH-JH joining. In contrast, VL regions of both types of L-chains are encoded by only two segments, VL and JL genes. Each newly formed VH and VL domain contains 4 intervals with relatively constant sequences which are named framework regions (FRs) (Fig. 1). They are separated from each other by three hypervariable intervals (complementarity determining regions or CDRs). The FRs encode the anti-parallel strands that make up not only the core β -barrel structure of the V but also the C domains. The first 2 hypervariable regions CDRs 1 and 2 of both, VH and VL regions are encoded by the V genes and form the outside borders of the antigen binding site (Fig. 2) [27]. In contrast, the third hypervariable regions HCDR3 and LCDR3 are created by VDJ and VL recombination, respectively. Both build the center of the antigen binding site (Fig. 2) [28].

1.5 Structure of the third hypervariable region of heavy chain (HCDR3)

After differentiation in the bone marrow, the initial diversity in antibodies is primarily concentrated at the joining sites of V, D and J segments thereby creating HCDR3. The extraordinary diversity of CDR3 of VH is created during the recombination process by the action of several enzyme systems (Fig. 5). The products of recombination-activating genes 1 and 2 (RAG-1 and RAG-2 proteins) accomplish the association of RSS of the involved gene segments and cutting off the loops. However, the hair-pin loops of both double-stranded DNA ends are mostly not ligated properly. Before the single DNA strands are connected by ligases, other enzymes modify both ends. First, exonucleases cut off nucleotides from the coding sequences at the 3' end of VH, the 5' and/or 3' end of DH and or the 5' end of JH (Fig. 5c).

Secondly, the hair-pins may be opened asymmetrically in such a way that sticky ends are created which together form a palindromic sequence. Therefore, the subsequently filled in nucleotides of the second strand are termed P nucleotides (Fig. 5a). Third, during the recombination process, so-called non-germ line encoded nucleotide sequences (N nucleotides) are inserted by the enzyme terminal deoxynucleotidyl transferase (TdT) at the DH-JH and the VH-DH border (Fig. 5b). Furthermore, the BALB/c DH locus encloses 13 diversity DH segments, which can be used, at least theoretically, in 6 different reading frames (RFs). As an overall result, only the middle part of the HCDR3 sequence is encoded by variable parts of a given DH gene while parts at the border are generated through random nucleotide sequences inserted during the recombination process [12]. The inserted nucleotides provide the opportunity to create totally random HCDR3 sequences, indicating that HCDR3 is not restricted to the genomic nucleotide repertoires of the DH gene segments. The recombination process at HCDR3 is so multifaceted that it is not possible to deduce the original DH germ line gene segment in a rather high percentage of antibodies [29].

In several murine immune responses, the vast majority of antibodies use DH reading frame 1 (RF1) which favors tyrosine and glycine residues [30]. It has been argued, that the preference for RF1 usage can be explained by the fact that RF1 of mice DH gene segments encodes neutral amino acids, while RF2 and RF3 are counter selected on the basis of stop codons and/or hydrophobic encoded nucleotides [31, 32]. Hence, such antibodies are eliminated by secondary regulatory mechanisms. This is indicated by the finding, that many auto-reactive antibodies are distinguished from non-pathogenic antibodies only by HCDR3 through insertion of P/N nucleotides or usage of alternative DH reading frames [33]. Hence, the restriction of HCDR3 plays a critical role in controlling autoimmune diseases [34]. Thus, under normal conditions, the central amino acids of HCDR3 are usually derived from the nucleotides encoded by RF1 of DH gene segments. Moreover, a preferential usage of some DH gene segments restricts the HCDR3 repertoire [35]. In fact, HCDR3 of fetal antibodies are shorter than in antibodies produced in later life [36]. This is due to low or no expression of TdT (lack of N nucleotides) and usage of short DH gene segments.

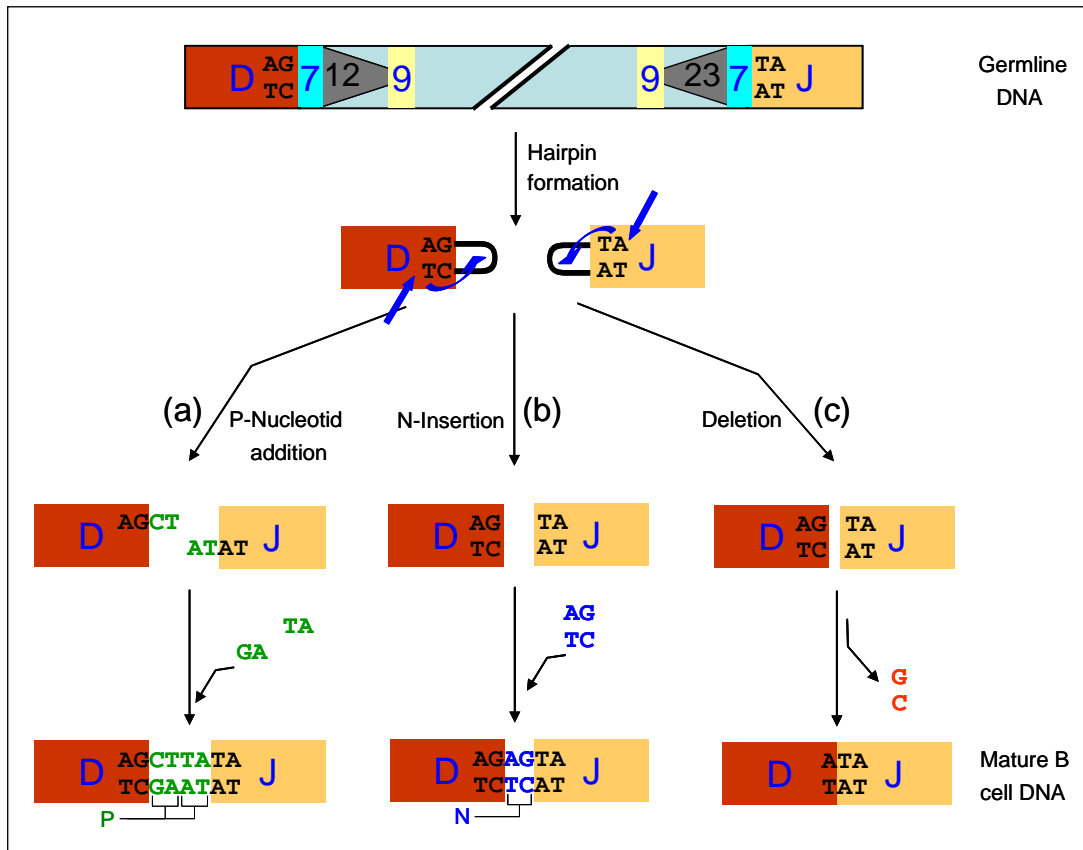

Figure 5

Imprecisions during DH-JH recombination

V(D)J recombination is mediated by the 2 RAG enzymes which cleave out the recombination signal sequences (RSS). However, during the recombination of DH-JH and its subsequent joining with a particular VH gene, the genomic sequences of the involved genetic elements are modified by three different mechanisms.

a) The resulting DNA hairpins may be opened asymmetrically in such a way that sticky ends are generated which may contain DNA palindromic sequences. Such P-nucleotides (green) are encoded by the complementary strand.

b) Nucleotides are added by terminal deoxytransferase (TdT) at random before complementary pairing occurs. Since these nucleotides are not encoded in the germ line they are termed N-nucleotides (blue) or N region insertions.

c) During this process, exonucleases cut off nucleotides (red) at the ends of the involved gene segments.

All three variability-enhancing mechanisms also occur during the recombination processes of joining between VH-DH and VL-JL.

Several reports have demonstrated that the HCDR3 is especially important and decisive for the determination of antigen-specificity of antibodies. Transgenic mice carrying a single functional VH gene but a full DH diversity repertoire are able to generate efficient immune responses to a variety of antigens. Antibodies generated in these mice, share the same VH and VL gene and differ only at HCDR3 [37]. Furthermore, mice lacking TdT (TdT^o) [38] show

drastically reduced BCR and TCR repertoires similar to that found in fetuses, where the TdT is not or minimally expressed [29, 39]. Interestingly, the responses to TD and TI antigens are very similar in TdT^o and control WT mice. Moreover, several studies have demonstrated that CDR3s of the TCR are crucial for antigen-recognition by T cells [37, 40]. Thus, it was concluded that HCDR3 determines antigen-specificity, while CDR1 and 2 play a role in the cross-reactivity [37].

1.6 B cell development

Mammalian B lymphocytes are derived from the primary lymphoid organs fetal liver and bone marrow, while B cells in birds are generated in the bursa of Fabricius. B cell development is a linear progression of defined stages characterized by assembly of the BCR from different genetic elements. This differentiation in the bone marrow is an intrinsic ability of the system and occurs independently of external antigens [41]. The assembly of the BCR begins in the H chain locus in pro-B cells. At first, one of the 13 DH segments (in BALB/c mice) is recombined with one of the available 4 JH gene segments with the aid of RAG1 and RAG2 proteins. In the early pre-B cells, a VH gene is joined to previously established DHJH segment, completing the rearrangement of the IgH locus by production of heavy chain of the μ isotype. The further successful association of the μ chain at pre-B cell stage with a surrogate light chain (SLC) correlates with the downregulation of transcription of RAG1 and RAG2 genes. SLC is a heterodimer composed of two peptides $\lambda 5$ and VpreB. $\lambda 5$ and VpreB show homology to lambda constant and variable regions, respectively. SLC combine with μ chain to form pre-B cell receptor complex (pre-BCR). In the late pre-B cell, reactivation of RAG1 and RAG2 allows L chain rearrangement. Typically, V κ -J κ recombination precedes V λ -J λ joining. Successful association of an in-frame L chain with the endogenous μ chain forms membrane bound molecules (mIgM), establishing immature B cells [42]. If the expressed IgM is not properly assembled or is auto-reactive, the interaction with self-antigens may induce either receptor editing by a secondary gene rearrangement to produce non-auto-reactive BCR, or the cells die by apoptosis in order to avoid autoimmunity [43]. If the cells pass this check point, an alternative splicing is induced which leads to co-expression of IgD at the surface. These mature B cells, which have survived negative selection in the bone marrow, leave the bone marrow via the blood stream and colonize the secondary lymphoid organs. In the periphery, they can receive positive selection signals necessary for further differentiation and maturation [44]. Depending on the nature of the antigen, mature naïve B follow different

destinations. Cells failing a renewed check of self-reactivity may undergo receptor revision changing the specificity of their BCR, convert to anergic (non-responsive), or may be deleted by apoptosis. B cells reacted with thymus-independent (TI) Ag will differentiate into plasma cells producing mostly IgM isotype. Anti-thymus-dependent (TD) Ag B cells receive additional stimulations from T_H cells necessary for hypermutation and class switch. Anti-TD antigen-specific B cells can differentiate into Ab secreting plasma and memory B cells.

1.7 Antibody response

The specific interaction between antigens and BCR on particular B cells is the basis for the clonal selection theory. The reactive B cells are activated to proliferation and differentiation into plasma cells that synthesize and secrete antibodies with identical specificity as the original BCR. Some antigens are capable of inducing a rapid antibody response that does not require T-cell help. There are of two types of the thymus-independent (TI) antigens. TI-1 antigens (*e.g.* bacterial lipopolysaccharide) can specifically be recognized by the B cell receptor (BCR) and, in a more non-specific way, by toll-like receptors (TLRs). Recognition by this second receptor induces proliferation and differentiation of the B cells. Another group of TI antigens is typically composed of repetitive carbohydrate (*e.g.* pneumococcal polysaccharide) or protein epitopes present at high density on the surface of a microorganism. These TI-2 antigens can extensively cross-link the antigen receptors and co-receptors on the B-cell surface. The rapid TI humoral responses are largely brought about by B-1 and marginal zone (MZ) B cells which produce predominantly IgM antibodies [45]. While TI-1 antigens do not induce generation of immunological memory, it is generally assumed that responses to TI-2 antigens include a long-term memory effect [46].

In contrast, thymus-dependent (TD) antigens require T helper (T_H) cells to stimulate antibody production. TD antigens must first be bound and internalized by antigen-presenting cells (APC) where they are enzymatically fragmented (processed). Peptide fragments are then presented by MHC class II molecules to antigen-specific T cells in order to activate them. Thus, interaction of T_H and B cells depends on recognition of the MHC class II-bound peptide by the TCR and simultaneous interaction of the MHC class-II on the B cells with CD4 on the T cell, *i.e.* T_H -B cell interaction is MHC class II-restricted. The successful interaction of both cell types leads to antibody production and secretion by plasma cells. The first antibodies made after TD antigen priming are of the IgM class. With continued T_H B-cell stimulation activated B cells undergo isotype switching, somatic hypermutation, and affinity maturation

within the germinal centers of secondary lymphoid organs, resulting in secretion of IgG antibodies with increased affinity/avidity for the inducing antigens. In addition, stimulation with TD antigens generates long lived plasma cells migrating to the bone marrow and induces B/T memory cells. While long lived plasma cells are capable to secrete specific antibodies for several months without antigen [47], memory B/T cells are fundamental for secondary and further immune responses providing efficient protection for many years [45, 48].

1.8 Internal processing of antigen-induced immune responses

The immune system does not only respond to the stimulation by external antigens, but develops a “*balance between the processing of foreign antigens and well-balanced self-reactivity*” [49]. This is achieved by idiotypic interactions: When antigen-reactive antibodies (idiotypes or Ab1) from one animal (rabbit, mouse) were used to immunize another animal, this produced Abs reacting with individual specificities of the injected idiotypes (anti-idiotypes or Ab2). Ab2 could stimulate anti-anti-idiotypes (Ab3) in a third animal, and Ab3 could stimulate anti-anti-anti-idiotypes (Ab4) in a fourth animal. This idiotypic cascade also proceeds within a particular immune system and the adaptive immune system functions as an idiotypically connected network [50]. Antibodies at each step of the idiotypic cascade represent a polyclonal collection and each clone expresses multiple idiotypic epitopes (idiotopes). Hence, every clone of a particular collection, *e.g.* Ab1, has a counterpart among Ab2s. Nevertheless is the collection of Ab3s not identical with that of Ab1s and, likewise, Ab4s are not identical with Ab2s. In a minority of investigations only, low amounts of antigen-reactive Ab1’ antibodies were found among Ab3s after immunization with Ab2. Hence, the induction of anti-idiotypes does not only depend on mutual recognition, but is also dictated by regulatory properties within the idiotypic network. This regulation depends largely on helper and regulatory T cells (T_{reg}) recognizing BCR as well as TCR idiotopes. The induction of autologous anti-idiotypic (aId) immune responses demonstrates that the immune system develops *no* tolerance to the idiotopes of its own antigen-receptors. Therefore, the pre-immune repertoire as well as that of antigen-activated B and T cells is regulated by idiotypic interactions [50-52]. For instance, in the thymus-independent type 2 response to $\alpha(1\rightarrow3)$ dextran, T_{reg} restrict the response to two major idiotypes and inhibit a class switch-recombination to IgG [53]. The involved T_{reg} cells are *not* antigen-, but Id-specific and recognize the HCDR3 region of the major J558 Id in an I-E^d-restricted manner [53]. Since these Id-specific T_{reg} do not arise in germ-free mice even when transferred to a normal environment at an age of 8 weeks it can be concluded that they were neonatally induced by contact with microbial antigens and persisted for

a long period of time. Hence, idiotypic regulation is evidently of particular importance during early ontogeny and it has been hypothesized that maternal antibodies play a major role by inducing an immunological imprinting which directs the future development of the immune system until adulthood.

1.9 Characteristic features of the anti-phOx immune response in BALB/c mice

The molecular events during the onset and the maturation of immune responses have mostly been studied with model antigens composed of hapten carrier complexes. Thymus-dependent immune responses to several hapten-coupled proteins are characterized by dominant idiotypes. It is only this circumstance that allowed tracking of the fate of particular primarily activated clones during secondary and tertiary responses. Hence, these systems were fundamental for detection of somatic hypermutation during TD responses as the underlying mechanism of immune maturation. One of the best studied systems is the TD response of BALB/c mice to the hapten 2-phenyl-oxazolone (phOx) after coupling to chicken serum albumin (CSA) as a carrier [54, 55].

The analysis of VH/VL sequences of a large number of hybridoma-derived antibodies allowed the construction of genealogical trees of antibodies activated during sequential steps from primary to memory responses [54, 56]. Analogous confirming data have been obtained in several other experimental systems including responses to other haptens like p-nitrophenyl-acetyl (NP) [57] and phenylarsonate (Ars) [58, 59], and protein antigens [60, 61].

The primary TD anti-phOx response in BALB/c mice is characterized by a dominant clone, the Ox1 idio type or Id_{Ox1}. On day 7 after primary immunization, about 75 % of all antibodies are of this idio type which, however, is lost within 3 weeks by somatic mutations. Ox1-idio typic antibodies are of highest affinity while the binding strength of non-Id_{Ox1} is 10-100-times lower. Immune maturation is primarily based on accumulation of somatic mutations occurring in Id_{Ox1}, but the propensity of non-Id_{Ox1} antibodies for somatic mutations is also known. Hence, the phOx-specific antibody production is probably the best known immune response at the molecular level.

Id_{Ox1} antibodies are encoded by the VH/VL gene combination VH171/V_κ072 (nomenclature of the VBASE2 data base; old nomenclature VHOx1/V_κOx1) [56]. However, syngeneic

monoclonal Ox1 (Id_{Ox1}) idiotype-specific antibodies have demonstrated that the idiotypic specificity entirely depends on the HCDR3 sequence Asp-Arg-Gly (DRG) [62]. This interaction is obviously extremely sensitive to conformational alterations of the idiotype and of high specificity, as documented by the observation that about half of 19 anti-Id_{Ox1} antibodies lost their reactivity already with class switching from IgM to IgG and none of the anti-Id_{Ox1} reacted with anti-phOx antibodies which carried a glycine or histidine instead of arginine as the middle amino acid of the D region [62]. During immune maturation in the late primary and the secondary response, antibodies exhibiting a DRG D-segment are first lost before they may reappear during the very late stages of tertiary and quaternary memory responses in the context of highly mutated VH and VL genes [62]. This observation was interpreted to indicate that the activation of antigen-reactive antibodies thereupon induces idiotypic responses which suppress major antigen-reactive clones, but stimulate minor clones. Concurrently, mutated clones would survive and could participate in later stages of immune maturation and memory responses. These mutations probably alter the overall structure of the paratope and in particular HCDR3 so that Id_{Ox1}-specific suppression is not active. Hence, idiotypic network reactions were viewed as the driving force of immune maturation. An involvement idiotypic regulation in clonal progression during immune maturation has also been deduced from the observation that Id_{Ox1} clones are suppressed during secondary anti-phOx responses, while non-Id_{Ox1} antibodies encoded by alternative VH/VL genes appear at an increased rate. This allowed the assumption that *'idiotypic interactions and, in particular, idiotypic suppression could be a way of dampening a dominating monoclonal response to favor the shift'* [55]. Other reports, however, did not find evidence for this possibility [63-65]. If clonal progression during immune responses is actually regulated by idiotypic regulation, this can only take place with the help of idiotypically connected T cells [52] which restrict the activation of anti-Id_{Ox1} antibodies to HCDR3-specific ones. Since the Id_{Ox1}-specific DRG-sequence is only expressed in those anti-phOx antibodies which are encoded by the VH171/Vκ072 gene combination [46], it is conceivable that the Id_{Ox1} dominance is T cell-mediated. It is generally assumed that Id_{Ox1} antibodies dominate the early response because of their superior affinity and that further clonal progression is also brought about by preferential activation of memory B cells which exhibit BCR with stepwise increasing affinities. However, this view is not quite valid since the pre-immune repertoire of BALB/c mice contains phOx-reactive non-Id_{Ox1} clones of higher affinity (Lange et al., in preparation).

1.10 Mice carrying single DH gene segments

The above data indicated a strict correlation between dominance of the Id_{Ox1} with the canonical gene combination VH171/VL072, the expression of a DRG amino acid sequence in HCDR3 and the ability of the syngeneic host to produce DRG-specific anti-idiotypic antibodies. Hence, these relationships depend on the available D gene repertoire in the BALB/c strain. Hoping to shed light on these relationships, we analyzed the anti-phOx primary and memory immune responses in two BALB/c mutant strains each of which harbor only one of two different DH gene-segments in their genome. These strains were generated in the following way.

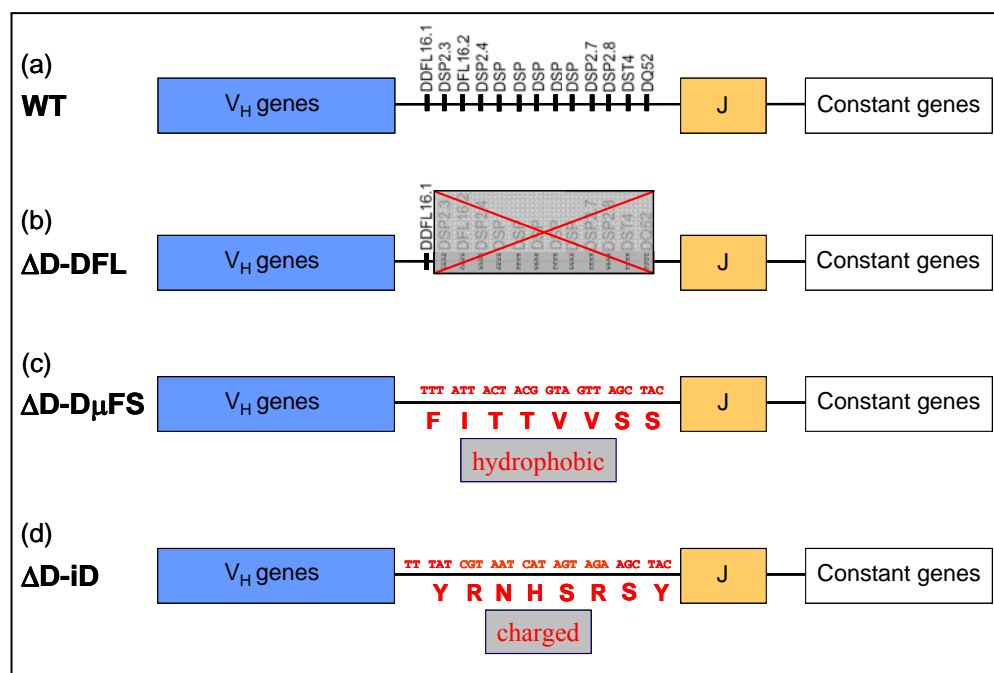

Figure 6

Generation of mice carrying a single DH gene segment

The murine IgH locus contains variable genes (blue), diversity-enhancing (D gene segments - black), joining (J gene segments - orange) and constant genes (white). (a) The D locus of BALB/c wildtype mice is made up of 13 DH genes. (b) In ΔD-DFL mice, only the DFL16.1 D gene segment remained while the other 12 of the DH gene segments are deleted by gene targeting with the aid of the Cre-*loxP* system. In ΔD-D_μFS mice (c), the central amino acids of DFL16.1 in ΔD-DFL mice are replaced by hydrophobic and in ΔD-iD mice (d) by charged amino acids. For ΔD-D_μFS mice (c) and ΔD-iD mice (d), the nucleotides of the respective single DH gene segments and the deduced amino acid sequences, translated in reading frame 1 (RF1) are also shown.

Cre-*loxP* gene targeting was used in a BALB/c embryonic stem cell line to create mice in which the DH locus was simplified to only one gene, *DFL16.1*, the most JH-distal DH gene segment. The other 12 DH gene segments were deleted. Thus, the ΔD-DFL mice have only

the most VH-proximal naturally DH gene *DFL16.1* in the DH locus, instead of 13 DH gene segments in WT animal [66] (Fig. 6).

The Δ D-DFL mice were used to create two other mutant strains, Δ D-iD and Δ D-D μ FS mice, both of which also have only 1 DH gene segment each coding for HCDR3 amino acid sequences with very different properties.

(a)										
Δ D-D μ FS	<u>T</u>	TTT	ATT	ACT	ACG	GTA	GTT	AGC	TAC	
		F	I	T	T	V	V	S	Y	RF1 (Hydrophobic)
		F	Y	Y	Y	G	S	*	L	RF2 (Neutral)
	L	L	L	R	*	L	A			RF3 (Hydrophobic)
(b)										
Δ D-iD	TT	TAT	CGT	AAT	CAT	AGT	AGA	AGC	TAC	
		Y	R	N	H	S	R	S	Y	RF1 (Charged)
		F	I	V	I	I	V	E	A	RF2 (Hydrophobic)
	L	S	*	S	*	*	K	L		RF3 (Hydrophobic)

Figure 7

Reading frames of mutant DH genes in Δ D-iD and Δ D-D μ FS mice

First line denotes the genomic nucleotide sequences (in blue), the followed three lines stand for the amino acid sequences in three reading frames (RF) (in black). Asterisks symbolize a stop codon. (a) and (b) represent the mutant DH gene of Δ D-D μ FS and Δ D-iD mice, respectively.

In Δ D-iD mice, the central portion of *DFL16.1* was replaced with the complete inverted coding sequence of *DSP2.2* [67], [68]. In this way, central RF1 codons for tyrosine and glycine were replaced with those for arginine, histidine and asparagines. Thus, RF1 is coding for charged amino acids, while i-RF1 generates the original tyrosine enriched sequence of *DSP2.2*. The coding sequences for tyrosine and serine at the 5' and 3' termini of the *DFL16.1* DH gene segment were retained to preserve microhomology between the VDJ boundaries. RF2 produces hydrophobic stretches of HCDR3 and leads probably to new-D μ protein expression. RF3 and i-RF3 (inverted RF3) contain termination codons (Fig. 7 b).

ΔD-D_μFS mice were also derived from ΔD-DFL mutant mice. Hence, they harbor a modified *DFL16.1* gene in the DH locus while the other 12 DH gene segments were deleted. The reading frame of *DFL16* was shifted by insertion of two thymidine nucleotides (Fig. 7 a). While RF1 is thus coding for hydrophobic amino acids of old RF2, RF2 and RF3 comprise a stop codon and recreate the old RF1 and RF3, respectively.

1.11 Aim of the work

In the present communication, we analyzed the humoral immune response to the hapten phOx in the 2 mutant mouse strains ΔD-iD and ΔD- D_μFS in the hope to answer the following questions:

- 1.) Is the VH/VL gene repertoire of anti-phOx antibodies identical to that of WT mice when the genome harbors only 1 DH-region gene instead of 13?
- 2.) Is the VH/VL gene repertoire identical, but the DH gene-dependent HCDR3 repertoire of the anti-phOx response restricted when it is generated from a single DH gene segment?
- 3.) Is the VDJ-recombination with only 1 available DH gene segment flexible enough to create the canonical Id_{Ox1} VH/VL gene combination together with the typical DRG D-region sequence? Are there differences in this respect between the two mutant strains?
- 4.) Is the Id_{Ox1} still dominating the anti-phOx response, *i.e.* does the Id_{Ox1} dominance depend on the VH171/Vκ072 gene combination only or is it really dictated by the DRG D-region sequence?
- 5.) How does the immune maturation in the 2 mutant strains develop from primary to memory responses, *i.e.* does immune maturation still depend on accumulation of somatic mutations in one or more particular primarily activated clonotypes?
- 6.) Is the immune maturation in these mutant mouse strains strong enough to develop clones of highest affinity?

2 Materials and methods

2.1 Materials

2.1.1 Buffer and media

Phosphate-buffered saline, PBS

137 mM sodium chloride (NaCl)
 2.7 mM potassium chloride (KCl)
 4.3 mM disodium hydrogen phosphate (Na_2HPO_4)
 1.4 mM potassium dihydrogen phosphate (KH_2PO_4)
 Adjust the pH to 7.4 with hydrochloric acid (HCl)

Carbonate bicarbonate buffer (0.5 M, pH 9.6)

Sodium hydrogen carbonate (NaHCO_3) 2.93g
 0.5 M disodium carbonate (Na_2CO_3) 1.59g
 ddH₂O to 1 liter

Standard medium for cell culture

RPMI 1640 a bottle of powder for 10 liters
 GlutaMAX 2 mM
 Streptomycin 100 U/ml
 Penicillin 0.1 mM
 2β-mercaptoethanol 0.1 mM
 FCS 10 % final concentration
 NaHCO₃ 20 g
 ddH₂O add 10 l
 Adjust the pH to 7.4 with HCl. Sterilize by filtration (0.2 μm filter)

HT-Medium

Standard medium (see above) fortified with:
 Hypoxanthin (50 mM)
 Thymidin (0.2 mM)
 10 % J774A.1-supernatant

Freezing medium

Standard medium

+ 10 % (v/v) Dimethylsulfoxyd (DMSO)

+ 10 % (v/v) FCS (20 % final concentration)

Filter through 0.2 µm filter.

Aliquot in 15 ml conical tubes and store in -20 °C freezer for long term periods

6X Loading Dye Solution

10mM Tris-HCl (pH 7.6)

0.03 % bromophenol blue

0.03 % xylene cyanol FF

60 % glycerol

60 mM EDTA

DEPC-treated water

0.1 ml DEPC

100 ml dd H₂O

Autoclave for 15 min to remove any trace of DEPC

10xPCR buffer

200 mM Tris-HCl

500 mM KCl

pH 8.4

EB

10 mM Tris.Cl

pH 8

10x TBE Buffer (Tris-Borate-EDTA)

108 mg Tris base

55 mg Boric acid

9.3 mg Na₄EDTA

Add ddH₂O to 1 liter

The pH is 8.3 and requires no adjustment.

2.1.2 Chemicals and instruments	(all companies in Germany)
ABTS	Roche Diagnostics, Mannheim
Agarose	Serva, Heidelberg
Amphotericin B	Merck Biosciences, Darmstadt
Buffer for ABTS	Roche Diagnostics, Mannheim
Casein Natrium	Roth, Karlsruhe
Dimethylsulfoxid (DMSO)	Sigma, Taufkirchen
DNA Ladder Plus	Fermentas, St. Leon-Rot
Ethanol	Roth, Karlsruhe
Ethidium bromide	Roth, Karlsruhe
Fetal calf serum (FCS)	Invitrogen, Karlsruhe
GlutaMAX	Invitrogen, Karlsruhe
HAT	Sigma, Taufkirchen
Histopaque	Sigma, Taufkirchen
HT	Sigma, Taufkirchen
Imject Alum	Perbio Science, Bonn
Isopropanol	Roth, Karlsruhe
Minocyclin	Sigma, Taufkirchen
Oligonucleotide; HPSF purified	MWG, Ebersberg
Penicillin	Sigma, Taufkirchen
Polyethylenglycol PEG1500	Roche Diagnostics, Mannheim
RPMI 1640	Biochrom, Berlin
Streptomycin	Sigma, Taufkirchen
<i>Taq</i> polymerase	Fermentas, Leon-Rot
Tiamulin	Sigma, Taufkirchen
Trypan Blue, 0.4 %	Promega, Mannheim
6-well culture plates	Sarstedt, Nümbrecht
24-well culture plates	Sarstedt, Nümbrecht
cDNA Synthesis	Fermentase, Leon-Rot
Electrophoresis chamber	Serva, Heidelberg
ELISA reader	Bio rad, München
Forceps	Roth, Karlsruhe

Fusion culture plates	Greiner, Frickenhausen
Gel casting trays	Serva, Heidelberg
Loading buffer	Fementas, Leon-Rot
MaxiSorp plates	Nunc, Wiesbaden,
Multiscreen HTS plates	Millipore, Billerica, USA
PCR clean-up gel extraction	Macherey-Nagel, Düren
Petri dishes	Sarstedt, Nümbrecht
Power supply	Serva, Heidelberg
RNA Extraction Kit	Quiagen, Hiden
Sample combs	Serva, Heidelberg
Scissors	Roth, Karlsruhe
Sterile 0.2 ml microfuge tubes	Sarstedt, Nümbrecht
Sterile centrifuge tubes	Sarstedt, Nümbrecht
Thermal Cycler	Serva, Heidelberg
Total IgG Kit	Roche, Karlsruhe
Transilluminator	Bio rad, München
UV spectrophotometer tubes	Eppendorf, Hamburg

2.1.3 Antibodies

APC anti-mouse CD19	NatuTec, Frankfurt
FITC anti-mouse CD3e	NatuTec, Frankfurt
Goat anti-mouse IgG	Dianova, Hamburg
Goat anti-mouse IgG/M/A	Dianova, Hamburg
Goat anti-mouse IgM	BIOZOL Diagnostica, Eching

2.2 Methods

2.2.1 Mice

Δ D-iD and Δ D-D μ FS mice, carrying a targeted deletion of 12 DH gene segments and intervening sequences [66], [68], were obtained from PD. Dr. M. Zemlin (Marburg) and maintained in the animal facility of the CAU under clean conventional conditions. After arrival, the mice were kept at last two weeks in the animal house to adapt to the new environmental conditions before starting with the experiments.

2.2.2 Preparation of hapten carrier complex (phOx-CSA)

The hapten-carrier-complex (phOx-CSA) was prepared as described by Mäkelä et al [69]. CSA (fraction V; 0.5 ml) was stirred with 37.5 mg of phOx in 20 ml of 5 % NaHCO₃ for 24 h at 4 °C.

After incubation, the mixture was centrifuged for 30 min at 35.000 g and then excessively dialyzed against 0.15 M NaCl. The amount of non-dialyzable phOx was estimated from the optical density assuming that phOx coupled to the lysine residues of the protein has the same optical density (OD₃₅₂ = 32.000) as phOx coupled to epsilon-aminocaproic acid.

The conjugate contained 8.5 molecules of phOx per molecule of CSA. The final solution was sterile filtered, aliquoted in 200 μ l and stored by -20 °C until usage. For generation of a strong immune response, the antigen was mixed with Imject Alum (Pierce; Rockford, USA) as an adjuvant at a 1:1 ratio for 30 min. Imject Alum is an aqueous solution of aluminum hydroxide (40 mg/ml) and magnesium hydroxide (40 mg/ml) plus inactive stabilizers.

2.2.3 Immunization

Δ D-iD and Δ D-D μ FS mice were injected intraperitoneally (i.p.) with 80 μ g of alum-adsorbed phOx-CSA. For analysis of the early and late primary response, mice were sacrificed on day 7 and 14, respectively. Spleens were teased apart and the spleen cells were fused by conventional PEG-mediated hybridization with the immunoglobulin-negative myeloma cell line Ag8.653 [70].

For analysis of the secondary response, mice were boosted 8 weeks later by i.p. injection of the same amount of Ag and spleen cells were fused on day three. Mice were rested until the antibody titers of the secondary immune response had declined after about two months. Then,

the tertiary i.p. immunization was performed and at day three, mice were sacrificed and spleen cells were fused with Ag8.653 myeloma cells. The antibody titers were tested regularly after every immunization and compared with that of wild type animals.

2.2.4 Collection of blood samples

The mouse was isolated in a small cage or container and warmed under an infrared lamp for 10-15 min. This treatment increased the blood flow to the tail, but should not hurt the mouse. The tail was swabbed with antiseptic and nicked with a sterile scalpel on the underside across one of the lower veins that should be visible. Several drops of blood could be collected and the mouse was returned back to its cage.

The blood was incubated at 37 °C for 1 h and shaken several times to dislodge the clot. After the tube was transferred to 4 °C for 2 h or overnight and spun at 10.000 x g for 10 min at 4 °C, the cell pellet was discarded and the supernatant was spun a second time for 10 min. The serum was transferred to a new tube, preserved by adding 0.02 % sodium azide or 0.001 % to 0.01 % thimerosal and frozen at -20 °C.

2.2.5 Cell culture

Myeloma and hybridoma cell lines were cultured in RPMI 1640 medium supplemented with foetal calf serum (FCS) to a final concentration of 10 % and 11×10^{-5} M β -Mercaptoethanol. FCS is used normally, because it contains very low concentrations of IgG molecules that may interfere in some assays or purifications. In addition, the medium was supplemented with antibiotics; penicillin at 100 U/ml and streptomycin at 100 μ g/ml. The cells were cultivated in a CO₂-incubator at a concentration of 7.5 % CO₂, 37 °C and water-saturated atmosphere.

2.2.6 Counting of cells

Cell viability was assessed by trypan blue exclusion using a Neubauer haemocytometer. An aliquot of 0.2 ml cell suspension was prepared and mixed with 0.3 ml medium and 0.5 ml (0.4 %) trypan blue. Ten μ l of the mixture was transferred to the counting chamber of the haemocytometer. After 1-2 min (but not longer as viable cells may die and begin to take up the dye) the number of cells could be counted within "counting squares". The calculated percentage of unstained cells represented the percentage of viable cells.

2.2.7 Thawing of cells

It was important to arrange all reagents before starting thawing of cells. 10 ml of medium were dispensed into a sterile 15 ml tube and warmed at 37 °C in a water bath. The freezing vial was removed from the liquid nitrogen and placed on ice until thawing in a water bath by gentle agitating. The O-ring and cap should be kept out of the water to prevent contamination. The vial was removed from the warmed water as soon as the contents were thawed.

After thawing, the entire vial had to be sprayed with 70 % EtOH (or antiseptic) and the cell suspension was poured out from the vial to the 10 ml of pre-warmed medium. After centrifugation for 5 min at 1.100 x g, the supernatant was aspirated with a Pasteur pipette and the cell pellet was dispersed by gentle tapping and flicking of the tube to prevent cell clumping when medium was added and resuspended in 5 ml fresh medium. The cell suspension was then transferred to a Petri dish (TC-quality) and placed in the CO₂-incubator.

2.2.8 Freezing of Cells.

Generally, cells were frozen slowly and thawed quickly for maximal survival. For freezing, cells had to be in log phase of growth and centrifuged at 1.100 x g for 7 min. The old medium was aspirated as completely as possible with a sterile Pasteur pipette and the cells were resuspended at a concentration of 0,5 - 2 x 10⁶ cells/ml in freezing medium and aliquots of 1 ml were put into freezing vials (1.8 ml cryovials). These vials were placed in a -20 °C freezer for 1 h and then transferred to -80 °C. After several days, the tubes could be removed from the freezer and transferred to liquid nitrogen.

2.2.9 Cell fusion

Before fusion, myeloma cells should be cultured for a certain period of time in the logarithmic phase and maintained at a density of about 1 x 10⁶ cells/ml. The mouse was sacrificed and the abdominal area swabbed with alcohol. After opening the abdomen with sterile forceps and scissors, the spleen was removed and placed into a sterile Petri dish containing 10 ml of serum-free RPMI 1640 medium. Splenocytes were passed through sterile Falcon 0.40 µm cell filter using syringe needle and sterile forceps. The suspension was transferred to a 15 ml tube and centrifuged for 5 min. Then, the supernatant was discarded, the pellet of splenocytes was washed twice in serum free medium, resuspended in 10 ml medium and the viable lymphocytes were counted in a haemocytometer.

Concurrently with the splenocytes, Ag8.653 myeloma cells were washed twice with serum-free medium, centrifuged for 5 min at 1.100 x g, resuspended in 10 ml medium and counted. The spleen and myeloma cells were mixed in a 50 ml tube at a ratio of 2:1-5:1 and centrifuged for 5 min at 1.100 x g. The supernatant fluid was aspirated as completely as possible with a Pasteur pipette and the pellet was gently disrupted by tapping the bottom of the tube. One ml of warmed 50 % PEG 1500 (w/v) was added dropwise and slowly to the pellet over a period one min while tapping the side of the tube to achieve thorough mixing. Then, the PEG/cell mixture was gradually diluted under continuous and gentle swirling of the tube: 5 ml serum-free medium for 5 min and thereafter 25 ml serum free medium for 5 min.

After centrifugation for 5 min at 1.100 g, the supernatant was removed and the fused cells gently resuspended and mixed with 400 ml volume of standard RPMI 1640 medium supplemented with 10 % FCS, HAT selection medium, 10 % J774A.1 supernatant, 2.5 ml Ciprobay and 5 µg/ml Amphotericin B. The cell suspension was distributed in fusion plates (1.5 ml/well) and incubated for the next 10 days at 37 °C and 8-10 % CO₂.

The fusion plates were examined visually 24-48 h after fusion for any abnormalities (*e.g.* bacterial contaminations) and during the next days for growing of cell clusters. At day 10, 0.5 ml aliquots were taken from every well and tested for phOx-reactive antibodies by ELISA.

2.2.10 Determination of hybridomas secreting phOx-specific antibodies

96-well microtiter plates (Nunc; Wiesbaden, Germany) were coated with phOx-BSA using multichannel pipette (50 µl/well; 10µg protein/ml sodium carbonate buffer; 0.05 M, pH 9.6) and blocked with casein (1 % casein in PBS, 200µl/well). Antibody-containing cell culture supernatant fluids (50 µl/well) were added and incubated for 1 h. After careful washing, HRP-labeled goat anti-mouse antiserum was added as a secondary antibody and incubated for 1 h. All incubations were performed at 37 °C for 1h. Washing was performed with PBS/T using an automatic washer. ABTS was used as substrate (50 µl/well), and the absorbance was measured at a 405 nm wavelength. Extinction values exceeding those of the negative controls with PBS, instead of phOx-BSA, by a factor of 5 were considered positive. Clones of positive wells picked up and transferred separately to 24 well plates. One week later, the clones of 24 well plates were tested again for reactivity with phOx-BSA, but non-reactivity with BSA. Antibodies fulfilling this criterion were considered as phOx-specific.

2.2.11 Isolation of total RNA

Total RNA was extracted with the aid of Qiagen's RNEasy mini kits according to manufacturer's instructions (Qiagen, Hilden, Germany). 1×10^7 myeloma cells were used to cover the maximum binding capacity of this column (100 μg RNA). After centrifugation of the cells at 1.100 g for 7 min, the cell pellet was disrupted by addition of 600 μl lysis buffer (RLT) and homogenized by vortexing for 1 min. One volume (600 μl) of 70 % ethanol was added and mixed thoroughly by pipetting. 700 μl of the solution was transferred to an RNEasy mini column and centrifuged for 15 sec at 10.000 g. The RNA was bound to the column material and the flow-through was discarded. For cleaning of the column-bound RNA, 700 μl wash buffer (RW1) was spun through the column for 15 sec at 10.000 g. Then, the collection tube was changed to a clean 1.5 ml Eppendorf tube and 500 μl of a second wash buffer (RPE) was spun through the tube again for 15 sec at 10.000 g. Then, 500 μl of RPE buffer was added to the tube and spun for 2 min at 10.000 g to ensure that the column was dry. As an additionally precaution against contamination, the collection tube was changed again and the column was spun for 1-2 min at maximum speed (13.000 g). To elute the RNA from the tube, 70 μl of RNase-free H_2O was added directly to the filter in the column and spun for 1 min at 10.000 g. The RNA concentration was determined spectrophotometrically at 260 nm and extracted RNA was frozen at -20°C .

2.2.12 Synthesis of complementary DNA

The cDNA library was constructed using a "RevertAid First Strand cDNA Synthesis" kit according to the manufacturer's protocol (Fermentas, St. Leon-Rot, Germany). 8 μl of total RNA was added in a 50 μl sterile tube on ice, mixed gently with 1 μl oligo(dt)₁₈ primers (0.5 $\mu\text{g}/\mu\text{l}$) and 3 μl of DEPC-treated water and spun down for 5 sec in a microcentrifuge. The mixture was incubated at 70°C for 5 min and the tube placed on ice. Then, the following components were added: 4 μl of 5 x reaction buffer, 1 μl of Ribolock™ (ribonuclease inhibitor, 20 U/ μl) and 2 μl of 10 mM dNTP mix, mixed gently and incubated at 37°C for 5 min. Now, 1 μl of RevertAid™ M-Mulv (reverse transcriptase, 200 U/ μl) was added and the mixture was incubated at 42°C for 60 min. Finally, the reaction was stopped by heating at 70°C for 10 min. The new synthesized cDNA could be used directly in PCR reaction or frozen at -20°C .

2.2.13 Polymerase chain reaction (PCR)

The PCR reaction was performed in volumes of 50 μ l and the following components were set up in 200 μ l sterile tube:

5 μ l	10x PCR reaction buffer
5 μ l	DMSO
1 μ l	dNTP (10 mM)
1.5 μ l	MgCl ₂ (50 mM)
1 μ l	3' primer (10 μ M) (Tab. 1)
1 μ l	5' primer (10 μ M) (Tab. 2)
0.4 μ l	Taq polymerase (5 U/ μ l)
2 μ l	cDNA (from first-strand reaction)
33 μ l	autoclaved, distilled water

The sample was mixed by pipetting up and down and loaded in a thermocycler at 94 °C. The thermocycle included 1 cycle at 94 °C for 2 min of initial denaturation, and 35 cycles at 94 °C for 1 min, at 72 °C for 1.5 min, and at 54 °C for 1.5 min, followed by a final extension at 72 °C for 10 min. The amplified DNA was then chilled at 4 °C. The PCR products were separated by electrophoresis in a 1 % agarose gel, stained with ethidium bromide and the desired fragments were cut out and purified.

Table 1

Primers 3'→5'

Name of primers	Sequences	T _M [°C]
KLM13	gta aaa cga cgg cca gtg gaa gct tac tgg atg gtg	72.9
CHIgG M13	gta aaa cga cgg cca gtg gaa gct tay ctc cac aca	72.3
CM 15	gct ctc gca gga gac	53.3

KL – primer of constant L chain. CHIgG – primer of constant H chain of IgG.

CM 15 – primer of constant H chain of IgM.

T_M [°C] = 2 (n_A + n_T) + 4 (n_G + n_C), annealing temperature.

Y = C, T

Table 2

Primers 5'→3'

Name of primers	Sequences	T _M [°C]
VLFR1M13rev	gga aac agc tat gac cac aga crt cma gat ray cca	70.6
VLFR2M13rev	gga aac agc tat gac cac ara mat tkt gct gac yca	69.5
VLFR3M13rev	gga aac agc tat gac cac aga try tkt gat gac cca	70.0
VLFR4M13rev	gga aac agc tat gac cac asr aaw tst tct cwy mca	68.9
VLFR5M13rev	gga aac agc tat gac cac arr crt tst gat gwc aca	70.0
VLFR6M13rev	gga aac agc tat gac cac aga tat tgt gat rac kca	68.3
VLFR7M13rev	gga aac agc tat gac cac arr yat tgt gat gac cca	70.0
VH1M13rev	gga aac agc tat gac cag taa gac gtc mag ctt cag	71.2
VH2M13rev	gga aac agc tat gac caa att gac gtc car syg cag	71.7
VH3M13rev	gga aac agc tat gac caa att gac gtc cag ytg swg	71.2
VH4M13rev	gga aac agc tat gac cac agc tga ags ast cag gac	72.9
VH5M13rev	gga aac agc tat gac cam wgs kgg tgg agt ctg ggg	75.2
VH6M13rev	gga aac agc tat gac caa rss tgg tgg aat ctg gag	72.3
VH7M13rev	gga aac agc tat gac caa rgs tgr tsg agt ctg gag	72.9
VH8M13rev	gga aac agc tat gac cac agc tgc agc agt cwg tg	73.0
VH9M13rev	gga aac agc tat gac cam asy tgs wgg wgw	68.1
VH10M13rev	gga aac agc tat gac cac agm tsc agc agy ctg g	73.1
UmIgVH	tga ggt gca gct gga gga gtc	68.39
UmIgVK	gac att ctg atg acc cag tct g	62.74

VH – primers of variable H chains. VL – primers of variable L chains. UmIg – universal Ig primers. $T_M [°C] = 2(n_A + n_T) + 4(n_G + n_C)$, annealing temperature.

N = A, C, G, T

B = G, T, C

M = A, C

S = G, C

V = G, A, C

H = A, T, C

R = A, G

Y = C, T

D = G, A, T

W = A, T

K = G, T

2.2.14 Agarose gel electrophoresis of DNA

Agarose gel electrophoresis is a method used in biochemistry and molecular biology for separation of DNA or RNA molecules according to size. This is achieved by moving negatively charged nucleic acid molecules through an agarose matrix with an electric field (electrophoresis). Shorter molecules move faster and migrate further than longer ones.

To pour a gel, agarose powder was mixed with electrophoresis buffer (TBE) to a final concentration of 1 %, and then heated in a microwave oven until completely melted (10 min, 400 W). After cooling the solution to about 60 °C, it was poured into a casting tray containing 2 combs, one at the middle of the gel and the other at one side, about 5 mm from the end of the gel and allowed to solidify at room temperature or in a refrigerator.

After the gel was solidified, the combs were removed using care not to rip the bottom of the wells. The gel in its plastic tray was inserted horizontally into the electrophoresis chamber and just covered with buffer. Samples containing DNA were mixed with loading buffer and then pipetted into the sample wells (30 µl), the lid and power leads were placed on the apparatus and a current was applied (100 V, 400 mA). DNA migrated towards the positive electrode, which is usually colored red.

After 35 min, the gel was stained by soaking in a dilute solution of ethidium bromide for 15 min. To visualize amplified DNA, the gel was placed on an ultraviolet transilluminator. Now, the desired DNA bands could be cut out of the gel and dissolved to retrieve the purified DNA fragments.

2.2.15 Isolation of DNA from agarose

QIAquick PCR purification kit (Qiagen, Hilden, Germany) was used to isolate and extract DNA fragments from the gels. The amplified DNA fragments were separated in horizontal agarose gels and visualized under UV light. The respective DNA fragments of about 450 pb were cut from the gel and placed into a microcentrifuge tube.

All buffers needed for the DNA isolation were included in the kit. In the first step, 3 volumes of binding buffer (QG) were added to 1 volume of gel slice and solubilized in a water bath or thermomixer at 50 °C. After complete solubilization, 1 gel volume of isopropanol was added and the solution was immediately applied onto a mini spin column. During centrifugation (1 min, 10.000 g), the DNA was bound onto the column material. The flow-through was discarded and 500 µl of washing buffer (QC) was added to wash away all traces of agarose. The column was centrifuged for 1 min and the flow-through was discarded. In a third centrifugation step, 750 µl of washing buffer (PE) was added and spun through. Then the column was spun for a second time to ensure complete removal of the buffer. At that time, the spin column was placed into a clean and sterile microcentrifuge tube. To elute the purified DNA, 50 µl of sterile water or elution buffer (EB) was added and the column was centrifuged for 1 min at 10.000 x g. The concentration of the extracted DNA could be determined by UV spectrophotometer.

2.2.16 Determination nucleic acid concentration

Nucleic acid concentrations were determined in an UV spectrophotometer by measurement of the extinction (E) at 260 and 280 nm using UV tubes, where an $E_{260} = 1$ corresponds to a concentration of 40 ng/ μ l RNA or 50 ng/ μ l double-stranded DNA [71]. The cleanness was controlled by means of the quotients E_{260}/E_{280} , which should lie between 1.8 and 2.0 [71].

2.2.17 DNA sequencing

The DNA sequencing was performed using the dye-terminator Sanger sequencing method and Roche FLX sequencer provided by different companies (Agova; Berlin, Germany, Qiagen; Hilden, Germany). In addition, variable sequences of some antibodies were determined at the Institute of Clinical Molecular Biology of Kiel University.

2.2.18 Determination of serum anti-phOx antibody titers

96-well microtiter plates (Nunc; Wiesbaden, Germany) were coated with phOx-BSA with the aid of multichannel pipettes (50 μ l/well; 10 μ g protein/ml sodium carbonate buffer; 0.05 M, pH 9.6) and blocked with casein (1 % casein in PBS, 200 μ l/well). The sera were diluted serially in PBS/T and 50 μ l/well were added. Horseradish peroxidase (HRP)-conjugated goat anti-mouse IgG and IgM Abs were diluted 4000-fold in PBS/T and 50 μ l/well were added. All incubations were performed at 37 °C for 1 h. After every incubation step, three washes with PBS/T were performed using an automatic washer. ABTS was used as substrate (50 μ l/well), and the absorbance was measured at a 405 nm wavelength.

2.2.19 Determination of relative affinity of phOx specific Abs

Determination of relative affinity of phOx specific IgG and IgM antibodies was done in two steps. In the first step, the dilution factor corresponding the 80 % of maximal binding of every supernatant was determined. In the next step, the concentration of 80 % value was used in an inhibition assay. Antibodies that did not reach maximal binding plateau were excluded from further investigation.

96-well flat-bottomed microtiter plates (Nunc; Wiesbaden, Germany) were coated with phOx-BSA and then 25 μ l of doubled concentration of the 80 % value of every supernatant and 25 μ l of serially diluted phOx-caproic acid were incubated for 1 h at RT. After washing, 50 μ l of horseradish peroxidase (HRP)-conjugated goat anti-mouse IgG and IgM Abs were added to

the wells and the plates were incubated for 1h at RT and then washed three times in PBS/T. ABTS (50 μ l/well) was used as a HRP-substrate and incubated in the dark at RT for 10 min. The absorbance of the wells was read at 405 nm. PhOx-caproic acid concentration giving 50 % binding inhibition was considered as relative affinity of the investigated anti-phOx antibody. An affinity factor was generated as the quotient of the relative affinity of the prototype Ox1-idiotypic antibody NQ2/16.2 divided by that of a particular antibody. Hence, antibodies with an affinity factor of >1 exhibited a higher while those with an affinity factor of <1 a lower affinity than NQ2/16.2.

2.2.20 Idiotypic determination of phOx specific antibodies

Since the monoclonal anti-idiotypic antibody (Ab2) 8-21/W18 recognizes an Ox1 idiotype- (Id_{Ox1})-specific idiotope of anti-phOx specific antibodies, this antibody was used to characterize anti-phOx antibodies generated in ΔD -D μ FS and ΔD -iD mice.

Microtiter plates were coated with phOx-BSA and residual surface of the wells were blocked with 1 % casein in PBS. After addition of 25 μ l of anti-phOx antibody-containing supernatant fluid and 25 μ l of serially diluted 8-21/W18 supernatant (1/1 – 1/4800), the plates were incubated for 1 h at RT. After washing, 50 μ l of horseradish peroxidase (HRP)-conjugated goat anti-mouse IgG and IgM Abs were added to the wells and the plates were incubated for 1 h at RT and then washed three times with PBS/T. ABTS (50 μ l/well) was added as a HRP-substrate and incubated in the dark at RT for 10 min. The absorbance of the wells was measured at 405 nm. Id_{Ox1} anti-phOx antibodies showed a descending curve in an 8-21/W18-dependent manner, while Id -Ox1 negative Abs were not affected by addition of the anti- Id 8-21/W18 and showed a straight line in the plot (absorbance against Ab2 concentration).

2.2.21 Flow cytometric measurement

A single cell suspension was prepared from freshly isolated spleen and bone marrow using scalpel, forceps and cell strainer (0.22 μ l). The cell suspension was centrifuged 5 min (4,000 x g) at 4 °C and the pellet was resuspended in 3 ml of complete RPMI 1640 medium. Red blood cells were removed by density gradient of Histopaque (Sigma-Aldrich Chemie; Munich, Germany) centrifugation. Three ml of Histopaque was filled into a 15 ml conical tube and 3 ml of the cell suspension was carefully layered on top. After centrifugation at 400 x g for exactly 30 min at RT, the upper layer was discarded and the cells lying on top of the opaque interface were quantitatively collected with a Pasteur pipette and transferred into a new 15 ml

centrifuge tube. The cells were washed two times with PBS, and then resuspended in 3 ml PBS, 5 % FCS (staining buffer) and a small sample (50 μ l) was used to perform a cell count and viability analysis by Trypan Blue.

The cell suspension was adjusted to concentrations of $1-10 \times 10^5$ cells/sample (0.5 ml) in U bottom plastic centrifuge tube (Sarstedt; Nümbrecht, Germany). After centrifugation, the purified cells were suspended in 50 μ l of staining buffer and pre-incubated with 1 μ l (0.5 μ g) of anti-CD16/CD32 (anti-Fc) for 5-10 min at RT to block unspecific staining by reaction with Fc-receptors (FcR) of the cells. For the staining, 1.25 μ l (0.25 μ g) of Allophycocyanin (APC) anti-CD3e and 2 μ l (1 μ g) of fluorescein isothiocyanate (FITC) anti-CD19 were added pro sample. The negative controls were performed only with staining buffer without any antibodies. The samples were mixed by gently vortexing or tapping and incubated for 60 min in the dark at 4 °C. After incubation, 3 ml of staining buffer was added, mixed, and centrifuged at 400 x g for 5 min. After the cell pellet was resuspended in 500 μ l of PBS, 2 % FCS on ice, the cell sample could be analyzed in the flow cytometer.

2.2.22 Flow cytometric staining of dead cells with 7-Amino-actinomycin D

7-Amino-actinomycin D (7-AAD) intercalates into double-stranded nucleic acids. Since it is excluded by viable cells but can penetrate cell membranes of dying or dead cells it is suitable for determination of dead cells in flow cytometric assays.

The cells were stained as outlined above in the protocol for dual color staining with APC and FITC monoclonal antibodies. After the last washing step, the cells were resuspended as usual in 500 μ l of PBS containing 2 % FCS. Then, viability of the cell sample was assessed by addition of 1-2 μ l of 7-AAD solution per tube. The samples were kept in this solution as usual at 4 °C and protected from light until analysis in the flow cytometer.

2.2.23 Flow cytometric analysis

Cell fluorescence was analyzed with a FACScan apparatus (BD Biosciences; San Jose, USA) using an excitation laser wavelength of 488 nm. Cell populations of interest were gated and analyzed using CellQuest 3.3 software. Gates were set to eliminate debris.

2.2.24 The enzyme-linked immunospot assay (Elispot)

The Elispot assay provides an effective method of measuring single plasma cells secreting antigen-specific antibodies. Each well of MultiScreen plates (Millipore; Billerica, USA) was pre-wetted with 15 μ l of 35 % ethanol for 1 min and then rinsed with 150 μ l sterile PBS three times before the ethanol evaporates. One plate was coated with 100 μ l (10 μ g/ml) pH₉-BSA in carbonate buffer (0.05 M, pH 9.6). In parallel, a second plate was coated with BSA alone under the same condition as pH₉-BSA. Then, the plates were incubated over night at 4 °C. After two washing steps with 150 μ l bidest. H₂O per well, the membrane was blocked with 150 μ l per well of culture medium (RPMI 1640, 10 % FCS, penicillin, streptomycin, glutamine) for at least 2 h at 37 °C. 100 μ l (ca. 5×10^5 cells) of purified mononuclear cell suspension isolated from spleen and BM (as described for flow cytometry using a Histopaque density gradient) was added per well.

The cells were incubated for 18 h at 37 °C in 5 % CO₂ incubator and then removed by washing the plate 6 times with PBS/0.01 % Tween 20. 100 μ l of secondary antibodies (HRP-conjugated anti-IgG or anti-IgM, diluted 1/40,000 in PBS) was added per well and incubated for 1 hr at 37 °C in an atmosphere containing 5 % CO₂ and 95 % humidity. After this incubation period, the secondary antibodies were decanted and the plate was washed 3 times with PBS-0.01 % Tween 20, followed by 3 washes with PBS. 100 μ l/well of 3-Amino-9-Ethylcarbazol (AEC) was added and incubated until dark spots emerge. Spot development was stopped after 10 min under running water and left to dry. After complete drying, the spots were counted under a dissecting microscope. The number of pH₉-specific antibody-secreting plasma cells was calculated by subtracting the number of spots of BSA- from pH₉-BSA-coated wells.

2.2.25 Statistical analysis

Statistical analysis was performed with one-way analysis of variance (ANOVA) followed by Dunnet's multiple comparison post test, using GraphPad Prism for Windows (version 4.02, GraphPad Software Inc., San Diego, CA, USA). Values of $P < 0.05$ were considered significant.

2.2.26 Hydrophobicity of the HCDR3

The hydrophobicity of the HCDR3 interval was determined with normalized Kyte-Doolittle hydrophobicity index [72, 73]. The average hydrophobicity was calculated by adding the hydrophobicity value for each amino acid in the HCDR3 dividing by the number of amino acid.

3 Results

Investigations of 3 genetically engineered mouse strains have demonstrated that B cell development and immune responses strongly depend on the number of available DH gene segments and the sequence of particular remaining single DH genes. Δ D-DFL mice containing only the natural occurring DFL16.1 gene segment in the DH locus showed, in comparison to WT mice, a rather normal B cell development and an almost unaltered response to the TD antigen NP-CGG [66]. Although the number of immature IgM^+IgD^- B cells in the bone marrow was decreased, numbers of mature IgM^+IgD^+ B cells in BM and spleen as well as B1a, B1b and B2 in the peritoneal cavity were as in WT mice. Length and amino acid compositions of DFL-16.1-encoded HCDR3 of BM B cells resembled those of WT mice, but differed in non-DFL16.1-related D regions. In Δ D-iD mice with an inverted DH gene segment encoding for the charged amino acids asparagine, histidine and arginines (instead of the normally predominating tyrosine and glycine), marginal zone (MZ) B cells were increased, but the numbers of mature B cells in BM and spleen as well as B1 cells in the peritoneum were reduced to half and immune responses to thymus-dependent (TD) as well as thymus-independent (TI) antigens were substantially reduced [68]. A similar strong impact on B cell development and TI-2 antigen-induced IgM immune responses was observed in Δ D-D μ FS mice containing a frame-shifted DFL16.1 gene in the DH locus [74, 75]. In these mice, kept under specific pathogen-free conditions, immunoglobulin serum concentrations of IgM, all IgG subclasses and IgA and the development of primary and secondary immune responses to TD antigen NP-CGG were identical to those of WT mice. The latter 2 strains, Δ D-iD and Δ D-D μ FS mice, are under investigation here.

3.1 Composition of B and T cell compartments in mutant mouse strains

For a first broad characterization of the immune systems of our mutant mice and a comparison to published data [66, 68, 74, 75], we examined the compartment of B cells in BM and spleen. Moreover, we determined the size of the T cell compartment and compared it with that of WT mice for two reasons: 1.) Since we surmised that the selection of HCDR3 amino acid composition might be connected with T cell regulation (see 1.9), the reduced B cell compartment may also cause a reduction of the total number of T cells. 2.) The development of B and T cells are not independent of each other but mutually regulatory as demonstrated in several investigations: a) B cells and antibodies participate in the selection of the T cell repertoire [76] and this immunoglobulin-dependent T cell selection operates only during the first 3

weeks of life [77]. b) Splens of B cell deficient mice show a three- to fivefold reduction in T cell numbers [78]. c) Studies of B cell deficient mice demonstrate that B cells are not only important for antibodies production, but also required for efficient T cell responses [79, 80].

Total mononuclear cells were isolated from BM and spleen of WT, homozygous $\Delta D-D\mu FS$ and homozygous $\Delta D-iD$ mice. After purification by Histopaque gradient centrifugation, cells were analyzed by fluorescence-activated cell sorting (FACS).

The average number of splenic mononuclear cells of $\Delta D-D\mu FS$ and $\Delta D-iD$ mice was about 2.5 and 2 fold lower than in WT mice. A similar reduction was also seen for lymphocyte counts. Lymphocytes in the spleen of $\Delta D-D\mu FS$ mice were 2.6 times lower and those of $\Delta D-iD$ mice were 2.4 times lower as in WT mice. In contrast, in the bone marrow, numbers of total mononuclear cells as well as lymphocytes of both mutant strains and WT mice were rather identical (Tab. 3).

The flow cytometric analysis of total T and B cell numbers in the spleen were determined with goat-anti-mouse CD3 and CD19, respectively, as shown in Fig. 8 and summarized in Tab. 3. In the spleen of $\Delta D-D\mu FS$ mice, the total number of 8.1×10^5 T and 20.6×10^5 B cells was approximately two and fourfold lower than in WT mice (29.2×10^5 and 74.4×10^5 , respectively). The splenic T and B cells of $\Delta D-iD$ mice were reduced to a similar extent (Tab. 3). When relating the proportion of T and B cells to total numbers of mononuclear cells, the following picture merged. Compared to WT mice with 14.7 %, the contribution of T cells of $\Delta D-D\mu FS$ (10.3 %) and $\Delta D-iD$ (13.2 %) among mononuclear cells remained almost unchanged. However, the percentages of B cell were relatively decreased, i.e. 26.3 % in $\Delta D-D\mu FS$ and 25.4 % in $\Delta D-iD$ mice compared to 37.5 % in WT mice.

Flow cytometric analysis of bone marrow cells demonstrated a much more heterogeneous picture of cells (Fig. 9), but numbers of B and T lymphocytes were rather similar in both mutant mouse strains as well as in WT mice (Tab. 3).

Hence, compared to WT mice, both mutant mouse strains have significantly reduced amounts of total mononuclear cells as well as T and B lymphocytes in the spleen. However, the proportion of T cells among mononuclear cells was rather unchanged while B cell counts were significantly reduced. We therefore compared the concentrations of total IgM and IgG in mutant and BALB/c WT mice. Total IgM concentration of $\Delta D-D\mu FS$ mice ($\sim 144 \mu g/ml$) was comparable with that of WT ($\sim 153 \mu g/ml$), while $\Delta D-iD$ mice showed a slightly decreased IgM level of about $99 \mu g/ml$ (Fig. 10). Thus, amounts of IgM immunoglobulin were in the

same range in all 3 strains. IgG concentrations, however, were significantly reduced in both mutant strains (Fig. 10).

Table 3

FACS analysis of spleen and bone marrow cells of BALB/c wild-type and ΔD -iD and ΔD -D μ FS mutant mice

	Total mononuclear cell x E+05	Lymphocytes x E+05	T cell x E+05	B Cell x E+05
Spleen				
WT	197.6 \pm 24.5	118.2 \pm 15	29.2 \pm 8.3 (14.7 %)	74.2 \pm 17.6 (37.5 %)
ΔD -D μ FS	78.2 \pm 17.6	45.2 \pm 7.8	8.1 \pm 3.2 (10.3 %)	20.6 \pm 6.3 (26.3 %)
ΔD -iD	99 \pm 12.8	48.5 \pm 8.1	13.1 \pm 6.4 (13.2 %)	25.2 \pm 10.2 (25.4 %)
Bone marrow				
WT	8.02 \pm 1.46	0.42 \pm 0.105	0.037 \pm 0.012 (0.46 %)	0.33 \pm 0.12 (4.1 %)
ΔD -D μ FS	8.22 \pm 1.12	0.53 \pm 0.11	0.046 \pm 0.011 (0.55 %)	0.44 \pm 0.08 (5.3 %)
ΔD -iD	7.16 \pm 1.43	0.48 \pm 0.12	0.033 \pm 0.013 (0.46 %)	0.40 \pm 0.09 (5.5 %)

Legend

Spleen and bone marrow mononuclear cells were isolated by Histopaque gradient centrifugation. Cell numbers \pm standard error of the mean of five separately analyzed cell preparations are given for 1 spleen or refer to the bone marrow of two femurs of five 10-wk-old ΔD -iD, ΔD -D μ FS or wild-type BALB/c mice. The numbers and percentages of B (CD19⁺) and T (CD3⁺) cells are related to the amount of total mononuclear cells. Lymphocytes are calculated from gate P1 in Fig. 6 and 7.

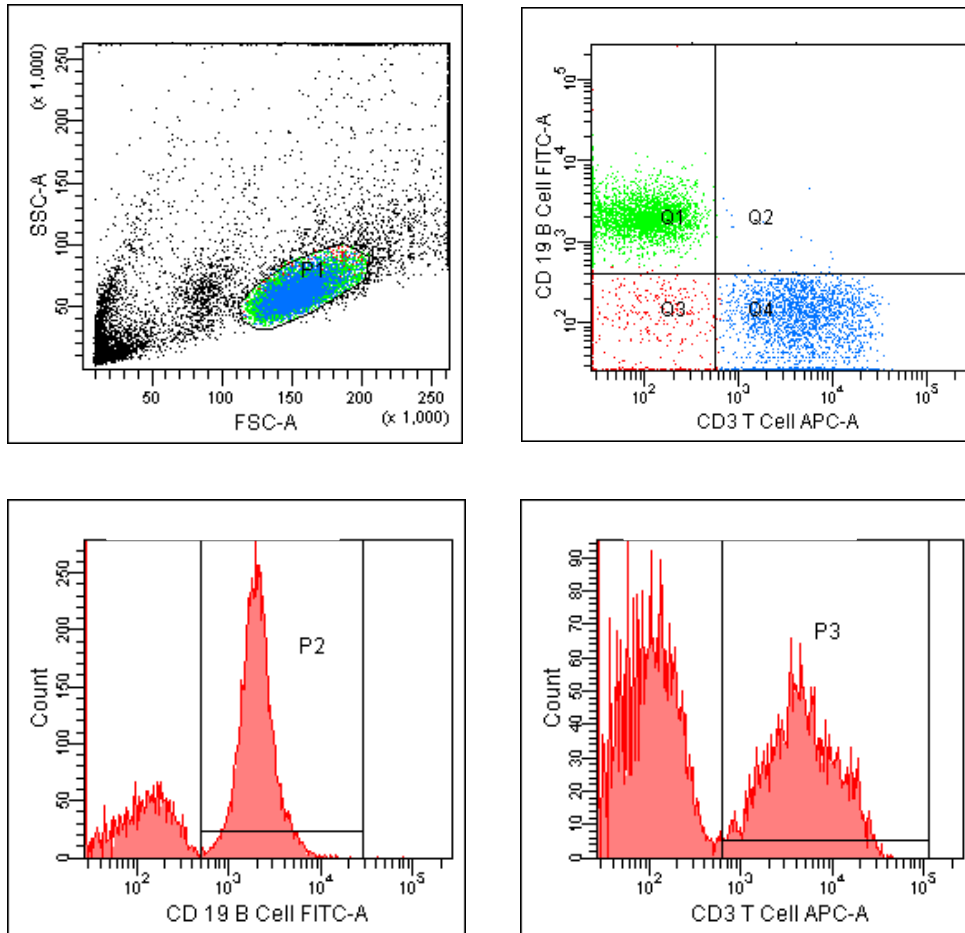

Figure 8

Flow cytometric analysis of splenic lymphocytes of homozygous ΔD -iD mice

Cells within the lymphocyte gate of spleen cells (upper left panel) were differentiated on the basis of CD19 and CD3 expression. The top right histogram shows the dot plot analysis of splenic B lymphocytes stained with FITC-labeled anti-CD19 versus T cells stained with APC-labeled anti-CD3. The lower two panels of gated splenic lymphocytes show the intensity of staining with both specific antibodies. P1, P2 and P3 represent the total number of lymphocytes, B and T cells, respectively. The data show representative staining of five separately analyzed spleen cell preparations. Cell viability (> 98 % data not shown) was estimated by staining with fluorescent marker 7-Aminoactinomycin D. The analysis of splenocytes of wildtype as well as homozygous ΔD -D μ FS mice gave similar results (data not shown). The average total numbers of different cells type in the spleen are depicted in Tab. 1.

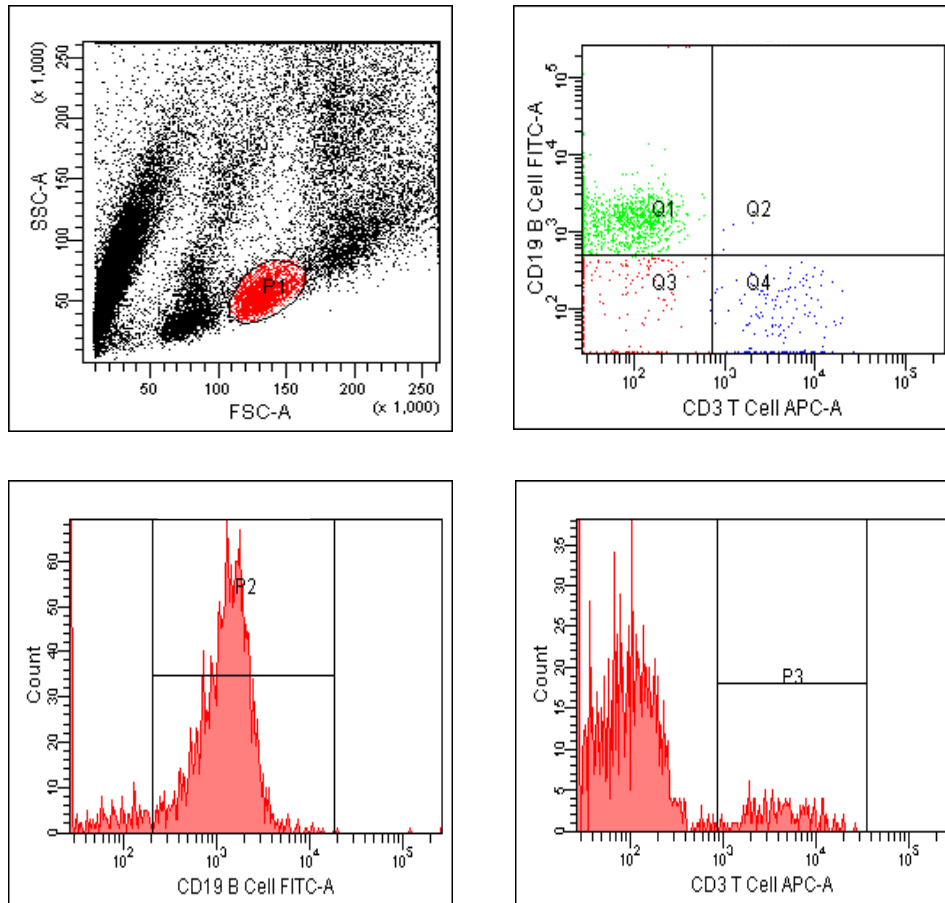

Figure 9

Flow cytometric analysis of bone marrow lymphocytes of homozygous ΔD -iD mice

Cells within the lymphocyte gate in the bone marrow (upper left panel) were differentiated on the basis of CD19 and CD3 expression. The top right histogram shows the dot plot analysis of BM B cells stained with FITC-labeled anti-CD19 versus T cells stained with APC-labeled anti-CD3. The lower two panels of gated BM lymphocytes show the intensity of staining with both specific antibodies. P1, P2 and P3 represent the total number of lymphocytes, B and T cells, respectively. The data show representative staining of five separately analyzed BM cell preparations. Staining with fluorescent marker 7-Aminoactinomycin D showed a cell viability of > 98 % (data not shown). The analysis of bone marrow cells of wildtype as well as homozygous ΔD -D μ FS mutant mice gave similar results (data not shown). The average total numbers of different cells type in the spleen are depicted in Tab. 3.

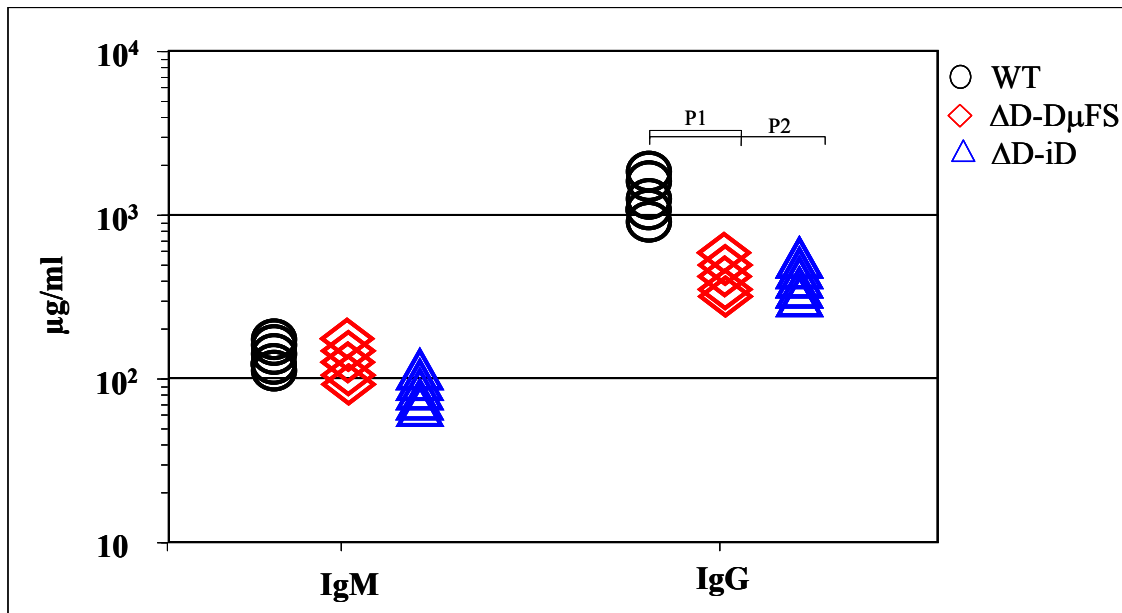

Figure 10

Total IgM and IgG concentrations in normal sera

Immunoglobulin concentrations of 10-weeks old ΔD -D μ FS (red lozenge), ΔD -iD (blue triangle) and WT (black circle) mice were determined with isotype-specific secondary antisera. $P1 < 0.0003$, $P2 < 0.0004$.

3.2 Comparison of phOx-specific background plasma cells and serum antibody concentrations

Hence, the question arose as to whether the observed global changes in the T and B cell compartments may influence the starting position for a specific immune response. Since WT BALB/c mice contain considerable concentrations of phOx-reactive antibodies in the serum [81], we first compared the background anti-phOx-secreting plasma cells and serum antibodies in mutant mice with that of WT mice. Plasma cells secreting phOx-specific IgM or IgG were determined with the Eli-spot assay. In this test, cells are incubated in culture wells on antigen-coated membranes so that secreted antibody can bind to the antigen-coated surface. After washing off the cells, bound antibody is detected with enzyme-labeled secondary antibody. Plasma cells are indicated by coloured spots as shown in Fig. 11. Surprisingly, compared to WT control mice, numbers of phOx-reactive IgM-secreting plasma cells were significantly enhanced in spleens as well as in the bone marrow of both mutant strains (Fig. 12). However, plasma cells secreting phOx-reactive IgG antibodies were missing in both transgenic strains as well as in WT mice (Fig. 12).

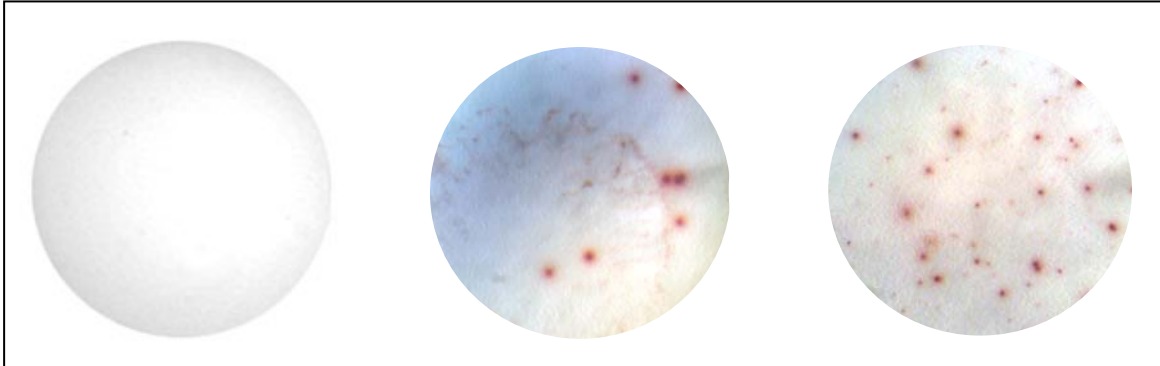

Figure 11

Determination of anti-phOx secreting splenic plasma cells with the ELI-spot assay

At an age of 10 weeks, BALB/c mice received a primary immunization with the TD antigen phOx-CSA. On day 7, mononuclear spleen cells were isolated by Histopaque gradient centrifugation. For determination of IgM and IgG anti-phOx secreting plasma cells, graded concentrations of mononuclear cells were incubated for 18 hr in phOx-BSA- or BSA-coated wells. Bound antibodies were detected with secondary antiserum to IgG (B) or IgM (C). In the negative control (A), wells were reacted with all reagents, but mononuclear cells were omitted. Splenocytes and bone marrow cells of $\Delta D-iD$ and $\Delta D-D\mu FS$ mice provided a similar pattern (data not shown). The average numbers of phOx-specific IgG- and IgM-secreting plasma cells were calculated as the difference between ELI-spots on phOx-BSA- and BSA-coated wells. ELI-spot numbers of BSA-reactive IgG as well as IgM were usually 10-15 % of phOx-BSA-reactive spots.

3.3 Comparison of the humoral anti-phOx immune response in D-mutant and wildtype BALB/c mice

We then compared the primary immune responses of all 3 mouse strains.

First, mice were stimulated with the type 2 thymus-independent form of the antigen, *i.e.* immunization was performed with the hapten phOx coupled to Ficoll in a ration of about 60:1. Despite the enhanced numbers of IgM-anti-phOx-secreting background plasma cells (Fig. 12), primary IgM (Fig. 13A) as well as IgG (Fig. 13B) response to this TI-2 antigen of all three mouse strains were rather similar and there was no significant difference.

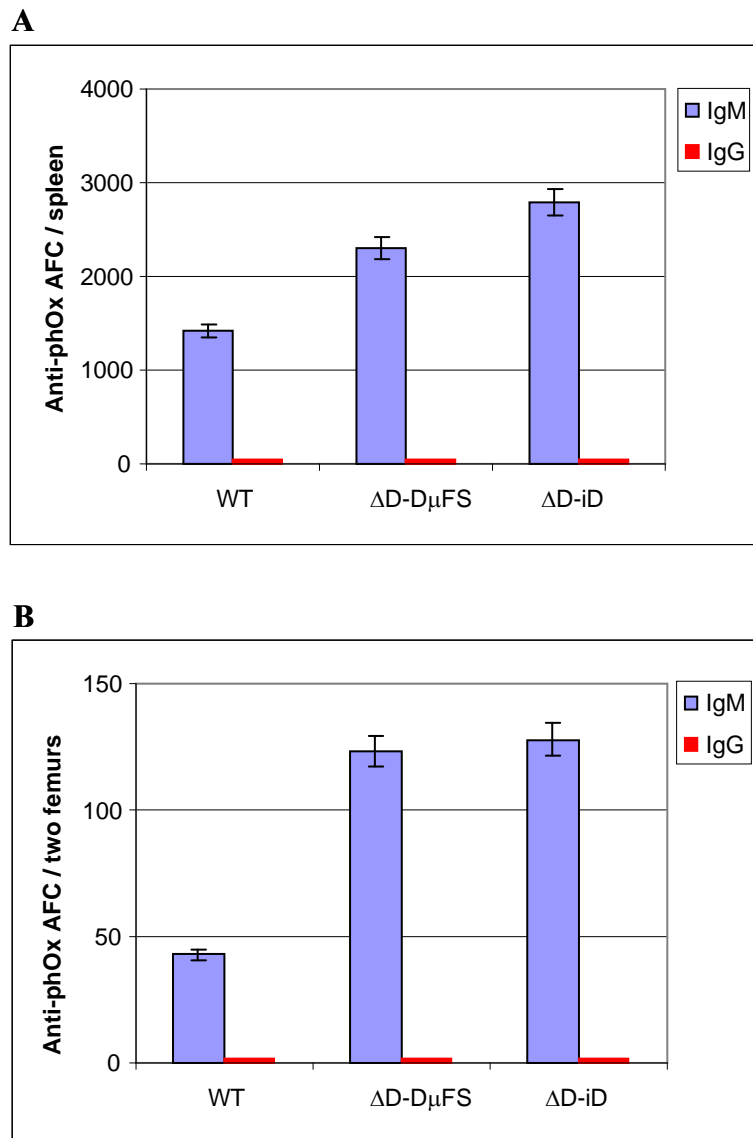

Figure 12

Anti-phOx antibody-secreting plasma cells in spleen (A) and bone marrow (B) of non-immunized mutant and wildtype BALB/c mice

For determination of IgM and IgG anti-phOx antibody-forming plasma cells (AFC), graded concentrations of Histopaque-isolated mononuclear cells were incubated for 18 hr in phOx-BSA- or BSA-coated wells and bound antibodies were detected with secondary antiserum to IgG or IgM. The number of phOx-specific antibody-secreting plasma cells was calculated as the difference of spots in phOx-BSA- and BSA-coated wells. The error bars indicate the standard error of the mean of five separate determinations.

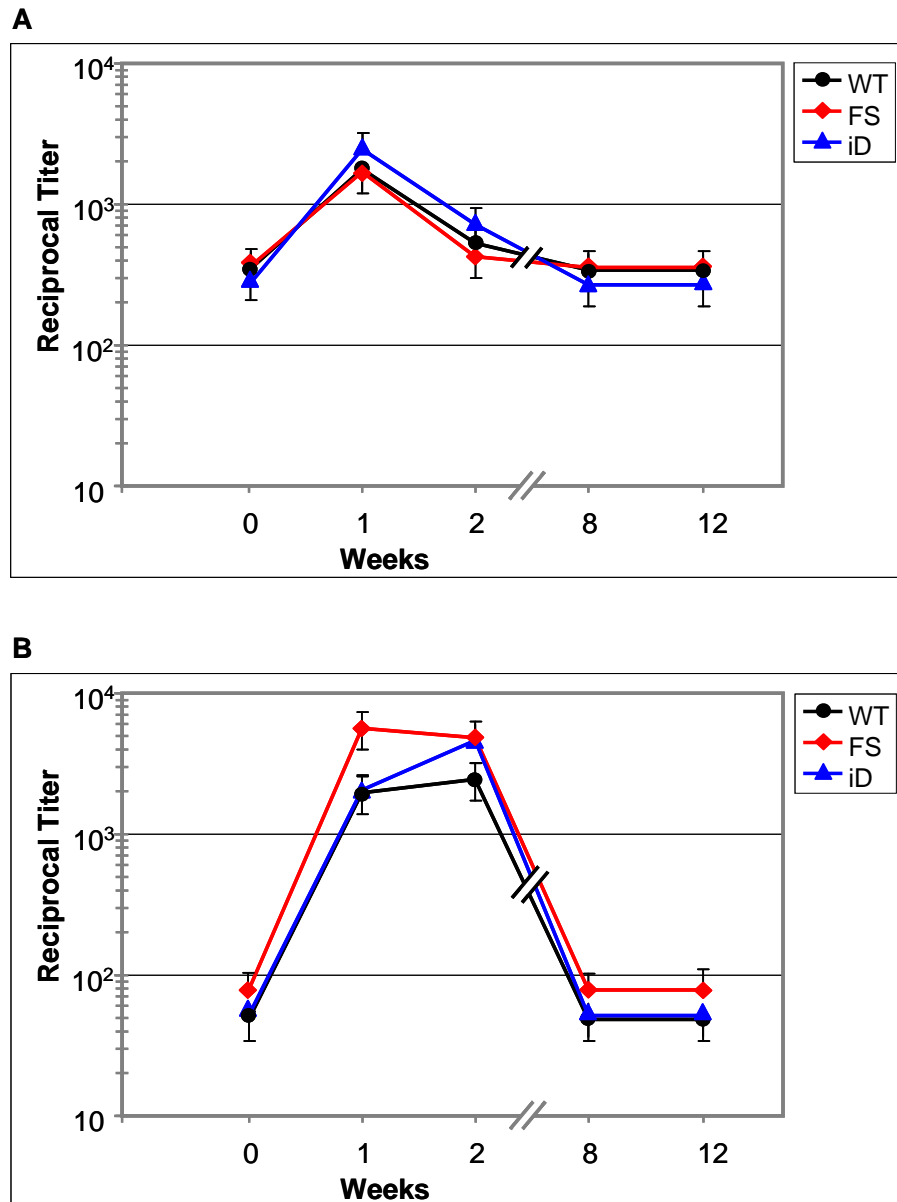

Figure 13

Primary anti-phOx humoral response after immunization with the TI-2 antigen phOx-Ficoll

IgM (A) and IgG (B) anti-phOx antibodies in the sera of 10-weeks old ΔD -D μ FS (red curve), ΔD -iD (blue curve) and WT mice (black curve) were determined at the given times points (weeks) after primary immunization with phOx-Ficoll at day 0. Background anti-phOx titers were evaluated in normal pre-immune sera.

Second, the TD response was induced with phOx-coupled CSA (phOx-CSA) and measured at the single cell level [antibody-forming cell response (AFC); Fig. 14] and by determination of serum antibody concentrations (Fig. 15). In WT BALB/c mice (Fig. 14), the primary IgM AFC-response on day 7 was hardly distinguishable from the level of background plasma cells shown in Fig. 12. In contrast, mice of both mutant strains ΔD -D μ FS and ΔD -iD showed a substantial increase of IgM AFC (Fig. 14A) which was at least twofold higher than that of WT mice. These IgM-secreting plasma cells seem to be recruited from the bone marrow since anti-phOx-secreting plasma cells in this organ are reduced 7 days after immunization (Fig. 14B). Interestingly, the average number of phOx-specific IgG-secreting cells of WT mice (276 pro spleen) was approximately fourfold higher than that of ΔD -D μ FS (64, $p < 0.0001$) and ΔD -iD mice (74, $p < 0.0001$) (Fig. 14A). This result seems to indicate an impaired class switch recombination in both mutant mouse strains.

In bone marrow, phOx-specific IgG-secreting cells were neither detectable in WT nor in transgenic mice (Fig. 14B).

The phOx-CSA-induced TD response was also measured by determining the humoral antibody concentrations after immunization. Despite the enhanced numbers of IgM anti-phOx-secreting plasma cells (Fig. 14), ΔD -D μ FS as well as ΔD -iD mutant mice developed reduced primary IgM TD responses and secondary IgM responses were barely visible in all three strains (Fig. 15A). The primary IgG response of both mutant strains developed with slower kinetics and maximal titers reached 2 weeks after immunization were about 5 times lower than in WT mice. In all three strains, the primary maximal titers remained for several weeks. When a secondary immunization with phOx-CSA was performed 14 weeks after primary stimulation, the difference between mutant and WT mice remained. Two weeks after secondary immunization, the mean anti-phOx IgG titer of WT (302000 [250000-350000]) was approximately sevenfold higher than ΔD -D μ FS (45800 [36000-60000]) and ΔD -iD mice (40200 [28000-45000]) (Fig. 15).

These data may allow the conclusion that in transgenic mice lower numbers of memory B cells are generated in the primary response and that this drawback can not be compensated for during the secondary response.

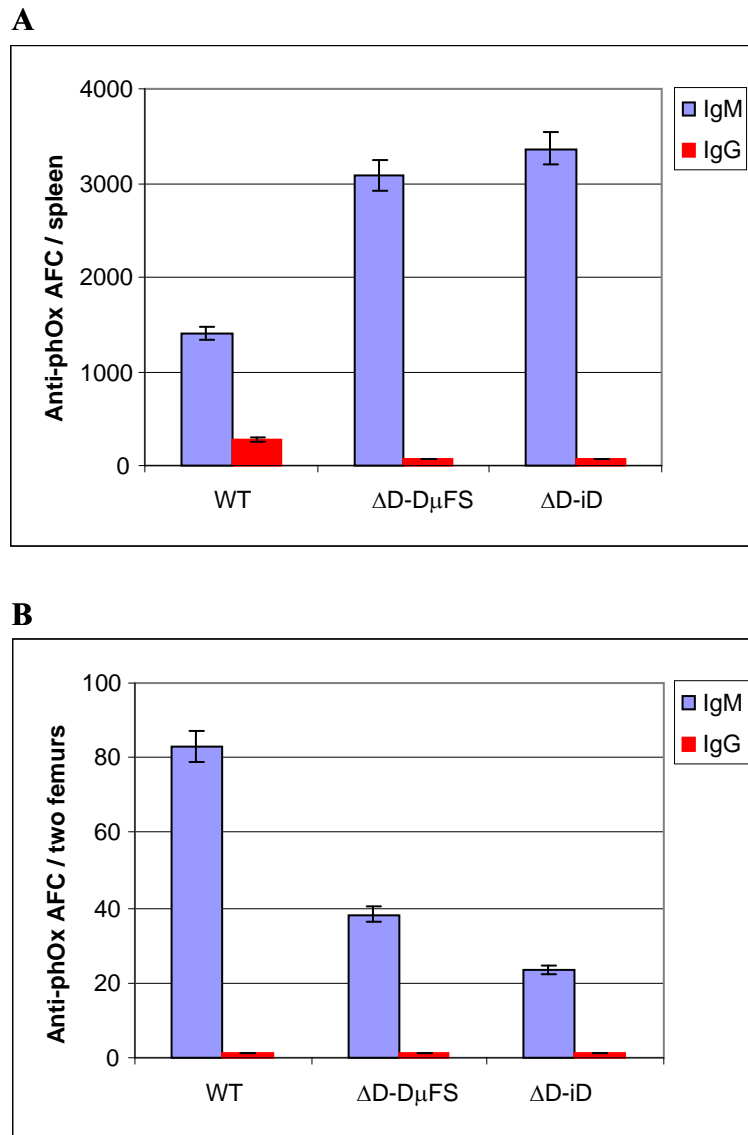

Figure 14

Primary Anti-phOx-secreting plasma cells in spleen (A) and bone marrow (B) of mutant and wild-type BALB/c mice

Seven day after primary i.p. immunization with the TD antigen phOx-CSA, spleen and bone marrow cells were isolated by Histopaque gradient centrifugation and phOx-reactive antibody-forming plasma cells (AFC) were determined with the ELI-spot assay. For further description see legend to Fig. 12. The error bars indicate the standard error of the mean of five separate determinations.

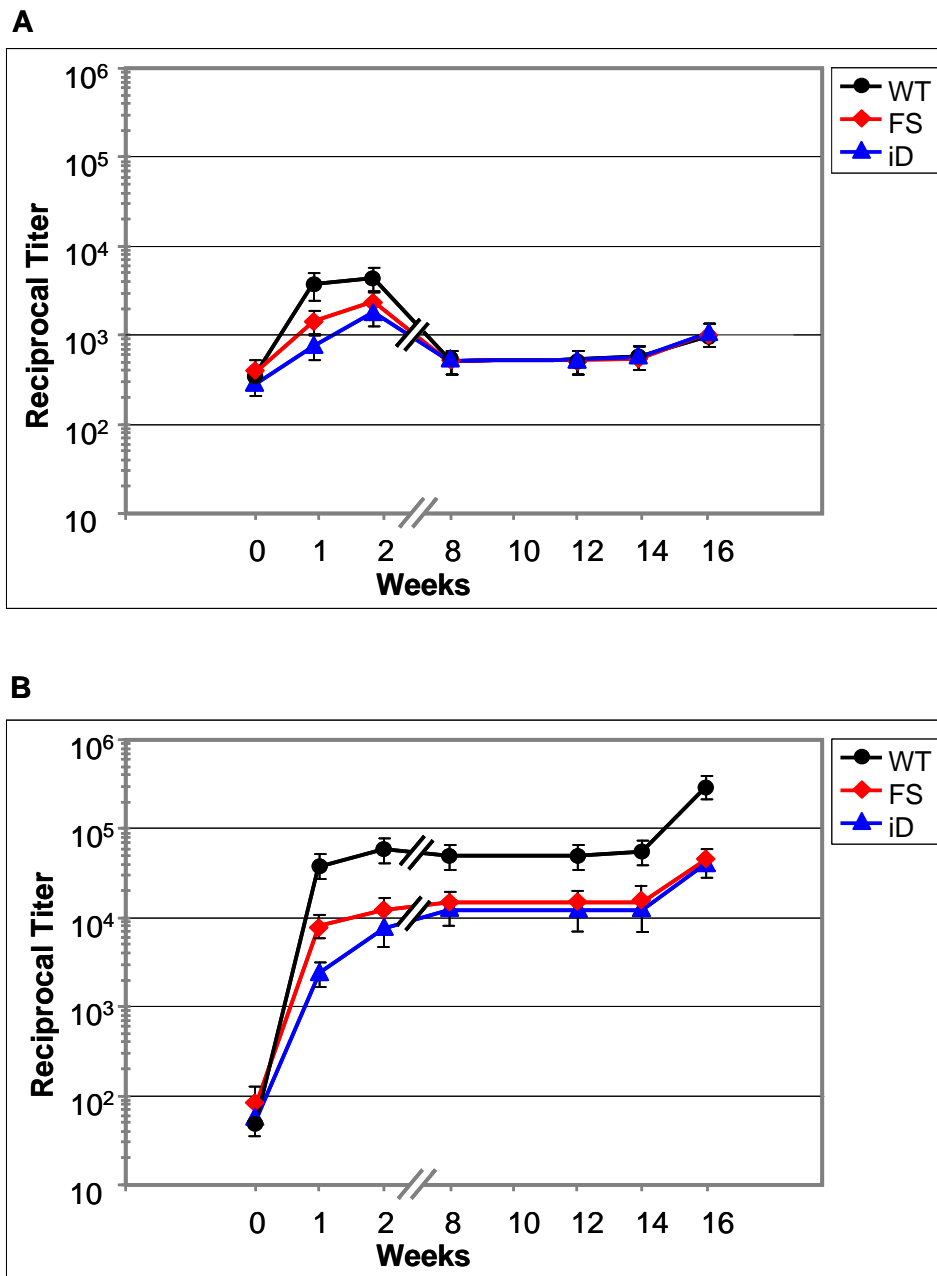

Figure 15

Primary and secondary anti-phOx humoral immune response of wildtype and mutant mice to the TD antigen phOx-CSA

IgM (A) and IgG (B) anti-phOx antibodies in the sera of 10-weeks old ΔD -D μ FS (red curve), ΔD -iD (blue curve) and WT mice (black curve) were determined after primary immunization at day 0 and secondary immunization 14 weeks later with phOx-CSA. Back ground anti-phOx titers were evaluated in pre-immune sera.

3.4 Analysis of variable genes of anti-phOx antibodies generated in Δ D-D μ FS and Δ D-iD mice

In the order to study the influence of DH gene segments on VH/VL gene usage, somatic mutation and affinity maturation, the TD immune response to the hapten-carrier complex phOx-CSA in Δ D-D μ FS and Δ D-iD mice, each of which carry a single modified DH gene segment, was studied at single cell level. To this end, mice of both strains were first immunized by i.p. injection of 80 μ g of phOx-CSA adsorbed to AL(OH)₃ and hybridomas were generated by fusion of immune spleen cells with the Ig non-secretor myeloma cell line Ag8.653. The primary immune response was analyzed at an early stage on day 7 and a late stage on day 14.

Furthermore, since the alteration in the DH locus obviously impaired the antibody production in the memory response (see 3.3), a set of hybridomas were also prepared after secondary and tertiary immunizations. Secondary immunization was performed 8 weeks after primary immunization also by i.p. injection of the same amount of antigen and the fusion was done three days later. The tertiary immunization followed two months later and cell hybridization was again performed on day 3.

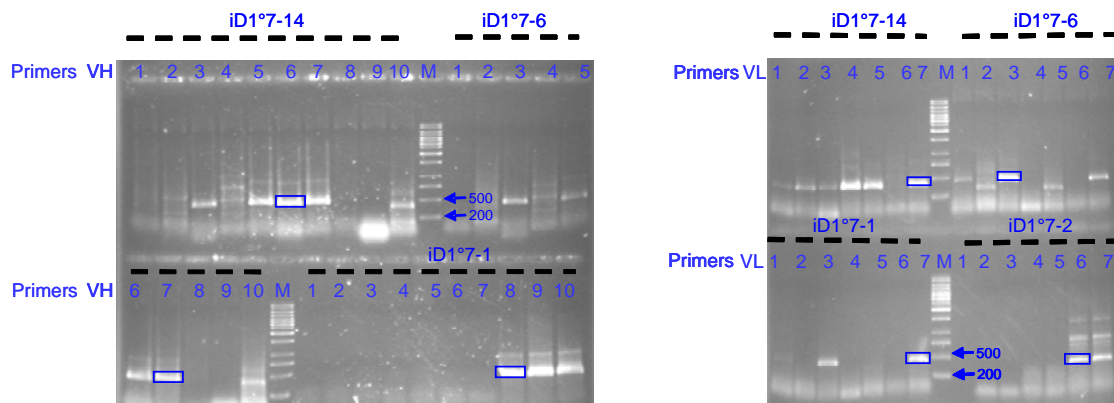

Figure 16

Amplification of variable region-coding sequences of anti-phOx antibodies

Here, the amplification of the variable region-coding sequences of heavy and light chains of antibodies iD°7-1, iD°7-2, iD°7-6 and iD°7-14 is shown. Amplification was performed with one of 10 VH and 7 VL variable primers in combination with respective constant primers.

(A) Amplification of heavy chain. (B) Amplification of light chain. The molecular size of the amplified DNA fragment can be estimated at approximately 450 base pair (bp). DNA fragments of interest are sliced out of the gel purified and used for sequencing (blue rectangle).

M - DNA marker.

Anti-phOx antibody-secreting hybridomas could be established from all stages of the primary to the tertiary immune response. RT-PCR was performed to amplify heavy and light chains of every positive clone (Fig. 16). Ten different primers were included for amplification of VH and seven different primers for amplification of VL. The size of amplified segments lies between 430 and 460 bp (Fig. 16). Despite amplification of all the clones, some of them could not be sequenced successfully, *i.e.* incomplete or bad quality of the nucleotide sequence. In those cases, repetition of the sequencing reaction was also ineffective.

3.5 Genetic analysis of phOx-reactive antibodies generated from Δ D-D μ FS mice

For an assessment of the genetic repertoire of both DH-mutant BALB/c variants it is essential to remember that it is to be compared with that of the anti-phOx repertoire of BALB/c WT animals. Therefore, the different characteristic molecular features of this response are repeated:

- 1.) The primary response is characterized by expression of a dominant clone with the canonical gene combination VH171/VL072. This Ox1-named idiotype (Id_{Ox1}) makes up 75 % of the IgG antibodies on day 7.
- 2.) The specific idiotope of Id_{Ox1} is related with the characteristic sequence aspartic acid-arginine-glycine (DRG) in the third hypervariable region of the heavy chain (HCDR3).
- 3.) The reactivity of Id_{Ox1} antibodies with syngeneic Id_{Ox1}-specific monoclonal anti-idiotypic antibodies is lost within 3 weeks by somatic mutations.
- 3.) Id_{Ox1} antibodies are of highest affinity while non-Id_{Ox1} have a 10-100-times lower one.
- 4.) Immune maturation is primarily based on the accumulation of somatic mutations occurring in Id_{Ox1} antibodies.
- 5.) Non-Id_{Ox1} antibodies encoded by alternative VH/VL genes appear during secondary and tertiary immune responses.
- 6.) The propensity of non-Id_{Ox1} antibodies for somatic mutations is known.

Hence, the primary genetic repertoire and the clonal development during memory responses in both mutant strains will be compared with these findings.

3.5.1 Genetic analysis of the phOx-reactive repertoire of Δ D-D μ FS mice

First, V region-coding sequences of anti-phOx antibodies will be described which were generated from TD responses of Δ D-D μ FS mice. These mice can only make use of a single DH

gene coding for hydrophobic amino acids in HCDR3. The complete amino acid sequences of V regions are showed in Fig. 1 in the appendix.

3.5.1.1 Analysis of primary anti-phOx antibodies

Primary repertoire

From the early primary day 7 TD response, 36 antibodies could be produced from two independent fusions (Tab. 4). The nomenclature of the antibodies is as follows: FS stands for Δ D-D μ FS mice and 1 $^{\circ}$ 7 indicates that the antibodies were generated after primary immunization and fusion on day 7. In both fusions, about half of the antibodies were of the IgM and IgG class, respectively.

The repertoire of the 18 IgM antibodies was extremely heterogeneous and every gene combination was unique. Hence, there was no dominant clone = idiotype. The Id_{Ox1} was not realized among IgM antibodies. Two IgM antibodies (FS1 $^{\circ}$ 7-09, FS1 $^{\circ}$ 7-10) expressed the VHOx1 gene VH171, but in combination with alternative light chains, namely V κ 078 and V κ 121, respectively. Antibody FS1 $^{\circ}$ 7-03 is encoded by the V κ Ox1 gene V κ 072 in association with alternative heavy chain gene VH627.

The repertoire of 17 IgG antibodies was as heterogeneous as that of IgM antibodies and again every gene combination was unique. However, antibody FS1 $^{\circ}$ 7-24 used the canonical Id_{Ox1} combination (VH171/V κ 072). The 2 antibodies FS1 $^{\circ}$ 7-27 and FS1 $^{\circ}$ 7-34 used the V κ Ox1 gene V κ 072 but in combination with a VH163 gene and an unknown VH gene, respectively. In addition, one IgA antibody was obtained.

- In conclusion, the TD antigen-activated repertoire of Δ D-D μ FS mice does not contain the Id_{Ox1} gene combination as a major component, neither among IgM nor among IgG antibodies.

Affinity of primary antibodies

Since the primary immune response reflects the first encounter of naive B cells with antigen, the dominance of Id_{Ox1} antibodies in the primary anti-phOx response of BALB/c WT mice was ascribed to their superior affinity for the hapten. Indeed, non-Id_{Ox1} antibodies of the IgM class were generally of much lower affinity. To elucidate the influence of a restriction to a single DH gene, coding for hydrophobic amino acids, on the affinity of the primarily stimulated antibodies, we measured the relative affinities of our antibodies in comparison to the IgM Id_{Ox1} H11.5 (μ , κ) and IgG Id_{Ox1} NQ2.16.2 (γ , κ) (Tab. 4). It is interesting to see that only

3 IgM were of very low affinity (FS1°7-01, -05 and -13), 3 exhibited slightly reduced affinities and 3 had similar affinities as the Id_{Ox1} control antibody H11.5 (μ , κ). Surprisingly, antibodies FS1°7-09 and -14 had significantly enhanced affinities.

Table 4

VH/VL gene combinations of pHox-CSA-induced primary day 7 anti-phOx antibodies of Δ D-D μ FS mice

MAb ^a	VH chain genes						VL chain genes					rel.
	FS1°7	Is ^b	Fam ^c	Cl ^d	IGHV ^e	p/s ^f	J	Fam ^c	Cl ^d	IGKV ^e	p/s ^f	J
01 ^h	μ	1	2	673	8/2	1	9B	1	121	0/0	2	0,01
02 ^h	μ	1	1	671	4/4	1	10	1	139	0/1	1	0,4
03 ^h	μ	1	2	627	12/3	1	4/5	1	072^k	1/0	4	0,4
04 ^h	μ	1	2	627	3/0	2	10	1	139	0/0	1	0,6
05 ^h	μ	1	1	532	4/1	2	4/5	1	078	0/0	2	0,03
06 ^h	μ	1	2	506	13/3	2	9B	1	121	1/0	1	0,8
07 ^h	μ	1	3	396	0/0	2	19/28	1	201	2/0	4	-
08 ^h	μ	1	3	386	5/1	3	9A	1	112	2/0	2	0,1
09 ^h	μ	2	1	171^k	1/0	3	4/5	1	078	-/-	4	4,5
10 ^h	μ	2	1	171^k	0/0	1	9B	1	121	0/0	2	0,6
11 ^h	μ	3	1	138	0/0	1	4/5	1	163	0/0	5	0,3
12 ⁱ	μ	3	1	138	1/1	2	19/28	1	157	0/0	2	-
13 ^h	μ	3	1	128	1/2	1	-	-	-	-/-	-	0,04
14 ^h	μ	3	1	120	0/1	3	21	1	066	2/2	1	5,2
15 ^h	μ	6	1	114	2/0	3	9B	1	106	1/0	2	-
16 ^h	μ	9	1	155	1/0	4	1	1	122	0/0	1	2,2
17 ⁱ	μ	-	-	-	-/-	-	4/5	1	154	0/0	2	-
18 ^h	μ	-	-	-	-/-	-	9B	1	121	0/0	2	-
19 ^h	γ	1	2	690	5/1	2	21	1	210	0/0	1	2,0
20 ^h	γ	1	2	690	5/5	1	24/25	1	123	0/0	2	1,8
21 ^h	γ	1	2	643	8/5	2	21	1	210	0/0	1	0,5
22 ^h	γ	1	1	532	3/0	2	4/5	1	077	1/1	2	0,5
23 ^h	γ	1	2	307	-/-	1	4/5	1	078	0/0	1	0,1
24 ^h	γ	2	1	171^k	1/0	3	4/5	1	072^k	0/0	5	0,5
25 ^h	γ	3	1	128	0/2	1	-	-	-	-/-	-	0,1
26 ^h	γ	3	1	128	3/1	1	4/5	1	143	10/1	5	2,7
27 ⁱ	γ	5	1	163	1/1	3	4/5	1	072^k	2/0	2	13,6
28 ^h	γ	5	1	163	1/2	4	23	1	168	1/1	4	14,1
29 ^h	γ	5	1	139	2/0	2	2	1	099	0/0	2	5,7
30 ⁱ	γ	6	1	114	1/0	3	1	1	115	0/0	2	1,8
31 ^h	γ	7	1	158	1/0	4	21	1	210	2/1	2	0,08
32 ^h	γ	14	1	125	4/0	3	10	1	108	0/0	1	-
33 ^h	γ	14	1	125	1/0	3	12/13	1	172	4/4	4	2,0
34 ^h	γ	-	-	-	-/-	-	4/5	1	072^k	1/0	4	-
35 ^h	γ	-	-	-	-/-	-	1	1	179	-/-	1	115
36 ^h	α	14	1	125	3/0	3	12/13	1	172	2/0	2	-

Legend

^a – The annotation of antibodies indicates their generation from Δ D- D μ FS mice (FS), after

- primary immunization (1°) on day 7 (7) and is followed by a sequential number.
- ^b – Isotype of the monoclonal antibody.
 - ^c – Indication of VH or VL gene family in the VBASE2 integrative database.
 - ^d – In the integrative database VBASE2, the genes are classified: for class 1 genes there is genomic and rearranged evidence, for class 2 genes only genomic evidence and for class 3 genes only rearranged evidence.
 - ^e – VH and VL gene numbers according to the integrative database VBASE2.
 - ^f – Productive (p) and silent (s) mutations of corresponding VH and VL chains.
 - ^g – The relative affinities were measured in a hapten inhibition test in comparison to Id_{Ox1} IgM and IgG anti-phOx antibodies, respectively.
 - ^{h,i} – Indication of different fusions.
 - ^k – Id_{Ox1} genes VH171 and Vκ072 are marked in bold.
 - – Sequence not determined.
- Grey background shows the Id_{Ox1} gene combination VH171/Vκ072.

A similar picture emerged in IgG antibodies. Some of them had lower and some had rather similar affinities as the IgG Id_{Ox1} control antibody NQ2/16.2. Strikingly, 4 non-Id_{Ox1} antibodies exhibited clearly enhanced affinities and one of them (FS1°7-35) had an even 100-times higher affinity.

Conclusion:

- Thus, the pre-immune repertoire contains clonotypes exhibiting clearly higher affinities than the normally dominant Id_{Ox1}.

Mutations in early primary antibodies

Somatic mutation is targeted to the rearranged immunoglobulin V-gene itself and their intronic flanking sequences. In cells harbouring hypermutated V-genes, the constant (C) and un-rearranged V genes are usually not modified. After intraperitoneal injection of a TD antigen, activated B cells migrate into the primary follicles of peripheral lymphoid organs where they undergo intense proliferation and form germinal centers, which appear towards the end of the first week after challenge and provide the location for both hypermutation and antigen selection.

We compared the V region sequences with those of the next related known V genes and counted the numbers of silent and productive mutations (Tab. 4). This comparison did not reveal any alteration from mutation rates seen in WT mice. The majority of light chain sequences of IgM anti-phOx antibodies was not mutated or contained less than 2 mutations per chain. In contrast, few VL genes of IgG antibodies showed clearly mutated Vκ genes, *i.e.* FS1°7-26 and -33 with 11 and 8 mutations, respectively.

When comparing mutations in VH, it is striking to see that all IgM encoded by VH1 family genes contain rather high mutation rates except antibody FS1°7-07 with no mutations. Aston-

prisingly, VH1 family-encoded IgM showed no or very few mutations in VL. This disparity is not seen in the other IgM antibodies, but again in VH1 family-encoded IgG antibodies FS1°7-19 to -22. Since the entire number of VH1 family genes is not known it can be assumed that the observed differences do not represent real mutations, but indicate hitherto unknown genes of this family.

It is widely accepted that VH genes show higher mutation rates than VL genes [64, 82-84]. One example of this kind seems to be IgG antibody FS1°7-32 with 4 productive mutations in VH, but no mutations in VL. However, the opposite situation is found in antibody FS1°7-33 with only 1 productive mutation in VH, but 4 productive plus 4 silent mutations in VL. This situation has already been observed in a previous investigation [46].

Conclusions:

- The mutation rates of early primary phOx-CSA-induced antibodies in Δ D-D μ FS mice differed not significantly from those of BALB/c WT mice. Thus, the alteration in the DH locus did not influence the mutation rate at this stage of immune response.

HCDR3 nucleotide sequences of early primary antibodies

The comparison of D-region nucleotide sequences of the early primary anti-phOx antibodies of Δ D-D μ FS mice with the genomic DH gene sequence is depicted in Tab. 5. As proposed by Kaartinen and Mäkelä [30], we assumed that an identity of at least 6 successive nucleotides with the genomic sequence, interrupted by no more than 1 mismatched nucleotide, proves that the genomic DH gene is verified in a particular antibody. If so, HCDR3 sequences of 7/13 IgM and 11/18 IgG could be traced back to the genomic D gene. However, one IgM and 3 IgG had identical sequences of 4 nucleotides (marked in blue in Tab. 5). It is difficult to decide if this sequence is derived from the genome or generated during the recombination process.

As stated above, the vast majority of antibodies, including those with phOx-specificity, use DH reading frame 1 (RF1) which favors tyrosine and glycine residues [30] while RF2 and RF3 are counter selected on the basis of stop codons and/or hydrophobic encoded nucleotides. However, the analysis of CDR3 sequences of the early primary anti-phOx antibodies from Δ D-D μ FS mice showed quite a different picture. Only 3/13 IgM and 4/18 IgG antibodies used RF1 in HCDR3, 4/13 IgM and 7/18 IgG used RF2 and in 6/13 IgM and 7/18 IgG the reading frame could not be assigned.

Table 5

Nucleotide sequences of HCDR3 of phOx-CSA-induced primary day 7 anti-phOx antibodies generated from Δ D-D μ FS

FS1°7		----VH ^a ----	-----DH ^b -----	----JH ^c ----	RF ^d
	DH gene		T TTT ATT ACT ACG GTA GTT AGC TAC		1
05	μ	TGT GCA AGA	TGG GGC TCT ATT ACT AAG GTA GTT AGT	GTC TAC TGG	1
06	μ	TGT GCA AGT	G TGT ATT ACT ACG GTA GA	GAC TGC TGG	2
10	μ	TGT GCA GGA	G TCC ATA ATT ACT ACG GTA GTT ACG GGT GGT ACT TC	GAT GTC TG	2
12	μ	TGT GCA CTC	TTT ACT ACG GTA GTT AGC TAC GTA CTT TTT	GAC TAC TGG	1
14	μ	TGT GCA AGA	G TTT ACT ACG AAG ACG GGT TT	GCT TAC TGG	2
15	μ	TGT GCG GGC	GTA GTT AGG TTT	GCT TAC TGG	1
16	μ	TGT GCA AGA	G ATT ATT ACT ACG AGG GTA TG	GAC TAC TGG	2
03	μ	TGT GCA AGG	G GGT ACT TC	GAT GTC TGG	nf
04	μ	TGT GCA AGA	GCG AAC TTT	GAC TAC TGG	nf
07	μ	TGT GCA ATA	CGA	GAC TAC TGG	nf
08	μ	TGT GCA AGG	GCT ACG GCC ATG GGG GCC TGG TTT	GCT TAC TGG	nf
09	μ	TGT GCC AGA	CTG ACC CAG ACG TTT	GCT TAC TGG	nf
13	μ	TGT GCA AGG	CGG TAC TTC	GAT GTC TGG	nf
11	γ	TGT GCA AGA	TTT ACT ACG GTA GTT TGC TAC TGG TAC TTC	GAT GTC TGG	1
19	γ	TGT GCA AGT	G TAG CTA ACT ACC GTA GTA ATA AAC GAG GGG AA	AAC TAC TGG	2
20	γ	TGT GCA GTT	ATT ACT ACG GTA GCC CCC	GAT GTC TGG	1
21	γ	TGT GCA AGA	AGA GTT AGC TAC GGA AAC TAC TTT	GAC TAC TGG	1
22	γ	TGT GCA AAT	T ACT ACG GTA CCT CCT TT	GAC TAC TGG	2
23	γ	TGT GCA AGG	G CCT ATT ACT ACG GC	GAT GTC TGG	2
27	γ	TGT GCA AGC	C ATT ACT ACG GTA CCC CTT TT	GCT TAC TGG	2
30	γ	TGT GCC AGG	C CGG GTT ACG GTA GTC CCT GGT TT	GCT TAC TGG	2
31	γ	TGT GCA AGA	CCT ACG GTA GTT AGC TTC TAT GCT ATG	GAC TAC TGG	1
33	γ	TGT GCT CTT	T ATT ACT ACG GTA GTG GGA CCT GGT TT	TCT TAC TGG	2
36	γ	TGT ACT AGC	T ACC GGC AGG CCT ACG GTA GTT CCT GGT TT	GCT TAC TGG	2

01	γ	TGT GCA AGA	GGG TAC TTC	GAT GTC TGG	nf
24	γ	TGT GCC AGA	GAT CCC GGG	GCT TAC TGG	nf
25	γ	TGT GCA AGG	CGG TAC TTC	GAT GTC TGG	nf
26	γ	TGT GCA AGA	GGA CTC TTA GTT TAC TGG TAC TTC	GAT GTC TGG	nf
28	γ	TGT GCA AGA	CAT AAC AAC TAT GCT ATG	GAC TAC TGG	nf
29	γ	TGT GCA AGA	TCG CCC GGA	GAC TAC TGG	nf
32	γ	TGT GTC CCG	GTG GCC TGG TTT	GCT TAC TGG	nf

Legend

^a – VH-encoded base of HCDR3.

^b – DH nucleotides of the HCDR3-loop.

^c – JH-encoded base of HCDR3.

^d – Reading frame of DH gene.

inv – inverted.

nf – not found.

Nucleotides marked in green (≥ 6 successive nucleotides) correspond to DH germline sequence in ΔD -D μ FS mice.

Nucleotides marked in red are generated by N and P region insertions.

Nucleotides marked in blue (4 or 5 successive nucleotides) correspond probably to DH germline sequence in ΔD -D μ FS mice.

DH germ line coding sequence of ΔD -D μ FS is outlined in first line in green colour.

Conclusions:

- It seems that RF1 which codes for hydrophobic amino acids is counter selected during the generation of the primary repertoire ΔD -D μ FS mice, harbouring only 1 non-natural = artificial gene in the DH locus.

HCDR3 amino acids in early primary antibodies in ΔD -D μ FS mice

The lengths of the HCDR3-loops of the early primary anti-phOx antibodies from ΔD -D μ FS mice are shown in Tab. 6. The HCDR3 lengths vary in a wide range from only 1 to 12 amino acids. It seems that the average length correlates with the used reading frame, *i.e.* antibodies in which the D region is encoded by RF1 or RF2, *i.e.* with 'green amino acids', have longer HCDR3 loops than those antibodies in which the reading frame could not assigned, *i.e.* they only contain 'red amino acids'. HCDR3 loops of 'green' IgM and IgG antibodies have an average length of 7.85 and 8.09 amino acids, respectively. In IgM and IgG antibodies containing only 'red' amino acids, the D region loops have on average 3.83 and 4.1 amino acids, respectively.

Antibody FS1^o7-24 which is encoded by the canonical Id_{Ox1} gene combination VH171/V κ 072 has a D loop with amino acids DPG which is rather similar to the DRG of Id_{Ox1} antibodies. Therefore, we tested these primary antibodies with our prototypic Id_{Ox1}-specific monoclonal antibody 8-21/W18. It turned out that none of these primary antibodies were Id_{Ox1} positive. Hence, the substitution of the middle R with P destroys the idiotope recognized by syngeneic Id_{Ox1}-specific antibodies, although the following base of the loop contains alanine and tyrosine (AY) which are also expressed in Id_{Ox1} antibodies. This confirms a previous observation that an exchange of R with P destroys the Id_{Ox1} quality (Lange et al., 2008).

In conclusion:

- The extreme variability of HCDR3 length suggests that the D region is not of prime importance for the phOx-specificity of ΔD -D μ FS mice primary antibodies.
- The more D gene nucleotides are eliminated by exonucleases during VDJ recombination in the course of generation of the pre-immune repertoire, the shorter the HCDR3 length will be.

Table 6

Predicted amino acid sequences of HCDR3 of pHox-CSA-induced primary day 7 anti-pHox antibodies generated from Δ D-D μ FS mice

FS1°7		Base ^a	CDRH3-loop ^b	Base ^c	RF ^d	H ^e
05	μ	CAR	WGSITKVVS	VYW	1	0.38
06	μ	CAS	VYYYGR	DCW	2	-0.08
10	μ	CAG	VHNYYSYGWYF	DVW	2	-0.04
12	μ	CAL	FTTVVSYVLF	DYW	1	0.78
14	μ	CAR	VYYEDGF	AYW	2	-0.28
15	μ	CAG	VVRF	AYW	1	0.75
16	μ	CAR	DYYYEGM	DYW	2	-0.28
03	μ	CAR	GYF	DVW	nf	0.28
04	μ	CAR	ANF	DYW	nf	0.28
07	μ	CAI	R	DYW	nf	-1.3
08	μ	CAR	ATAMGAWF	AYW	nf	0.5
09	μ	CAR	LTQTF	AYW	nf	0.27
13	μ	CAR	RYF	DVW	nf	-0.15
11	γ	CAR	FTTVVCYWYF	DVW	1	0.55
19	γ	CAS	VANYRSNKRGE	NYW	2	-0.42
20	γ	CAV	ITTVAP	DVW	1	0.59
21	γ	CAR	RVSYGNYF	DYW	1	-0.026
22	γ	CAN	YYGTSF	DYW	2	0.07
23	γ	CAR	AYYYG	DVW	2	-0.002
27	γ	CAS	HYYGTPF	AYW	2	-0.1
31	γ	CAR	PTVVSFYAM	DYW	1	0.56
30	γ	CAR	PGYGSWPF	AYW	2	0.03
33	γ	CAL	YYYGSGTWF	SYW	2	0.004
36	γ	CTS	YRQAYGSSWF	AYW	2	-0.12
01	γ	CAR	GYF	DVW	nf	0.28
24	γ	CAR	DPG	AYW	nf	-0.44
25	γ	CAR	RYF	DVW	nf	-0.15
26	γ	CAR	GLLVYWYF	DVW	nf	0.6
28	γ	CAR	HNNYAM	DYW	nf	-0.26
29	γ	CAR	SPG	DYW	nf	-0.14
32	γ	CVP	VAWF	AYW	nf	0.83

Legend

- ^a – VH-encoded base of HCDR3.
^b – Predicted amino acid sequence of the HCDR3 loop.
^c – JH-encoded base of HCDR3.
^d – Reading frame of DH gene.
^e – The average, normalized Kyte-Doolittle hydrophobicity of the HCDR3 loop [72, 73].

Amino acids marked in green correspond to DH germline sequence in Δ D-D μ FS mice.

Amino acids marked in red are generated by N and P region insertions.

nf – not found

3.5.1.2 Analysis of late primary anti-phOx antibodies

Clonal development in the late primary response

Next, we prepared anti-phOx antibody-secreting hybridomas 14 days after primary immunization with the TD antigen phOx-CSA. From the established 16 clones, 9 (56 %) secreted IgM and 7 (44 %) secreted IgG antibodies (Tab. 7). This is in clear contrast to the control response in BALB/c WT mice where the vast majority of the anti-phOx forming cells at this stage of immune response produce IgG antibodies. Furthermore, while in WT mice there is a clear preference for Id_{Ox1} antibodies as a dominant clonotype, Δ D-D μ FS mice did not develop any dominant clone. The VHOx1 gene VH171 is only expressed in antibody FS1°14-11 and the V κ Ox1 gene V κ 072 was not used at all. Thus, no clone was encoded by the Id_{Ox1} canonical gene combination VH171/V κ 072.

Conclusions:

- The development of the dominant Id_{Ox1} clonotype obviously depends on the available DH gene repertoire and can not or only very rarely (see previous section) be generated from the non-natural DH gene of Δ D-D μ FS mice.

Mutations in late primary antibodies

The mutation rates of these late primary anti-phOx antibodies were higher than those of the early primary antibodies (Tab. 4). This is especially the case if one only looks at those antibodies which are encoded by VH and VL class 1 genes and disregards uncertain mutations in antibodies encoded by class 2 genes. (Classification of variable genes as *class 1* rests on genomic as well as rearranged evidence while for class 2 genes, there is only genomic evidence and so far such genes have not been observed in known antibodies.) However, the numbers of mutations in VH differ greatly and range from 0 in antibody FS1°14-06 and -07 to 11 mutations in antibody FS1°14-08. Collectively, IgG antibodies seem to contain more mutations than IgM antibodies. Moreover, the observed mutation rates in these late primary anti-phOx antibodies of Δ D-D μ FS mice are comparable with those of BALB/c WT mice. The VH/VL ratio of mutations is in accord with the above mentioned rule that VH contain more mutations than VL. A ratio of productive to silent mutations greater than 1 (Tab. 7) indicates an antigenic selection of the produced clones.

Conclusions:

- Late primary anti-phOx antibodies in Δ D-D μ FS mice contain an astonishingly high number of non-switched IgM antibodies.

- An immune maturation is indicated by enhanced mutations rates, but the mutations do not accumulate in a particular clone.

Table 7

VH/VL gene combinations of pHox-CSA-induced primary day 14 anti-pHox antibodies in ΔD -D μ FS mice

MAb ^a	VH chain genes						VL chain genes					rel.
	FS1 ^o 14	Is ^b	Fam ^c	Cl ^d	IGHV ^e	p/s ^f	J	Fam ^c	Cl ^d	IGKV ^e	p/s ^f	J
01	μ	1	2	569	2/0	2	4/5	1	077	0/0	2	-
02	μ	1	1	532	1/0	3	2	1	097	1/0	4	-
03	μ	1	2	495	5/0	3	4/5	1	166	0/0	1	-
04	μ	1	2	286	1/0	1	4/5	1	166	0/0	2	-
05	μ	1	2	073	4/1	3	10	1	129	3/0	2	-
06	μ	5	1	147	0/0	2	23	1	179	0/0	4	-
07	μ	9	1	155	0/0	3	4/5	1	082	0/0	4	-
08	μ	9	1	118	6/5	4	2	1	097	0/0	1	-
09	μ	-	-	-	-/-	-	4/5	1	166	0/0	2	-
10	γ	1	1	480	3/0	3	1	1	115	2/1	5	-
11	γ	2	1	171^k	5/4	3	4/5	1	142	5/1	4	-
12	γ	5	1	192	1/2	2	-	1	-	-/-	-	-
13	γ	5	1	139	1/1	3	9A	1	103	1/0	4	-
14	γ	7	1	168	6/1	3	1	1	115	4/0	2	-
15	γ	7	1	158	5/2	3	-	1	-	-/-	-	-
16	γ	14	1	125	3/0	3	12/13	1	172	2/0	2	-

Legend

- ^a – The annotation of antibodies indicates their generation from ΔD -D μ FS mice (FS), after primary immunization (1^o) on day 14 (14) and is followed by a sequential number.
All clones are generated from the same fusion.
- ^b – Isotype of the monoclonal antibody.
- ^c – Indication of VH or VL gene family in the VBASE2 integrative database.
- ^d – In the integrative database VBASE2, the genes are classified: for class 1 genes there is genomic and rearranged evidence, for class 2 genes only genomic evidence and for class 3 genes only rearranged evidence.
- ^e – VH and VL gene numbers according to the integrative database VBASE2.
- ^f – Productive (p) and silent (s) mutations of corresponding VH and VL chains.
- ^k – Id_{Ox1} genes VH171 and V κ 072 are marked in bold.
- - Sequence not determined.

Table 8

Nucleotide sequences of HCDR3 of phOx-CSA-induced primary on day fourteen anti-phOx antibodies generated from Δ D-D μ FS

FS1°14	----VH ^a ----	-----DH ^b -----	----JH ^c ----	RF ^d
DH gene		T TTT ATT ACT ACG GTA GTT AGC TAC		1
01 μ	TGT GCA AGA	T CCT ATT ACT ACG GTA GGG CCT TT	GAC TAC TGG	2
02 μ	TGT GCA AGA	G GTT ACT ACG GTA GCT CCT GGT TT	GCT TAC TGG	2
04 μ	TGT GCA AGA	T CAG ACT ACG GTA GTT ACG ACT GGT ACT TC	GAT GTC TGG	2
06 μ	TGT GCA AGA	C ATC CGG TAG TTA GCA TGT ACT ACT TT	GAC TAC TGG	2
03 μ	TGT GCA AGA	TGG GAG	GCT TAC TGG	nf
05 μ	TGT GCA AGA	GAC GGG GGT	GCT TAC TGG	nf
07 μ	TGT GCA AGA	AAG GGG GCT ACC GTC ACT TTT AGG GTG TTT	GCT TAC TGG	nf
08 μ	TGT GCC AGA	TTT ATG GTA GTT TGG GGT TCT ATG	GAC TAC TGG	nf
10 γ	TGT GCA AGA	TCT GAT TTT ATT ACT CAC GCC TGG TTT	GCT TAC TGG	1
12 γ	TGT GCA AGA	CTG AGT ACT ACG GCG	GAC TAC TGG	1
14 γ	TGT TCA AGA	G GCC ATT ACT ACG GCT CCT GGT TT	GCT TAC TGG	2
15 γ	TGT GCA AGA	G GGG ATT ACT ACG GTT GTT GGT TT	GCT TAC TGG	2
16 γ	TGT GCT AGC	TTT TTT ATT ACT ACG GTA GTT AGG	GCT TAC TGG	1
11 γ	TGT GCC AGA	GAT TTC GGT	AAG GAC TGG	nf
13 γ	TGT GCA AAA	GAC TAC GGT	GTC GGG TGG	nf

Legend^a – VH-encoded base of HCDR3.^c – JH-encoded base of HCDR3.

inv – inverted.

^b – DH-nucleotides of the HCDR3-loop.^d – Reading frame of DH gene.

nf – not found.

Nucleotides marked in green (≥ 6 successive nucleotides) correspond to DH germline sequence in Δ D-D μ FS mice.

Nucleotides marked in red are generated by N and P region insertions.

Nucleotides marked in blue (4 or 5 successive nucleotides) correspond probably to DH germline sequence in Δ D-D μ FS mice.DH germ line coding sequence of Δ D-D μ FS is outlined in first line in green colour.

Table 9

Predicted amino acid sequences of HCDR3 of phOx-CSA-induced primary on day fourteen anti-phOx antibodies generated from Δ D-D μ FS mice

FS1°14		Base ^a	CDRH3-loop ^b	Base ^c	RF ^d	H ^e
01	μ	CAR	SY YYGRA F	DYW	2	-0.04
02	μ	CAR	G YYGS SW F	AYW	2	0.04
04	μ	CAR	SD YGS YD WY F	DVW	2	-0.2
06	μ	CAR	HP VVSM YY F	DYW	2	0.35
03	μ	CAR	WE	AYW	nf	-0.57
05	μ	CAR	DGG	AYW	nf	-0.31
07	μ	CAR	KG ATV TFR V F	AYW	nf	0.37
08	μ	CAR	FM VVW GSM	DYW	nf	0.71
10	γ	CAR	SDF ITHAW F	AYW	1	0.27
12	γ	CAR	LSTTA	DYW	1	0.39
14	γ	CSR	GH YYGS W F	AYW	2	-0.07
15	γ	CAR	GD YYG CW F	AYW	2	0.06
16	γ	CAS	FF ITTV VR	AYW	1	0.71
11	γ	CAR	DFG	KDW	nf	0.04
13	γ	CAK	DYG	VGW	nf	-0.41

Legend

- ^a – VH-encoded base of HCDR3.
^b – Predicted amino acid sequence of the HCDR3 loop.
^c – JH-encoded base of HCDR3.
^d – Reading frame of DH gene.
^e – The average, normalized Kyte-Doolittle hydrophobicity of the HCDR3 loop [72, 73].

Amino acids marked in green correspond to DH germline sequence in Δ D-D μ FS mice.

Amino acids marked in red are generated by N and P region insertions.

nf – not found

HCDR3 nucleotide sequences of late primary antibodies

The nucleotide sequences of the late primary antibodies are depicted in Tab. 8. Ten of these 16 antibodies (62 %) contained 6 or more successive nucleotides derived from the germ line DH gene segment with more or less modifications at both boundaries of VDJ joining sites. The other 6 antibodies (37 %) showed no homology with the germ line DH segment.

As already observed in early primary antibodies of Δ D-D μ FS mice, RF1 usage was reduced in late primary antibodies in favor of RF2 (37 %) or a situation that the reading frame could not be determined. With antibodies FS1°14-07 and -8 as exceptions, HCDR3 loops were longer in antibodies with germ line-related than in those with non-related DH nucleotide sequences.

Conclusions:

- Late primary anti-phOx antibodies of ΔD -D μ FS mice preferably use germ line-related HCDR3 nucleotides sequences, but 'try to avoid' reading frame 1.

HCDR3 amino acids in late primary antibodies in ΔD -D μ FS mice

The deduced amino acid sequences from the HCDR3 nucleotide sequences prove the above conclusions (Tab. 9). With the exceptions of antibodies FS1°14-07 and -08, antibodies with germ line-related HCDR3 sequences have clearly longer D region loops than antibodies with non-related sequences. Among the antibodies with germ line-related HCDR3 sequences, only 3 (FS1°14-10, 12 and 16) used the DH RF1 coding for hydrophobic amino acids. This is indicated by a positive hydrophobicity index (Tab. 9). Only RF2 in HCDR3 encoded the normally preferred amino acids glycine and tyrosine. Since 6 clones (37 %) used a germ line non-related reading frame in HCDR3 intervals, antibodies with DH RF1 represent only 19 % instead of 90 % in WT.

Analysis of hydrophobic score of the HCDR3 demonstrated that the germ line DH non-related clones used hydrophobic as well as hydrophilic amino acids and some of these clones (FS1°14-5, FS1°14-11, FS1°14-13) presented a similar HCDR3-loop (DXG) found in WT mice. However, clones using RF1 in DH showed a hydrophobic HCDR3, while that using RF2 presented mostly a hydrophilic HCDR3.

In conclusion:

- As concluded from the early primary anti-phOx antibodies of ΔD -D μ FS mice, the variability of HCDR3 length suggests that the D region is not of prime importance for the phOx-specificity.
- In general, the more DH gene nucleotides are eliminated by exonucleases during VDJ recombination in the course of generation of the pre-immune repertoire, the shorter the HCDR3 length will be.

3.5.1.3 Analysis of secondary anti-phOx antibodies

Clonal composition of the secondary response

Eight weeks after primary immunization, a group of ΔD -D μ FS mice were immunized a second time with the TD antigen phOx-CSA and phOx-reactive antibody-secreting hybridomas were prepared 3 days later by cell fusion. From 2 such fusions, 12 anti-phOx specific hybridomas were established (Tab. 10). From the first fusion of one mouse, only 4 IgM anti-phOx

antibodies were obtained and from the other mouse only 8 IgG-secreting clones. Compared to BALB/c WT mice, isolation of IgM antibodies in the first fusion is a rather strange event, particularly since they were obtained already on day 3 after immunization. The collection of antibodies obtained in the second fusion also present curious features. In wildtype mice, the secondary response is characterized by a clonal shift away from the primary dominant Id_{Ox1} to other clonotypes. In these secondary antibodies from ΔD-DμFS mice, 3 antibodies (FS2°-05 to -07) were encoded by the Id_{Ox1} gene combination VH171/Vκ072. Hence, they dominated the secondary response of this mouse with 37 %. In addition, antibody FS2°-08 was also encoded by VH171, but in combination with VL gene Vκ137.

Conclusions:

- The very different outcome in these 2 fusions indicates that the repertoire of B cells in ΔD-DμFS mice which can be activated by phOx-CSA develops at random. Therefore, the normally dominant Id_{Ox1} may even be generated in very few mice.
- Because of the probably non-sufficient amount of secondary antibodies, a clear repertoire switch as in BALB/c WT mice can not be concluded.

Mutations in secondary antibodies

The IgM antibodies were almost non-mutated and the 7 productive and 5 silent mutations in antibody FS2°-01 are problematic since the coding gene VH623 is 'only' a class 2 gene. Since the complete repertoire of the VH1 family is not known, the VH gene used FS2°-01 may belong to the group of hitherto unknown VH1 family genes. Thus, we can regard the associated cells as naive and not as memory B cells.

As mutation rates of secondary IgG antibodies are higher than in late primary antibodies, it can be concluded that these antibodies have undergone immune maturation through somatic hypermutation. Indeed, VL-coding gene Vκ072 of antibodies FS2°-06 and -07 contain the well known classical affinity-enhancing early mutations H>N in position 33 and Y> F in position 35 [55]. In addition, the VH171 gene of antibody FS2°-07 contains the known mutation S>T in position 31 [55]. Hence, the 4 antibodies encoded by VH171 are immune matured and this correlates well with their considerably enhanced affinities (Tab. 10).

Conclusion:

- Immune maturation can occur in individual, but not all ΔD-DμFS mice.

HCDR3 nucleotide sequences of secondary antibodies

Two of the IgM antibodies could be sequenced in VH. Both of them used germ line-related

nucleotide sequences in HCDR3, 1 in RF1 and the other in RF2 (Tab. 11). HCDR3 sequences of 3 IgG antibodies are also germ line-related. Two of them are translated in RF2 and the in RF3. Interestingly, the other 4 IgG antibodies which are encoded by one or both Id_{Ox1} variable genes have rather short HCDR3 loops (Tab. 11).

Conclusion:

- In ΔD-DμFS antibodies encoded by one or both genes of the canonical Id_{Ox1} combination, the HCDR3 loop could obviously not be generated from germ line-related nucleotide sequences.

Table 10

VH/VL gene combinations of phOx-CSA-induced secondary anti-phOx antibodies in ΔD-DμFS mice

MAb ^a	VH chain genes						VL chain genes					rel. Aff. ^g
	FS2 ^o	Is ^b	Fam ^c	Cl ^d	IGHV ^e	p/s ^f	J	Fam ^c	Cl ^d	IGKV ^e	p/s ^f	
01 ^h	μ	1	2	623	7/5	3	1	1	115	0/0	2	-
02 ^h	μ	1	2	591	0/0	3	-	-	-	-/-	-	-
03 ^h	μ	-	-	-	-/-	-	1	1	097	0/0	1	-
04 ^h	μ	-	-	-	-/-	-	9B	1	121	0/0	2	-
05 ⁱ	γ	2	1	171^k	3/0	4	4/5	1	072^k	1/0	5	16, 4
06 ⁱ	γ	2	1	171^k	6/0	3	4/5	1	072^k	5/0	5	127, 7
07 ⁱ	γ	2	1	171^k	5/2	3	4/5	1	072^k	4/2	5	65, 7
08 ⁱ	γ	2	1	171^k	6/0	4	10	1	137	3/3	2	19, 1
09 ⁱ	γ	2	1	162	10/6	3	1	1	115	3/3	1	-
10 ⁱ	γ	7	1	158	9/5	3	1	1	115	2/1	2	2, 0
11 ⁱ	γ	15	1	125	3/1	2	10	1	137	4/0	1	10, 4
12 ⁱ	γ	-	-	-	-/-	-	19/28	1	202	1/0	2	-

Legend

- ^a – The annotation of antibodies indicates their generation from ΔD-DμFS mice (FS), after secondary immunization (2^o) and is followed by a sequential number.
- ^b – Isotype of the monoclonal antibody.
- ^c – Indication of VH or VL gene family in the VBASE2 integrative database.
- ^d – In the integrative database VBASE2, the genes are classified: for class 1 genes there is genomic and rearranged evidence, for class 2 genes only genomic evidence and for class 3 genes only rearranged evidence.
- ^e – VH and VL gene numbers according to the integrative database VBASE2.
- ^f – Productive (p) and silent (s) mutations of corresponding VH and VL chains.
- ^g – The relative affinities were measured in a hapten inhibition test in comparison to Id_{Ox1} IgM and IgG anti-phOx antibodies, respectively.
- ^{h, i} – Indication of different fusions.
- ^k – Id_{Ox1} genes VH171 and Vκ072 are marked in bold.
- – Sequence not determined.

Grey background shows the Id_{Ox1} gene combination VH171/Vκ072.

Table 11

Nucleotide sequences of HCDR3 of phOx-CSA-induced secondary anti-phOx antibodies generated from Δ D-F μ FS

FS2°	----	VH ^a	-----	DH ^b	-----	JH ^c	----	RF ^d
DH gene				T TTT ATT ACT ACG GTA GTT AGC TAC				1
01 μ	TGT	GCA	AGA	GGG TGG AGT ATT ACT ACG GTA GTT AGC TAC		GCT TAC TGG		1
02 μ	TGT	GCA	AGA	G AGA GGT CTT TTT ACT ACG GTA GGG AGT GGC TGG TT		TGC TTA TGG		2
09 γ	TGT	GCC	AGA	CA TGA ATT TTT ATT ACT ACG GAG TTA CCT ACG C		GCT TAC TGG		3
10 γ	TGT	GCA	CGA	G GGC ATT ACT ACG GTA CTT GGT TT		GCT TAC TGG		2
11 γ	TGT	GTT	AGA	T ATT ACT ACG GTA GGC CT		GAC TAC TGG		2
05 γ	TGT	GCC	AGA	GAC TCC GGG		GAC TAC TGG		nf
06 γ	TGT	GCC	AGA	GAT GGG GGG		GCT TAC TGG		nf
07 γ	TGT	GCC	AGA	G ATT ACG GA		ATT TAC TGG		nf
08 γ	TGT	GCC	AGA	GAT GGG GGG		GAC TAC TGG		nf

Legend

^a – VH-encoded base of HCDR3.

^b – DH nucleotides of the HCDR3-loop.

^c – JH-encoded base of HCDR3.

^d – Reading frame of DH gene.

inv – inverted.

nf – not found.

Nucleotides marked in green (≥ 6 successive nucleotides) correspond to DH germline sequence in Δ D-D μ FS mice.

Nucleotides marked in red are generated by N and P region insertions.

Nucleotides marked in blue (4 or 5 successive nucleotides) correspond probably to DH germline sequence in Δ D-D μ FS mice.

DH germ line coding sequence of Δ D-D μ FS is outlined in first line in green colour.

Table 12

Predicted amino acid sequences of HCDR3 of pHox-CSA-induced secondary anti-pHox antibodies generated from Δ D-D μ FS mice

FS2 ^o		Base ^a	CDRH3-loop ^b	Base ^c	RF ^d	H ^e
01	μ	CAR	GWS ITTVVSY	AYW	1	0.42
02	μ	CAR	ERS FYYGRE WL V	CLW	2	-0.1
09	γ	CAR	HEF LLLR SYLR	AYW	3	0,17
10	γ	CAR	GHYYG TWF	AYW	2	-0,06
11	γ	CVR	YYYGR P	DYW	2	-0,41
05	γ	CAR	DSG	DYW	nf	-0,36
06	γ	CAR	DGG	AYW	nf	-0,31
07	γ	CAR	DYG	IYW	nf	-0,41
08	γ	CAR	DGG	DYW	nf	-0,36

Legend

- ^a – VH-encoded base of HCDR3.
^b – Predicted amino acid sequence of the HCDR3 loop.
^c – JH-encoded base of HCDR3.
^d – Reading frame of DH gene.
^e – The average, normalized Kyte-Doolittle hydrophobicity of the HCDR3 loop [72, 73].

Amino acids marked in green correspond to DH germline sequence in Δ D-D μ FS mice.
Amino acids marked in red are generated by N and P region insertions.
nf – not found

HCDR3 amino acids in secondary antibodies in Δ D-D μ FS mice

A conspicuous character of the secondary response is the reduced usage of DH RF1-encoded hydrophobic amino acids in the HCDR3 loop. Antibodies FS2^o-2, -10 and -11 used tyrosine-rich germ line-related DH sequences and only antibody FS2^o-01 used hydrophobic amino acids encoded by the DH RF1 (Tab. 12). Thus, the single clone using DH RF1 represents only 11 % of our secondary Abs.

Thus, tyrosine- and glycine-rich HCDR3s were seen in all clones except antibodies FS2^o-01 and FS2^o-09. The prevalence of these 2 amino acids shifted the average hydrophobicity of the HCDR3s strongly into the hydrophilic range (average hydrophobicity less than -0.3) (Tab. 10). In contrast, hydrophobicity of HCDR3 in antibodies FS2^o-01 and FS2^o-09 had average hydrophobicity scores in the normalized Kyte-Doolittle scale of 0.17 and 0.42, respectively.

Moreover, the usage of VHOx1 in antibodies FS2^o-05 to -08 was accompanied by the expression of germ line-non-related Ox1 motive (DXG), pointing out the minimal role of DH genes in the constraining of amino acid composition of the HCDR3. However, the DRG sequence

determining the Id_{Ox1} idiotope was not found. Hence, these antibodies did not react with our Id_{Ox1}-specific prototypic monoclonal anti-idiotype 8-21/W18.

Conclusions:

- In principle, Δ D-D μ FS mice can generate the genetic VH/VL combination of Id_{Ox1} antibodies.
- However, the idiotypic motive DRG in which the middle arginine is essential for recognition by syngeneic anti-idiotypes can either not or only extremely rarely be generated.

3.5.1.4 Analysis of tertiary anti-phOx antibodies

Clonal composition of the tertiary response

Two months after secondary immunization mice received a tertiary immunization and on day 3 thereafter, hybridomas secreting phOx-specific antibodies were prepared by cell fusion with the non-secretor myeloma cell line Ag8.653. From one fusion, 35 hybridoma lines could be established (Tab. 13). Strikingly and in accord with secondary fusions (see above), even after tertiary immunization, 12/35 clones (34 %) secreted antibodies of the IgM class. This is in sharp contrast to BALB/c WT mice in which only IgG antibodies can be established at this stage of a memory response [46].

Among IgM antibodies, FS3^o-04 was encoded by the VHOx1 gene VH171 and antibodies FS3^o-07 used the V κ Ox1 gene V κ 072. However, the classical full VHOx1/V κ Ox1 combination was not found (Tab. 13). IgG antibodies FS3^o-18 and -19 were encoded by the VHOx1 gene VH171, but only FS3^o-18 utilized the V κ Ox1 gene V κ 072. This gene was also used in 2 other IgG antibodies, in FS3^o-15 in combination with the VH2 family gene VH175 and in FS3^o-23 in combination with the VH5 family gene VH139. Interestingly, 7 IgG clones (FS3^o-24 to -30, representing 30 % of IgG antibodies) were encoded by the VH/VL gene combination VH158/V κ 115. Thus, this combination can be regarded as a dominating clone in the tertiary response of Δ D-D μ FS mice.

Conclusions:

- In contrast to BALB/c WT mice with a full DH gene repertoire, the Id_{Ox1} does not prevail the tertiary TD response of Δ D-D μ FS mice which can only make use of one artificial DH gene coding for hydrophobic amino acids.
- Instead, the VH158/V κ 115 genetic combination may develop into a dominating clone. Interestingly, this gene combination was also a major clone when wildtype mice were

immunized first with the TI-2 antigen phOx-Ficoll, 3 months later with the TD antigen phOx-CSA and a second TD immunization 2 months later [46].

Table 13

VH/VL gene combinations of phOx-CSA-induced tertiary anti-phOx antibodies in Δ D- μ FS mice

MAb ^a		VH chain genes					VL chain genes				
FS3 ^o	Is ^b	Fam ^c	Cl ^d	IGHV ^e	p/s ^f	J	Fam ^c	Cl ^d	IGKV ^e	p/s ^f	J
01	μ	1	2	627	2/0	2	24/25	1	096	0/0	5
02	μ	1	2	495	2/0	2	-	-	-	-/-	-
03	μ	1	2	286	1/0	3	9A	1	112	1/0	2
04	μ	2	1	171^k	0/1	2	10	1	137	3/0	2
05	μ	5	1	178	2/0	1	21	1	210	0/0	1
06	μ	5	1	176	0/0	3	8	1	195	0/0	2
07	μ	5	1	139	1/0	2	4/5	1	072^k	4/0	5
08	μ	5	1	139	2/0	2	1	1	231	5/3	4
09	μ	6	1	494	8/3	3	2	1	099	0/0	5
10	μ	7	1	158	10/1	3	1	1	115	1/3	2
11	μ	-	-	-	-/-	-	10	1	137	3/0	2
12	μ	-	-	-	-/-	-	1	1	115	0/1	1
13	γ	1	2	627	1/0	2	9A	1	103	6/0	2
14	γ	1	2	627	1/0	2	12/13	1	174	0/0	5
16	γ	1	2	073	3/2	2	4/5	1	078	2/1	5
17	γ	1	2	073	6/0	2	-	-	-	-/-	-
15	γ	2	1	175	3/1	3	4/5	1	072^k	6/0	5
18	γ	2	1	171^k	7/4	3	4/5	1	072^k	1/0	5
19	γ	2	1	171^k	8/3	3	10	1	137	3/3	2
20	γ	3	1	138	7/0	1	24/25	1	123	2/0	1
21	γ	5	1	139	3/1	3	4/5	1	072^k	5/2	5
22	γ	6	1	114	3/2	2	9A	1	108	3/2	2
23	γ	6	1	114	2/1	2	9A	1	108	2/1	2
36	γ	7	1	663	4/1	3	1	1	115	3/1	4
24	γ	7	1	158	8/1	3	1	1	115	0/0	2
25	γ	7	1	158	9/1	3	1	1	115	1/1	2
26	γ	7	1	158	5/5	3	1	1	115	4/1	4
27	γ	7	1	158	10/2	3	1	1	115	0/0	2
28	γ	7	1	158	10/2	3	1	1	115	0/0	2
29	γ	7	1	158	11/2	3	1	1	115	0/0	2
30	γ	7	1	158	4/1	3	1	1	115	1/1	4
31	γ	14	1	125	8/1	2	10	1	129	2/2	1
32	γ	14	1	125	8/1	2	10	1	129	2/1	1
33	γ	14	1	125	3/0	2	12/13	1	172	0/1	4
34	γ	-	-	-	-/-	-	4/5	1	078	2/0	1
35	γ	-	-	-	-/-	-	10	1	137	3/3	2

Legend

- ^a – The annotation of antibodies indicates their generation from Δ D-D μ FS mice (FS), after tertiary immunization (3^o) and is followed by a sequential number. All clones are generated from the same fusion.
- ^b – Isotype of the monoclonal antibody.
- ^c – Indication of VH or VL gene family in the VBASE2 integrative database.
- ^d – In the integrative database VBASE2, the genes are classified: for class 1 genes there is genomic and rearranged evidence, for class 2 genes only genomic evidence and for class 3 genes only rearranged evidence.
- ^e – VH and VL gene numbers according to the integrative database VBASE2.
- ^f – Productive (p) and silent (s) mutations of corresponding VH and VL chains.
- ^g – The relative affinities were measured in a hapten inhibition test in comparison to Id_{Ox1} IgM and IgG anti-phOx antibodies, respectively.
- ^k – Id_{Ox1} genes VH171 and V κ 072 are marked in bold.
- – Sequence not determined.

Grey background shows the Id_{Ox1} gene combination VH171/V κ 072.

Mutations in tertiary antibodies

Mutations further accumulated in tertiary IgG antibodies as compared to secondary antibodies while IgM antibodies remained rather non-mutated. Only IgM FS3^o-09 and -10 contained considerable numbers of mutations. This might indicate that both antibodies had undergone immune maturation. However, if this were the case it has to be asked why they did not traverse class switch recombination.

Among IgG antibodies, the 2 VH171 genes in antibodies FS3^o-18 and -19 exhibited rather high numbers of mutations, but the typical S>T mutation in position 31 is not seen. However, antibody FS3^o-19 showed a silent mutation in this position. Highest mutation rates in IgG antibodies occur in antibodies encoded by the VH158/V κ 115 gene combination (Tab. 13). In 4 positions (52, 56, 61 and 76), the VH158 gene in all of these antibodies had a variable number of silent and productive mutations in common with previously established anti-phOx antibodies [46]. Those antibodies were obtained in mice which had been immunized first with the TI-2 antigen phOx-Ficoll followed by a primary and then a secondary immunization with phOx-CSA. This further proves that tertiary Δ D-D μ FS antibodies with the VH158/V κ 115 gene combination had undergone immune maturation.

Conclusions:

- The tertiary anti-phOx antibodies from Δ D-D μ FS mice underscore that the single artificial DH gene in these mice does not allow the Id_{Ox1} to become a dominant clone.
- However, Δ D-D μ FS mice can develop antibodies with the VH158/V κ 115 gene combination as a dominant clone in the tertiary response.

Table 14

Nucleotide sequences of HCDR3 of phOx-CSA-induced tertiary anti-phOx antibodies generated from Δ D-D μ FS

FS3 ^o	----	VH ^a	-----	DH ^b	-----	JH ^c	----	RF ^d
DH gene				T TTT ATT ACT ACG GTA GTT AGC TAC				1
01	μ	TGT GCA AGC		GGG GGT ACT ACG GTA GCC TTT		GAC TAC TGG		1
02	μ	TGT GCA AGA		G ACT ACG GCA AAA GAG GT		GGC TAC TGG		2
05	μ	TGT ATT ACT		ACG GTA GTT AGC TAC TGG TAC TTC		GAT GTC TGG		1
06	μ	TGT GCA AGA		GGC AGG GCT ACG GTA GTT AGC TAC GCC TGG TTT		GCT TAC TGG		1
07	μ	TGT GCA AGA		G ACT ACG GT		GAC TAC TGG		2
08	μ	TGT GCA AGA		G ACT ACG GT		GAC TAC TGG		2
03	μ	TGT GCA AGA		AGA GAT GGG		GCT TAT TGG		nf
04	μ	TGT GCC AGA		GAT TCG GGG		GAC TAC TGG		nf
09	μ	TGT ACG GGG		GGT CCC TGG TTT		GCT TAC TGG		nf
10	μ	TGT GCA AGA		GGG GCC GGT AGT GGA GCC TGG TTT		GCT TAC TGG		nf
13	γ	TGT GCA AGG		T TTT ACT ACG GTA GGG GGG GGC TCG TCTACTTT		GAC TAC TGG		2
14	γ	TGT GCA AGG		T TTT ACT ACG GTA GGG GGG GGC TCG TCTACTTT		GAC TAC TGG		2
16	γ	TGT GCA AGA	GGA GGC	TTT ATT AGG ACG ACG GTA GCC GGG		GAC TAC TGG		1
17	γ	TGT ACA ACA		G GGG ATT ACT ACG GT		AGT TAC TGG		2
20	γ	TGT GCA AGA		TTT ACT ACG GTA GTT AGC TAC TGG TACTTC		GAT GTC TGG		1
21	γ	TGT GCA AGA		G ACT ACG GG		GCT TAC TGG		2
25	γ	TGT GCA AGA		G GTT ATT ACT ACG GTA GTT GGT TT		GCT TAC TGG		2
26	γ	TGT GCA AGA		G GGC ATT ACT ACG GTG CCT GGT TT		GCT TAC TGG		2
27	γ	TGT GCA AGA		G GTC ATT ACT ACG GTA CTT GGT TT		GCT TAC TGG		2
28	γ	TGT GCA AGA		G GTC ATT ACT ACG GTA CTT GGT TT		GCT TAC TGG		2
29	γ	TGT GCA AGA		G GTC ATT ACT ACG GTA CTT GGT TT		GCT TAC TGG		2
30	γ	TGT GCA AGA		G GGG ATT ACT ACG GTG CCT GGT TT		GCT TAC TGG		2
31	γ	TGT GCT AGT		G ACT ACG GC		CTC TAC TGG		2

32	γ	TGT GCT AGT	G ACT ACG GC	CTC TAC TGG	2
33	γ	TGT GCT AGA	TAT GAG ATT ACT ACG GTA GTT ACC	TCT ATC TGG	1
36	γ	TGT GCA AGA	G GGG ATT ACT ACG GTG CCT GGT TT	GCT TAC TGG	2
15	γ	TGT GCC AGA	GAT TGG GGG	GAT TAC TGG	nf
18	γ	TGT GCC AGA	GAT GGG GGG	ACT TAT TGG	nf
19	γ	TGT GCC AGA	GAT GAG GGT	GTG AAC TGG	nf
22	γ	TGT ACA ACT	AGA GGG	GAC TAT TGG	nf
23	γ	TGT ACA ACT	AGA GGG	GAC TAT TGG	nf
24	γ	TGT GCA AGA	G GGG ACG GTC GTG GAG CCT GGT TT	GCT TAC TGG	nf

Legend

- ^a – VH-encoded base of HCDR3.
- ^b – DH nucleotides of the HCDR3-loop.
- ^c – JH-encoded base of HCDR3.
- ^d – Reading frame of DH gene.
- inv – inverted.
- nf – not found.

Nucleotides marked in green (≥ 6 successive nucleotides) correspond to DH germline sequence in ΔD -D μ FS mice.

Nucleotides marked in red are generated by N and P region insertions.

Nucleotides marked in blue (4 or 5 successive nucleotides) correspond probably to DH germline sequence in ΔD -D μ FS mice.

DH germ line coding sequence of ΔD -D μ FS is outlined in first line in green colour.

HCDR3 nucleotide sequences of tertiary antibodies

60 % of the IgM antibodies contain germ line-related HCDR3 sequences of variable length (Tab. 14). Among IgG antibodies this value is even higher with 72 %. As in all previous antibodies of this investigation, antibodies with RF1 (~ 19 %) usage in HCDR3 are clearly counter selected. RF2 dominates with 50 % and in 31 % of the antibodies the reading frame could not be ascribed. The HCDR3 loop of antibody FS3°-16 seems to be interesting since to separated germ line-related sequences occur which are separated from each other by non-ascribable nucleotides. It may be speculated that this D region may be generated by D-D duplication.

Conclusion:

- Reading frame used in these tertiary anti-phOx antibodies from Δ D-D μ FS mice thus confirm findings from the earlier stages of this response.

HCDR3 amino acids in tertiary antibodies in Δ D-D μ FS mice

The deduced amino acid HCDR3 sequences in the tertiary anti-phOx antibodies are shown in Tab. 15. Only 3 IgM and 3 IgG contained hydrophobic amino acids encoded by DH RF1, while 3 IgM and 13 IgG antibodies had RF2-encoded hydrophilic amino acids. In 4 IgM and 6 IgG, the reading frame could not be assigned and the newly generated HCDR3 nucleotide sequences encoded mostly hydrophilic amino acids. Interestingly, only the germ line-related HCDR3 sequences coded for tyrosines, which was missing in germ line-non-related HCDR3. The negative selection of hydrophobic amino acid encoded by DH RF1 is also reflected in the hydropathicity scores of the HCDR3 loops, *i.e.* negative values prevail while positive scores are very rare. Thus, the majority of the HCDR3-loops resembled those seen in BALB/c WT mice with hydrophilic amino acids like tyrosine and glycine (Tab. 15).

The lengths of HCDR3-loops of these tertiary Δ D-D μ FS anti-phOx antibodies showed the same characteristics as before, namely that germ line-related coding caused longer loops than non-related coding. In IgG antibodies, the length of HCDR3-loops ranged from 2 to 11, while those of IgM antibodies varied between 3 and 11 amino acids. Interestingly, the middle Id_{Ox1} related motive DXG was present in four clones of IgM class (FS3°-3, -7, -8 and -41) and in 5 IgG antibodies (FS3°-15, -18, -19, -21, -31 and -32). The HCDR3-loops of these clones were encoded by N nucleotides generated during the recombination processes and did not show any homology with the germ line DH segment.

Conclusions:

- Also in the tertiary response, Δ D-D μ FS mice 'try to avoid' coding of HCDR3 in RF1. Instead, RF2 usage and generation of newly form nucleotide sequences during recombination favor HCDR3 loops which are rich in glycine and tyrosine.

Table 15

Predicted amino acid sequences of HCDR3 of phOx-CSA-induced tertiary anti-phOx Abs generated from Δ D-D μ FS mice

FS3°		Base ^a	CDRH3-loop ^b	Base ^c	RF ^d	H ^e
01	μ	CAS	GGTTVAF	DYW	1	0.48
02	μ	CAR	DYGKRG	GYW	2	-0.6
05	μ	CIT	TVVSYWYF	DVW	1	0.43
06	μ	CAR	GRATVVSYAWF	AYW	1	0.36
07	μ	CAR	DYG	DYW	2	-0.64
08	μ	CAR	DYG	DYW	2	-0.64
03	μ	CAR	RDG	AYW	nf	-0.76
04	μ	CAR	DSG	DYW	nf	-0.36
09	μ	CTG	GPWF	AYW	nf	0.16
10	μ	CAR	GAGSGAWF	AYW	nf	0.31
13	γ	CAR	FYYGRGGLVYF	DYW	2	0.29
14	γ	CAR	FYYGRGGLVYF	DYW	2	0.29
16	γ	CAR	GGFIRTTVAG	DYW	1	0.38
17	γ	CTT	GDYYG	SYW	2	-0.3
20	γ	CAR	FTTVVSYWYF	DVW	1	0.45
21	γ	CAR	DYG	AYW	2	-0.41
25	γ	CAR	GYYYGSWF	AYW	2	0.01
26	γ	CAR	GHYYGAWF	AYW	2	0.04
27	γ	CAR	GHYYGTWF	AYW	2	-0.06
28	γ	CAR	GHYYGTWF	AYW	2	-0.06
29	γ	CAR	GHYYGTWF	AYW	2	-0.06
30	γ	CAR	GDYYGAWF	AYW	2	0.03
31	γ	CAS	DYG	LYW	2	-0.41
32	γ	CAS	DYG	LYW	2	-0.41
33	γ	CAR	YEITTVVT	SIW	1	0.43
36	γ	CAR	GDYYGAWF	AYW	2	0.03
15	γ	CAR	DWG	DYW	nf	-0.37
18	γ	CAR	DGG	TYW	nf	-0.31
19	γ	CAR	DEG	VNW	nf	-0.66
22	γ	CTT	RG	DYW	nf	-0.64
23	γ	CTT	RG	DYW	nf	-0.64
24	γ	CAR	GDGRGAWF	AYW	nf	-0.06

Legend

^a – VH-encoded base of HCDR3.

^b – Predicted amino acid sequence of the HCDR3 loop.

^c – JH-encoded base of HCDR3.

^d – Reading frame of DH gene.

^e – The average, normalized Kyte-Doolittle hydrophobicity of the HCDR3 loop [72, 73].

Amino acids marked in green correspond to DH germline sequence in Δ D-D μ FS mice.

Amino acids marked in red are generated by N and P region insertions. nf – Not found

As general conclusions from the analysis of the thymus-dependent anti-phOx response in Δ D-D μ FS mice it can be stated:

- 1.) The restriction of the number of DH gene segments to one artificial DH gene demonstrates the extraordinary variability at the third hypervariable region which is enzymatically created during VDJ-recombination by exonucleases and the insertion of non-templated (N) and palindromic (P) nucleotides.
- 2.) The restriction of the number of DH gene segments to one artificial DH gene, coding for hydrophobic amino acids, causes a substantial reduction of the antibody repertoire of the mice.
- 3.) The canonical VH/VL gene combination VH171/V κ 072 together with Id_{Ox1}-typical amino acid sequence DRG in HCDR3 is extremely rarely verified and, if so, only in particular animals.

3.5.2 Genetic analysis of the phOx-reactive repertoire of Δ D-iD mice

Next, Δ D-iD mice were immunized with the TD antigen phOx-CSA. These mice can only make use of a single DH gene coding for charged amino acids in HCDR3. Anti-phOx antibody-secreting hybridomas were generated by cell fusion from the primary, secondary and tertiary of immune response. Here, the V region-coding sequences of these antibodies will be described.

3.5.2.1 Analysis of early primary anti-phOx antibodies

Primary repertoire

From the early primary response of Δ D-iD mice, *i.e.* 7 days after immunization, 18 hybridomas could be established. Eleven of them (61 %) were of the IgM and 39 % belonged to the IgG class (Tab. 16). The nomenclature of these antibodies is analogous to that of Δ D-D μ FS mice.

This mutant strain is abbreviated by iD and early primary antibodies are marked with 1° followed by the day 7 of the fusion. IgM anti-phOx antibodies iD1°7-05, -06 and -07 and IgG antibodies iD1°7-13 and -14 expressed a VHOx1 heavy chain (VH171) in association with alternative light chains. Only IgG antibody iD1°7-12 used the VκOx1 light chain (Vκ072) in combination with VH183. Hence, the Id_{Ox1} VH/VL gene combination VH171/Vκ072, dominating the primary TD response of BALB/c WT mice, is not expressed among early primary antibodies of ΔD-iD mice. Moreover, the normally dominant Id_{Ox1} is not replaced by another dominant VH/VL gene combination. Most of the variable genes in this primary response in the ΔD-iD mice have been observed in the WT mice, but in different combinations.

Conclusions:

- Hence, the restriction to a single DH gene segment coding for charged amino acids changes the pattern of VH/VL combinations in ΔD-iD mice, but not the V gene usage of heavy and light chains.
- There is no dominant idotype in the early primary anti-phOx antibodies.

Affinity of primary antibodies

The relative affinity of the majority of IgM antibodies was 10-20 lower than that of the IgM Id_{Ox1} antibody H11.5 (μ, κ). In contrast, the affinities of the 2 IgG antibodies iD1°7-16 and -17 were in the range of the Id_{Ox1} control antibody NQ2/16.2, and antibodies iD1°7-13, -14 and -15 exhibited clearly higher affinities (Tab. 16).

Conclusion:

- Even a restricted pre-immune repertoire generated from the single D gene segment of ΔD-iD mice may contain antibodies with VH/VL gene combinations which confer higher affinities than that of Id_{Ox1} antibodies.

Mutations in early primary antibodies

Most of the early primary anti-phOx antibodies from ΔD-iD mice showed no or low mutation numbers, with some exceptions. The 2 IgM antibodies iD1°7-03 and -04 had enhanced mutations in the VH1 family gene VH286. However, since this is a class 2 gene, these mutations are doubtful. Three other IgM antibodies, iD1°7-01, -05 and -10, contain some productive as well as silent mutations in their light chain which can not be explained at this early stage of the primary response.

Conclusion:

- We conclude that the mutation rates of early primary phOx-CSA-induced antibodies in Δ D-iD mice did not differ significantly from those of BALB/c WT mice. Thus, the alteration in the DH locus did not influence the mutation rate at this stage of immune response.

Table 16

VH/VL gene combinations of phOx-CSA-induced primary day 7 anti-phOx antibodies in Δ D-iD mice

MAb ^a	VH chain genes						VL chain genes					rel. Aff. ^g
	iD1°7	Is ^b	Fam ^c	Cl ^d	IGHV ^e	p/s ^f	J	Fam ^c	Cl ^d	IGKV ^e	p/s ^f	
01	μ	1	1	532	0/0	1	2	1	097	7/1	1	-
02	μ	1	1	532	1/0	3	23	1	171	0/0	2	0,05
03	μ	1	2	286	5/1	2	9A	1	108	1/0	2	-
04	μ	1	2	286	3/0	2	1	1	122	1/0	2	0,07
05	μ	2	1	171^k	1/0	4	4/5	1	078	2/3	2	0,2
06	μ	2	1	171^k	3/0	2	10	1	137	1/1	1	0,1
07	μ	2	1	171^k	2/0	3	21	1	210	0/1	2	0,1
08	μ	5	1	131	0/1	1	1	1	122	1/0	2	0,05
09	μ	6	1	114	1/0	3	9A	1	108	0/0	2	0,06
10	μ	-	-	-	-/-	-	8	1	195	6/3	5	0,07
11	μ	-	-	-	-/-	-	21	1	064	2/0	4	-
12	γ	2	1	183	1/0	4	4/5	1	072^k	1/0	5	-
13	γ	2	1	171^k	0/1	4	1	1	115	0/0	2	4,1
14	γ	2	1	171^k	1/1	3	4/5	1	154	0/0	5	5,7
15	γ	5	1	176	1/0	3	8	1	195	0/1	1	9,2
16	γ	5	1	139	0/0	4	4/5	1	050	0/0	2	0,8
17	γ	6	1	114	0/0	3	8	1	188	0/0	4	0,9
18	γ	-	-	-	-/-	-	19/281		186	0/0	2	-

Legend

- ^a – The annotation of antibodies indicates their generation from Δ D-iD mice (iD), after primary immunization (1°) on day 7 (7) and is followed by a sequential number. All clones are generated from the same fusion.
- ^b – Isotype of the monoclonal antibody.
- ^c – Indication of VH or VL gene family in the VBASE2 integrative database.
- ^d – In the integrative database VBASE2, the genes are classified: for class 1 genes there is genomic and rearranged evidence, for class 2 genes only genomic evidence and for class 3 genes only rearranged evidence.
- ^e – VH and VL gene numbers according to the integrative database VBASE2.
- ^f – Productive (p) and silent (s) mutations of corresponding VH and VL chains.
- ^g – The relative affinities were measured in a hapten inhibition test in comparison to Id_{Ox1} IgM and IgG anti-phOx antibodies, respectively.
- ^k – Id_{Ox1} genes VH171 and V κ 072 are marked in bold.
- – Sequence not determined.

Table 17

Nucleotide sequences of HCDR3 of phOx-CSA-induced primary day 7 anti-phOx antibodies generated from Δ D-iD mice

Δ D1 ^{o7}	---VH ^a ---			-----DH ^b -----												---JH ^c ---			RF ^d							
DH gene				TT	TAT	CGT	AAT	CAT	AGT	AGA	AGC	TAC							1							
01	μ	TGT	GCA	AGA	AGG	GGT	CGT	AAT	CAT	AGT	AGA	AGC	TAC	GTA	GGC	GGG	TAC	TTC	GAT	GTC	TGG	1				
02	μ	TGT	GCA	AGG	ATT	TAT	CTG	ATC							CCT	TAC	TGG	1								
08	μ	TGT	GCA	AGA	CAG	GGG	CGT	AAT	CAT	AGT	AGA	AGC	TAC	CCC	TCA	CTG	GTA	CTT	CGA	TGT	CTG	1				
03	μ	TGT	GCA	AGT	ATT	AGT	ACG	GTA							GTC	ATC	TGG	nf								
04	μ	TGT	GCA	AGA	TGG	GGC	AAC							GAC	TAC	TGG	nf									
05	μ	TGT	GCC	AGA	GAT	CGG	GGG							GAC	TAC	TGG	nf									
06	μ	TGT	TCC	AGA	GAT	CGG	GGG							GAC	TAC	TGG	nf									
07	μ	TGT	GCC	AGA	GAT	CGG	GGG							GCT	TAC	TGG	nf									
09	μ	TGT	TCC	AGG	CGA	GGG							ACT	CAC	TGG	nf										
14	γ	TGT	GCC	AGG	TCT	TAT	CGT	AAT	CAT	AGT	AGA	ACC							GCT	TAC	TGG	1				
15	γ	TGT	GCA	AGT	AGC	TTC	TAC	TAT	GAT	TAC	GAT	AAA	TCG	TTT							GCT	TAC	TGG	inv		
16	γ	TGT	GCA	AGA			CC	CGT	AAT	CAG	ATA	TTA	CTA	TGC	TAT	G							GAC	TAC	TGG	2
17	γ	TGT	ACC	AGG	CC	TCT	TAT	CGT	AAG	GGT	TCA	CTT	T							GCT	TAC	TGG	2			
12	γ	TGT	GCC	AGA	AAT	TGG	GGG							GAC	TAC	TGG	nf									
13	γ	TGT	GCC	AGA	GAT	CGA	GGG							GAC	TAC	TGG	nf									

Legend

^a – VH-encoded base of HCDR3.

^b – DH nucleotides of the HCDR3-loop.

^c – JH-encoded base of HCDR3.

^d – Reading frame of DH gene.

inv – inverted.

nf – not found.

Nucleotides marked in green (≥ 6 successive nucleotides) correspond to DH germline sequence in Δ D-iD mice.

Nucleotides marked in red are generated by N and P region insertions.

Nucleotides marked in blue (4 or 5 successive nucleotides) correspond probably to DH germline sequence in Δ D-iD mice.

DH germ line coding sequence of Δ D-iD is outlined in first line in green colour.

HCDR3 nucleotide sequences of early primary antibodies

From 15 antibodies we obtained full sequences of VH regions (Tab. 17). In 3/9 of IgM and in 1/6 IgG of the 15 VH sequences, HCDR3 were translated in RF1. In another IgG antibody (iD1°7-15), HCDR3 was in an inverted RF1. Only the 2 IgG antibodies iD1°7-16 and -17 used RF2 in HCDR3. In the majority of the antibodies, *i.e.* 6 IgM and 2 IgG, the D regions the reading frames could not be assigned.

Conclusions:

- The bias against RF1 usage is not as pronounced as in Δ D-D μ FS mice. RF2 is not really dominant and in most of the antibodies the reading frame could not be assigned.
- Invariably, non-assignable reading frames code for shorter D-regions lengths.
- B cells seem to escape the usage of charged HCDR3-loop in two mechanisms:
 - First, by shifting the RF, so that 2 antibodies (iD1°7-16 and 17) contain RF2-encoded DH segments and 1 antibody (iD1°7-15) contained DH sequence encoded by an inverted RF1 (i-RF1).
 - Second, by an enhanced loss of nucleotides at the termini of DH gene, so that 53 % of the HCDR3 intervals contained no germ line-encoded DH nucleotides.

HCDR3 amino acids in early primary antibodies in Δ D-iD mice

Three IgM antibodies (iD1°7-5, -06 and -07) and 1 IgG antibody (iD1°7-13), exhibiting germ line non-related readings frames in HCDR3, contained the DRG motive of wildtype Id_{Ox1} antibodies, but only one of them (iD1°7-13) reacted with our Id_{Ox1}-specific prototypic monoclonal anti-idiotypic 8-21/W18. This is astonishing, since only antibody iD1°7-07 showed the complete Id_{Ox1}-typical sequence CAR-DRG-AYW (Tab. 18). However, the 3 IgM antibodies iD1°7-05, -06 and -07 contained the DRG motive and used the VHOx1 in combination with alternative light chain genes as the other VH171-encoded IgG antibodies.

Conclusions:

- This shows that the Id_{Ox1} specificity relies not only on the DRG motive in the HCDR3 loop, but is also influenced in its 3-dimensional structure by other parts of the complete molecule, *i.e.* including the L chain.
- With the only exception of antibody iD1°7-02, short HCDR3-loops are only seen in antibodies in which the reading frame could not assigned.

Table 18

Predicted amino acid sequences of HCDR3 of pH_{0x}-CSA-induced primary day 7 anti-ph_{0x} antibodies generated from ΔD-iD mice

iD1°7		Base ^a	CDRH3-loop ^b	Base ^c	RF ^d	H ^e
01	μ	CAR	RGRNHRSYVGGYF	DVW	1	-0,27
02	μ	CAR	IYLI	PYW	1	1,13
08	μ	CAR	QGRNHRSYPSLVLR	LGR	1	-0,4
03	μ	CAS	ISSV	VIW	nf	0,78
04	μ	CAR	WGN	DYW	nf	-0,37
05	μ	CAR	DRG	DYW	nf	-0,76
06	μ	CSR	DRG	DYW	nf	-0,76
07	μ	CAR	DRG	AYW	nf	-0,76
09	μ	CSR	RG	THW	nf	-0,64
14	γ	CAR	SYRNHSRT	AYW	1	-0,63
15	γ	CAS	SFYDYDKSF	AYW	1inv	-0,19
16	γ	CAR	PVIRYYYAM	DYW	2	0,27
17	γ	CTR	PLIVRVHF	AYW	2	0,6
12	γ	CAR	NWG	DYW	nf	-0,37
13	γ	CAR	DRG	DYW	nf	-0,76

Legend

^a – VH-encoded base of HCDR3.

^b – Predicted amino acid sequence of the HCDR3 loop.

^c – JH-encoded base of HCDR3.

^d – Reading frame of DH gene.

^e – The average, normalized Kyte-Doolittle hydrophobicity of the HCDR3 loop [72, 73].

Amino acids marked in green correspond to DH germline sequence in ΔD-iD mice.

Amino acids marked in red are generated by N and P region insertions.

nf – not found

3.5.2.2 Analysis of late primary anti-ph_{0x} antibodies

Clonal development in the late primary response

After primary immunization of ΔD-iD mice with pH_{0x}-CSA, 20 anti-ph_{0x} antibody-secreting hybridomas could be established from the late primary response in 2 separate fusions on day 14 (Tab. 19). As the most remarkable finding, the absolute majority of 19 antibodies were of the IgM and only 2 antibodies of the IgG class. This is in sharp contrast to BALB/c WT mice in which only IgG-secreting hybridomas can be generated at this late time point of the primary immune response. It is also striking that the Id_{0x1} variable genes were almost absent. The VHO₁ gene VH171 is found not at all in antibodies of both fusions, and VκO₁ is only found once in the IgM antibody iD1°14-11. Hence, as among the early primary antibodies, the

Id_{Ox1} is not expressed (Tab. 17). In addition, there is no other dominant VH/VL combination. The repertoire of these 20 late primary antibodies is with 15 VH and 14 VL genes extremely heterogeneous and every gene combination is unique.

Conclusions:

- As already observed in Δ D-D μ FS mice, antibodies of the late primary response of Δ D-iD mice revealed an impaired class switch recombination.
- The genetic repertoire is quite heterogeneous.
- There is no dominant VH/VL gene combination

Mutations in late primary antibodies

It is also surprising that the majority of H and L chains were not mutated. In fact, except the 3 antibodies iD1°14-06, -09 and -20, none of the VL genes showed any mutation. In addition, 5 VH genes did not present any deviation from the germ line configuration. These data indicate that the late primary IgM-secreting activated B cells neither undergo class switch recombination nor do they show somatic mutation.

Conclusion:

- Hence, the restriction in Δ D-iD mice to a single DH gene coding for charged amino acids in HCDR3 drastically inhibits the early immune maturation through somatic mutation.

HCDR3 nucleotide sequences of late primary antibodies

The nucleotide sequences of the late primary anti-phOx antibodies from Δ D-iD mice are depicted in Tab. 20. In 11/18 IgM antibodies (61 %), the HCDR3 nucleotide sequences derived from the germ line DH gene and in another antibody (iD1°14-05), the germ line relation of the HCDR3 sequence was doubtful since only 5 successive nucleotides were identical with the germ line DH gene. A germ line related HCDR3 sequence is also observed in 1 IgG antibody, but not the other.

As already observed in the early primary antibodies of Δ D-iD mice, RF1 was not decreased to such an extent as in Δ D-D μ FS mice. In fact, 8/18 antibodies (~44 %) used RF1 in HCDR3, 2 antibodies used RF2 and RF3, respectively, and in 6 antibodies (~33 %) the reading frame could not be assigned (Tab. 20).

Conclusions:

- The bias against RF1 usage is not as pronounced as in Δ D-D μ FS mice. RF2 and RF3

are least frequently used and antibodies with germ line non-related HCDR3 sequences are rather common.

- Non-assignable reading frames code for shorter D-regions lengths.

Table 19

VH/VL gene combinations of phOx-CSA-induced primary day 14 anti-phOx antibodies in Δ D-iD mice

MAb ^a	VH chain genes						VL chain genes					rel.
	iD1°14	Is ^b	Fam ^c	Cl ^d	IGHV ^e	p/s ^f	J	Fam ^c	Cl ^d	IGKV ^e	p/s ^f	J
05 ^h	μ	1	1	706	0/0	2	4/5	1	142	0/0	2	-
02 ^h	μ	1	2	654	1/2	3	2	1	097	0/0	2	-
03 ^h	μ	1	2	499	0/0	3	19/28	1	198	0/0	1	-
04 ^h	μ	1	2	286	1/1	1	19/28	1	201	0/0	1	-
01 ^h	μ	1	3	014	0/0	1	10	1	137	0/0	1	-
06 ⁱ	μ	3	1	128	4/1	2	4/5	1	050	3/1	4	-
07 ^h	μ	3	1	128	1/0	1	10	1	137	0/0	4	-
08 ⁱ	μ	5	1	192	1/1	2	23	1	168	0/0	1	-
13 ^h	μ	5	1	185	1/1	2	4/5	1	082	0/0	5	-
12 ^h	μ	5	1	178	2/0	2	8	1	069	0/0	5	-
09 ⁱ	μ	5	1	147	0/0	2	38C	1	140	1/0	5	-
10 ⁱ	μ	5	1	135	0/0	1	23	1	168	0/0	4	-
11 ^h	μ	5	1	135	1/0	1	4/5	1	072^k	0/0	5	-
14 ^h	μ	5	1	135	1/1	2	23	1	179	0/0	5	-
15 ⁱ	μ	6	1	114	2/2	3	1	1	115	0/0	1	-
16 ^h	μ	10	1	028	1/0	2	12/13	1	170	0/0	5	-
17 ⁱ	μ	-	-	-	-/-	-	12/13	1	170	0/0	1	-
18 ^h	μ	-	-	-	-/-	-	2	1	097	0/0	1	-
19 ^h	μ	-	-	-	-/-	-	4/5	1	078	0/0	5	-
21 ^h	γ	1	1	528	8/0	3	-	-	-	-/-	-	-
20 ⁱ	γ	1	2	455	3/1	3	1	1	115	1/1	1	-

Legend

- ^a – The annotation of antibodies indicates their generation from Δ D-iD mice (iD), after primary immunization (1°) on day 14 (14) and is followed by a sequential number.
- ^b – Isotype of the monoclonal antibody.
- ^c – Indication of VH or VL gene family in the VBASE2 integrative database.
- ^d – In the integrative database VBASE2, the genes are classified: for class 1 genes there is genomic and rearranged evidence, for class 2 genes only genomic evidence and for class 3 genes only rearranged evidence.
- ^e – VH and VL gene numbers according to the integrative database VBASE2.
- ^f – Productive (p) and silent (s) mutations of corresponding VH and VL chains.
- ^g – The relative affinities were measured in a hapten inhibition test in comparison to Id_{Ox1} IgM and IgG anti-phOx antibodies, respectively.
- ^{h,i} – Indication of different fusions.
- ^k – Id_{Ox1} genes VH171 and V κ 072 are marked in bold. - – Sequence not determined.

Table 20

Nucleotide sequences of HCDR3 of pHx-CSA-induced primary day 14 anti-pHx antibodies generated from Δ D-iD mice

iD1°14	----	VH ^a	-----	DH ^b	-----	JH ^c	----	RF ^d
DH gene				TT TAT CGT AAT CAT AGT AGA AGC TAC				1
01	μ	TGT GCA AGA		CGA GAT CGT AAT CAT AGT AGA AGC TTC CTC TAC TGG TAC TTC		GAT GTC TGG		1
03	μ	TGT GCA AGA		T TAT CGT ACT CAT ATT TTA AGC TCC TGG TT		TGC TTA TGG		3
04	μ	TGT GCA AGA		CAT CAT AGT AGA AGC TAC TGG TAC TTC		GAT GTC TGG		1
06	μ	TGT GCA AGG		GG CGT AAT CAT ACT ACT AGC TAG ATA CTT T		GAC TAC TGG		2
07	μ	TGT GCA AGA		AAG GAT CGT AAT CAT AGT AGA AGG GAC TGG TAC TTC		GAT GTC TGG		1
08	μ	TGT GCA AGA	CCT TTT TAT CGT AAT CAT AGG GGA TAC TTT			GAC TAC TGG		1
10	μ	TGT GCA AGA		CAT CGG CGT AAT CAT AGT AGA AGA GAG ACT GAC TGG TAC TTC		GAT GTC TGG		1
11	μ	TGT GCA AAT		CGT AAT CAT AGT AGA AGC TAC TGG TAC TTC		GAT GTC TGG		1
12	μ	TGT ACA AGA		GTA GCT TCT ACT ATG ATT ACG GTA AAG AGG GTC CTT		GAC TAC TGG		3inv
13	μ	TGT GCA AGG		TC AAT CGT AAT CAT AGT AGA AGC T		AAA CTA TGG		2
14	μ	TGT GCA AGA		CCA GGA CGT AAT CAT AGT AGA AGC TAC CCC TAC TTT		GAC TAC TGG		1
02	μ	TGT GCA AGA	GGG GGG ATT CAT CGT AAA AAC CTG GTT			TGC TTA TGG		nf
05	μ	TGT GCA AGA	AGA GAT			GCC TAC TGG		nf
09	μ	TGT GCA AGA	CAC CCG CTA CGA CGC TAC TTT			GAC TAC TGG		nf
15	μ	TGT ACC AGG	CCC GTC ATC CCA GAG GCC TGG TTT			GCT TAC TGG		nf
16	μ	TGT GTG AGA	CAT GGG ACG TAC TCA TGG AGA			GGA CTA TGG		nf
20	γ	TGT ACA AGA		TCA TGG GGG GAT CAT AGT AAA ACC TAC GGT TCC TGG TTT		GCT TAC TGG		1
21	γ	TGT GCA AGA	CGC TTT			GCT TAC TGG		nf

Legend^a – VH-encoded base of HCDR3.^b – DH nucleotides of the HCDR3-loop.

^c – JH-encoded base of HCDR3.

^d – Reading frame of DH gene.

inv – inverted.

nf – not found.

Nucleotides marked in green (≥ 6 successive nucleotides) correspond to DH germline sequence in Δ D-iD mice.

Nucleotides marked in red are generated by N and P region insertions.

Nucleotides marked in blue (4 or 5 successive nucleotides) correspond probably to DH germline sequence in Δ D-iD mice.

DH germ line coding sequence of Δ D-iD is outlined in first line in green colour.

Table 21

Predicted amino acid sequences of HCDR3 of phOx-CSA-induced primary day 14 anti-phOx antibodies generated from Δ D-iD mice

iD1°14		Base^a	CDRH3-loop^b	Base^c	RF^d	H^e
01	μ	CAR	RDRNHSRSFLYWYF	DVW	1	-0.29
03	μ	CAR	LSYSYFKLLV	CLW	3	0.51
04	μ	CAR	HHSRSYWYF	DVW	1	-0.32
06	μ	CAR	GVILLARYF	DYW	2	0.81
07	μ	CAR	KDRNHSRRDWYF	DVW	1	-0.69
08	μ	CAR	PFYRNHRGYF	DYW	1	-0.32
10	μ	CAR	HRRNHSRRETDWYF	DVW	1	-0.68
11	μ	CAN	RNHSRSYWYF	DVW	1	-0.43
12	μ	CTR	VASTMITVKRVL	DYW	3inv	0.57
13	μ	CAR	SIVIIVEA	KLW	2	1
14	μ	CAR	PGRNHSRSYPYF	DYW	1	-0.41
02	μ	CAR	GGIHRKNLV	CLW	nf	0.05
05	μ	CAR	RD	AYW	nf	-1.15
09	μ	CAR	HPLRRYF	DYW	nf	-0.24
15	μ	CTR	PVIPEAWF	AYW	nf	0.41
16	μ	CVR	HGTYSWR	GLW	nf	-0.39
20	γ	CTR	SWGDSKTYGSWF	AYW	nf	-0.21
21	γ	CAR	RF	AYW	nf	-0.1

Legend

^a – VH-encoded base of HCDR3.

^b – Predicted amino acid sequence of the HCDR3 loop.

^c – JH-encoded base of HCDR3.

^d – Reading frame of DH gene.

^e – The average, normalized Kyte-Doolittle hydrophobicity of the HCDR3 loop [72, 73].

Amino acids marked in green correspond to DH germline sequence in Δ D-iD mice.

Amino acids marked in red are generated by N and P region insertions.

nf – not found

HCDR3 amino acids in late primary antibodies in Δ D-iD mice

As expected, the majority of these antibodies expressed mainly hydrophilic amino acids in HCDR3 so that the average hydrophobic score of the D loops became negative (hydropathy index lower than - 0.1; Tab. 21). In fact, all RF1 translated HCDR3 had the lowest hydrophobic values and antibodies with positive scores were translated in RF2 and RF3 or the reading frame could not be assigned. In contrast to the early primary antibodies, HCDR3 sequences of all these antibodies showed no similarities to the typical D-loops of Id_{Ox1} antibodies and also the middle DRG motive was not verified. This finding supports again the conclusion that the selection of phOx-repertoires at the different stages of the immune response is individually specific for every mouse.

Conclusions:

- In the late primary anti-phOx antibodies of Δ D-iD mice, hydrophilic amino acids are selectively expressed in HCDR3.
- The divergence of the HCDR3 sequences from those of Id_{Ox1} antibodies confirm findings from the early response in this mouse strain.

3.5.2.3 Analysis of secondary anti-phOx antibodies

Although 4 fusions were performed after secondary immunization which all exhibited normal cell growth, we obtained only 2 anti-phOx antibody-secreting hybridomas from one fusion, 1 IgM and the other an IgG antibody (Tab. 22). The IgM antibody iD2^o-01 exhibited 1 silent and 3 productive mutations in VH as well as in VL. The IgG antibody iD2^o-02 showed a high number of mutations in VH and half as many mutations in VL. Hence, it can be concluded that especially this IgG antibody had undergone immune maturation. This is also indicated by its substantially enhanced relative affinity in comparison to the Id_{Ox1} IgG antibody NQ2/16.2 (Tab. 22).

While the HCDR3 nucleotide sequence of the IgG antibody was germ line-related, the reading frame of the IgM antibody could not be assigned (Tab. 23) and the deduced HCDR3 amino acid sequences were not related to those of Id_{Ox1} antibodies (Tab. 24).

Conclusions:

- Although it is not possible to draw firm conclusion from only 2 secondary antibodies, it is again astonishing that an IgM antibody could be isolated 3 days after secondary immunization with the TD antigen phOx-CSA.

- Enhanced mutations and an increased affinity of the IgG antibody indicated that secondary antibodies in Δ D-iD mice are derived from an immune matured repertoire.

Table 22

VH/VL gene combinations of phOx-CSA-induced secondary anti-phOx antibodies in Δ D-iD mice

MAb ^a	VH chain genes						VL chain genes					rel.
	iD2 ^o	Ig ^b	Fam ^c	Cl ^d	IGHV ^e	p/s ^f	J	Fam ^c	Cl ^d	IGKV ^e	p/s ^f	J
01	μ	6	1	114	3/1	2	9A	1	108	3/1	5	0,5
02	γ	1	3	386	13/4	2	9A	1	108	6/1	2	306,6

Legend

- ^a – The annotation of antibodies indicates their generation from Δ D-iD mice (iD), after secondary immunization (2^o) and is followed by a sequential number. All clones are generated from the same fusion.
- ^b – Isotype of the monoclonal antibody.
- ^c – Indication of VH or VL gene family in the VBASE2 integrative database.
- ^d – In the integrative database VBASE2, the genes are classified: for class 1 genes there is genomic and rearranged evidence, for class 2 genes only genomic evidence and for class 3 genes only rearranged evidence.
- ^e – VH and VL gene numbers according to the integrative database VBASE2.
- ^f – Productive (p) and silent (s) mutations of corresponding VH and VL chains.
- ^g – The relative affinities were measured in a hapten inhibition test in comparison to Id_{Ox1} IgM and IgG anti-phOx antibodies, respectively.

Table 23

Nucleotide sequences of HCDR3 of phOx-CSA-induced secondary anti-phOx antibodies

iD2 ^o	----VH ^a ----	-----DH ^b -----	----JH ^c ----	RF ^d
DH gene		TT TAT CGT AAT CAT AGT AGA AGC TAC		
01 μ	TGT ACC AGG CGG GGC		GAC TAC TGG	nf
02 γ	TGT GCA AGA CTA CGT AAT CAT GGA		GAC TCT TGG	1

Legend

- ^a – VH-encoded base of HCDR3.
- ^b – DH nucleotides of the HCDR3-loop.
- ^c – JH-encoded base of HCDR3.
- ^d – Reading frame of DH gene.
- inv – inverted.
- nf – not found.

Nucleotides marked in green (≥ 6 successive nucleotides) correspond to DH germline sequence in Δ D-iD mice.

Nucleotides marked in red are generated by N and P region insertions.

DH germ line coding sequence of Δ D-iD is outlined in first line in green colour.

Table 24

Predicted amino acid sequences of HCDR3 of phOx-CSA-induced secondary anti-phOx antibodies generated from Δ D-iD mice

iD2°		Base ^a	CDRH3-loop ^b	Base ^c	RF ^d	H ^e
01	μ	CTR	RG	DYW	nf	-0,64
02	γ	CAR	LRNHG	DSW	1	-0,36

Legend

- ^a – VH-encoded base of HCDR3.
^b – Predicted amino acid sequence of the HCDR3 loop.
^c – JH-encoded base of HCDR3.
^d – Reading frame of DH gene.
^e – The average, normalized Kyte-Doolittle hydrophobicity of the HCDR3 loop [72, 73].

Amino acids marked in green correspond to DH germline sequence in Δ D-iD mice.

Amino acids marked in red are generated by N and P region insertions.

nf – not found

3.5.2.4 Analysis of tertiary anti-phOx antibodies

Clonal development in the tertiary response

Two months after the secondary immunization, mice were immunized once more with phOx-CSA and hybridomas secreting anti-phOx antibodies were prepared by cell fusion 3 days later. From 2 fusions, we obtained 16 monoclonal antibodies (Tab. 25). In one fusion, we established 9 phOx-specific hybridomas; seven of them were of the IgG class and two were IgM antibodies. From the other animal seven hybridomas were derived all of which produced IgM antibodies. The 3 IgM antibodies iD3°-02, -4 and -04 and IgG antibody iD3°-12 were encoded by the VHOx1 gene VH171. While IgM antibody iD3°-3 and IgG antibody iD3°-12 showed the canonical VHOx1/VκOx1 gene combination, characteristic for phOx-specific antibody, the 2 IgM antibodies iD3°-02 and -04 were encoded by alternative VL genes. Antibody iD3°-09 was encoded by the VκOx1 gene Vκ072 in combination with an unknown VH gene.

Conclusions:

- In contrast to anti-phOx antibodies from earlier stages of TD immune responses, tertiary antibodies contained again VH171/Vκ072-encoded Id_{Ox1} antibodies.
- However, the Id_{Ox1} clonotype was not dominant and there was no other dominant clone.

Table 25

VH/VL gene combinations of phOx-CSA-induced tertiary anti-phOx Abs in Δ D-iD mice

MAb ^a		VH chain genes					VL chain genes					rel.
iD3 ^o	Is ^b	Fam ^c	Cl ^d	IGHV ^e	p/s ^f	J	Fam ^c	Cl ^d	IGKV ^e	p/s ^f	J	Aff. ^g
01 ^h	μ	2	1	201	0/0	2	4/5	1	050	0/0	5	-
02 ^h	μ	2	1	171^k	1/0	2	9/10	1	137	0/0	2	0,3
03 ^h	μ	2	1	171^k	0/0	3	4/5	1	072^k	0/0	5	1,0
04 ^h	μ	2	1	171^k	0/0	1	4/5	1	079	0/0	2	-
05 ⁱ	μ	5	1	192	1/0	4	4/5	1	157	0/0	5	0,03
06 ⁱ	μ	5	1	148	-/-	4	38C	1	140	1/0	1	0,01
07 ^h	μ	5	1	147	0/1	4	10	1	137	0/0	1	-
08 ^h	μ	5	1	135	2/1	1	21	1	210	0/0	1	0,01
09 ^h	μ	-	-	-	-/-	-	4/5	1	072^k	0/0	2	-
10 ⁱ	γ	1	3	386	7/1	2	9A	1	108	0/1	2	3,8
11 ⁱ	γ	1	3	386	12/3	2	9A	1	108	-/-	2	2,8
12 ⁱ	γ	2	1	171^k	5/3	3	4/5	1	072^k	4/1	5	143,7
13 ⁱ	γ	3	1	120	-/-	2	23	1	168	8/2	1	13,9
14 ⁱ	γ	7	1	158	14/8	3	1	1	115	2/1	2	4,6
15 ⁱ	γ	-	-	-	-/-	-	23	1	168	0/1	2	2,5
16 ⁱ	γ	-	-	-	-/-	-	VRF	1	128	4/3	1	4,6

Legend

- ^a – The annotation of antibodies indicates their generation from Δ D-iD mice (iD), after tertiary immunization (3^o) and is followed by a sequential number.
- ^b – Isotype of the monoclonal antibody.
- ^c – Indication of VH or VL gene family in the VBASE2 integrative database.
- ^d – In the integrative database VBASE2, the genes are classified: for class 1 genes there is genomic and rearranged evidence, for class 2 genes only genomic evidence and for class 3 genes only rearranged evidence.
- ^e – VH and VL gene numbers according to the integrative database VBASE2.
- ^f – Productive (p) and silent (s) mutations of corresponding VH and VL chains.
- ^g – The relative affinities were measured in a hapten inhibition test in comparison to Id_{Ox1} IgM and IgG anti-phOx antibodies, respectively.
- ^{h,i} – Indication of different fusions.
- ^k – Id_{Ox1} genes VH171 and V κ 072 are marked in bold.
- – Sequence not determined.

Grey background shows the Id_{Ox1} gene combination VH171/V κ 072.

Table 26

Nucleotide sequences of HCDR3 of pHox-CSA-induced tertiary anti-pHox Abs generated from Δ D-iD mice

iD3°	---VH ^a ---			-----DH ^b -----										---JH ^c ---			RF ^d									
DH gene				TT	TAT	CGT	AAT	CAT	AGT	AGA	AGC	TAC												1		
01	μ	TGT	GCC	AAA	ATG	GGT	CGT	AAT	CAT	AGT	AGA	AGC	TAC	TTT			GAC	TAC	TGG						1	
04	μ	TGT	GCC	AGA					GCG	GGT	AGA	AGC	TAC	GGG	TGG	TAC	TTC			GAT	GTC	TGG		1		
07	μ	TGT	GCA	AGA	ATC	AAT	CGT	AAT	CAT	AGT	AGA	AGC	TAC	CCG	GGG	TAC	TTT			GAC	TAC	TGG		1		
08	μ	TGT	GCA	AGT	ATT	TAT	CGT	AAT	CAT	AGT	AGA	AGT	CAC	TGG	TAC	TTC			GAT	GTC	TGG		1			
02	μ	TGT	GCC	AGA	GAT	GGG	GGG													GAC	TAC	TGG		nf		
03	μ	TGT	GCC	AGA	GAT	GGA	GGG													ATT	TCC	TGG		nf		
05	μ	TGT	GCA	AGA	TCC	CGT	TAC	GAT	TAC	TAT	GCT	ATG									GAC	TAC	TGG		nf	
06	μ	TGT	GCA	AGA	CAT	GGA	GCT	CCT	TAT	TAC	TAC	GGT	AGT	AGC	TAC	TAT	GCT	ATG			GAC	TAC	TGG		nf	
10	γ	TGT	GTA	AGA	AAG	TTC	CGA	GGG	GGT												GAC	TAC	TGG		nf	
11	γ	TGT	GTA	AGA	AAG	TTC	CGA	GGG	GGT												GAC	TAC	TGG		nf	
12	γ	TGT	GCC	AGA	GAT	GGA	GGT														GCT	TTC	TGG		nf	
13	γ	TGT	GTA	AGA	GGA	GGG	ACG	GTA	GTA	GCT	TTT										GAC	TAC	TGG		nf	
14	γ	TGT	GCA	AGA	GGG	TTG	TAC	GAG	GGA	GCC	TGG	TTT										TCT	TAT	TGG		nf

Legend^a – VH-encoded base of HCDR3.^b – DH nucleotides of the HCDR3-loop.^c – JH-encoded base of HCDR3.^d – Reading frame of DH gene.

inv – inverted.

nf – not found.

Nucleotides marked in green (≥ 6 successive nucleotides) correspond to DH germline sequence in Δ D-iD mice.

Nucleotides marked in red are generated by N and P region insertions.

Nucleotides marked in blue (4 or 5 successive nucleotides) correspond probably to DH germline sequence in Δ D-iD mice.DH germ line coding sequence of Δ D-iD is outlined in first line in green colour.

Mutations in tertiary antibodies

The tertiary IgM antibodies were either non- or almost non-mutated. In fact, VH genes of antibodies iD3^o-01, -03 and -04 and all VL genes, except antibody iD3^o-6, did not present any deviation from the respective germ line genes. In contrast, the IgG antibodies showed high numbers of productive and few silent mutations (Tab. 25). The relative affinity of the Id_{Ox1} antibody iD3^o-03 was identical to the control Id_{Ox1} antibody H11.5 (μ , κ), while affinities of the non-Id_{Ox1} antibodies was 10-100-times lower. In contrast, although IgG antibodies displayed many mutations the affinity of most of them remained comparably low. The relative affinities of antibodies iD3^o-10, -11, -14, -15 and -16 were only slightly higher than that of the primary IgG Id_{Ox1} antibody NQ2/16.2 (γ , κ). The affinity of antibody iD3^o-13 was ~14-times higher than that of NQ2/16.2 and only the Id_{Ox1} antibody iD3^o-12 exhibited an affinity comparable to those of BALB/c WT mice, *i.e.* about 150-times higher than primary Id_{Ox1} antibody NQ2/16.2 (Tab. 25). The affinity maturation of antibody iD3^o-12 can also be deduced from the fact that the VL-coding gene V κ 072 shows the well known classical affinity-enhancing early mutations H>N in position 33 and Y>F in position 35 (Fig. 2 in the appendix). However, the known mutation S>T in position 31 in VH171 gene of antibody iD3^o-12 was not seen.

Conclusions:

- In the tertiary response of Δ D-iD mice, a high percentage of naïve, non-mutated and non-maturated IgM antibodies are obtained by cell fusion.
- These IgM antibodies resemble antibodies from the primary response.
- In individual Δ D-iD mice, the tertiary response may contain somatically mutated and affinity-maturated Id_{Ox1} antibodies.

HCDR3 nucleotide sequences of tertiary antibodies

The HCDR3-coding nucleotide sequences of the tertiary anti-phOx antibodies are depicted in Tab. 26. As observed before, RF1-encoded sequences are not totally avoided, but verified in 4 IgM antibodies. In the other 4 IgM and 5 IgG antibodies, the HCDR3 reading frames could not be assigned. RF2 and RF3 were not observed. Except in antibodies iD3^o-02, -03 and -12, the lengths of the germ line non-related HCDR3 sequences were surprisingly long, especially in antibodies iD3^o-13, -14 and -06.

Conclusions:

- Since the germ line DH gene segment of Δ D-iD mice codes for charged, *i.e.* hydrophilic amino acids, RF1 usage is suppressed, but not avoided.

- In a rather high proportion of antibodies, the HCDR3 reading frames could not be assigned.

Table 27

Predicted amino acid sequences of HCDR3 of phOx-CSA-induced tertiary anti-phOx antibodies generated from Δ D-iD mice

iD3°	Base ^a	CDRH3-loop ^b	Base ^c	RF ^d	H ^e
01	μ	CAK MGRNHSRSYF	DYW	1	-0,31
04	μ	CAR AGRSYGWYF	DVW	1	-0,02
07	μ	CAR INRNHSRSYPGYF	DYW	1	-0,29
08	μ	CAS IYRNHSRSHWYF	DVW	1	-0,29
02	μ	CAR DGG	DYW	nf	-0,31
03	μ	CAR DGG	ISW	nf	-0,31
05	μ	CAR SRYDYAM	DYW	nf	-0,21
06	μ	CAR HGAPYYYGSSYYAM	DYW	nf	-0,03
10	γ	CVR KFRGG	DYW	nf	-0,25
11	γ	CVR KFRGG	DYW	nf	-0,25
12	γ	CAR DGG	AFW	nf	-0,31
13	γ	CVR GGTVVAF	DYW	nf	0,72
14	γ	CAR GLYEGAWF	SYW	nf	0,24

Legend

- ^a – VH-encoded base of HCDR3.
^b – Predicted amino acid sequence of the HCDR3 loop.
^c – JH-encoded base of HCDR3.
^d – Reading frame of DH gene.
^e – The average, normalized Kyte-Doolittle hydrophobicity of the HCDR3 loop [72, 73].

Amino acids marked in green correspond to DH germline sequence in Δ D-iD mice.

Amino acids marked in red are generated by N and P region insertions.

nf – not found

HCDR3 amino acids in tertiary antibodies in Δ D-iD mice

The deduced amino acids for HCDR3 of the tertiary antibodies are hydrophilic to such an extent that the average hydrophobic score for the D-loops are mostly negative (Tab. 27). Only in antibodies iD3°-13 and – 14 they are slightly positive. Hence, this result presents further evidence for a positive selection of hydrophilic HCDR3-loops.

Three of the 4 antibodies encoded by the VHOx1 gene VH171 showed the Id_{Ox1}-related DH motive DGG, while in the fourth antibody (iD3°-04) the HCDR3 sequence show no such relation. Interestingly, in antibody iD3°-12 which show highest affinity, the entire CDR3-loop, *i.e.* the VH-encoded base plus the HCDR3-loop plus the second base = CAR-DGG-

AFW, is most similar to the respective prototypic sequence of true Id_{Ox1} antibodies (CAR-DRG-AYW).

Conclusions:

- The expression of the original Id_{Ox1} motive DRG or its modified forms DXG is rather independent of the available germ line DH segments.
- Moreover, these findings confirm that this motive is completely associated with the VHOx1 gene VH171.

As general conclusions from the analysis of the thymus-dependent anti-phOx response in ΔD-iD mice it can be stated:

- 1.) As in ΔD-D_μFS mice, the restriction of the number of DH gene segments to a non-natural D gene segment which encodes for charged amino acids in HCDR3, demonstrates the extraordinary variability at the third hypervariable region which is enzymatically created during VDJ-recombination by exonucleases and the insertion of non-templated (N) and palindromic (P) nucleotides.
- 2.) The restriction of the number of DH gene segments to one artificial D gene, coding for charged amino acids, causes a substantial reduction of the antibody repertoire of these mice.
- 3.) The canonical VH/VL gene combination VH171/Vκ072 together with Id_{Ox1}-typical amino acid sequence DRG in HCDR3 is extremely rarely verified and, if so, only in particular animals.

4 Discussion

Adaptive immune responses are generated by B and T lymphocytes. Their ability to recognize a huge multitude of different molecular structures on antigens relies on a similarly huge repertoire of clonally distributed antigen receptors, BCR on B and TCR on T cells. The variable portions of antigen receptors of both lymphocyte populations are created by V(D)J recombination, pairing of immunoglobulin H and L chains in B cells and α and β or γ plus δ chains in T cells as well as imprecisions during the recombination process. These imprecisions are based on a) the action of exonucleases which delete variable numbers of nucleotides from the coding ends of the involved genes, b) addition of palindromic (P) nucleotides and c) random addition of non-template (N) nucleotides by the enzyme terminal deoxynucleotidyl transferase (TdT). Due to the fact that the diversity-enhancing DH genes are rather short mini-genes, the recombinatorial imprecisions create a huge non-genetic repertoire at the third hypervariable regions of the BCR (HCDR3) as well as the TCR (V β CDR3). In addition, the size of this repertoire depends on the possibility that the modified D genes can be translated in all 6 reading frames. Together, these mechanisms enable the immune repertoire to recognize a seemingly unlimited universe of antigens. Imprecisions during V(D)J recombination can modify a particular DH gene to such an extent that it can not be deduced from the final nucleotide sequence. Hence, since the HCDR3 is the most diverse component of antibodies and lies at the centre of antigen-binding site, it plays a significant role in the development of cellular and humoral immune responses.

The relative contributions to the entire antibody pre-immune repertoire of the genomic repertoire of V(D)J genes on the one hand and the non-genetic generation of DH gene-associated variability on the other have only incompletely been studied. In a previous study [28], it has been demonstrated that mice with a single VH gene but complete DH and JH gene clusters are able to respond to a variety of quite different protein antigens like keyhole limpet hemocyanin (KLH), ovalbumin (OVA), hen egg-white lysozyme (HEL), cholera toxin B subunit (CTB) and haptens like 2,4-dinitrophenyl (DNP, coupled to KLH), phOx-conjugated CSA and phosphorylcholine (PC, coupled to KLH). It was observed that antibodies specific for these antigens differed only in HCDR3. Therefore, the authors concluded that the diversity at HCDR3 is decisive for determining the fine specificity of the antigen binding site while the genome-encoded CDR1 and 2 are much more cross-reactive. Thus, this model would argue that the high number of variable genes only supplies this underlying background reactivity

whereas the precise specificity for the epitope is provided by HCDR3. In the study by Xu and Davis [28], it was also observed that memory antibodies developed surprisingly high affinities through somatic mutations.

The contribution of recombinatorial non-genetic imprecisions to the pre-immune repertoire of specific immune responses has so far only been investigated in TdT knock-out mice which, because of this genetic defect, lack N-region diversity [29, 85]. Therefore, HCDR3 loops of TdT⁻ mice are shorter and less diverse than in WT mice. These mice harbor an immature repertoire [86] resembling that of fetal mice [85]. Nevertheless, with regard to efficiency as well as specificity, TdT⁻ mice develop quasi normal immune responses [38]. Hence, it seems necessary to reassess the general assumption that N-region diversity is required for an effective T and B cell repertoire. However, other results give better insights into the significance of TdT-mediated junctional diversification. Since HCDR3 is of central importance for expression of idiotypic determinants [52] it is not surprising that particular idiotypes are lost in TdT⁻ mice [87]. Moreover, HCDR3 sequences are important for binding of self antigens by autoantibodies and autoreactive T cells. Accordingly, compared to wildtype control mice, TdT⁻ mice showed lower serum concentrations of DNA-reactive autoantibodies and rheumatoid factor activity and had shorter HCDR3 with fewer arginines [88]. These lower autoantibody concentrations seem to be due to a lower incidence of polyreactivity and lower affinity of anti-DNA autoantibodies [89]. A physiological significance of this finding is indicated by the fact that, in an animal model, TdT deficiency reduces autoimmune nephritis and prolongs survival although the concentrations of anti-DNA and anti-histone autoantibodies were similar as in WT control mice [90]. Hence, either the autoantibodies under consideration are not the indicative parameter or the protective effect of TdT deficiency seems to be mediated indirectly. In relation to the above mentioned findings by Mi and co-workers [87], idiotypic regulation and regulatory T cells may be considered as possible mechanistic pathways.

The influence of DH gene restriction on the immune system has been investigated in different mutant strains (Tab. 28). The restriction to the single natural DH gene DFL16.1 in Δ D-DFL mice had no severe impact on several parameters of B cell development. Although the number of IgM⁺/IgD⁻ pre-B cell in the bone marrow was decreased, numbers of mature IgM⁺/IgD⁺ B cells in bone marrow and spleen as well as of B1a, B1b and B2 in the peritoneum were as in WT mice [66]. In addition, the HCDR3 repertoire deduced from DFL16.1 was similar as in WT mice, but differed in HCDR3 sequences not related to DFL16.1. The total serum

immunoglobulin concentrations were slightly enhanced for IgM, IgG1 and 2a, but slightly decreased for IgG2b and similar for IgG3 and IgA (Tab. 28). Humoral IgG immune response to the two TD antigens NP-CGG and Tetanus toxoid (TT) were almost identical to wildtype control mice [66].

In contrast, DH mutant mice harbouring one of two artificial DH genes exhibited more severe alterations of B cell development. In one of these strains, Δ D-iD mice, the replacement of the central portion of *DFL16.1* by the complete inverted coding sequence of *DSP2.2*. resulted in coding for charged amino acids in HCDR3 [67, 68]. In Δ D-D μ FS mice, the reading frame of *DFL16* was shifted by insertion of two thymidine nucleotides. In this way, the preferentially used RF1 leads to a predominant usage of hydrophobic amino acids in HCDR3 [74]. Δ D-iD and Δ D-D μ FS mice showed an altered B cell development and reduced B cell numbers in bone marrow as well as in the spleen (Tab. 28). However, numbers of natural B cells in the peritoneum of Δ D-D μ FS mice were identical to those of wildtype mice. Under specific pathogen-free (SPF) conditions, concentrations of total IgM and IgA in Δ D-iD and Δ D-D μ FS were as in wildtype mice; however, all IgG subclasses were decreased in Δ D-iD, but alike in Δ D-D μ FS mice (Tab. 28) [68, 74]. In part, these findings contrast our own results. While the IgM concentration in sera of Δ D-D μ FS mice was identical to wildtype mice, they were slightly lower in Δ D-iD mice (Fig. 13). Total IgG concentrations were reduced in both strains and not only in Δ D-iD as observed by Ippolito, Schelonka and co-workers [68, 74]. In their experiments, the immune response to the TI-2 antigen dextran was impaired in both DH mutant strains, while the IgM response to the TD antigen tetanus toxin (TT) in Δ D-iD mice equalled that of WT mice and was even enhanced in Δ D-D μ FS mice [74]. Compared to WT mice, IgG responses to NP-chicken serum gamma-globulin (CGG) was decreased in Δ D-iD, but unchanged in Δ D-D μ FS mice, while the anti-TT IgG response was impaired in both strains. The general overview, given in Tab. 28, reveals that Δ D-DFL mice with a single natural DH gene showed the least while Δ D-iD mice with an artificial DH gene the most severe deviations from BALB/c WT mice.

Table 28

Comparison of the immune responses of 3 mutant mouse strains carrying different single DH gene segments relative to BALB/c wildtype mice

	Δ D-DFL [66]	Δ D-iD [68]	Δ D-D μ FS [74]
<u>Total nucleated cells</u>			
Bone marrow	↔	↔	↓
Spleen	↔	↓	↓
Peritoneal cavity	↔	↓	↔
<u>B cells total</u>			
Bone marrow	↔	↓	↓
Spleen	↔	↓	↓
Peritoneal cavity	↔	↓	↔
<u>B cells mature</u>			
Bone marrow	↔	↓	↓
Spleen	↔	↓	n.d.
<u>Total Ig</u>			
IgM	↑	↔	↔
IgG1	↑	↓	↔
IgG2a	↑	↓	↔
IgG2b	↓	↓	↔
IgG3	↔	↓	↔
IgA	↔	↔	↔
<u>Anti-NP-CGG</u>			
IgG	↔	↓	↔
<u>Anti-TT</u>			
IgM	↑	↔	↑
IgG	↔	↓	↓
IgA	↔	n.d.	↔
<u>Anti-Dex</u>			
IgM	↓	↓	↓
IgG	↓	↓	n.d.

Legend

The different indicated parameters were compared with those of BALB/c wildtype mice. Double arrows (↔) indicate no difference while green and red (↑/↓) arrows symbolize an increase and decrease, respectively.

Total (CD19⁺) as well as mature (CD19⁺CD21^{lo}CD23^{hi}) B cells were determined by FACS analysis.

The humoral immune responses were measured by ELISA.

Dex - dextran

NP-CGG - 4-hydroxy-3-nitrophenylacety-chicken gamma globulin

TT - Tetanus Toxin

n.d - not determined

However, the quality of a particular immune response in the latter 2 mutant mouse strains has so far not been investigated at the level of single B cell clones. Therefore, the data presented herein describe for the first time the connection between clonal development during the TD immune response and a particular DH gene.

4.1 B cell development in DH mutant mice

How do these data relate to our observations? In both of our DH mutant strains, the total lymphocyte and B cell counts in the bone marrow were rather enhanced than decreased (Tab. 3). In spleen, however, B cell numbers were clearly decreased as observed in the investigations by Schroeder and colleagues [66, 68, 74]. Hence, our data would indicate that simplifying the genomic DH segments to a single gene, coding for hydrophobic HCDR3 amino acids in ΔD -D μ FS or charged amino acids in ΔD -iD mice, does not influence the development of B cells in the antigen independent phase in the bone marrow and does not prevent an efficient V(D)J rearrangement, an assembling of H and L chain and the formation of pre-BCR in the bone marrow. Thus, the reduction of splenic B cells is most likely first induced in the periphery and does not reflect a lower influx of newly generated naïve B cells from the bone marrow. The progression from immature to mature naïve B cells is a critical phase in B cell development. Mainly non-autoreactive immature B cells are allowed to move from the bone marrow towards the periphery, where they undergo a second round of selection against peripheral auto-antigens. Is it possible that this negative selection in the periphery which eliminates autoreactive and B cells with non-functional BCR is responsible for the reduced numbers of B cells in the periphery?

As pointed out in the introduction, B and T cells mutually regulate the development of their repertoires [76, 77]. This finding is confirmed by the observation that spleens of B-cell deficient mice show a three- to fivefold reduction in T cell numbers [78]. Other studies in B cell deficient mice proved that the function of B cells is not limited to antibody production, but are also required for efficient T cell responses [79, 80]. In line with these observations, T cell numbers in the spleen of ΔD -D μ FS as well as ΔD -iD mice were drastically reduced (Tab. 3) although the genetic alteration in both strains of mice is restricted to Ig genes and does not affect the germ line repertoire of TCR.

After selection in the thymus, thymic emigrants mature to naïve immunocompetent T cells in secondary lymphoid organs. In the spleen, T cells are located in the periarteriolar lymphoid

sheath (PALS), which also contains low numbers of plasma cells, macrophages, and interdigitating dendritic cells (DC) [91]. The PALS is surrounded by a region containing primary follicles, which are filled with B cells and macrophages. Naïve T cells become activated when they are exposed to antigen-MHC complexes presented by resident DCs or other antigen presenting cells [92].

On the other hand, studies in B cell-deficient mice generated by μ -chain gene disruption showed that B cells provide signals which promote T cell accumulation in the spleen and support the development of splenic T-zone stromal cells as well as the accumulation of DCs [80]. Ngo et al. [78] reported that the numbers of T cells in the spleen of B cell-deficient mice were reduced threefold in comparison with WT controls. Our study provides further evidence for the necessity of B cells in normal development of splenic T cells. Thus, it can be assumed that the decrease of T cell numbers in ΔD -D μ FS and ΔD -iD mice results from an insufficient stimulus by a reduced number of B cells, which emerged from a simplified DH gene repertoire. Furthermore, it has been documented that B cells can act as APC in the initiation of T cell maturation [93, 94]. Indeed, B cells are highly efficient for the presentation of their BCR-specific antigen in association with MHC molecules to mature T_H cells, and can stimulate proliferation and differentiation of naïve T cells. Therefore the decrease in antigen presentation affects the T cell maturation. Together, reduced splenic T cells in ΔD -D μ FS and ΔD -iD mice reflect insufficient chemokine-producing B cells and / or the impairment of antigen presentation by B cells or both.

In contrast, the numbers of T and B cells in the bone marrow of mutant mice were similar to that of WT controls. In the bone marrow, the B cells include all stages of B cell development as well as memory and long lived plasma cells [95, 96]. Concerning the T cells, various studies showed that memory T cells (CD4⁺ and CD8⁺) migrate to the bone marrow of immunized mice and are sustained there over long periods of time [97-99]. Therefore our data suggest that the memory T cells are not affected by the alteration in the DH locus.

4.2 Humoral immune responses in DH mutant mice

The murine peripheral B cell pool consists of mature B cells and a small subset of three different cell types: long lived plasma cells, memory and B1 cells. Mature IgM⁺/IgD⁺ B cells are the main source of cells participating in the primary immune response. They differentiate into specific antibody-producing plasma cells and in case of TD antigens also into memory B cells

[100]. Our data show that the total population of splenic B cells, including MZ, B-1 and follicular B cells are reduced in ΔD -D μ FS and ΔD -iD mice, but does this cause impaired humoral immune responses? For approaching an answer to this question, we first analyzed the initial situation and determined a) the total IgM and IgG serum concentrations, b) phOx-specific background antibodies and c) anti-phOx antibody-secreting cells before any immunization, namely in non-immunized animals.

As shown in Fig. 13, the concentrations of total IgM were rather similar in WT and ΔD -D μ FS mice, but reduced in ΔD -iD mice. In contrast, IgG concentrations were significantly reduced in both DH mutant strains. Surprisingly, spleens of the DH mutant strains contained almost twice as many IgM-anti-phOx secreting cells than wildtype mice (Fig. 11). Also in the bone marrow, IgM-anti-phOx secreting cells were almost threefold higher in mutant as compared to wildtype control mice (Fig. 11). These natural IgM antibodies are known to be produced by B-1 cells without antigenic stimulation. Natural antibodies recognize antigens of many common pathogens and they are capable of self-renewal [101]. In addition to the protective function against pathogens, antibodies produced by B-1 cells play an important role in the clearance of apoptotic cells. Moreover, B-1 and MZ B cells are proposed to provide protection during responses against bacterial TI-2 antigens [102, 103]. The B-1 cells predominantly reside in peritoneal and pleural cavities and only a small number is found in the spleen. Natural antibodies are mostly of the IgM class, they are auto- as well as poly-reactive, encoded by immunoglobulin V genes in germ line configuration, and they react with low affinity with a variety of endogenous and exogenous antigens [104]. Thus, B-1 cells and their natural antibodies represent part of the pre-immune repertoire.

Own data have demonstrated that natural phOx-reactive antibodies do not participate in the TD phOx-CSA-induced response (Lange et al., in preparation). This view is supported by the observation that the enhanced amounts of background anti-phOx-secreting cells in spleen and bone marrow of DH mutant mice does neither correlate with the phOx-Ficoll-induced TI-2 nor with the phOx-CSA-induced TD antibody response. The TD-induced IgM-anti-phOx serum concentrations measured 1 week after stimulation with phOx-CSA were slightly lower in both DH mutant mouse strains (Fig. 15). This is astonishing, since the number of IgM-anti-phOx-secreting plasma cells in the spleen of DH mutant mice were much higher than in WT mice (Fig. 12A). This can only be explained by the assumption that the amount of Ig produced by a single antibody-forming cell (AFC), as indicated by the size of the ELI-spot, varies considerably especially for IgM-AFC (Fig. 10). The TD-induced IgG response was

strongly suppressed in correlation with reduced number of IgG-AFC (Fig. 15). Antibody production in both DH mutant mouse strains after stimulation with phOx-Ficoll, however, was almost identical for IgM and developed slightly faster IgG response in Δ D-DuFS mice, but was not significantly different in Δ D-iD and wildtype mice (Fig. 14).

IgG antibodies are produced by short and long lived plasma cells. The short lived plasma cells, continuously generated from activated memory B cells after re-stimulation with the antigen, are responsible for an immediate increase of the IgG serum titer and have a lifespan of a few days. The long lived plasma cells are responsible for long-term production of serum antibodies. They can survive in the BM (95 %) or in the spleen (5 %) for extended periods of time, apparently from several months to years [105]. These long-lived plasma cells or their precursors are generated in germinal centres of secondary lymphoid organs like the spleen, and then migrate to the bone marrow, where they take up residence in a complex molecular microenvironment, a survival niche. Due to their antigen independent survival, they can maintain the humoral memory to previously encountered antigens without antigenic stimulation [106, 107]. However the switch from IgM to IgG occurs usually in the germinal centre and is driven by T_H cell cytokines [108]. Thus, the low IgG concentration in our DH mutant mice probably reflects the reduction in the IgM>IgG switched plasma cells. A reduced number of phOx-specific IgG memory B cells can also be concluded from the observation that the difference in antibody production between WT on the one hand and DH mutant mice on the other remained after secondary renewed stimulation with phOx-CSA (Fig. 15). The data, however, do not give any information about the cellular components of the primary and further immune responses. It is important to remember that a substantial number of IgM-secreting hybridomas could be established at times of the TD immune response when in WT mice such IgM-producers have never been seen, *i.e.* in the late primary, secondary and tertiary response (see below). Hence, the restriction of HCDR3 by using a single DH segment encoding for hydrophobic or charged amino acids severely impairs all stages of TD immune responses. In contrast, pre-immune sera and TI-2 responses seem to be not affected to a great extent.

4.3 Comparison of anti-phOx repertoires in wildtype and DH mutant mice

It was of interest to compare the repertoire of all anti-phOx antibodies generated in this study from DH mutant mice with that of BALB/c wildtype mice. Fortunately, the VH/VL gene combinations of almost 200 anti-phOx antibodies from WT mice were available (Lange et al.,

in preparation). The repertoire of these antibodies represents a) natural antibodies, *i.e.* the hybridomas were obtained from non-immunized mice, b) antibodies obtained after immunization with the TI-2 antigen phOx-Ficoll, c) anti-phOx antibodies received after primary to quaternary immunizations with the TD antigen phOx-CSA and d) various combinations of initial TI-2 and following TD immunizations or *vice versa*. Altogether, this WT anti-phOx repertoire was encoded by 44 VH and 40 VL genes (Tab. 29). It is striking to see that IgM antibodies are distributed all over the table, whereas IgG antibodies are concentrated in certain areas of VH/VL combinations. Most of them are encoded by one of the Id_{Ox1} genes VH171 or V κ 072. The highest proportion of IgG antibodies is encoded by the Id_{Ox1} combination VH171/V κ 072. This demonstrates that most IgM-anti-phOx antibodies, activated during the early phases of primary TI-2 and TD responses, did **not** undergo class switch recombination. This is especially striking for IgM antibodies which are encoded by VH1 family genes. With the exception of four VH532/V κ 115-encoded antibodies, none of them switched to the IgG class.

Hence, the question was as to whether the new anti-phOx antibodies obtained from DH mutant mice were encoded within this panel of VH and VL genes. Therefore, we extended Tab. 29 and included all anti-phOx antibodies from the 2 DH mutant strains (Tab. 30). In this table, the light colours represent antibodies from the early stages of the response whereas dark colours symbolized antibodies from the late stages. The darkest colours show antibodies from tertiary responses. To our surprise, these antibodies were encoded by 24 more VH and 12 more VL genes. However, the new VH genes belonged to the same families already seen in WT mice. Most of the additional 24 VH genes (15 = 62 %) belonged to the VH1 family and the rest pertained to VH families 2, 3, 5, 6, 7, 9 and 14. The new VL genes belonged to families 1, 4/5, 8, 9/10, 19/28, 21 and 23, already seen in wildtype mice, and to the new VL families 24/25 and 38C. In contrast to WT antibodies (Tab. 29), IgG antibodies of DH mutant mice were more evenly distributed over the whole table and a comparably high proportion of IgG antibodies were encoded by VH1 family genes (Tab. 30). From Tab. 30 it is already obvious that Id_{Ox1} antibodies did not dominate any phase of the response, neither in Δ D-iD (Tab. 30, yellow to reddish colours) nor in Δ D-D μ FS mice (Tab. 30, blue colours).

Hence, in principle, anti-phOx antibodies from Δ D-iD and Δ D-D μ FS DH mutant mice can make use of VH and VL genes already known from BALB/c WT mice. But in addition, a large fraction of them is encoded by V genes hitherto not observed in wildtype mice. Is it possible to explain this fact by a correlation between HCDR3 sequence and usage of VH/VL gene combinations? It is conceivable that antibodies encoded by 'new' VH or VL genes carry new sequences in HCDR3 or that these sequences exhibit new properties which require an as-

sociation with new V genes to create a reactivity for the hapten phOx. However, the variability at HCDR3 is so high that we so far could not find such an association

4.4 D gene segments and homogeneity of immune responses

Despite the potential to create an enormous antibody repertoire, certain mouse strains respond to the immunization with some haptens and simple antigens with a remarkably homogenous population of antibodies. For instance, such dominant clonotypes or idiotypes are observed in the response of BALB/c mice to phosphorylcholine (PC) [109], p-arzophenylarsonate [110], (4-hydroxy-3-nitrophenyl)acetyl (NP) [111] and phOx [69]. As already mentioned above, the early stage (day 7) of the primary TD anti-phOx response of BALB/c mice is characterized by the dominant Ox1 idiotypic sequence with the VHOx1/VκOx1 = VH171/Vκ072 gene combination. In addition, the Id_{Ox1} specificity is correlated with the DRG sequence in the middle of HCDR3. The idiotypic characteristic is destroyed by somatic mutations during immune maturation and a repertoire shift is observed during the secondary response [112]. In clear contrast to these findings in WT mice, primary to tertiary anti-phOx antibodies from ΔD-DμFS and ΔD-iD mice did not contain the Id_{Ox1} or any other dominant clonotype. Moreover, there was no increased usage of the Id_{Ox1} genes in combination with alternative VH or VL genes. The Id_{Ox1}-typical DRG sequence in HCDR3 was only observed 3-times among early primary antibodies in ΔD-iD mice in the VH171 gene which, however, was associated with 3 different alternative VL genes (Fig. 18). Only in the tertiary response of a particular animal of ΔD-DμFS mice we obtained a major clonotype with the VH158/Vκ115 gene combination (Tab. 13).

This combination has already been observed as major clonotype in the secondary response of BALB/c WT mice [46]. However, a comparison of HCDR3 sequences in Tab. 15 with those in [46] revealed that some antibodies showed rather similar sequences while others differed considerably and we could not detect a common motive. Thus, the genomic elimination of all but one DH gene, coding for hydrophobic or charged amino acids in HCDR3, does not allow the development of dominant clonotypes.





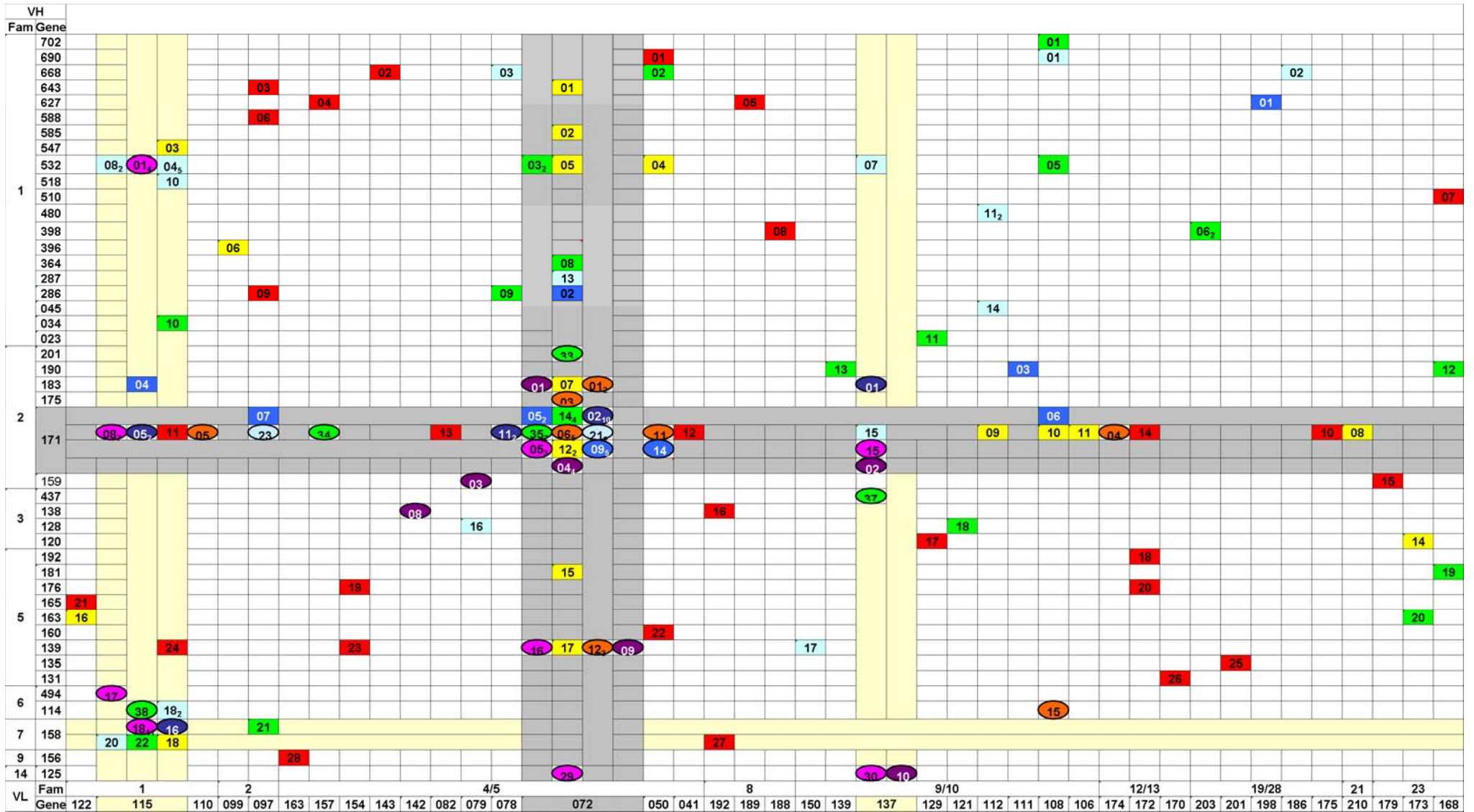



Table 29

VH/VL gene combinations of natural and antigen-induced anti-phOx antibodies of BALB/c wildtype mice



Legend

Sequences of variable region genes of heavy (VH) and light chains (VL) of anti-phOx hybridoma antibodies from BALB/c wildtype mice were analyzed with the integrative database VBASE2. IgM antibodies are indicated by filled rectangles and IgG antibodies by ellipses. Large numbers indicate the sequential numbers of a particular group of antibodies and subscript numbers specify the amount of antibodies with a particular VH/VL combination. Antibodies were obtained in the following way

-  - natural antibodies from spleens of non-immunized mice
-  - primary antibodies after immunization with the TI-2 antigen phOx-Ficoll
-  - primary antibodies after immunization with the TD antigen phOx-CSA
-  - antibodies obtained after tertiary TD and a final TI-2 immunization
-  - antibodies obtained after quaternary TD immunization
-  - antibodies obtained after initial TI-2 immunization and a primary TD immunization 1 month later and fusion on day 7
-  - antibodies were obtained after an initial TI-2 immunization and a primary TD immunization 3 months later and fusion on day 7
-  - initial TI-2 immunization, 3 months pause, followed by a primary TD immunization and fusion on day 14
-  - initial TI-2 immunization, 3 months pause, primary TD followed by a secondary TD immunization 8 weeks later and fusion on day 3.

Tab. 30

VH/VL gene combinations of thymus-dependent antigen-induced anti-phOx antibodies of DH mutant ΔD -D μ FS and ΔD -iD mice

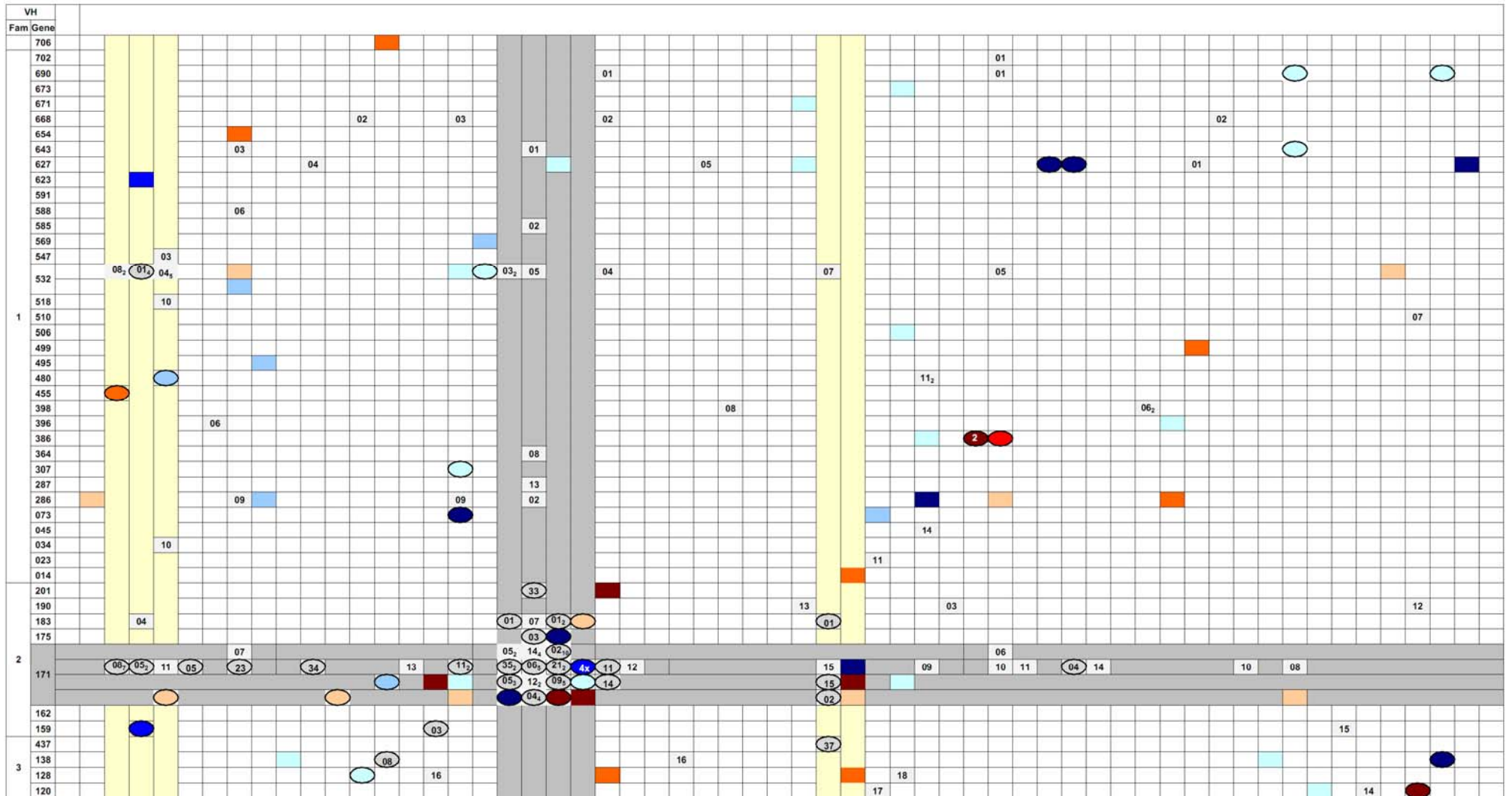

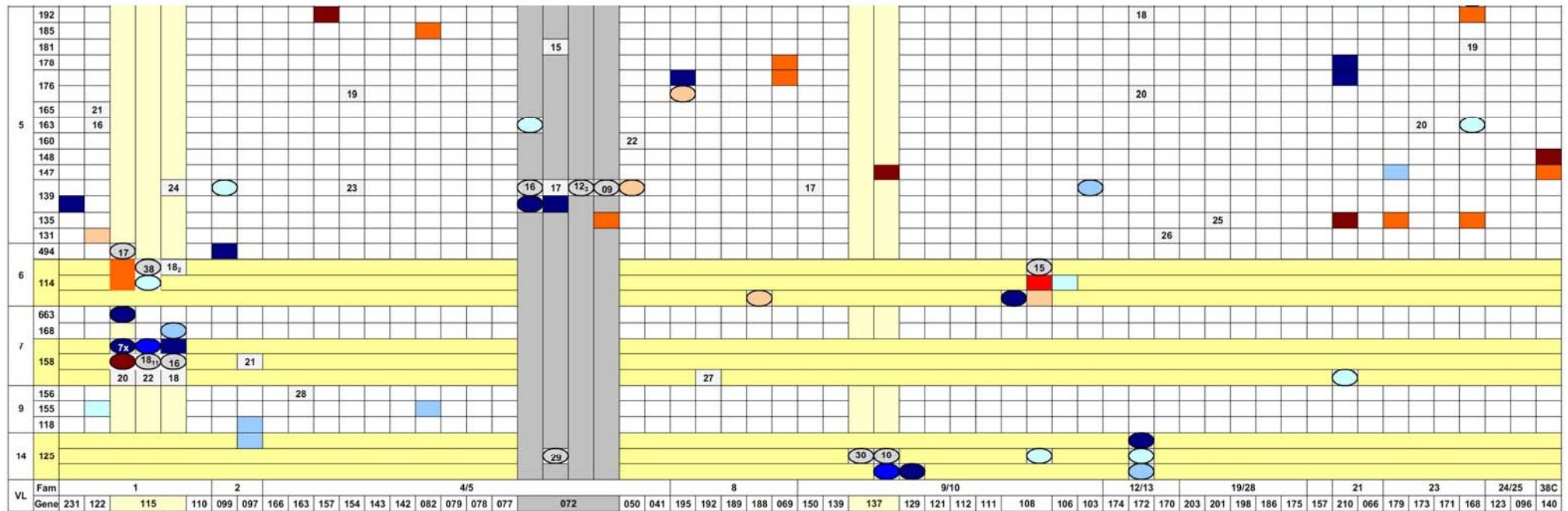

Legend

Sequences of variable region genes of heavy (VH) and light chains (VL) of anti-phOx hybridoma antibodies from ΔD -D μ FS and ΔD -iD mice were analyzed with the integrative database VBASE2 and compared with those of BALB/c wildtype mice. All wildtype antibodies of Tab. 29 are marked by a grey-dotted background.

IgM antibodies are indicated by filled rectangles and IgG antibodies by ellipses in white rectangles. The number of antibodies encoded by a particular VH/VL gene combination is also indicated. All antibodies were obtained after immunization with the thymus-dependent antigen phOx-CSA in the following way:

ΔD -D μ FS mice

□ - primary immunization and fusion on day 7; □ - primary immunization and fusion on day 14;

■ - secondary immunization, fusion on day 3; ■ - tertiary immunization, fusion day 3.

ΔD -iD mice

□ - primary immunization, fusion day 7; □ - primary immunization, fusion day 14;

■ - secondary immunization, fusion day 3; ■ - tertiary immunization, fusion day 3.

Hitherto, the dominance of particular clonotypic VH/VL gene combinations has been explained by their superior affinity. However, this argument does not seem to be really valid since we observed early primary clones of higher affinity than Id_{Ox1} antibodies in BALB/c WT as well as in both DH mutant mice. In Δ D-D μ FS mice, the affinity of 2 IgM non-Id_{Ox1} clones was enhanced by factors of 5, in 2 IgG antibodies by a factor of 14 and 1 IgG even by a factor of 115 (Tab. 4). In Δ D-iD mice, there were no early primary IgM non-Id_{Ox1} with enhanced affinities, but those of 3 IgG were enhanced by factors of 4, 6 and 9, respectively (Tab. 16). Hence, if affinity is a decisive or the only factor for activation of reactive clones, it is difficult to understand why such clones are not generally activated and become dominant clonotypes. Moreover, it has to be considered that the dominance of particular clones first becomes visible after class switch recombination to IgG (Lange et al., in preparation). Since this process is initiated and regulated by T cells and T cell-derived cytokines, it is tempting to speculate that the preferred selection of certain B cell clones over others is T cell-mediated and not only driven by affinity of the BCR. This view is in line with repertoire analyses after immunization with TI-2 antigens. The primary repertoire of C57BL/6 mice induced with NP-coupled Ficoll, a TI-2 carrier, is very heterogeneous while that of the TD response, induced with NP coupled to a protein as a TD carrier, is characterized by a dominant idio type which is composed of a V_H186.2 heavy chain in combination with a lambda-1 light chain [113]. Complementing investigations have demonstrated that C57BL/6 mice harbor B cells with much higher affinity than the dominant clonotype encoded by the VH186.2-lambda 1 gene combination [114]. Hence, why are those higher affinity clones not activated in the TD response and how can T cells perform such a clonotypic selection not depending on the BCR affinity?

Physiological recognition of protein antigens (including idiotypes) by T cell antigen receptors requires a processing by antigen-presenting cells followed by the presentation of small peptide fragments through MHC molecules on the surface of these cells. B cells are particularly efficient in presenting processed peptides since they can bind antigen specifically through their BCR. Therefore, antigen-specific B cells can stimulate T cells at antigen concentrations several orders of magnitude lower than those required for activation by nonspecific APC. B cells, however, do not only process BCR-bound antigen and present its fragments, but at the same time they present peptides of their intrinsic immunoglobulin H and L chains which can then be recognized by T cells (reviewed in [52]). Does this idiotypic MHC-restricted T-B interaction take place during TD antigen-induced immune responses? This is indeed the case as older investigations have shown. Antibody secretion by idio type⁺ B memory cells requires

two signals: one is provided by "carrier"-specific and the other by idiotypic-specific T helper cells. Both signals are required for optimal induction of idiotype⁺ B memory clones to secrete antibody [115]. From other studies it has also been concluded that a successful T-B cooperation requires two types of T helper cells, one recognizing the antigen and the other recognizing the idiotype of the B cell [116-118]. Hence, T cell regulation is probably responsible for the dominance of Id_{Ox1} antibodies and can not only be ascribed to their superior affinity. This allows concluding that a restricted DH gene repertoire causes a restricted T helper cell repertoire and in this way interferes with clonal progression during TD immune responses. The involvement of idiotypic-specific T cells in the clonal development during TD immune responses has been proposed since a long time. It has been argued that a) idiotypic interaction / suppression could be a way of dampening a dominating monoclonal response to favor the observed mutation drift and repertoire shift in the maturation of the immune response [55], b) a very dominant negative selection may act against the idiotype of primary antibodies [119] and c) HCDR3-associated idiotypic suppression may function as a driving force for diversification and maturation of the antigen-induced immune response [120].

Our sequence analyses demonstrated that the Id_{Ox1}-specific VH/VL gene combination plus the HCDR3-typical middle DRG sequence is only very rarely produced in a few Δ D-D μ FS and Δ D-iD mice. Since the T and the B cell system undergo a mutually selective expansion during early life, it is conceivable that our DH mutant mice with a drastically reduced HCDR3 repertoire fail to develop corresponding idiotypic-specific T cells and that this failure reduces both repertoires equally. This reduced T cell repertoire causes also an impaired class switch recombination, *i.e.* more than half of the hybridomas of both mouse strains generated at different stages of immune responses (primary, secondary and tertiary) produce IgM antibodies. Isotype switching is promoted by cytokines in the immediate microenvironment of the activated B cells inside or outside the germinal centre [121]. These cytokines are usually derived from T_H cells. Thus, the type of T_H cells which secrete a set of cytokines in the immediate microenvironment of the activated B cells, determine which antibody isotype will be produced. Without intervention of the T_H cells, the B cells 'consider' a TD as being TI antigen, and consequently, the majority of antibodies against this antigen will belong to the IgM isotype [122]. A similar scenario seems to happen in Δ D-D μ FS and Δ D-iD mice. The low numbers of T_H cells may produce too low amounts of cytokines to force isotype switching of all antigen-specific B cells. Consequently, only part of the IgM-secreting activated B cells switch to IgG after primary injection of TD antigen, whereas the majority of the IgM activated B cells die

by apoptosis after elimination of the antigen. As a result, the primary antigen-specific IgG as well as the total IgG concentration is reduced in both mutant mice strains. Furthermore, since the memory B cells develop only from the switched IgG cells in germinal centres, a second injection with the same antigen activates only reduced numbers of the memory IgG and virgin IgM B cells.

4.5 Selection of reading frames

Despite its overwhelming variability, there are some limitations in HCDR3 which seem to be necessary for a proper function of the adaptive immune system [123]. In murine as well as in human sera, immunoglobulins with neutral or slight hydrophilic HCDR3 are dominant, while HCDR3 with hydrophobic as well as charged residues are infrequent in WT mice. In part, this bias is due to a preferred usage of DH reading frame 1 (RF1) which codes for neutral and hydrophilic amino acids [124]. As RF1 of all 13 BALB/c DH segments codes for neutral and hydrophilic amino acids, it is not astonishing that 90 % of murine rearranged antibodies use the DH segments in RF1 [125, 126]. Consequently certain amino acids like glycine and tyrosine are overutilized, whereas hydrophobic and charged residues like arginine and lysine are underrepresented. Hence, despite the high plasticity at HCDR3 by insertion or deletion of some nucleotides during VDJ recombination, usage of hydrophobic or charged amino acids is relatively rare. However, it has been observed that auto-antibodies reacting with double-stranded DNA contain enhanced numbers of arginines in HCDR3 [127]. Such unusual rearrangements are not only observed in anti-DNA and but also in anti-nucleosome auto-antibodies and include alternative DH reading frames, inverted D segments, and D-D fusions, all coding for hydrophobic and charged residues [128]. Hence, it could generally be concluded that antibodies with hydrophobic or charged HCDR3-loops show auto-reactivity [129]. In addition, the porcine respiratory and reproductive syndrome virus (PRRSV) causes auto-immunity in neonatal piglets by inducing expansion of B cell clones bearing hydrophobic HCDR3s encoded by reading frame 3 of one particular DH segment [130]. On the other hand, the expression of auto-reactive BCRs can disrupt the development from immature to mature B cells and to promote receptor editing [131, 132].

In Δ D- μ FS mice, $\frac{1}{2}$ to $\frac{2}{3}$ of the antibodies use germline-encoded HCDR3 sequences, but only a minority of them is translated in RF1 and, as expected, this correlates with positive hydrophobicity scores (Tab. 6, 9, 12 and 15). Also in Δ D-iD mice, a significant number of B

cells express the germ line DH gene which, however, codes for charged HCDR3 amino acid sequences. Therefore, germline-encoded as well as germline non-related sequences, being translated in RF1 or non-RF1, are correlated with sometimes strongly negative hydrophobicity scores in HCDR3 (Tab. 18, 21, 24 and 27). However, some of the anti-phOx antibodies in ΔD -iD mice exhibit even strong hydrophobic scores, like the early primary antibodies ID1[°]7-02 (IgM) with a score of 1.13 and ID1[°]7-17 (IgG) with a score of 0.6 (Tab. 18), the late primary IgM antibody ID1[°]14-03 with a score of 0.51 (Tab. 21) and the tertiary IgG antibody ID3[°]-13 with a score of 0.72 (Tab. 27). Whether these B cells escaped negative selection in the periphery and exhibit, besides their anti-phOx reactivity, auto-reactivity remains a speculation. The first step of negative selection of auto-reactive B cells is thought to occur at the stage of pre-B cells when they are confronted with auto-antigens present in the bone marrow. A second round of negative selection is initiated when mature B cells encounter peripheral auto-antigens not expressed in bone marrow. If a BCR binds to this auto-antigen with high affinity, the maturation will be abrogated and the B cell dies by apoptosis (clonal elimination). Hence, negative selection of hydrophobic and charged HCDR3 clones in the periphery explains, at least in part, the reduction of B splenocytes of ΔD -D μ FS and ΔD -iD mice.

It can be assumed that the germ line non-related HCDR3 nucleotide sequences of ΔD -D μ FS and ΔD -iD antibodies result from the complete deletion of the whole germ line DH segment by exonucleases and a subsequent random addition of non-germ line (N) nucleotides inserted during VDJ joining processes. These N nucleotides are inserted by the terminal deoxynucleotidyl transferase (TdT), a unique enzyme capable of adding from one to twenty nucleotides to rearranging V, D, and J termini of immunoglobulins as well as of TCR [133]. As TdT is not expressed in early ontogeny, fetal BCR and TCR repertoires lack N regions and, as a consequence, perinatal HCDR3 are significantly less variable than those of adults, and the average length of HCDR3 increases with the development until adulthood [29, 39]. Hence, mice lacking TdT (TdT⁻) show a drastically reduced BCR and TCR repertoire. However, responses to TD and TI antigens are very similar in TdT⁻ and control mice [38], suggesting that N regions might not be required for an effective T and B cell immune response. Our data support the assumption that N nucleotides may have a function other than a source of diversity. N region insertions promote, in some cases, the construction of germ line independent HCDR3, *e.g.* when the DH segment codes for unfavourable residues (hydrophobic or charged amino acids). However, because DH segments are evolutionary pre-selected for nucleotides coding for neutral amino acids, the construction of DH independent HCDR3 is rarely used and only 5

% of the antibodies in sera of wildtype mice contain HCDR3 motives unrelated to any DH segment.

Table 31

Genomic and non-genomic nucleotide sequences in HCDR3 of anti-phOx antibodies of DH mutant mice ΔD -D μ FS and ΔD -iD

Ab	Class	ΔD -D μ FS			ΔD -iD			
		genomic yes	no	portion of non-genomic	Class	genomic yes	no	portion of non-genomic
1 $^{\circ}$ 7 ^{a)}	IgM	7	6	46 %	IgM	3	6	66 %
	IgG	11	7	39 %	IgG	4	2	33 %
1 $^{\circ}$ 14 ^{b)}	IgM	4	4	50 %	IgM	11	5	31 %
	IgG	5	2	29 %	IgG	1	1	50 %
2 $^{\circ}$ ^{c)}	IgM	2	0	0 %	IgM	0	1	100 %
	IgG	3	4	57 %	IgG	1	0	0 %
3 $^{\circ}$ ^{d)}	IgM	6	4	40 %	IgM	4	4	50 %
	IgG	16	6	27 %	IgG	0	5	100 %

Legend

- a) Primary antibodies obtained in fusion 7 days after immunization.
 b) Primary antibodies obtained 14 days after immunization.
 c) Secondary antibodies.
 d) Tertiary antibodies.

In both DH mutant strains, this picture is completely different. At all stages of the primary to the tertiary immune response in ΔD -D μ FS and ΔD -iD mice, the proportion of antibodies exhibiting genome non-related HCDR3 sequences ranges from about 30 to 66 % (Tab. 31). This applies for IgM as well as IgG antibodies. In tertiary anti-phOx antibodies of ΔD -iD mice, even 100 % of IgG antibodies (n = 5) had HCDR3 nucleotide sequences showing no relationship to the genomic DH gene. As mentioned above, these sequences may be generated by an initial removal of the DH gene and a subsequent addition of N and P nucleotides. A second possibility may result from a direct V to J joining, likewise associated with insertion of N and P nucleotides. Such a direct joining of VH to JH genes has been observed in

BALB/c mice *in vivo*, but at low frequency [134]. In addition, the rare V-J joining event seems to be unlikely because of the genetic restriction during the recombination process (one and two-turn roll). Hence, usage of any germ line DH gene will automatically generate a neutral or hydrophilic HCDR3. In the case of ΔD -D μ FS and ΔD -iD mice, the central nucleotides of the single DH gene code for hydrophobic and charged amino acids, respectively. Thus, a direct V-J joining is also one way to escape unfavourable HCDR3 interval.

4.6 Concluding remarks

The data presented demonstrate that the reduction of normally 13 DH genes in BALB/c wild-type mice to single artificial genes in ΔD -D μ FS and ΔD -iD mutant mice has a severe impact on the humoral immune response to the hapten phOx. This is astonishing since both mutant strains harbor the full repertoire of hundreds of variable and all joining genes which are needed for the generation of B cell antigen receptors. In addition, they have full access to create the vast repertoire of T cell antigen receptors. It was striking to see that the reduction of DH genes impaired not only immunoglobulin-related parameters of the immune response, but also suppressed associated T cell functions. The overall T cell numbers were reduced, the TD response was severely suppressed and T cell-mediated class switch recombination was impaired in all phases of immune maturation. As the switch- and T cell-dependent development of Id_{Ox1} dominance was abrogated in both DH mutant strains and no other dominant clonotype developed, it can be concluded that idiotype dominance does not depend on canonical VH/VL gene combinations, but on certain HCDR3-related idiotopes. Moreover, this finding supports our earlier assumption that clonal selection during immune maturation is not only mediated by BCR-affinity but is also regulated by HCDR3-specific, *i.e.* idiotype-specific T cells.

The analysis of HCDR3 sequences documented the extreme non-genetic variability at this region. In principle, HCDR3 sequences identical or similar to the Id_{Ox1}-specific sequence CAR-DRG-AYW could be created in both DH mutant strains. However, this event was obviously so rare that it only occurred in a few individual mice. The extraordinary enzymatic activity of exonucleases during the V(D)J recombination process can be deduced from the finding that 30-66 % of antibodies (in one case even 100 %) from all phases of immune maturation used HCDR3 sequences showing no relation to the respective germline DH genes.

Future work is necessary to elucidate the precise mechanism of T cell-mediated regulation of the thymus-dependent immune response.

5 References

1. Danilova, N., *The evolution of immune mechanisms*. J Exp Zoolog B Mol Dev Evol, 2006. **306**(6): p. 496-520.
2. Boman, H.G., *Peptide antibiotics and their role in innate immunity*. Annu Rev Immunol, 1995. **13**: p. 61-92.
3. Beck, G. and G.S. Habicht, *Immunity and the invertebrates*. Sci Am, 1996. **275**(5): p. 60-3, 66.
4. Vasselon, T. and P.A. Detmers, *Toll receptors: a central element in innate immune responses*. Infect Immun, 2002. **70**(3): p. 1033-41.
5. Larsen, G.L. and P.M. Henson, *Mediators of inflammation*. Annu Rev Immunol, 1983. **1**: p. 335-59.
6. Banchereau, J., et al., *Immunobiology of dendritic cells*. Annu Rev Immunol, 2000. **18**: p. 767-811.
7. Iwasaki, A., *Mucosal dendritic cells*. Annu Rev Immunol, 2007. **25**: p. 381-418.
8. Zhang, B., *Targeting the stroma by T cells to limit tumor growth*. Cancer Res, 2008. **68**(23): p. 9570-3.
9. Piersma, S.J., M.J. Welters, and S.H. van der Burg, *Tumor-specific regulatory T cells in cancer patients*. Hum Immunol, 2008. **69**(4-5): p. 241-9.
10. Berner, B., et al., *Analysis of Th1 and Th2 cytokines expressing CD4+ and CD8+ T cells in rheumatoid arthritis by flow cytometry*. J Rheumatol, 2000. **27**(5): p. 1128-35.
11. Kapp, J.A. and R.P. Bucy, *CD8+ suppressor T cells resurrected*. Hum Immunol, 2008. **69**(11): p. 715-20.
12. Kirkham, P.M. and H.W. Schroeder, Jr., *Antibody structure and the evolution of immunoglobulin V gene segments*. Semin Immunol, 1994. **6**(6): p. 347-60.
13. Tonegawa, S., *Somatic generation of antibody diversity*. Nature, 1983. **302**(5909): p. 575-81.
14. Lefranc, M.P., *IMGT, the international ImMunoGeneTics database*. Nucleic Acids Res, 2003. **31**(1): p. 307-10.
15. Yancopoulos, G.D. and F.W. Alt, *Regulation of the assembly and expression of variable-region genes*. Annu Rev Immunol, 1986. **4**: p. 339-68.
16. Blackwell, T.K. and F.W. Alt, *Mechanism and developmental program of immunoglobulin gene rearrangement in mammals*. Annu Rev Genet, 1989. **23**: p. 605-36.
17. Lewis, S.M., et al., *Cryptic signals and the fidelity of V(D)J joining*. Mol Cell Biol, 1997. **17**(6): p. 3125-36.

18. Wilson, P.C., et al., *Receptor revision of immunoglobulin heavy chain variable region genes in normal human B lymphocytes*. J Exp Med, 2000. **191**(11): p. 1881-94.
19. Johnston, C.M., et al., *Complete sequence assembly and characterization of the C57BL/6 mouse Ig heavy chain V region*. J Immunol, 2006. **176**(7): p. 4221-34.
20. Haines, B.B., et al., *Germline diversity of the expressed BALB/c VhJ558 gene family*. Mol Immunol, 2001. **38**(1): p. 9-18.
21. Chang, S. and C. Mohan, *Identification of novel VH1/J558 immunoglobulin germline genes of C57BL/6 (Igh b) allotype*. Mol Immunol, 2005. **42**(11): p. 1293-301.
22. Retter, I., et al., *Sequence and characterization of the Ig heavy chain constant and partial variable region of the mouse strain 129S1*. J Immunol, 2007. **179**(4): p. 2419-27.
23. Ichihara, Y., et al., *Only DFL16, DSP2, and DQ52 gene families exist in mouse immunoglobulin heavy chain diversity gene loci, of which DFL16 and DSP2 originate from the same primordial DH gene*. Eur J Immunol, 1989. **19**(10): p. 1849-54.
24. Ye, J., *The immunoglobulin IGHD gene locus in C57BL/6 mice*. Immunogenetics, 2004. **56**(6): p. 399-404.
25. Honjo, T., *Immunoglobulin genes*. Annu Rev Immunol, 1983. **1**: p. 499-528.
26. Early, P., et al., *An immunoglobulin heavy chain variable region gene is generated from three segments of DNA: VH, D and JH*. Cell, 1980. **19**(4): p. 981-92.
27. Padlan, E.A., *Anatomy of the antibody molecule*. Mol Immunol, 1994. **31**(3): p. 169-217.
28. Xu, J.L. and M.M. Davis, *Diversity in the CDR3 region of V(H) is sufficient for most antibody specificities*. Immunity, 2000. **13**(1): p. 37-45.
29. Schroeder, H.W., Jr., *Similarity and divergence in the development and expression of the mouse and human antibody repertoires*. Dev Comp Immunol, 2006. **30**(1-2): p. 119-35.
30. Kaartinen, M. and O. Makela, *Reading of D genes in variable frames as a source of antibody diversity*. Immunology Today, 1985. **6**(11): p. 324-327.
31. Shimizu, T. and H. Yamagishi, *Biased reading frames of pre-existing DH--JH coding joints and preferential nucleotide insertions at VH--DJH signal joints of excision products of immunoglobulin heavy chain gene rearrangements*. Embo J, 1992. **11**(13): p. 4869-75.
32. Martin, D.A., et al., *Selection of Ig mu heavy chains by complementarity-determining region 3 length and amino acid composition*. J Immunol, 2003. **171**(9): p. 4663-71.
33. Lipsanen, V., et al., *CDRH3 length is the target of selection of disease-associated IgM autoantibodies*. Ann N Y Acad Sci, 1997. **815**: p. 448-54.

34. Shiokawa, S., et al., *IgM heavy chain complementarity-determining region 3 diversity is constrained by genetic and somatic mechanisms until two months after birth*. J Immunol, 1999. **162**(10): p. 6060-70.
35. Schelonka, R.L., et al., *Categorical selection of the antibody repertoire in splenic B cells*. Eur J Immunol, 2007. **37**(4): p. 1010-21.
36. Souto-Carneiro, M.M., et al., *Developmental Changes in the Human Heavy Chain CDR3*. J Immunol, 2005. **175**(11): p. 7425-7436.
37. Xu, C., et al., *Gammadelta T cells recognize tumor cells via CDR3delta region*. Mol Immunol, 2007. **44**(4): p. 302-10.
38. Gilfillan, S., C. Benoist, and D. Mathis, *Mice lacking terminal deoxynucleotidyl transferase: adult mice with a fetal antigen receptor repertoire*. Immunol Rev, 1995. **148**: p. 201-19.
39. Feeney, A.J., *Junctional sequences of fetal T cell receptor beta chains have few N regions*. J Exp Med, 1991. **174**(1): p. 115-24.
40. Wang, Z., et al., *Targeting solid tumors via T cell receptor complementarity-determining region 3delta in an engineered antibody*. Cancer Lett, 2008. **272**(2): p. 242-52.
41. Agematsu, K., *Memory B cells and CD27*. Histol Histopathol, 2000. **15**(2): p. 573-6.
42. Zhang, M., G. Srivastava, and L. Lu, *The pre-B cell receptor and its function during B cell development*. Cell Mol Immunol, 2004. **1**(2): p. 89-94.
43. Cheng, S., et al., *BCR-mediated apoptosis associated with negative selection of immature B cells is selectively dependent on Pten*. Cell Res, 2009. **19**(2): p. 196-207.
44. Allman, D., B. Srivastava, and R.C. Lindsley, *Alternative routes to maturity: branch points and pathways for generating follicular and marginal zone B cells*. Immunol Rev, 2004. **197**: p. 147-60.
45. Stein, K.E., *Thymus-independent and thymus-dependent responses to polysaccharide antigens*. J Infect Dis, 1992. **165 Suppl 1**: p. S49-52.
46. Lange, H., et al., *Thymus-independent type 2 antigen induces a long-term IgG-related network memory*. Mol Immunol, 2008. **45**(10): p. 2847-60.
47. Radbruch, A., et al., *Competence and competition: the challenge of becoming a long-lived plasma cell*. Nat Rev Immunol, 2006. **6**(10): p. 741-50.
48. Liu, Y.J. and C. Arpin, *Germinal center development*. Immunol Rev, 1997. **156**: p. 111-26.
49. Poletaev, A.B., V.L. Stepanyuk, and M.E. Gershwin, *Integrating immunity: the immunculus and self-reactivity*. J Autoimmun, 2008. **30**(1-2): p. 68-73.
50. Jerne, N.K., *Recent advances in immunology*. Schweiz Rundsch Med Prax, 1974. **63**(50): p. 1493-4.

51. Coutinho, A., *The network theory: 21 years later*. Scand J Immunol, 1995. **42**(1): p. 3-8.
52. Lemke, H. and H. Lange, *Generalization of single immunological experiences by idiotypically mediated clonal connections*. Adv Immunol, 2002. **80**: p. 203-41.
53. Rademaekers, A., E. Kolsch, and C. Specht, *T cell mediated antibody invariance in an immune response against a bacterial carbohydrate antigen requires CD28/B7-1 costimulation*. Dev Immunol, 2001. **8**(3-4): p. 243-57.
54. Berek, C., G.M. Griffiths, and C. Milstein, *Molecular events during maturation of the immune response to oxazolone*. Nature, 1985. **316**(6027): p. 412-418.
55. Berek, C. and C. Milstein, *Mutation drift and repertoire shift in the maturation of the immune response*. Immunol Rev, 1987. **96**: p. 23-41.
56. Kaartinen, M., et al., *mRNA sequences define an unusually restricted IgG response to 2-phenyloxazolone and its early diversification*. Nature, 1983. **304**(5924): p. 320-324.
57. Bothwell, A.L.M., et al., *Heavy chain variable region contribution to the NPb family of antibodies: somatic mutation evident in a [gamma]2a variable region*. Cell, 1981. **24**(3): p. 625-637.
58. Casson, L.P. and T. Manser, *Evaluation of loss and change of specificity resulting from random mutagenesis of an antibody VH region*. J Immunol, 1995. **155**(12): p. 5647-54.
59. Wysocki, L.J., et al., *Single germline VH and V kappa genes encode predominating antibody variable regions elicited in strain A mice by immunization with p-azophenylarsonate*. J Exp Med, 1987. **166**(1): p. 1-11.
60. Bye, J.M., et al., *Germline variable region gene segment derivation of human monoclonal anti-Rh(D) antibodies. Evidence for affinity maturation by somatic hypermutation and repertoire shift*. J Clin Invest, 1992. **90**(6): p. 2481-90.
61. Adderson, E.E., P.G. Shackelford, and W.L. Carroll, *Somatic Hypermutation in T-Independent and T-Dependent Immune Responses to Haemophilus influenzae Type b Polysaccharide*. Clin Immunol Immunopathol, 1998. **89**(3): p. 240-246.
62. Lange, H. and H. Lemke, *Induction of a non-oscillating, long-lasting humoral immune response to an internal network antigen*. Int Immunol, 1996. **8**(5): p. 683-8.
63. Cumano, A. and K. Rajewsky, *Structure of primary anti-(4-hydroxy-3-nitrophenyl)acetyl (NP) antibodies in normal and idiotypically suppressed C57BL/6 mice*. Eur J Immunol, 1985. **15**(5): p. 512-20.
64. Cumano, A. and K. Rajewsky, *Clonal recruitment and somatic mutation in the generation of immunological memory to the hapten NP*. Embo J, 1986. **5**(10): p. 2459-68.
65. Parhami-Seren, B., et al., *Clustered H chain somatic mutations shared by anti-p-azophenylarsonate antibodies confer enhanced affinity and ablate the cross-reactive idiotypic*. J Immunol, 1990. **145**(7): p. 2340-6.

66. Schelonka, R.L., et al., *A single DH gene segment creates its own unique CDR-H3 repertoire and is sufficient for B cell development and immune function.* J Immunol, 2005. **175**(10): p. 6624-32.
67. Ippolito, G.C., et al., *Antibody repertoire in a mouse with a simplified D(H) locus: the D-limited mouse.* Ann N Y Acad Sci, 2003. **987**: p. 262-5.
68. Ippolito, G.C., et al., *Forced usage of positively charged amino acids in immunoglobulin CDR-H3 impairs B cell development and antibody production.* J Exp Med, 2006. **203**(6): p. 1567-78.
69. Mäkelä, O.M.K., J. L. T. Pelkonen, and K. Karjalainen, *Inheritance of antibody specificity V.* J. Exp. Men. , 1978. **148**: p. 1644-1660.
70. Kearney, J.F., et al., *A new mouse myeloma cell line that has lost immunoglobulin expression but permits the construction of antibody-secreting hybrid cell lines.* J Immunol, 1979. **123**(4): p. 1548-50.
71. Sambrook and Russell, *Molecular Cloning: A Laboratory Manual.* 3 ed. 2001: Cold Spring Harbor Laboratory Press.
72. Kyte, J. and R.F. Doolittle, *A simple method for displaying the hydropathic character of a protein.* J Mol Biol, 1982. **157**(1): p. 105-32.
73. Eisenberg, D., *Three-dimensional structure of membrane and surface proteins.* Annu Rev Biochem, 1984. **53**: p. 595-623.
74. Schelonka, R.L., et al., *Preferential use of DH reading frame 2 alters B cell development and antigen-specific antibody production.* J Immunol, 2008. **181**(12): p. 8409-15.
75. Zemlin, M., et al., *Regulation of repertoire development through genetic control of DH reading frame preference.* J Immunol, 2008. **181**(12): p. 8416-24.
76. Marcos, M.A., et al., *B cell participation in the recursive selection of T cell repertoires.* Eur J Immunol, 1988. **18**(7): p. 1015-20.
77. Martinez, C., et al., *Establishment of idiotypic helper T-cell repertoires early in life.* Nature, 1985. **317**(6039): p. 721-3.
78. Ngo, V.N., R.J. Cornall, and J.G. Cyster, *Splenic T zone development is B cell dependent.* J Exp Med, 2001. **194**(11): p. 1649-60.
79. Mastroeni, P., et al., *Igh-6(-/-) (B-cell-deficient) mice fail to mount solid acquired resistance to oral challenge with virulent Salmonella enterica serovar typhimurium and show impaired Th1 T-cell responses to Salmonella antigens.* Infect Immun, 2000. **68**(1): p. 46-53.
80. Yang, X. and R.C. Brunham, *Gene knockout B cell-deficient mice demonstrate that B cells play an important role in the initiation of T cell responses to Chlamydia trachomatis (mouse pneumonitis) lung infection.* J Immunol, 1998. **161**(3): p. 1439-46.

81. Lemke, H., H. Lange, and C. Berek, *Maternal immunization modulates the primary immune response to 2-phenyl-oxazolone in BALB/c mice*. Eur J Immunol, 1994. **24**(12): p. 3025-30.
82. Tuteja, R., *B-cell responses to a peptide epitope: mutations in heavy chain alone lead to maturation of antibody responses*. Immunology, 1999. **97**(1): p. 1-8.
83. van der Keyl, H., Z.F. Gellad, and J.A. Owen, *Disparity in the kinetics of onset of hypermutation in immunoglobulin heavy and light chains*. Immunol Cell Biol, 2000. **78**(3): p. 224-37.
84. de Wildt, R.M., et al., *Somatic insertions and deletions shape the human antibody repertoire*. J Mol Biol, 1999. **294**(3): p. 701-10.
85. Gilfillan, S., et al., *Efficient immune responses in mice lacking N-region diversity*. Eur J Immunol, 1995. **25**(11): p. 3115-22.
86. Gilfillan, S., et al., *Mice lacking TdT: mature animals with an immature lymphocyte repertoire*. Science, 1993. **261**(5125): p. 1175-8.
87. Mi, Q.S., et al., *The M603 idiotype is lost in the response to phosphocholine in terminal deoxynucleotidyl transferase-deficient mice*. Eur J Immunol, 2002. **32**(4): p. 1139-46.
88. Molano, I.D., et al., *Effect of a genetic deficiency of terminal deoxynucleotidyl transferase on autoantibody production by C57BL6 Fas(lpr) mice*. Clin Immunol, 2000. **94**(1): p. 24-32.
89. Weller, S., et al., *Autoantibodies in mice lacking terminal deoxynucleotidyl transferase: evidence for a role of N region addition in the polyreactivity and in the affinities of anti-DNA antibodies*. J Immunol, 1997. **159**(8): p. 3890-8.
90. Conde, C., et al., *Terminal deoxynucleotidyl transferase deficiency reduces the incidence of autoimmune nephritis in (New Zealand Black x New Zealand White)F1 mice*. J Immunol, 1998. **161**(12): p. 7023-30.
91. Pabst, R. and J. Westermann, *The role of the spleen in lymphocyte migration*. Scanning Microsc, 1991. **5**(4): p. 1075-9; discussion 1079-80.
92. Mejri, N. and M. Brossard, *Splenic dendritic cells pulsed with Ixodes ricinus tick saliva prime naive CD4+T to induce Th2 cell differentiation in vitro and in vivo*. Int Immunol, 2007. **19**(4): p. 535-43.
93. Milich, D.R., et al., *Role of B cells in antigen presentation of the hepatitis B core*. Proc Natl Acad Sci U S A, 1997. **94**(26): p. 14648-53.
94. Michael, L.D., *T-cell activation through immunological synapses and kinapses*. Immunological Reviews 2008. **221** (1): p. 77-89.
95. Paramithiotis, E. and M.D. Cooper, *Memory B lymphocytes migrate to bone marrow in humans*. Proc Natl Acad Sci U S A, 1997. **94**(1): p. 208-12.

96. Hoyer, B.F., et al., *How to cope with pathogenic long-lived plasma cells in autoimmune diseases*. *Ann Rheum Dis*, 2008. **67 Suppl 3**: p. iii87-9.
97. Slifka, M.K., J.K. Whitmire, and R. Ahmed, *Bone marrow contains virus-specific cytotoxic T lymphocytes*. *Blood*, 1997. **90**(5): p. 2103-8.
98. Di Rosa, F. and A. Santoni, *Memory T-cell competition for bone marrow seeding*. *Immunology*, 2003. **108**(3): p. 296-304.
99. Di Rosa, F. and R. Pabst, *The bone marrow: a nest for migratory memory T cells*. *Trends Immunol*, 2005. **26**(7): p. 360-6.
100. Driver, D.J., et al., *Development and maintenance of a B220- memory B cell compartment*. *J Immunol*, 2001. **167**(3): p. 1393-405.
101. Yamamoto, S., et al., *Precursor B-1 B cell lymphoma in a newborn calf*. *J Vet Diagn Invest*, 2007. **19**(4): p. 447-50.
102. Hardy, R.R., *B-1 B cells: development, selection, natural autoantibody and leukemia*. *Curr Opin Immunol*, 2006. **18**(5): p. 547-55.
103. Duan, B. and L. Morel, *Role of B-1a cells in autoimmunity*. *Autoimmun Rev*, 2006. **5**(6): p. 403-8.
104. Martin, F. and J.F. Kearney, *B-cell subsets and the mature preimmune repertoire. Marginal zone and B1 B cells as part of a "natural immune memory"*. *Immunol Rev*, 2000. **175**: p. 70-9.
105. Manz, R.A. and A. Radbruch, *Plasma cells for a lifetime?* *Eur J Immunol*, 2002. **32**(4): p. 923-7.
106. Hoyer, B.F., et al., *Short-lived plasmablasts and long-lived plasma cells contribute to chronic humoral autoimmunity in NZB/W mice*. *J Exp Med*, 2004. **199**(11): p. 1577-84.
107. Wrammert, J. and R. Ahmed, *Maintenance of serological memory*. *Biol Chem*, 2008. **389**(5): p. 537-9.
108. McHeyzer-Williams, L.J. and M.G. McHeyzer-Williams, *Antigen-specific memory B cell development*. *Annu Rev Immunol*, 2005. **23**: p. 487-513.
109. Lieberman, R., et al., *Genetics of a new IgVH (T15 idiotype) marker in the mouse regulating natural antibody to phosphorylcholine*. *J Exp Med*, 1974. **139**(4): p. 983-1001.
110. Pawlak, L.L., et al., *Evidence for the linkage of the IGC H locus to a gene controlling the idiotypic specificity of anti-p-azophenylarsonate antibodies in strain A mice*. *J Exp Med*, 1973. **137**(1): p. 22-31.
111. Imanishi, T. and O. Makela, *Inheritance of antibody specificity. I. Anti-(4-hydroxy-3-nitrophenyl)acetyl of the mouse primary response*. *J Exp Med*, 1974. **140**(6): p. 1498-510.

112. Scotti, C. and E. Gherardi, *Structural Basis of Affinity Maturation of the TEPIC15/V[κ]45.1 Anti-2-phenyl-5-oxazolone Antibodies*. J Mol Biol, 2006. **359**(5): p. 1161-1169.
113. Maizels, N. and A. Bothwell, *The T-cell-independent immune response to the hapten NP uses a large repertoire of heavy chain genes*. Cell, 1985. **43**(3 Pt 2): p. 715-20.
114. Maizels, N., et al., *The T-cell independent antigen, NP-ficoll, primes for a high affinity IgM anti-NP response*. Mol Immunol, 1988. **25**(12): p. 1277-82.
115. Woodland, R. and H. Cantor, *Idiotype-specific T helper cells are required to induce idiotype-positive B memory cells to secrete antibody*. Eur J Immunol, 1978. **8**(8): p. 600-6.
116. Hetzelberger, D. and K. Eichmann, *Recognition of idiotypes in lymphocyte interactions. I. Idiotypic selectivity in the cooperation between T and B lymphocytes*. Eur J Immunol, 1978. **8**(12): p. 846-52.
117. McNamara, M., K. Gleason, and H. Kohler, *T-cell helper circuits*. Immunol Rev, 1984. **79**: p. 87-102.
118. McNamara, M. and H. Kohler, *Regulatory idiotopes. Induction of idiotype-recognizing helper T cells by free light and heavy chains*. J Exp Med, 1984. **159**(2): p. 623-8.
119. Blier, P.R. and A. Bothwell, *A limited number of B cell lineages generates the heterogeneity of a secondary immune response*. J Immunol, 1987. **139**(12): p. 3996-4006.
120. Lange, H., et al., *Correlation between immune maturation and idiotypic network recognition*. Eur J Immunol, 1996. **26**(9): p. 2234-42.
121. Konforte, D., N. Simard, and C.J. Paige, *IL-21: an executor of B cell fate*. J Immunol, 2009. **182**(4): p. 1781-7.
122. Lindroth, K., et al., *Understanding thymus-independent antigen-induced reduction of thymus-dependent immune responses*. Immunology, 2004. **112**(3): p. 413-9.
123. Klonowski, K.D., L.L. Primiano, and M. Monestier, *Atypical VH-D-JH rearrangements in newborn autoimmune MRL mice*. J Immunol, 1999. **162**(3): p. 1566-72.
124. Link, J.M. and H.W. Schroeder, Jr., *Clues to the etiology of autoimmune diseases through analysis of immunoglobulin genes*. Arthritis Res, 2002. **4**(2): p. 80-3.
125. Tarlinton, D., et al., *DH element reading frame selection is influenced by an Ig heavy chain transgene, but not by bcl-2*. J Immunol, 1995. **154**(7): p. 3341-50.
126. Zanetti, M. and J.D. Capra, eds. *The Antibodies*. Vol. 7. 2007. 246.
127. Rahman, A., *Autoantibodies, lupus and the science of sabotage*. Rheumatology (Oxford), 2004. **43**(11): p. 1326-36.

128. Li, Z., et al., *Structure-function analysis of a lupus anti-DNA autoantibody: central role of the heavy chain complementarity-determining region 3 Arg in binding of double- and single-stranded DNA*. Eur J Immunol, 2000. **30**(7): p. 2015-26.
129. Schroeder, H.W., Jr., G.C. Ippolito, and S. Shiokawa, *Regulation of the antibody repertoire through control of HCDR3 diversity*. Vaccine, 1998. **16**(14-15): p. 1383-90.
130. Butler, J.E., et al., *Antibody repertoire development in fetal and neonatal piglets: XIX. Undiversified B cells with hydrophobic HCDR3s preferentially proliferate in the porcine reproductive and respiratory syndrome*. J Immunol, 2007. **178**(10): p. 6320-31.
131. Benson, M.J., et al., *Affinity of antigen encounter and other early B-cell signals determine B-cell fate*. Curr Opin Immunol, 2007. **19**(3): p. 275-80.
132. Kiefer, K., et al., *Antigen receptor editing in anti-DNA transitional B cells deficient for surface IgM*. J Immunol, 2008. **180**(9): p. 6094-106.
133. Kallenbach, S., et al., *Three lymphoid-specific factors account for all junctional diversity characteristic of somatic assembly of T-cell receptor and immunoglobulin genes*. Proc Natl Acad Sci U S A, 1992. **89**(7): p. 2799-803.
134. Koralov, S.B., et al., *Direct in vivo VH to JH rearrangement violating the 12/23 rule*. J Exp Med, 2005. **201**(3): p. 341-8.

6 Abbreviations

AA	Amino acid
Ab	Antibody
ABTS	2'-azinobis (3-ethylbenzthiazoline-6-sulfonic acid)
AEC	3-Amino-9-Ethylcarbazol
Ag	Antigen
APC	Antigen presenting cell
BCR	B-cell receptor
bp	Base pair
BSA	Bovine serum albumin
cDNA	Complementary DNA
CDR	Complementarily-determining region
CSA	Chicken serum albumin
DH	Diversity segment
DNA	Deoxyribonucleic acid
FITC	Fluoroisothiocyanate
H	Heavy chain
HRP	Horseradish peroxidase enzyme
i.p	Intraperitoneal
JH	Joining segment
kDa	Kilo Dalton
L	Light chain
MHC	Major histocompatibility
ORF	Open reading frame
PBS	Phosphate- buffered saline
PCR	Polymerase chain reaction
phOx	2-phenyloxazolone
RF	Reading frame
TCR	T-cell receptor
TD	Thymus-dependent
TdT	Terminal deoxynucleotidyltransferase
T _H	T helper cells
TI	Thymus-independent

UV	Ultraviolet
V	Variable domain
WT	Wildtype

7 Appendix

Figure 1

Amino acid sequences of VH/VL gene-encoded variable regions of TD antigen-induced anti-phOx antibodies in Δ D-D μ FS mice

(Legend see below)

Amino acid sequences of TD antigen-induced primary day 7 antibodies of Δ D-D μ FS mice

IGHV673	QVQLQ Q SGPE	LVKPGASVKI	SCKASG SSFT SY Y I HWVKQS	PGQGLEWIGW	I Y P G S G N T K Y	NEKFKGKATL	TADTSSSTAY	MQLSSLTSED	SAVYFCAR
01H 673	-----P-----	-----	-----R--N--R-----	-----+	-----F--S-----	-----	-----+	-----H-----E-----	-----
01L 121	-----	-----	-----	-----	-----	-----	-----	-----	-----
IGKV121	DIKMTQSPSS	MYASLG R VT	ITCKAS QDIN SY L S W F Q Q KP	GKSPKTLI Y R	A N R L V D G V P S	RFSGSGSGQD	YSLTIS S L E Y	EDMGIYYCLO	YDEF

IGHV671	EVQLQ Q SGTV	LARPGASVKM	SCKASG GYTFT SY W M HWVKQR	PGQGLEWIGA	I Y P G N S D T S Y	NQKFKGKAKL	TAVTSTSTAY	MELSSLT N ED	SAVYYCTR
02H 671	-----+-----	-----	-----S-----	-----+	-----+	-----	-----A-----	-----	-----+VI-----
02L 139	-----	-----	-----	-----	-----	-----	-----	-----+	-----
IGKV139	DIQMTQT T SS	LSASLGDRVT	I S C S A S QGIS NY L N W Y Q Q KP	DGTVKLLI Y Y	T S S L H S G V P S	RFSGSGSGTD	YSLTIS N L E P	EDIATYYCQO	YSKL

IGHV627	QVQLQ Q SGPE	LVKPGASVRI	SCKASG GYTFT SY Y I HWVKQR	PGQGLEWIGW	I Y P G N G N T K Y	NEKFKGKATL	TADKSSSTAY	MQLSSLTSED	SAVYFCAR
03H 627	-----+--T--LKM-----	-----	-----+ G-----	-----	-----D--S-----	-----T--	-----E--N--	-----L-----	-----I-----+
03L 072	-----	-----	-----H-----	-----	-----	-----	-----	-----	-----
IGKV072	QIVLTQSPAI	MSASPGEKVT	M T C S A S SSVS Y M H W Y Q Q KSG	TSPKRWI Y DT	S K L A S G V P A R	FSGSGSGTSY	SLTIS S M E A E	DAATYYCQ Q W	SSN

IGHV627	QVQLQ Q SGPE	LVKPGASVRI	SCKASG GYTFT SY Y I HWVKQR	PGQGLEWIGW	I Y P G N G N T K Y	NEKFKGKATL	TADKSSSTAY	MQLSSLTSED	SAVYFCAR
04H 627	-----	-----	-----	-----	-----V-----	-----	-----	-----F--F-----	-----
04L 139	-----	-----	-----	-----	-----	-----	-----	-----	-----
IGKV139	DIQMTQT T SS	LSASLGDRVT	I S C S A S QGIS NY L N W Y Q Q KP	DGTVKLLI Y Y	T S S L H S G V P S	RFSGSGSGTD	YSLTIS N L E P	EDIATYYCQO	YSKL

IGHV532	QVQLQQSGAE	LAKPGASVKM	SCKAS	GYFT SYW	MHWVKQR	PGQLEWIGY	INPSTGYT	EY	NQKFKDKATL	TADKSSSTAY	QQLSSLTSED	SAVYYCAR
05H 532	-----	-----	-----	-----	-----	-----	RI-NN	+	-----	-----	-----	-----
05L 078	-----	-----	-----	-----	-----	-----	-----	-----	-----	-----	-----	-----
IGKV078	ENVLTQSPAI	MSASPGEKVT	MTCRAS	SSVS SSY	LHWYQQK	SGASPKLWIY	STSN	LASGVP	ARFSGSGSGT	SYSLTISSVE	AEDAATYYCQ	QYSGY
IGHV506	EIQLQQSGPE	LVKPGASVKV	SCKAS	GYAFT SYM	MYWVKQS	HGKSLEWIGY	IDPYNGGT	SY	NQKFKGKATL	TIDKSSSTAY	MHLNSLTSED	SAVYYCAR
06H 506	--- K ---	--- M ---	--- I ---	--- S ---	--- T-Y-H ---	---	---	---	---	---	---	---
06L 121	-----	-----	-----	-----	-----	-----	C	-----	-----	-----	-----	-----
IGKV121	DIKMTQSPSS	MYASLGERVT	ITCKAS	QDIN SY	LSWFQOKP	GKSPKTLIY	R ANR	LVDGVPS	RFSGSGSGQD	YSLTISSLEY	EDMGIYYCLO	YDEF
IGHV396	EVQLQQSGPE	LEKPGASVKI	SCKAS	GYSTF GYM	MNVVKQS	NGKSLEWIGN	IDPYYGGT	SY	NQKFKGKATL	TVDKSSSTAY	MQLKSLTSED	SAVYYC
07H 396	-----	-----	-----	-----	-----	-----	-----	-----	-----	-----	-----	-----
07L 201	-----	--- I-R ---	-----	-----	-----	-----	-----	-----	-----	-----	-----	-----
IGKV201	DIVMTQSQKF	MSTSVGDRVS	VTCKAS	QNVG TM	VAWYQQKP	GQSPKALIY	S AS	RYSGVPD	RFTGSGSGTD	FTLTISNVQS	EDLAEYFCQQ	YNSY
IGHV386	QVQLQQSGAE	LMKPGASVKI	SCKAT	GYTFS SYW	LEWVKQR	PGHGLEWIGE	ILPSSGST	NY	NEKFKGKATF	TADTSSNTAY	QQLSSLTSED	SAVYYC
08H 386	-----	--- +T ---	-----	-----	---	---	---	---	---	---	---	---
08L 112	-----	-----	---	---	---	---	---	---	---	---	---	---
IGKV112	DIQMTQSPSS	LSASLGERVS	LTCRAS	QDIG SSL	NWLQQEP	DGTIKRLIY	A TS	SLDSGVPK	RFSGSRSGSD	YSLTISSLES	EDFVDYYCLO	YASS
IGHV117	SQMQLQESGP	GLVKPSQSLF	LACSIT	GFPI TSGYY	WIWIR	QSPGKPLEWM	GYTHSGET	F	YNPSLQSPIS	ITRETSKNQF	FLQLNSVTTE	DTAMYYCAG
10H 117	-----	-----	-----	-----	-----	-----	-----	-----	-----	-----	-----	-----
10L 121	-----	-----	-----	-----	-----	-----	-----	-----	-----	-----	-----	-----
IGKV121	DIKMTQSPSS	MYASLGERVT	ITCKAS	QDIN SY	LSWFQOKP	GKSPKTLIY	R ANR	LVDGVPS	RFSGSGSGQD	YSLTISSLEY	EDMGIYYCLO	YDEF
IGHV138	SDVQLQESGP	DLVKPSQSLS	LTCTVT	GYSI TSGYS	MHWIR	QFPGNKLEWM	GYTHSGST	N	YNPSLKSRI	ITRDTSKNQF	FLQLNSVTTE	DTATYYCAR
11H 138	-----	-----	-----	-----	-----	-----	-----	-----	-----	-----	-----	-----
11L 163	-----	-----	-----	-----	-----	-----	-----	-----	-----	-----	-----	-----
IGKV163	ENVLTQSPAI	MAASLGQKVT	MTCRAS	SSVS SSY	LHWYQQK	SGASPKPLIH	RTSN	LASGVP	ARFSGSGSGT	SYSLTISSVE	AEDDATYYCQ	QWSGY

IGHV138	SDVQLQESGP	DLVKPSQSLS	LTCTVT	GYSI TSGYS	WHWIR	QFPGNKLEWM	GY THYSGST	YNPSLKSRIS	ITRDTSKNQF	FLQLNSVTTE	DTATYYCAR
12H 138	-----	-----	-----	-----	-----	-----	-----	-----	-----	-----	-----L
12L 175	-----	-----	-----	-----	-----	-----	-----	-----	-----	-----	-----
IGKV175	DIVMTQSHKF	MSTSVGDRVS	ITCKAS	QDVG TAV	AWAYQQKP	GQSPKLLIYW	AST	RHTGVPD	RFTGSGSGTD	FTLTISNVQS	EDLADYFCQQ YSSY
IGHV120	SDVQLQESGP	GLVKPSQSLS	LTCSVT	GYSI TSGYY	WNWIR	QFPGNKLEWM	GY ISYDGS	YNPSLKNRIS	ITRDTSKNQF	FLKLNSVTTE	DTATYYCAR
14H 120	-----	-----	-----	-----	-----	-----	-----	-----	-----	-----	-----
14L 066	-----	-----	-----	-----	-----	-----	-----	-----	-----	-----	-----
IGKV066	DIVLTQSPAS	LAVSLGQRAT	ISCRAS	QSVS TSSYS	MHWY	QOKPGOPPCL	LIKY AS	NLES	GVPARFSGSG	SGTDFTLNIH	PVEEEDTATY YCOHSWEI
IGHV114	EVKLEESGGG	LVQPGGSMKL	SCVAS	GFTFS NYW	MNWVRQS	PEKGLEWVAE	IRLKSNNYAT	HYAESVKGRF	TISRDDSKSS	VYLQMNLR	EDTGIYYCTR
15H 114	-----	-----	-----	-----	-----	-----	-----	-----	-----	-----	-----AG
15L 106	-----	-----	-----	-----	-----	-----	-----	-----	-----	-----	-----
IGKV106	DIKMTQSPSS	MYASLGERVT	ITCKAS	QDIK SYL	SWYQQKP	WKSPKTLIYW	AT	SLADGVPS	RFSGSGSQD	YSLTISSLES	DDTATYYCLQ HGES
IGHV155	QIQLVQSGPE	LKKPGETVKI	SCKAS	GYTFT NYG	MNVVKQA	PGKGLKWMGW	INTNTGEP	TY AEEFKGRFAF	SLETSASTAY	LQINNLIKNE	TATYFCAR
16H 155	-----	-----	-----	-----	-----	-----	-----	-----	-----	-----	-----
16L 122	-----	-----	-----	-----	-----	-----	-----	-----	-----	-----	-----
IGKV122	DVVMTQTPLS	LPVSLGDQAS	ISCRSS	QSLV HSN	GNLYLHW	YLQKPGQSPK	LLIY KV	SNRF	SGVPDRFSGS	SGTDFTLKI	SRVEAEDLGV YFCSQSTHV
IGHV690	EIQLQQTGPE	LVKPGASVKI	SCKAS	GYSFT DYI	MLWVKQS	HGKSLEWIGN	INPYYGST	SY NQKFKGKATL	TADKSSSTAY	MQLSSLTSED	SAVYYCAR
19H 690	-----	-----	-----	-----	-----	-----	-----	-----	-----	-----	-----S
19L 210	-----	-----	-----	-----	-----	-----	-----	-----	-----	-----	-----
IGKV210	DIVLTQSPAS	LAVSLGQRAT	ISCRAS	ESVD NYG	ISFMNWF	QOKPGOPPCL	LIY AAS	NOGS	GVPARFSGSG	SGTDFSLNIH	PMEEDDTAMY FCQOSKEV
IGHV690	EIQLQQTGPE	LVKPGASVKI	SCKAS	GYSFT DYI	MLWVKQS	HGKSLEWIGN	INPYYGST	SY NQKFKGKATL	TADKSSSTAY	MQLSSLTSED	SAVYYCAR
20H 690	-----	-----	-----	-----	-----	-----	-----	-----	-----	-----	-----V
20L 123	-----	-----	-----	-----	-----	-----	-----	-----	-----	-----	-----
IGKV123	DIVMTQAAFS	NPVTLGTSAS	ISCRSS	KSL L HSN	GITYLYW	YLQKPGQSPQ	LLIY QMS	NLA	SGVPDRFSSS	SGTDFTLRI	SRVEAEDVGV YYCAQNL

IGHV643	EIQLQQSGPE	LVKPGASVKI	SCKAS	GYSFT GY	IMHWMKQS	HGKCLEWIGY	ISCYIGATS	SY	NQKFKGKAIF	TVDKSSSTAY	MQFNSLTFED	SAVYYCAR
21H 643	-----+---	+--T-----	-----	-----+Y--V--	-----	-----S-----	-----N-----	-----	-----+--T-	-----T-----	-----S+	-----
21L 210	-----	-----	-----	-----	-----	-----	-----	-----	-----	-----	-----	-----
IGKV210	DIVLTQSPAS	LAVSLGQRAT	ISCRASE	SVD NYGISF	MNWF	QOKPGQPPKL	LIY AASN	NOGS	GVPARFSGSG	SGTDFSLNIH	PMEEDDTAMY	FCQOSKEV
IGHV532	QVQLQQSGAE	LAKPGASVKM	SCKASG	YTFT SYW	MHWVKQR	PGQGLEWIGY	INPSTGYTE	EY	NQKFKDKATL	TADKSSSTAY	MLSSLTSED	SAVYYCAR
22H 532	-----	-----	-----	-----	-----	-----	-----	-----	-----	-----	-----F--	F-----N
22L 077	-----	-----	-----	-----	-----	-----R-----	-----	-----	-----	-----	-----+	-----
IGKV077	QIVLTQSPAI	MSASPGEKVT	ISCSAS	SSVS YMYWY	QOKPG	SSPKPWIYR	SN	LASGVPAR	FSGSGSGTSY	SLTISSMEAE	DAATYYCQOY	HSY
IGHV171	QVQLKESGPG	LVAPSQSLSI	TCTVSG	FSLT SYG	VHWVRQP	PGKGLEWLGV	IWAGGST	NYN	SALMSRLSIS	KDNSKSQVFL	KMNSLQTTDDT	AMYICAR
24H 171	-----Q-----	-----	-----	-----	-----	-----	-----	-----	-----	-----	-----	-----
24L 072	-----	-----	-----	-----	-----	-----	-----	-----	-----	-----	-----	-----
IGKV072	QIVLTQSPAI	MSASPGEKVT	MTCSAS	SSVS YMHWY	QOKSG	TSPKRWIYD	SK	LASGVPAR	FSGSGSGTSY	SLTISSMEAE	DAATYYCQOW	SSN
IGHV128	EVQLQESGPS	LVKPSQTLISL	TCSVT	GDSIT SG	WNWIRKF	PGNKLEYMGY	ISYSGST	YYN	PSLKSRLSIS	RDTSKNQYYL	QLNSVTTEDT	ATYYCAR
26H 128	-----+---	-----	-----	-----	-----	-----	-----F--R--I--	-----	-----	-----	-----	-----
26L 143	-----G-----	-S-----	-K-----R	-----R-----	-----VF--H--	-----C--L	-----	-----	-----	-----	-----	-----
IGKV143	EILLTQSPAI	IAASPGEKVT	ITCSAS	SSVS YMNWY	QOKPG	SSPKIWIYGI	SN	LASGVPAR	FSGSGSGTSF	SFTINSMEAE	DVATYYCQQR	SSY
IGHV163	DVKLVESGGG	LVKLGGSLLK	SCAAS	GFTFS SY	MSWVRQT	PEKRLELVAA	INSNGGST	YY	PDTVKGRFTI	SRDNAKNTLY	LQMSSLKSED	TALYYCAR
27H 163	-----+---	-----	-----	-----	-----	-----	-----	-----	-----	-----	-----	-----S
27L 072	-----	-----	-----	-----T--Q--	-----	-----	-----	-----	-----	-----	-----	-----
IGKV072	QIVLTQSPAI	MSASPGEKVT	MTCSAS	SSVS YMHWY	QOKSG	TSPKRWIYD	SK	LASGVPAR	FSGSGSGTSY	SLTISSMEAE	DAATYYCQOW	SSN
IGHV163	DVKLVESGGG	LVKLGGSLLK	SCAAS	GFTFS SY	MSWVRQT	PEKRLELVAA	INSNGGST	YY	PDTVKGRFTI	SRDNAKNTLY	LQMSSLKSED	TALYYCAR
28H 163	-----+---	-----	-----	-----	-----	-----	-----	-----	-----	-----	-----	-----G-----
28L 168	-----	-----	-----	-----	-----	-----	-----	-----	-----	-----+	-----	-----T-----
IGKV168	DILLTQSPAI	LSVSPGERVS	FSCRAS	QSIG TS	IHWYQRT	NGSPRLLIK	AS	SISGIPS	RFSGSGSGTD	FTLSINSVES	EDIADYYCQO	SNSW

IGKV154 QIVLTQSPAI MSASLGERVT MTCTASS**SSVS SSY**LHWYQOK PGSSPKLWIY **STS**NLASGVP ARFSGSGSGT SYSLTISSME AEDAATYYCH QYHRS
 17L 154 -----

IGKV121 DIKMTQSPSS MYASLGERVT ITCKAS**QDIN SY**LSWFQOKP GKSPKTLIY**R AN**RLVDGVPS RFSGSGSGQD YSLTISSLEY EDMGIYYCLQ YDEF
 18L 121 -----

IGKV078 ENVLTQSPAI MSASPGEKVT MTCRAS**SSVS SSY**LHWYQOK SGASPKLWIY **STS**NLASGVP ARFSGSGSGT SYSLTISSVE AEDAATYYCQ QYSGY
 23L 078 -----

IGHV125 EVQLQQSGAE LVKPGASVKL SCTAS**GFNIK DTY**MHWVKQR PEQGLEWIGR **IDPANGTKY** DPKFQ GKATI TADTSSNTAY LQLSSLTSED TAVYYCAR
 32H 125 ----- **F** ----- **VP**

IGKV072 QIVLTQSPAI MSASPGEKVT MTCSAS**SSVS Y**MHWYQOKSG TSPKRWIY**DT S**KLASGVPAR FSGSGSGTSY SLTISSMEAE DAATYYCQOW SSN
 34L 072 ----- **H** -----

Amino acid sequences of TD antigen-induced primary day 14 antibodies of Δ D-D μ FS mice

IGHV569	QVQLQQSGAE	LMKPGSSVKL	SCKAT	GYTFT GY	WIEWVKQR	PGHGLEWIGE	ILPSSGST	NY	NEKFKGKATF	TADTSSNTAY	MQLSSLTSED	SAVYYCAR			
01H 569	-----	-----	-----	S S	-----	-----	-----	-----	-----	-----	-----	-----			
01L 077	-----	-----	-----	-----	-----	-----	-----	-----	-----	-----	-----	-----			
IGKV077	QIVLTQSPAI	MSASPGEKVT	I	SSVS	YMYWYQQKPG	SSPKPWIY	RT	SN	LASGVPAR	FSGSGSGTSY	SLTISSMEAE	DAATYYCQQY HSY			
IGHV532	QVQLQQSGAE	LAKPGASVKM	SCKAS	GYTFT SYW	MHWVKQR	PGQGLEWIGY	INPSTGYT	EY	NQKFKDKATL	TADKSSSTAY	MQLSSLTSED	SAVYYCAR			
02H 532	-----	-----	-N-	-----	-----	-----	-----	-----	-----	-----	-----	-----			
02L 097	-----	-----	T	-----	-----	-----	-----	-----	-----	-----	-----	-----			
IGKV097	DVVMTQTPLT	LSVTIGQPAS	I	QSL	DSDGKTY	LNW	LLQRP	QSPK	RLIY	LVSK	LD	SGVPDRFTGS	GGTDFTLKI	SRVEAEDLGV	YYCWQGTHF
IGHV495	QVQLQQSGAE	LARPGASVKM	SCKAS	GYTFT SYW	MHWVKQR	PGQGLEWIGA	IYPGDGDT	RY	TQKFKGRATL	TADKSSSTAY	MQLSSLTSED	SAVYYCAT			
03H 495	-----	-----	-----	-----	-----	-----	-----	-----	T-K	N	A	R			
03L 166	-----	-----	-----	-----	-----	-----	-----	-----	-----	-----	-----	-----			
IGKV166	ENVLTQSPAI	MSASLGEKVT	M	SSVN	YMYWYQQKSD	ASP	KLWII	YT	SN	LAPGVPAR	FSGSGSGNSY	SLTISSMEGE	DAATYYCQQF	TSS	
IGHV286	EFQLQQSGPE	LVKPGASVKM	SCKAS	GYTFT SYV	MHWVKQR	PGQGLEWIGY	IYPYNDGT	KY	NEKFKGKATL	TSDKSSSTAY	MELSSLTSED	SAVYYCAR			
04H 286	-----	-----	-----	-----	-----	-----	N	-----	-----	-----	-----	-----			
04L 166	-----	-----	-----	-----	-----	-----	-----	-----	-----	-----	-----	-----			
IGKV166	ENVLTQSPAI	MSASLGEKVT	M	SSVN	YMYWYQQKSD	ASP	KLWII	YT	SN	LAPGVPAR	FSGSGSGNSY	SLTISSMEGE	DAATYYCQQF	TSS	
IGHV073	QVQLQQSGAE	LVKTGASVKM	SCKAS	GYTFT SYT	MHWVKQR	PGQGLEWIGY	INPSSGYT	NY	NQKFKDKATL	TADKSSSTAY	MQLSSLTSED	SAVYYCAR			
05H 073	-----	-----	-----	-----	-----	-----	-----	-----	M M	S	I +	-----			
05L 129	-----	-----	-----	N	-----	-----	Q	-----	-----	S	-----	-----			
IGKV129	DIQMNQSPSS	LSASLGDTIT	I	QNIN	VWLSWYQQK	PG	GNIP	KLII	K	AS	NLHTGVPS	RFSGSGSGTG	FTLTISSLQP	EDIATYYCQQ	GQSY

IGHV147	EVMLVESGGG	LVKPGGSLKL	SCAAS	GFTFS SYAM	SWVRQT	PEKRLEWVAT	ISSGGSYTY	MY	PDSVKGRFTI	SRDNAKNTLY	LQMSSLRSED	TAMYYCAR	
06H 147	-----	-----	-----	-----	-----	-----	-----	-----	-----	-----	-----	-----	
06L 179	-----	-----	-----	-----	-----	-----	-----	-----	-----	-----	-----	-----	
IGKV179	DIVMTQSPAT	LSVTPGDRVS	LSCRAS	QSIS DY	LHWYQOKS	HESPRLLIKY	AS	QSISGIPS	RFSGSGSGSD	FTLSINSVEP	EDVGVYYCQN	GHSF	
IGHV155	QIQLVQSGPE	LKKPGETVKI	SCKAS	GYTFT NYG	MNVVKQA	PGKGLKWMGW	INTNTGEP	TY	AEEFKGRFAF	SLETSASTAY	LQINNLKNE	TATYFCAR	
07H 155	-----	-----	-----	-----	-----	-----	-----	-----	-----	-----	-----	-----	
07L 082	-----	-----	-----	-----	-----	-----	-----	-----	-----	-----	-----	-----	
IGKV082	QIVLTQSPAI	MSASPGEKVT	ITCSAS	SSVS Y	MHWFOQKPG	TSPKLWIY	ST	SNLASGVPAR	FSGSGSGTSY	SLTISRMEAE	DAATYYCQR	SSY	
IGHV118	QIQLVQSGPE	LKKPGETVRI	SCKAS	GYTFT TAG	MQWVQKM	PGKGLKWIGW	INTHSGV	PKY	AEDFKGRFAF	SLETSASTAY	LQISNLKNE	TATYFCAR	
08H 118	-----	-----	-----	-----	-----	-----	-----	-----	-----	-----	-----	-----	
08L 097	-----	-----	-----	-----	-----	-----	-----	-----	-----	-----	-----	-----	
IGKV097	DVVMTQTPLT	LSVTIGQPAS	ISCKSS	QSLD DSDGKTY	LNW	LLQRPQSPK	RLIY	LVS	KLD	SGVPDRFTGS	GSPTDFTLKI	SRVEAEDLGV	YYCWQGTHF
IGHV480	EVQLQQSGPE	LVKPGASVKI	SCKAS	GYSFT GYY	MHWVKQS	HVKSLEWIGR	INPYNGAT	SY	NQNFKDKASL	TVDKSSSTAY	MELHSLTSED	SAVYYCAR	
10H 480	-----	-----	-----	-----	-----	-----	-----	-----	-----	-----	-----	-----	
10L 115	-----	-----	-----	-----	-----	-----	-----	-----	-----	-----	-----	-----	
IGKV115	DVLMTQTPLS	LPVSLGDQAS	ISCRSS	QSIV HSN	GNTYLEW	YLQKPGQSPK	LLIY	KVS	NRF	SGVPDRFSGS	GSPTDFTLKI	SRVEAEDLGV	YYCFQGSVH
IGHV171	QVQLKESGPG	LVAPSQSLSI	TCTVSS	GFSLT SYG	MHWVRQP	PGKGLEWLGV	IWAGGST	NYN	SALMSRLSIS	KDNSKSQVFL	KMNSLQTD	AMYYCAR	
11H 171	-----	-----	-----	-----	-----	-----	-----	-----	-----	-----	-----	-----	
11L 142	-----	-----	-----	-----	-----	-----	-----	-----	-----	-----	-----	-----	
IGKV142	EIVLTQSPPT	MAASPGEKIT	ITCSAS	SSIS S	NYLHWYQOK	PGFSPKLLIY	RTS	NLASGVP	ARFSGSGSGT	SYSLTIGTME	AEDVATYYCQ	QGSSI	
IGHV139	DVQLVESGGG	LVQPGGSRKL	SCAAS	GFTFS SFG	MHWVRQA	PEKGLEWVAY	ISSGSSIT	IYY	ADTVKGRFTI	SRDNPKNLTF	LQMTSLRSED	TAMYYCAR	
13H 139	XXXXXXXXXX	XXXXXXXXXX	-----	-----	-----	-----	-----	-----	-----	-----	-----	-----	
13L 103	-----	-----	-----	-----	-----	-----	-----	-----	-----	-----	-----	-----	
IGKV103	DIQMTQSPSS	LSASLGERVS	LTCRAS	QDIH GY	NLWFQOKP	GETIKHLIYE	TS	NLDGVPK	RFSGSRSGSD	YSLIIGSLES	EDFADYYCLO	YASS	

IGHV168 VKLVESGGG LVQPGGSLRL SCATS**GFTFS DFY**MEWVRQP PGKRLEWIAA **SRNKANDYTT** EYSASVKGRF IVSRDTSQSI LYLQMNALRA EDTAIYYCAR
 14H 168 ----- +----- IG----- I----- D----- S----- S-----
 14L 115 ----- T----- +T----- R----- I-----
 IGKV115 DVLMTQTPLS LPVSLGDQAS ISCRSS**QSIV HSNQNTY**LEW YLQKPGQSPK LLIY**KVS**NRF SGVPDRFSGS GSGTDFTLKI SRVEAEDLGV YYCFQGS HV

IGHV125 EVQLQQSGAE LVKPGASVKL SCTAS**GFNIK DTY**MHWVKQR PEQGLEWIGR **IDPANGNTKY** DPKFQKATI TADTSSNTAY LQLSSLTSED TAVYYCAR
 16H 125 ----- F----- DI-----
 16L 172 ----- V----- S-----
 IGKV172 DIQMTQSPAS LSASVGETVT ITCRAS**ENIY SY**LAWYQQKQ GKSPQLLVY**N AK**LAEGVPS RFGSGSGTQ FSLKINSLQP EDFGSYYCQH H YGT

IGKV166 ENVLTQSPAI MSASLGEKVT MSCRAS**SSVN Y**MYWYQQKSD ASPKLWIY**YT S**NLAPGVPAR FSGSGSGNSY SLTISSMEGE DAATYYCQOF TSS
 09L 166 -----

IGHV192 EVQLVESGGD LVKPGGSLKL SCAAS**GFTFS SY**GMSWVRQT PDKRLEWVAT **ISSGGSYTY** PDSVKGRFTI SRDNAKNTLY LQMSSLKSED TAMYYCAR
 12H 192 ----- +----- L----- +-----

IGHV158 EVKLVESGGG LVQPGGSLRL SCATS**GFTFT DYY**MSWVRQP PGKALEWLGF **IRNKANGYTT** EYSASVKGRF TISRDNDSQSI LYLQMNTLRA EDSATYYCAR
 15H 158 ----- +----- E----- S----- A----- R----- V----- +-----

Amino acid sequences of TD antigen-induced secondary antibodies of ΔD-D_μFS mice

IGHV623	EQIQQSGPE	LVKPGASVKM	SCKAS	GYTFT DYY	MHWVKQS	HGKSLEWIRR	VNPNNGGTS	Y	NQKFKDKATL	TVEKSSITAY	MELRSLTSED	SAVYYCAR
01H 623	-----	-----	-----	-S- G-	-----	-----G-	-----	-----	-----G-I+	---D-+-S---	---+-----	-+-----
01L 115	-----	-----	-----	-----	-----	-----	-----	-----	-----	-----	-----	-----
IGKV115	DVLMTQTPLS	LPVSLGDQAS	ISCRSS	QSIV HSNNGNTY	LEW	YLQKPGQSPK	LLIY KVSN	RNF	SGVPDRFSGS	GGTDFTLKI	SRVEAEDLGV	YY CFQ GS HV
IGHV171	QVQLKESGPG	LVAPSQSLSI	TCTVSG	FSLT SYG	VHWVRQP	PGKGLEWLGV	IWAGGST	NYN	SALMSRLSIS	KDNSKSQVFL	KMNSLQTTDDT	AMYYCAR
05H 171	---E---	-----	-----	-----	R	-----	-----	T	-----	-----	-----	-----
05L 072	---T---	-----	-----	-----	-----	-----	-----	-----	-----	-----	-----C	-----
06H 171	---E---	-----	-----	-----	N	-----	-----	T-I	-----R	-----	-----A	-----
06L 072	-----	-----	-----	-----	IN-E	-----	-----	P	-----	-----	-----C	-T-----
07H 171	-----	-----	-----	-----	T-AI	-----	-----	T	-----	+++	-----R	-----
07L 072	-----	-----	-----	-----	+N	N-E	-----	-----	F	-----	-----C	-----
IGKV072	QIVLTQSPAI	MSASPGEKVT	MTCSSA	SSVS Y	MHWYQQKSG	TSPKRWIY	DT SK	KLASGVPAR	FSGSGSGTSY	SLTISSMEAE	DAATYY CQ QW	SSN
IGHV171	QVQLKESGPG	LVAPSQSLSI	TCTVSG	FSLT SYG	VHWVRQP	PGKGLEWLGV	IWAGGST	NYN	SALMSRLSIS	KDNSKSQVFL	KMNSLQTTDDT	AMYYCAR
08H 171	-----	-----	-----	-----	+	-----	-----	-----	+++	+++	-----	-----
08L 137	-----	-----	-----	-----	F	-----	-----	++	-----N	-----D	-----	-----
IGKV137	DIQMTQTSS	LSASLGDRVT	ISCRAS	QDIS NY	LNWYQQKP	DGTVKLLIY	YS	RLHSGVPS	RFSGSGSGTD	YSLTISNLEQ	EDIATY FC QQ	GNTL
IGHV162	QVQLKESGPD	LVAPSQSLSI	TCTVSG	FSLT SYG	VHWVRQP	PGKGLEWLTV	IWSDGST	NYN	SALKSRLSIS	KDNSKSQVFL	KMNSLQTTDDT	AMYYCAR
09H 162	-----	-----	-----	-----	L+ T	N-G+	-----	+	-----I	S-L+--+R	R-----+	-----S
09L 115	-----	-----	-----	-----	-----	+++	F+	-----	-----	-----	T-A	-----
IGKV115	DVLMTQTPLS	LPVSLGDQAS	ISCRSS	QSIV HSNNGNTY	LEW	YLQKPGQSPK	LLIY KVSN	RNF	SGVPDRFSGS	GGTDFTLKI	SRVEAEDLGV	YY CFQ GS HV
IGHV158	EVKLVESGGG	LVQPGGSLRL	SCATS	GFTFT DYY	MSWVRQP	PGKALEWLG	IRNKANGYTT		EYSASVKGRF	TISRDNQSQSI	LYLQMNTRLRA	EDSATYYCAR
10H 158	---E---	---+---	-----	-----	T	-----	+++A	-----	-----K-R-YA	D-T	-----	---+---+---

10L 115 -----+-----**N**-----**T**-----
 IGKV115 DVLMTQTPLS LPVSLGDQAS ISCRSS**QSIV HSNGNIT**LEW YLQKPGQSPK LLIY**KVSNRF** SGVPDRFSGS GSGTDFTLKI SRVEAEDLGV YY**CFQ**SHV

IGHV125 EVQLQQSGAE LVKPGASVKL SCTAS**GFNIK DTY**MHWVKQR PEQGLEWIGR **IDPANGNT**KY DPKFQ GKATI TADTSSNTAY LQLSSLTSED TAVYY**CAR**
 11H 125 -----**S**-----**N**+-----**V**-----
 11L 137 -----**Y**-----**T**-----**R**-----**N**-----**C**-----
 IGKV137 DIQMTQTSS LSASLGDRVT ISCRAS**QDIS NY**LNWYQQKP DGTVKLLIY**TS**RLHSGVPS RFSGSGSGTD YSLTISNLEQ EDIATY**FCQ** GNTL

IGHV591 QAYLQQSGAE LVRSGASVKM SCKAS**GYTFT SYN**MHWVKQT PGQGLEWIGY **IYPNGGT**NY NQKFKGKATL TADTSSSTAY MQISSLTSED SAVY**FCAR**
 02H 591 -----**S**-----**N**+-----**V**-----

IGKV097 DVVMTQTPLT LSVTIGQPAS ISCKSS**QSLD DSDGKTY**LNW LLQRPQSPK RLIY**LVS**KLD SGVPDRFTGS GSGTDFTLKI SRVEAEDLGV YY**CWQ**GTHF
 03L 097 -----**S**-----**N**+-----**V**-----

IGKV121 DIKMTQSPSS MYASLGERVT ITCKAS**QDIN SY**LSWFQQKP GKSPKTLIY**R AN**RLVDGVPS RFSGSGSGQD YSLTISSLEY EDMGIYY**CLQ** YDEF
 04L 121 -----**S**-----**N**+-----**V**-----

IGKV202 DIVMTQSQKF MSTSVGDRVS ITCKAS**QNRV TAV**AWYQQKP GQSPKALIY**L AS**NRHTGVPD RFTGSGSGTD FTLTISNVQS EDLADY**FCLQ** HWNY
 12L 202 -----**P**-----**N**+-----**V**-----

Amino acid sequences of TD antigen-induced tertiary antibodies of ΔD-D_μFS mice

IGHV627	QVQLQQSGPE	LVKPGASVRI	SCKAS	GYTFT	SY IHWVKQR	PGQGLEWIGW	IYPGNGNT KY	NEKFKGKATL	TADKSSSTAY	QQLSSLTSED	SAVYFCAR
01H 627	-----	-----	-----	-----	-----	-----	----- V -----	-----	-----	-----	----- S -----
01L 096	-----	-----	-----	-----	-----	-----	-----	-----	-----	-----	-----
IGKV096	DIVMTQAAPS	VPVTPGESVS	ISCRSS	KSL L	HSNGNTY LYW	FLQRPQSPQ	LLIY RMS NLA	SGVPDRFSGS	GGTAF T LRI	SRVEAEDVGV	YYCMQHLEY
IGHV286	EFQLQQSGPE	LVKPGASVKM	SCKAS	GYTFT	SYV MHWVKQK	PGQGLEWIGY	IYPYNDGT KY	NEKFKGKATL	TSKSSSTAY	MELSSLTSED	SAVYYCAR
03H 286	-----	-----	-----	-----	-----	-----	----- N -----	-----	-----	-----	-----
03L 112	-----	-----	-----	-----	----- H -----	-----	-----	-----	-----	-----	-----
IGKV112	DIQMTQSPSS	LSASLGERVS	LTCRAS	QDIG	SS LNWLQOEP	DGTIKRLIYA	TS SLDSGVPK	RFSGSRSGSD	YSLTISSLES	EDFVDYYCLO	YASS
IGHV171	QVQLKESGPG	LVAPSQSLSI	TCTVSS	GFSLT	SYG VHWVRQP	PGKGLEWLGV	IWAGGST NYN	SALMSRLSIS	KDNSKSQVFL	KMNSLQTD D T	AMYYCAR
04H 171	-----	-----	-----	-----	-----	-----	-----	-----	-----	----- + -----	-----
04L 137	-----	-----	-----	-----	----- F -----	-----	----- Q -----	-----	-----	----- A -----	-----
IGKV137	DIQMTQTTSS	LSASLGDRVT	ISCRAS	QDIS	NY LNWYQQKP	DGTVKLLIYY	TS RLHSGVPS	RFSGSGSGTD	YSLTISNLEQ	EDIATYFCQQ	GNTL
IGHV178	DVKLVESGGG	LVKPGGSLKL	SCAAS	GFTFS	SYT MSWVRQT	PEKRLEWVAT	ISSGGST YY	PDSVKGRFTI	SRDNAKNTLY	LQMS S LKSED	TAMYYCTR
05H 178	-----	-----	-----	-----	-----	-----	-----	-----	-----	-----	----- IT -----
05L 210	-----	-----	-----	-----	-----	-----	-----	-----	-----	-----	-----
IGKV210	DIVLTQSPAS	LAVSLGQRAT	ISCRAS	ESVD	NYGISF MNWF	QQKPGQPPKL	LIYA AAS NQGS	GVPARFSGSG	SGTDFSLNIH	PMEEDDTAMY	FCQQSKEV
IGHV176	EVKLVESGGG	LVKPGGSLKL	SCAAS	GFTFS	SYA MSWVRQT	PEKRLEWVAS	ISSGGST YYP	DSVKGRFTIS	RDNARNILYL	QMSSLRSED T	AMYYCAR
06H 176	-----	-----	-----	-----	-----	-----	-----	-----	-----	-----	-----
06L 195	-----	-----	-----	-----	-----	-----	-----	-----	-----	-----	-----
IGKV195	DIVMTQSPSS	LAMSVGQKVT	MSCKSS	QSL L	NSSNQ KNYLA	WYQQKPGQSP	KLLVY FAS TR	ESGVPDRFIG	SGSGTDFTLT	ISSVQAEDLA	DYFCQQHYS

IGHV139	DVQLVESGGG	LVQPGGSRKL	SCAAS	GFTFS	SFG	MHWVRQA	PEKGLEWVAY	ISSGSSTI	YY	ADTVKGRFTI	SRDNPKNLTF	LQMTSLRSED	TAMYYCAR
07H 139	-----	-----	-----	-----	-----	-----	-----	-----	-----	V	-----	-----	-----
07L 072	-----	-----	-----	R	N	N	F	-----	-----	-----	-----	-----	-----
IGKV072	QIVLTQSPAI	MSASPGEKVT	MTCSAS	SSVS	Y	MHWYQQKSG	TSPKRWIY	DT	S	KLASGVPAR	FSGSGSGTSY	SLTISSMEAE	DAATYYCQQW SSN

IGHV158	EVKLVESGGG	LVQPGGSLRL	SCATS	GFTFT	DYY	MSWVRQP	PGKALEWLG	IRNKANGYTT		EYSASVKGRF	TISRDNSQSI	LYLQMNTRLA	EDSATYYCAR				
10H 158	-----	-----	V	-----	Y	-----	-----	K	E	A	D	R	+	L	G	S	-----
10L 115	-----	-----	-----	-----	-----	-----	-----	-----	-----	-----	-----	N	-----	+	-----	-----	-----
24H 158	-----	-----	T	+	-----	-----	-----	V	K	R	D	-----	F	-----	T	G	-----
24L 115	-----	-----	-----	-----	-----	-----	-----	-----	-----	-----	-----	-----	-----	-----	-----	-----	-----
25H 158	-----	-----	+	-----	-----	-----	G	K	R	S	DS	V	-----	V	G	-----	-----
25L 115	-----	-----	-----	-----	-----	-----	R	+	-----	-----	-----	-----	-----	-----	-----	-----	-----
26H 158	-----	-----	K	-----	+	-----	C	AS	-----	-----	++	+	-----	-----	V	+	-----
26L 115	-----	-----	-----	+	T	RS	-----	-----	R	-----	-----	-----	-----	-----	-----	-----	-----
27H 158	-----	-----	-----	-----	+	-----	A	+DRTS	D	R	D	-----	T	-----	F	-----	-----
27L 115	-----	-----	-----	-----	-----	-----	-----	-----	-----	-----	-----	-----	-----	-----	-----	-----	-----
28H 158	-----	-----	-----	-----	+	-----	A	+DRTS	D	R	D	-----	T	-----	F	-----	-----
28L 115	-----	-----	-----	-----	-----	-----	-----	-----	-----	-----	-----	-----	-----	-----	-----	-----	-----
29H 158	-----	-----	K	-----	+	-----	A	+DRTS	D	R	D	-----	T	-----	F	-----	-----
29L 115	-----	-----	-----	-----	-----	-----	-----	-----	-----	-----	-----	-----	-----	-----	-----	-----	-----
30H 158	-----	-----	-----	-----	-----	-----	+	S	V	-----	-----	G	-----	-----	-----	-----	-----
30L 115	-----	-----	-----	-----	-----	-----	-----	-----	+	V	-----	-----	-----	-----	-----	-----	-----
IGKV115	DVLMTQTPLS	LPVSLGDQAS	ISCRSS	QSIV	HSNGNTY	LEW	YLQKPGQSPK	LLIY	KVS	NRF	SGVPDRFSGS	GGTDFTLKI	SRVEAEDLGV	YYCFQGS	SHV		

IGHV139	DVQLVESGGG	LVQPGGSRKL	SCAAS	GFTFS	SFG	MHWVRQA	PEKGLEWVAY	ISSGSSTI	YY	ADTVKGRFTI	SRDNPKNLTF	LQMTSLRSED	TAMYYCAR		
08H 139	-----	-----	-----	-----	-----	-----	-----	-----	-----	V	-----	-----	-----		
08L 231	-----	-----	T	+	-----	-----	+	Q	+	-----	D	-----	I		
IGKV231	DVVMTQTPLS	LPVSLGDQAS	ISCRSS	QSIV	HSNGNTY	LEW	YLQKPGQSPK	LLIY	KVS	NRL	SGVPDRFSGS	GGTXFTLKI	SRVEAEDLGV	YYCFQGS	SHV

IGHV114 EVKLEESGGG LVQPGGSMKL SCVAS**GFTFS NYW**MNWRQS PEKGLEWVAE **IRLKSNNYAT** HYAESVKGRF TISRDDSKSS VYLQMNLRRA EDTGIYYCTR
 09H 114 ----- + S S ----- D ----- K ----- R L ----- S ----- + ----- +G
 09L 099 -----
 IGKV099 DVVMTQTPLT LSVTIGQPAS ISCKSS**QSLY YSNKTY**LNW LLQRPQSPK RLIY**LVS**KLD SGVPDRFTGS GSGTDFTLKI SRVEAEDLGV YYCVQGFHF

IGHV627 QVQLQSGPE LVKPGASVRI SCKAS**GYTFT SYI**LHWVKQR PGQGLEWIGW **IYPGNGNT**KY NEKFKGKATL TADKSSSTAY MQLSSLTSED SAVYFCAR
 13H 627 ----- +
 13L 103 ----- S ----- Q ----- T S ----- DG -----
 IGKV103 DIQMTQSPSS LSASLGERVS LTCRAS**QDIH GY**LNLFFQOKP GETIKHLIYE **TS**NLDSGVPK RFGSGRSGD YSLIIGSLES EDFADYYCLO YASS

IGHV627 QVQLQSGPE LVKPGASVRI SCKAS**GYTFT SYI**LHWVKQR PGQGLEWIGW **IYPGNGNT**KY NEKFKGKATL TADKSSSTAY MQLSSLTSED SAVYFCAR
 14H 627 ----- +
 14L 174 -----
 IGKV174 DIQMTQSPAS LSASVGETVT ITCRAS**GNIH NY**LAWYQQQ GKSPQLLVY**N AK**TLADGVPS RFGSGSGTQ YSLKINSLQP EDFGSYYCQH FWST

IGHV175 QVQLKESGPG LVAPSQSLSI TCTVSG**FSLS RYS**VHWVRQP PGKGLEWLGW **IWGGGST**DYN SALKSRLSIS KDNSKSQVFL KMNSLQTTDDT AMYYCAR
 15H 175 ----- + NN ----- I -----
 15L 072 ----- IQ F ----- G ----- N Y -----
 IGKV072 QIVLTQSPAI MSASPGEKVT MTCRAS**SSVS Y**MHWYQQKSG TSPKRWIY**DT S**KLASGVPAR FSGSGSGTSY SLTISSMEAE DAATYYCQW SSN

IGHV073 QVQLQSGAE LVKTGASVKM SCKAS**GYTFT SYI**MHWVKQR PGQGLEWIGW **INPSSGYT**NY NQKFKDKATL TADKSSSTAY MQLSSLTSED SAVYYCAR
 16H 073 ----- T + ----- + ----- N ----- I -----
 16L 078 ----- T ----- T -----
 IGKV078 ENVLTQSPAI MSASPGEKVT MTCRAS**SSVS SSI**LHWYQQK SGASPKLWIY **STSN**LAGVVP ARFSGSGSGT SYSLTISSVE AEDAATYYCQ QYSGY

IGHV171 QVQLKESGPG LVAPSQSLSI TCTVSG**FSLT SYG**VHWVRQP PGKGLEWLGW **IWAGGST**NYN SALMSRLSIS KDNSKSQVFL KMNSLQTTDDT AMYYCAR
 18H 171 ----- VI + I ----- + P + ----- T T ----- N ----- + -----
 18L 072 ----- T -----
 IGKV072 QIVLTQSPAI MSASPGEKVT MTCRAS**SSVS Y**MHWYQQKSG TSPKRWIY**DT S**KLASGVPAR FSGSGSGTSY SLTISSMEAE DAATYYCQW SSN

IGHV171	QVQLKESGPG	LVAPSQSLSI	TCTVSG	GFSLT SYG	VHWVRQP	PGKGLEWLG	IWAGGST	NYN	SALMSRLSIS	KDNSKSQVFL	KMNSLQTTDDT	AMYICAR					
19H 171	-----	-----	-----	+H	-----	Q	S N	W	-----	R	-----	L	-----	V++			
19L 137	-----	-----	-----	-----	+ F	-----	K	+	-----	-----	-----	+	-----	K			
IGKV137	DIQMTQTTSS	LSASLGDRVT	ISCRAS	QDIS NY	LNWYQQKP	DGTVKLLIY	Y TS	RLHSGVPS	RFSGSGSGTD	YSLTISNLEQ	EDIATYFCQQ	GNTL					
IGHV138	SDVQLQESGP	DLVKPSQSL	LTCTVT	GYSI TSGYSW	HWIR	QFPGNKLEWM	GYLHYSGSTN	YNPSLKSRIS	ITRDTSKNQF	FLQLNSVTTE	DTATYYCARF						
20H 138	-----	-----	-----	G	-----	-----	YF	SS	F	-----	-----	A	-----				
20L 123	-----	-----	-----	-----	-----	-----	V	-----	-----	-----	-----	K	-----				
IGKV123	DIVMTQAAFS	NPVTLGTSAS	ISCRSS	KSLL HSN	GITY	LYW	YLQKPGQSPQ	LLIY	QMS	NLA	SGVPDRFSSS	GGTDFTLRI	SRVEAEDVGV	YYCAQNL			
IGHV139	DVQLVESGGG	LVQPGGSRKL	SCAASG	GFTFS SFG	MHWVRQA	PEKGLEWVAY	ISSGSSTI	YY	ADTVKGRFTI	SRDNPKNLTF	LQMTSLRSED	TAMYYCAR					
21H 139	-----	-----	-----	-----	I	-----	N	-----	-----	-----	-----	F+					
21L 072	-----	-----	-----	N F	+	-----	S	-----	-----	-----	-----	+T	-----	G			
IGKV072	QIVLTQSPAI	MSASPGEKVT	MTCAS	SSVS Y	MHWYQQSG	TSPKRWIY	DT S	KLASGVPAR	FSGSGSGTSY	SLTISSMEAE	DAATYYCQQW	SSN					
IGHV114	EVKLEESGGG	LVQPGGSMKL	SCVASG	GFTFS NYW	MNWRQS	PEKGLEWVAE	IRLKSNNYAT		HYAESVKGRF	TISRDDSKSS	VYLQMNLR	EDTGIYYCTR					
22H 114	-----	-----	-----	-----	-----	-----	S	+	-----	-----	-----	F	-----	+T			
22L 108	-----	-----	-----	H	F	-----	-----	+	-----	-----	-----	A	-----	-----			
23H 114	-----	-----	-----	-----	-----	-----	-----	+	-----	-----	-----	R	-----	+T			
23L 108	-----	-----	-----	-----	F	-----	-----	+	-----	-----	-----	G	-----	-----			
IGKV108	DIQMTQSPSS	LSASLGERVS	LTCRAS	QELS GY	LSWLQOKP	DGTIKRLIY	A AS	TLDSGVPK	RFSGSRGSD	YSLTISSLES	EDFADYYCLO	YASY					
IGHV125	EVQLQSGAE	LVKPGASVKL	SCTASG	FNLIK DTY	MHWVKQR	PEQGLEWIGR	IDPANGNT	KY	DPKFQKATI	TADTSSNTAY	LQLSSLTSED	TAVYYCAR					
31H 125	-----	-----	-----	+	Q	L	-----	NS	-----	-----	-----	T	I	-----	S	-----	S
31L 129	-----	-----	-----	-----	N F	-----	+	-----	-----	-----	-----	+	-----	-----	-----	-----	-----
32H 125	-----	-----	-----	-----	+	Q	L	-----	NS	-----	-----	T	I	-----	S	-----	S
32L 129	-----	-----	-----	-----	N F	-----	-----	-----	-----	-----	-----	+	-----	-----	-----	-----	-----
IGKV129	DIQMNQSPSS	LSASLGDTIT	ITCHAS	QININ VW	LSWYQQKP	GNIPKLLIY	K AS	NLHTGVP	RFSGSGSGTG	FTLTISSLQ	EDIATYYCQQ	GQSY					

IGHV125	EVQLQQSGAE	LVKPGASVKL	SCTAS	GFNIK DTY	MHWVKQR	PEQGLEWIGR	IDPANGNT	KY	DPKFQ GKATI	TADTSSNTAY	LQLSSLTSED	TAVYYCAR
33H 125	-----	-----	-----	Y	-----	-----	Y	-----	-----	S	-----	-----
33L 172	-----	-----	-----	-----	-----	-----	-----	-----	-----	-----	-----	+
IGKV172	DIQMTQSPAS	LSASVGETVT	ITCRAS	ENIY SY	LAWYQQKQ	GKSPQLLVY	IN AK	TLAEGVPS	RFSGSGSGTQ	FSLKINSLQP	EDFGSYQCQ	HYGT
IGHV663	EVKLVESEGG	LVQPGGSLRL	SCATS	EFTFT DYY	MSWVRQP	PGKALEWLG	IRNKANGYT	T	EYSASVKGRF	TISRDN SQSI	LYLQMN TLRA	EDSATYYCAR
36H 663	-----	-----	-----	-----	-----	+ S V	R	-----	-----	G	-----	-----
36L 115	-----	-----	-----	-----	-----	-----	-----	V	-----	-----	TK	-----
IGKV115	DVLM TQTPLS	LPVSLGDQAS	ISCRSS	QSIV HSN GNTY	LEW	YLQKPGQSPK	LLIY KVS	NRF	SGVPDRFSGS	GGTDFTLKI	SRVEAEDLGV	YYCFQ GSHV
IGHV495	QVQLQQSGAE	LARPGASVKM	SCKAS	GYTFT SYW	MQWVKQR	PGQGLEWIGA	IYPGDGDT	RY	TQKFKGRATL	TADKSSSTAY	MQLSSLTSED	SAVYYCAT
02H 495	-----	-----	-----	-----	-----	-----	-----	-----	-----	-----	A	R
IGKV115	DVLM TQTPLS	LPVSLGDQAS	ISCRSS	QSIV HSN GNTY	LEW	YLQKPGQSPK	LLIY KVS	NRF	SGVPDRFSGS	GGTDFTLKI	SRVEAEDLGV	YYCFQ GSHV
12L 115	-----	-----	-----	-----	-----	-----	-----	+	-----	-----	-----	-----
IGKV078	ENVLTQSPAI	MSASPGEKVT	MTCRAS	SSVS SSY	LHWYQQK	SGASPKLWIY	ST	SNLASGVP	ARFSGSGSGT	SYSLTISSVE	AEDAATYYCQ	QYSGY
34L 078	-----	-----	-----	-----	-----	D V	-----	-----	-----	-----	-----	-----
IGKV137	DIQMTQTTSS	LSASLGDRVT	ISCRAS	QDIS NY	LNWYQQKP	DGTVKLLIY	Y TS	RLHSGVPS	RFSGSGSGTD	YSLTISNLEQ	EDIATYFCQQ	GNTL
11L 137	-----	-----	-----	-----	F	-----	Q	-----	-----	-----	A	-----
35L 137	-----	-----	-----	-----	+ F	-----	K	+	-----	-----	+	-K-

Legend for Figure 1

Antibodies are specified by numbers (01, 02, etc.) and the chains are indicated by H or L followed by the coding gene, according to the integrative data base VBASE2. The deduced amino acid sequences of antibody V genes are compared with the respective germline VH (IGHV, full sequence shown above a group of Ab) and VL sequence (IGKV, full sequence shown below a group of Ab). A dash indicates identity with the respective germline-encoded amino acid, productive mutations are indicated by the new aa in the one-letter code and silent mutations are indicated by a (+). Mutations correlate with affinity enhancement are showed in grey background.

Figure 2

Amino acid sequences of VH/VL gene-encoded variable regions of TD antigen-induced anti-phOx antibodies in Δ D-ID mice

(Legend see below)

Amino acid sequences of TD antigen-induced primary day 7 antibodies of Δ D-ID mice

IGHV532	QVQLQQSGAE	LAKPGASVKM	SCKAS	GYTFT	SYWM	HWVKQR	PGQGLEWIGY	INPSTGYTEY	NQKFKDKATL	TADKSSSTAY	MQLSSLTSED	SAVYYCAR			
01H 532	-----	-----	-----	-----	-----	-----	-----	-----	-----	-----	-----	-----			
01L 097	-----	-----	-----	-----	-----	-----	-----	-----	-----	-----	-----	-----			
IGKV097	DVVMTQTPLT	LSVTIGQPAS	ISCKSS	QSL	DS	DKTY	LNW	LLQRPQSPK	RLIY	LVS	SKLD	SGVPDRFTGS	SGGTDFTLKI	SRVEAEDLGV	YYCWQGTHF

IGHV532	QVQLQQSGAE	LAKPGASVKM	SCKAS	GYTFT	SYWM	HWVKQR	PGQGLEWIGY	INPSTGYTEY	NQKFKDKATL	TADKSSSTAY	MQLSSLTSED	SAVYYCAR		
02H 532	-----	-----	-----	-----	-----	-----	-----	-----	-----	-----	-----	-----		
02L 171	-----	-----	-----	-----	-----	-----	-----	-----	-----	-----	-----	-----		
IGKV171	DIVLTQSPAT	LSVTPGDRVS	LSCRAS	QSL	S	NYL	LHWYQOKS	HESPRLLIKY	AS	QSIGIPS	RFSGSGSGTD	FTLSINSVET	EDFGMYFCQQ	SNSW

IGHV286	EFQLQQSGPE	LVKPGASVKM	SCKAS	GYTFT	SYVM	MHWVKQK	PGQGLEWIGY	IYPYNDGTY	NEKFKGKATL	TSDKSSSTAY	MELSSLTSED	SAVYYCAR			
03H 286	-----	-----	-----	-----	-----	-----	-----	-----	-----	-----	-----	-----			
03L 195	-----	-----	-----	-----	-----	-----	-----	-----	-----	-----	-----	-----			
IGKV195	DIVMTQSPSS	LAMSVGQKVT	MCKSS	QSL	NSS	NQNY	LA	WYQOKPGOSP	KLLVY	FAS	TR	ESGVPDRFIG	SGSGTDFTLT	ISSVQAEDLA	DYFCQOHYS

IGHV286	EFQLQQSGPE	LVKPGASVKM	SCKAS	GYTFT	SYVM	MHWVKQK	PGQGLEWIGY	IYPYNDGTY	NEKFKGKATL	TSDKSSSTAY	MELSSLTSED	SAVYYCAR			
04H 286	-----	-----	-----	-----	-----	-----	-----	-----	-----	-----	-----	-----			
04L 122	-----	-----	-----	-----	-----	-----	-----	-----	-----	-----	-----	-----			
IGKV122	DVVMTQTPLS	LPVSLGDQAS	ISCRSS	QSLV	HS	NGNTY	LHW	YLQKPGQSPK	LLIY	KVS	NR	SGVPDRFSGS	SGGTDFTLKI	SRVEAEDLGV	YFCSQSTHV

IGHV171	QVQLKESGPG	LVAPSQSLSI	TCTVS	GFSLT	SYG	VHWVROP	PGKGLEWLGV	IWAGGST	NYN	SALMSRLSIS	KDNSKSQVFL	KMNSLQDDT	AMYYCAR
05H 171	-----	-----	-----	-----	-----	-----	-----	-----	-----	-----	-----	-----	-----
05L 078	-----	-----	-----	-----	-----	-----	-----	-----	-----	-----	-----	-----	-----
IGKV078	ENVLTQSPAI	MSASPGEKVT	MTCRASS	SVS	SSY	LHWYQOK	SGASPKLWIY	STS	NLASGVP	ARFSGSGSGT	SYSLTISSVE	AEDAATYYCQ	QYSGY

IGHV171 QVQLKESGPG LVAPSQSLSI TCTVSG**FSLT SYG**VHWVRQP PGKGLEWLGV **IWAGGST**NYN SALMSRLSIS KDNSKSQVFL KMNSLQTTDDT AMYYCAR
 06H 171 ----- +----- +----- +----- +----- +----- +----- +----- +----- +----- +-----
 06L 137 ----- +----- +----- +----- +----- +----- +----- +----- +----- +----- +-----
 IGKV137 DIQMTQTTSS LSASLGDRVT ISCRAS**QDIS NY**LNWYQQKP DGTVKLLI**Y TS**RLHSGVPS RFSGSGSGTD YSLTISNLEQ EDIATYFCQQ GNTL

IGHV171 QVQLKESGPG LVAPSQSLSI TCTVSG**FSLT SYG**VHWVRQP PGKGLEWLGV **IWAGGST**NYN SALMSRLSIS KDNSKSQVFL KMNSLQTTDDT AMYYCAR
 07H 171 ----- +----- +----- +----- +----- +----- +----- +----- +----- +----- +-----
 07L 210 ----- +----- +----- +----- +----- +----- +----- +----- +----- +----- +-----
 IGKV210 DIVLTQSPAS LAVSLGQRAT ISCRAS**ESVD NYGISF**MNWF QOKPGOPP**KL LIY**AAS**NOGS** GVPARFSGSG SGTDFSLNIH PMEEDDTAMY FCQOSKEV

IGHV131 EVKLVESGGG LVKPGGSLKL SCAAS**GFAPS SYD**MSWVRQT PEKRLEWVAT **ISSGGSYT**YY PDSVKGRFTI SRDNARNTLY LQMSSLRSED TALYYCAR
 08H 131 ----- +----- +----- +----- +----- +----- +----- +----- +----- +----- +-----
 08L 122 ----- **S**----- +----- +----- +----- +----- +----- +----- +----- +----- +-----
 IGKV122 DVVMTQTPLS LPVSLGDQAS ISCRSS**QSLV HSN**GNTY**LHW** YLQKPGQSPK LLIY**KVS**NRF SGVPDRFSGS GSGTDFTLKI SRVEAEDLGV YFCSQSTHV

IGHV114 EVKLEESGGG LVQPGGSMKL SCVAS**GFIFS NYW**MNWRQS PEKGLEWVAE **IRLKSNNYAT**HYAESVKGRF TISRDDSKSS VYLQMNLRRA EDTGIYYCTR
 09H 114 ----- +----- +----- +----- +----- +----- +----- +----- +----- +----- +-----
 09L 108 ----- +----- +----- +----- +----- +----- +----- +----- +----- +----- +-----
 IGKV108 DIQMTQSPSS LSASLGERVS LTRCAS**QEIS GY**LSWLQQKP DGTIKRLI**YA AS**TLDSGVPK RFSGSRSGSD YSLTISSLES EDFADYYCLQ YASY

IGHV183 QVQLKQSGPG LVQPSQSLSI TCTVSG**FSLT SYG**VHWVRQS PGKGLEWLGV **IWSGGST**DYN AAFISRLSIS KDNSKSQVFF KMNSLQANDT AIYYCAR
 12H 183 ----- +----- +----- +----- +----- +----- +----- +----- +----- +----- +-----
 12L 072 ----- +----- +----- +----- +----- +----- +----- +----- +----- +----- +-----
 IGKV072 QIVLTQSPAI MSASPGEKVT MTCAS**SSVS Y**MHWYQQKSG TSPKRWI**YDT SK**LASGVPAR FSGSGSGTSY SLTISSMEAE DAATYYCQOW SSN

IGHV171 QVQLKESGPG LVAPSQSLSI TCTVSG**FSLT SYG**VHWVRQP PGKGLEWLGV **IWAGGST**NYN SALMSRLSIS KDNSKSQVFL KMNSLQTTDDT AMYYCAR
 13H 171 ----- +----- +----- +----- +----- +----- +----- +----- +----- +----- +-----
 13L 115 ----- +----- +----- +----- +----- +----- +----- +----- +----- +----- +-----
 IGKV115 DVLMTQTPLS LPVSLGDQAS ISCRSS**QSLV HSN**GNTY**LHW** YLQKPGQSPK LLIY**KVS**NRF SGVPDRFSGS GSGTDFTLKI SRVEAEDLGV YYCFQGS

Amino acid sequences of TD antigen-induced primary day 14 antibodies of ΔD-ID mice

IGHV014	QVQLQQSGAE	LVRPGTSVKI	SCKAS	GYTFT NYW	LGWVKQR	PGHGLEWIGD	IYPGGGYT	NEKFKGKATL	TADTSSSTAY	MQLSSLTSED	SAVYFC	
01H 014	-----	-----	-----	-----	-----	-----	-----	-----	-----	-----	-----	
01L 137	-----	-----	-----	-----	-----	-----	-----	-----	-----	-----	-----	
IGKV137	DIQMTQTSS	LSASLGDRVT	ISCRAS	QDIS NY	LNWYQQKP	DGTVKLLIYY	TSR	RLHSGVPS	RFSGSGSGTD	YSLTISNLEQ	EDIATYFCQQ	GNTL
IGHV654	QVQLQQPGAE	LVKPGASVKM	SCKAS	GYTFT SYM	MHWVKQT	PGQGLEWIGA	IYPNGDTS	Y NQKFKGKATL	TADKSSSTAY	MQLSSLTSED	SAVYYCAR	
02H 654	-----	-----	-----	-----	-----	-----	-----	-P-+	-+	-----	-----	
02L 097	-----	-----	-----	-----	-----	-----	-----	-----	-----	-----	-----	
IGKV097	DVVMTQTPLT	LSVTIGQPAS	ISCKSS	QSLLDSDGKTY	LNW	LLQRPQSPK	RLIY LVS	KLD	SGVPDRFTGS	GGTDFTLKI	SRVEAEDLGV	YYCWQGTHF
IGHV499	QVQLQQSGAE	LAKPGASVKM	SCKAS	GYTFT SYW	MHWVKQR	PGQGLEWIGY	INPSSGYT	KY NQKFKDKATL	TADKSSSTAY	MQLSSLTSED	SAVYYCAR	
03H 499	-----	-----	-----	-----	-----	-----	-----	-----	-----	-----	-----	
03L 198	-----	-----	-----	-----	-----	-----	-----	-----	-----	-----	-----	
IGKV198	DIVMTQSHKF	MSTSVGDRVS	ITCKAS	QDVS TAV	AWYQQKP	GQSPKLLIYS	AS	RYRTGVPD	RFTGSGSGTD	FTFTISSVQA	EDLAVYYCQQ	HYST
IGHV286	EFQLQQSGPE	LVKPGASVKM	SCKAS	GYTFT SYV	MHWVKQK	PGQGLEWIGY	IYPYNDGT	KY NEKFKGKATL	TSDKSSSTAY	MELSSLTSED	SAVYYCAR	
04H 286	-----	-----	-----	-----	-----	-----	-----	-N-	-----	-----	-----	
04L 201	-----	-----	-----	-----	-----	-----	-----	-----	-----	-----	-----	
IGKV201	DIVMTQSQKF	MSTSVGDRVS	VTCKAS	QNVG TN	AWYQQKP	GQSPKALIYS	AS	RYRSGVPD	RFTGSGSGTD	FTLTISNVQS	EDLAEYFCQQ	YNSY
IGHV128	EVQLQESGPS	LVKPSQTLSL	TCSVT	GDSIT SGY	WNWIRKF	PGNKLEYMGY	ISYSGST	YYN PSLKSRISIT	RDTSKNQYYL	QLNSVTTEDT	ATYYCAR	
06H 128	-----	-----	-----	-----	-----	-----	-----	-RN--N-H-	-----	-----	-----	
06L 050	-----	-----	-----	N	Q	-----	-----	-----	+	-----	T-	
IGKV050	QIVLSQSPAI	LSASPGEKVT	MTCRAS	SSVS Y	MHWYQQKP	G	SSPKPWIY AT	SNLASGVPAR	FSGSGSGTSY	SLTISRVEAE	DAATYYCQOW	SSN

IGHV706	QVQLQQSGAE	LVKPGASVKL	SCKTSGYTFI SYW	IQWVKQR	PGQGLGWIGE	IFPGTGTTY	NEKFKGKATL	TIDTSSSTAY	MQLSSLTSED	SAVYFCAR
05H 706	-----	-----	-----	-----	-----	-----	-----	-----	-----	-----
05L 142	-----	-----	-----	-----	-----	-----	-----	-----	-----	-----
IGKV142	EIVLTQSPPT	MAASPGEKIT	ITCSASSIS SNY	LHWYQOK	PGFSPKLLIY	RTSNLASGVP	ARFSGSGSGT	SYSLTIGTME	AEDVATYYCQ	QGSSI
IGHV128	EVQLQESGPS	LVKPSQTLSL	TCSVTGDSIT SGY	WNWIRKF	PGNKLEYMGY	ISYSGSTYYN	PSLKSRISIT	RDTSKNQYYL	QLNSVTTEDT	ATYYCAR
07H 128	-----	-----	-----	-----	-----	-----	-----	-----	-----	-----
07L 137	-----	-----	-----	-----	-----	-----	-----	-----	-----	-----
IGKV137	DIQMTQTSS	LSASLGDRVT	ISCRASQDIS NY	LNWYQOKP	DGTVKLLIYY	TSRLHSGVPS	RFSGSGSGTD	YSLTISNLEQ	EDIATYFCQQ	GNTL
IGHV192	EVQLVESGGD	LVKPGGSLKL	SCAASGFTFS SYG	MSWVRQT	PDKRLEWVAT	ISSGGSYTTY	PDSVKGRFTI	SRDNAKNTLY	LQMSSLKSED	TAMYYCAR
08H 192	---E-+---	-----	-----	-----	-----	-----	-----	-----	-----	-----
08L 168	-----	-----	-----	-----	-----	-----	-----	-----	-----	-----
IGKV168	DILLTQSPAI	LSVSPGERVS	FSCRASQSIG TS	IHWYQORT	NGSPRLLIKY	ASISISGIPS	RFSGSGSGTD	FTLSINSVES	EDIADYYCQQ	SNSW
IGHV147	EVMLVESGGG	LVKPGGSLKL	SCAASGFTFS SYA	MSWVRQT	PEKRLEWVAT	ISSGGSYTTY	PDSVKGRFTI	SRDNAKNTLY	LQMSSLRSED	TAMYYCAR
09H 147	-----	-----	-----	-----	-----	-----	-----	-----	-----	-----
09L 140	-----	-----	-----	-----	-----	-----	-----	-----	-----	A-----
IGKV140	DIQMTQSPSS	LSASLGKVT	ITCKASQDIN KY	IAWYQHQP	GKGPRLLIHY	TSITLQPGIPS	RFSGSGSGRD	YSFISISNLEP	EDIATYYCLQ	YDNL
IGHV135	EVQLVESGGG	LVKPGGSLKL	SCAASGFTFS SYA	MSWVRQT	PEKRLEWVAT	ISSGGSYTTY	PDSVKGRFTI	SRDNAKNTLY	LQMSSLRSED	TAMYYCAR
10H 135	-----	-----	-----	-----	-----	-----	-----	-----	-----	-----
10L 168	-----	-----	-----	-----	-----	-----	-----	-----	-----	-----
IGKV168	DILLTQSPAI	LSVSPGERVS	FSCRASQSIG TS	IHWYQORT	NGSPRLLIKY	ASISISGIPS	RFSGSGSGTD	FTLSINSVES	EDIADYYCQQ	SNSW
IGHV135	EVQLVESGGG	LVKPGGSLKL	SCAASGFTFS SYA	MSWVRQT	PEKRLEWVAT	ISSGGSYTTY	PDSVKGRFTI	SRDNAKNTLY	LQMSSLRSED	TAMYYCAR
11H 135	-----	-----	-----	-----	-----	-----	-----	-----	-----	-----N
11L 072	-----	-----	-----	-----	-----	-----	-----	-----	-----	-----
IGKV072	QIVLTQSPAI	MSASPGEKVT	MTCSSSVS Y	MHWYQOKSG	TSPKRWIYDT	SKLASGVPAR	FSGSGSGTSY	SLTISSMEAE	DAATYYCQQW	SSN

IGHV178 VKLVESGGG LVKPGGSLKL SCAAS**GFTFS SYT**MSWVRQT PEKRLEWVAT **ISSGGSYT**YY PDSVKGRFTI SRDNAKNTLY LQMSSLKSED TAMYYCTR
 12H 178 ----- **T** ----- **G** -----
 12L 069 -----
 IGKV069 IVMTQSPSS LSVSAGEKVT MSCKSS**QSLN NSGNQKNY**LA WYQQKPGQPP KLLIY**GAS**TR ESGVPDRFTG SGSGTDFTLT ISSVQAEDLA VYYCQNDHSY

IGHV185 EVQLVESGGG LVQPGESLKL SCESNE**YEFPSHDM**MSWVRKT PEKRLELVAA **INSDGGST**YY PDTMERRFII SRDNTKKTLY LQMSSLRSED TALYYCAR
 13H 185 -----
 13L 082 -----
 IGKV082 QIVLTQSPAI MSASPGEKVT ITCSAS**SSVS YMHWFQKPG** TSPKLWIY**ST SN**LASGVPAR FSGSGSGTSY SLTISRMEAE DAATYYCQQR SSY

IGHV135 EVQLVESGGG LVKPGGSLKL SCAAS**GFTFS SYA**MSWVRQT PEKRLEWVAT **ISSGGSYT**YY PDSVKGRFTI SRDNAKNTLY LQMSSLRSED TAMYYCAR
 14H 135 ----- **E** ----- **+** -----
 14L 179 -----
 IGKV179 DIVMTQSPAT LSVTPGDRVS LSCRAS**QSIS DY**LHWYQOKS HESPRLLIKY **AS**QSISGIPS RFSGSGSGSD FTLSINSVEP EDVGVYYCQN GHSF

IGHV114 VKLEESGGG LVQPGGSMKL SCVAS**GFTFS NYW**MNWRQS PEKGLEWVAE **IRLKSNNYAT** HYAESVKGRF TISRDDSKSS VYLQMNLR EDGTGIYYCTR
 15H 114 ----- **I** ----- **Q** ----- **+** ----- **+** -----
 15L 115 -----
 IGKV115 VLMTQTPLS LPVSLGDQAS ISCRSS**QSIV HSNNTY**LEW YLQKPGQSPK LLIY**KVSN**RF SGVPDRFSGS GSGTDFTLKI SRVEAEDLGV YYCFQGS HV

IGHV028 VQLVESGGG LVQPKGSLKL SCAAS**GFTFN TYA**MNWRQA PGKLEWVAR **IRSKSNYAT** YYADSVKDRF TISRDDSQSM LYLQMNLR EDGTAMYYCVS
 16H 028 -----
 16L 170 -----
 IGKV170 IQMTQSPAS LSVSVGETVT ITCRAS**ENLY SN**LAWYQOKQ GKSPQLLVYA **AT**NLADGVPS RFSGSGSGTQ YSLKINSLQS EDFGSYYCQH FWGT

IGHV455 QVQLQQPGAE LVKPGASVKM SCKAS**GYTFT SYW**MHWVKQR PGQGLEWIGM **IDPSDSYTS**Y NQKFKGKATL TVDTSSSTAY MQLSSLTSED SAVYYCTR
 20H 455 ----- **+** ----- **T** ----- **+** ----- **N** -----
 20L 115 ----- **+** ----- **H** -----
 IGKV115 DVLMTQTPLS LPVSLGDQAS ISCRSS**QSIV HSNNTY**LEW YLQKPGQSPK LLIY**KVSN**RF SGVPDRFSGS GSGTDFTLKI SRVEAEDLGV YYCFQGS HV

IGKV170 DIQMTQSPAS LSVSVGETVT ITCRAS**ENLY SM**LAWYQQKQ GKSPQLLVYA **AT**NLADGVPS RFSGSGSGTQ YSLKINSLQS EDFGSYYCQH FWGT
 17L 170 -----

IGKV097 DVVMTQTPLT LSVTIGQPAS ISCKSS**QSLD DSDGKTY**LNW LLQRPQSPK RLIY**LVS**KLD SGVPDRFTGS GSGTDFTLKI SRVEAEDLGV YYCWQGTHF
 18L 097 -----

IGKV078 ENVLTQSPAI MSASPGEKVT MTCRAS**SSVS SSY**LHWYQQK SGASPKLWIY **STS**NLASGVP ARFSGSGSGT SYSLTISSVE AEDAATYYCQ QYSGY
 19L 078 -----

IGHV528 EVQLQQSGPE LVKPGASVKM SCKAS**GYTFT DYY**MKWVKQS HGKSLEWIGD **LNPNGDT**FFY NQKFKGKATL TVDKSSSTAY MQLNSLTSED SAVYYCAR
 21H 528 -----L++-----V-I-----R-N-----H-SR-----

Amino acid sequences of TD antigen-induced secondary antibodies of ΔD-iD mice

IGHV114 EVKLEESGGG LVQPGGSMKL SCVAS**GFTF**S NYW**M**NWVRQS PEKGLEWVAE **IRLKS**NMYAT'HYAESVKGRF TISRDDSKSS VYLQMNLR A EDTGIYYCTR
 01H 114 -----+-----F-----R-Y-----
 01L 108 -----T-----F-----P-----+-----
 IGKV108 DIQMTQSPSS LSASLGERVS LTCRAS**QEIS GY**LSWLQQKP DGTIKRLIYA **AS**TLDGVPK RFSGSRSGSD YSLTISSLES EDFADYYCLQ YASY

IGHV386 QVQLQQSGAE LMKPGASVKI SCKAT**GYTFS SYW**LEWVKQR PGHGLEWIGE **ILPGSGST**NY NEKFKGKATF TADTSSNTAY MQLSSLTSED SAVYYCAR
 02H 386 -----V-R-----I-**RF**-D-----+-----F-N+**YK**+---+-----I-----W-----F-----
 02L 108 -----S-----+-----N-----G-----T-----G-----F-----
 IGKV108 DIQMTQSPSS LSASLGERVS LTCRAS**QEIS GY**LSWLQQKP DGTIKRLIYA **AS**TLDGVPK RFSGSRSGSD YSLTISSLES EDFADYYCLQ YASY

Amino acid sequences of TD antigen-induced tertiary antibodies of ΔD-ID mice

IGHV201 QVQLKQSGPG LVQPSQSLSI TCTVSG**FS**LT **SYG**VHWVRQS PGKGLEWLGV **IWRGGST**DYN AAFMSRLSIT KDNSKSQVFF KMNSLQADDT AIYYCAK
 01H 201 -----
 01L 050 -----
 IGKV050 QIVLSQSPAI LSASPGEKVT MTCRAS**SSVS** YMHWYQOKPG SSPKPWIY**AT S**NLASGVPAR FSGSGSGTSY SLTISRVEAE DAATYYCQOW SSN

IGHV171 QVQLKESGPG LVAPSQSLSI TCTVSG**FS**LT **SYG**VHWVRQP PGKGLEWLGV **IWAGGST**NYN SALMSRLSIS KDNSKSQVFL KMNSLQTDDE AMYYCAR
 02H 171 ---**E**-----
 02L 137 -----
 IGKV137 DIQMTQTSS LSASLGDRVT ISCRAS**QDIS** NYLNWYQOKP DGTVKLLIY**Y TS**RLHSGVPS RFGSGSGTD YSLTISNLEQ EDIATYFCQQ GNTL

IGHV171 QVQLKESGPG LVAPSQSLSI TCTVSG**FS**LT **SYG**VHWVRQP PGKGLEWLGV **IWAGGST**NYN SALMSRLSIS KDNSKSQVFL KMNSLQTDDE AMYYCAR
 03H 171 -----
 03L 072 -----
 12H 171 x---**K**-----
 12L 072 XXXXX--**T**--
 IGKV072 QIVLTQSPAI MSASPGEKVT MTCAS**SSVS** YMHWYQOKSG TSPKRWIY**DT S**KLASGVPAR FSGSGSGTSY SLTISSMEAE DAATYYCQOW SSN

IGHV171 QVQLKESGPG LVAPSQSLSI TCTVSG**FS**LT **SYG**VHWVRQP PGKGLEWLGV **IWAGGST**NYN SALMSRLSIS KDNSKSQVFL KMNSLQTDDE AMYYCAR
 04H 171 -----
 04L 079 -----
 IGKV079 QIVLTQSPAI MSASPGEKVT MTCAS**SSVS** YMYWYQOKPG SSPRLIY**DT S**NLASGVPVR FSGSGSGTSY SLTISRMEAE DAATYYCQOW SSY

IGHV192 EVQLVESGGD LVKPGGSLKL SCAAS**GFTFS** **SYG**MSWVRQT PDKRLEWVAT **ISSGGSYT**Y PDSVKGRFTI SRDNAKNTLY LQMSLKSSED TAMYYCAR
 05H 192 ---**E**-----
 05L 157 -----
 IGKV157 QIVLTQSPAL MSASPGEKVT MTCAS**SSVS** YMYWYQOKPR SSPKPWIY**LT S**NLASGVPAR FSGSGSGTSY SLTISSMEAE DAATYYCQOW SSN

IGHV147 EVMLVESGGG LVKPGGSLKL SCAAS**GFTFS SYA**MSWVRQT PEKRLEWVAT **ISSGGSYTY**Y PDSVKGRFTI SRDNAKNTLY LQMSSLRSED TAMYYCAR
 07H 147 -----+-----
 07L 137 -----
 IGKV137 DIQMTQTTSS LSASLGDRVT ISCRAS**QDIS NYL**NWYQQKP DGTVKLLIY**Y T**SLRHSGVPS RFSGSGSGTD YSLTISNLEQ EDIATYFCQQ GNTL

IGHV135 EVQLVESGGG LVKPGGSLKL SCAAS**GFTFS SYA**MSWVRQT PEKRLEWVAT **ISSGGSYTY**Y PDSVKGRFTI SRDNAKNTLY LQMSSLRSED TAMYYCAR
 08H 135 ---E-----+-----S
 08L 210 -----
 IGKV210 DIVLTQSPAS LAVSLGQRAT ISCRAS**ESVD NYGISF**MNWF QQKPGQPPKL LIY**AAS**NQGS GVPARFSGSG SGTDFSLNIH PMEEDDTAMY FCQQSKEV

IGHV386 QVQLQSGAE LMKPGASVKI SCKAT**GYTFS SYW**LEWVKQR PGHGLEWIGE **ILPSSGSTNY** NEKFKGKATF TADTSSNTAY MQLSSLTSED SAVYYC
 10H 386 -----V-----FSI-----N-----S-----T-----+
 10L 108 -----+-----
 IGKV108 DIQMTQSPSS LSASLGERVS LTCRAS**QELIS GYL**SWLQOKP DGTIKRLIY**A AS**ILDGVPK RFSGSRSGSD YSLTISSLES EDFADYYCLO YASY

IGHV158 EVKLVESGGG LVQPGGSLRL SCATS**GFTFT DYY**MSWVRQP PGKALEWLG**F IRNKANGYTT** EYSASVKGRF TISRDNSQSI LYLQMNTLRA EDSATYYCAR
 14H 158 --Q-E-----D-+---L-N-+---+---+MA-MK-L-A-+ + + + -D- - - - + -T -T-----
 14L 115 -----T-R-----+-----
 IGKV115 DVLMTQTPLS LPVSLGDQAS ISCRSS**QSIV HSN**GNTYLEW YLQKPGQSPK LLIY**KVS**NRF SGVPDRFSGS GSGTDFTLKI SRVEAEDLGV YYCFQGSHV-

IGKV140 DIQMTQSPSS LSASLGKVT ITCKAS**QDIN KY**LAWYQHKP GKGPRLLIY**Y T**SLIQGIPS RFSGSGSGRD YSFSISNLEP EDIATYYCLO YDNL
 06L 140 -----F-----

IGKV072 QIVLTQSPAI MSASPGEKVT MTCSAS**SSVS Y**MHWYQQKSG TSPKRWIY**DT S**KLASGVPAR FSGSGSGTSY SLTISSMEAE DAATYYCQQW SSN
 09L 072 -----

IGHV386	QVQLQQSGAE	LMKPGASVKI	SCKAT	GYTFS SYW	LEWVKQR	PGHGLEWIGE	ILP GSGST	NY	NEKFKGKATF	TADTSSNTAY	MQLSSLTSED	SAVYYC						
11H 386	-----	-----	---	G	---	-----	V	---	FSI	N	---	N	-----	++IV+	---	T	-----	+

IGKV168	DILLTQSPAI	LSVSPGERVS	FSCRAS	QSIG TS	IHWYQORT	NGSPRLLIK	Y AS	ESISGIPS	RFSGSGSGTD	FTLSINSVES	EDIADYYCQQ	SNSW							
13L 168	-----	---	Q	-----	---	N	+	H	-----	G	+	---	N	-----	---	---	---	E NY	---
15L 168	-----	-----	---	-----	-----	-----	-----	-----	-----	---	+	-----	-----	-----	-----	-----	-----	-----	-----

IGKV128	DVQITQSPSY	LAASPGETIT	INCRAS	KSIS KY	LAWYQEKP	GKTNKLLIY	S GS	TLQSGIPS	RFSGSGSGTD	FTLTISSLEP	EDFAMYYCQQ	HNEY							
16L 128	-----	-----	---	T	-----	---	+	SY+	---	S	---	---	+	-----	-----	-----	-----	-----	-----

Legend for Figure 2

Antibodies are specified by numbers (01, 02, etc.) and the chains are indicated by H or L followed by the coding gene, according to the integrative data base VBASE2. The deduced amino acid sequences of antibody V genes are compared with the respective germline VH (IGHV, full sequence shown above a group of Ab) and VL sequence (IGKV, full sequence shown below a group of Ab). A dash indicates identity with the respective germline-encoded amino acid, productive mutations are indicated by the new aa in the one-letter code and silent mutations are indicated by a (+). Mutations correlate with affinity enhancement are showed in grey background.

Acknowledgements

First of all, I would like to express my cordially gratitude to Prof. Dr. Hilmar Lemke for providing me the possibility to join his group. I am indebted for his precious advices, fruitful discussion and proof-reading my thesis. His enthusiasm for immunology contributed significantly to the completion my thesis and is one major motivation to pursue my career in science.

I would like to thank Prof. Dr. Stefan Rose-John for taking over the supervision of my thesis and giving me the chance to work at the biochemical institute.

A special thank to my colleague Dr. Radu Tanasa for the great time with him in the Lab.

I wish to thank Prof. Dr. Joachim Grötzinger, and his group members for the warm and comfortable environment; Dr. Inken Lorenzen, Dr. Sascha Jung, Madlen Mohr, Matthias Michalek, Agnes Nolting, Björn Spudy, Verena Pawlak, Marc Rödinger, Britta Hansen and Jonas Völcker.

A special thank is dedicated to my friends Mahnaz Taherzadeh Kaffash, Mohammad Shomali and Ahmad Khalil, who always encouraged me to finish as soon as possible

I thank our collaborators, notably PD. Dr. Michael Zemlin (Marburg, Germany) and Prof. Dr. Harry Schröder (Birmingham, Alabama, USA), for supplying us the transgenic mice and for their helpful discussion.

Finally, I am very grateful for my family, parent, sisters and brothers, for their love, unlimited support and showing me the right perspective towards life. They were and are always the source of joy and relaxation.

Curriculum vitae

Personal Information

Name Ahmad Trad
Address Niemannsweg 152
24105 Germany
Telephone +49 4313106663
Email atrad@biochem.uni-kiel.de
Date of Birth 17.06.1976
Nationality Lebanon

Education

1982 – 1996 High school in Tripolie
Degree: General qualification for university entrance with main subject mathematic.

Study of biochemistry

1997-2001 Study of biochemistry at the Lebanese university in Tripolie
Degree: Maitrise in biochemistry
Maitrise thesis: Smoking and metabolic effects
2002-2003 German courses at the University of Kiel (PNDS)
2003-2005 Diploma study of biochemistry at university of Kiel
Degree: Diploma in biochemistry
Grade: 1.7 („good“)
Diploma thesis: Affinity determination of syngenic anti-idiotypic antibody

Ph.D. Thesis

2006 - Oktober 2009: Ph.D. thesis at the Christian Albrecht University (CAU), Kiel, Chair of Professor Dr. Hilmar Lemke
Ph.D. thesis: Significance of the third hypervariable region of the antibody heavy chain for antigen-specificity and expression of idiotypes during the thymus-dependent immune response

Publications

R. Tanasa, **A. Trad**, H. Lange, J. Grötzinger, and H. Lemke. "Allergen IgE-isotype-specific suppression by maternally derived monoclonal anti-IgG-idiotypic" *Allergy*, 2009. Epub ahead of print: DOI: 10.1111/j.1398-9995.2009.02104.x

H. Lemke, R. Tanasa, **A. Trad** and H. Lange "Benefits and burden of the maternally-mediated immunological imprinting". *Autoimmun Rev* 8 (2009) 394-399.

H. Lange, M. Zemlin, R. Tanasa, **A. Trad**, T. Weiss, H. Menning, H. Lemke. "Thymus-independent type 2 antigen induces a long-term IgG-related network memory". *Mol Immunol* 45 (2008) 2847–2860.

H. Lemke, R. Tanasa, **A. Trad** and H. Lange (2008).

Immunophysiology: Natural autoimmunity in physiology and pathology. P 77-86

Declaration

Herewith I affirm that I composed the present doctoral thesis single all by my self without utilizing illegitimate resources, except for scientific advice giving by Prof. Dr Hilmar Lemke. I used no other aids besides the cited references.

Also, this doctoral thesis has not already been submitted to any other faculty.

Kiel 01.09.2009

Ahmad Trad