

Ion Transport across Membranes Mediated by a Dynamic Combinatorial Library

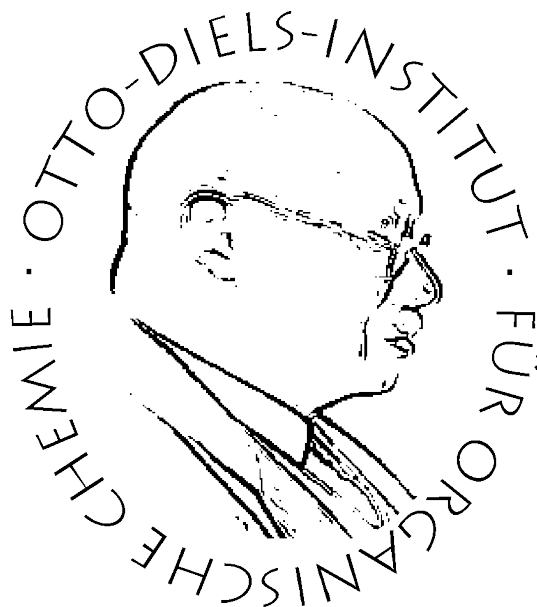

Dissertation

Zur Erlangung des Doktorgrades
der Mathematisch-Naturwissenschaftlichen Fakultät
der Christian-Albrechts-Universität zu Kiel

vorgelegt von

Vittorio Saggiomo

Kiel 2010

Referent: Prof. Dr. Ulrich Lüning

Korreferent: Prof. Dr. Rainer Herges

Tag der mündlichen Prüfung: 29 / 04 / 2010

Zum Druck genehmigt: 25 / 05 /2010

gez. Prof. Dr. L. Kipp, Dekan

Die vorliegende Arbeit wurde unter Anleitung von
Prof. Dr. Ulrich Lüning
am Otto-Diels-Institut für Organische Chemie
der Christian-Albrechts-Universität zu Kiel
in der Zeit von Mai 2007 bis März 2010 angefertigt.

“The true delight is in the finding out rather than in the knowing.”

Isaac Asimov (Chemist)

Acknowledgment

First of all to my ex-girlfriend (a.k.a. wife) Ilaria who is always encouraging and supporting me in almost everything I am doing. She is following me in the foolish idea of doing research somewhere else in the world.

A huge thanks to my Ph.D. supervisor Prof. Dr. Ulrich Lüning, in these three years I learned more than I expected. I have learned great lessons not only in chemistry but also in “real” life. It will be hard to find another kind supervisor like him.

Thanks to Angelika Merten who took care of burEaUcracy on my behalf. That was not an easy job.

A sincere thanks to all the working group. The passage from Italy to Germany was not so traumatic as I thought, mainly thanks to the kindness of all of them.

In these three years I met very good friends. There are too many reasons to thank Frank Schleef that I should write another three theses only to have three new pages for acknowledging him. Thanks to Tim (Mario) Reimers for his friendship, for the nice music selection during the lab time, funny going out in the night and for finding almost all the typos. Thanks to all the chemists that worked and are working in the lab 317 (Christiane Dethlefs and Mirja Oldefest over all with many other students) for the nice working environment. Dr. Ole Winkelmann is kindly acknowledged for the interesting chemistry conversations and the long video games nights. Dr. Dennis Stoltenberg is acknowledged for the nice meetings that we attended together.

Thanks to Dr. Catrin Goeschen (Rainer Herges' group), Jörg Klein (Jeremy Sanders' group in Cambridge), Michael Zengerle (Stefan Kubik's group in Kaiserslautern), Dr. Roberto Quesada (University of Burgos), and Jens Eckelmann for their collaboration in different projects. Working with them was interesting and funny.

Thanks to Frank Sönnichsen and all the spectroscopic division, always fast and ready to help me for any problems with measurements.

Thanks to Lisa Reck, the only brave student that did the OCF-3 in English with me.

Thanks to Prof. Sijbren Otto for his great work as coordinator of the Marie Curie Network. Naturally thanks to the EU for its support through the Marie Curie Research Training Network MRTN-CT-2006-035614 Dynamic Combinatorial Chemistry (DCC). Without this grant, this thesis would never have seen the light.

And always thanks to my parents and my brother.

At the end, thanks to you reader. If you are reading this line after the others, you at least read one page of my thesis. Thank You.

Abstract

In this thesis, the proof of concept of using a Dynamic Combinatorial Library (DCL) directly for a function is presented. The transport of ions mediated by a carrier amplified from a DCL was successfully achieved. A carrier macrocycle is formed directly by a DCL and then it transports calcium ions from a water source phase to a water receiver phase passing through synthetic organic membranes.

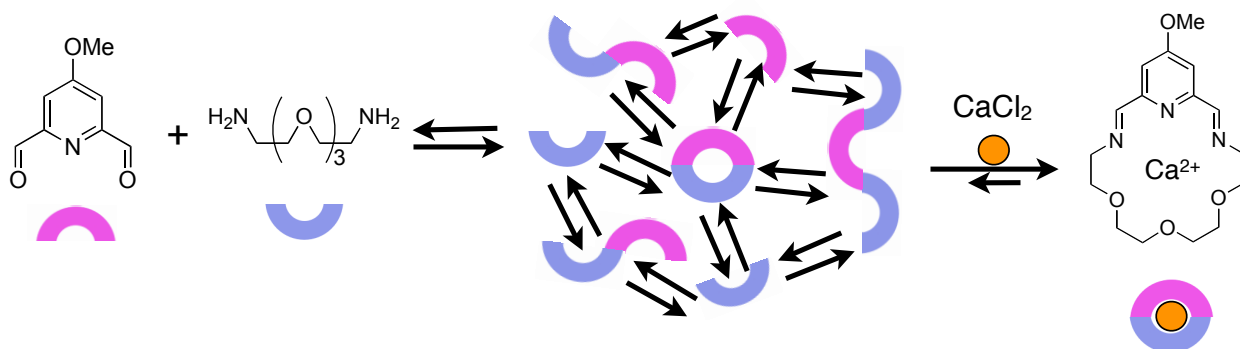

Proved for the first time, this goal was achieved in a series of experiments. First, the possibility of using a library composed of imines in water was studied. Then, the same dynamic combinatorial experiment was screened in a biphasic system.

Finally, the possibility of amplifying a macrocyclic carrier directly in a bulk membrane experiment was proven. A carrier was amplified from a DCL and the template was subsequently transported from the source phase to the receiver phase. The one step generation of a carrier from a library was successfully achieved.

The development of this idea was improved realizing a double screening methodology by a larger DCL. The template selects and amplifies two related macrocycles from the DCL, and in a second step, the membrane itself selects the macrocycle with the best carrier activity.

The proof of concept of DCL/transport was also tested using liposomes as mimic of a biological membrane.

In order to maintain the electroneutrality during the transport of ions, the counter-ions should be transported as well. Transporting an ion duplet or triplet should be easier and faster than transporting only the related ion. Therefore, a macrocycle was synthesized and its ability to bind calcium chloride as an ion triplet was proven.

Zusammenfassung

In dieser Arbeit wird der Aufbau und die direkte Verwendung einer dynamischen kombinatorischen Bibliothek dargestellt. Dabei konnte gezeigt werden, dass ein makrocyclischer Carrier, der direkt aus einer DCL gebildet wurde, Calciumionen aus der wässrigen Phase durch eine organische Membran in eine wässrige Phase transportiert. Diese Funktion konnte in einer Reihe von Experimenten zum ersten Mal erzielt werden.

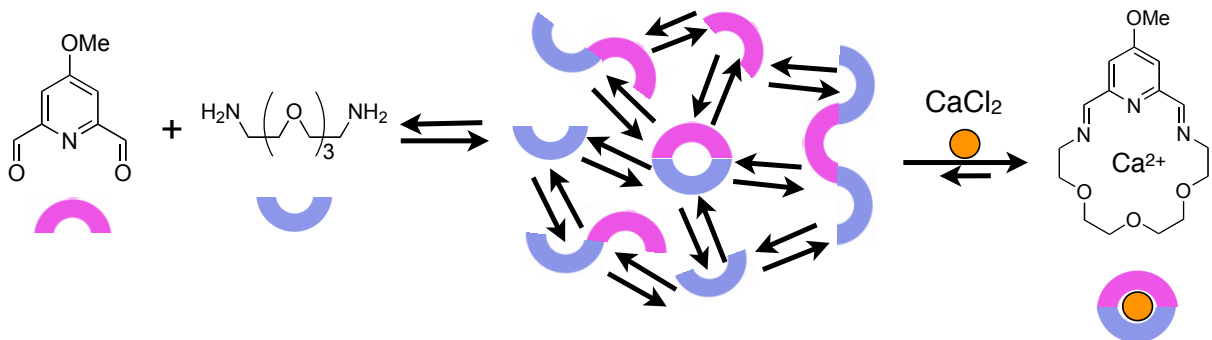

Zudem konnte eine Imin-Bibliothek in einer wässrigen Phase realisiert und untersucht werden. Anschließend wurde das gleiche dynamisch-kombinatorische Experiment in einem zweiphasigen System untersucht.

Schließlich konnte nachgewiesen werden, dass der makrocyclische Carrier den Transport durch eine Membran unterstützt. Der Carrier wurde durch eine DCL verstärkt und das Templat konnte danach über eine Phasengrenze hinweg transportiert werden. Dabei gelang es, einen Carrier erfolgreich in einem Schritt aus einer Bibliothek zu erhalten.

Diese Entwicklung konnte verbessert werden, indem eine größere DCL verwendet wurde. Dabei unterstützt das Templat die Bildung zweier verschiedener Makrocyclen, zudem selektiert die Membran bevorzugt den Carrier mit der besten Aktivität.

Zum Nachweis der erstellten DCL bzw. des Transports wurden zusätzlich Liposome als Modell einer biologischen Membran verwendet.

Um eine Elektroneutralität während des Transportes zu gewährleisten, müssen die Gegenionen ebenso transportiert werden. Der Transport eines Ionenpaares beziehungsweise eines Ionentriplets sollte einfacher und schneller erfolgen als der eines einfachen Ions. Hierzu wurde ein Makrocyclus synthetisiert, der in der Lage ist, Calciumdichlorid als ein Ionentriplet zu binden.

Table of Contents

1	Introduction	1
1.1	Supramolecular Chemistry	1
1.2	Dynamic Combinatorial Chemistry	3
1.2.1	Imines	5
1.2.2	The next step: Applications	8
2	Objective	10
3	Results and Discussion	12
3.1	Remarkable Stability of Imino Macrocycles in Water	13
3.2	On the Formation of Imines in Water, a Comparison	19
3.3	Transport of Calcium Ions through a Bulk Membrane by Use of a Dynamic Combinatorial Library	23
3.4	Ion Transport across Membranes Facilitated by a Dynamic Combinatorial Library	38
3.5	The First Supramolecular Ion Triplet Complex	58
4	Summary and Perspective	82
4.1	Summary	82
4.2	Perspective	84
5	References	86

1 Introduction

1.1 Supramolecular Chemistry

*“Atoms are letters, molecules are the words, supramolecular entities are the sentences and the chapters”.*¹ This brief sentence contains in itself the importance and the great fascination of supramolecular chemistry. The year was 1987. Jean-Marie Lehn, together with Donald J. Cram and Charles J. Pedersen, won the Nobel price *“for their development and use of molecules with structure-specific interaction of high selectivity”* (Fig. 1.1). Born by genial intuition and lucky accidental synthesis,² supramolecular chemistry has nowadays great importance in various and different fields in chemistry and industry.

Dibenzo - 18 -Crown - 6

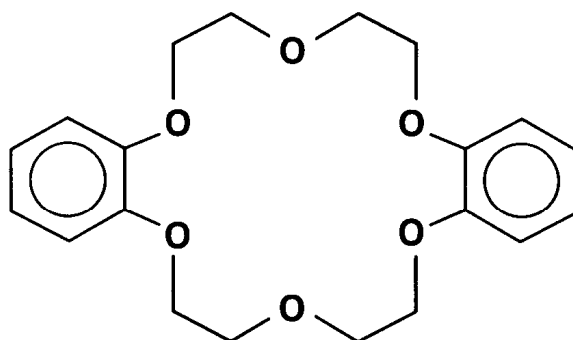

Figure 1.1: Original drawing from Charles J. Pedersen's Nobel Prize Lecture.³

Supramolecular chemistry was born as a branch of organic chemistry and slowly grew up as a highly interdisciplinary subject. It not only attracts chemists but also biochemists, biologists, engineers, physicists and theoreticians.⁴ Moreover it plays a crucial role in the development of new nanotechnologies.⁵ In a more poetic way we can say, without any doubt, that supramolecular chemistry “is life”.

In biological life, molecular recognition plays a key role in almost all processes with an amazing selectivity. This high selectivity is really difficult to reproduce in laboratories by synthetic hosts. Host-guest complexes possess great importance also in signaling and transport, moving in and out guests in different part of cells.

In everyday's life, supramolecular chemistry is even more present. Plastic materials completely changed our life, and now this branch is evolving in polymer and material

science. High-tech materials such as thermoplastics, solar panels, adhesives or new and resistant materials for artificial organs are based on supramolecular and polymer chemistry. These new materials can drastically improve our daily life. Also in pharmaceuticals, supramolecular chemistry is widely exploited. Cyclodextrines for example, thanks to their shapes and to the apolar binding site, are used since more than ten years in many pharmaceutical formulations in order to solubilize synthetic drugs.⁶ Moreover “smart materials”, molecular shuttles, motors and rotors are, in this first part of the 21st century the new era of supramolecules thanks to the work of J. Fraser Stoddart,⁷ David Leigh⁸ and Ben L. Feringa.⁹ Those are only a few applications of supramolecular chemistry.

In an oversimplified way, supramolecular core concepts are:

- Molecular Recognition: The formation of a complex takes place through recognition between guest species and host. The receptor should have, beyond a binding site, also a geometry and a three-dimensional structure complementary to the guest.
- Non Covalent Bonds: The forces between host and guest are non-covalent interactions. Examples of those forces are: ion-ion, ion-dipole or dipole-dipole interaction, hydrogen bonding, π - π stacking, Van der Waals forces and hydrophobic effects.
- Preorganisation: Often the host is rigidified in order to adopt the perfect conformation for the recognition of a specific guest. This preorganization leads to a high stability of the final host-guest complex.
- Self Assembly: A new macromolecule can be generated by spontaneous association of single molecules.

Since the birth of supramolecular chemistry, many host molecules have been synthesized. From crown and lariat ethers, podands, cryptands to calixarenes, cyclodextrines and then, to even more complex structures such catenanes, rotaxanes, foldamers or helicates.

The synthesis of host molecules for specific guests is usually long and difficult. Often the final product is only obtained by a multi-step synthesis, requiring various purification steps and many times also protection/deprotection steps. Once the host product is synthesized, it must be tested for the host-guest complexation. And this, unfortunately, is not always successful. In fact it is not rare, that the hard-won host does not bind the desired guest, or binds it with low affinity.

An alternative strategy to obtain a host for a specific guest, with less synthetic effort, was developed during the last twenty years in an emerging field: Dynamic Combinatorial Chemistry.

1.2 Dynamic Combinatorial Chemistry

Dynamic Combinatorial Chemistry (DCC) ¹⁰ is, by definition, combinatorial chemistry under thermodynamic control. In non-reversible combinatorial chemistry, a large number of different related products are synthesized from a mixture of different starting building blocks. The obtained products will not react with one another and the final composition of the library will not change. On the contrary, all members of a Dynamic Combinatorial Library (DCL) are in equilibrium and can be interconverted into one another changing the library composition. In order to achieve the interconversion, the link between the components of the dynamic library must be reversible. Pioneers with two different approaches were Jean-Marie Lehn and Jeremy K. M. Sanders.

Lehn's group in Strasbourg used DCC to cast a substrate (guest) for an enzyme (host). They describe "*casting consist in the receptor-induced assembly of a substrate that fits the receptor*". ¹¹ The use of DCC allows the guests in the library to interconvert into one another. The spontaneous guest diversity generation is then shifted mainly to one guest that will fit inside the enzyme pocket in what they call "*sort of (supra)molecular Darwinism*" (Fig. 1.2, a). In a few words, they discover an easy and efficient methodology to synthesize a perfectly fitting guest for a specific host.

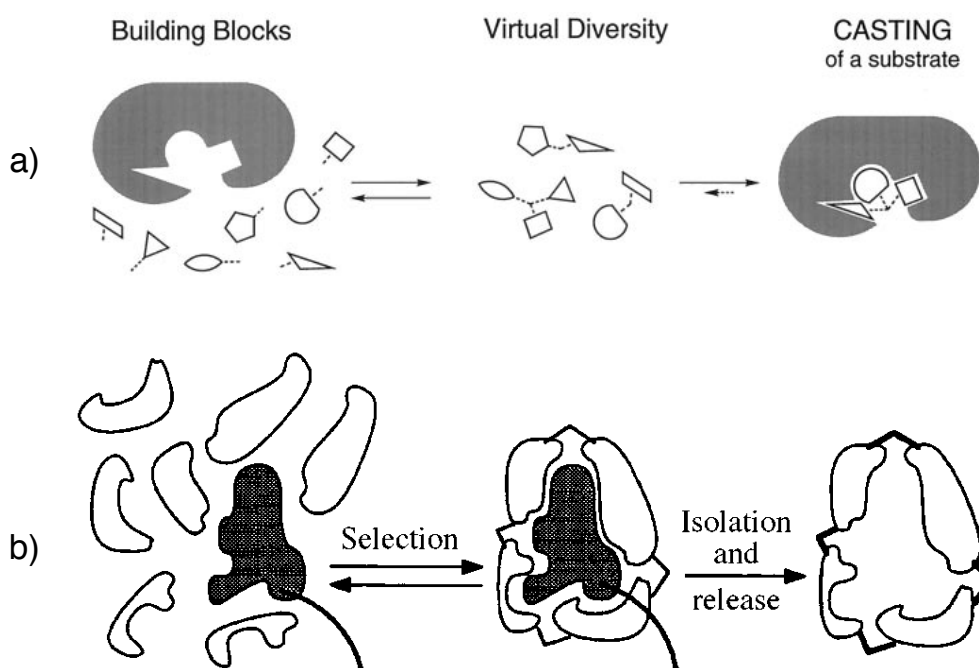

Figure 1.2: Original drawings from first experiments of Dynamical Combinatorial Chemistry. a) Casting of a substrate (guest) ¹¹ and b) selection of a host. ¹²

Using the opposite approach, Sanders' group in Cambridge used DCC in order to obtain a host for a specific guest.¹² In this case, the reaction of different building blocks gave various linear and macrocyclic products. To this resulting library was then added a guest. Perturbing the equilibrium by addition of a guest resulted in a different library composition. Thus the macrocycles that better bound the given guest were "amplified" to the detriment of other library members (Fig. 1.2, b).

Since then, dynamic combinatorial chemistry has evolved discovering and using different reversible covalent reactions [mainly used are imines,¹³ hydrazones¹⁴ and disulfides¹⁵ (Fig. 1.3), in our group there are also examples of boronic ester exchange^{16,17}], as well as non-covalent bonds (examples: metal-ligand exchange¹⁸ or hydrogen bond).¹⁹

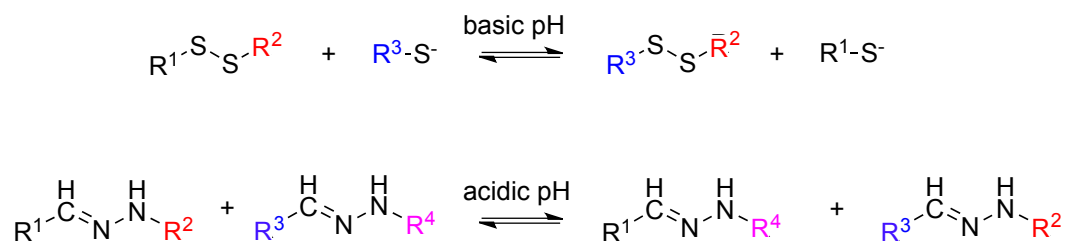

Figure 1.3: Two different reversible reactions: disulfide exchange (top) and hydrazone exchange (bottom). The disulfide reaction is reversible only at basic pH. Decreasing the pH will freeze the equilibration of the library due to the protonation of the thiolate to thiol. The hydrazone exchange, on the contrary, is reversible only at acidic pH. Increasing the pH will result in the frozen library. The residues Rⁿ are coloured only to enable the readers' eyes to see the exchange. However it is important to remember that the whole thiolic and hydrazide groups are involved in the exchange and not only the residues.

Moreover it was proven that two different reversible reactions can be carried out at the same time giving an "orthogonal" screening.²⁰ Without any doubt, the idea to synthesize perfect fitting guests for a specific host in one step (or other way round: to synthesize a perfect host for a specific guest) is intriguing and fascinating. Naturally in a novel field like this many problems arise. The DCL is in thermodynamic equilibrium, and small physical or chemical changes can affect the library distribution. In addition to this, it should be noted that the more complex the library is, the more difficult is its screening, and small changes in the library composition can sometimes be overlooked. However thanks to DCC many novel hosts have been discovered in the last years.

It is interesting to note that also only one building block can be used for setting up a dynamic combinatorial library. Various products can be amplified from this dynamic library using different templates. Starting from only one building block, it is possible to amplify various products (Fig. 1.4).

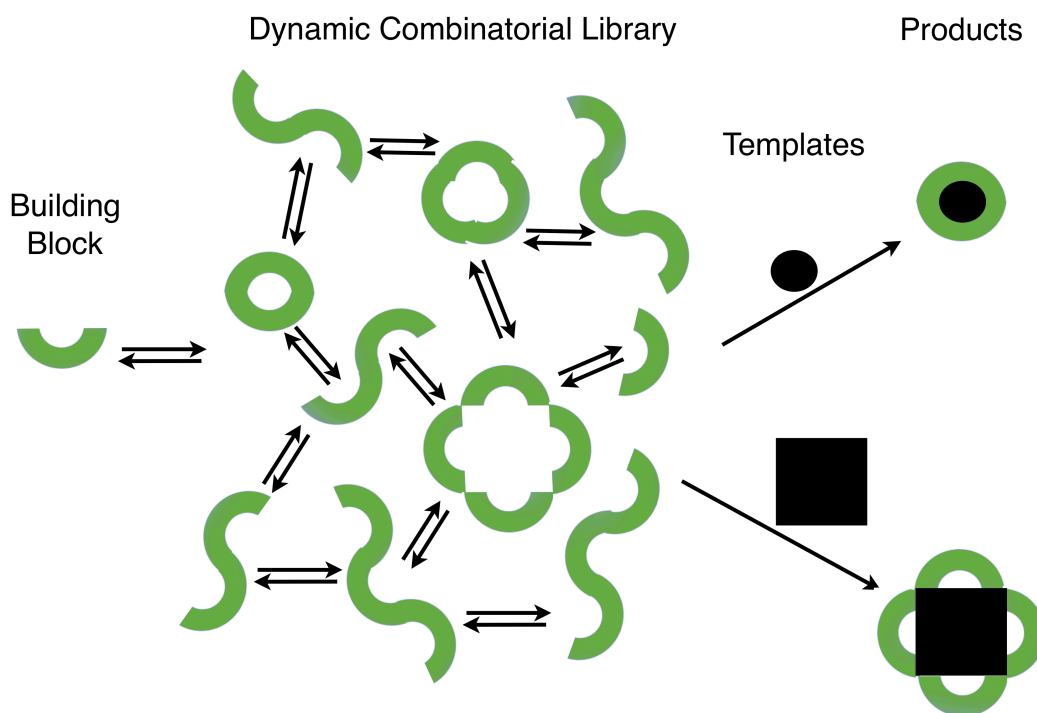

Figure 1.4: In Dynamic Combinatorial Chemistry, only one building block can react to give a Dynamic Combinatorial Library. All members of the dynamic library are in equilibrium one with another. The addition of a guest (solid black) shifts this equilibrium to the products that best bind it. Note that if only one building block is used, it must be a bifunctional molecule (for example dithiols).

Due to this great interest the European Commission fully granted a Marie Curie Research Training Network for Dynamic Combinatorial Chemistry. This Ph.D. research work and the author were funded through this European grant. Together with Kiel, nine other laboratories, in different European countries, were associated in the network with a common goal: bringing Dynamic Combinatorial Chemistry to the next step and train young European scientists in this novel field.

1.2.1 Imines

Imine exchange, with disulfide and hydrazone exchange, is one of the most used reversible reaction in Dynamic Combinatorial Chemistry. The condensation between aldehydes and amines is a reversible reaction. In order to obtain imines in good yield,

it is usually important to remove water. In fact the imine formation (from amine and aldehydes or ketones) is accompanied with the release of one molecule of water for each imine formed. In the DCC specific case hydrolysis plays an important role for the reversibility of the reaction. The freshly formed imines can be hydrolyzed and the starting material will be free to react again forming a different imine. Imines can also be interconverted by transimination.²¹

Beyond DCC, imines were and are still widely used for several reasons. Since their discovery by Hugo Schiff in 1864 (imines are also known as Schiff's bases)²² they found broad applications in organic and inorganic chemistry. The reason for this interest by organic chemists lies in the fact that condensation between aldehydes and imines is considered an easy reaction and that the generated imines can then be used as versatile key intermediates in various synthetic routes: from reductive amination^{23, 24} to multicomponent reactions like the Mannich²⁵ or the Ugi reaction.²⁶ The latter was also one of the first reaction used in (non reversible) combinatorial chemistry.²⁷

Inorganic imino-complexes with different transition metal ions are used since a long time as catalysts. Salen, salen-like complexes²⁸ and bis(imino)pyridines²⁹ are doing lion's share within the large plethora of related catalysts. Moreover imine formation is extensively used in macrocycle syntheses.^{30, 31}

Even when this reaction was exploited in a large number of syntheses, it has only recently become an essential part of Dynamic Combinatorial Chemistry. In 2002, Ole Storm elegantly demonstrated that imino-macrocycles can efficiently be synthesized from a Dynamic Combinatorial Library (Fig. 1.5).¹³ The reaction of a dialdehyde with diamino chains of different lengths produces various imino-macrocycles, oligo- and polymers.

Then using different alkaline earth metal ions, it is possible to shift the equilibria to mainly only one of the various products. Cations act as templates for the formation of the macrocycle amplifying the best binder and shifting all the other products of the library to it. Several products can selectively be obtained starting from a single Dynamic Combinatorial Library.

At the end of equilibration, imines are reduced to amines in order to "freeze" the dynamic library and to screen it. This step is necessary because imines usually are not stable enough to purification steps, some of them could easily be hydrolyzed giving back a different library composition during the screening. Unfortunately, once the imino-macrocycle is reduced to an amino-macrocycle it will not exactly be the amplified binder anymore as the imine is reduced to an amine.

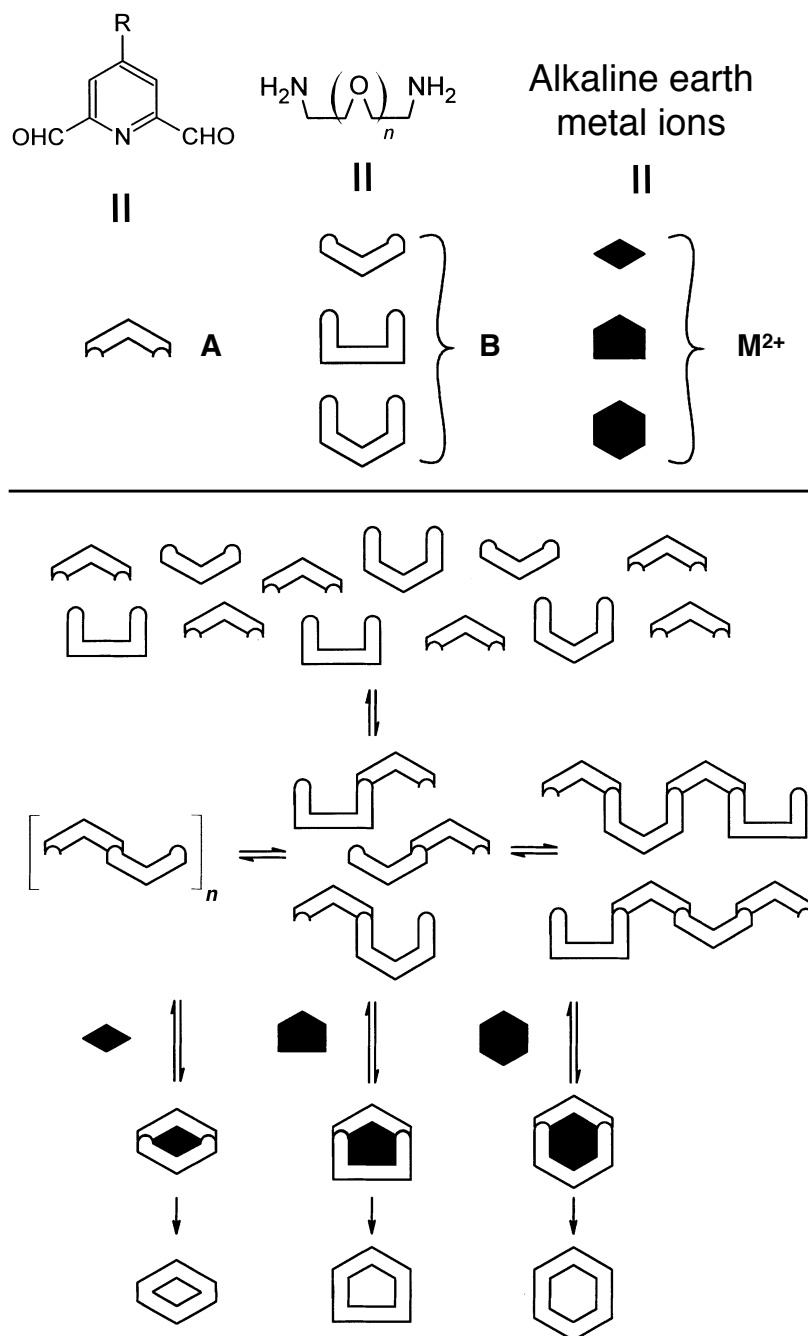

Figure 1.5: On top, starting materials used and their schematic representation. Dialdehyde **A** ($R = \text{OMe}$ and H), diamine **B** ($n = 2,3,4$) and various alkaline earth metal ions ($M^{2+} = \text{Mg}^{2+}, \text{Ca}^{2+}, \text{Ba}^{2+}$). On bottom, schematic representation of the dynamic combinatorial library. The equilibration forms different products. The addition of a guest (solid black) shifts the library towards the macrocycle that better binds it. Next, by reducing the imines to amines and removing the guest, free macrocycles are obtained.

Since Ole Storm's paper appeared in the literature, imine formation grows in importance as a reversible reaction in DCC. In the last decade, many publications appeared regarding DCLs made of imines.^{32,33,34} Related work was done by Vicente

Gotor's group in Oviedo. Starting from a library composed of pyridine-2,6-dicarbaldehyde and *trans*-cyclohexane-1,2-diamine they amplified different macrocycles (dimer and trimer) using various cations.³⁵

A few years later they discovered a diastereoselective amplification from a DCL of macrocyclic oligoimines. Using cadmium ions they were able to shift the equilibria to one major product as a single diastereomer from a mixture of stereochemically different species.³⁶

Although many different DCLs were exploited and many receptors were discovered and synthesized using this methodology, the “*road to fulfilling the promise*” of using DCC for new areas of application is still long.³⁷

1.2.2 The next step: Applications

At the beginning of this thesis, DCLs were mainly applied in order to synthesize the “best binder” for a specific guest. It was time to move on to the next step, namely applications. Few publications appeared in recent years describing the use of a Dynamic Combinatorial Library directly for a function instead of single purified products.^{38,39,40,41} This perspective is growing in importance day after day.⁴² Without spoiling the rest of this thesis during the introduction, it is gratifying to state here that we were the first,⁴³ in parallel to Jeremy Sanders' group in Cambridge,⁴⁴ to use directly a dynamic combinatorial library for the screening of a transport carrier. Transport of molecules from a source phase to a receiver phase passing through a membrane is a remarkable task but usually difficult to achieve. In nature this task is done in various ways, from channels to carriers (Fig. 1.6) and by various mechanisms like passive or active transport.⁴⁵

Those channels and carriers are relevant in cells, where the concentrations of metabolites, salts and pH make the difference between life and death. Chemists have, since a long time, tried to mimic and understand transport in nature by studying synthetic membranes and carriers or channels.

Various biological membrane mimics were used in order to understand how the transport works. Nowadays a number of membranes have been used and studied: bulk membrane, supported liquid membrane and liposomes (see pg. 34 for bulk membrane experiment set-up, and pg. 46 for supported liquid membrane experiment set-up). Each of those membranes has its weak and strong points. For example, if it is possible to use a bulk membrane for months, it will be difficult doing the same with the more fragile liposomes.

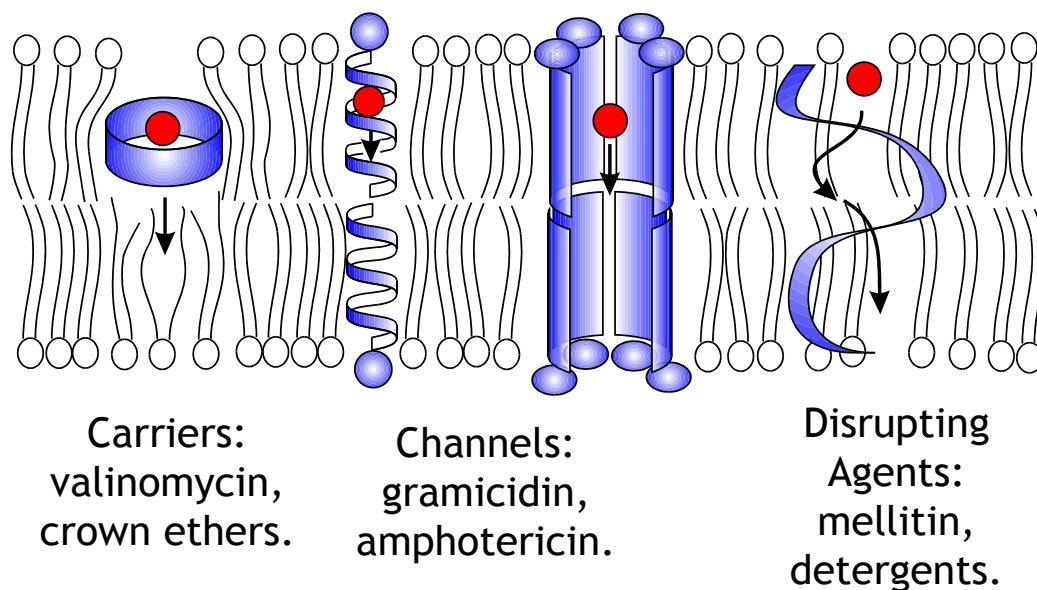

Figure 1.6: Schematic representation of carriers, two different self assembled channels, and disrupting agents. ⁴⁶

Parallel to studying different membranes, the focus laid also on synthesizing artificial channels and carriers.

Channels and carriers have great importance in many different fields. Ion sensors are mainly based on carriers immobilised in a polymeric film. When in contact with a fitting ion, it will be transported across the polymeric film to the detector, signalling the presence of the ion. Using a specific carrier for a given ion is also helpful in the cleaning of wastewater (for example to remove toxic transition metal ions or radioactive particles) or for blood dialysis. Moreover as stated a couple of pages above (Ch. 1.1), drug delivery is one of the major research lines in pharmaceutical industries with a special focus on targeting. Even if we do have effective drugs against cancer, this is still one of the worst diseases nowadays. The main problem of those anti-cancer medicines is that they are not target specific. Those drugs will simply “kill” indistinctly different cells, both diseased and normal cells.

For in vivo imaging, small molecules are easily accessible but it is important to deliver them to the right cell that needs to be screened, otherwise they become useless. For those reasons, it is essential to focus on the synthesis of water soluble carriers for a specific guest. It is also notable to modify it in order to recognize or be recognized by a targeted cell. These two tasks are usually translated into hard bench work in order to synthesize the carrier step by step and to optimize it. To overcome and simplify this task, this thesis shall explore the possibility of using directly a Dynamic Combinatorial Library in order to screen for a specific carrier.

2 Objective

By the use of Dynamic Combinatorial Chemistry (DCC), it is possible to synthesize in one step the host that best binds a specific guest used as a template. Moreover from a single Dynamic Combinatorial Library (DCL), a number of products can be amplified using various templates. The advantages of using the DCC instead of a step by step synthesis is clear. In a schematic summary, the differences between the two approaches are even more evident (Fig. 2.1).

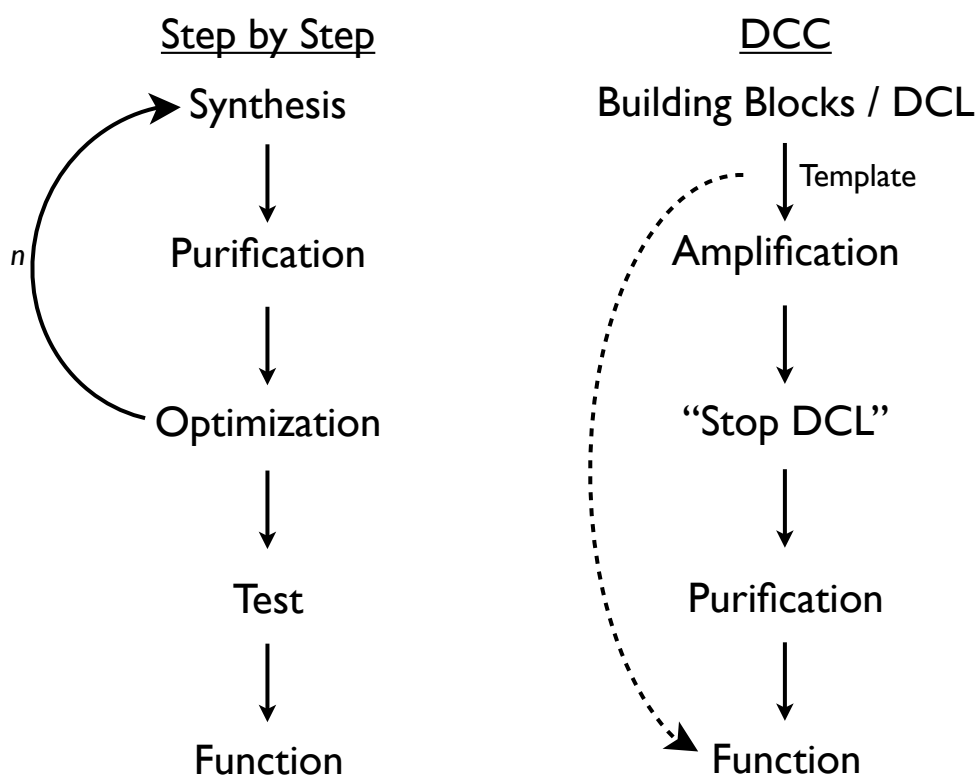

Figure 2.1: Schematic representation of a step by step synthesis (left) for n synthetic steps, and Dynamic Combinatorial Chemistry (right). This thesis will study whether it will be possible to screen for a function directly by the use of a dynamic library (right, dashed arrow).

In a step by step synthesis (Fig 2.1, left), every single intermediate of the synthetic route must be synthesized and purified. Usually the first reaction tried does not work with 90% of yield immediately. It is then necessary to carry out some optimization work to find out the best reaction conditions. All of these steps must be done n times in a multi-step synthesis. At the end of hard bench-work, it is finally possible to test the product for an application.

On the contrary in the DCC approach (Fig 2.1, right), the building blocks are mixed, the template is added and the mixture is left to equilibrate. When, and if, an amplification occurs, it is necessary to stop the equilibration and to purify the final amplified product. At this point, the product is ready to be tested for an application.

The main goal of this thesis is bringing DCC one step further: to use a DCL directly to screen for a function. In this way it should be possible to skip several steps in the DCC flowchart (Fig. 2.1, right, dashed arrow).

Using the dynamic library directly instead of a purified product should result not only in an amplification of a product, but in an amplification of a product able to perform a task. The benefit of synthesizing a product for an application in only one step is, without any doubt, attractive.

Many functions are not yet screened by a DCL and this thesis focuses on transport as the function. DCC is still young and there are no proofs of using a library in order to amplify a carrier for transport. To achieve this goal it is wise starting from a well known DCL. It is based on imines and it was used in our laboratory.¹³ As a first guest to be transported, calcium ion was chosen. This ion was used in a previous investigation and its ability to shift a specific imine DCL was already proved.¹³ In general, this proof of concept can be possible for many ions and guest molecules.

For a good and full study of using a DCL to amplify a carrier, various test must be done. First of all, it is necessary to study the stability of imines in water and how the ionic guest influences this stability. After this, the dynamic library must be tested directly in presence of different synthetic membranes such as bulk membranes, supported liquid membranes and liposomes. Another interesting task will be the set up of a double screening experiment: When more than only one product is amplified from a DCL which one will perform a better transport?

Moreover, in order to prove once more the simplicity of the proposed methodology, only a few building blocks (commercially available or easily synthesizable) shall be used to set up the libraries.

3 Results and Discussion

Dynamic Combinatorial Chemistry (DCC) has gained large interest since its discovery. Using Dynamic Combinatorial Libraries (DCLs), it is possible to synthesize a host for a template guest in only one step. However the direct application of a DCL instead of a single isolated product is hardly investigated at all.

This Ph.D. thesis shall investigate the proof of concept of using a DCL for the screening and the amplification of a carrier. The main question is if this latter, directly obtained from the DCL, will be able to transport ions from a water source phase to a water receiver phase through synthetic organic membranes? The methodology of this screening is hitherto unknown in literature and it must be proved for the first time in a series of different experiments.

This chapter summarizes five publications obtained as part of the Ph.D. thesis work. Each publication has its own introduction page.

The first two publications treat the role of water in imine synthesis. In the first one, the stability of various imine products is tested and the influence of a template ion on their stability is discussed (Ch. 3.1). During this work, a big discrepancy about synthesis of imines in pure water was found in the literature. The explanation of this discrepancy and its solution is described in chapter 3.2.

The third publication presents the first example of using a Dynamic Combinatorial Library to screen for a carrier. Using a bulk membrane and a dynamic library, it is possible to amplify a macrocyclic carrier. This latter transports the template ion from an aqueous source phase to an aqueous receiver phase passing through an organic solvent membrane (Ch. 3.3).

A further development is in the fourth publication: the double screening methodology. In a first stage, the template amplifies two similar macrocycles from the dynamic library. Subsequently, the membrane itself discriminates between these related macrocyclic carriers to find the best one (Ch. 3.4).

When cations are transported, one way to keep the electroneutrality of the system, is transporting anions simultaneously. If a macrocycle is designed for complexing cations, the transport of the counter-ions is not easy. Mainly because this latter, during the transport, is not shielded at all from organic solvent. For this reason a study was started by using a macrocycle that binds both ion and counter-ion. The fifth publication is the first description of an ion triplet complex (Ch. 3.5).

3.1 Remarkable Stability of Imino Macrocycles in Water

V. Saggiomo, U. Lüning, *Eur. J. Org. Chem.*, **2008**, 4329-4333.

Water plays an important role in the DCC of imines. Hydrolysis of imines is one of the possible pathways for an imine exchange: the reaction of the imine with water to give back the aldehyde which then can react with a second amine. The study of the following publication was set up to test the stability of imines at different percentages of water. Three different compounds were synthesized and left in methanol to equilibrate using calcium ions as template. After equilibration, various amounts of water were added. The NMR spectra were recorded after each addition in order to check the stability to hydrolysis. Three different amines were chosen. One has the proper length to form a good host for complexing calcium ions (Fig. 3.1, a). One is a longer diamine but with the same number of donor atoms (Fig. 3.1, b). The last one forms a product that has almost no affinity to the template (Fig 3.1, c). All NMR experiments show that one (bis)imino pyridine (Fig. 3.1, a) is extremely stable to water at room temperature also for one week. In pure water, this macrocycle can be obtained in good yield when 2 equivalents of template are used.

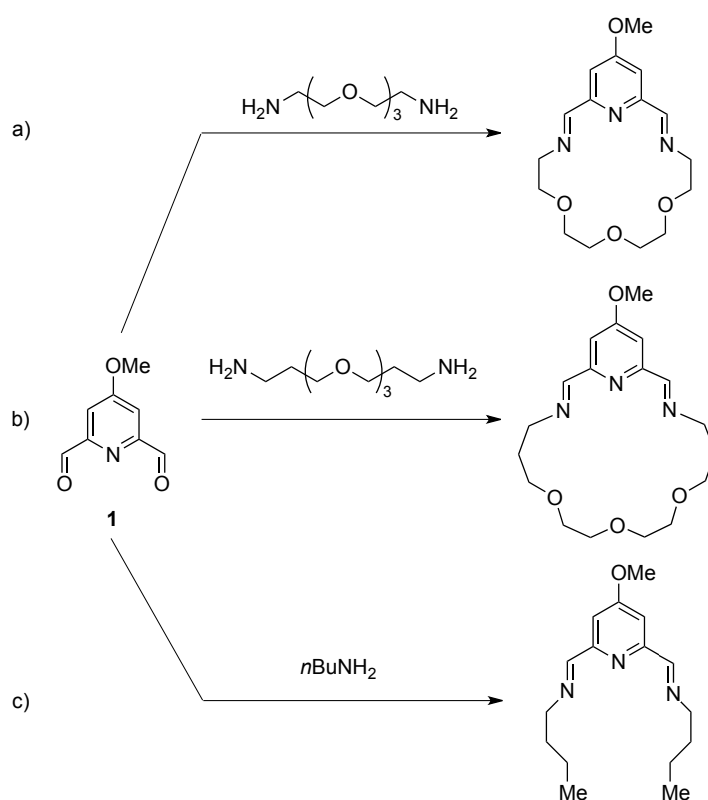

Figure 3.1: Schematic representation of the experiments. The syntheses were done in MeOD and then, different aliquots of D_2O were added to test the stability of the three different products (on the right). For the two macrocycles, different amounts of CaCl_2 as template were used.

Remarkable Stability of Imino Macrocycles in Water^[‡]

Vittorio Saggiomo^[a] and Ulrich Lüning^{*[a]}

Keywords: Combinatorial chemistry / Imines / Macrocycles / Pyridine / Templates

Imines **3**, **5** and **7** generated from 4-methoxypyridine-2,6-dicarbaldehyde (**1**) and several amines **2**, **4** and **6** show a remarkable stability in water. The 18-membered macrocyclic diimine **5** is stable and could be synthesized in good yield by using 2 equiv. of calcium ions as template in pure water, and even the non-macrocyclic diimine **3** survives in water/meth-

anol (50:50) without any template effect. In a mixture of pyridinedicarbaldehyde **1** and two glycol-derived diamines **4** and **6**, a calcium template ion selects the 18-membered macrocycle **5** over the 20-membered one (**7**).

(© Wiley-VCH Verlag GmbH & Co. KGaA, 69451 Weinheim, Germany, 2008)

Introduction

Macrocyclic structures have gained enormous attention over the past decades.^[1] However, macrocycles are not as easily prepared as five- or six-membered rings,^[2] and thus special approaches have been developed for better syntheses. For kinetically controlled macrocyclizations, the use of the high-dilution technique^[3] often increases yields considerably, whereas in thermodynamically controlled reactions, the template effect has proven to be the proper tool to shift the equilibrium to the desired product.^[4–6] Many applications of macrocycles including the metal-ion-complexing abilities of crown ethers make use of *endo* functionalities. Therefore, it is self-evident that these functionalities can be exploited in the macrocyclic assembly process.^[7] Unlike in a kinetically controlled reaction, the products of a thermodynamically controlled reaction are interconverted into one another constantly. The composition of the product mixture is depending on the relative thermodynamic stability of the products. The mixture is dynamic. If poly-functional molecules or several starting materials are used, numerous different combinations are conceivable, and usually mixtures are formed. For these situations, the term dynamic combinatorial chemistry (DCC) has been coined.^[8–11] Since decades,^[4] the imine formation has been used to synthesize macrocycles, and templates have been found to shift the equilibria of the dynamic combinatorial libraries towards one product in good yield. Dynamic combinatorial libraries have been investigated by starting from a dialdehyde and one^[12,13] or several^[14] diamines. The coordinative bond between a transition-metal ion and an imine

leads to an increased stability of the imines even in water.^[15] But in general, imines are rather unstable and are hydrolyzed quickly if water is present.^[16–18] However, converse results have also been reported.^[19] In the DCC synthesis of macrocyclic imines, too, the sensitivity against water has to be investigated for several reasons: (i) every formation of an imine from an aldehyde and an amine forms a water molecule, (ii) the template salts often contain water,^[14,20] (iii) the reactions are usually not carried out under strict exclusion of moisture and (iv) the hydrolysis plays an important role in the reversibility of the imine bond formation.^[21]

Results and Discussion

Due to the instability of imines under the conditions of many standard purification techniques, the analysis of an imine library is rarely^[22] performed on the imine mixture itself but usually done by investigating the amine mixture obtained by reduction of the imines.^[14] Besides HPLC-MS,^[22] one other direct method to monitor the equilibrium is the observation of the imines by NMR spectroscopy. In this work, dynamic combinatorial libraries (DCL) derived from pyridine-2,6-dicarbaldehyde **1** and various diamines such as **2**, **4** or **6** have been investigated by ¹H NMR spectroscopy. One prerequisite for the analysis is the use of a 4-substituted pyridine-2,6-dicarbaldehyde such as 4-methoxypyridine-2,6-dicarbaldehyde (**1**) because the pyridine hydrogen atoms of 2,4,6-trisubstituted pyridines show a sharp singlet in the NMR spectra. If the dynamic combinatorial library gives a manageable number of products, their relative ratio can be determined by integration of these pyridine 3,5-H peaks. Quantitative measurements are possible if an internal standard (for instance dimethyl terephthalate, DMT) is added. Many components of a library can also be detected by ESI mass spectrometry, although no quantitative analysis is possible by this analytic technique. In the

[‡] Dynamic Combinatorial Chemistry, 2. Part 1: Ref.^[14]

[a] Otto-Diels-Institut für Organische Chemie,
Christian-Albrechts-Universität zu Kiel,
Olshausenstr. 40, 24098 Kiel, Germany
Fax: +49-431-880-1558
E-mail: luening@oc.uni-kiel.de

FULL PAPER

V. Saggiomo, U. Lüning

present study, three different amines [*n*-butylamine (**2**), a triethylene glycol derived diamine **4** and a bis(homo) analogue **6**] have been used. From the resulting imines **3**, **5** and **7**, only the largest macrocycle **7** was well detected by ESI [$M + H^+$], whereas the smaller macrocycle **5** appeared as an $[M + Ca^{2+}]/2$ signal, and the butyl compounds could not be detected at all (Figure 1).

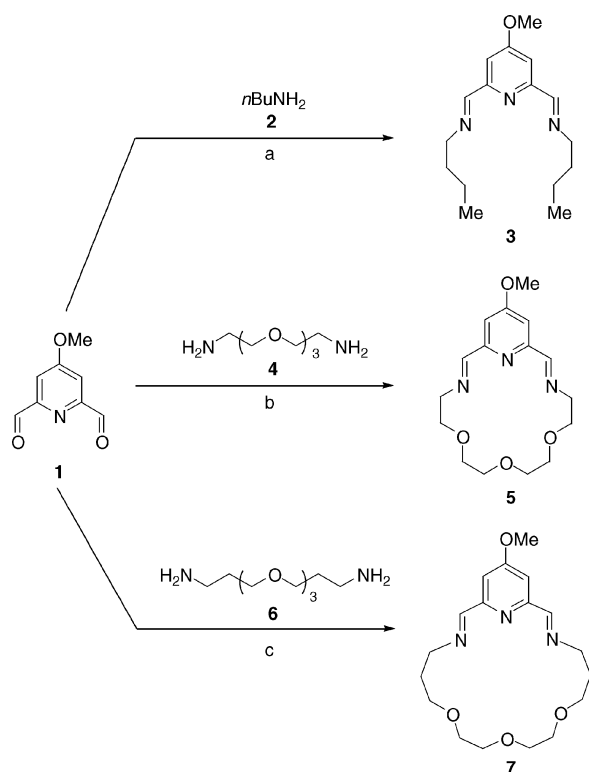

Figure 1. (a) CD_3OD/D_2O in various ratios, 12 h, room temp.; (b) CD_3OD/D_2O in various ratios with 1 equiv. of $CaCl_2$, 12 h, room temp., and pure D_2O with various equiv. of $CaCl_2$, 12 h, room temp.; (c) CD_3OD/D_2O in various ratios with 1 equiv. of $CaCl_2$, 12 h, room temp.

However, all three compounds gave nice and clear signals in the NMR spectra, well distinguishable from each other or from oligomer signals. The individual imine synthesis, as well the imine-based libraries, usually is carried out in methanol,^[6,20,14] and consequently the reaction of 4-methoxypyridine-2,6-dicarbaldehyde (**1**) with *n*-butylamine (**2**) gave the respective diimine **3** in good yield. Increasing percentages of water reduced the yield of **3** as could be deduced from the integrations of the respective signals in the NMR spectrum (Figure 2, for instance NH_2CH_2 of the free butyl chains at $\delta = 2.7$ ppm, and CH of the aldehyde in its hydrate or hemiacetal form at $\delta \approx 5.5$ ppm). If more than 50% of water was added, the solvent became too polar to dissolve the starting materials completely. However, the diimine **3** proved to be rather stable, and 68% of it was still detected when the solvent contained 50% of water. Next, the formation of macrocyclic diimine **5** was investigated in the presence of 1 equiv. of calcium ions. In methanol with various percentages of water, no change in the composition could

be detected. With 50% of water, still 90% of macrocycle **5** exists. This surprising stability led us to an experiment in pure water by using various amounts of templating calcium ions. In pure water, the quantitative analysis of the NMR signals against the standard DMT cannot be carried out anymore due to DMT's insolubility, but, to calculate the yield, the intensities of the imine peak and the aldehyde peak can be compared according to literature.^[16] With 1 or less equiv. of calcium ions, the reaction mixture was not a solution, but a suspension, due to the fact that aldehyde **1** does not have sufficient solubility in water.

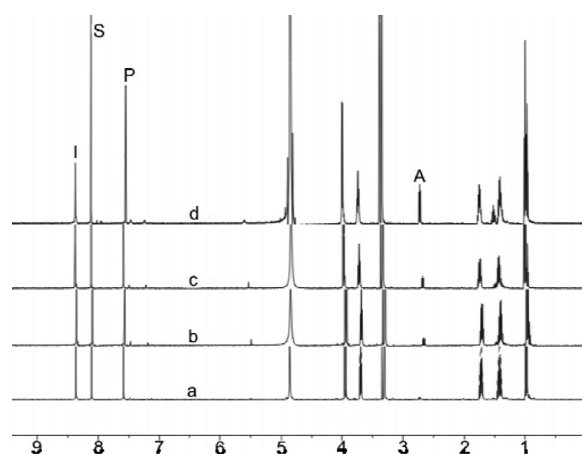

Figure 2. 1H NMR spectrum (500 MHz, 298 K) of imine **3** in: (a) CD_3OD , (b) CD_3OD/D_2O , 98:2, (c) CD_3OD/D_2O , 90:10, (d) CD_3OD/D_2O , 50:50. All ratios are expressed in v/v. Capital letters indicate prominent resonances: I = imine, S = DMT, P = pyridine, A = free amine chain.

However, with 2 equiv. of calcium ions, the solution became clear, and only one product **5**, as the calcium complex, was detected (Figure 3). Thus, even in water, a calcium ion stabilizes the macrocyclic diimine **5** to such an extent that it becomes the only product! In contrast to the stabilization of a macrocycle by transition-metal ions, which bind donor atoms by coordinative bonds, here, the interactions between the calcium ion and the donor atoms of the macrocycle are predominantly dipole-ion interactions. But these interactions are strong enough to withstand the competing solvation by 55 M water, and macrocycle **5** is found exclusively.

The reaction with the longest diamine **6**, which contains two aminopropylene groups instead of aminoethylene ones, gave less clear results. Also in methanol, the macrocyclic diimine **7** was formed in good yield (Figure 4a) and could be analyzed by ESI mass spectrometry or NMR spectroscopy. However, in contrast to the macrocycle formation of **5**, the addition of water disturbs the formation of the macrocyclic diimine **7** (Figure 4). The NMR signals broaden, and increasing amounts of free diamine **6** appear. But also in this case, the addition of templating calcium ions favors the formation of the macrocycle, and for instance with 10 equiv. of $CaCl_2$ in CD_3OD/D_2O (50:50), only the signals of the macrocycle **7** were observed again.

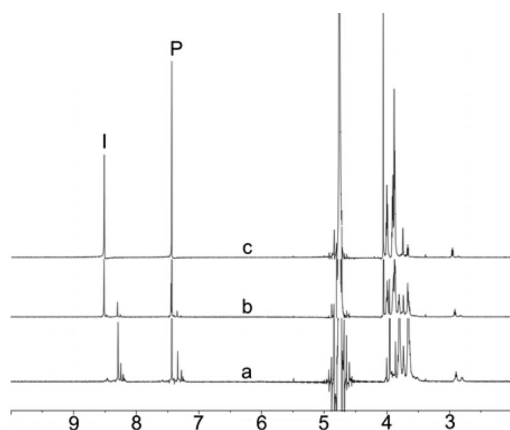

Figure 3. ^1H NMR spectrum (500 MHz, D_2O , 298 K). Synthesis of imine **5** in pure D_2O with: (a) no CaCl_2 , (b) 1 equiv. of CaCl_2 , (c) 2 equiv. of CaCl_2 . Capital letters indicate prominent resonances: I = imine, P = pyridine.

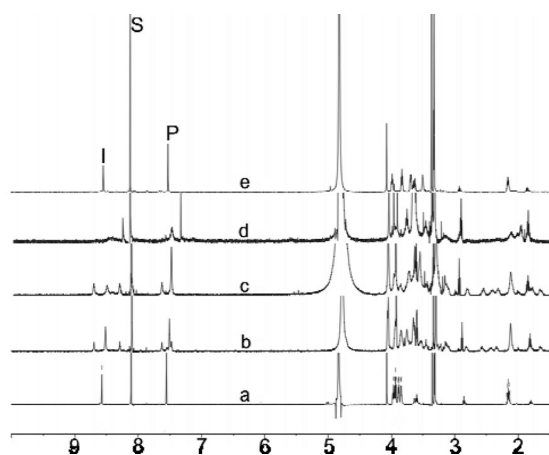

Figure 4. ^1H NMR (500 MHz, 298 K) of imine **7** in: (a) CD_3OD , (b) $\text{CD}_3\text{OD}/\text{D}_2\text{O}$, 98:2, (c) $\text{CD}_3\text{OD}/\text{D}_2\text{O}$, 90:10, (d) $\text{CD}_3\text{OD}/\text{D}_2\text{O}$, 50:50, (e) $\text{CD}_3\text{OD}/\text{D}_2\text{O}$, 50:50, and 10 equiv. of CaCl_2 . All ratios are expressed in v/v. Capital letters indicate prominent resonances: I = imine, S = DMT, P = pyridine.

Finally, we investigated a dynamic combinatorial library derived from the dialdehyde **1** and both diamines **4** and **6**. In the first experiment, a mixture of CaCl_2 , dialdehyde **1** and the propylenediamine **6** was prepared, and the respective imines were allowed to form. Then, 5% of water and 1 equiv. of ethylenediamine **4** were added one after the other, and each mixture was analyzed by NMR spectroscopy (Figure 5). First, the typical broadening of the signals of the propylenemacrocycle **7** appeared (see Figures 4 and 5b), and after addition of **4**, the most stable macrocyclic diimine **5** was formed exclusively (shift of imine peak from $\delta = 8.60$ to 8.64 ppm), and free propylenediamine **6** was detected (see for instance $\text{CH}_2\text{CH}_2\text{CH}_2$ of the free amine chain: $\delta = 1.75$ ppm), proving the formation of the more stable 18-membered macrocycle in this dynamic combinatorial library.

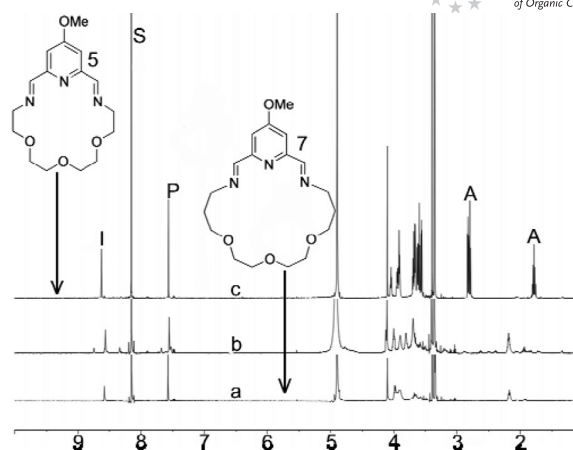

Figure 5. Exchange experiment. (a) 1 equiv. of dialdehyde **1**, 1 equiv. of diamine **6**, and 1 equiv. of CaCl_2 in CD_3OD give the macrocyclic diimine **7**; (b) addition of 5% of D_2O interferes with the exclusive formation of **7**; (c) after addition of diamine **4** and equilibration for 12 h, the most stable diimine complex **5** is exclusively formed on the cost of the larger macrocycle **7** with liberation of diamine **6**. Capital letters indicate prominent resonances: I = imine, S = DMT, P = pyridine, A = free amine chain.

Conclusions

Even in water, the macrocyclic diimine **5** can be formed in excellent yields, provided that enough calcium ions are present. These have two functions: they stabilize this product by their template effect and they solubilize the complex by the introduction of charge. But not only the templating of the macrocycle contributes to the remarkable stability of diimine **5** in water. Even the non-macrocyclic diimine **3** is still formed in good yield in a solvent mixture containing 50% of water and 50% of methanol. This stability is probably caused by the pyridine unit and its conjugation with the imine groups.^[23]

Experimental Section

General Remarks: *n*-Butylamine (**2**), 4,7,10-trioxa-1,13-tridecanediamine (**6**), and sodium cyanoborohydride were obtained commercially from Fluka and used without further purification. 4-Methoxypyridine-2,6-dicarbaldehyde (**1**)^[20] and 3,6,9-trioxa-1,11-undecanediamine (**4**)^[20] were synthesized according to literature procedures. NMR spectra were recorded with Bruker DRX 500 or AV 600 instruments. Assignments are supported by COSY, HSQC and HMBC. All chemical shifts were referenced to the residual proton (^1H) or carbon (^{13}C) signal of the solvent [CD_3OD , $\delta = 3.35$ (^1H), 49.0 (^{13}C) ppm]. Mass spectra were recorded with a Finnigan MAT 8200 or MAT 8230. ESI mass spectra were recorded with an Applied Biosystems Mariner Spectrometry Workstation.

General Procedure for the Preparation of Stock Solutions: To solutions of 4-methoxypyridine-2,6-dicarbaldehyde (**1**, 9.6 mg, 0.058 mmol), dimethyl terephthalate (DMT, 5.6 mg, 0.029 mmol) and CaCl_2 (6.4 mg, 0.058 mmol) in CD_3OD (5 mL), various diamines **2**, **4** or **6** (1.05 to 1.5 equiv.) were added. The solutions were stirred at room temp. for 12 h and were then transferred into NMR tubes with various percentages of D_2O . These solutions were al-

FULL PAPER

V. Saggiomo, U. Lüning

lowed to stand for at least 4 h in order to equilibrate. In another set of experiments, water was added before the amines to start the reaction in aqueous media. The final volume for all NMR experiments was 600 μL , the tube's atmosphere was replaced with nitrogen, and the tubes were capped with Teflon caps.

2,6-Bis(*n*-butyliminomethyl)4-methoxypyridine (3): A stock solution was prepared as follows: 4-methoxypyridine-2,6-dicarbaldehyde (**1**, 5 mg, 0.03 mmol) and DMT (2.15 mg, 0.011 mmol) were dissolved in CD_3OD (2.5 mL). *n*-Butylamine (**2**, 6.2 μL , 0.063 mmol) was added, and the solution was stirred at room temp. for 12 h. Then, various percentages of water (2%, 10%, 50% v/v) were added, and ^1H NMR spectra were recorded after 4 h. Yields calcd. from the ratio between signals of aromatic protons of DMT [$\delta = 8.15$ (s, 4 H), 3.97 (s, 6 H) ppm] and imine protons: pure CD_3OD : 91%, 2% D_2O : 88%, 10% D_2O : 71%, 50% D_2O : 68%. ^1H NMR (600 MHz, 298 K, CD_3OD) of **3** in the mixture: $\delta = 8.40$ (t, $J = 1.2$ Hz, 2 H, CH=N), 7.62 (s, 2 H, Py), 4.00 (s, 3 H, OMe), 3.77 (m, 4 H, CH=NCH₂), 1.76 (quint, $J = 6$ Hz, 4 H, N=CH₂CH₂CH₂CH₃), 1.45 (m, 4 H, N=CH₂CH₂CH₂CH₃), 0.98 (t, $J = 7.8$ Hz, 6 H, CH₃) ppm. ^{13}C NMR (150 MHz, 298 K, CD_3OD): $\delta = 168.79$ [C-2,6 (Py)], 163.09 (CH=N), 157.04 [C-4 (Py)], 109.43 [C-3,5 (Py)], 61.88 (N=CH₂), 56.38 (OMe), 33.77 (CH₂CH₂CH₂), 21.38 (CH₂CH₃), 14.12 (CH₃CH₃) ppm. HRMS: calcd. for $\text{C}_{16}\text{H}_{25}\text{N}_3\text{O}$ 275.19977, found 275.19992; calcd. for $\text{C}_{15}^{13}\text{CH}_{25}\text{N}_3\text{O}$ 276.20313, found 176.20323.

1⁴-Methoxy-6,9,12-trioxa-3,15-diaza-1(2,6)-pyridinahexadecacyclophan-2,15-diene (5): (a): A stock solution was prepared as follows: 4-methoxypyridine-2,6-dicarbaldehyde (**1**, 8.7 mg, 0.052 mmol), DMT (6.2 mg, 0.032 mmol), and CaCl_2 (5.7 mg, 0.052 mmol) were dissolved in CD_3OD (5 mL). 3,6,9-Trioxa-1,11-undecanediamine (**4**, 10.9 mg, 0.057 mmol) was added, and the solution was stirred for 12 h. Various percentages of water (2%, 10%, 50%) were added to different tubes, and ^1H NMR spectra were recorded after 5 h. Yields calcd. from the ratio between signals of aromatic protons of DMT [$\delta = 8.15$ (s, 4 H), 3.97 (s, 6 H) ppm] and imine protons: CD_3OD : 92%, 2% D_2O : 90%, 10% D_2O : 90%, 50% D_2O : 90%. ^1H NMR (600 MHz, 298 K, CD_3OD) of **5** in the mixture: $\delta = 8.64$ (t, $J = 1.2$ Hz, 2 H, CH=N), 7.58 (s, 2 H, Py), 4.11 (s, 3 H, OMe), 4.05 (t, $J = 4$ Hz, 4 H, CH=NCH₂), 3.96–3.91 [overlapping signals, 12 H, (CH₂OCH₂)₃] ppm. ^{13}C NMR (150 MHz, 298 K, CD_3OD): $\delta = 169.87$ [C-2,6 (Py)], 163.45 (CH=N), 153.05 [C-4 (Py)], 113.82 [C-3,5 (Py)], 70.92, 70.04, 69.74, 69.36, 69.05, 68.72 [(CH₂OCH₂)₃], 56.90 (N=CH₂), 55.92 (OMe) ppm. HRMS: calcd. for $\text{C}_{16}\text{H}_{23}\text{N}_3\text{O}_4$ 321.16885, found 321.16899; calcd. for $\text{C}_{15}^{13}\text{CH}_{23}\text{N}_3\text{O}_4$ 322.17221, found 322.17218. (b): A stock solution was prepared as follows: 3,6,9-trioxa-1,11-undecanediamine (**4**, 10.9 mg, 0.057 mmol) was added to a solution of 4-methoxypyridine-2,6-dicarbaldehyde (**1**, 8.7 mg, 0.052 mmol) in D_2O (5 mL). Then various equivalents of CaCl_2 were added to the solution in different NMR tubes, and the solutions were left to equilibrate for 12 h. Then the ^1H NMR spectra were recorded. ESI-MS (positive ions) of the water solution with 2 equiv. of CaCl_2 : calcd. for $\text{C}_{16}\text{H}_{23}\text{CaN}_3\text{O}_4$ 361.13, found 180.554 [M + Ca^{2+}]/2.

1⁴-Methoxy-7,10,13-trioxa-3,17-diaza-1(2,6)-pyridinaoctadecacyclophan-2,17-diene (7): A stock solution was prepared as follows: 4-methoxypyridine-2,6-dicarbaldehyde (**1**, 8.7 mg, 0.052 mmol), DMT (6.6 mg, 0.034 mmol), and CaCl_2 (5.7 mg, 0.052 mmol) were dissolved in CD_3OD (5 mL). 4,7,10-Trioxa-1,13-tridecanediamine (**6**, 17.1 μL , 0.078 mmol) was added, and the solution was stirred for 12 h. In different tubes, various percentages of water (2%, 10%, 50%) were added, and ^1H NMR spectra were recorded after 5 h. Yield calcd. from the ratio between signals of aromatic protons of

DMT [$\delta = 8.15$ (s, 4 H), 3.97 (s, 6 H) ppm] and imine protons: pure CD_3OD : 88%. ^1H NMR (600 MHz, 298 K, CD_3OD) of **7** in the mixture: $\delta = 8.60$ (t, $J = 1.2$ Hz, 2 H, CH=N), 7.58 (s, 2 H, Py), 4.11 (s, 3 H, OMe), 4.01–3.92 [overlapping signals, 16 H, CH₂(CH₂OCH₂)₃CH₂, CH=NCH₂], 2.19 (quint, $J = 6.6$ Hz, 4 H, CH₂CH₂CH₂) ppm. ^{13}C NMR (150 MHz, 298 K, CD_3OD): $\delta = 171.58$ [C-2,6 (Py)], 165.41 (CH=N), 154.59 [C-4 (Py)], 115.49 [C-3,6 (Py)], 71.54, 71.21, 70.92, 70.45, 69.64, 68.94, 58.14 [CH₂(CH₂OCH₂)₃CH₂, N=CH₂], 57.39 (OMe), 29.04 (CH₂CH₂CH₂) ppm. ESI-MS (positive ions) of the solution with 10% of water: calcd. for $\text{C}_{18}\text{H}_{27}\text{N}_3\text{O}_4$ 349.42, found 350.29 [M + H⁺]. HRMS: calcd. for $\text{C}_{18}\text{H}_{27}\text{N}_3\text{O}_4$ 349.20016, found 349.20015; calcd. for $\text{C}_{17}^{13}\text{CH}_{27}\text{N}_3\text{O}_4$ 350.20352, found 350.20405.

Exchange Reaction between the Macrocyclic Diimines 7 and 5: A stock solution was prepared as follows: 4-methoxypyridine-2,6-dicarbaldehyde (**1**, 8.7 mg, 0.052 mmol), DMT (6.6 mg, 0.034 mmol), and CaCl_2 (5.7 mg, 0.052 mmol) were dissolved in CD_3OD (5 mL). 4,7,10-Trioxa-1,13-tridecanediamine (**6**, 17.1 μL , 0.078 mmol) was added, and the solution was stirred for 12 h. Then, the solution was transferred into an NMR tube with 5% of water and left at room temperature for 4 h. Next, 3,6,9-trioxa-1,11-undecanediamine (**4**, 1 equiv.) was added into the tube, and the reaction was left to equilibrate for 12 h. ^1H NMR spectra were recorded in each step.

Acknowledgments

We are grateful for the support by the Marie Curie Research Training Network (MRTN-CT-2006-035614), Dynamic Combinatorial Chemistry (DCC).

- [1] a) *Encyclopedia of Supramolecular Chemistry* (Eds.: J. L. Atwood, J. W. Steed), Marcel Dekker, New York, **2004**, p. 311–318; b) J. W. Steed, J. L. Atwood, *Supramolecular Chemistry*, Wiley, Chichester, New York, Weinheim, Brisbane, Singapore, Toronto, **2005**, reprinted; c) *Core Concepts in Supramolecular Chemistry and Nanochemistry* (Eds.: J. W. Steed, D. R. Turner, K. J. Wallace), Wiley, Chichester, New York, Weinheim, Brisbane, Singapore, Toronto, **2007**.
- [2] Third Schiemenz “law” of organic chemistry: “whenever five- or six-membered rings may be formed, they will”. For an illustration of the three “laws” see: U. Lüning, *Organische Reaktionen – Eine Einführung in Reaktionswege und Mechanismen*, Elsevier – Spektrum, Spektrum Akademischer Verlag, Heidelberg, **2007**.
- [3] See, e.g.: F. Vögtle, *Chem.-Ztg.* **1972**, *96*, 396–403.
- [4] Probably the first example of a metal-ion template for the formation of imino macrocycles: N. F. Curtis, D. A. House, *Chem. Ind.* **1961**, *42*, 1708.
- [5] D. H. Cook, D. E. Fenton, M. G. B. Drew, S. G. McFall, S. M. Nelson, *J. Chem. Soc., Dalton Trans.* **1977**, *5*, 446–449.
- [6] U. Lüning, *Liebigs Ann. Chem.* **1987**, *11*, 949–955.
- [7] A recent example for the use of organic molecules as templates for the formation of a family of *endo*-functionalized molecules: S. Lüthje, C. Bornholt, U. Lüning, *Eur. J. Org. Chem.* **2006**, 909–915.
- [8] Imine formation in the presence of a carbonic anhydrase as template: I. Huc, J.-M. Lehn, *Proc. Natl. Acad. Sci. USA* **1997**, *94*, 2106–2110.
- [9] Steroid oligomers by transesterification: P. A. Brady, J. K. M. Sanders, *J. Chem. Soc. Perkin Trans. 1* **1997**, *21*, 3237–3253.
- [10] S. J. Rowan, S. J. Cantrill, G. R. L. Cousins, J. K. M. Sanders, J. F. Stoddart, *Angew. Chem.* **2002**, *114*, 938–993; *Angew. Chem. Int. Ed.* **2002**, *41*, 898–952.
- [11] P. T. Corbett, J. Leclair, L. Vial, K. R. West, J.-L. Wietor, J. K. M. Sanders, S. Otto, *Chem. Rev.* **2006**, *106*, 3652–3711.

- [12] A. González-Álvarez, I. Alfonso, F. López-Ortiz, A. Aguirre, S. García-Granda, V. Gotor, *Eur. J. Org. Chem.* **2004**, 1117–1127.
- [13] For a diastereoselective amplification of imine macrocycles, see: A. González-Álvarez, I. Alfonso, V. Gotor, *Chem. Commun.* **2006**, 21, 2224–2226.
- [14] O. Storm, U. Lüning, *Chem. Eur. J.* **2002**, 8, 793–798.
- [15] A recent example for the stability of an imine in water when forming a coordinative bond to a transition-metal ion: M. Hutin, C. A. Schalley, G. Bernardinelli, J. R. Nitschke, *Chem. Eur. J.* **2006**, 12, 4069–4076, and cited references.
- [16] C. Godoy-Alcantar, A. K. Yatsimirsky, J.-M. Lehn, *J. Phys. Org. Chem.* **2005**, 18, 979–985.
- [17] W. Lu, T. H. Chang, *J. Org. Chem.* **2001**, 66, 3467–3473: the (sulfonimino)pyridine compound **27** (more stable than an imine) was hydrolyzed in THF/H₂O (1:1).
- [18] For an example, see: T. Hirashita, Y. Hayashi, K. Mitsui, S. Araki, *J. Org. Chem.* **2003**, 68, 1309–1313. Product **2a** was hydrolyzed with a small amount of water in the solvent; in MeOH/H₂O (1:1), the product was fully hydrolyzed.
- [19] A. Simion, C. Simion, T. Kanda, S. Nagashima, Y. Mitoma, T. Yamada, K. Mimura, M. Tashiro, *J. Chem. Soc. Perkin Trans. I* **2001**, 2071–2078.
- [20] U. Lüning, R. Baumstark, K. Peters, H. G. v. Schnering, *Liebigs Ann. Chem.* **1990**, 2, 129–143.
- [21] C. D. Meyer, S. Joiner, F. Stoddart, *Chem. Soc. Rev.* **2007**, 36, 1705–1723.
- [22] S. Zameo, B. Vauzeilles, J. M. Beau, *Eur. J. Org. Chem.* **2006**, 24, 5441–5444.
- [23] In preliminary experiments, the imine formation of isophthalic dialdehyde with amines **2** and **4** has been investigated in methanol/water mixtures, too. Due to the *endo*-hydrogen atom in 2-position of the isophthalic dialdehyde, macrocycles do not form as good as with pyridine-2,6-dicarbaldehyde **1**. But in the reaction of isophthalic dialdehyde with *n*-butylamine (**2**), imine signals can also be detected, and the amount of imine formed is comparable with that of diimine **3** obtained from pyridinedialdehyde **1**. This result shows the importance of conjugation in the imines **3**, **5** and **7**.

Received: May 9, 2008
Published Online: July 15, 2008

3.2 On the Formation of Imines in Water, a Comparison

V. Saggiomo, U. Lüning, *Tetrahedron Lett.*, **2009**, *50*, 4663-4665.

During the previous work (Ch. 3.1), a discrepancy was found in the literature. In two different publications, the same imine synthesis in water has been reported with completely different yields (refs. 7 and 8 in the following publication). Starting from the same starting materials (benzaldehyde or salicylaldehyde and aniline, Fig. 3.2) and using the same solvent (water), the difference of yields was more than 80 % between the two references. Therefore both experiments were reproduced and the results were carefully analyzed in order to understand and explain the difference.

When both experiments were repeated, the same diverting results were obtained. The main problem was that the working groups did not differentiate between experiment and workup. When their experiments were repeated, it became clear that the starting materials and the final products were simply not soluble in water giving a biphasic solution.

An additional experiment was carried out to reinforce the proof that water was not playing any role in that synthesis. The starting materials were mixed without the addition of any solvent and leaved under vacuum. Using no solvent, the imines were obtained in high yield. Water from the reaction can be easily removed by reduced pressure driving the reaction to the product.

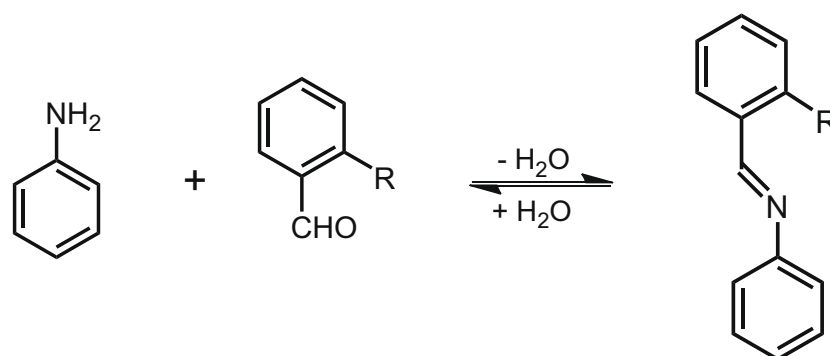

Figure 3.2: The reaction of aniline and benzaldehyde (R = H) or salicylaldehyde (R = OH) produces the respective imine. The reaction is reversible and water can drive it back to the starting materials.



Contents lists available at ScienceDirect

Tetrahedron Letters

journal homepage: www.elsevier.com/locate/tetlet



On the formation of imines in water—a comparison

Vittorio Saggiomo, Ulrich Lüning*

Otto-Diels-Institut für Organische Chemie, Christian-Albrechts-Universität zu Kiel, Olshausenstr. 40, D-24098 Kiel, Germany

ARTICLE INFO

Article history:

Received 13 March 2009

Accepted 29 May 2009

Available online 6 June 2009

Keywords:

Imines

Solvent-free reactions

Schiff bases

Water

ABSTRACT

The reaction of aniline with aryl aldehydes in water has been investigated in the past, but contradictory results have been published. While only small amounts of imines **3** were detected by NMR analysis, isolation afforded high imine yields. A reinvestigation of the reaction of benzaldehyde (**1a**) and salicylaldehyde (**1b**) with aniline (**2**) revealed two important factors which explain the putative contradiction: (i) NMR only reveals the fraction of products which is soluble in water, and (ii) imines **3** form during or after workup.

© 2009 Elsevier Ltd. All rights reserved.

1. Introduction

The reaction of primary amines with carbonyl compounds to give imines—also called Schiff bases or azomethines—is a reaction which is well known.¹ In nature it serves to interconvert amino acids and α -ketoacids into one another with the help of vitamin B6 (pyridoxamine–pyridoxal as coenzyme in transaminases²), but it has also been widely used in organic chemistry for numerous purposes since the 1800s. Due to its reversibility, the formation of imines has gained increasing interest in recent years as it is one of the reactions widely used in dynamic combinatorial chemistry.³ When an imine is formed from an aldehyde and a primary amine, one molecule of water is liberated per molecule of imine. Consequently, the formation of imines is facilitated when water is removed from the reaction mixture. In many experimental procedures, water-removing techniques or reagents are employed.⁴ The synthetic chemist therefore hesitates to have water present when he tries to synthesize an imine, although water would be the environmentally most benign solvent.⁵

2. Results and discussion

In dynamic combinatorial chemistry (DCC), water which is produced by an imine formation will stay in the reaction mixture, and the question arises to which extent water can be tolerated. Literature studies reveal surprising answers. While we discovered that in a specific dynamic combinatorial library, water can even be used as the solvent,⁶ other researchers have found less promising results. A recent study of Lehn and co-workers⁷ shows that only small

amounts of imines can be detected in water. Among many other substrates, they investigated the reaction of benzaldehyde (**1a**) or salicylaldehyde (**1b**) with aniline (**2**) (Fig. 1).

In contrast to these results, Tashiro and co-workers⁸ reported excellent yields of imines **3** when they reacted aldehyde **1a** or **1b** with aniline (**2**) in water—a remarkable putative contradiction. Due to the high relevance for DCC, we reproduced these experiments in our laboratory to understand this discrepancy (see Table 1).

First, the NMR experiment of Lehn's group (**A1**)⁷ was repeated in our laboratory. The literature experiment was carried out using a molar ratio of aldehyde **1a** to amine **2** of 1:3. A 16.5 mM solution of aldehyde **1a** in D₂O at pD 7.5 gave 5.4% of imine **3a**. This yield had been determined by simply integrating the signals for aldehyde **1a** and imine **3a** in D₂O.

When repeating this experiment, we did not use a buffer to allow for a comparison to the Tashiro experiments.⁸ With a molar

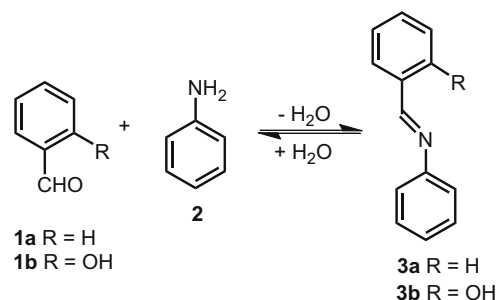

Figure 1. The reaction of aldehydes **1** with an amine such as aniline (**2**) to give imines **3** is a reversible process.

* Corresponding author. Fax: +49 431 880 1558.

E-mail address: luening@oc.uni-kiel.de (U. Lüning).

Table 1Reaction conditions, analysis conditions, and product ratios for the imine formation between aldehydes **1a–b** and aniline (**2**)

Experiment	Aldehyde	Reaction condition	Analysis	Ratio 1:3
A1	1a	D ₂ O	NMR	96:4
A2	1a	H ₂ O	NMR after workup and vacuum	5:95
A3	1a	No solvent, vacuum	NMR	5:95
B1	1b	D ₂ O	NMR	88:12
B2	1b	H ₂ O	NMR after workup and vacuum	3:97 ^a
B3	1b	No solvent, vacuum	NMR	3:97 ^b

^a Yield after recrystallization: 85%.^b Yield after recrystallization: 83%.

ratio of aldehyde **1a** to amine **2** of 1:1 at 10 mM for each starting material in D₂O, it became obvious that both starting materials which are liquids were not soluble in deuterated water, and the resulting mixture was non-homogeneous. Also pure aldehyde **1a** and pure amine **2** form two layers with water, showing that the solubility of these compounds is low in water. Neither heating of the NMR tube nor application of ultrasound resulted in the formation of a single layer. Either the solution remained biphasic or it became emulsion like. When a ¹H NMR was recorded, it resulted in the same ratio of imine **3a** to aldehyde **1a** as reported by Lehn.⁷

It must be noted that when analyzing the water layer alone by recording its NMR spectrum, only a small amount of the starting material was analyzed. The major part of the material is in the other layer and the NMR does not analyze it. The experiment was repeated with 3 equiv of aniline (**2**) without any improvement of the solubility or the percentage of imine **3a** dissolved in water. When calcium chloride (CaCl₂) or hydrochloric acid (HCl) was added to the emulsion, everything dissolved completely and the solution finally was clear. However the Lewis acid and the Brønsted acid simply solubilized aldehyde **1a** and amine **2** but their addition had no effect on the formation of imine **3a**, whose concentration remained low. No imine could be detected when HCl was used, and when CaCl₂ was used the amount of imine **3a** was less than 5%.

In contrast, Tashiro and co-workers were able to isolate imines **3** in good yields. The authors used a 0.6 M solution of aldehyde **1a** and amine **2**. The starting materials **1a** and **2** were stirred in water vigorously for 3 h. Then, the products were extracted with dichloromethane, dried, and analyzed by NMR. The yield of imine **3a** was found to be 97%.⁸

When this reaction was repeated (**A2**), again the low solubility of the starting materials in water could be observed. Vigorous stirring only provoked the reaction mixture to become emulsion like. Analogous to the reference, the reaction was stopped after 3 h, and the reaction mixture was extracted with dichloromethane, dried over MgSO₄, and the solvent was evaporated in vacuo. In order to record the NMR and to remove the remaining solvent traces, the vessel containing the oily product was evacuated using an oil pump. A few seconds after the vacuum was established, the oily product solidified and heat was developed. This was the first clue that the imine-forming reaction takes place when the two starting components are in concentrated contact with each other after the workup. Water does not play any role in the reaction as the starting aldehyde **1a** and amine **2** as well as the final product are only slightly soluble in water. Then after the workup, when the two reagents are concentrated, they react. The oil pump vacuum simply helps in the formation of imine **3a** by removing the water formed in the imine condensation.

To prove the latter hypothesis, aldehyde **1a** and amine **2** were mixed without any solvent in experiment **A3**.⁹ After a few seconds, a solid formed and the reaction was exothermic. The crude product was kept in vacuo for 10 min. Subsequent NMR analysis afforded the same yield as experiment **A2** (95%).

A second imine-forming experiment has also been investigated in both references in water:^{7,8} the reaction between salicylaldehyde (**1b**) and aniline (**2**). Also in this case, the yields reported for the formation of imine **3b** in water are completely different. In the NMR experiment of Lehn et al.,⁷ the reported yield of imine **3b** was only 14% while in the experiment of Tashiro et al.,⁸ the same imine **3b** was obtained in 87% yield. Suspecting the same effects during the reaction and workup as in experiments **A1–A3** [**1a** with aniline (**2**)], this reaction was also carried out in the three different ways as described above.

NMR experiment **B1** was carried out under the same conditions as experiment **A1**, and it did not show drastic changes in the ratio of final imine **3b** to aldehyde **1b** compared to the ratio reported by Lehn.⁷ Although salicylaldehyde (**1b**) is a little bit more soluble in water than benzaldehyde (**1a**), the solution once more was biphasic, and, as in experiment **A1**, neither heating nor sonication improved the solubility of the starting materials. Experiment **B2** was repeated in the same way as experiment **A2** was carried out. In this particular case, after workup, when the crude oil was subjected to vacuum, only a small amount of solid appeared. But after 12 h in vacuo, the product was almost completely solid. Recrystallization from *n*-hexane gave pure imine **3b** as yellow needles in 85% yield.

In the last experiment (**B3**),¹⁰ salicylaldehyde (**1b**) and aniline (**2**) were simply mixed together in a ratio of 1:1, and then the reaction was evacuated for 12 h. The result was the same as in experiment **B2**. After recrystallization from *n*-hexane, 83% of the final imine **3b** was recovered. Thus this experiment also shows that water as a solvent does not play any role during the formation of the imine. The liquid aldehyde and the liquid amine react with each other to give the respective imine **3b** in the absence of solvent.

3. Conclusion

The scope of this work was to elucidate the contradictory results presented in two different and recent papers. Both papers contain reproducible experiments and their goal is not focused on the synthesis of a single imine but on (a) a general imine synthesis in the presence of water⁸ and (b) the relationship between the structure and stability of imine formation in aqueous solution.⁷ However, when the same starting materials were used (**1a**, **1b**, and **2**), drastically varying yields were found for the respective imines **3a** and **3b**.

The putative contradiction in the two sets of experiments lies in the fact that the reaction only presumably takes place in water and that the 'water results' are compared. But on the contrary, the reaction takes place best in the absence of solvent.

The solubilities of the starting materials, and those of the final products, play an extremely important role in the dynamical combinatorial chemistry. Even if the starting building blocks are well soluble in water but the final product is not, this can drive a reaction to the latter product, into a thermodynamic trap. In order to

have a good and reproducible distribution of products in a library, all the components should be soluble and, by this, be free to interact with one another.

Acknowledgment

We are grateful for the support provided by the Marie Curie Research Training Network MRTN-CT-2006-035614 Dynamic Combinatorial Chemistry (DCC).

References and notes

1. (a) Patai, S. *The Chemistry of the Carbon–Nitrogen Double Bond*; Wiley: London, 1970; (b) Patai, S. *The Chemistry of the Amino Group*; Wiley: London, 1968; (c) Patai, S. *The Chemistry of the Carbonyl Group*; Wiley: London, 1966; (d) Layer, R. W. *Chem. Rev.* **1963**, *63*, 489–510; (e) Goering, B. K. Ph.D. Dissertation, Cornell University, 1995.
2. Aminotransferases and transaminases form enzyme class 2.6.1. For the mechanisms of transaminases via imines see: (a) Meister, A. *Biochemistry of the amino acids*; Academic Press: New York, 1957; (b) Frey, P. A.; Hegeman, A. D. *Enzymatic reaction mechanisms*; Oxford University Press, 2007. p. 148ff; For a recent review, see (c) Toney, M. D. *Arch. Biochem. Biophys.* **2005**, *433*, 279–287.
3. (a) Corbett, P. T.; Leclair, J.; Vial, L.; West, K. R.; Wietor, J.-L.; Sanders, J. K. M.; Otto, S. *Chem. Rev.* **2006**, *106*, 3652–3711; (b) Meyer, C. D.; Joiner, C. S.; Stoddart, J. F. *Chem. Soc. Rev.* **2007**, *36*, 1705–1723; (c) Rowan, S. J.; Cantrill, S. J.; Cousins, G. R. L.; Sanders, J. K. M.; Stoddart, J. F. *Angew. Chem.* **2002**, *114*, 938–993; *Angew. Chem., Int. Ed.* **2002**, *41*, 898–952; (d) Storm, O.; Lüning, U. *Chem. Eur. J.* **2002**, *8*, 793–798.
4. (a) Carey, F. C.; Sundberg, R. J. *Advanced Organic Chemistry*, 4th ed.; Springer: New York, 2006. p. 460; (b) Gattermann, L. *Die Praxis des organischen Chemiker* (Gattermann; Wieland), neu bearb. von Wieland, T.; Sucrow, W. de Gruyter, 43. Aufl., Berlin, New York, 1982.
5. (a) Horvath, I. T.; Anastas, P. T. *Chem. Rev.* **2007**, *107*, 2167–2168; (b) Li, C.-J.; Chan, T.-H. *Comprehensive Organic Reactions in Aqueous Media*, 2nd ed.; Wiley: New York, 2007; (c) *Organic Synthesis in Water*; Grieco, P. A., Ed.; Blackie Academic & Professional: London, 1998.
6. Saggiomo, V.; Lüning, U. *Eur. J. Org. Chem.* **2008**, *25*, 4329–4333.
7. Godoy-Alcantar, C.; Yatsimirsky, A. K.; Lehn, J.-M. *J. Phys. Org. Chem.* **2005**, *18*, 979–985.
8. Simion, A.; Simion, C.; Kanda, T.; Nagashima, S.; Mitoma, Y.; Yamada, T.; Mimura, K.; Tashiro, M. *J. Chem. Soc., Perkin Trans. 1* **2001**, 2071–2078.
9. *Experiment A3*: 1.0 mL (10 mmol) of benzaldehyde (**1a**) and 910 μ L (10 mmol) of aniline (**2**) were mixed in a 5 mL flask. The crude oil was left under vacuum (4×10^{-4} mbar) for 10 min, until all the oil became solid. Then, 10 mg of the crude product¹¹ was analyzed by ¹H NMR. Ratio imine **3a**/aldehyde **1a**: 95:5.
10. *Experiment B3*: 966 μ L (10.0 mmol) of salicylaldehyde (**1b**) and 911 μ L (10.0 mmol) of aniline (**2**) were mixed, and the reaction mixture was left under vacuum (4×10^{-4} mbar) for 12 h. Then, 10 mg of the crude product was analyzed by ¹H NMR. Ratio imine **3b**/aldehyde **1b**: 97:3. Recrystallization from *n*-hexane gave the final product¹¹ in 83% yield.
11. *N*-Benzylideneaniline (**3a**): SDBS No.: 2145, CAS No.: 538.51.2; *o*-(phenyliminomethyl)phenol (**3b**): SDBS No.: 7178, CAS No.: 779-84-0.

3.3 Transport of Calcium Ions through a Bulk Membrane by Use of a Dynamic Combinatorial Library

V. Saggiomo, U. Lüning, *Chem. Commun.*, **2009**, 3711-3713.

A carrier experiment in a bulk membrane system was set up to study if a Dynamic Combinatorial Library (DCL) can be used to screen directly a function, here transport.

A bulk membrane was used. The diamine and calcium ions were dissolved in the aqueous source phase (Figure 3.3, a), the dialdehyde was dissolved in the organic phase (Figure 3.3, b), and the receiver phase was pure water (Figure 3.3, c). After one week, imino macrocycle and calcium ions were found in the receiver phase. This phase was screened by NMR, ESI-MS, and a calcium titration test. The blank experiment with calcium ions and only one of the two building blocks (diamine or dialdehyde) reveals that none of the two transports calcium into the receiver phase. Using the two building blocks without calcium in the source phase reveals that the macrocycle is almost not synthesized at all.

This is the first proof of a macrocyclic carrier amplified directly by a DCL.

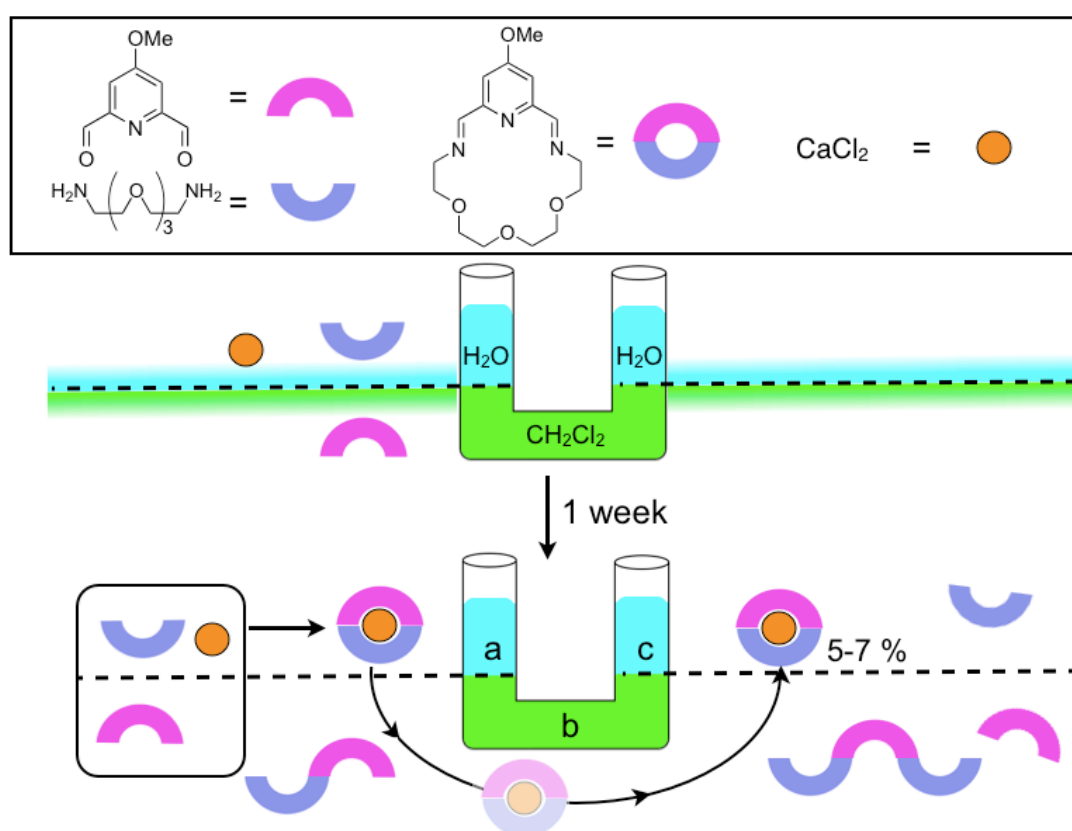

Figure 3.3: Schematic representation of the bulk membrane/DCL experiment. Starting material and detected final macrocycle on top. Transport of calcium ions from (a) water source phase to (c) water receiver phase passing through (b) organic bulk membrane.

Transport of calcium ions through a bulk membrane by use of a dynamic combinatorial library†‡

Vittorio Saggiomo and Ulrich Lüning*

Received (in Cambridge, UK) 10th February 2009, Accepted 15th May 2009

First published as an Advance Article on the web 28th May 2009

DOI: 10.1039/b902847a

In a bulk membrane transport experiment, a dynamic combinatorial library (DCL) has been used to transport calcium ions; the calcium ions amplify the formation of a macrocyclic carrier which results in transport.

Dynamic Combinatorial Chemistry (DCC)¹ exploits the reversibility of chemical reactions. The resulting mixtures are called dynamic combinatorial libraries (DCLs). At first glance, reversibility seems to complicate the chemistry as all products in a DCL may interconvert into new ones. By addition of suitable template molecules, specific members of the DCL can be amplified if the resulting complex is more stable than uncomplexed members of the DCL or complexes of other members with this template.^{2,3} In a classical DCC experiment (Fig. 1, solid arrows), the next task is to stop the equilibration of the DCL and to isolate the desired amplified product. Then it can be used for its function, for instance as a receptor or a carrier in a transport experiment.

Over the past years, a large number of reversible reactions have been used in DCC. Classical DCLs frequently use disulfide, hydrazone or imine chemistry, and quenching may be performed by a change of pH (sulfide or hydrazone exchange) or by reduction (imines).

In this work we have investigated a “short-cut”: the DCL was directly used to screen for a function (Fig. 1, dashed arrow).⁴ Transport mediated by carrier molecules has broad scientific interest: *e.g.* decontamination of wastewater, the understanding of biological processes, drug delivery. Previous experiments carried out by Morrow’s group⁵ show that a library formed by the condensation of different aldehydes with amines (or hydrazides) can extract certain transition metal ions from water into an organic solvent in which the building blocks are dissolved. Our approach adds one more step. We have investigated whether a DCL can transport calcium ions from an aqueous source phase to an aqueous receiver phase separated by organic solvent (bulk membrane).

Starting from a well known host–guest system^{6,7} with an imino macrocycle and calcium ions, we carried out transport experiments using a DCL and not a purified carrier. The main question was: “Can a DCL built from amines and dialdehydes be used to transport particular ions?” In this work, we present experiments showing that a metal ion which can act as a

template ion in Dynamic Combinatorial Chemistry can select its own carrier from the DCL and is transported through a (bulk) membrane.

Before the transport experiments were carried out, bi-phasic behaviour of the DCL made from diamine **1**, dialdehyde **2**⁸ and calcium ions (Fig. 2) was investigated in a two-phase system (water and chloroform or dichloromethane).⁹ Dissolving equimolar amounts of diamine **1** in the aqueous phase and dialdehyde **2** in the organic phase gave a DCL with a distribution of final products in both layers. Using deuterated solvents, the time dependence of the DCL composition was monitored by means of NMR. The system was not stirred or mixed. Every 48 h, 600 μ L of each layer were taken and analyzed by ¹H-NMR.

Experiment **A** without any template ions (Fig. 3) showed after one week many imine peaks in the organic phase (7.4–7.8 ppm for the pyridine protons and 8.4–8.6 ppm for the imine protons). The large number of signals can be attributed to the presence of different cyclic or linear oligo- and polymers (see ESI† for the overlapped NMR spectra).

For comparison, two blank experiments were carried out with the bi-phasic set-up: (i) Diamine **1** was dissolved in water but no dialdehyde **2** was dissolved in the organic phase. After one week, only a small amount (from 2% to 4%) of diamine **1** was detected in the organic phase (determination by weight after evaporation of the solvent). (ii) In a second experiment, dialdehyde **2** was dissolved in the organic layer but no diamine **1** was present in the water layer. In this case, no dialdehyde **2** could be found in the aqueous phase after one week. Due to its basicity, diamine **1** is largely protonated and stays in the water layer but some diamine **1** will always diffuse into the organic layer. In contrast, dialdehyde **2** stays mostly in the organic phase. Thus a reaction between diamine **1** and dialdehyde **2** probably takes place in the organic phase or at the interphase.

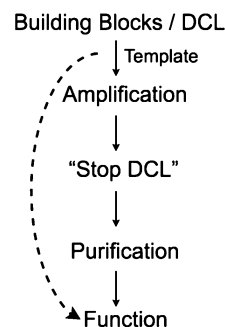

Fig. 1 Flowchart of a general DCC experiment in solid arrows. The experiment described here is indicated by a dashed arrow.

Otto-Diels-Institut für Organische Chemie, Olshausenstr. 40, D-24098 Kiel, Germany. E-mail: luening@oc.uni-kiel.de; Fax: +49-431-880-1558; Tel: +49-431-880-2450

† Dynamic Combinatorial Chemistry, Part 3. For Part 2, see ref. 7.

‡ Electronic supplementary information (ESI) available: Experimental section, ¹H-NMR, ESI-MS and transport experiment. See DOI: 10.1039/b902847a

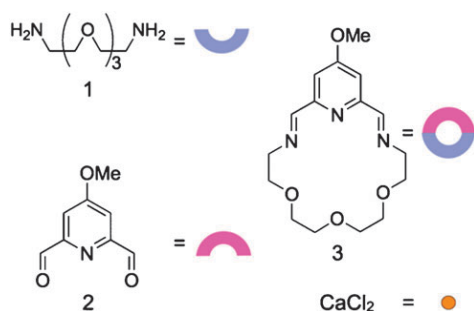

Fig. 2 Building blocks and their cartoon representation.

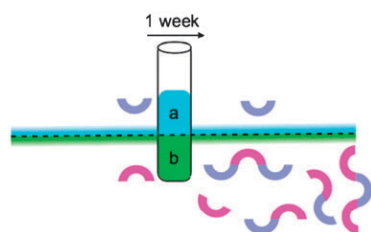

Fig. 3 Experiment A. Building blocks on the left and detected products on the right. (a) Aqueous phase, (b) organic phase.

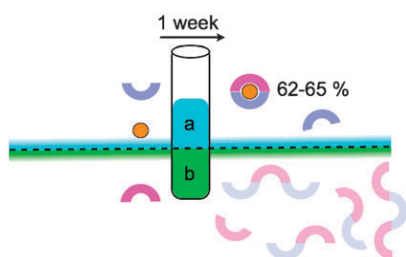

Fig. 4 Experiment B. Building blocks on the left and detected products on the right. (a) Aqueous phase, (b) organic phase.

In experiment B (Fig. 4), an equimolar amount of calcium chloride (CaCl_2) (with respect to diamine 1 and dialdehyde 2) was dissolved in the aqueous phase.

After one week, macrocycle 3 was detected in the aqueous phase with a yield of 62–65%. Surprisingly, even in presence of an organic layer, macrocycle 3 complexes calcium and goes preferentially into the water layer.

Also for experiment B, two different blank experiments were monitored: (i) without dialdehyde 2 in the organic layer, diamine 1, initially dissolved in water in presence of calcium ions, was found in the organic layer in 2–4% yield after one week. (ii) In the absence of diamine 1, dialdehyde 2 was dissolved in the organic layer, and CaCl_2 in the aqueous phase. After one week, 1–2% of dialdehyde 2 was found in the aqueous phase in its hydrate form (monitored by $^1\text{H-NMR}$). Here, calcium chloride seems to facilitate the hydration of the aromatic aldehyde 2.

Next, the transport of calcium ions by the DCL derived from diamine 1 and dialdehyde 2 was investigated. The difference from standard transport experiments is the fact that no carrier exists in the beginning. Even after mixing of diamine 1 with dialdehyde 2, macrocycle 3 which is supposed to be able to carry calcium ions across a lipophilic membrane only exists in low concentration. But calcium ions act as a template for

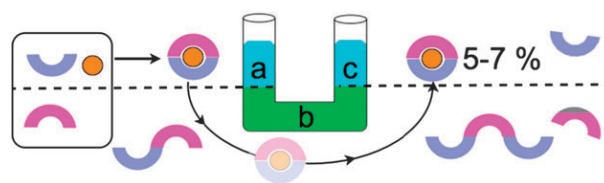

Fig. 5 Experiment C. Building blocks (in the frame) and detected products in the transport experiment. (a) Source water phase, (b) bulk membrane CD_2Cl_2 , (c) aqueous receiver phase.

the formation and stabilization of macrocycle 3 and thus the presence of calcium ions changes the DCL and amplifies the calcium complex 3-Ca^{2+} .

The transport ability of the DCL was tested with a bulk membrane¹⁰ experiment (experiment C, Fig. 5) which was set up in the following way: diamine 1 and calcium ions were dissolved in the source water phase, dialdehyde 2 was dissolved in the bulk membrane organic phase, and the receiver phase was pure water. All three components were used in equimolar amounts.

After one week, the three phases were monitored by means of $^1\text{H-NMR}$.¹¹ No NMR signals of the starting building blocks 1 and 2 nor of the final product 3 are observed in the “residue solvent region” of the spectra. In order not to disturb the DCL by removing solvent the spectra were recorded directly in the non-deuterated solvents. The analysis of the water source phase and the organic phase was straightforward. The results are in agreement with experiment B. The major part (*ca.* 60%) of macrocycle 3 was found in the source water phase, as well as polymers being found in the organic phase. But the product in the water receiver phase was too dilute to record good NMR spectra directly from the receiving solution. For this reason the solvent was removed by a flow of nitrogen.¹² The residue was dissolved in deuterated methanol and a $^1\text{H-NMR}$ spectrum was recorded. A 5–7% yield of macrocycle 3 was found in the receiving phase. This solution was also analyzed by ESI-MS, which showed the signal for the protonated molecule ($M + \text{H}^+$), the molecular peak plus a potassium ion ($M + \text{K}^+$) and, more importantly, the molecular peak plus a calcium ion ($M + \text{Ca}^{2+}/2$). Although in the ESI-MS it is quite common to find molecular peaks plus potassium and sodium ions, originating from the environment, it is usually impossible to detect the molecular peak plus a calcium ion if calcium is not present in the solution. Thus, the ESI-MS proves that both macrocycle and calcium ions were present in the water receiver phase. Furthermore, a titration method was used to analyze the calcium ions in the receiving phase. The Aquamerck[®] calcium test (for details, see ESI†) is able to detect calcium ions in a range from 2–200 mg L^{-1} , and it also determined 5–7% of calcium in the receiver phase.

Control experiments showed that with calcium chloride alone, or calcium chloride with only one of the two building blocks (diamine 1 or dialdehyde 2), there was no transport at all.

Our transport experiments prove that a DCL can be directly used for a function. Not a pre-selected and isolated carrier has been used for transport but carrier 3 was amplified from a DCL and acted as a carrier through a bulk liquid membrane! These results open new opportunities in many different fields.

Cleaning of waste/toxic water from dangerous heavy metal ions mediated by a DCL could be very fascinating for environmental chemistry. Another important field is drug delivery in the cell;¹³ the use of a DCL instead of a purified product is of easy access and could give immediate results if a product of the library is amplified by the drug and if it acts as a carrier into the cell. A conceptually similar set of observations using different chemistry is reported by the Cambridge group in an accompanying paper.¹⁴

We thank the EU for its support through the Marie Curie Research Training Network MRTN-CT-2006-035614 Dynamic Combinatorial Chemistry (DCC), and for providing the forum for the Cambridge and Kiel groups to exchange insights and results. We thank M. Pittelkow and J. K. M. Sanders for helpful discussions, and C. Goeschen and R. Herges for lending us the transport equipment.

Notes and references

- 1 P. T. Corbett, J. Leclaire, L. Vial, K. R. West, J.-L. Wietor, J. K. M. Sanders and S. Otto, *Chem. Rev.*, 2006, **106**, 3652–3711; C. D. Meyer, C. S. Joiner and J. F. Stoddart, *Chem. Soc. Rev.*, 2007, **36**, 1705–1723; S. J. Rowan, S. J. Cantrill, G. R. L. Cousins, J. K. M. Sanders and J. F. Stoddart, *Angew. Chem.*, 2002, **114**, 938–993; S. J. Rowan, S. J. Cantrill, G. R. L. Cousins, J. K. M. Sanders and J. F. Stoddart, *Angew. Chem., Int. Ed.*, 2002, **41**, 898–952; I. Huc and J.-M. Lehn, *Proc. Natl. Acad. Sci. U. S. A.*, 1997, **94**, 2106–2110; P. A. Brady and J. K. M. Sanders, *J. Chem. Soc., Perkin Trans. 1*, 1997, **21**, 3237–3253; S. Ladame, *Org. Biomol. Chem.*, 2008, **6**, 219–226.
- 2 Some examples for amplification in disulfide, hydrazone and imine libraries: S. Otto, E. L. R. Furlan and J. K. M. Sanders, *Science*, 2002, **297**, 590–593; M. S. Voshell, J. S. Lee and R. M. Gagne, *J. Am. Chem. Soc.*, 2006, **128**, 12422–12423; K. Ziach and J. Jurczak, *Org. Lett.*, 2008, 5159–5162.
- 3 It is important to note that the addition of templates affects the whole system. The resulting DCL will be that with the lowest total free enthalpy and thus the most stable member need not exist in highest concentration. Some examples: P. T. Corbett, J. K. M. Sanders and S. Otto, *J. Am. Chem. Soc.*, 2005, **127**, 9390–9392; P. T. Corbett, J. K. M. Sanders and S. Otto, *Chem.–Eur. J.*, 2008, **14**, 2153–2166; K. Severin, *Chem.–Eur. J.*, 2004, **10**, 2565–2580.
- 4 Few examples of direct use of a DCL and not a purified product are present in the literature: R. Larsson, Z. Pei and O. Ramström, *Angew. Chem.*, 2004, **116**, 3802–3804; R. Larsson, Z. Pei and O. Ramström, *Angew. Chem., Int. Ed.*, 2004, **43**, 3716–3718; A. Buryak and K. Severin, *Angew. Chem.*, 2005, **117**, 8149–8152; A. Buryak and K. Severin, *Angew. Chem., Int. Ed.*, 2005, **44**, 7935–7938; A. Buryak and K. Severin, *J. Comb. Chem.*, 2006, **8**, 540–543. Nowadays the use of a chemical library instead of a single compound is growing in importance (system chemistry): R. F. Ludlow and S. Otto, *Chem. Soc. Rev.*, 2008, **37**, 101–108.
- 5 D. M. Epstein, S. Choudhary, M. R. Churchill, K. M. Keil, A. V. Eliseev and J. R. Morrow, *Inorg. Chem.*, 2001, **40**, 1591–1596; S. Choudhary and J. R. Morrow, *Angew. Chem.*, 2002, **114**, 4270–4272; S. Choudhary and J. R. Morrow, *Angew. Chem., Int. Ed.*, 2002, **41**, 4096–4098.
- 6 O. Storm and U. Lüning, *Chem.–Eur. J.*, 2002, **8**, 793–798.
- 7 V. Saggiomo and U. Lüning, *Eur. J. Org. Chem.*, 2008, 4329–4333.
- 8 Diamine **1** and dialdehyde **2** were synthesized according to: U. Lüning, R. Baumstark, K. Peters and H. G. v. Schnering, *Liebigs Ann. Chem.*, 1990, 129–143.
- 9 R. Pérez-Fernández, M. Pittelkow, A. M. Belenguer and J. K. M. Sanders, *Chem. Commun.*, 2008, 1738–1740.
- 10 J. H. Moore and R. S. Schechter, *AIChE J.*, 1973, **19**, 736–741; H. C. Visser, D. N. Reinhoudt and F. de Jong, *Chem. Soc. Rev.*, 1994, 75–81; P. Breccia, M. Van Gool, R. Pérez-Fernández, S. Martín-Santamaria, F. Gago, P. Prados and J. de Mendoza, *J. Am. Chem. Soc.*, 2003, **125**, 8270–8284.
- 11 Typically in this kind of experiment, a conductivity meter is used. Here, the transport of the calcium ions could not be followed by conductivity because diamine **1** passes through the bulk membrane and reaches the receiver phase. There, its protonated form $1\cdot\text{H}^+$ contributes to the conductivity increase, hiding the calcium conductivity in a non predictable way.
- 12 Note: it is important to remove the solvent without heating since this facilitates the hydrolysis of the imino linkage.
- 13 W. A. Ritschel, *Handbook of Basic Pharmacokinetics*, Drug Intelligence, Hamilton, 1976.
- 14 R. Pérez-Fernández, M. Pittelkow, A. M. Belenguer, L. A. Lane, C. V. Robinson and J. K. M. Sanders, *Chem. Commun.*, 2009, DOI: 10.1039/b902842k.

Supplementary Information For:

Transport of calcium ions through a bulk membrane by use of a dynamic combinatorial library

Vittorio Saggiomo, Ulrich Lüning*

Otto-Diels-Institut für Organische Chemie, Olshausenstr. 40, D-24098 Kiel, Germany. Fax: +49-431-880-1558; Tel:+49-431-880-2450; E-mail: luening@oc.uni-kiel.de

Contents	page
General remarks	2
Experiment A (bi-phasic, no calcium ions)	3
- experimental procedure	3
- schematic set-up (Figure 1)	3
- ¹ H-NMR (Figure 2)	4
Experiment B (bi-phasic, with calcium ions)	5
- experimental procedure	5
- schematic set-up (Figure 3)	5
- ¹ H-NMR (Figure 4)	6
Experiment C (carrier experiment)	7
- experimental procedure	7
- schematic set-up (Figure 5)	7
- glassware (Figure 6)	8
- ¹ H-NMR (Figure 7)	9
- ESI-MS (Figure 8)	10
- Colorimetric titration	11

General remarks

TraceSELECT[®] Water (Fluka) and *Aquamerck*[®] Calcium Test (Merck) were obtained commercially. 4-Methoxypyridine-2,6-dicarbaldehyde ¹ and 3,6,9-trioxa-1,11-undecanediamine ¹ were synthesized according to literature. NMR spectra were recorded with Bruker DRX 500 or AV 600 instruments. ESI mass spectra were recorded with an Applied Biosystem Mariner Spectrometry Workstation. All the glassware used for the experiments were first washed with ultra-pure water (purified by mean of ELSA Purelab Plus) and then washed with *TraceSELECT*[®] Water to prevent any contamination by calcium ions which are always present in distilled water. All experiments were repeated at least three times each. For a complete characterization of 14-methoxy-6,9,12-trioxa-3,15-diaza-1(2,6)-pyridinahexadecacyclophan-2,15-diene see ².

Experiment **A** (bi-phasic, no calcium ions):

In a test tube, 8.2 mg (0.050 mmol) of 4-methoxypyridine-2,6-dicarbaldehyde (**2**) was dissolved in 5 mL of CDCl_3 (or CD_2Cl_2). A solution of 9.6 mg (0.050 mmol) of 3,6,9-trioxa-1,11-undecanediamine (**1**) in 5 mL of D_2O was added to the organic phase to form the bi-phasic system. The test tube was closed with a stopper and the air was exchanged three times by nitrogen. Every 48 h, 600 μL of both layers were taken and the respective ^1H -NMR spectra were recorded. A well defined amount of a standard solution of dimethyl terephthalate (DMT) was added into each organic solution to follow the evolution of the experiment.

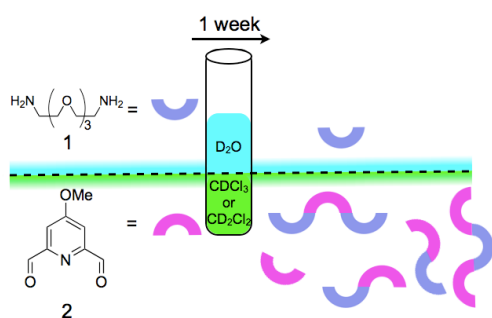

Figure 1: Schematic set-up of experiment **A**. The colored half circles symbolize the diamine and dialdehyde building blocks **1**, **2** and the respective products.

Supplementary Material (ESI) for Chemical Communications
This journal is (c) The Royal Society of Chemistry 2009

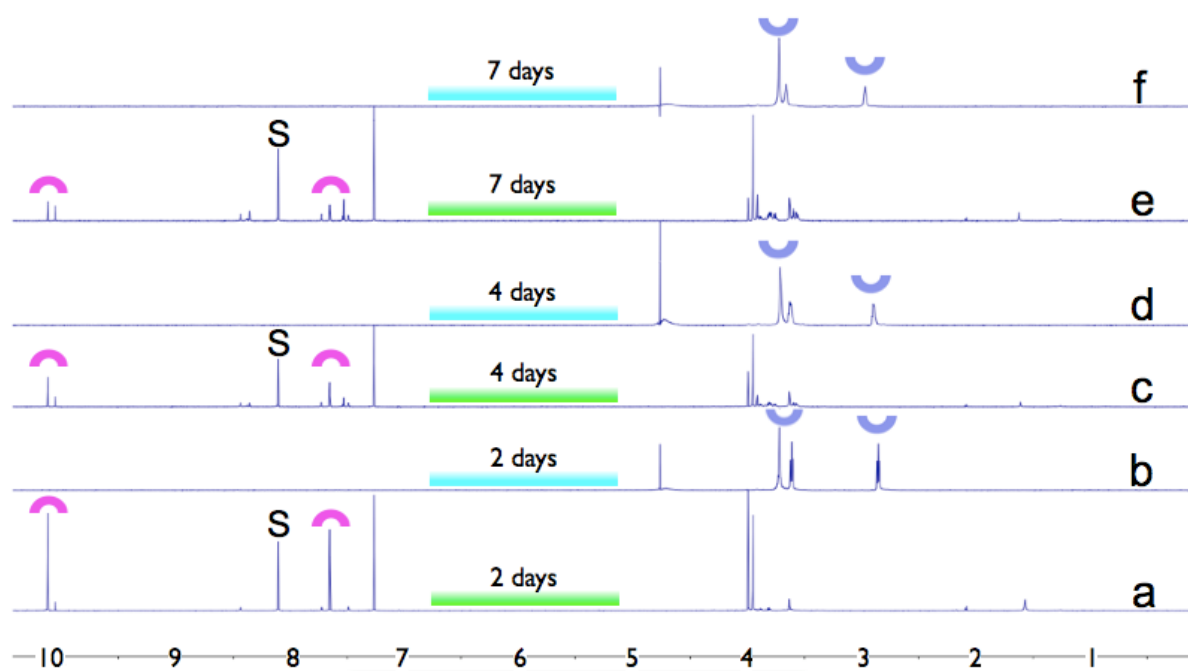

Figure 2. ¹H-NMR (500 MHz, 298 K). a), c) and e) CDCl₃; b), d) and f) D₂O. S = internal standard (DMT). Peaks are labeled with symbols as defined in Figure 1.

Experiment B (bi-phasic, with calcium ions):

In a test tube, 8.2 mg (0.050 mmol) of 4-methoxypyridine-2,6-dicarbaldehyde (**2**) was dissolved in 5 mL of CDCl_3 (or CD_2Cl_2). A solution of 9.6 mg (0.050 mmol) of 3,6,9-trioxa-1,11-undecanediamine (**1**) in 5 mL of D_2O was added to the organic phase to form the bi-phasic system. To the water layer, 5.5 mg (0.050 mmol) of CaCl_2 was added. The test tube was closed with a stopper and the air was exchanged three times by nitrogen. Every 48 h, 600 μL of both layers were taken and the respective $^1\text{H-NMR}$ spectra were recorded. A well defined amount of a standard solution of dimethyl terephthalate (DMT) was added into each organic solution to follow the evolution of the experiment. 14-Methoxy-6,9,12-trioxa-3,15-diaza-1(2,6)-pyridinahexadecacyclophan-2,15-diene in the water phase: 62-65% yield.

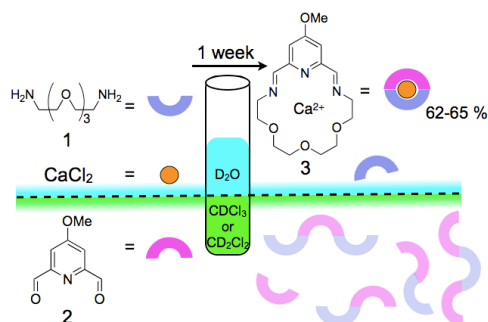

Figure 3: Schematic set-up of experiment **B**. The colored half circles shall symbolize the diamine and dialdehyde building blocks **1**, **2** and the respective products (macrocycle **3** and polymers). Calcium ions are shown as orange circles.

Supplementary Material (ESI) for Chemical Communications
This journal is (c) The Royal Society of Chemistry 2009

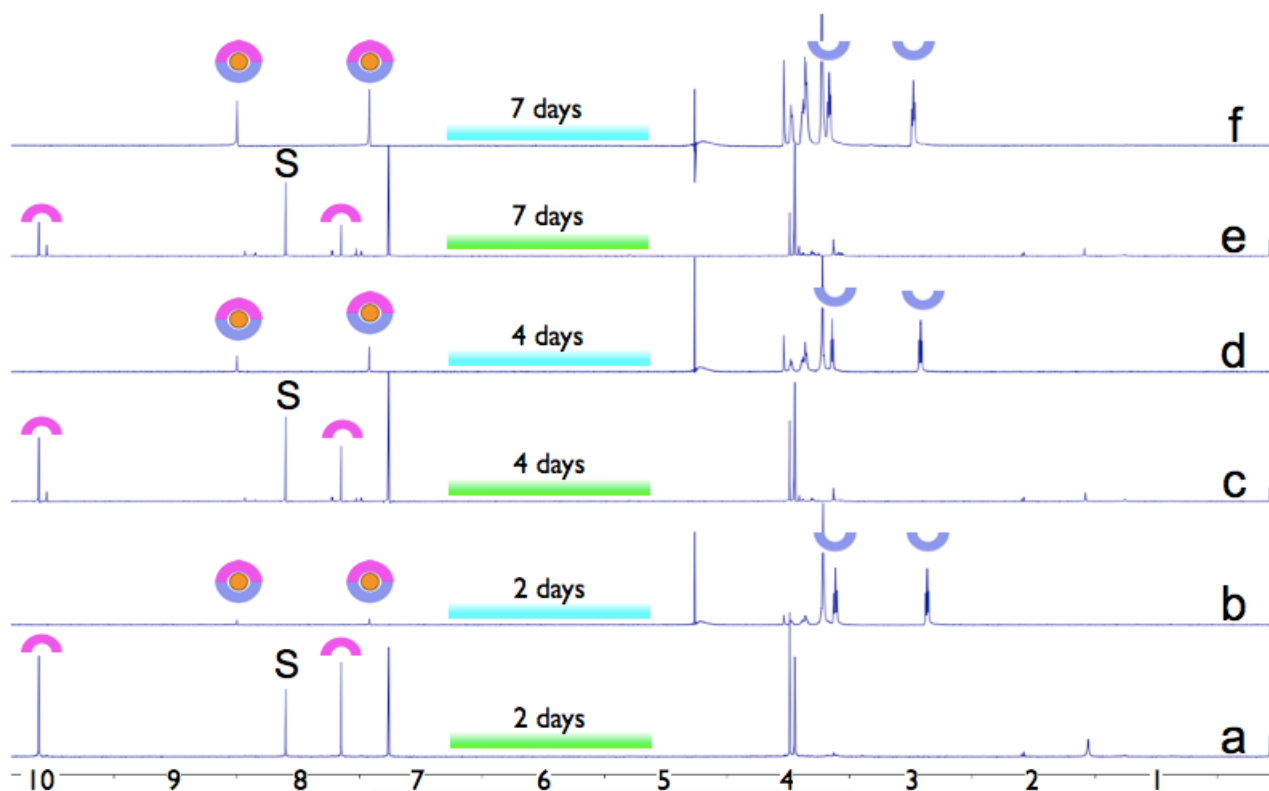

Figure 4. ¹H-NMR (500 MHz, 298 K). a), c) and e) CDCl₃; b), d) and f) D₂O. S = internal standard (DMT). Peaks are labeled with symbols as defined in Figure 1 or 3.

Experiment **C** (carrier experiment):

Water source phase: 20 mL of Fluka *TraceSELECT*[®] Water, 49 mg (0.30 mmol) of 3,6,9-trioxa-1,11-undecanediamine (**1**) and 33 mg (0.30 mmol) of CaCl₂.

Bulk membrane: 60 mL of CH₂Cl₂, 49 mg (0.30 mmol) of 4-methoxypyridine-2,6-dicarbaldehyde (**2**).

Water receiver phase: 20 mL of Fluka *TraceSELECT*[®] Water.

Each phase was left under gentle stirring for 1 week. After 1 week, the three phases were analyzed by ¹H-NMR. 550 μl of the water source phase and 550 μl of the organic phase were taken. 50 μl of deuterated solvent (D₂O for the water phase and CD₂Cl₂ for the organic phase) were added and the ¹H-NMR spectra were recorded. The solvent of the aqueous receiver phase was evaporated by a flux of nitrogen. Then the residue was dissolved in CD₃OD and a ¹H-NMR spectrum was recorded. The aqueous receiver phase was also analyzed by means of ESI-MS and with a titration method (Aquamerck[®] Calcium-Test). Macrocycle **3** and calcium ions were found in the receiver phase with 5 - 7% of yield.

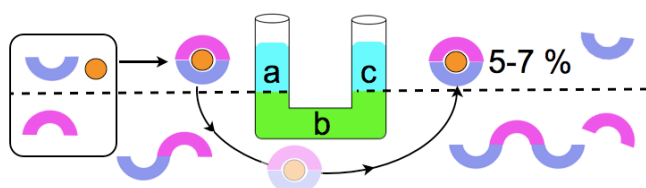

Figure 5: Schematic set-up of experiment **C**. For symbols, see Figure 1 or 3.

Supplementary Material (ESI) for Chemical Communications
This journal is (c) The Royal Society of Chemistry 2009

Quartz glass

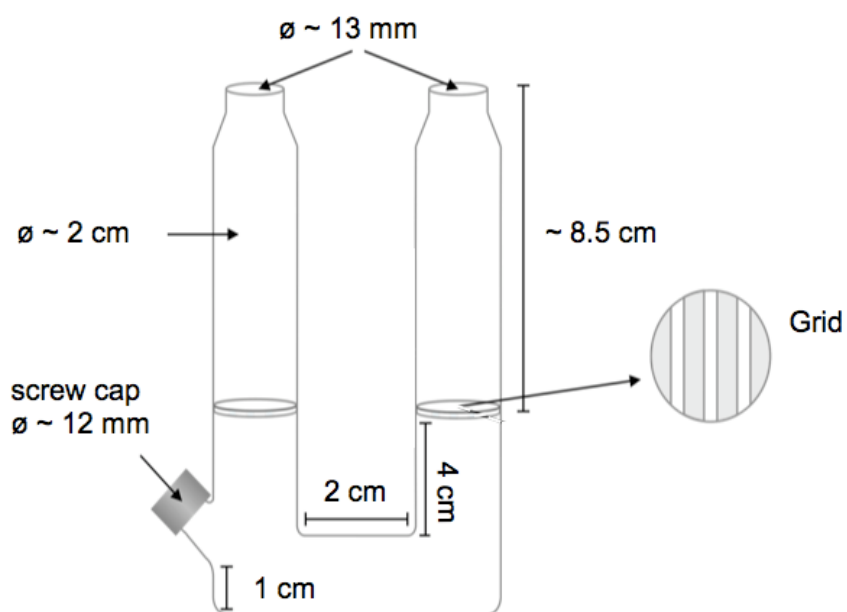

Figure 6: Glassware used in experiment **C**. All three compartments were gently stirred by magnetic stirring bars.

Supplementary Material (ESI) for Chemical Communications
This journal is (c) The Royal Society of Chemistry 2009

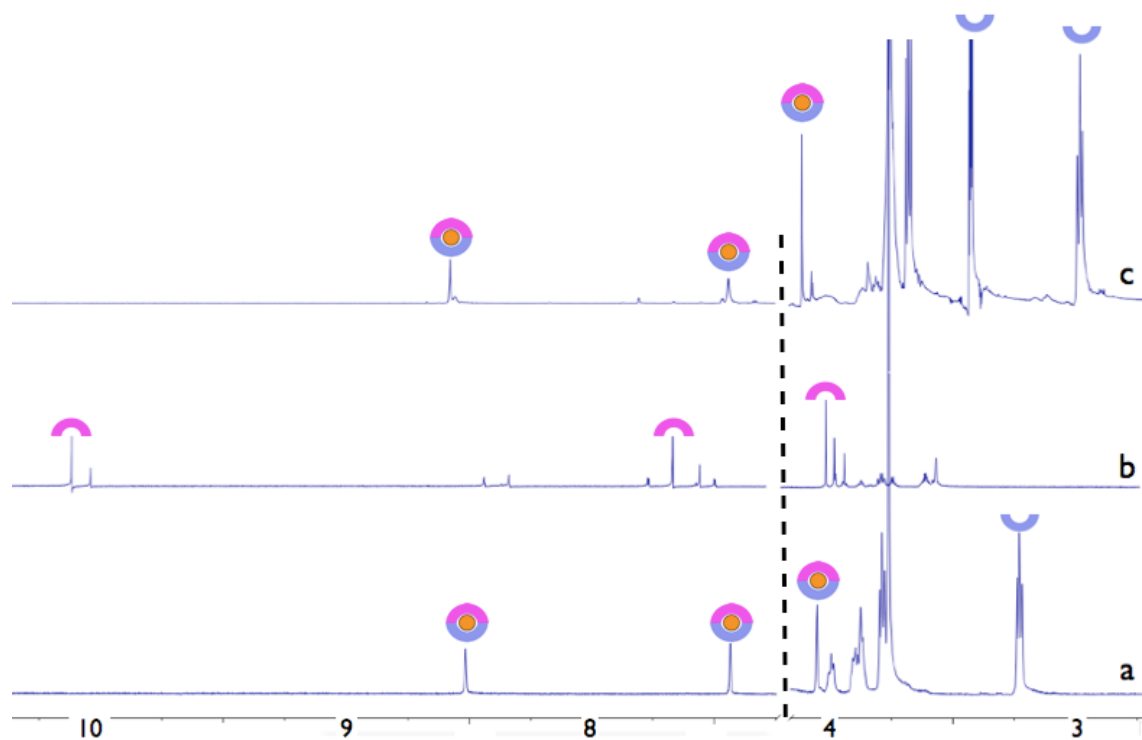

Figure 7. ¹H-NMR (500 MHz, 298 K). a) source phase H₂O + 10 % D₂O; b) bulk membrane CH₂Cl₂ + 10 % CD₂Cl₂; c) receiver phase evaporated, CD₃OD. Solvent residue peaks are removed for clarity. For symbols, see Figure 1 or 3.

Supplementary Material (ESI) for Chemical Communications
This journal is (c) The Royal Society of Chemistry 2009

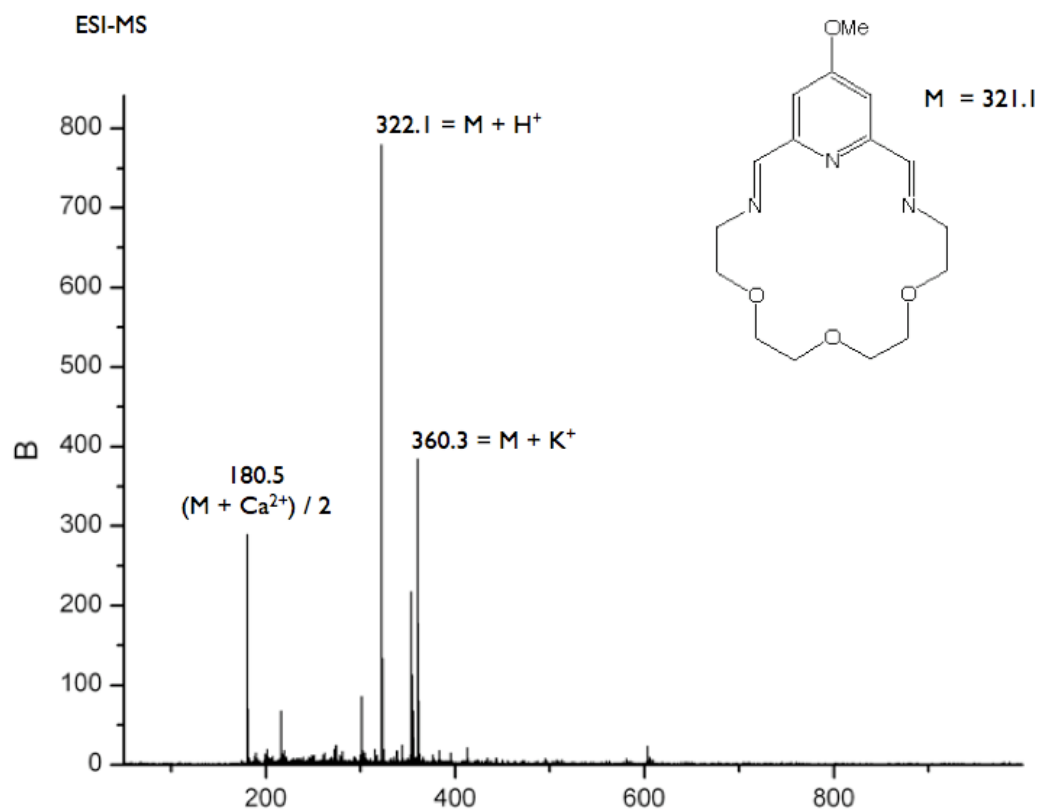

Figure 8. ESI-MS of the receiving phase.

Colorimetric Titration

5 ml were taken from the aqueous receiver phase. 10 drops of Ca-1 solution (Aquamerck[®] Calcium-Test) were added to this solution followed by a small amount of indicator Ca-2 (Aquamerck[®] Calcium-Test). The solution was stirred and titrated drop by drop using a titration pipette with a solution of Ca-3 (Aquamerck[®] Calcium-Test). When the color changed from red-violet to blue-violet the titration was complete. From the volume of the Ca-3 solution used, the amount of calcium was calculated to be 99 mg/L (1.98 mg/20 mL receiver phase, 6 %) which is in agreement with the NMR determined 5 - 7 % of calcium complex carried from the source to the receiver phase.

¹ U. Lüning, R. Baumstark, K. Peters, H. G. v. Schnering, *Liebigs Ann. Chem.*, **1990**, 129-143.

² V. Saggiomo, U. Lüning, *Eur. J. Org. Chem.*, **2008**, 4329-4333.

3.4 Ion Transport across Membranes Facilitated by a Dynamic Combinatorial Library

V. Saggiomo, C. Goeschen, R. Herges, R. Quesada, U. Lüning, *Eur. J. Org. Chem* **2010**, DOI: 10.1002/ejoc.201000038.

After the bulk membrane experiment (Ch. 3.3), another synthetic membrane and a larger library were tested. Starting from a DCL of three building blocks (one diamine and two dialdehydes) and calcium ion as template, two macrocycles were formed due to their calcium complexing abilities and one showed a better transport activity than the other. This methodology has a double screening activity: In the first screening, two different macrocycles are amplified from a DCL, during the second screening the membrane itself chooses the best carrier between the two macrocycles (Fig. 3.4). A Supported Liquid Membrane (SLM) was used as synthetic membrane and some preliminary experiments with liposomes were carried out. This also shows the versatility of the methodology that could be applied to other membranes. Catrin Goeschen from Rainer Herges' group in Kiel helped with the set-up of the first SLM experiment and with the data collection. Roberto Quesada (University of Burgos) helped in the set-up of the liposome experiments.

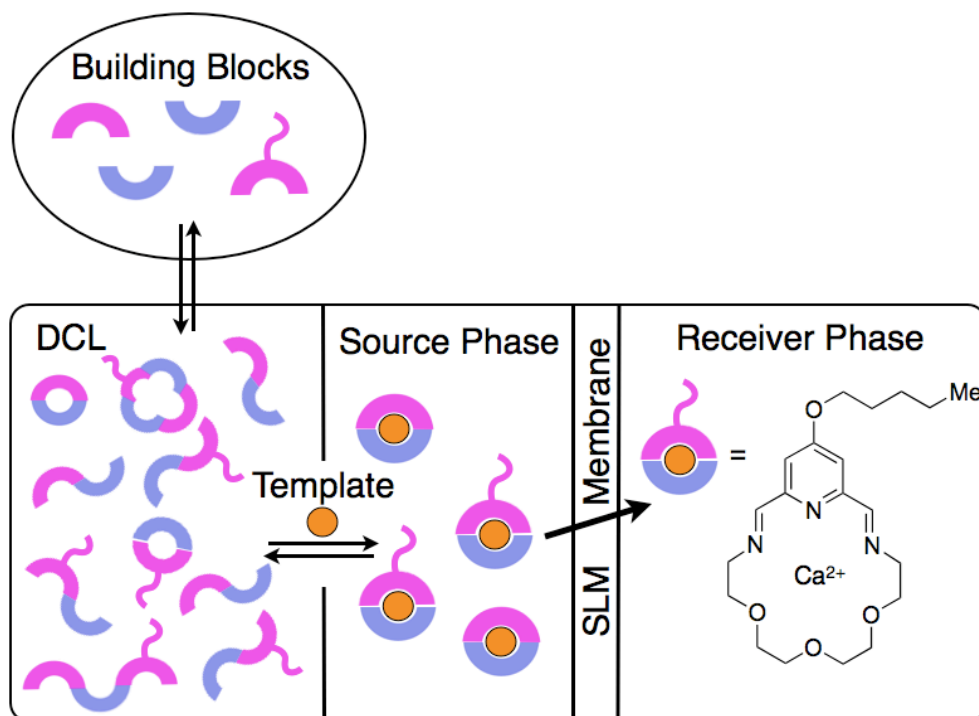

Figure 3.4: Schematic representation of the experiment. Starting from a DCL consisting of calcium ions, one diamine and two dialdehydes, two macrocycles templated by calcium ions are formed, and one of them transports the ions through a Supported Liquid Membrane (SLM).

Ion Transport Across Membranes Facilitated by a Dynamic Combinatorial Library ‡

Vittorio Saggiomo,^a Catrin Goeschen,^a Rainer Herges,^a Roberto Quesada,^b Ulrich Lüning^{*,a}

Dedication ((optional))

Abstract: A dynamic combinatorial library (DCL) consisting of dialdehydes and diamines has been used to facilitate transport of calcium ions across a supported liquid membrane (SLM). In a dual selection process, the calcium ions first select matching macrocycles **3** or **5** from the DCL. Second, only one of the macrocycle-calcium

complexes (**5**•Ca²⁺) efficiently transports calcium ions due to its better balance between lipo- and hydrophilicity. The special set-up of a DCL combined with a SLM directly finds suitable carriers for ion transport starting from diamine and dialdehyde building blocks **1**, **2** and **4** alone. The synthesis of the new, more lipophilic 4-

pentoxypyridine-2,6-dicarbaldehyde (**4**) is described, too, and first transport experiments with liposomes are discussed.

Keywords: transport • dynamic combinatorial chemistry • imine • macrocycles • supported liquid membrane • liposomes

Introduction

Compartmentalization by membranes is most important for the existence of life. In the cell, numerous compounds must be transported from one location to another across membranes.¹ Nature has developed several tools: from channels which allow diffusion all the way to specific carriers. Supramolecular chemistry has investigated these different approaches, too.² Especially molecular recognition can be exploited also for the development of a selective transporting system. In a classical experiment, a host is chosen which may bind the specific guest to be transported across a membrane. As a model for the biological membrane either bulk organic layers,³ or polymer supported thin liquid membranes⁴ have been used. The guest must be recognized and taken from the

(aqueous) source phase, it must be bound efficiently, the resulting host-guest complex must be soluble in the membrane, and finally the guest must be released into the aqueous receiving phase. Therefore, a fine balance between thermodynamic binding parameters and kinetic uptake and release rates must be found. This usually requires an extensive optimization work.

One way to simplify selection and optimization processes is the use of dynamic combinatorial chemistry (DCC).⁵ In the beginning of DCC, the search of an optimal host for a given guest was the central focus, and many dynamic combinatorial libraries (DCLs) have been investigated in the search of a good host for a given guest. All DCC experiments have in common that the interaction of the guest with a host stabilizes a particular host, and thus the dynamic equilibrium of several potential host molecules changes the composition of the DCL and forms the most stable system. A good match between a host and a guest can be used for several purposes, e. g. for analysis (sensing), for purification (extraction), or for transport. These applications have now come into focus of DCC. Besides sensing⁶ and extraction,⁷ first transport experiments across bulk liquid membranes have been described.^{8,9} Here, we like to present the first example of a transport across a supported liquid membranes (SLM) by a dynamic combinatorial library, and some experiments showing the selection of the most efficient transporter by its own guest. Moreover we present first preliminary transport experiment using liposomes as cell membrane mimics.

Results and Discussion

In previous work,⁸ we showed that a DCL formed by a reversible reaction between diamine **1** and dialdehyde **2** can be used to effect calcium transport across a bulk membrane. When the building blocks react in presence of calcium ions in the water source phase,

[a] V. Saggiomo, M. Sc., Dr. C. Goeschen, Prof. Dr. R. Herges, Prof. Dr. U. Lüning
Otto-Diels-Institut für Organische Chemie
Christian-Albrechts-Universität zu Kiel
Olshausenstr. 40, D-24098 Kiel, Germany
Fax: (+)49-431-880-1558
E-mail: luening@oc.uni-kiel.de

[b] Dr. R. Quesada
Departamento de Química
Universidad de Burgos
E-09001 Burgos, Spain

‡ Dynamic Combinatorial Chemistry, Part 4. For Part 3, see ref. 8.

Supporting information for this article is available on the WWW under <http://www.chemedurf.org/> or from the author.

macrocycle **3** is formed, along with linear oligo- and polymers, and it transports calcium ions from the water source phase to the water receiver phase.⁸ The good water solubility of complex **3**•Ca²⁺¹⁰ is supposed to be the weakness of its carrier activity. In fact, most of the complex was found in the water source phase.⁸

First, we repeated the same experiment using a supported liquid membrane¹¹ (SLM) (Figure 1, building blocks **1** and **2**). In an SLM experiment, the water source phase is separated from the water receiver phase by a polymeric membrane (polypropylene) soaked with organic solvent (*o*-nitrophenyl octyl ether, NPOE). The solvent polarity of NPOE was determined using a solvatochromic dye.¹² It was found to be $E_T^N = 0.33$, slightly different from the $E_T^N = 0.31$ of dichloromethane found in literature¹² and less polar than that of dichloromethane (distilled but not dry) used in our laboratory ($E_T^N = 0.34$).¹³

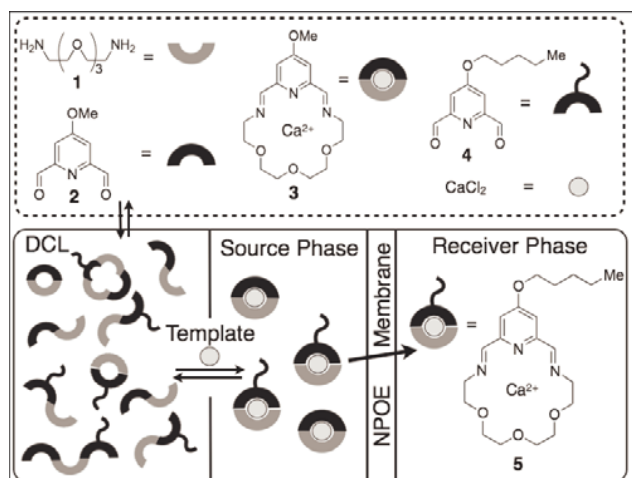

Figure 1. Building Blocks (**1**, **2** and **4**), detected products (**3** and **5**) used and their cartoon representations. Set-up of the transport experiment across a supported liquid membrane (SLM) facilitated by a dynamical combinatorial library (DCL).

The two water phases were gently stirred and the conductivity in the receiver phase was recorded by means of a conductivity meter. Calcium chloride was chosen for its low solubility in organic solvents with respect to other salts (e. g. calcium nitrates or picrates are, thanks to the counter ions, more lipophilic and thus more soluble in organic media).¹⁴ Due to the lipophobicity of calcium chloride, the control experiment with a solution of calcium chloride in the source phase showed that hardly any calcium ions pass across the membrane (Figure 2d, conductivity after 48 h = $0.25 \mu\text{S cm}^{-1}$).

On the contrary, when the two building blocks **1** and **2** were dissolved, equilibrated for one hour and then used as source phase, the formed imino macrocycle **3** was able to transport calcium (conductivity after 48 h = $1.02 \mu\text{S cm}^{-1}$, Figure 2b). In two separate control experiments, the building blocks were dissolved separately in absence of the other respective building block in the calcium solution (source phase). Although the two building blocks interact with the supported liquid membrane carrying calcium in the receiver phase, the sum of their single transport activities is less than that of the macrocycle **3** (conductivity after 48 h = $0.86 \mu\text{S cm}^{-1}$, Figure 2c).

In order to improve the transport activity of the macrocycle, a lipophilic dialdehyde was synthesized. In three steps, dialdehyde **4** was obtained from commercially available chelidamic acid (**6**) (Scheme 1).

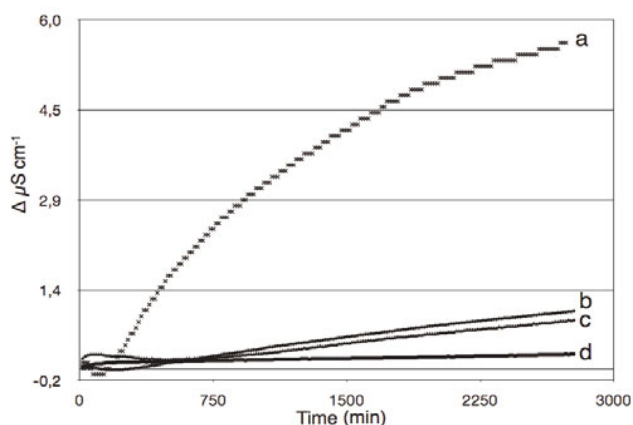
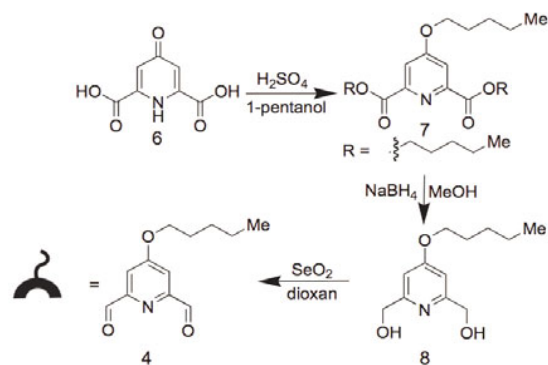

Figure 2. Transport of calcium ions through a SLM using dialdehyde **2** or **4** and diamine **1**. The conductivity in the receiver phase is plotted against time. In all experiments, the water source phase consisted of: 10 mM solution of CaCl₂ with: a) 0.1 mmol of **1** and 0.1 mmol of **4**; b) 0.1 mmol of **1** and 0.1 mmol of **2**; c) calculated sum of conductivities of **1** (0.1 mmol) and **2** (0.1 mmol) from two separate experiments in which they were dissolved separately in absence of the other respective building block; d) no addition of building blocks.

The latter was reacted with 1-pentanol in presence of a catalytic amount of sulphuric acid to give 4-pentoxo substituted diester **7**. After reduction with sodium borohydride, alcohol **8** was obtained. This alcohol is a bench stable product and can be stored at room temperature without any decomposition. A fast oxidation with selenium dioxide gives the desired dialdehyde **4** ready to be used



after a simple purification.

Scheme 1. Synthesis of dialdehyde **4** and its cartoon representation

The two dialdehydes **2** and **4** differ only in the pentyl chain in 4-position of the pyridine. Thus the formation of the imino macrocycle **5** in presence of calcium ions as template and its complexing ability should be only marginally different from imino macrocycle **3**.^{8,10} As proof of the formation of the imino macrocycle **5**, the DCL composed of diamine **1** and dialdehyde **4** was screened by the mean of ¹H-NMR in presence and absence of calcium chloride (using CD₃OD and H₂O/D₂O as solvent). When calcium is present, only one peak in the imine region (8.64 ppm) and one in the pyridine region (7.55 ppm) could be detected in the NMR spectra

(see Supplementary Information).¹⁵ Subsequently, the above described SLM experiment was repeated using dialdehyde **4** instead of **2**. Figure 2a clearly shows that the calcium transport activity of macrocycle **5** is approximately six times better than that of macrocycle **3** (conductivity after 48 h = $5.70 \mu\text{S cm}^{-1}$). The shape of this curve (Figure 2a) is not linear as those of the previous transport experiments (Figure 2b – 2d), however the non-linearity of transport curves has been observed before and has been discussed and explained as a decomplexation rate-limited transport.^{16,17}

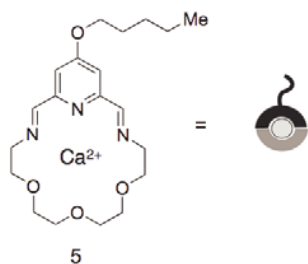

Figure 3. Macrocycle **5** and its cartoon representation.

In addition to the conductivity measurements, the presence of calcium ions in the receiver phase has also been verified using a titration method (Aquamerck[®] Calcium Test). Even near the detection limit (2 mg L^{-1}), this test reveals calcium ions in the receiver phase.

A control experiment with dialdehyde **4** alone dissolved in the calcium source solution was not possible due to its low solubility in water. However when the dialdehyde **4** was dissolved in NPOE it did not show any carrier activity.

Experiments using magnesium chloride and barium chloride were also carried out. A 10 mM solution of magnesium chloride was not able to dissolve the building blocks and it was impossible to use the milky solution as source phase. When a 10 mM solution of barium chloride was used instead, the solution became clear and an increase of conductivity in the receiver phase could be measured. In this case, the conductivity after 48 h was: $2.33 \mu\text{S cm}^{-1}$. This is lower than when calcium is the ion in the source phase showing a small preference of imino macrocycle **5** to transport calcium over barium.^{18,19}

In another experiment, a dynamic library composed of dialdehydes **2** and **4** (4 mM each) and two equivalents of diamine **1** was generated in a 12.5 mM solution of calcium chloride. The formed DCL was used as source phase in a DCC-SLM experiment. The receiver phase, monitored by the use of a conductivity meter, showed a flux comparable to the above experiment with only calcium carrying macrocycle **5**. In intervals, the source phase was screened by ¹H-NMR by analyzing 550 μL samples of the source phase to which 50 μL of D₂O were added. The water residue peak in the NMR spectra was removed during acquisition using arbitrary waveforms and pulsed field gradient.²¹ In the resulting spectra, two well distinguishable peaks are partially overlapping in the imine region, and two well separated peaks for the pyridine hydrogen atoms could be easily assigned to the respective macrocycles **3** (7.35 ppm) and **5** (7.32 ppm) (Figure 4b). At different times, the ratio between **3** and **5** could be calculated from the integration of the respective peaks (Figure 4c). In Figure 4a, the ratio **3/5** is plotted versus time showing that macrocycle **5** is leaving the source phase.

In a control experiment, in which the solution containing the two macrocycles **3** and **5** was not used as a source phase, the ratio between the two macrocycles remains constant over time [Figure 4a (O)]. The shape of the curve (+) in the source phase is similar to the shape of the curve of conductivity in the receiver phase (as example see Figure 2a). Thus two different detection methods, NMR in the source phase for macrocycles and conductivity in the receiver phase for the calcium complexes, prove the same fact: macrocycle **5** leaves the source phase carrying calcium to the receiver phase. Starting from a DCL of three building blocks and one template ion, two macrocycles are selected and amplified from the mixture of macrocycles, oligomers and polymers due to their calcium complex stabilities and one shows a better transport activity than the other.

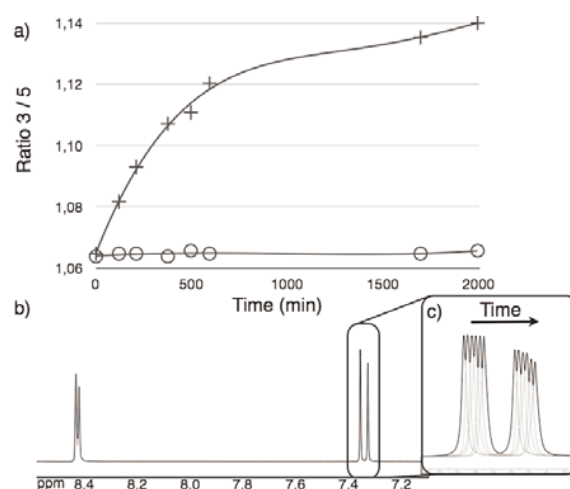

Figure 4. a) Ratio of **3/5** vs. time (+) calculated from the integration of the pyridine peaks at 7.35 and 7.32 ppm. (O): Control experiment (see text). b) ¹H-NMR of water source phase. c) Expanded section of peaks at 7.35 and 7.32 over time.

After these results, we carried out some preliminary experiments in order to explore the possibility of screening for a carrier mediated by a DCL with a biologically relevant membrane. In this regard, liposomes are widely used as cell membrane mimics. Our approach was to use unilamellar phospholipid vesicles (1-palmitoyl-2-oleoyl-sn-glycero-3-phosphocholine, POPC) loaded with sodium chloride and dispersed in a sodium nitrate solution. Incorporation and movement of macrocycle **5** through the phospholipid membrane could promote counterion transport driven by the concentration gradient in a symport mechanism. Chloride release from the interior of the vesicles to the external medium can be easily monitored by using a chloride selective electrode.²²

Briefly, POPC vesicles (100 nm mean diameter) loaded with NaCl (488mM, 5 mM phosphate buffer, pH=7.2) were suspended in a NaNO₃ solution (488mM, 5 mM phosphate buffer, pH=7.2) for a final lipid concentration of 1 mM. To this dispersion, 5 mol% (calculated as building blocks/POPC) of the dynamic combinatorial library composed of diamine **1** and dialdehyde **4** previously equilibrated in a solution of Ca(NO₃)₂ was added, and the chloride ion efflux was monitored by a chloride ion selective electrode (ISE) over time. After ten minutes, the vesicles were lysed by addition of detergent and the final reading of the electrode was used to calibrate 100% release of chloride. For comparison purposes, control

experiments using similar amounts of $\text{Ca}(\text{NO}_3)_2$ solution without any of the library components or just one them, either **1** or **4**, were carried out. The results obtained are shown in figure 5.

Addition of dialdehyde **4** or diamine **1** (Figure 5, **4** = ●, **1** = □) induced a fast initial chloride efflux which quickly reached a plateau. This result could be due to a small initial detergent effect exerted by these compounds. Nevertheless, the plateau shows that after the initial phase, the remaining liposomes are stable in the presence of the starting materials for the DCL. Addition of both compounds **1** and **4**, i. e. the library/carrier, results in a small yet constant chloride efflux from the liposomes (Figure 5, +). This efflux is more than two times faster than the blank experiment in which only the same aliquot (40 μL) of $\text{Ca}(\text{NO}_3)_2$ solution was added (Figure 5, O). Although the overall chloride efflux observed in these experiments is quite limited it must be stressed that macrocycle **5** has no affinity at all for anions therefore an efficient chloride transport was not expected. On the other hand, it seems clear that addition of the carrier induces a significantly faster chloride efflux compared to the control experiments. This result shows promise for the development of dynamic combinatorial libraries for ion pair transporters and the use of this approach in biomimetic environments.

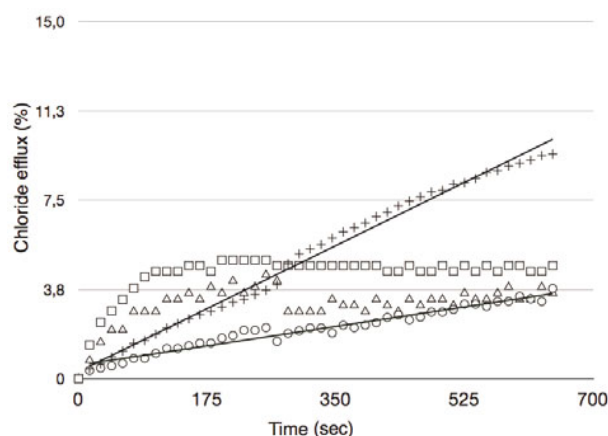

Figure 5. Chloride efflux from 100 nm POPC liposomes promoted by addition of 40 μL of $\text{Ca}(\text{NO}_3)_2$ solution (488 mM, O); 5 mol% (per POPC) of dialdehyde **4** in 10 μL of DMSO (●); 5 mol% (per POPC) of diamine **1** in 40 μL of $\text{Ca}(\text{NO}_3)_2$ solution (488 mM, □); 5 mol% (per POPC) of the dynamic combinatorial library composed of diamine **1** and dialdehyde **4** in 40 μL of $\text{Ca}(\text{NO}_3)_2$ solution (488 mM, +). The liposomes (1 mM POPC) contained NaCl (488 mM) and were immersed in NaNO_3 (488 mM) in a 5 mM phosphate buffer (pH 7.2). 100 % efflux was always achieved by destroying the liposomes upon addition of detergent. The straight lines through the data points are only drawn to guide the reader's eye.

Conclusion

The concept of using a DCL to find a matching carrier for a particle to be transported across a membrane (here: calcium ions) has been proven here. From a DCL consisting of building blocks of varying lipo- and hydrophilicity, calcium ions select their proper host (**5**) for transport across a supported liquid membrane. In contrast to most DCC experiments, here the amplification process is dual: first calcium ions amplify the formation of matching macrocycles **3** and **5** from the dynamic mixture of oligomers, polymers and hosts, then

second, the systems selects complex **5**• Ca^{2+} over complex **3**• Ca^{2+} for the transport process due to **5**'s better balance of lipo- and hydrophilicity. Complex **5**• Ca^{2+} bears a long lipophilic chain but is still water soluble and is able to pass through the NPOE membrane thus transporting calcium ions. In future experiments, pyridine dialdehydes such as **2** or **4** shall be mixed with diamines of varying length to find suitable carriers for different cations in this kind of double selection experiment. The DCC-SLM experiment described here could also be used to analyze other complex DCL mixtures. The fittest species will cross the membrane and can then easily be detected in the receiver phase, separated from all other components of the library.

Preliminary experiments show that this methodology can also be used to screen the capability of carriers to cross phospholipid membranes. This is the first experiment on the way to use a DCL directly in a biomimetic system. The methodology of selecting a carrier from a dynamic combinatorial library therefore is very versatile: we started by screening its carrier ability with a bulk membrane⁸ that has a thickness of centimeters, next we moved to a supported liquid membrane possessing a thickness of millimeters and with the last experiment we used liposomes which possess a thickness of nanometers.

Experimental Section

Remarks

TraceSELECT[®] Water was obtained commercially from Fluka and was used for the source phase solution as well as for the receiver phase in the transport experiment. *o*-Nitrophenyl octyl ether (NPOE) was obtained from Aldrich and was purified as described below before use in transport experiments. Polypropylene Accurel[®] PP was obtained from AkzoNobel. Aquamerck[®] Calcium Test was obtained from Merck; for its use see ref.⁸ 3,6,9-Trioxa-1,11-undecanediamine (**1**) and 4-methoxypyridine-2,6-dicarbaldehyde (**2**) were synthesized according to literature.²³ Chelidamic acid (**6**) was synthesized using standard procedures or obtained from Aldrich. For a complete characterization of the imino macrocycle **3** see ref.¹⁰. The conductimeter used was LF 340 from WTW with automatic data storage (15 min) and non-linear compensation of the temperature set to 20 °C. During the transport experiments, the temperature varied from 19 °C to 21 °C. The probe was LR 325/01 (WTW) with a cell constant of 0.100 cm^{-1} . The molar conductance of calcium chloride is $271.56 \cdot 10^{-4} \text{ m}^2 \text{ S mol}^{-1}$, and $279.82 \cdot 10^{-4} \text{ m}^2 \text{ S mol}^{-1}$ for barium chloride.²⁰ The glassware (quartz) used for the transport experiment had a half cell volume of 25 mL, a section of $8.553 \cdot 10^{-4} \text{ m}^2$ and is described in the Supplementary Information. NMR spectra were recorded with Bruker DRX 500 or AV 600 instruments. Assignments are supported by COSY, HSQC and HMBC. All chemical shifts are referenced to TMS or to the residual proton or carbon signal of the solvent (CD_3OD , 3.35 ppm ^1H , 49.0 ppm ^{13}C). Mass spectra were recorded with a Finnigan MAT 8200 or MAT 8230. ESI mass spectra were recorded with an Applied Biosystems Mariner Spectrometry Workstation. IR spectra were recorded with a Perkin-Elmer Paragon 1000, equipped with an ATR unit. Elemental analyses were carried out with a EuroEA 3000 Elemental Analyzer from Euro Vector.

Transport Experiments:

All glassware were washed with bidistilled water and rinsed with *TraceSELECT*[®] Water before use. The experiments were repeated at least 2 times, also with different concentrations in the source phase (10 or 12.5 mM calcium chloride) proving the reproducibility of the experiments.

Membrane: Commercial NPOE was purified by a short column chromatography (1:5 NPOE / silica gel (w/w), dichloromethane). The solvent was removed under reduced pressure and the oily residue was left under vacuum in an ultrasonic bath for 12 h before use. A square 4.5 · 4.5 cm of micropore polypropylene polymer Accurel[®] PP was cut and soaked with 300 mg of NPOE. The membrane was left under vacuum in a desiccator for 12 h before use.

Source phase: In 25 mL of 10 mM calcium chloride solution (*TraceSELECT*[®] Water) were dissolved 100 μmol of dialdehyde (**2** or **4**) and 19.1 mg (100 μmol) of 3,6,9-trioxa-1,11-undecanediamine (**1**). The solution was vigorously stirred until complete dissolution of the building blocks. When the solution became clear (from 30 min to 2 h depending on the dialdehyde) it was used as source phase in the experiment.

Receiver phase: 25 mL of TraceSELECT® Water, blank conductivity between 1 and 1.5 μS .

DCL-transport experiment: The membrane was prepared as described above.

Source phase: In 25 mL of 12.5 mM calcium chloride solution (TraceSELECT® Water) were dissolved 16.5 mg (100 μmol) of 4-methoxypyridine-2,6-dicarbaldehyde (**2**), 22.1 mg (100 μmol) of 4-pentoxo-2,6-dicarbaldehyde (**4**) and 38.2 mg (200 μmol) of 3,6,9-trioxa-1,11-undecanediamine (**1**). The solution was vigorously stirred until complete dissolution of the building blocks. When the solution became clear it was used as source phase in the experiment. A 550 μL aliquot from the source phase was taken and mixed with 50 μL of D_2O . The resulting solution was put in a NMR tube and ^1H -NMR spectra were recorded at different times as the control experiment. At different times, 550 μL aliquots were taken from both phases (source and receiver), the 550 μL aliquot from the source phase was mixed with 50 μL of D_2O , put in a NMR tube and the ^1H -NMR spectra were recorded.

The receiver phase was set up as described above.

Preparation of phospholipid vesicles:

A solution of 1-palmitoyl-2-oleoyl-sn-glycero-3-phosphocholine (POPC, Genzyme) in chloroform (20 mg/mL) was evaporated forming a lipid film. This latter was dried under vacuum for 12 h. The lipid film was rehydrated with a solution of sodium chloride (488 mM of NaCl and 5 mM of phosphate buffer, pH 7.2) and shaken by vortex. The suspension was then subjected to nine freeze-thaw cycles and 29 extrusions through a 100 nm polycarbonate Nucleopore membrane using a Liposofast Basic extruder (Avestin) in order to obtain unilamellar vesicles with a mean diameter of 100 nm. Finally, the suspension was dialysed against a NaNO_3 solution (488 mM NaNO_3 and 5 mM phosphate buffer, pH 7.2) to remove unencapsulated NaCl.

Ion selective electrode transport assays:

Unilamellar vesicles (POPC, 100 nm mean diameter) prepared as described above were suspended in a solution of NaNO_3 (488 mM, and phosphate buffer, 5 mM, pH 7.2) for a final POPC concentration of 1 mM. The dynamic combinatorial library composed of dialdehyde **4** and diamine **1** (6.25 mM each) was equilibrated for 12 h in a solution of $\text{Ca}(\text{NO}_3)_2$ (488 mM, phosphate buffer, pH 7.2, 5 mM) before use. 40 μL of this solution was added to 5 mL of the vesicle suspension (resulting in 5 mol% of library to POPC) and the chloride ion release was monitored using an Accumet chloride selective electrode. After 10 min, the vesicles were lysed by addition of detergent (Triton-X) to release all chloride ions (by definition giving 100% conductivity). The blank experiments with the $\text{Ca}(\text{NO}_3)_2$ solution and diamine **1** were carried out in the same way. Due to the low solubility of dialdehyde **4**, it was dissolved (25 mM) in DMSO and 10 μL of this solution (corresponding to 5 mol% relative to POPC) was added to the vesicle suspension (5 mL). The experiment was repeated three times and the average of the chloride efflux was plotted over time.

Syntheses:

Dipentyl 4-pentoxypyridine-2,6-dicarboxylate (7): 500 mg (3.62 mmol) of chelidamic acid (**4**) was dissolved in 30 mL of 1-pentanol, and 0.2 mL of concentrated sulphuric acid was added. The solution was attached to a Dean-Stark trap and left refluxing for 4 h while stirring. Then the solvent was removed under reduced pressure, the residue was dissolved in chloroform and washed with water (2 x 20 mL). The organic phase was dried with MgSO_4 . Chloroform was removed under reduced pressure and the oily residue was purified by column chromatography (silica gel, chloroform) giving 869 mg (2.21 mmol, 61 %) of the final product **5** as a colorless oil. R_f [CHCl_3] = 0.12. CI-MS [Isobutane] = calcd. for $\text{C}_{22}\text{H}_{35}\text{NO}_5$: 393.25; found : 394.0 (M+H⁺). Elem. Anal. = calcd. for $\text{C}_{22}\text{H}_{35}\text{NO}_5$: C 67.15, H 8.96, N 3.56; found : C 66.98, H 9.24, N 3.51. IR: $\tilde{\nu}$ = 2953 (alkyl), 1716 (ester), 1591, 1442 (arom.) cm^{-1} . ^1H -NMR (500 MHz, 298 K, CDCl_3 , TMS): δ = 7.74 (s, 2H, Py), 4.39 (t, J = 7 Hz, 4H, COO- CH_2), 4.12 (t, J = 6.5 Hz, 4H, O- CH_2), 1.87-1.80 (m, 6H, O- CH_2 - CH_2 and COO- CH_2 - CH_2), 1.48-1.36 (m, 12H, CH_2 - CH_2 - CH_3), 0.96-0.91 (m, 9H, CH_3) ppm; ^{13}C -NMR (125 MHz, 298 K, CDCl_3 , TMS): δ = 166.98 (C-4-Py), 164.89 (C-2,6-Py), 150.21 (COO), 114.22 (C-3,5-Py), 68.99 (O- CH_2), 66.39 (COO- CH_2), 28.45, 28.24, 28.04, 27.99, 22.36, 22.34 (CH_2 - CH_2 - CH_2), 13.96 (CH_3) ppm.

4-Pentoxypyridine-2,6-bismethanol (8): 800 mg (2.05 mmol) of dipentyl 4-pentoxypyridine-2,6-dicarboxylate (**7**) was dissolved in 15 mL of dry methanol. 1.5 g (41 mmol) of NaBH_4 was slowly added to the solution at 0 °C. When the hydride was completely dissolved, the reaction was left under reflux for 4 h. Then at room temperature, 5 mL of a saturate aqueous solution of Na_2CO_3 was added and the solution was refluxed for additional 30 min. The solvent was removed under reduced pressure, the residue was dissolved in CHCl_3 and washed with water (2 x 15 mL). The organic phase was dried with MgSO_4 and the solvent was removed under reduced pressure. The crude product was purified by column chromatography, using silica gel and eluting with

$\text{CHCl}_3/\text{MeOH}$ 96:4 (v/v). Alcohol **8** was obtained pure as a white solid. 424 mg (1.88 mmol), 92 % yield. R_f [$\text{CHCl}_3/\text{MeOH}$ 96:4] = 0.20, m. p. 82-83 °C. ESI-MS: calcd. for $\text{C}_{12}\text{H}_{19}\text{NO}_3$: 225.14; found: 226.14 (M+H⁺), 248.12 (M+Na⁺). Elem. anal.: calcd. for $\text{C}_{12}\text{H}_{19}\text{NO}_3$: C 63.98, H 8.50, N 6.22; found: C 64.18, H 8.86, N 6.04. IR: $\tilde{\nu}$ = 3341 (OH), 2973 (alkyl), 1597, 1496 (arom.) cm^{-1} . ^1H -NMR (500 MHz, 298 K, CDCl_3 , TMS): δ = 6.63 (s, 2H, Py), 4.62 (s, 4H, CH_2 -OH), 3.95 (t, J = 6.5 Hz, 2H, O- CH_2), 3.65 (br, 2H, OH), 1.72 (quint, J = 7.2 Hz, 2H, O- CH_2 - CH_2), 1.39-1.28 (m, 4H, CH_2 - CH_2 - CH_3), 0.86 (t, J = 7.1 Hz, 3H, CH_3) ppm; ^{13}C -NMR (125 MHz, 298 K, CDCl_3 , TMS) δ = 165.77 (C-4-Py), 159.09 (C-2,6-Py), 104.67 (C-3,5-Py), 67.31 (O- CH_2), 63.26 (CH_2 -OH), 27.52 (O- CH_2 - CH_2), 27.00 (O- CH_2 - CH_2 - CH_2), 21.34 (CH_2 - CH_3), 12.95 (CH_3) ppm.

4-Pentoxypyridine-2,6-dicarbaldehyde (4): 424 mg (1.88 mmol) of 4-pentoxypyridine-2,6-bismethanol (**8**) was dissolved in 10 mL of dry dioxane and 207 mg (1.88 mmol) of SeO_2 was added. The solution was left refluxing for 6 h while stirring. Then the heterogenous solution was passed through a pad of celite and eluted with a small portion of dioxane. The solution was recovered and the solvent was removed under reduced pressure. The crude product was purified by column chromatography [silica gel, cyclohexane/ethyl acetate 1:1 (v/v)] giving a slightly yellow solid, 376 mg (1.70 mmol), 90 % yield. R_f [cyclohexane/ethyl acetate 1:1] = 0.25, m. p. 67-68 °C. ESI-MS: calcd. for $\text{C}_{12}\text{H}_{15}\text{NO}_3+\text{Na}^+$: 244.09; found: 244.09 (M+Na⁺). Elem. anal.: calcd. for $\text{C}_{12}\text{H}_{15}\text{NO}_3$: C 65.14, H 6.83, N 6.33; found: C 64.99, H 7.04, N 6.10. IR: $\tilde{\nu}$ = 2931 (alkyl), 1704 (C=O), 1591, 1448 (arom.) cm^{-1} . ^1H -NMR (500 MHz, 298 K, CDCl_3 , TMS): δ = 10.11 (s, 2H, CHO), 7.63 (s, 2H, Py), 4.14 (t, J = 6.5 Hz, 2H, O- CH_2), 1.88-1.82 (m, 2H, O- CH_2 - CH_2), 1.47-1.39 (m, 4H, CH_2 - CH_2 - CH_3), 0.94 (t, J = 7.0 Hz, 3H, CH_3) ppm; ^{13}C -NMR (125 MHz, 298 K, CDCl_3 , TMS) δ = 192.46 (CHO), 167.14 (C-4-Py), 154.72 (C-2,6-Py), 111.50 (C-3,5-Py), 69.34 (O- CH_2), 28.37 (O- CH_2 - CH_2), 27.94 (O- CH_2 - CH_2 - CH_2), 22.32 (CH_2 - CH_3), 13.95 (CH_3) ppm.

1^4 -Pentoxo-6,9,12-trioxa-3,15-diaza-1(2,6)-pyridinhexadecacyclophan-2,15-diene (5): In 10 mL of CD_3OD were dissolved 11.0 mg (50 μmol) of 4-pentoxypyridine-2,6-dicarbaldehyde (**4**), 11.5 mg (60 μmol) of 3,6,9-trioxa-1,11-undecanediamine (**1**) and 5.5 mg (50 μmol) of CaCl_2 . After 12 h, the solution was controlled by NMR, ESI and HR-MS. ESI-MS: calcd for $\text{C}_{20}\text{H}_{31}\text{N}_3\text{O}_4+\text{Na}^+$: 400.21, found: 400.22 (M+Na⁺). HR-MS (EI, 70 eV): calcd for $\text{C}_{20}\text{H}_{31}\text{N}_3\text{O}_4$: 377.23145, found 377.23146; calcd for $\text{C}_{19}^{13}\text{CH}_3\text{N}_3\text{O}_4$: 378.23480, found: 378.23545. ^1H -NMR (500 MHz, 298 K, CD_3OD): δ = 8.64 (t, J = 1.3 Hz, 2H, $\text{CH}=\text{N}$), 7.55 (s, 2H, Py), 4.31 (t, J = 6.4, 2H, (4-O- CH_2 - CH_2), 4.05 (t, J = 4.6, 4H, $\text{CH}=\text{N}$ - CH_2), 3.96-3.90 (m, 12H, $\text{CH}=\text{N}$ - CH_2 - CH_2 and O- CH_2 - CH_2 -O), 1.94-1.89 (m, 2H, 4-O- CH_2 - CH_2), 1.56-1.44 (m, 4H, CH_2 - CH_2 - CH_3), 1.00 (t, J = 7.2 Hz, 3H, CH_3) ppm; ^{13}C -NMR (125 MHz, 298 K, CD_3OD): δ = 170.47 (C-2,6-Py), 164.70 ($\text{CH}=\text{N}$), 154.40 (C-4-Py), 115.46 (C-3,5-Py), 72.52, 71.39, 79.83, 70.03 (CH_2 -O- CH_2 and $\text{CH}=\text{N}$ - CH_2), 58.25 (Py-O- CH_2), 29.55 (Py-O- CH_2 - CH_2), 29.13 (Py-O- CH_2 - CH_2 - CH_2), 23.40 (CH_2 - CH_3), 14.32 (CH_3) ppm.

Acknowledgments

We are grateful for support by the Marie Curie Research Training Network MRTN-CT-2006-035614 Dynamic Combinatorial Chemistry (DCC). We acknowledge Dr. Frank Sönichsen for his help in NMR spectroscopy.

- [1] a) R. MacKinnon, *Angew. Chem.* **2004**, *116*, 4363-4376; *Angew. Chem., Int. Ed.* **2004**, *43*, 4265-4277; b) P. Agre *Angew. Chem.* **2004**, *116*, 4363-4376; *Angew. Chem., Int. Ed.* **2004**, *43*, 4278-4290; c) Membrane transport, (Eds: S. L. Bonting and J. J. H. M. de Pont), North-Holland Biomedical Press, Amsterdam, **1981**.
- [2] A. L. Sisson, M. R. Shah, S. Bhosale, S. Matile, *Chem. Soc. Rev.*, **2006**, *35*, 1269-1286.
- [3] Early description of a respective experimental set-up: J.-P. Behr, J.-M. Lehn, *J. Am. Chem. Soc.*, **1973**, *95*, 6108-6110.
- [4] a) Early description of a SLM with NPOE: T. B. Stolwijk, E. J. R. Sudhölter, D. N. Reinhoudt, *J. Am. Chem. Soc.* **1987**, *109*, 7042-7047; b) A. Casnati, A. Pochini, R. Ungaro, C. Bocchi, F. Uguzzoli, R. J. M. Egberink, H. Struijk, R. Lugtenberg, F. de Jong, D. N. Reinhoudt, *Chem. Eur. J.*, **1996**, *2*, 436-445.
- [5] a) P. T. Corbett, J. Leclair, L. Vial, K. R. West, J.-L. Wietor, J. K. M. Sanders, S. Otto, *Chem. Rev.*, **2006**, *106*, 3652-3711; b) C. D. Meyer, C. S. Joiner, J. F. Stoddart, *Chem. Soc. Rev.*, **2007**, *36*, 1705-1723; c) S. J. Rowan, S. J. Cantrill, G. R. L. Cousins, J. K. M. Sanders, J. F. Stoddart, *Angew. Chem. Int. Ed.*, **2002**, *41*, 898-952; d) O. Storm, U. Lüning, *Chem. Eur. J.*, **2002**, *8*, 793-798.
- [6] A. Buryak, K. Severin, *J. Comb. Chem.*, **2006**, *8*, 540-543.

- [7] D. M. Epstein, S. Choudhary, M. R. Churchill, K. M. Keil, A. V. Eliseev, J. R. Morrow, *Inorg. Chem.*, **2001**, *40*, 1591-1596.
- [8] V. Saggiomo, U. Lüning, *Chem. Commun.*, **2009**, *25*, 3711-3713.
- [9] R. Pérez-Fernandez, M. Pittelkow, A. M. Belenguer, L. A. Lane, C. V. Robinson, J. K. M. Sanders, *Chem. Commun.*, **2009**, *25*, 3708-3710.
- [10] V. Saggiomo, U. Lüning, *Eur. J. Org. Chem.*, **2008**, 4329-4333.
- [11] a) H. C. Visser, D. N. Reinhoudt, F. de Jong, *Chem. Soc. Rev.*, **1994**, 75-81; b) N. M. Kocherginsky, Q. Yang, L. Seelam, *Sep. Pur. Technol.*, **2007**, *53*, 171-177.
- [12] C. Reichardt, *Chem. Rev.*, **1994**, *94*, 2319-2358.
- [13] $E_T(30)$ values are based on the solvatochromic pyridinium *N*-phenolate betaine dye as probe molecule. E_T^N is the normalized value using water and tetramethylsilane as extreme polar and nonpolar reference solvents, respectively.
- [14] Y. Marcus, *Ion Solvation*, Wiley & Sons, New York, **1985**.
- [15] Macrocycle **5** was characterized in solution by ^1H -, ^{13}C -NMR, ESI-MS and HRMS.
- [16] E. G. Reichwein-Buitenhuis, H. C. Visser, F. de Jong, D. N. Reinhoudt, *J. Am. Chem. Soc.*, **1995**, *117*, 3913-3921.
- [17] It should be noted that this experiment is a proof of concept and it was not our goal to optimize the supported liquid membrane experiment. For this reason, the calcium chloride solution was 10 mM instead of 1 M, usually used as source phase in this kind of experiment. Moreover we did not use any "strip solution" as receiver phase. The use of an acidic receiver phase (strip solution) improves drastically the flux of ions through the membrane, as the driving force in this case is the difference in pH. In our experiment, the only driving force are the different calcium concentrations in the two water phases (10 and 0 mM initially).
- [18] The difference in binding of a barium or a calcium ion may be rationalized by the fact that, in the crystal structure, the calcium ion is located in the plane of the macrocycle, while barium is displaced. The barium complex is isostructural with the strontium complex: D. E. Fenton, D. H. Cook, *J. Chem. Soc., Chem. Commun.*, **1978**, 279-280.
- [19] The influence of BaCl_2 on conductivity is comparable with that one of CaCl_2 . The molar conductivities are 279.82 and $271.56 \cdot 10^{-4} \text{ m}^2 \text{ S mol}^{-1}$ respectively,²⁰ and this cannot explain the big difference measured in the receiver phase.
- [20] D. R. Lide, *Handbook of Chemistry and Physics*, 80th edition, CRC Press, Boca Raton, **1999-2000**.
- [21] T. L. Hwand, A. J. Shaka, *J. Magn. Reson. Ser. A.*, **1995**, *112*, 275-279.
- [22] J. T. Davis, P. A. Gale, O. A. Okunola, P. Prados, J. C. Iglesia-Sánchez, T. Torroba, R. Quesada, *Nature Chem.*, **2009**, 138-144.
- [23] U. Lüning, R. Baumstark, K. Peters, H. G. v. Schnering, *Liebigs. Ann. Chem.*, **1990**, 129-143.

Received: ((will be filled in by the editorial staff))

Revised: ((will be filled in by the editorial staff))

Published online: ((will be filled in by the editorial staff))

Supplementary Information For:

Ion Transport Across Membranes Facilitated by a Dynamic Combinatorial Library

Vittorio Saggiomo,^a Catrin Goeschen,^a Rainer Herges,^a Roberto Quesada,^b Ulrich Lüning*,^a

[a] Otto-Diels-Institut für Organische Chemie, Olshausenstr. 40, D-24098 Kiel, Germany.
Fax: +49-431-880-1558; Tel: +49-431-880-2450; E-mail: luening@oc.uni-kiel.de

[b] Departamento de Química, Universidad de Burgos, E-09001 Burgos, Spain.

Contents	page
Glassware	2
Dipentyl 4-pentoxypyridine-2,6-dicarboxylate (7)	3
¹ H-NMR	3
¹³ C-NMR	4
4-Pentoxypyridine-1,6-bismethanol (8)	5
¹ H-NMR	5
¹³ C-NMR	6
4-Pentoxypyridine-2,6-dicarbaldehyde (4)	7
¹ H-NMR	7
¹³ C-NMR	8
14-Pentoxy-6,9,12-trioxa-3,15-diaza-1(2,6)- pyridinahexadecacyclophan-2,15-diene (5)	9
¹ H-NMR	9
¹³ C-NMR	10
COSY	11
DCL of 4 and 1 in presence and absence of CaCl ₂	12
¹ H-NMR	12
DCC-SLM - Source Phase	13
¹ H-NMR ratio/time	13

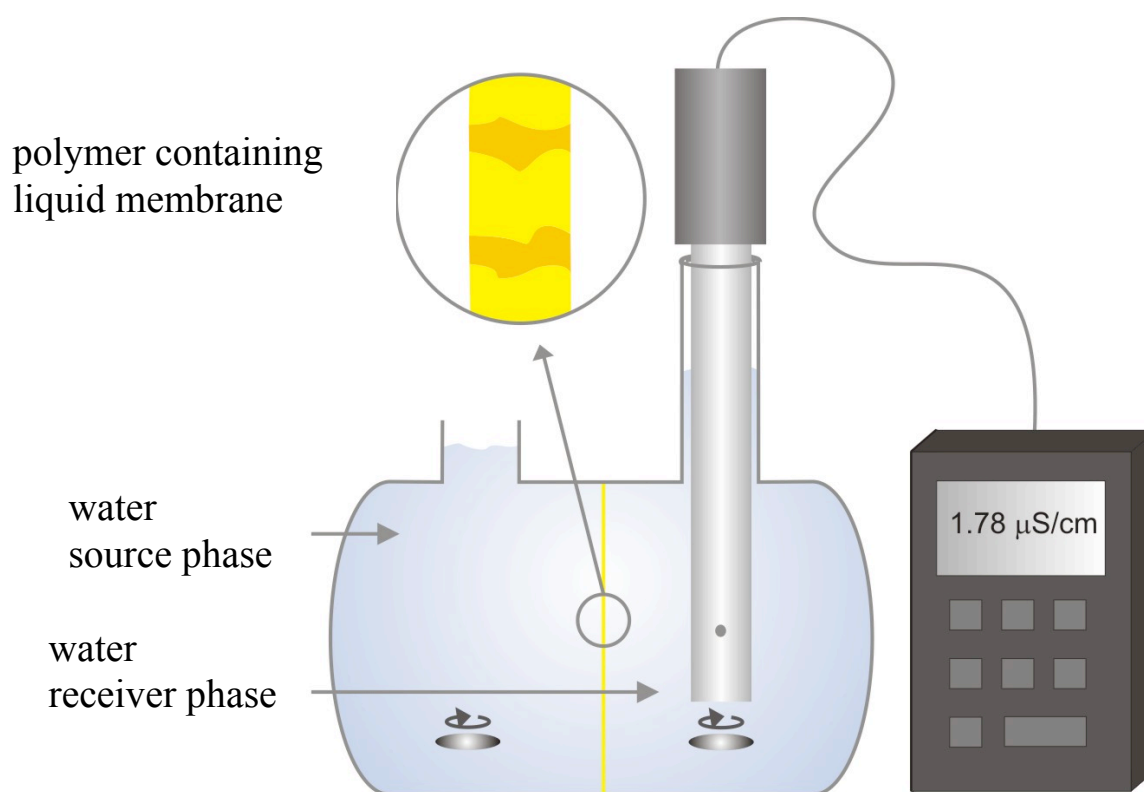

Figure 1: Glassware (quartz) used and set-up for the Dynamic Combinatorial Chemistry - Supported Liquid Membrane experiment (DCC-SLM)

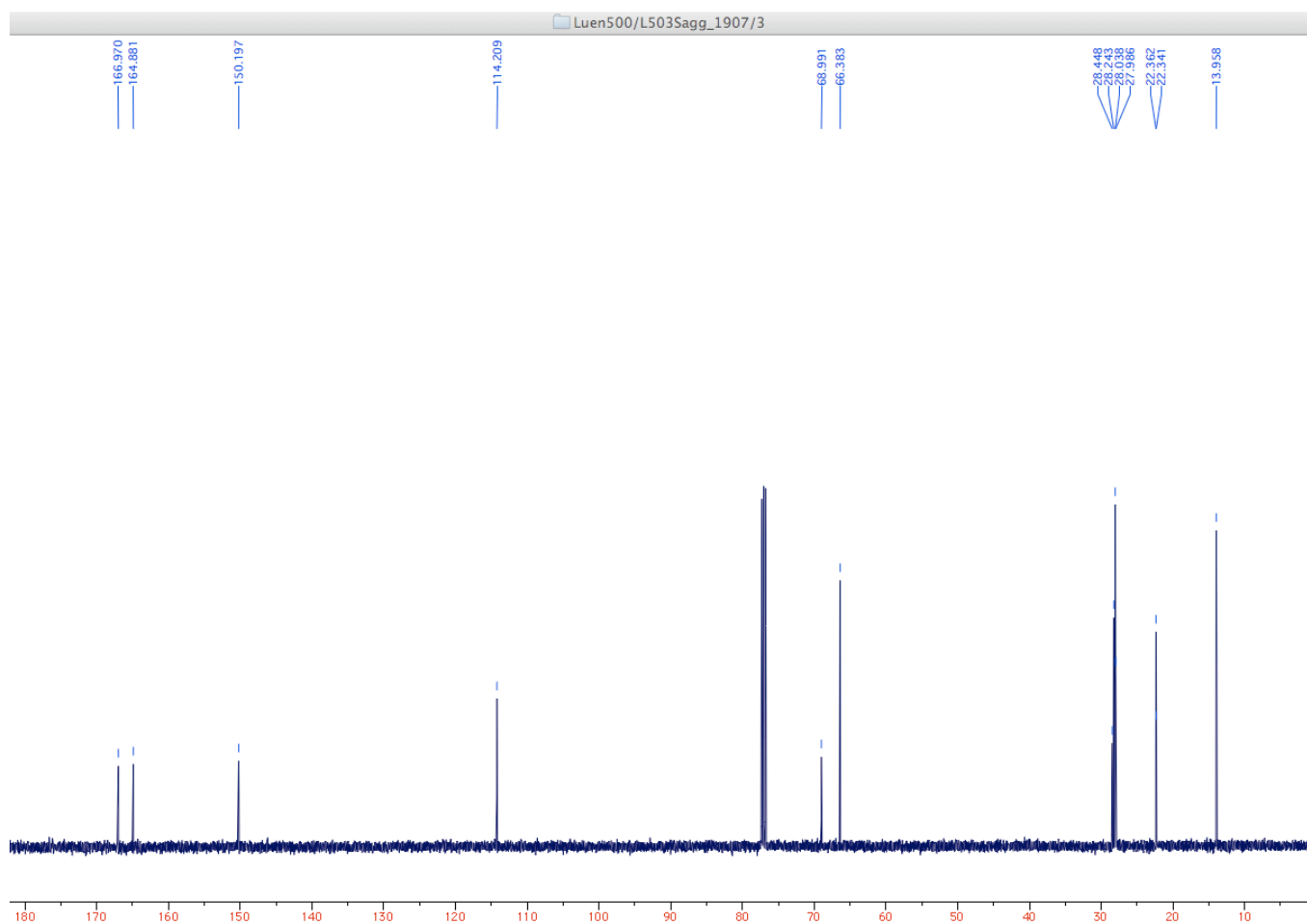
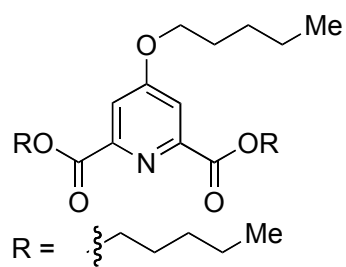

Figure 3: ^{13}C -NMR (125 MHz, 298 K, CDCl_3 , TMS) of product 7

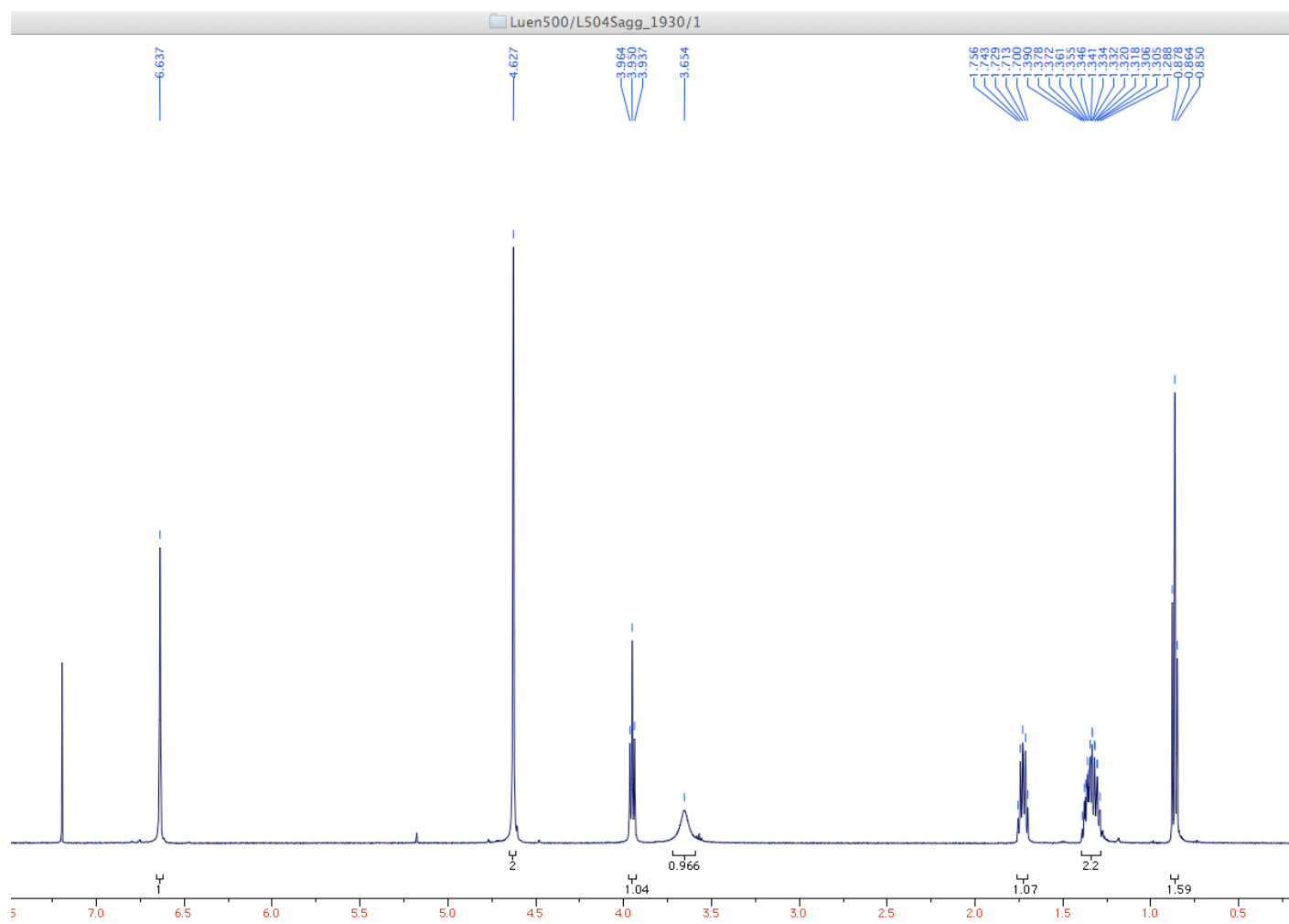
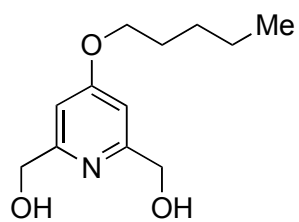

Figure 4: $^1\text{H-NMR}$ (500 MHz, 298 K, CDCl_3 , TMS) of product **8**

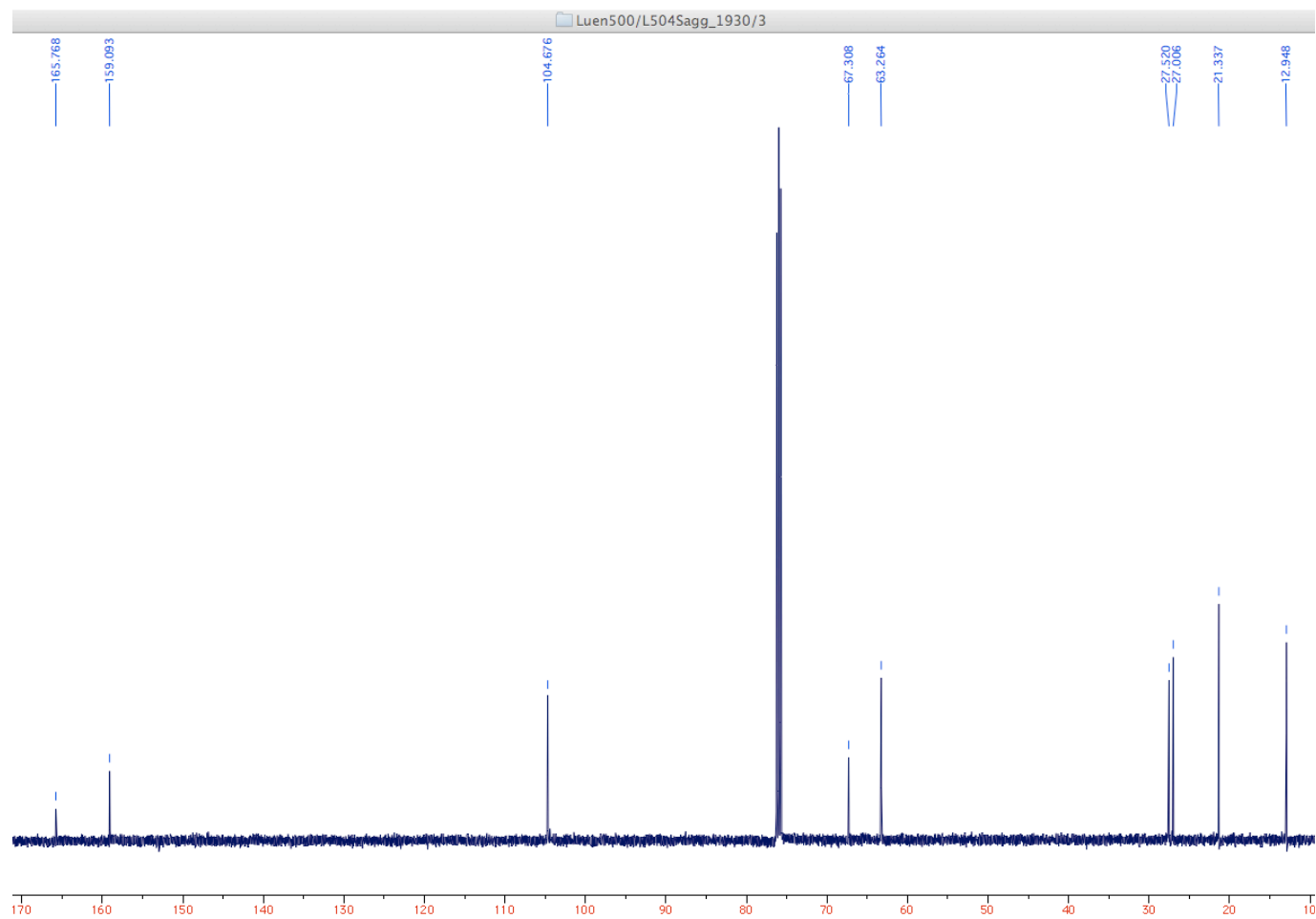
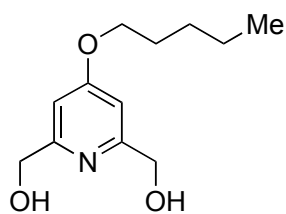

Figure 5: ¹³C-NMR (125 MHz, 298 K, CDCl₃, TMS) of product 8

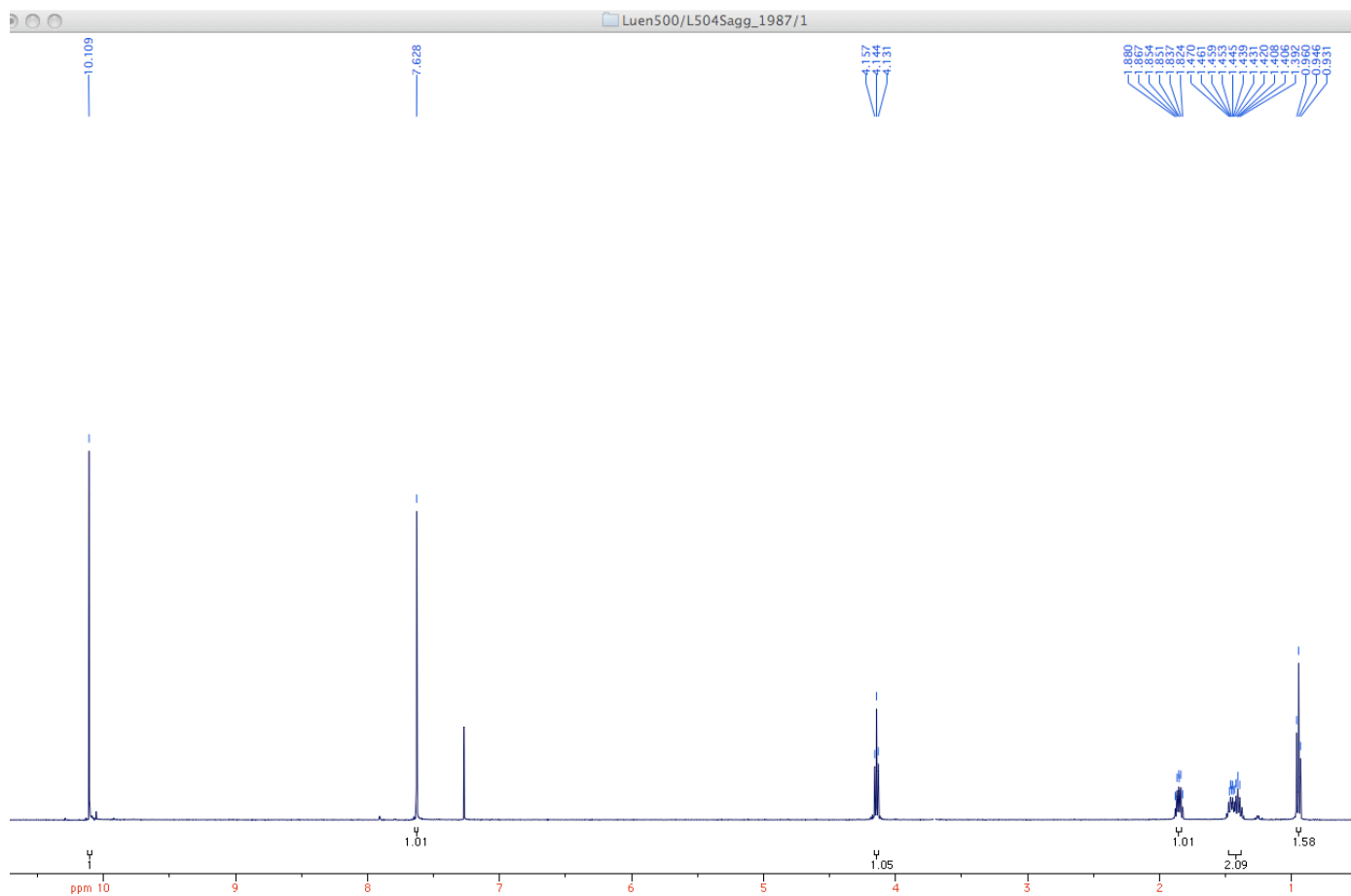
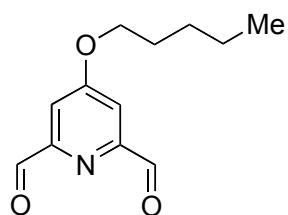

Figure 6: ¹H-NMR (500 MHz, 298 K, CDCl₃, TMS) of product 4

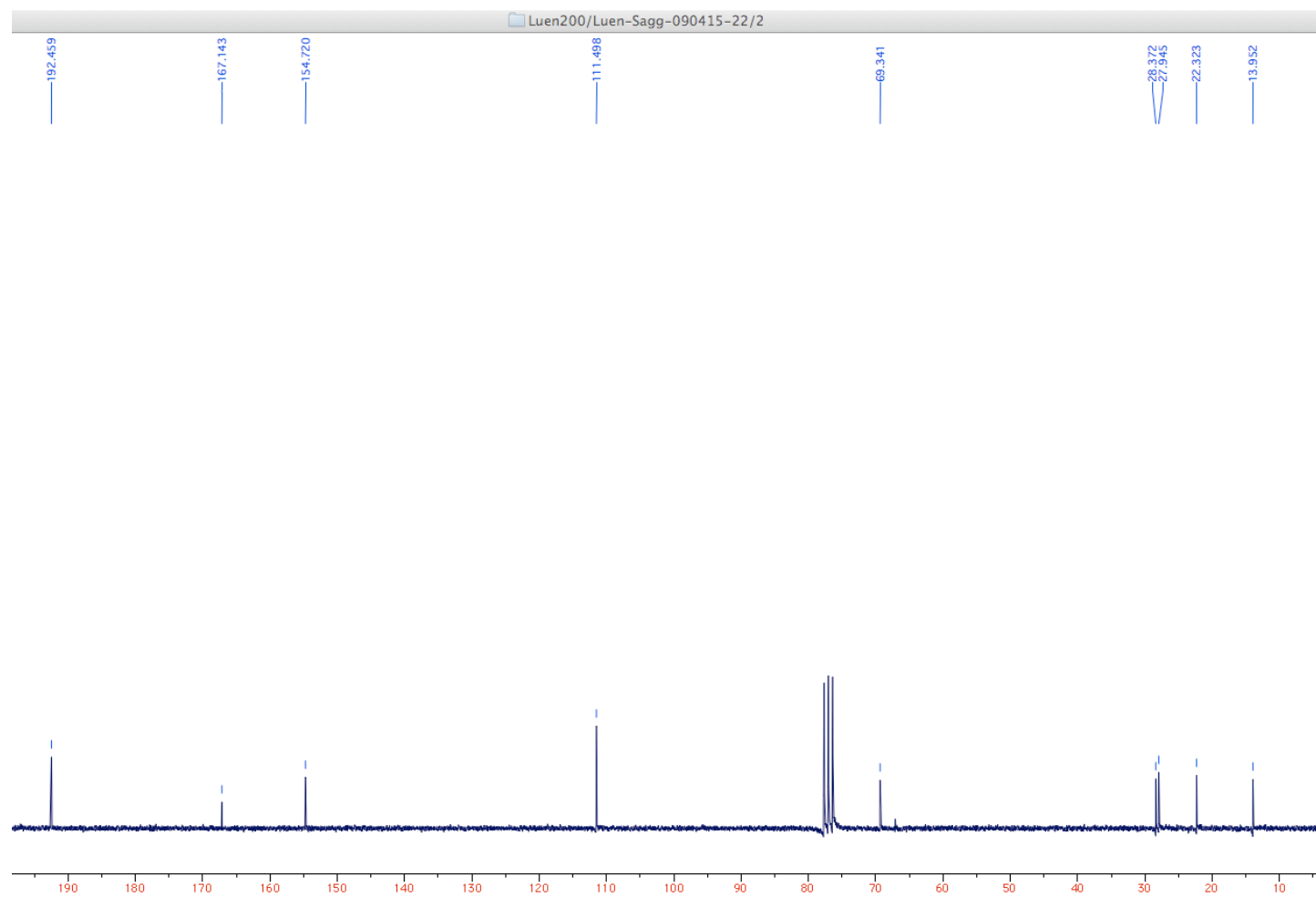
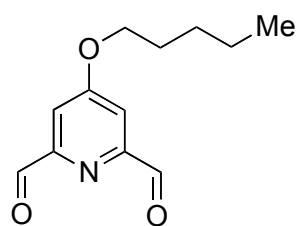

Figure 7: ^{13}C -NMR (125 MHz, 298 K, CDCl_3 , TMS) of product 4

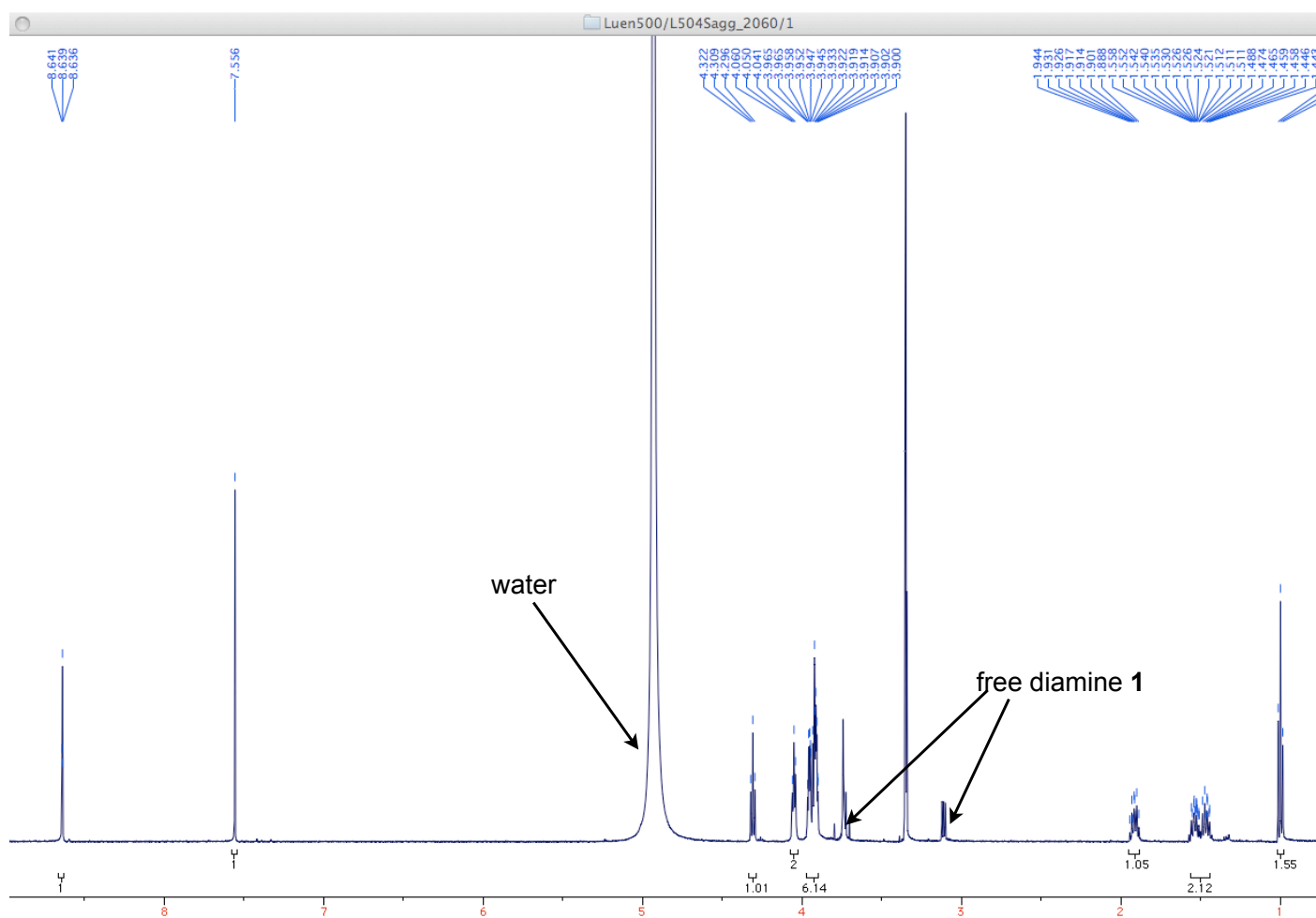
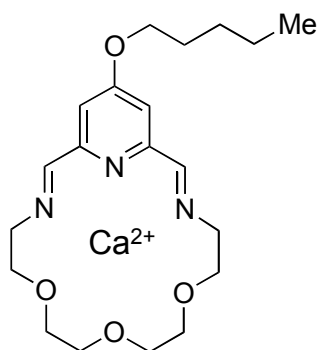

Figure 8: $^1\text{H-NMR}$ (500 MHz, 298 K, CDCl_3 , TMS) of product **5** in the DCL formed by dialdehyde **4** and diamine **1** in presence of CaCl_2

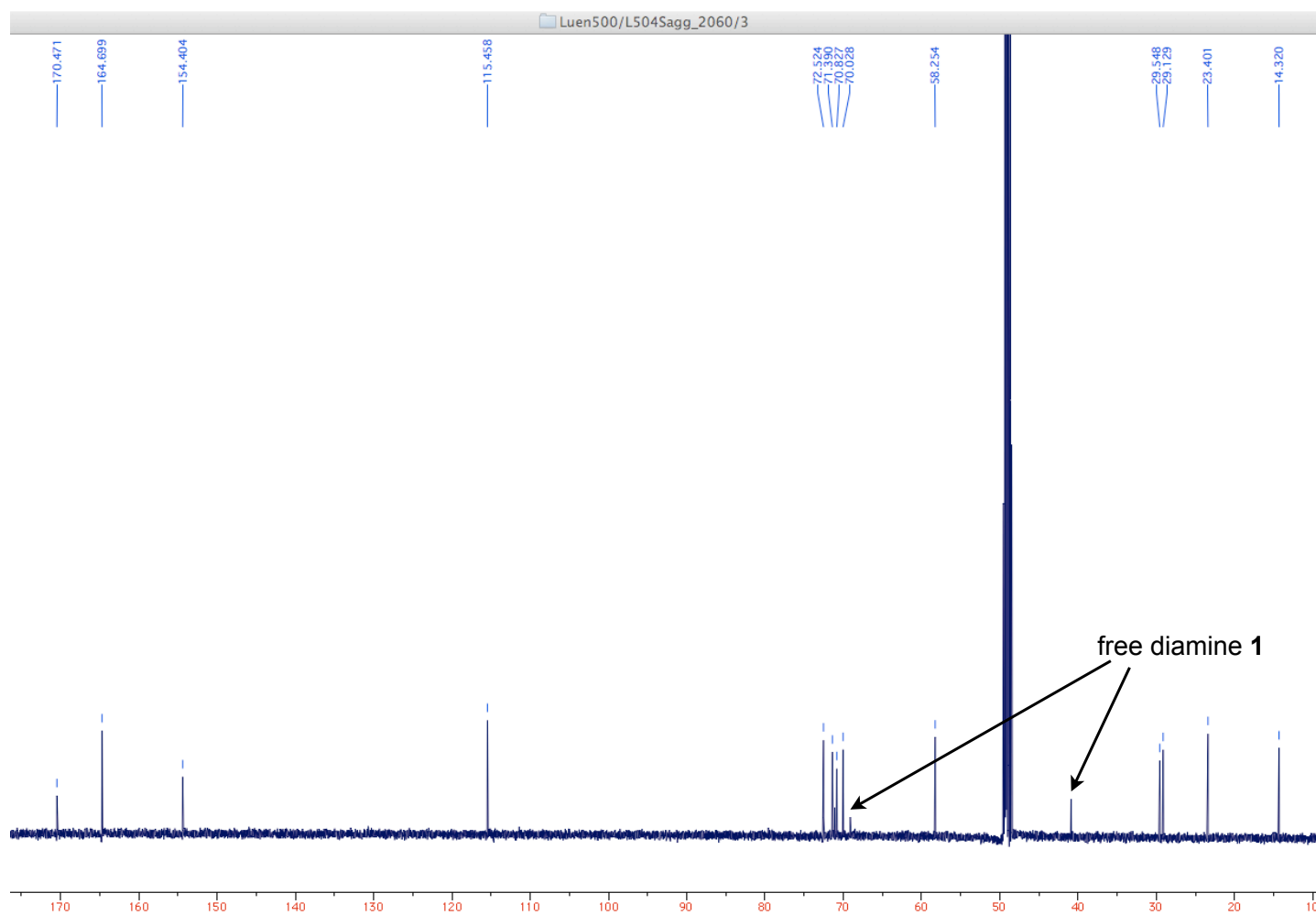
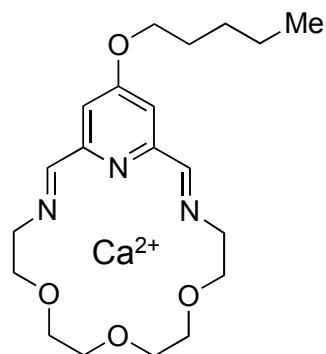

Figure 9: ^{13}C -NMR (125 MHz, 298 K, CDCl_3 , TMS) of product **5** in the DCL formed by dialdehyde **4** and diamine **1** in presence of CaCl_2

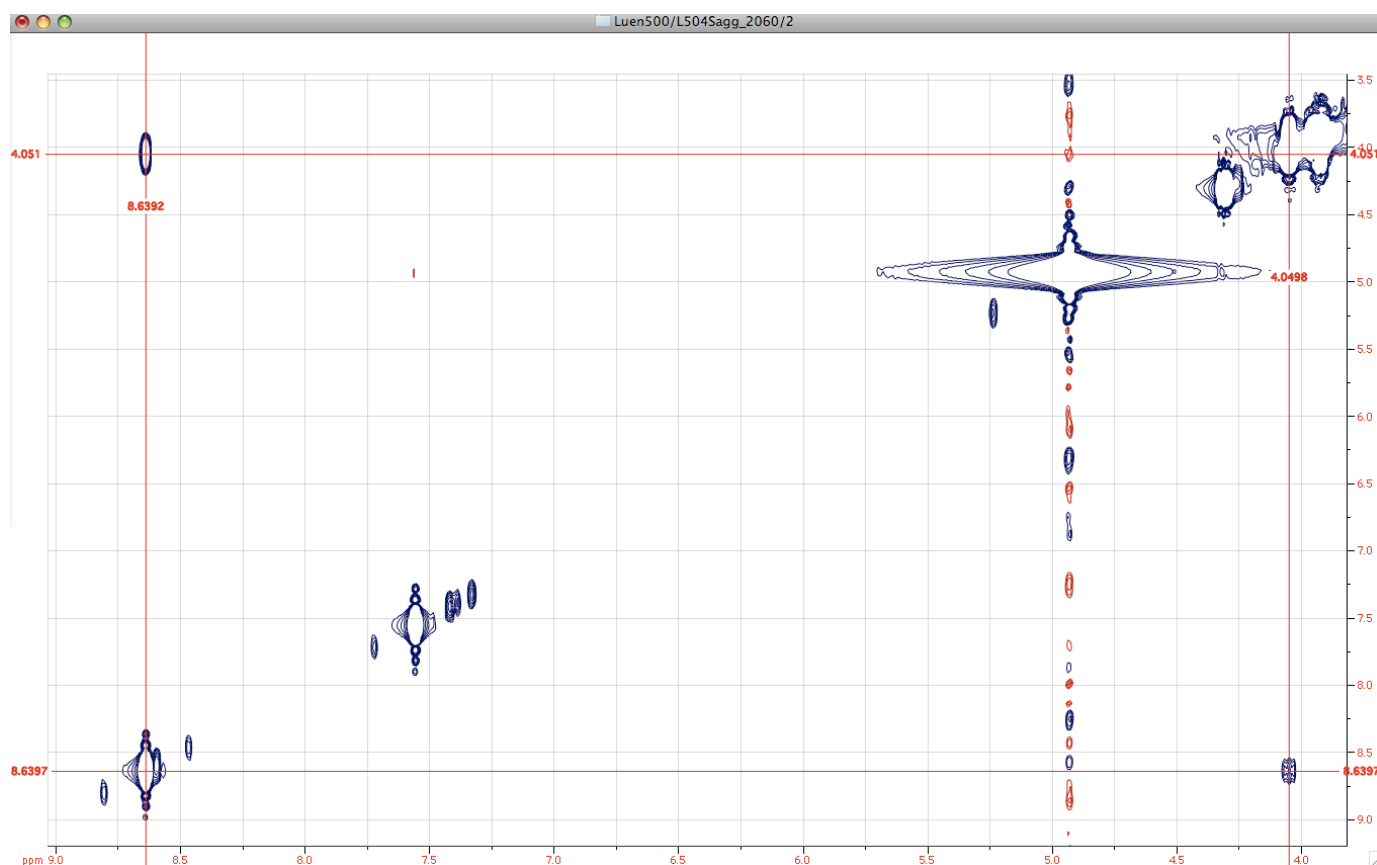
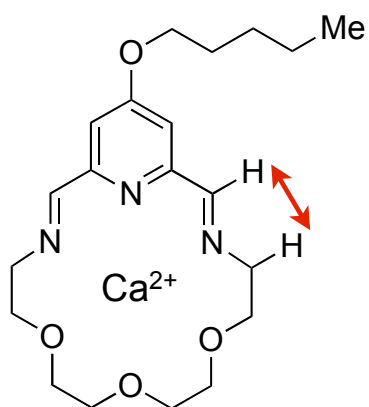

Figure 10: COSY (expansion) NMR (500 MHz, 298 K, CDCl_3 , TMS) of product **5** in the DCL formed by dialdehyde **4** and diamine **1** in presence of CaCl_2

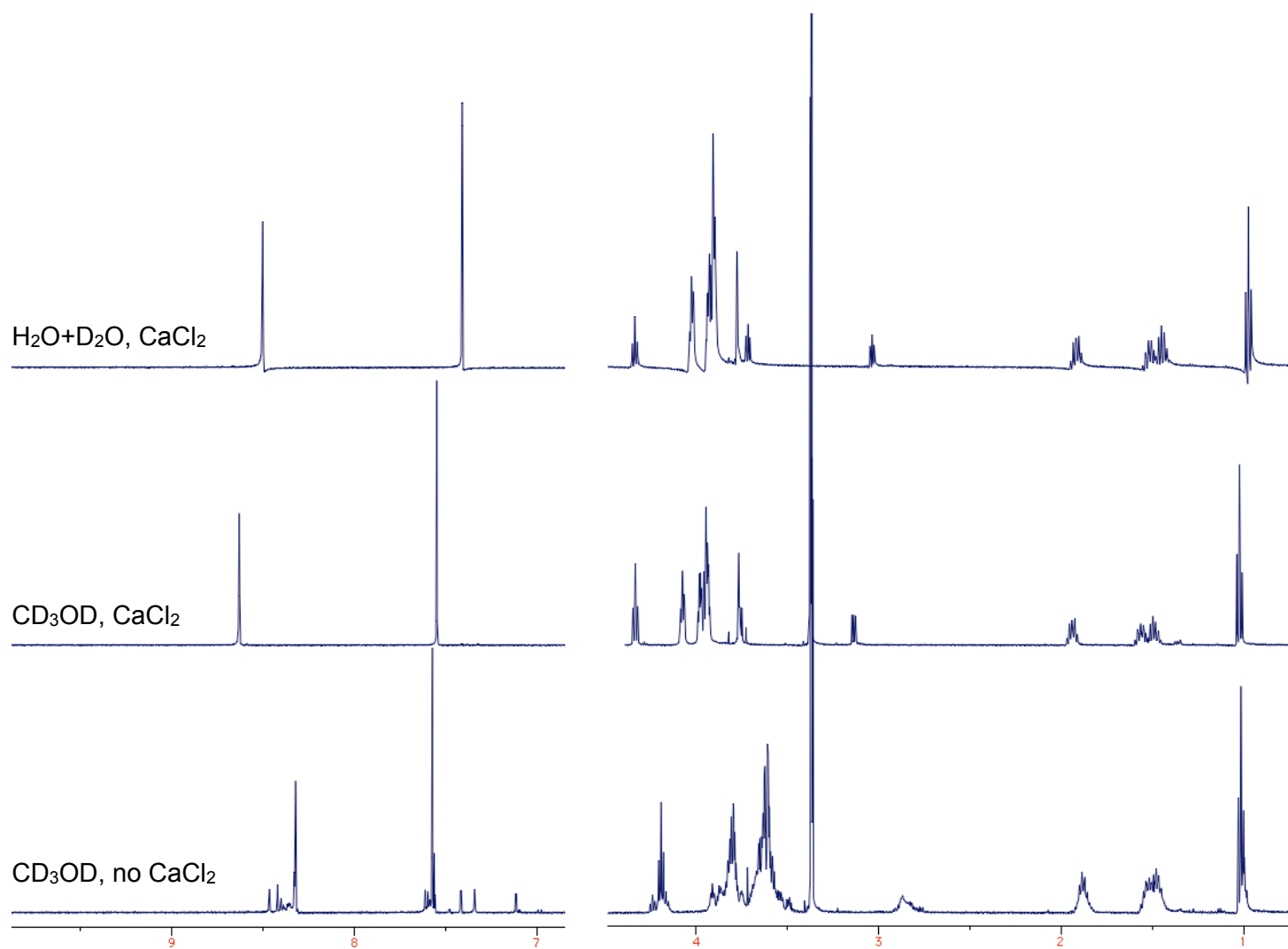

Figure 11: $^1\text{H-NMR}$ (500 MHz, 298 K), DCL formed by reacting diamine **1** and dialdehyde **4** in presence or absence of CaCl_2 in different solvents.

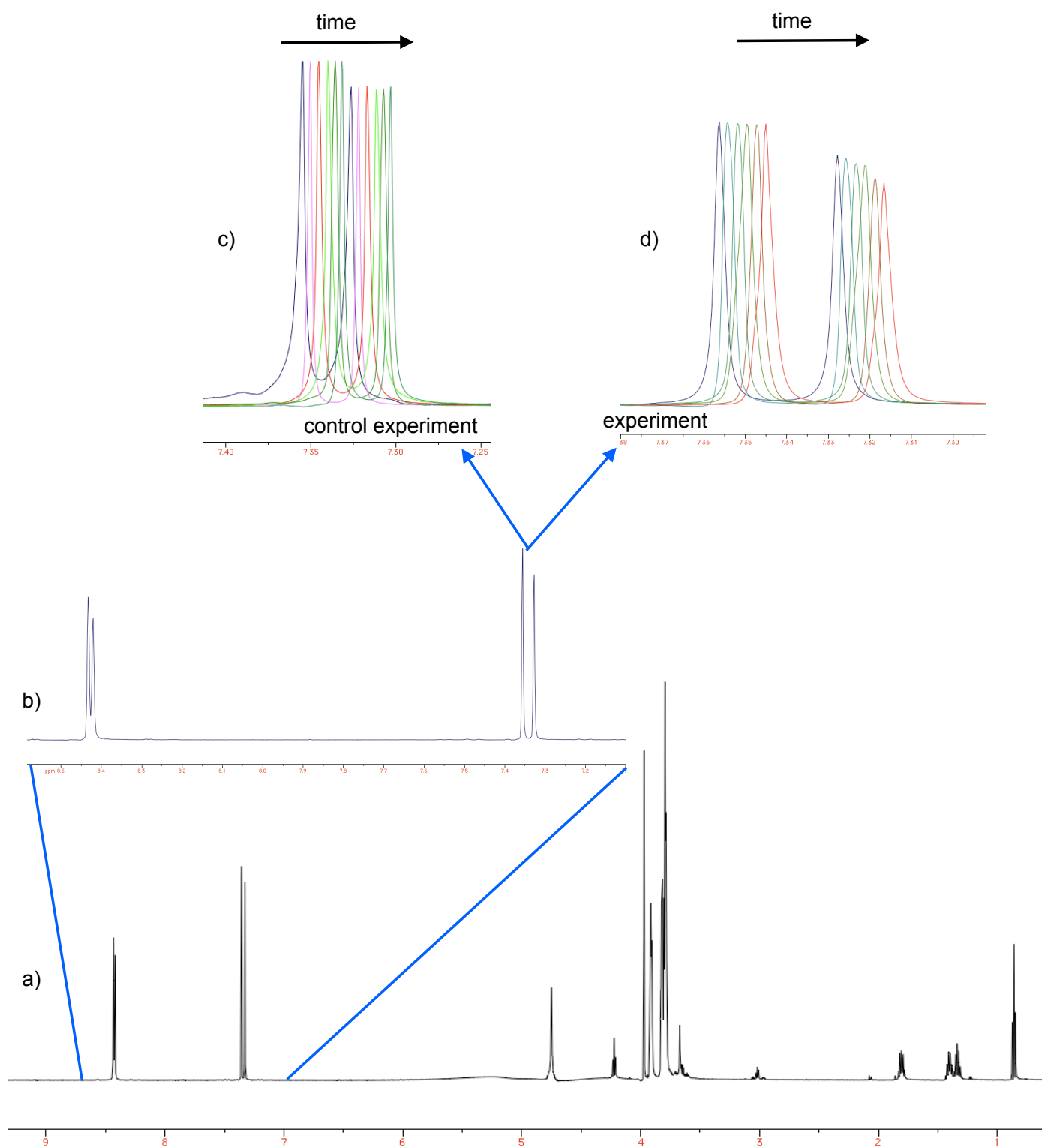

Figure 12: DCC-SLM experiment, source phase mixture of dialdehydes **2**, **4**, diamine **1** and CaCl_2 , $^1\text{H-NMR}$ (600 MHz, 298 K, $\text{H}_2\text{O} + 10\% \text{D}_2\text{O}$). a) $^1\text{H-NMR}$ of the mixture; b) $^1\text{H-NMR}$, expanded section; c) control experiment (no transport) and, d) time dependent transport experiment.

3.5 The First Supramolecular Ion Triplet Complex

J. Eckelmann V. Saggiomo, F. Sönnichsen, U. Lüning, 2010, *submitted*.

This experiment was done in prevision of possible future use of polytopic carrier macrocycles able to complex both ion and counter-ion.

In this collaboration, Jens Eckelmann provided the macrocycle shown in Figure 3.5. This neutral macrocycle displays three binding sites (tritopic macrocycle): four amide NHs in two different isophthalamide residues, well known to complex anions, and four oxygen atoms in the diethylene glycol part able to complex cations. The capacity of this macrocycle to extract alkaline and alkaline earth metal chlorides into an organic solvent was screened. Regarding alkaline metal chlorides, this host was capable to bind and extract into chloroform selectively LiCl over NaCl and KCl, and CaCl₂ over MgCl₂ and BaCl₂ regarding alkaline earth metal chlorides. Other proofs of the binding were obtained by the use of ESI-MS and NOESY experiments (thanks to the support of Frank Sönnichsen). This, to the best of our knowledge, is the first supramolecular ion triplet complex.

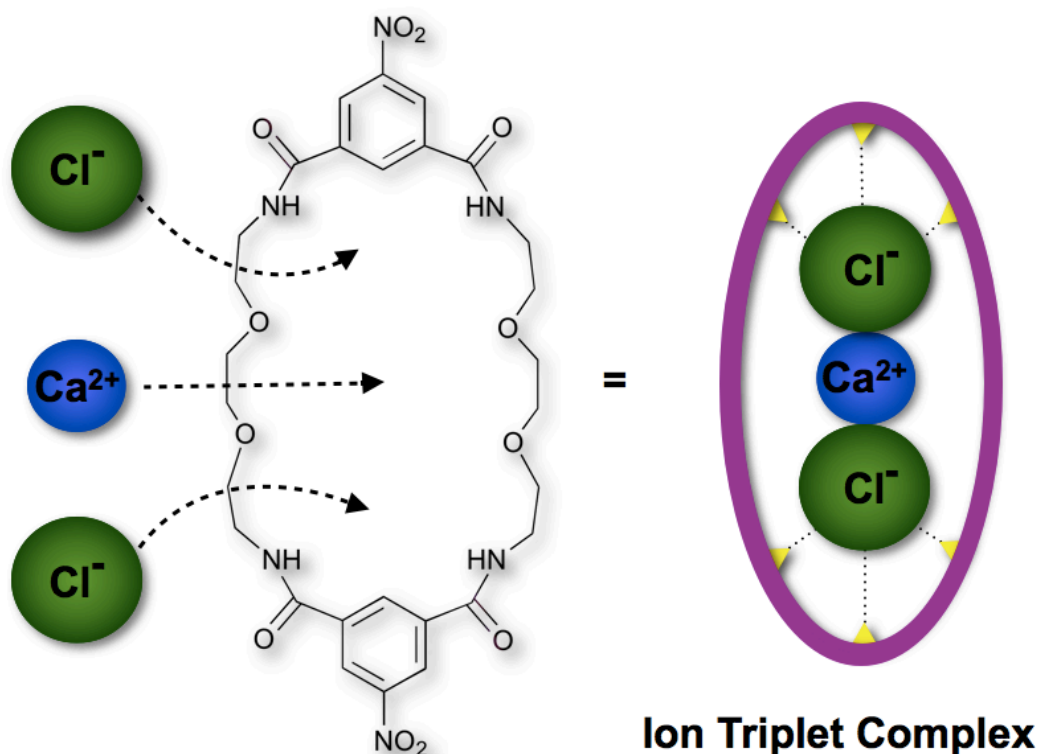

Figure 3.5: Schematic representation of the ion triplet complex with calcium chloride.

The first supramolecular ion triplet complex

Jens Eckelmann, Vittorio Saggiomo, Frank D. Sönnichsen and Ulrich Lünig*

Received (in XXX, XXX) Xth XXXXXXXXX 200X, Accepted Xth XXXXXXXXX 200X

First published on the web Xth XXXXXXXXX 200X

DOI: 10.1039/b000000x

A neutral tritopic macrocycle **1** was obtained by condensation of a diacid dichloride **2** with a diamine **3**. **1** contains three binding sites: two for anions by hydrogen bonding and one for cations by ether oxygen atoms. The selective binding of LiCl and CaCl₂ has been studied by NMR and MS techniques. **1** is the first host to form a supramolecular complex with an ion triplet: 1·CaCl₂.

In supramolecular chemistry, macrocycles have always been widely used to complex different organic and inorganic guests.¹ For a long time, chemists focused their attention on the complexation of cations and anions, with the latter task being more challenging due to the large size, different shapes and the high polarisability of anions.² Nowadays, the importance of targeting ion-pairs of salts as guests is growing.³ In this field, ditopic hosts are usually synthesized as neutral compounds, in which the ditopic nature of the receptor allows to bind both cation and anion in adjacent binding units in close contact.⁴ With the matching cation for the contact pair formation in the host-guest complex, it is possible to enhance the binding of a particular anion or vice versa.⁵

Although this field is growing and many different ditopic molecules have been synthesized in the last five years, there is still a lack of hosts for complexing alkaline earth metal halides. In order to reach this goal, chemists must move from ditopic hosts to tritopic hosts. In these, two binding units for anions and one for a cation comprise the sites needed for the complexation of an alkaline earth metal halide as ion triplet.^{6,7} In this work, we present the neutral tritopic host **1** that is capable to bind an alkaline earth metal salt, and binds calcium dichloride as an ion triplet with high selectivity. To the best of our knowledge, the formation of complex 1·CaCl₂ is the first description of a supramolecular ion triplet complex for alkaline earth metal salts (figure 1).⁸

The synthesis of macrocycle **1** is straightforward and starts from two building blocks: diacid dichloride **2** and diamine **3** (see scheme 1). In order to obtain and study macrocycles of different sizes, we used a combinatorial approach which gave the [2+2]-macrocycle **1** (figure 1), together with [1+1]-, [3+3]-, [4+4]-macrocycles and linear products which are not described here. After a simple one step condensation of diacid dichloride **2** and diamine **3** in the presence of triethylamine, the [2+2]-macrocycle **1** could be isolated from the resulting mixture by chromatography (scheme 1).

Macrocycle **1** displays three binding sites (tritopic macrocycle): four NH amides in two different isophthalamide residues, well known to complex anions,⁹ and four oxygen atoms in the diethylene glycol part able to complex cations.

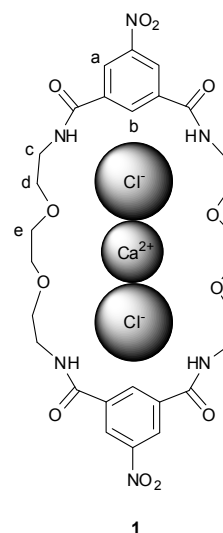

Fig. 1 Calcium dichloride complex with macrocycle **1** and hydrogen labeling scheme. For structural studies, see supporting information.

Additionally it has two nitro groups that can be further modified, e. g. by reduction. The neutral macrocycle **1** possesses D_{2h} symmetry giving rise to a simple ¹H-NMR spectrum: two triplets for the NH and H_d protons, a doublet for H_a, a broad singlet for the H_b and a singlet for the H_c protons.

The easily interpretable and clean ¹H-NMR spectra were used to investigate the capability of this tritopic macrocycle **1** to bind salts as contact ions, and to detect their extraction from solid into an organic solvent. A stock solution (2.5 mM) of **1** in CDCl₃ with 5% of DMSO-d₆ was allowed to stand over an excess of powdered alkaline and alkaline earth metal chlorides in different NMR tubes. After 12 h, ¹H-NMR spectra were recorded and analyzed for differences in chemically induced shifts (CIS) between the free macrocycle **1** and the complexes (Figure 2).

When comparing the solutions containing the alkaline chlorides LiCl, NaCl and KCl, the NMR spectra clearly show that macrocycle **1** is capable of binding lithium chloride selectively over other alkaline metal chlorides, as the ¹H-NMR spectra do not show any change when sodium chloride or potassium chloride are used. In the case of lithium chloride, a significant CIS of NH (-0.88 ppm) and H_b (-0.65 ppm) was detected (Figure 2, LiCl).

The large downfield shift of almost 1 ppm of the amide proton is indicative of the formation of hydrogen bonds to the chloride anion (NH...Cl) in presence of DMSO.¹⁰

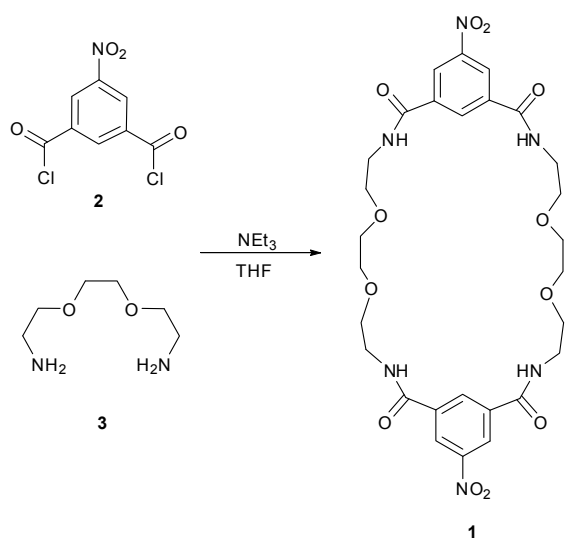

Scheme 1 Synthetic scheme for the formation of macrocycle **1**.

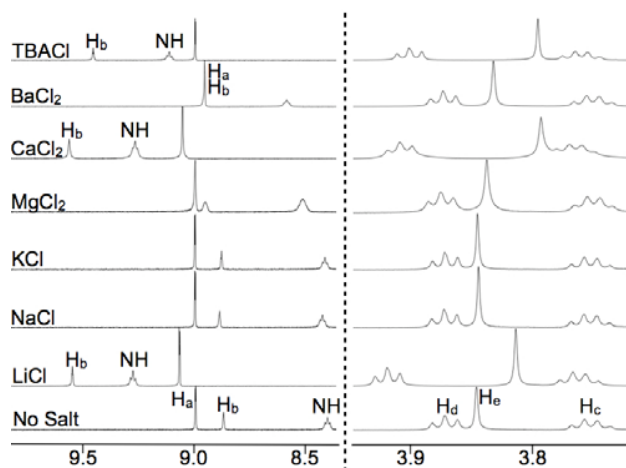

Fig. 2 Expanded sections of $^1\text{H-NMR}$ spectra (500 MHz, 298 K, $\text{CDCl}_3/\text{DMSO-d}_6$ 95:5) of **1** in the presence of different salts. For proton assignments see Figure 1.

A small difference in the chemical shifts of H_a (-0.08 ppm), not involved in the binding, was also detected. In the diethylene glycol chains, upfield CIS for H_c (+0.04 ppm) and downfield CIS for H_d (-0.05 ppm) were observed. Due to the key importance of lithium salts as drug in different diseases,¹¹ it is an interesting goal to develop lithium receptors and sensors.¹² The challenge is to bind it selectively over competing ions such as sodium. Macrocycle **1** achieves this task in an organic solvent complexing selectively LiCl as contact ion pair over NaCl.

Additionally, alkaline earth metal dichlorides (MgCl_2 , CaCl_2 , BaCl_2) were screened applying the same methodology. Indeed, macrocycle **1** is able to form an ion triplet complex $\mathbf{1}\cdot\text{CaCl}_2$, but remarkably only with the calcium salt. The distinct differences in CIS for MgCl_2 , CaCl_2 and BaCl_2 show a strong selectivity of macrocycle **1** for calcium dichloride over magnesium and barium dichloride. Although in presence of magnesium and barium dichloride, the NH signal shows a modest CIS (-0.14 and -0.24 ppm, respectively), a prominent

NH downfield shift (-0.90 ppm) is observed only when calcium dichloride is used (Figure 2, CaCl_2). The calcium dichloride complex ($\mathbf{1}\cdot\text{CaCl}_2$) shows proton shifts similar to the lithium chloride complex ($\mathbf{1}\cdot\text{LiCl}$). Only H_c is shifted more upfield (+0.06 ppm) with respect to $\mathbf{1}\cdot\text{LiCl}$ which reflects a different side chain orientation. Due to different sizes of magnesium, calcium and barium, macrocycle **1** is able to complex selectively calcium dichloride as a *contact ion-triplet*. To the best of our knowledge, this is the first neutral macrocycle that binds an alkaline earth metal dihalide as contact ion triplet.¹³

Mass analyses confirm the strong complexing ability of macrocycle **1** for LiCl and CaCl_2 (see Supplementary Information). When ESI-MS spectra (negative ion mode) were recorded directly from the NMR solutions with either lithium chloride or calcium dichloride, it was possible to detect a single peak as $\mathbf{1}\cdot\text{Cl}^-$ ($m/z=681.20$). The ESI-MS scan of $\mathbf{1}\cdot\text{CaCl}_2$ in the positive mode showed two peaks attributable to complex $\mathbf{1}\cdot\text{CaCl}_2$: $(\mathbf{1}+\text{Ca}^{2+})/2$ ($m/z=343.10$) and $\mathbf{1}+\text{CaCl}^+$ ($m/z=721.14$). On the other hand, the ESI spectra of the lithium chloride complex $\mathbf{1}\cdot\text{LiCl}$ showed only the protonated peak $\mathbf{1}+\text{H}^+$, but for this complex the MALDI-TOF spectrum revealed $\mathbf{1}+\text{Li}^+$ ($m/z=653.31$).

To obtain further insight into the complexation of the salts by macrocycle **1**, detailed NOESY experiments were carried out.¹⁴ A stock solution of **1** in CDCl_3 (ca. 2.5 mM) with 7% of DMSO-d_6 ¹⁵ was used to record 2D-NOESY spectra in three different NMR tubes: in the absence of salt, in the presence of excess of powdered lithium chloride, and in the presence of excess of powdered calcium dichloride.

Table 1 Average proton-proton distances¹⁶ (in Å) in macrocycle **1** based on NOESY experiments. For proton labels see Figure 1.

	1	$\mathbf{1}\cdot\text{LiCl}$	$\mathbf{1}\cdot\text{CaCl}_2$
$\text{H}_b\text{-NH}$	2.6	2.85	2.5
$\text{H}_c\text{-NH}$	2.7	4.5	4.1
NH-H_c	3.1	3.3	2.95
NH-H_d	3.5	3.85	3.4
$\text{H}_b\text{-H}_c$	4.3	4.8	4.3
$\text{H}_b\text{-H}_d$	4.0	5.0	4.7
$\text{H}_a\text{-H}_c$	4.1	4.6	4.1
$\text{H}_a\text{-H}_d$	3.9	-	-

Table 1 compiles the proton-proton distances as calculated from the NOESY measurements. When the obtained distances for the free macrocycle **1** are compared to those in the complexes, significant differences are apparent. In pure macrocycle **1**, the average proton-proton distances of $\text{H}_a\text{-NH}$ and $\text{H}_b\text{-NH}$ were found to be quite similar. The NH proton is at the same average distance from H_a and H_b , indicating that the benzene ring is capable of rotating around the Ar-CO bond. Thus in about half of the population, NH is close to H_a , and in the other half, NH is close to H_b , resulting in almost identical average distances of 2.6 Å ($\text{H}_b\text{-NH}$) and 2.7 Å ($\text{H}_a\text{-NH}$) in the free macrocycle.

The distances $\text{H}_a\text{-NH}$ and $\text{H}_b\text{-NH}$ respond differently to the addition of salts, i. e. the binding of chloride anions by hydrogen bonding, as they become different in both the $\mathbf{1}\cdot\text{LiCl}$ and $\mathbf{1}\cdot\text{CaCl}_2$ complexes. The average proton-proton distance between NH and H_a increased considerably, thus on average

H_a moved away from NH, while at the same time the apparent NH-H_b distance is shortened. Both facts can be explained by the binding of the NH protons to the chloride anions. In fact, the complex must have been rigidified upon complexation and the two protons (NH and H_a) are now further away from one another, while at the same time H_b spends more time in close proximity to the NH proton. It is interesting to note that also the distances between H_b and H_d increase upon complexation from 4 Å to 5 Å (1·LiCl) and 4.7 Å (1·CaCl₂), respectively.

Finally, we carried out first orientational experiments to quantify the formation of the supramolecular complexes of 1. The salts are insoluble in the solvents used for the NMR investigations, especially CaCl₂.¹⁷ But with a mixture of anhydrous calcium perchlorate and tetrabutylammonium chloride in CHCl₃/DMSO (93:7), we were able to carry out isothermal titration calorimetry (ITC) experiments with receptor 1. The results must not be overinterpreted due to the insolubility problems and also to the fact that the mixture changes the ionic strength. Nevertheless, binding constants for 1:1 complexes in the range of 10³ to 10⁴ in CHCl₃/DMSO could be determined for CaCl₂ (by use of a Ca(ClO₄)₂/nBu₄NCl mixture), and for LiCl (by use of a Li(ClO₄)₄/nBu₄NCl mixture) and nBu₄NCl.

In conclusion, a facile and accessible synthesis of macrocycle 1 has been described. The ability of 1 to complex LiCl and CaCl₂ was proven by means of ¹H-NMR and mass analyses. In solution, its conformational change in the presence of guests was analyzed and described using NOESY experiments. All these experiments concentrate on the fact that the neutral macrocycle 1 complexes calcium dichloride in its ion-triplet form. This ion-triplet receptor should be useful in different applications such as selective extraction from solid mixtures (industrial application), membrane transport (calcium is an essential element for biological life, and chloride concentration controls several processes in the cell), chemosensing, homogeneous catalysis and phase transfer catalysis. In our laboratory the screening of some of these applications is work in progress.

Acknowledgement

We thank the EU for its support through the Marie Curie Research Training Network MRTN-CT-2006-035614 Dynamic Combinatorial Chemistry (DCC). Eva Mucke's help with the calculations is gratefully acknowledged.

Notes and references

Otto-Diels-Institut für Organische Chemie, Christian-Albrechts-Universität zu Kiel, Olshausenstr. 40, D-24098 Kiel, Germany. Tel.: +49 431 880-2450 Fax: +49 431 880-1558 E-mail: luening@oc.uni-kiel.de

† Electronic Supplementary Information (ESI) available: Experimental and spectroscopic details of 1. NMR and MS complexation studies.

Calculations. See DOI: 10.1039/b000000x/

¹ J. W. Steed and J. L. Atwood, *Supramolecular Chemistry*, 2nd ed., Wiley, New York, 2009.

² F. P. Schmidtchen, M. Berger, *Chem. Rev.*, 1997, **97**, 1609-1646; A. Bianchi, K. Bowman-James, E. García-España in *Supramolecular Chemistry of Anions*, Wiley-VCH, New York, 1997; A. J. Evans, P. D. Beer, *Dalton Trans.*, 2003, 4451-4456; M. T. Reetz, C. M. Niemeyer, K. Harms, *Angew. Chem., Int. Ed. Engl.*, 1991, **30**, 1472-1474.

³ B. D. Smith, "Ion-Pair Recognition By Ditopic Receptors" in *Macrocyclic Chemistry: Current Trends and Future*, (eds.: K. Gloe, B. Antonioli), Kluwer, London, 2005, pp 137-152.

⁴ Some recent examples of ditopic receptors: K. Salorinne, T.-R. Tero, K. Riikonen, M. Nissinen, *Org. Biomol. Chem.*, 2009, DOI: 10.1039/b911389d; N. Bernier, S. Carvalho, F. Li, R. Delgado, V. Félix, *J. Org. Chem.*, 2009, **74**, 4819-4827; M. D. Lankshear, I. M. Dudley, K.-M. Chan, A. R. Cowley, S. M. Santos, V. Félix, P. D. Beer, *Chem. Eur. J.*, 2008, **14**, 2248-2263; M. D. Lankshear, A. R. Cowley, P. D. Beer, *Chem. Commun.*, 2006, **6**, 612-614; J. M. Mahoney, K. A. Stucker, H. Jiang, I. Carmichael, N. R. Brinkmann, A. M. Beatty, B. C. Noll, B. D. Smith, *J. Am. Chem. Soc.*, 2005, **127**, 2922-2928. J. M. Mahoney, A. M. Beatty, B. D. Smith, *Inorg. Chem.*, 2004, **43**, 7617-7621.

⁵ J. M. Mahoney, A. M. Beatty, B. D. Smith, *J. Am. Chem. Soc.*, 2001, **123**, 5847-5848; S. Kubik, *J. Am. Chem. Soc.*, 1999, **121**, 5846-5855.

⁶ There is a discussion on how to name an ionic aggregate such as CaCl₂ triple ion or ion triplet. We have chosen ion triplet to highlight the fact that three ions are bound as a unit, and we have not chosen triple ion to avoid the impression that there is a remaining charge (see ⁷). 1·CaCl₂ is the first neutral supramolecular ion triplet complex. G. V. Oshovsky, D. N. Reinhoudt, W. Verboom, *J. Am. Chem. Soc.* **2006**, *128*, 5270-5278.

⁸ With a dichloride of a more electrophilic transition metal (palladium), a structurally related complex has been described: B. A. Blight, J. A. Wisner, M. C. Jennings, *Chem. Commun.* **2006**, 4593-4595.

⁹ P. V. Santacroce, J. T. Davis, M. E. Light, P. A. Gale, J. C. Iglesias-Sánchez, P. Prados, R. Quesada, *J. Am. Chem. Soc.*, 2007, **129**, 1886-1887; K. Kavallieratos, B. A. Moyer, *Chem. Commun.*, **2001**, 1620-1621; A. Szumna, J. Jurczak, *Eur. J. Org. Chem.*, **2001**, 4031-4039; K. Kavallieratos, C. M. Bertao, R. H. Crabtree, *J. Org. Chem.*, **1999**, *64*, 1675-1683.

¹⁰ M. J. Deetz, M. Shang, B. D. Smith, *J. Am. Chem. Soc.*, 2000, **122**, 6201-6207.

¹¹ N. J. Birch, *Chem. Rev.*, 1999, **99**, 2659-2682; C. J. Phiel, C.A. Wilson, V. M.-Y. Lee, P. S. Klein, *Nature*, 2003, **423**, 435-439; H. R. Pilcher, *Nature*, 2003, **425**, 118-120.

¹² S. Rochat, Z. Grote, K. Severin, *Org. Biomol. Chem.*, 2009, **7**, 1147-1153.

¹³ To prove the chloride complexing abilities of macrocycle 1, tetrabutylammonium chloride (TBACl) was used as salt. And even in this case, the shifts of the protons are comparable with 1·LiCl and 1·CaCl₂ complexes. Nevertheless, the NH protons are shifted more when CaCl₂ or LiCl was used instead of TBACl (naked chloride). The CIS of the ethylene glycol protons are more similar to the CIS of 1·CaCl₂ than to that of 1·LiCl.

¹⁴ Unfortunately, up to now it was not possible to obtain a single crystal of 1·CaCl₂. Besides, if the complexation shall be exploited in applications such as for instance transport it must be studied in solution anyway.

¹⁵ In comparison to the first binding experiments, a slightly higher concentration of DMSO was used in order to ensure a homogeneous organic phase, needed to record reliable NOESY spectra.

¹⁶ 2D-NOESY experiments with varying mixing times were used to analyze the conformation and mobility of the free macrocycle and the tritopic complexes. Using a two-spin approximation and two known distances as a reference, average interproton distances were calculated from all observed NOE intensities after peak integration as described in supplementary materials. In a mobile structure, the distances are physically meaningless i. e. don't describe a single conformation, their differences upon ion binding however indicate changes in the combination of short distances and population of the conformations present.

¹⁷ CaCl₂ and LiCl are insoluble in the solvent mixture used and are extracted into these solvents only by 1. Therefore, a titration with portions of the solid salt into a solution of host 1 cannot be interpreted when excess salt is added. For this reason, the preliminary binding studies were done with salts which are soluble in the solvent mixture: Ca(ClO₄)₂, Li(ClO₄) and nBu₄NCl.

Supplementary Information For:

The first supramolecular ion triplet complex

Jens Eckelmann, Vittorio Saggiomo, Frank D. Sönnichsen, Ulrich Lüning*

Otto-Diels-Institut für Organische Chemie, Christian-Albrechts-Universität zu Kiel,
Olshausenstr. 40, D-24098 Kiel, Germany. E-mail: luening@oc.uni-kiel.de

Contents:

General Remarks	S2
Macrocycle 1	
Synthesis	S2
¹ H-NMR	S4
¹³ C-NMR	S5
HSQC	S6
ESI-MS	S7
¹H-NMR Experiments	S8
Overlayed spectra in presence of different salts	S9
MS Experiments	S10
ESI-MS of 1 ·CaCl ₂ , negative mode (M + Cl ⁻)	S10
ESI-MS of 1 ·CaCl ₂ , positive mode [(M + Ca ²⁺) / 2]	S11
ESI-MS of 1 ·CaCl ₂ , positive mode (M + CaCl ⁺)	S12
ESI-MS of 1 ·LiCl, negative mode (M + Cl ⁻)	S13
MALDI-TOF of 1 ·LiCl, positive mode (M + Li ⁺)	S14
NOESY Experiments	S15
NOE of 1	S16
NOE of 1 ·LiCl	S17
NOE of 1 ·CaCl ₂	S18
Quantum mechanical calculations	S19

General Remarks

All reagents were obtained from commercial sources and used without additional purification unless otherwise indicated. 5-Nitroisophthaloyl dichloride was prepared from 5-nitroisophthalic acid and thionyl chloride according to Vögtle and De Cola.¹ 1,8-Diamino-3,6-dioxaoctane was obtained from Fluka. THF was freshly distilled from lithium aluminum hydride (triphenylmethane as indicator). All reactions were carried out in an atmosphere of nitrogen. NMR spectra were recorded with Bruker DRX 500 or AV 600 instruments. Assignments are supported by COSY, HSQC and HMBC. All chemical shifts are referenced to TMS. Mass spectra were recorded with a Finnigan MAT 8200 or MAT 8230. ESI mass spectra were recorded with an Applied Biosystems Mariner Spectrometry Workstation. IR spectra were recorded with a Perkin-Elmer Spectrum 100, equipped with an ATR unit. Elemental analyses were carried out with a EuroEA 3000 Elemental Analyzer from Euro Vector. MALDI-TOF spectra were recorded with a Bruker-Daltonics Biflex III. 4-Chloro- α -cyanocinnamic acid (Cl-CCA) was used as a matrix.

Synthesis of macrocycle **1**

16,33-Dinitro-6,9,23,26-tetraoxa-3,12,20,29-tetraazatricyclo[29.3.1.1^{14,18}]hexatriaconta-1(35),14,(36),15,17,31,33-hexaen-2,13,19,30-tetraone (1)

A solution of 5-nitroisophthaloyl dichloride (1.00 g, 4.03 mmol) in tetrahydrofuran (20 mL) was added dropwise over 20 min to a stirred solution of 1,8-diamino-3,6-dioxaoctane (5.06 g, 5.00 mL, 34.1 mmol) and triethylamine (2.50 mL, 1.83 g, 18.0 mmol) in tetrahydrofuran (20 mL). The solution was stirred for 24 h. The solvent and excess of triethylamine was evaporated under reduced pressure. The residue was dissolved in dichloromethane (30 mL) and washed with water (4 x 50 mL). The combined extracts were dried with magnesium sulfate and evaporated under reduced pressure to yield a yellow solid, which was purified by column chromatography on silica using dichloromethane/methanol/triethylamine (20:1:1, R_f = 0.47) as eluent to give macrocycle **1** (110 mg, 8 %) as a white solid.

δ_H (500 MHz; CDCl₃/DMSO-d₆ 95:5 v/v; TMS): 3.59 (8 H, m, O-CH₂-CH₂-NH), 3.68 (8 H, s, O-CH₂-CH₂-O), 3.71 (8 H, t, J = 5.2, O-CH₂-CH₂-NH), 8.39 (4 H, t, J = 5.5, NH), 8.77 (2 H, s, Ar), 8.84 (4 H, d, J = 1.3, Ar);

δ_c (125 MHz, CDCl₃/DMSO-d₆ 95:5 v/v, TMS): 39.54, 39.71, 39.88, 40.05, 40.21, 40.38, 40.55 (DMSO-d₆ and CH₂-NH), 69.21, 70.14 (CH₂-O-CH₂), 125.04 (Ar-C-4, Ar-C-6), 131.05 (Ar-C-2), 136.22 (Ar-C-1, Ar-C-3), 148.27 (Ar-C-5), 164.66 (C=O);

IR (ATR): $\nu_{\max}/\text{cm}^{-1}$ 3275 (NH), 3091 (Aryl-H), 2866 (CH₂), 1649 (CO), 1580, 1557 and 1528 (C=C), 1123 (C-O-C);

m/z (ESI): 669.2284 (M+Na⁺, C₂₈H₃₄N₆O₁₂Na⁺ requires 669.2127).

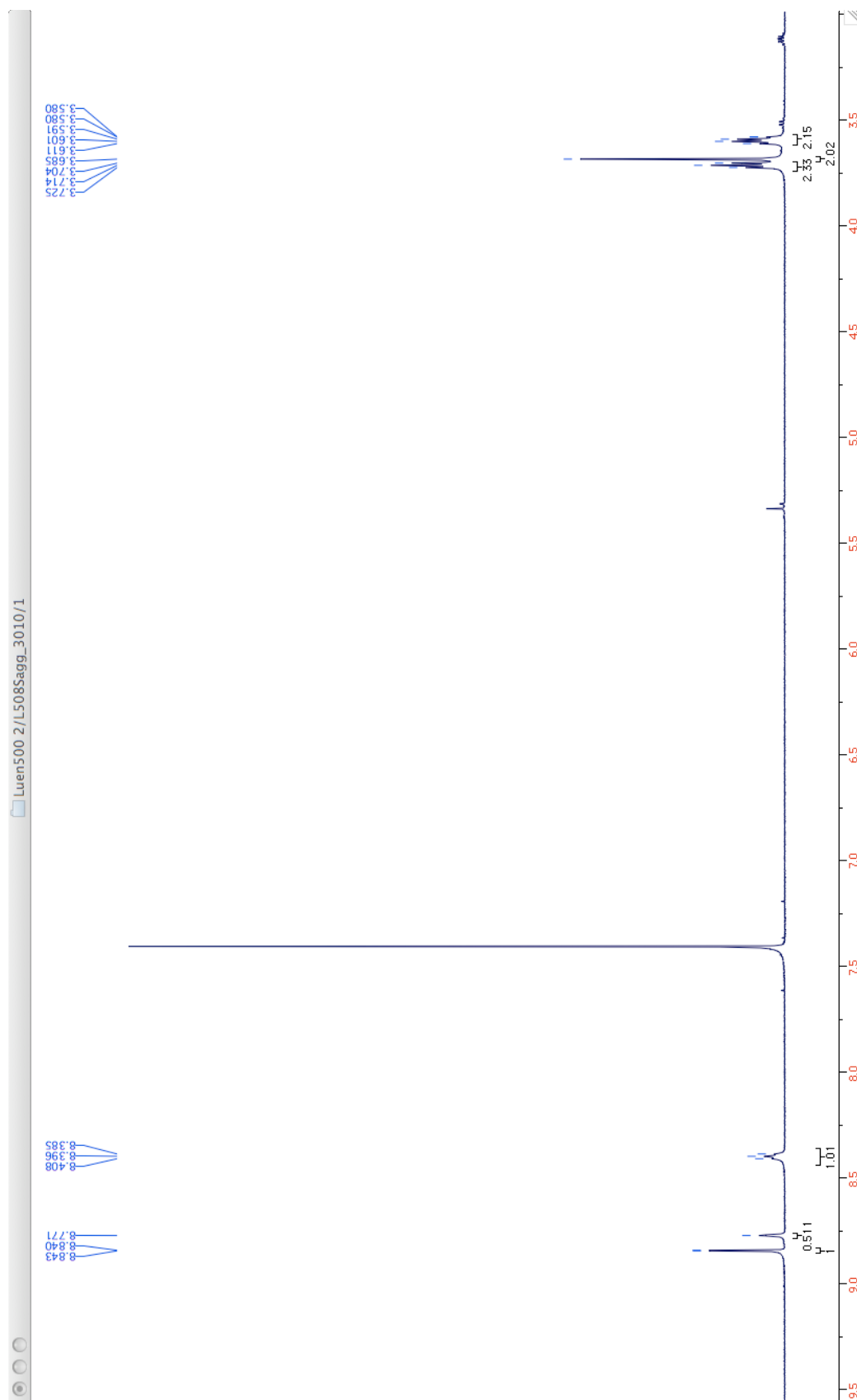

Figure 1: $^1\text{H-NMR}$ (500 MHz; 298 K; $\text{CDCl}_3/\text{DMSO-d}_6$ 95:5 v/v; TMS) of **1**.

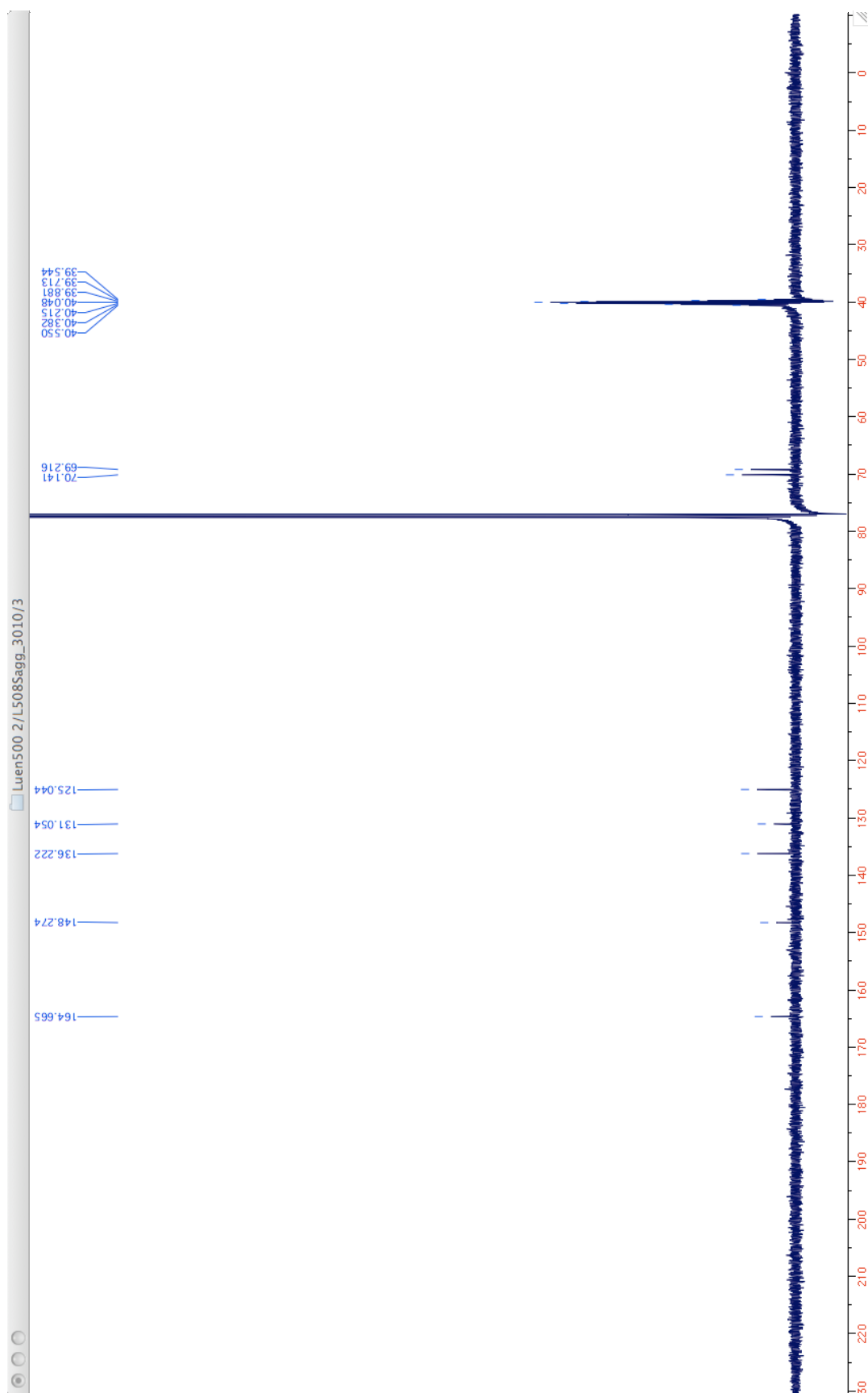

Figure 2: ^{13}C -NMR (125 MHz, 298 K, $\text{CDCl}_3/\text{DMSO-d}_6$ 95:5 v/v, TMS) of **1**.

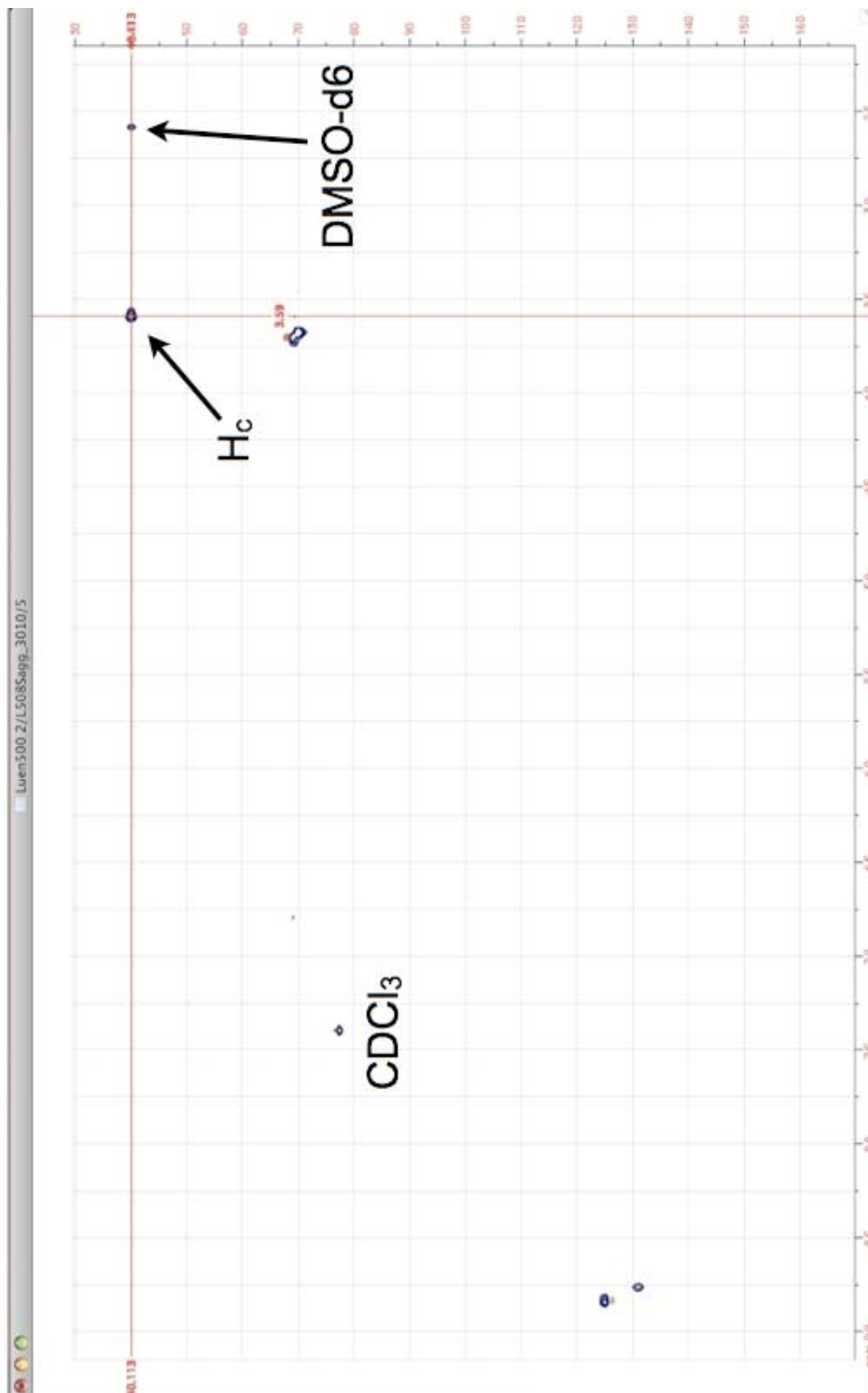

Figure 3: HSQC of **1**. The CH₂NH carbon is overlapping with DMSO-d₆ carbons.

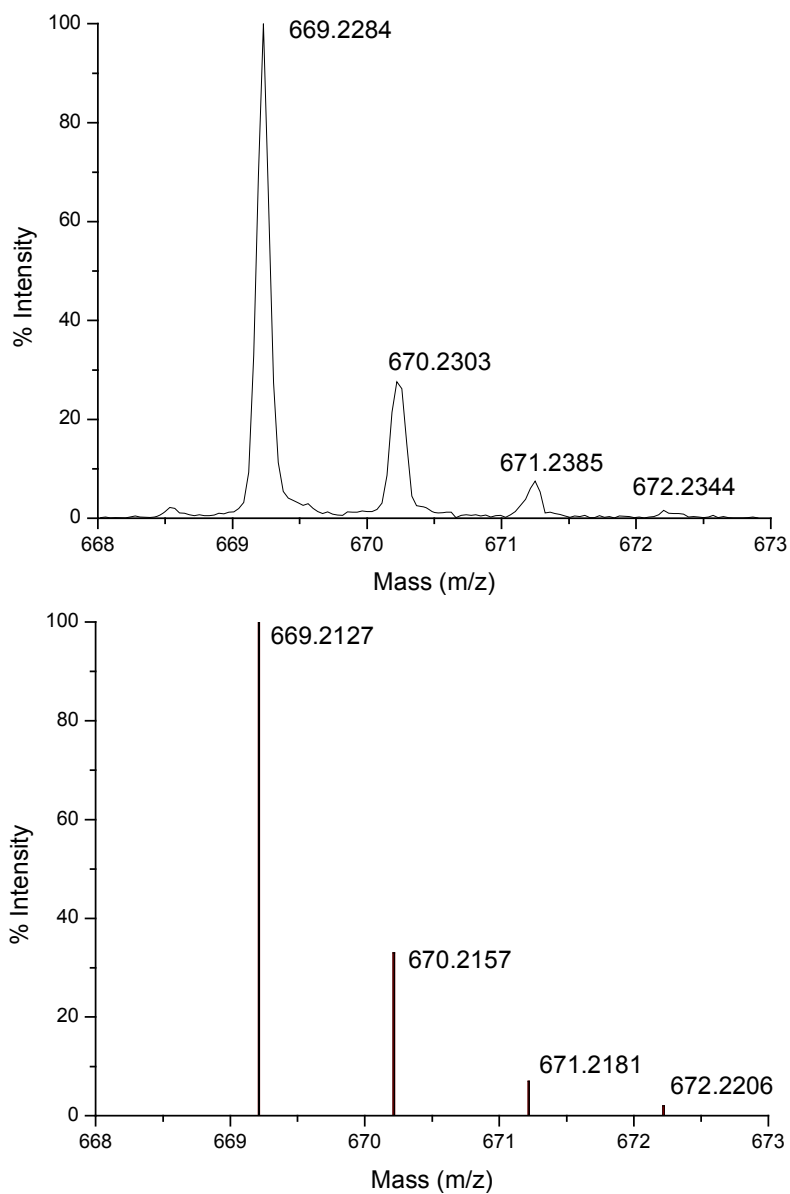

Figure 4: Measured (top) and predicted (bottom): ESI-MS spectra (positive mode) of **1** ($C_{28}H_{34}N_6O_{12}+Na^+$).

¹H-NMR Experiment

8.0 mg (1.2 μmol) of **1** was dissolved in 5.0 mL of a mixture of $\text{CDCl}_3/\text{DMSO-d}_6$ (95:5, v/v). 600 μL of this stock solution was then transferred into different NMR tubes containing various excess of salts. The tubes were fluxed with nitrogen, capped and sealed with PARAFILM[®]. The NMR spectra were recorded after 12 h.

MS experiments :

Directly from the NMR tubes, a drop of solution was used to carry out the mass spectrometry experiments.

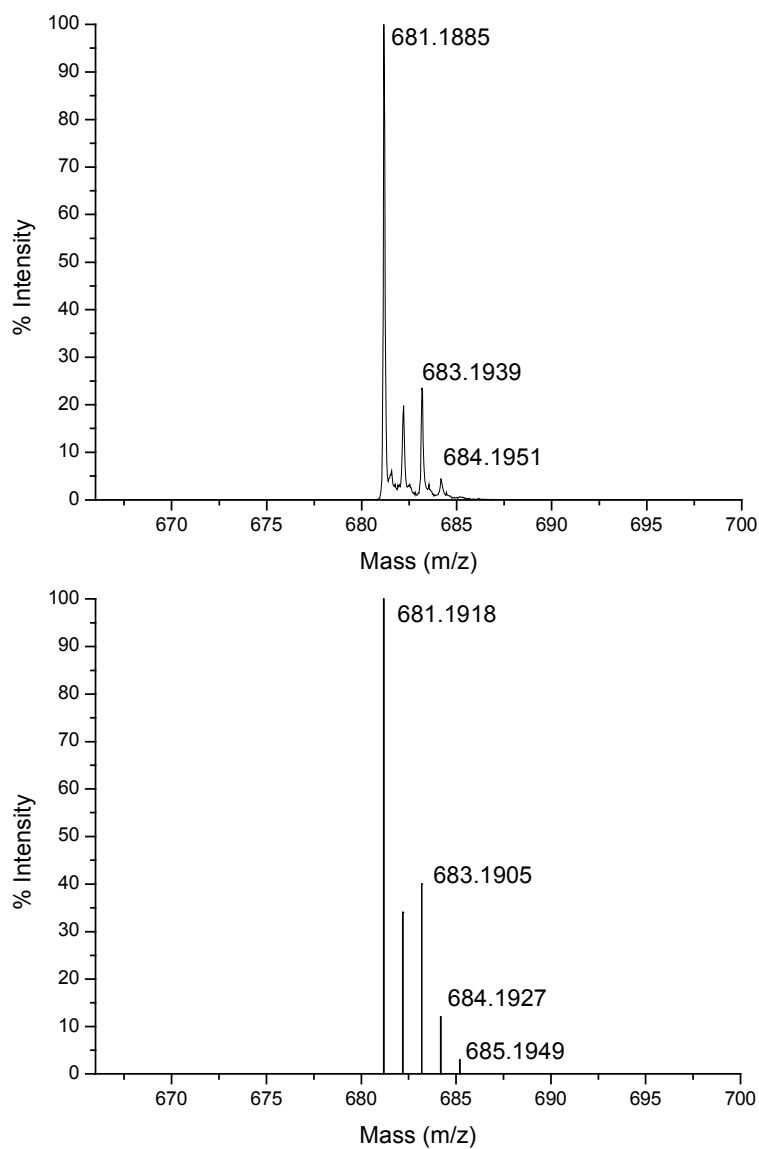

Figure 6: Measured (top) and predicted (bottom): ESI-MS spectra (negative mode) of $1 \cdot \text{CaCl}_2$ ($\text{C}_{28}\text{H}_{34}\text{N}_6\text{O}_{12} + \text{Cl}^-$).

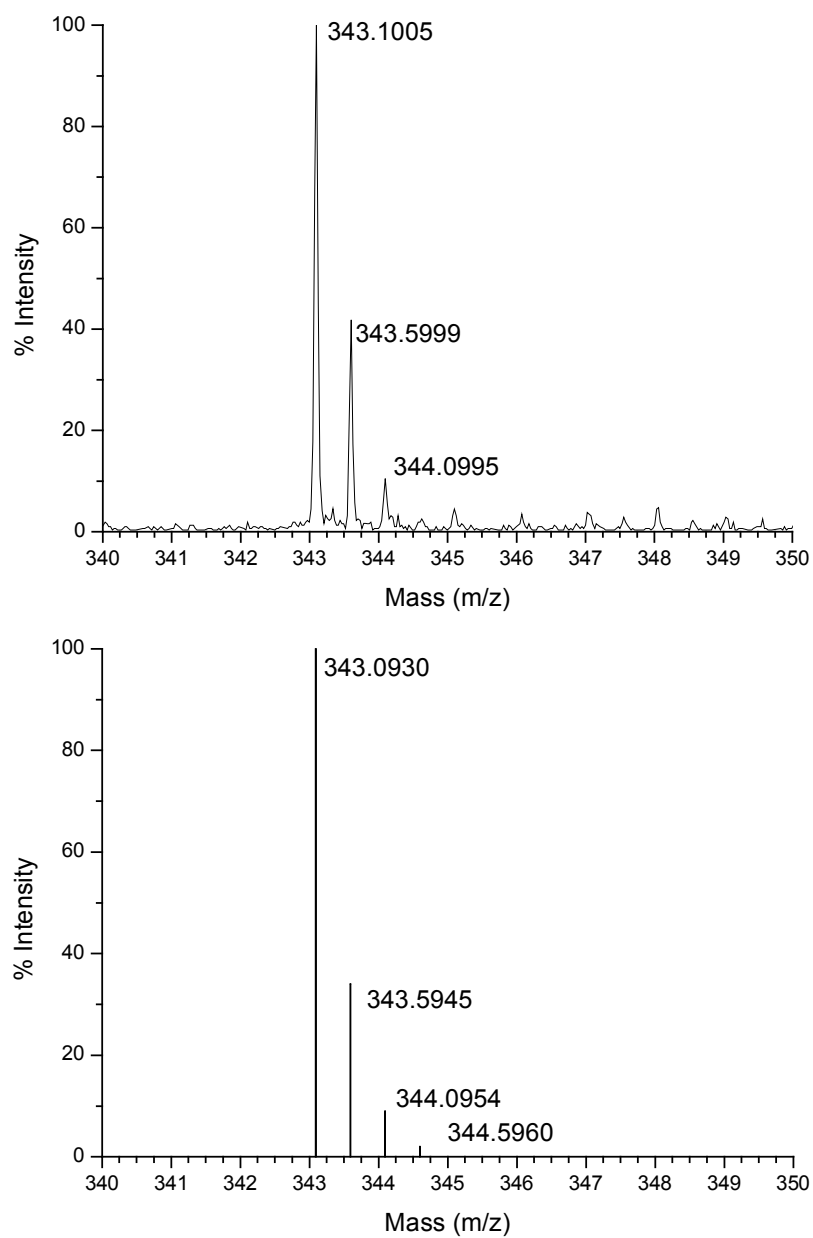

Figure 7: Measured (top) and predicted (bottom): ESI-MS spectra (positive mode) of $1 \cdot \text{CaCl}_2$ ($\text{C}_{28}\text{H}_{34}\text{N}_6\text{O}_{12} + \text{Ca}^{2+}/2$).

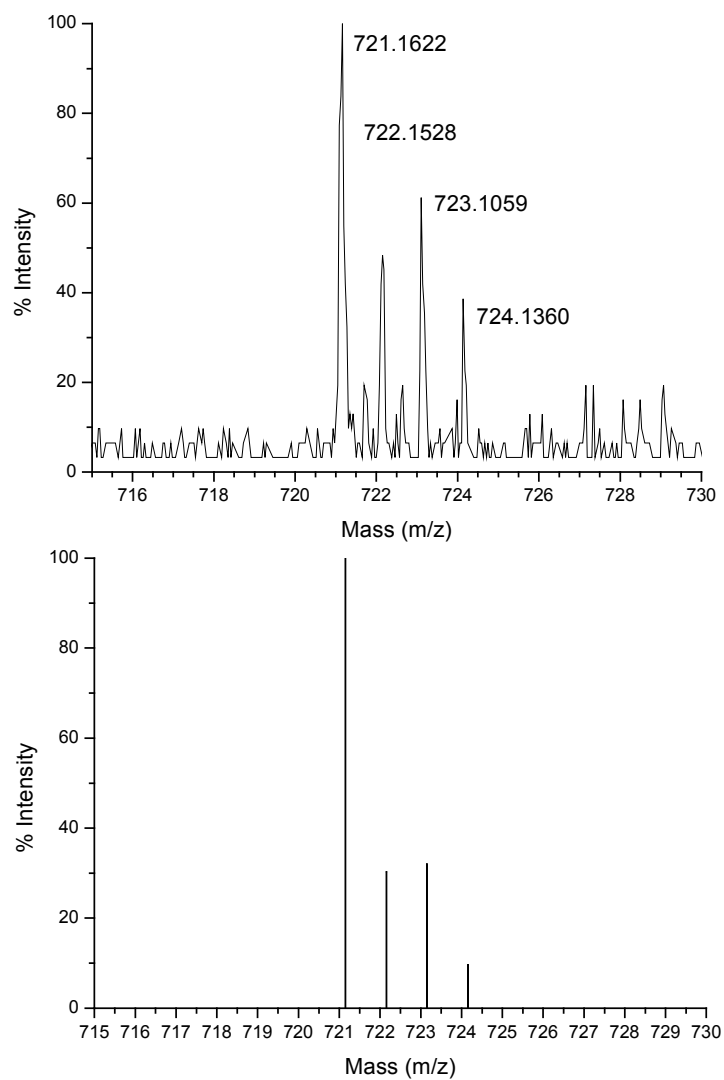

Figure 8: Measured (top) and predicted (bottom): ESI-MS spectra (positive mode) of $1 \cdot \text{CaCl}_2$ ($\text{C}_{28}\text{H}_{34}\text{N}_6\text{O}_{12} + \text{CaCl}^+$).

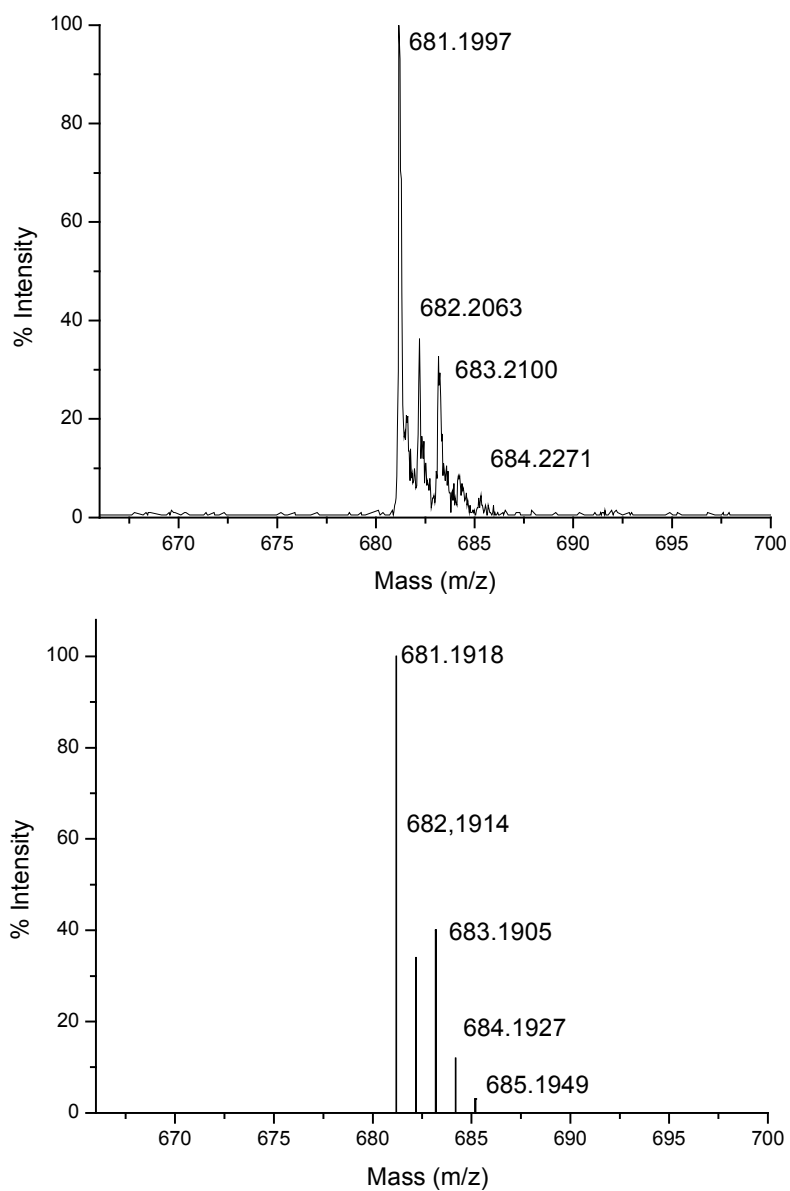

Figure 9: Measured (top) and predicted (bottom): ESI-MS spectra (negative mode) of $1 \cdot \text{LiCl}$ ($\text{C}_{28}\text{H}_{34}\text{N}_6\text{O}_{12} + \text{Cl}^-$).

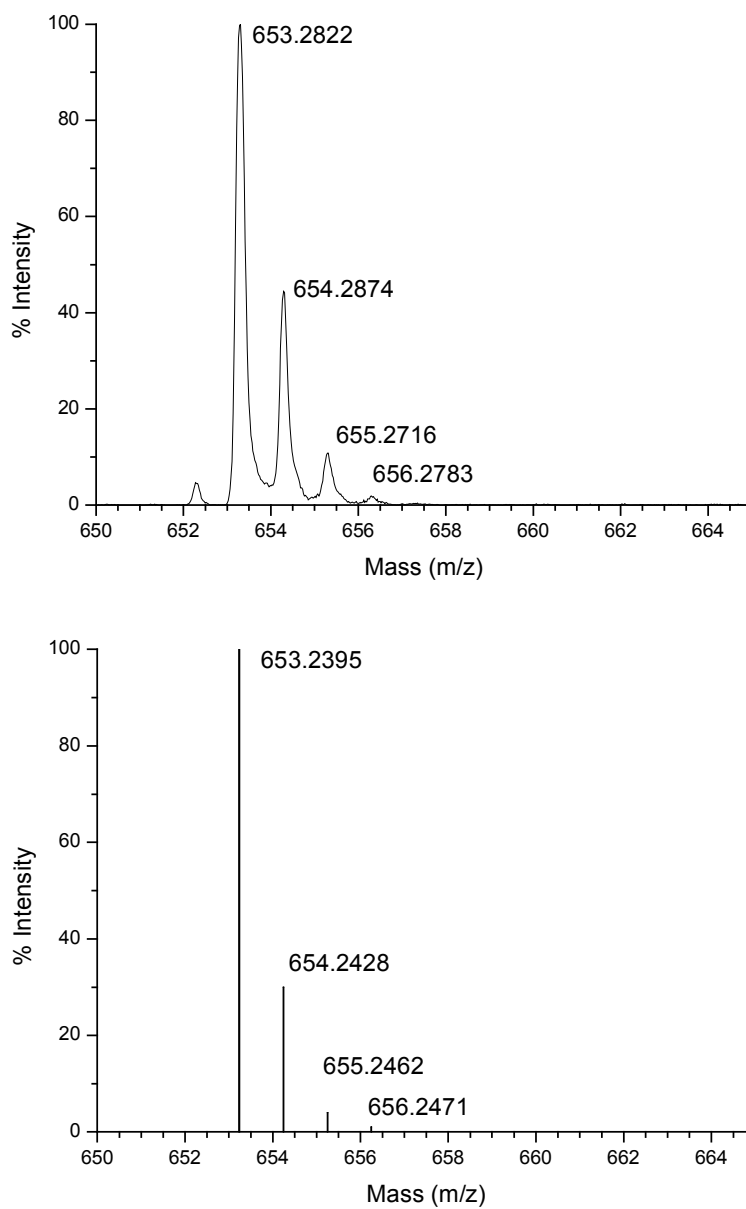

Figure 10: Measured (top) and predicted (bottom): MALDI-TOF spectra (CI-CCA) of $1 \cdot \text{LiCl}$ ($\text{C}_{28}\text{H}_{34}\text{N}_6\text{O}_{12} + \text{Li}^+$).

2D-NOESY experiments:

Using the NMR samples prepared as described above, phase sensitive 2D-NOESY experiments were acquired at 298 K with mixing times of 300 and 600 ms on a Bruker DRX500 instrument.

Spectra were acquired with 8 scans and a repetition delay of 2 sec, spectral widths of 4300 Hz, and 2048/128 total data points in F2 and F1 dimensions, respectively.

The data was zero-filled in F1 to 1028 real data points, weighted in both dimension with 90°-shifted squared sinebell function. Cross peaks were integrated after baseline correction. The obtained peak volumes were converted into distances using a two-spin approximation. For intensity calibration, the constant distance of H_a-H_b was used as a reference. When this NOE cross peak was not available due to overlap, the NOE between NH and H_c was used, assuming an average distance of 3.1 Å. All processing was performed with Topspin 2.1 (Bruker Biospin, Germany).

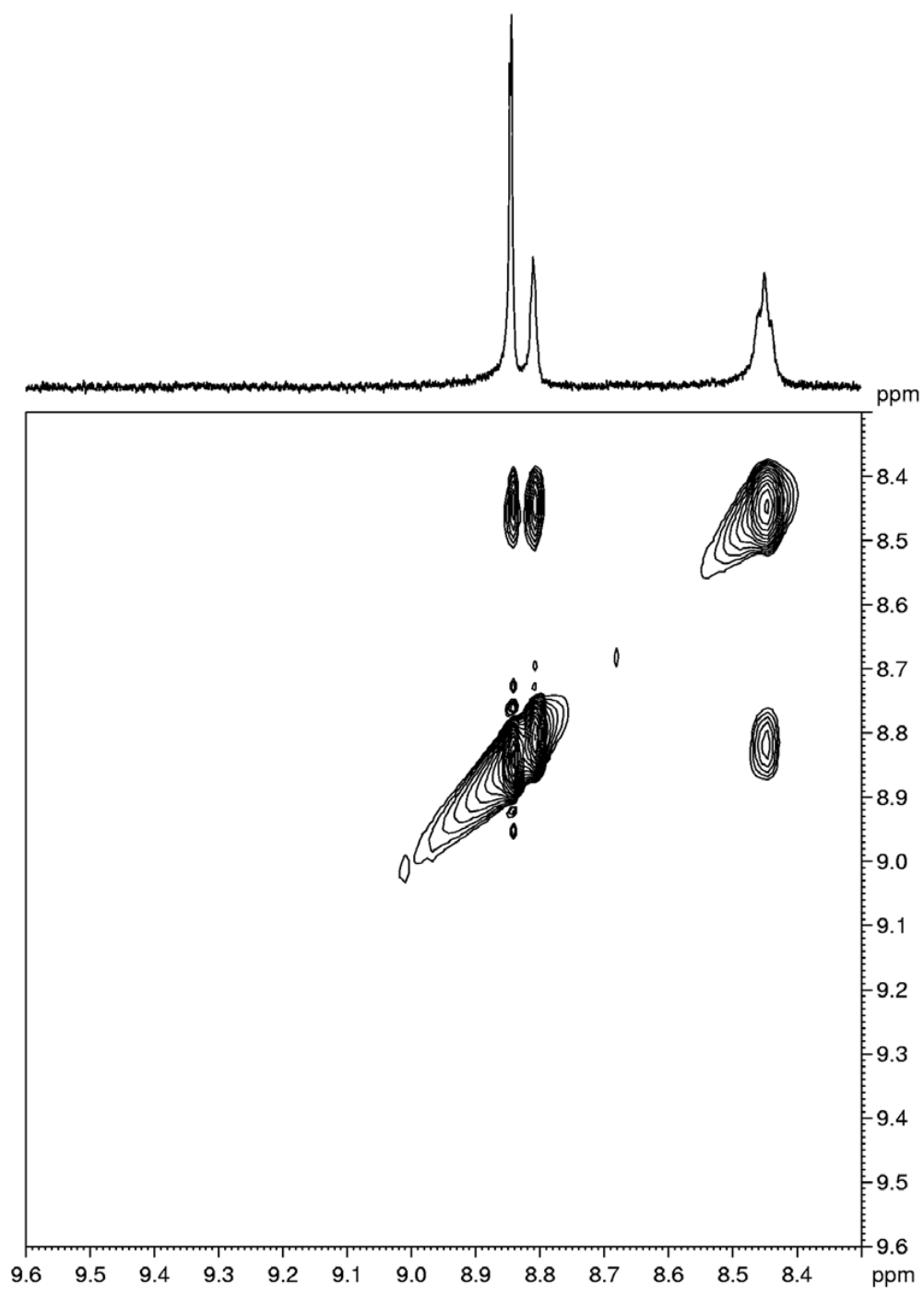

Figure 11: NOESY NMR (500 MHz; 298 K; CDCl₃/DMSO-d₆ 93:7 v/v; TMS) spectrum of **1**.

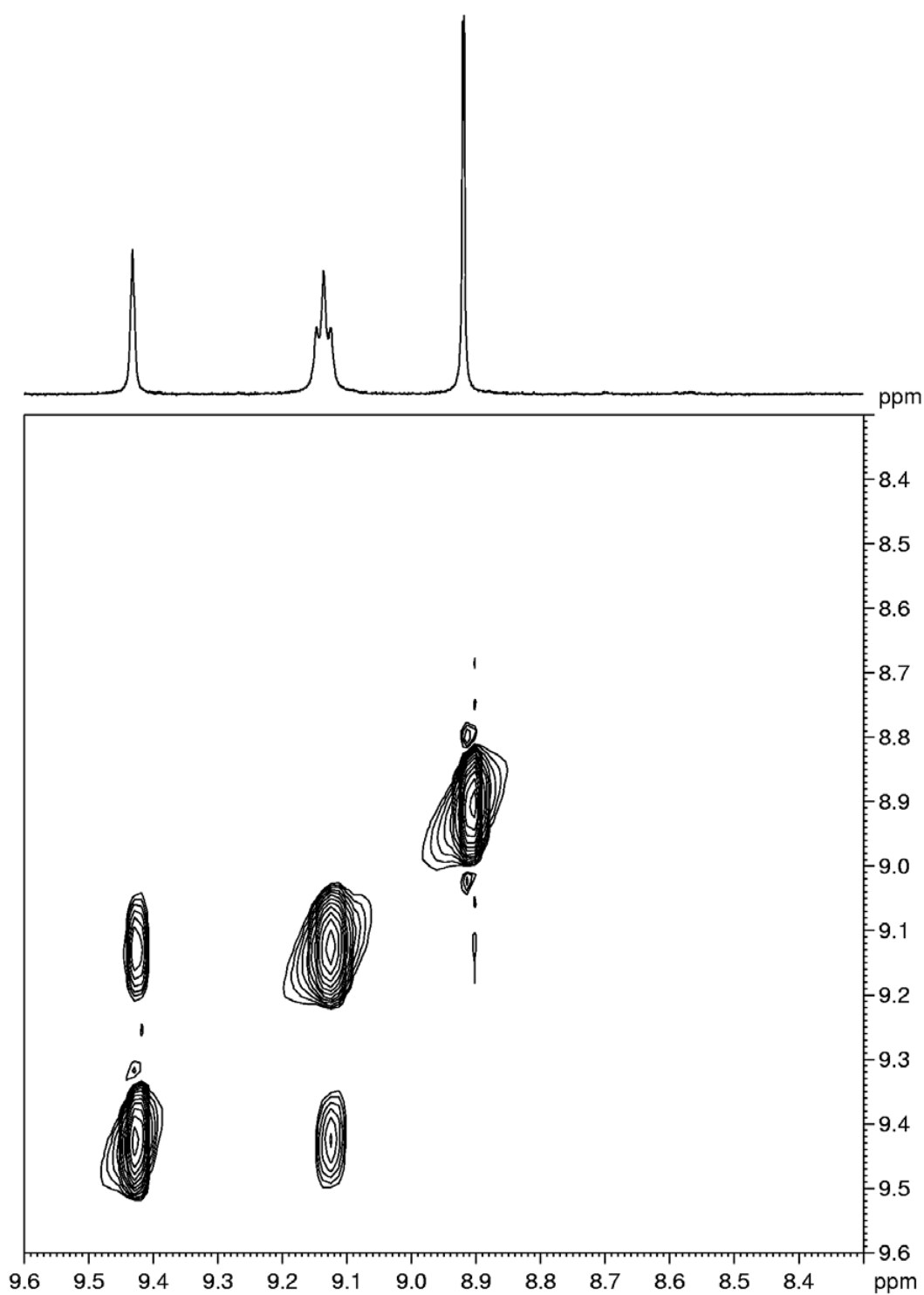

Figure 12: NOESY NMR (500 MHz; 298 K; $\text{CDCl}_3/\text{DMSO-d}_6$ 93:7 v/v; TMS) spectrum of $1\cdot\text{LiCl}$.

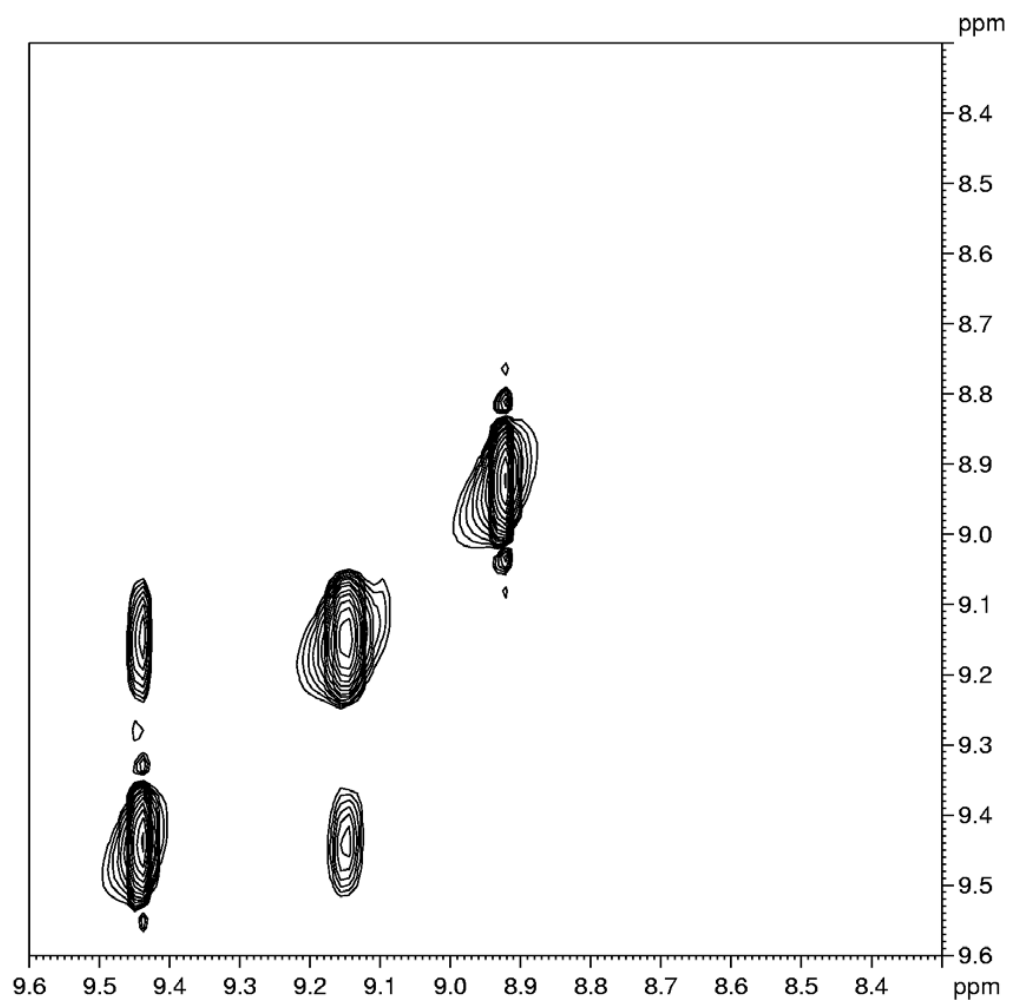

Figure 13: NOESY NMR (500 MHz; 298 K; $\text{CDCl}_3/\text{DMSO-d}_6$ 93:7 v/v; TMS) spectrum of 1-CaCl_2 .

Quantum mechanical calculations

Quantum mechanical calculations were carried out for $1 \cdot \text{CaCl}_2$. Top and side views for two minimized conformers (U- and S-shaped) are shown in Fig. 14. All calculations were done with Gaussian03.² Geometry optimizations were done using HF/6-31G(d). The calculations cannot reflect all aspects of the spectroscopic investigations because (i) those have been carried out in solvent, and (ii) the spectroscopic data are time averaged. Thus the conformers have to be viewed as snap-shots.

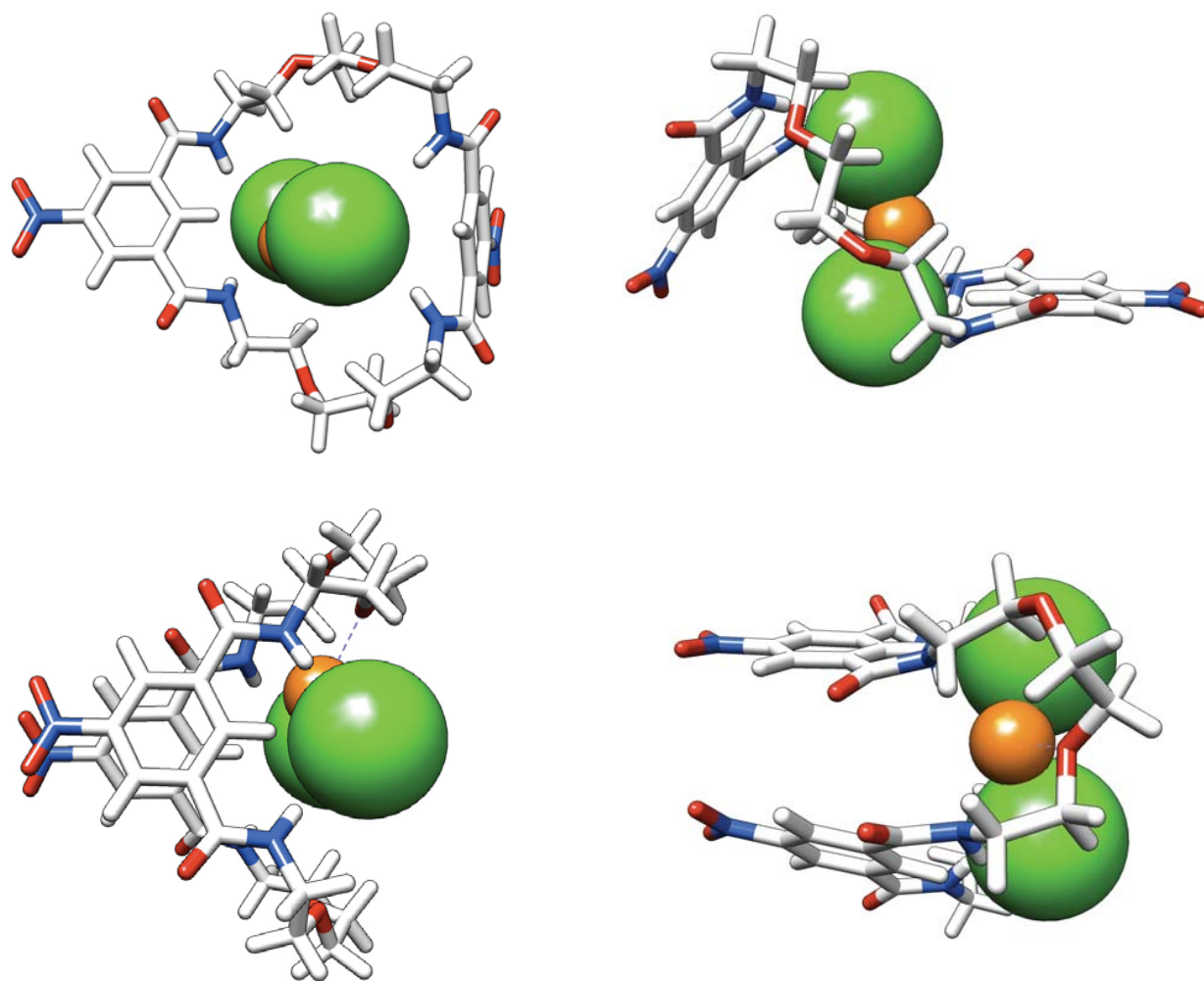

Figure 14: Two calculated conformers of $1 \cdot \text{CaCl}_2$.

¹ A. Dirksen, U. Hahn, F. Schwanke, M. Nieger, J. N. H. Reek, F. Vögtle, L. De Cola *Chem. Eur. J.*, 2004, **10**, 2036 - 2047.

² *Gaussian 03, Revision D.02*, M. J. Frisch, G. W. Trucks, H. B. Schlegel, G. E. Scuseria, M. A. Robb, J. R. Cheeseman, J. A. Montgomery, Jr., T. Vreven, K. N.

Kudin, J. C. Burant, J. M. Millam, S. S. Iyengar, J. Tomasi, V. Barone, B. Mennucci, M. Cossi, G. Scalmani, N. Rega, G. A. Petersson, H. Nakatsuji, M. Hada, M. Ehara, K. Toyota, R. Fukuda, J. Hasegawa, M. Ishida, T. Nakajima, Y. Honda, O. Kitao, H. Nakai, M. Klene, X. Li, J. E. Knox, H. P. Hratchian, J. B. Cross, V. Bakken, C. Adamo, J. Jaramillo, R. Gomperts, R. E. Stratmann, O. Yazyev, A. J. Austin, R. Cammi, C. Pomelli, J. W. Ochterski, P. Y. Ayala, K. Morokuma, G. A. Voth, P. Salvador, J. J. Dannenberg, V. G. Zakrzewski, S. Dapprich, A. D. Daniels, M. C. Strain, O. Farkas, D. K. Malick, A. D. Rabuck, K. Raghavachari, J. B. Foresman, J. V. Ortiz, Q. Cui, A. G. Baboul, S. Clifford, J. Cioslowski, B. B. Stefanov, G. Liu, A. Liashenko, P. Piskorz, I. Komaromi, R. L. Martin, D. J. Fox, T. Keith, M. A. Al-Laham, C. Y. Peng, A. Nanayakkara, M. Challacombe, P. M. W. Gill, B. Johnson, W. Chen, M. W. Wong, C. Gonzalez, and J. A. Pople, Gaussian, Inc., Wallingford CT, 2004.

4 Summary and Perspective

4.1 Summary

Dynamic Combinatorial Chemistry (DCC) is a powerful tool to discover and synthesize novel hosts in one step. In a Dynamic Combinatorial Library (DCL), all the members of the library, due to reversible reactions, are in equilibrium one with another. When a guest template is added, the equilibrium is shifted toward the host that better binds it. Subsequently, freezing the equilibration allows the purification of the host. Thus in one pot it is possible to obtain a host for a given guest (Fig. 4.1).

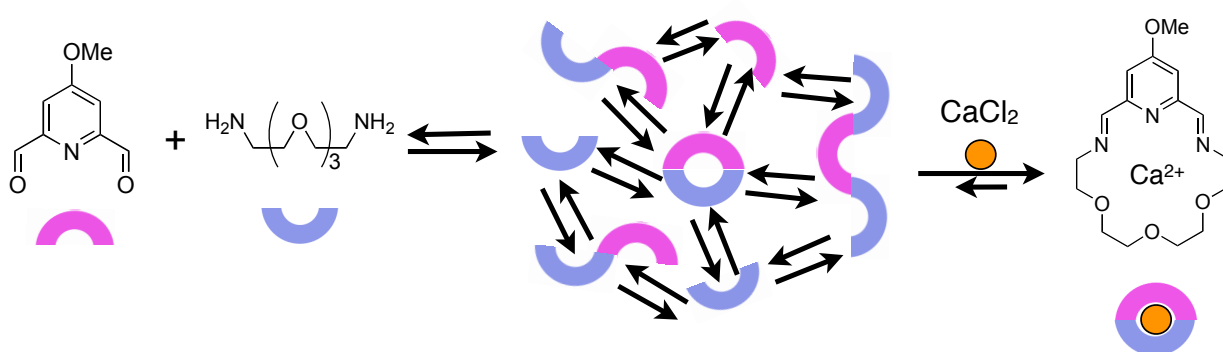

Figure 4.1: From two building blocks (left) a dynamic combinatorial library is set up (center). All the members of the library are in equilibrium with one another. The addition of a guest template shifts the equilibrium to the host that better binds it (right).

Using a DCL directly for a function is a remarkable step forward. This methodology allow to screen in one step not only for a product, but for a product useful for an application.

In this thesis the proof of concept of using a DCL directly for screening a given function is demonstrated. The transport of ions mediated by a carrier amplified from a DCL was tested and successfully achieved. A carrier macrocycle was formed directly from a DCL composed of imines using calcium ions as a template. Then the macrocycle transported calcium ions from a water source phase to a water receiver phase passing through different organic synthetic membranes. Proved for the first time, this goal was achieved in a series of experiments.

First of all the possibility of using a library composed of imines in water was studied. Usually imines are quickly hydrolyzed in presence of small amounts of water. However the hydrolysis is one of the possible pathway for the reversibility of the imine formation. Therefore it was interesting to test the stability of various imines in

the presence of increasing amounts of water. Moreover the presence of a template ion on this stability was screened (Ch. 3.1).

During this work, a discrepancy was found in the literature. In two different publications the same imine synthesis in water was described with two completely different yields. Repeating the experiments and using another reaction condition, it was possible to understand and explain the discrepancy. This discrepancy lies in the fact that the starting materials and the product were not soluble in water. Therefore it was important to differentiate between reaction and workup (Ch. 3.2).

Before starting the transport experiments, the same DCL of chapter 3.1 was screened in a biphasic system. At last, the possibility of amplifying a macrocyclic carrier directly in a bulk membrane experiment was proven. A carrier was amplified from the DCL and the template was subsequently transported from the aqueous source phase to the aqueous receiver phase passing through an organic solvent bulk membrane. The one step generation of a carrier from a library was successfully achieved for the first time (Ch. 3.3).

A forward development was realized setting up a double screening methodology using a larger DCL. In the first screening, the template selects and amplifies two similar macrocycles from the DCL, and in a second screening, the membrane, here a supported liquid membrane, selects the macrocycle with the best carrier activity. Thus in only one step the best carrier for a given guest was amplified and selected (Fig. 4.2). The proof of concept of a transport mediated by a DCL was also tested using liposomes as mimic of a biological membrane (Ch. 3.4).

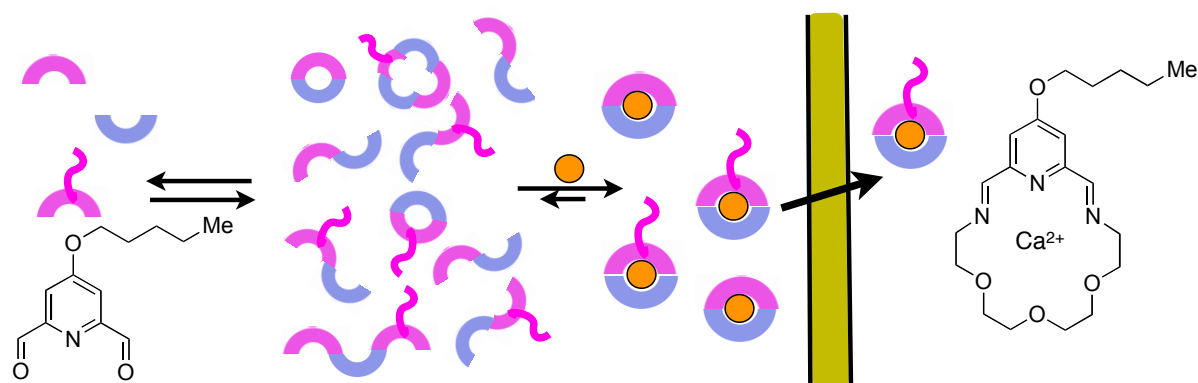

Figure 4.2: Double screening methodology. From three building blocks (left) a Dynamic Combinatorial Library is set up. In a first screening, the addition of a guest template amplifies two related hosts that better bind it (center). In a second screening the membrane itself (pear colour) selects the host with better carrier activity (right). Equilibrium arrows between the components of the library are omitted for clarity. For the cartoons representation of the other used molecules see figure 4.1.

Next development must deal with the transport of counter-ions. When cations are transported, one way to keep the electroneutrality of the system, is transporting anions simultaneously. In order to achieve this goal, a polytopic macrocycle is necessary. In such a macrocycle, the ion and the counter-ion are both partially shielded from the organic solvent. In a novel study, a macrocycle was synthesized and its ability to bind calcium chloride as an ion triplet was proven. This is the first description of a ion triplet complex (Ch. 3.5).

In a few words, a Dynamic Combinatorial Library can be used to screen for a carrier. The evidences of this proof of concept are shown in this thesis. This one step methodology is extremely flexible, and it can be used with different synthetic membranes. In fact its application was successfully tested using membranes with centimetres thickness (bulk membrane) to the nanometers thickness of liposomes. Moreover the presented methodology is, in principle, adaptable to all reversible reaction. This latter point is indeed interesting for synthesizing novel and diverse carriers in a one step fashion.

There is a great interest and a wide application of carriers in various field. This thesis has achieved a big step forward for the application of Dynamic Combinatorial Chemistry. Using the novel described methodologies, the screening of carriers can be done in a simple and fast way. The direct use of a library instead of a single purified product is the connection point between DCC and Systems Chemistry. Therefore this thesis stands between two new and emerging fields.

4.2 Perspective

The concept of using a DCL to screen for a carrier was proven. However the route to achieve a better performance of the methodology is still long. Using larger libraries composed of a larger number of building blocks with different lipophilicity will improve drastically the potential of the screening. Naturally when more products are screened, the possibilities of finding a carrier with high performance are higher.

The results of this thesis work now open also two new interesting tasks: Testing the methodology with cell membranes and the possibility of screening for a polytopic host by the use of ion pairs or triplets as guests.

The methodology of screening for a carrier was used with different synthetic membranes (bulk membrane, supported liquid membranes and liposomes). The logical continuation of the experiments presented in this thesis should be to use various cells. Using different cell lines it should be possible, in principle, to screen and find the best carrier for each type of cell membrane. Moreover the building

blocks can be modified using fluorescent groups. With those groups it should be easy to follow the movement and the position of the carrier in different cells. Using various drugs and a library composed of fluorescent building blocks, the formation of the carrier and the cellular uptake of the drug could be also screened.

Using contact pair or triplet ions as template, a Dynamic Combinatorial Library should be used to screen for macrocycles that bind ions as contact pairs or triplets. The use of ion pairs or triplets as template in DCC is still not exploited.

5 References

- ¹ J.-M. Lehn, *Supramolecular Chemistry*, Wiley-VCH, Weinheim, **1995**.
- ² C. J. Pedersen, *J. Am. Chem. Soc.*, **1967**, *89*, 7017-7036.
- ³ *Nobel Lectures Chemistry 1981-1990*, Ed. Bo G. Malmström, World Scientific Publishing Co., Singapore, **1992**.
- ⁴ J. W. Steed, J. L. Atwood, *Supramolecular Chemistry*, Wiley, New York, **2000**.
- ⁵ J. W. Steed, D. R. Turner, K. J. Wallace, *Core concepts in Supramolecular Chemistry and Nanochemistry*, Wiley-VCH, Weinheim, **2007**.
- ⁶ K.-H. Frömring, J. Szejtli, *Cyclodextrins in Pharmacy*, Kluwer Academic Publisher, Dordrecht, **1994**.
- ⁷ J. F. Stoddart, *Chem. Soc. Rev.*, **2009**, *38*, 1802-1820.
- ⁸ E. R. Kay, D. A. Leigh, "Synthetic Molecular Machines", in *Functional Artificial Receptors*, T. Schrader, A. D. Hamilton (eds.), Wiley-VCH, Weinheim, pp 333-406, **2005**.
- ⁹ B. L. Feringa, *Acc. Chem. Res.*, **2001**, *34*, 504-513.
- ¹⁰ P. T. Corbett, J. Leclaire, L. Vial, K. R. West., J.-L. Wietor, J. K. M. Sanders, S. Otto, *Chem. Rev.*, **2006**, *206*, 3652-3711.
- ¹¹ I. Huc, J.-M. Lehn, *Proc. Natl. Acad. Sci. USA*, **1997**, *94*, 2106-2110.
- ¹² P. A. Brady, J. K. M. Sanders, *J. Chem. Soc., Perkin Trans. 1*, **1997**, *21*, 3237-3252.
- ¹³ One example of a Dynamic Combinatorial Library based on imines studied in our laboratory: O. Storm, U. Lüning, *Chem. Eur. J.*, **2002**, *8*, 793-798.
- ¹⁴ One example of a Dynamic Combinatorial Library of pseudo-peptide hydazone macrocycles: G. R. L. Cousins, S. A. Poulsen, J. K. M. Sanders, *Chem. Commun.*, **1999**, 1575-1577.
- ¹⁵ Report on selection and amplification of hosts from a DCL of macrocyclic disulfides: S. Otto, E. L. R. Furlan, J. K. M. Sanders, *Science*, **2002**, *297*, 590-593.
- ¹⁶ S. Lüthje, *Ph.D. Thesis*, Christian-Albrechts-Universität zu Kiel, **2006**.
- ¹⁷ D. Stoltenberg, *Ph.D. Thesis*, Christian-Albrechts-Universität zu Kiel, **2010**.
- ¹⁸ I. Saur, K. Severin, *Chem. Commun.*, **2005**, 1471-1473.
- ¹⁹ M. C. Calama, R. Hulst, R. Fokkens, N. M. M. Nibbering, P. Timmerman, D. N. Reinhoudt, *Chem. Commun.*, **1998**, 1021-1022.
- ²⁰ V. Goral, M. I. Nelen, A. V. Eliseev, J.-M. Lehn, *Proc. Natl. Acad. Sci. USA*, **2001**, *98*, 1347-1352.
- ²¹ C. D. Meyer, C. S. Joiner, J. F. Stoddart, *Chem. Soc. Rev.*, **2007**, *36*, 1705-1723.
- ²² H. Schiff, *Ann. Chem.*, **1864**, *131*, 118-119.
- ²³ Borch reductive amination by NaBH₃CN: R. F. Borch, M. D. Bernstein, H. D. Durst, *J. Am. Chem. Soc.*, **1971**, *93*, 2897-2904.
- ²⁴ Reductive amination by NaBH(OAc)₃: A. F. Abdel-Magid, K. G. Carson, B. D. Harris, C. A. Maryanoff, R. D. Shah, *J. Org. Chem.*, **1996**, *61*, 3849-3862.

- ²⁵ C. Mannich, W. Krösche, *Arch. Pharm.*, **1912**, *250*, 647-667.
- ²⁶ I. Ugi, *Angew. Chem.*, **1962**, *74*, 9-22; *Angew. Chem. Int. Ed.*, **1962**, *1*, 8-21.
- ²⁷ N. K. Terret, *Combinatorial Chemistry*, Oxford University Press, Oxford, **1998**.
- ²⁸ K. C. Gupta, A. K. Sutar, *Coord. Chem. Rev.*, **2008**, *252*, 1420-1450.
- ²⁹ V. C. Gibson, C. Redshaw, G. A. Solan, *Chem. Rev.*, **2007**, *107*, 1745-1776.
- ³⁰ P. A. Vigato, S. Tamburini, L. Bertolo, *Coord. Chem. Rev.*, **2007**, *251*, 1311-1492.
- ³¹ N. E. Borisova, M. D. Reshetova, Y. A. Ustynyuk, *Chem. Rev.*, **2007**, *107*, 46-79.
- ³² D. M. Epstein, S. Choudhary, M. R. Churchill, K. M. Keil, A. V. Eliseev, J. R. Morrow, *Inorg. Chem.*, **2001**, *40*, 1591-1596.
- ³³ J.-B. Lin, X.-N. Xu, X.-K. Jiang, Z. -T. Li, *J. Org. Chem.*, **2008**, *73*, 9403-9410.
- ³⁴ A. Herrmann, N. Giuseppone, J.-M. Lehn, *Chem. Eur. J.*, **2009**, *15*, 117-124.
- ³⁵ A. González-Álvarez, I. Alfonso, F. López-Ortiz, A. Aguirre, S. García-Granda, V. Gotor, *Eur. J. Org. Chem.*, **2004**, 1117-1127.
- ³⁶ A. González-Álvarez, I. Alfonso, V. Gotor, *Chem. Commun.*, **2006**, 2224-2226.
- ³⁷ S. Ladame, *Org. Biomol. Chem.*, **2008**, *6*, 219-226.
- ³⁸ Catalysis used as self-screen for substrates from a Dynamic Combinatorial Library: R. Larsson, Z. Pei, O. Ramström, *Angew. Chem.*, **2004**, *116*, 3802-3804; *Angew. Chem. Int. Ed.*, **2004**, *43*, 3716-3718.
- ³⁹ "Dynamic Combinatorial Libraries of Dye Complexes as Sensors": A. Buryak, K. Severin, *Angew. Chem.*, **2005**, *117*, 8149-8152; *Angew. Chem. Int. Ed.*, **2005**, *44*, 7935-7938.
- ⁴⁰ "Dynamic Combinatorial Libraries of Metal-Dye Complexes as Flexible Sensors for Tripeptides": A. Buryak, K. Severin, *J. Comb. Chem.*, **2006**, *8*, 540-543.
- ⁴¹ Nowadays the use of a chemical library instead of a single compound is growing in importance (system chemistry): R. F. Ludlow, S. Otto, *Chem. Soc. Rev.*, **2008**, *37*, 101-108.
- ⁴² A. Herrmann, *Org. Biomol. Chem.*, **2009**, *7*, 3195-3204.
- ⁴³ V. Saggiomo, U. Lüning, *Chem. Commun.*, **2009**, 3711-3713.
- ⁴⁴ R. Pérez-Fernandez, M. Pittelkow, A. M. Belenguer, L. A. Lane, C. V. Robinson, J. K. M. Sanders, *Chem. Commun.*, **2009**, 3708-3710.
- ⁴⁵ It is impossible to give an comprehensive overview of transport in all of its facets without writing a book. However it will be helpful to remember that:
Passive transport does not require energy. The movement of molecules or ions across the membrane is due to a concentration or electrochemical gradient. The flux is achieved by simple diffusion, facilitated diffusion by the help of carriers or channels, and by osmosis.
Active transport, on the contrary, is the movement of molecules or ions against a concentration or electrochemical gradient and it requires energy.
- ⁴⁶ Reprint with permission of Prof. Tom Flyes (University of Victoria), "Membrane Transport", XIII International Symposium on Supramolecular Chemistry, Workshop on Membrane Transport, **2004**.

Eidesstattliche Erklärung

Hiermit erkläre ich, Vittorio Saggiomo, an Eides statt, dass ich die vorliegende Dissertation selbständig und nur mit den angegebenen Hilfsmitteln angefertigt habe. Die Arbeit ist nach Inhalt und Form, abgesehen von der Beratung durch meinen Betreuer, durch mich eigenständig erarbeitet und verfasst worden. Die Arbeit entstand unter Einhaltung der Regeln guter wissenschaftlicher Praxis der Deutschen Forschungsgemeinschaft. Weder die gesamte Arbeit noch Teile davon wurden von mir an anderer Stelle im Rahmen eines Prüfungsverfahrens eingereicht. Dies ist mein erster Promotionsversuch.

Kiel, 04.03.2010

Vittorio Saggiomo

Lebenslauf

Persönliche Daten

Vor- und Zuname: Vittorio Saggiomo
Geburtsdatum und -ort: 31.07.1980, Napoli
Nationalität: Italian
Anschrift: Schauenburgerstr. 64, 24118 Kiel
Email: vsaggiomo@oc.uni-kiel.de

Ausbildung

11/ 1998 - 03/ 2007 Master in Chemistry, Federico II Università di Napoli

03/ 2007 Master Thesis supervised by Prof. Daniela Montesarchio: "*Novel Amphiphilic Cyclic Oligosaccharides: Synthesis and Self-Aggregation Properties*"

seit 05/ 2007 Early Stage Researcher in the EU Marie Curie Initial Training Network "Dynamic Combinatorial Chemistry" supervised by Prof. Dr. Ulrich Lüning in Kiel

Kiel, 04.03.2010