

*Habitats and
chemical characteristics
of modern
planktonic foraminifera
in the
Atlantic Ocean*



*Dissertation
zur Erlangung des Doktorgrades
der Mathematisch-Naturwissenschaftlichen Fakultät
der Christian-Albrechts-Universität zu Kiel*

*vorgelegt von
Almuth Thea Elisabeth Harbers*

2011

**HABITATS AND
CHEMICAL CHARACTERISTICS OF
MODERN PLANKTONIC FORAMINIFERA
IN THE ATLANTIC OCEAN**

Dissertation

zur Erlangung des Doktorgrades
der Mathematisch-Naturwissenschaftlichen Fakultät
der Christian-Albrechts-Universität
zu Kiel

vorgelegt von

Almuth Thea Elisabeth Harbers

Kiel 2011

Referent

Prof. Dr. Martin Frank

Co-Referent

Prof. Dr. Wolf-Christian Dullo

Tag der Disputation

01.03.2011

Zum Druck genehmigt

01.03.2011

Abstract

Planktonic foraminifera are free-floating protozoa, which react sensitively on their immediate environment. The geographical distribution of planktonic foraminifera is, above all, related to water temperature. On the other hand, the vertical distribution is much more differentiated and governed by an interaction of physical, biological and chemical parameters. Chemical entities are also imprinting foraminiferal shells during their ontogenesis and thus, make the foraminifera a signal carrier for environmental and paleoceanographical proxies. Therefore, I focused on biogeographical studies and on chemical aspects to assess planktonic foraminiferal habitats and to improve our understanding of the role of planktonic foraminifera as environmental signal carriers. The present study focuses on three regions of the Atlantic Ocean, the seas to the west of Ireland, Cape Verde and central tropical Atlantic

A comparison of faunal composition in intermediate water of the North Atlantic Ocean did not reveal differences between recent faunal composition to subfossil assemblages from surface sediments, but the species proportions were different. This contrast was mainly driven by the subtropical species *Globorotalia hirsuta*, which was frequent in 2004 but rare in surface sediment samples and in earlier plankton collections obtained from the southern Porcupine Seabight during the 1990s. Furthermore, the study revealed the influence of phytoplankton blooms on foraminiferal weight and thus, a strong contribution of *G. hirsuta*, *Neogloboquadrina incompta* and *Globigerina bulloides* to the foraminiferal carbonate flux.

In the tropical Atlantic, the fine-scale vertical distribution coupled with the size distribution of planktonic foraminiferal species revealed a distinctly different standing stock between the central Atlantic and the Cape Verde region. The most regular pattern was observed in the surface dwelling *Globigerinoides sacculifer*, which had a steady abundance over the entire sampling period in both regions. In contrast, *Globorotalia menardii* showed highly variable abundances at the different locations but their depth range was similar. A comparison of the faunal assemblages with historical data revealed significant changes in foraminiferal assemblage and abundances that took place during the past 80 years. Notably, a distinct, historical decline in the abundance of *Globigerinoides ruber* white was recognized. The observation was confirmed by core-top assemblages where this species was frequent. The faunal changes seem to be linked to a general increase of sea surface temperature of approximately 2°C in this area.

The trace element analyses of several planktonic foraminiferal species revealed highly variable concentrations within each specimen, species and even individual chambers. Though the barium and boron content of our samples are much higher than reported in other studies, the values support assumptions that non-spinose species incorporate more barium than spinose species, and symbiont-bearing foraminifera show higher boron concentrations than symbiont-barren species. The calculation of the calcification temperatures of *G. sacculifer* following established paleotemperature equations are 2.6°C and 3.1°C higher than the temperatures that were actually measured. The difference in *G. menardii* was only 0.5°C however. The data demonstrated that measured seawater oxygen isotopes, ambient temperature, and oxygen isotopes from the precipitated shell carbonate infer temperature relationships with a much higher accuracy than previous approaches using derived parameters.

Kurzfassung

Planktonforaminiferen sind treibende Protozoen, die sehr empfindlich auf äußere Einflüsse reagieren. So ist zum Beispiel ihre geographische Verteilung zum großen Teil von der Wassertemperatur abhängig. Ihre vertikale Verteilung in der Wassersäule ist jedoch abhängig von weitaus differenzierten Zusammenhängen, wobei physikalische, biologische und chemische Faktoren eine Rolle spielen. Die chemischen Parameter sind es auch, die während der Ontogenese der Foraminiferen ihre Spur hinterlassen und die Planktonforaminiferen zu einem Signalträger für paläozeanische und umweltbedingte Proxies macht. Diese Arbeit konzentriert sich daher auf biogeographische und chemische Aspekte, um die Lebensräume der Planktonforaminiferen darzustellen und unser Verständnis der Rolle der Foraminiferen als Signalträger für umweltbedingte Proxies zu verbessern. Diese Studie konzentriert sich auf drei Regionen des Atlantischen Ozeans, die Gewässer westlich von Irland, Kap Verde und den tropischen Zentralatlantik.

Der Vergleich der Faunenzusammensetzung in den Gewässern des Nordatlantiks ergab keine nennenswerten Unterschiede zwischen der rezenten Fauna und der Zusammensetzung von oberflächennahen Sedimenten. Die Anteile der verschiedenen Arten waren allerdings unterschiedlich. Dieser Unterschied wurde vor allem durch die subtropische Art *Globorotalia hirsuta* verursacht, da sie sehr häufig in den Proben aus Jahr 2004 auftrat, aber kaum in den Oberflächensedimenten und in Proben aus den 90er Jahren zu finden war. Weiterhin fanden wir heraus, daß eine Phytoplanktonblüte großen Einfluß auf das Gewicht von Planktonforaminiferen hatte. Die Arten *G. hirsuta*, *Neogloboquadrina incompta* und *Globigerina bulloides* trugen so einen großen Teil zum Karbonatfluß bei.

Im tropischen Atlantik zeigte die feinskalige Vertikalverteilung im Zusammenhang mit der Größenverteilung von Planktonforaminiferen eine starke unterschiedliche Besatzdichte im Zentralatlantik und der Region um Kap Verde. Die gleichmäßigste Verteilung innerhalb der gesamten Beprobungszeit konnte in *Globigerinoides sacculifer* in beiden Gebieten beobachtet werden. Im Gegensatz dazu, zeigt *Globorotalia menardii* eine starke Variabilität in ihrer Besatzdichte, ihre Tiefenverteilung hingegen zeigt gleichmäßige Werte. Ein Vergleich von Faunenzusammensetzungen aus historischen Daten zeigt eine deutliche Veränderung innerhalb der letzten 80 Jahre bezüglich der Artenzusammensetzung und Häufigkeit. Vor allem wurde eine starke Verminderung in der Häufigkeit von *Globigerinoides ruber* White bemerkt. Diese Beobachtung konnte durch Kernoberflächenproben bestätigt werden. Die Faunenänderungen scheinen im Zusammenhang mit einem allgemeinen Temperaturanstieg um ungefähr 2°C im Oberflächenwasser des Untersuchungsgebietes zu stehen.

Spurenelementanalysen von verschiedenen Planktonforaminiferenarten zeigen eine hohe Variabilität zwischen den Arten, aber auch einzelner Exemplare und sogar derselben Kammer. Obwohl die Barium- und Borgehalte unserer Proben höhere Werte zeigen als in Proben anderer Studien, können wir die Annahmen, daß nicht-spinose Arten mehr Barium in ihr Gehäuse einbauen als spinose Arten, und daß symbiont-tragende Arten höhere Bor Werte zeigen als Arten ohne Symbionten unterstützen. Die Berechnung von Kalzifizierungstemperaturen von *G. sacculifer* nach bekannten Formeln zur Errechnung von Paläotemperaturen liegt um 2.6°C bzw. 3.1°C höher als

die gemessenen Temperaturen. Der Unterschied in *G. menardii* liegt bei 0.5°C. Die Daten demonstrieren, daß gemessene Sauerstoffisotopen des Wassers, die Temperatur und die Sauerstoffisotopie der Foraminifernkarbonats eine sehr viel höhere Genauigkeit der Temperaturbeziehung zeigen als frühere Studien, welche abgeleitete Parameter zur Berechnung nutzten.

Acknowledgements

It is a pleasure to thank those who made this thesis possible. First, I would like to thank Prof. Dr. Martin Frank and Prof. Dr. Wolf-Christian Dullo who took the part as supervisors. Above all, I am heartily thankful to my advisor Dr. Joachim Schönfeld, who inspired me with his work ethic and his endless supply of guidance and patience from initial to the final level. He initiated the project and gave me the opportunity to work with a group of excellent scientists.

This study was funded by the Kieler Exzellenzcluster “Future Ocean”. Especially I am grateful to Prof. Dr. Martin Frank and Prof. Dr. Wolf-Christian Dullo who provided financial support for the third year.

For the opportunity of publishing my first chapter, I am grateful for the advice and comments of the editor Andy Gooday and three anonymous reviewer. For supporting discussion I thank Dr. Ralf Schiebel from the University of Angers, France, and Dr. Andres Rüggeberg from the Renard Center of Marine Geology in Ghent. I am grateful to Eugenia Kandiano and Kevin Brown from the IFM-GEOMAR as well as Mark Chapman from the UEA who took their time to discuss taxonomy. Many thanks go to Ute Schuldt, who took the REM at the Institute of Geosciences, Kiel, Henning Kuhnert, who provided the LA-ICP-MS sessions in Bremen and Nils Andersen, who carried out the stable isotope measurements.

I would like to thank the INDP for providing the cruises and laboratory use in Mindelo, Cape Verde. I am grateful to Pericles Silva, Ivanice Monteiro and Franziska Hellmich for any support in Mindelo and accomplishment of the cruises. I thank chief scientist Colin Devey, and the crew of R/V *Atalante* for assisting during sampling on cruise MARSUED IV. I am also very thankful to Peter Brandt and Jürgen Fischer from IFM-GEOMAR Kiel for providing thermosalinograph data and to Björn Fiedler and Christian Mertens, who provided CTD data for this study. Thanks also go to NERC Earth Observation Data Acquisition and Analysis Service (NEODAAS) who provided SeaWiFS and AVHRR data.

I am very grateful for the contributions, comments, support and encouragement in any matter by colleagues and friends. Therefore, in alphabetical order, I thank Sebastian Beil, Dr. Ed Hathorne, Kristin Haynert, Agnes Heinemann, Jutta Heinze, Karen Hissmann, Basak Kisakurek, Steffanie Kraft, Dr. Anna Nikulina, Dr. Irina Polovodova, Dr. Marcus Regenberg, Jan Riethdorf, Julia Schwab, Roland Stumpf, Claudia Teschner and Dr. Syee Weldeab. Lastly, I offer my regards and blessings to all of those who supported me in any respect during the completion of the project.

It is an honor for me to dedicate this thesis to my beloved mother and my beloved late father.

Contents

Abstract	i
Kurzfassung	ii
Acknowledgements	iv
Introduction	1
1. Planktonic foraminifera	1
2. The Atlantic Ocean	1
3. Planktonic foraminiferal sampling	2
4. Outline	3
Chapter 1 – Short term dynamics of planktonic foraminiferal sedimentation in the Porcupine Seabight	
Abstract	5
1.1. Introduction	5
1.1.1. Oceanographic Setting	7
1.1.2. Geographical Setting	7
1.2. Materials and Methods	8
1.2.1. Sediment trap	8
1.2.2. Core-top samples	9
1.2.3. Taxonomy	10
1.2.4. Hydrography and assemblage data	10
1.3. Results	10
1.3.1. Hydrography	10
1.3.2. Depositional flux	10
1.3.3. Foraminiferal flux	11
1.3.3.1. Sediment trap	11
1.3.3.2. Core-top assemblage	13
1.3.3.3. Shell and carbonate flux	13
1.3.4. Species dynamics	15
1.3.5. Core-top analyses	16
1.4. Discussion	17
1.4.1. Spatial distribution	17
1.4.2. Foraminiferal flux	18
1.4.2.1. Faunal composition	19
1.4.3. Sediment accumulation	20
1.5. Conclusion	21

Chapter 2 – Geographical and vertical distribution of planktonic foraminiferal assemblages in the tropical Atlantic Ocean

Abstract	22
2.1. Introduction	22
2.1.1. Planktonic foraminiferal survey	22
2.1.2. Oceanography	23
2.1.2.1. Central Atlantic	23
2.1.2.2. Cape Verde	25
2.2. Material and Methods	26
2.2.1. Plankton sampling	26
2.2.1.1. Central Atlantic	26
2.2.1.2. Cape Verde	26
2.2.2. Taxonomy	28
2.2.3. Faunal analyses	28
2.2.4. Hydrography	28
2.2.5. Sediment surface data	28
2.2.6. Historical data	29
2.3. Results	29
2.3.1. Foraminiferal assemblage	29
2.3.1.1. Central Atlantic (underway data)	29
2.3.1.2. Central Atlantic (plankton tows)	30
2.3.1.3. Cape Verde	32
2.3.2. Vertical dynamics	33
2.3.2.1. Central Atlantic	33
2.3.2.2. Cape Verde	36
2.3.3. Core-top analyses	39
2.3.3.1. Central Atlantic	39
2.3.3.2. Cape Verde	41
2.4. Discussion	42
2.4.1. Sampling interferences	42
2.4.1.1. Pump sampling	42
2.4.1.2. Daily vertical migration	42
2.4.1.3. Tow sampling	43
2.4.2. Historical changes in faunal composition	44
2.4.2.1. Central Atlantic	44
2.4.2.2. Cape Verde	46
2.5. Conclusion	47

Chapter 3 – Chemical characteristics of recent planktonic foraminifera
in the Atlantic Ocean – a LA-ICP-MS study

Abstract	48
3.1. Introduction	49
3.2. Materials and Methods	49
3.2.1. Plankton samples	49
3.2.1.1. Porcupine Seabight	49
3.2.1.2. Tropical Atlantic	49
3.2.2. Taxonomy	50
3.2.3. Hydrographic data	50
3.2.4. Sample preparation	50
3.2.4.1. Porcupine Seabight	50
3.2.4.2. Tropical Atlantic	51
3.2.4.3. Cleaning procedure	51
3.2.5. Chemical analyses	51
3.2.5.1. Laser ablation	51
3.2.5.2. Stable isotopes $\delta^{13}\text{C}$ and $\delta^{18}\text{O}$	52
3.3. Results	53
3.3.1. Chemical composition of planktonic foraminiferal species	53
3.3.2. <i>G. sacculifer</i> and <i>G. menardii</i> as temperature proxies	57
3.4. Discussion	58
3.4.1. Chemical characteristics	58
3.4.2. Temperature proxies	61
3.5. Conclusion	62
Outlook – The significance of lunar cycles	64
References	66
Appendix	
Appendix 1. Faunal composition Galway Mound	II
Appendix 2. Faunal composition Tropical Atlantic	III
Appendix 2.1. Central Atlantic Ocean	III
Appendix 2.2. Cape Verde	IV
Appendix 3. Trace element analyses	V
Appendix 3.1. <i>G. sacculifer</i>	V
Appendix 3.2. <i>G. menardii</i>	VI
Appendix 3.3. <i>G. hirsuta</i>	VII
Appendix 3.4. <i>G. crassaformis</i>	VII

Appendix 3.5. <i>G. ruber</i> pink	VII
Appendix 3.6. <i>N. dutertrei</i>	VIII
Appendix 3.7. <i>G. bulloides</i>	VIII
Appendix 3.8. <i>N. incompta</i>	IX
Appendix 3.9. <i>G. inflata</i>	IX
Appendix 4 - Plates	
Plate 1	XI
Plate 2	XIII
Plate 3	XIV
Plate 4	XV
Plate 5	XVI
Plate 6	XVII

Introduction

1. Planktonic foraminifera

Nearly two hundred years ago, planktonic foraminifera were first described by D`Orbigny (1826). Today, approximately forty-four living planktonic foraminiferal species are known (Hemleben et al., 1989). They are distinguished by their morphology, including shell shape and surface structure. The absence or presence of spines, group the planktonic foraminifera in spinose and non-spinose species (Murray, 1897). The diet of spinose species, predominantly is zooplankton, particularly copepods, non-spinose species mostly feed on algae (Rhumbler, 1911), whereas some species are known as omnivorous. Some planktonic foraminifera may also contain symbiotic algae, which makes them light-dependent. Thus, some foraminifera are living in the photic zone of the oceans, others are known as deep-dwellers and intermediate-dwelling species, respectively. Among others, the availability of nutrients and the water temperature are two basic facts, that determine the species composition of faunal assemblages (Bè and Tolderlund, 1971).

Planktonic foraminifera form a coiled carbonate shell, composed of several chambers during their life cycle (Appendix 4). The planktonic foraminiferal life ends upon gametogenesis. Most species ascend to shallow waters to reproduce. The adult foraminifera discharges gametes, which become a zygote, that forms a new organism. The juveniles begin their life in the surface water of the ocean and migrate during their life cycles in the water column. After releasing the gametes, the empty foraminiferal test sinks to the ocean floor and becomes part of the pelagic ocean sediment above the carbonate compensation depth.

The fossil assemblages of planktonic foraminifera are important for the reconstruction of paleoenvironmental parameters and so they became a major paleoceanographic proxy. Several questions considering temperature, salinity, stratification and glacial/interglacial reconstruction have been already answered by the use of planktonic foraminiferal tests. Analyses of modern planktonic foraminifera provide a base for better understanding and more accurate reconstructions.

2. The Atlantic Ocean

This study is covering samples taking in several parts of the world second-largest ocean, the Atlantic Ocean (Fig. A). One of our study areas is located in the North Eastern Atlantic above the Porcupine Seabight, southwest off Ireland. This part of the ocean is characterized by the Eastern North Atlantic Water, warmer water carried by the North Atlantic Current, and the poleward flowing Slope Current. The appearance of cold-core eddies were reported near this area. Seasonal variations regarding surface salinity, surface temperature and bottom current velocities occur.

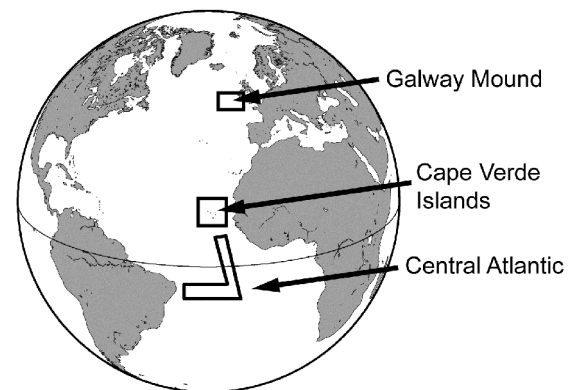

Fig. A. Study areas in the Atlantic Ocean

Another study area is located in the vicinity of the Cape Verde Islands. The water masses near the Cape Verde Islands are mainly influenced by the southwards flowing Canary Current. Physical parameters do not vary strongly during the seasons. Also, in this area large eddies were observed. Around the Islands, where the sampling was carried out, strong currents occur during spring-tide.

The third study area is covering a large part in the central Atlantic. In the west, the study area is influenced by a branch of the South Equatorial Current, in particular the central South Equatorial Current. The central and northern part of the sampling stations are affected by the North Equatorial Countercurrent. The velocity of the westward flowing South Equatorial Current and the North Equatorial Countercurrent vary seasonally. The flow directions of the North Equatorial Countercurrent also varies seasonally. The equatorial tropical Atlantic is known to be exerted by instability waves, Rossby and Kelvin waves are also influencing the ocean to be seasonally variable.

3. Planktonic foraminiferal sampling

The planktonic foraminiferal samples from the Porcupine Seabight were caught by a sediment trap, which was attached to Deep-Sea Observation Lander (Fig. B). The trap was equipped with 13 cups, filled with artificial seawater, which swiveled each 8 days.

Plankton tow samples were carried out a) hand-hauling in the Cape Verde area and b) winch driven on expedition R/V Atalante MARSUED IV. In both cases, the tows have been done with a closeable 100 μm Apstein-net. The hand-hauled plankton tows were carried out with assistance of fishermen, since the weight during hauling is beyond one man's power. In general, the net was deployed slowly to 10 m water depth and lifted gently five times. Before the final hauling, a weight attached to the rope was released, which so closed

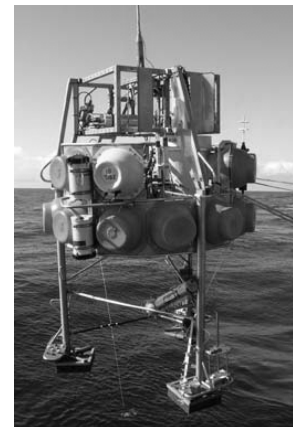

Fig. B. DOS Lander (photograph provided by IFM-GEOMAR)

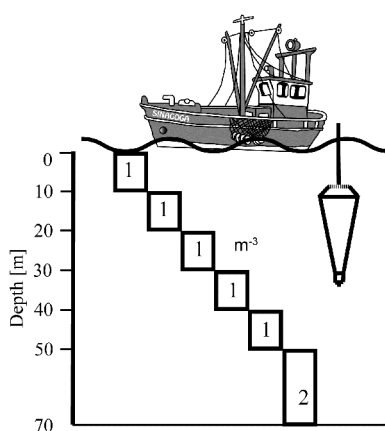

Fig. C. Sketch of plankton tow procedure. In the Cape Verde area tows took place down to 70m, in the central Atlantic down to 50m.

the opening shutter of the net. Onboard, the net was rinsed with seawater from outside, so the planktonic foraminifera sticking to the net were sampled in the trap-container. The content, planktonic foraminifera and other organism from approximately 1 m^3 ocean, were then transferred into simple plastic vials and filled up with ethanol. A general towing procedure is drafted in figure C.

Another kind of sampling planktonic foraminifera from surface water in 5-7 m water depth was done with a ship's intern pump. On MARSUED IV, we connected a hose to the ship's pump and attached a water meter. A smaller finer hose was stucked to a tube equipped with a 63 μm sieve (Fig. D). The first two times, 1 m^3 was sampled, but they contained too less planktonic foraminifera, so the volume

was increased to 3 m³. Each procedure last approximately 2.5-3 hours (Table 2.2). The residues on the sieve was carefully transferred to plastic vials and filled up with ethanol.

More detailed information about the following mechanical and chemical treatments are described in each related chapter.



Fig. D. Pump sampling contrivance with water meter and 63µm sieve built during MARSUED IV in January 2008.

4. Outline

This thesis addresses several questions concerning modern planktonic foraminifera in the Atlantic Ocean. The vertical and lateral distribution of living planktonic as well as the chemical characteristics of dead and living species, population dynamics, deposition flux and seasonal variations were considered. The parameters of adjacent seawater within the productivity zone of planktonic foraminifera in the upper water column, such as temperature, salinity, meteorological and hydrographical effects and food availability may affect the planktonic foraminifera and so their assemblages, dynamics and composition. Also, currents, eddies, dissolution, alteration and burial may affect the transfer of planktonic foraminifera to the ocean floor and their preservation.

Chapter 1 deals with planktonic foraminifera in the Northeast Atlantic. We studied the faunal composition, population dynamics and export flux of sediment trap samples covering a 3-month period. For interpretation we considered several hydrographic impacts. Not only the surface current had to be considered, we also had to attend to bottom currents. In comparison to former studies in this part of the ocean, we found planktonic foraminiferal composition and population densities have changed. Our counting revealed one important discrepancy between living species and subfossil assemblage, the presences of *Globorotalia hirsuta*, a warm water species, which does not occur in the sediment assemblage.

In chapter 2 we discuss the lateral and vertical distribution of sub-tropical and tropical living foraminiferal species. Tow and pump samples of two expeditions in the central and eastern central Atlantic Ocean were analyzed. This biogeographic study revealed fine-scaled information of the living habitats of planktonic foraminiferal species in conjunction with the hydrographic situation in the central Atlantic Ocean. The counting of the pump samples revealed an apparently daily vertical migration of planktonic foraminifera. The fine-scaled observation is a new approach to get information about the vertical migration of planktonic foraminifera. Since a similar expedition was carried out approximately 80 years ago, we were able to find significant changes in foraminiferal assemblage and abundance.

Chemical inventory of planktonic foraminifera are described in **chapter 3**. We carried out laserablation with an inductively coupled plasma mass spectrometer (LA-ICP-MS) to reveal chemical composition within the three youngest chambers of several planktonic foraminiferal

species. Though we can support that non-spinose species incorporate more barium than spinose species, and symbiont-bearing foraminifera show higher boron than symbiont-barren species, trace element analyses of several planktonic foraminiferal species revealed highly variable values within each specimen, species and even chambers. The calculation of the calcification temperature of *G. sacculifer* following Shackleton and Bemis are 2.6°C and 3.1°C higher than the in situ temperature. The difference in *G. menardii* was only 0.5°C following Shackleton. These distinct variations and differences lead to the question how reliable planktonic foraminifera are and how necessary it is to sample all relevant data and to work without estimations.

Chapter 4 is an outlook and describes the reproduction cycle of several planktonic foraminiferal species coupled with lunar cycles and vertical migration. Early evidences show that some planktonic foraminifera reproduce semi-lunar and lunar (i.e. Bijma, 1990; Erez, 1991; Lončarić, 2005; Spindler, 1979). We extend this approach and depict the impact and relevance of this process to the planktonic foraminiferal species as considered in this study. In general, we suggest, that *G. bulloides*, *G. glutinata*, *G. inflata* and *G. sacculifer* reproduce monthly. Population densities emphasize the assumption, that gamete release occurs around full moon.

Short term dynamics of planktonic foraminiferal sedimentation in the Porcupine Seabight

Published as:

Harbers, A., Schönfeld, J., Rüggeberg, A. and O. Pfannkuche, 2010. Short term dynamics of planktonic foraminiferal sedimentation in the Porcupine Seabight . *Micropaleontology* 56, 259-274.

ABSTRACT

Modern planktonic foraminifera collected with a sediment trap, and subfossil assemblages from surface sediments from the Galway Mound in the Porcupine Seabight off southwestern Ireland, (northeastern Atlantic), were studied in order to investigate recent assemblage variations. The sediment trap operated from April to August 2004 with a sampling interval of eight days and covered the spring bloom and early summer. Ten different species were recorded. *Globorotalia hirsuta*, *Turborotalita quinqueloba* and *Globigerinita glutinata* appeared predominately in spring. *Neogloboquadrina incompta*, *Globigerina bulloides* and *Globorotalia inflata* were abundant in spring and summer. Highest foraminiferal tests flux occurred in June. The faunal composition was similar to subfossil assemblages from surface sediments, but the species proportions were different. This contrast was mainly driven by the subtropical species *G. hirsuta*, which was frequent in 2004 but rare in surface sediment samples and in earlier plankton collections obtained from the southern Porcupine Seabight during the 1990s. The individual weight of deposited foraminifera is mainly influenced by the spring bloom, as indicated by sea-surface chlorophyll-a data. The top three-ranked species, *G. hirsuta*, *N. incompta* and *G. bulloides*, contributed 87 % to the foraminiferal carbonate flux at Galway Mound.

1.1. INTRODUCTION

Planktonic foraminifera live in surface to intermediate waters of the open ocean. They are known to respond to the temperature and chemical properties of the ambient seawater (Hemleben et al., 1989, Schiebel and Hemleben, 2005). Therefore, planktonic foraminifera are of high ecologic and paleoceanographic significance. They are used as paleoproxies and their tests are reliable geochemical signal carriers (Berger, 1971; Erez, 1983; Kroon and Ganssen, 1989; Nürnberg et al., 1996; Mulitza et al., 1997). Planktonic foraminifera are major carbonate producers and contribute substantially to the fossil record (Milliman, 1993; Schiebel, 2002). With the changes in surface ocean pH and carbonate chemistry resulting from the present rise of atmospheric CO₂ (Riebesell et al., 2000), a decrease of calcification or weakening of their shells can be anticipated (The Royal Society, 2005). In order to assess whether this process is already taking place and how strong the impact is, monitoring and comparison with historical data is required (Schönfeld and Numberger, 2007; Nikulina et al., 2008).

In this study, we focused on planktonic foraminifera in the northeastern Atlantic (Fig. 1.1). Early studies of planktonic foraminifera in the North Atlantic Ocean were done by Cifelli and Smith (1970), who related planktonic foraminiferal distributions to oceanographic features. A change in distributional patterns east of 50°W was related to the dynamics of circulation. The most abundant

species at the PSB at 200m to 300m water depth was *Globigerina incompta* (Cifelli and Smith, 1970). Later studies in this area by Ottens (1991) revealed that foraminiferal assemblages were related to hydrographical units, and the most frequent species in surface waters were *N. incompta*, *G. bulloides* and *G. inflata*.

More recently, planktonic foraminifera from the northeastern Atlantic off the British Isles have been studied in the framework of projects like OMEX II and BIOTRANS (van Weering et al., 1998). A sediment trap in the OMEX II area in 1993/1994, which was located at Goban Spur close to 49°N and 13°W in 600 m water depth, provided information on faunal assemblages and implications for paleotemperature reconstructions (Chapman, 2007). Dominant species were *N. incompta*, *G. bulloides* and *G. inflata*. Foraminiferal studies at BIOTRANS (47°N, 20°W) focused on foraminiferal production related to hydrography, chlorophyll fluorescence and nutrient content and provided seasonal and interannual data (Schiebel and Hemleben, 2000; Schiebel et al., 2001).

The faunal inventory, size and weight distribution of planktonic foraminifera in subfossil and recent assemblages in the northeastern Atlantic is described in this study in order to gain information on the short-term variation of planktonic foraminifera. These data are compared to former studies in and around the Porcupine Seabight to reveal historical changes in species composition and CaCO₃ flux.

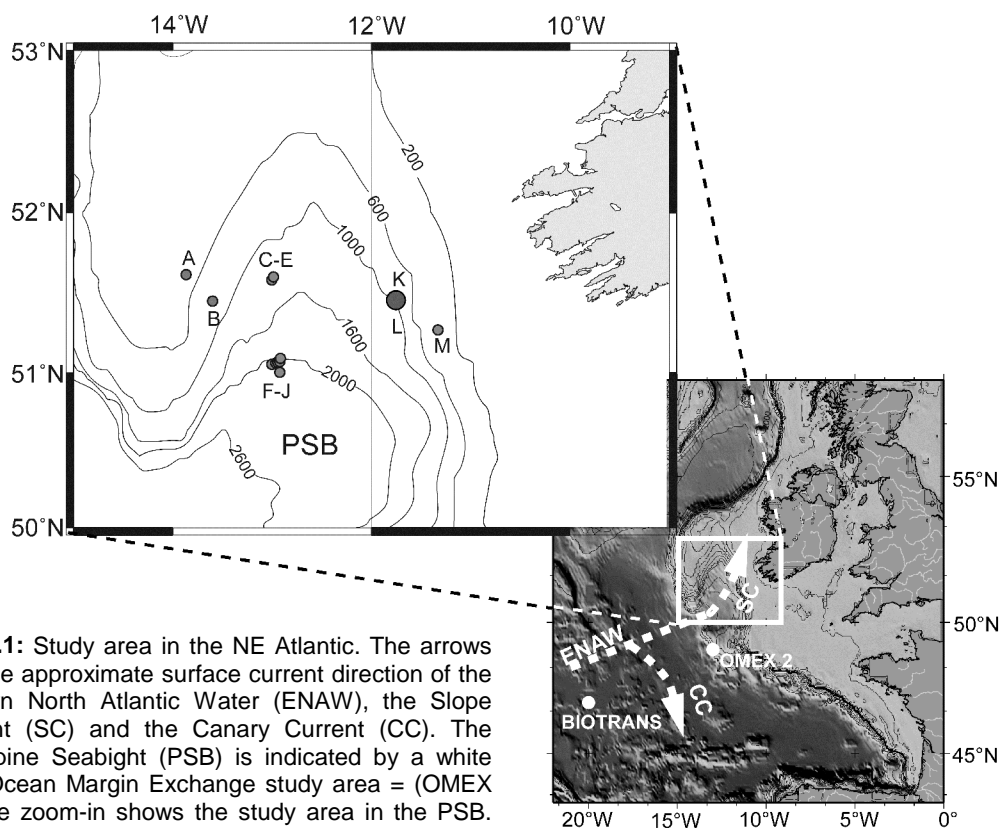

Fig. 1.1: Study area in the NE Atlantic. The arrows indicate approximate surface current direction of the Eastern North Atlantic Water (ENAW), the Slope Current (SC) and the Canary Current (CC). The Porcupine Seabight (PSB) is indicated by a white box; Ocean Margin Exchange study area = (OMEX 2). The zoom-in shows the study area in the PSB. Letters mark several site locations of assemblages, which are listed in Table 1.3. The analyzed sediment trap and core-top samples were taken at stations K and L.

1.1.1. OCEANOGRAPHIC SETTING

The hydrography in the study area is characterized by the Eastern North Atlantic Water (ENAW), the North Atlantic Current (NAC), which is a warm current that continues the Gulf Stream northeastwards, and the Slope Current (SC), which is part of the ENAW and flows poleward. West of Ireland, the NAC splits into two branches, the northern branch enters the Norwegian-Greenland Sea through the Faroe-Shetland Channel, and the southern branch flows into the Bay of Biscay moving south to join the subtropical gyre (Pingree, 1993). Southwest of the study area (48°N, 22°W), cold-core eddies with a diameter of approximately 100 km, have been observed (Beckmann et al., 1987; Mittelstaedt, 1987).

The vertical structure of the water masses at the eastern margin of the Porcupine Seabight shows a temporary warm surface-water layer of 40 to 50 m, which is developed in summer only. Below, decreasing temperature and salinity with a minimum at ~600 m water depth indicates the ENAW. At approximately 700 m water depth, the influence of the underlying Mediterranean Outflow Water (MOW) is recognized by increasing salinity with depth (Rüggeberg and Dodds, 2004) (Fig. 1.2).

Above the Porcupine Bank, the smaller eastern boundary slope current (SC) transports the ENAW and the MOW northwards (Hackett and Roed, 1998; White, 2007). This current is wind and density driven and characterized by salinities greater than 35.5 and surface velocities of 20-35 cm s⁻¹. Bottom currents on the flank of Galway Mound vary between 16-20 cm s⁻¹. Maximum velocities of up to 40 cm s⁻¹ have been measured (P. Linke, pers.comm.).

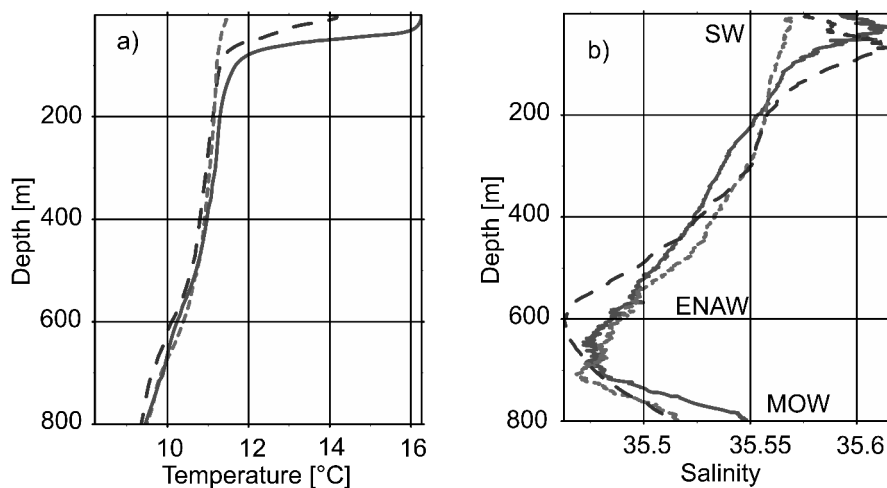

Fig. 1.2: CTD data from Galway Mound (Rüggeberg and Dodds, 2004). The dotted line shows data from April, the dashed line from June, and the solid line from August. a) Temperature. b) Salinity. SW = Surface water; ENAW = Eastern North Atlantic Water; MOW = Mediterranean Outflow Water

1.1.2. GEOGRAPHICAL SETTING

The Porcupine Seabight (PSB) is a tongue-shaped embayment between the Porcupine Bank and the Irish Shelf. It is approximately 65 km wide and 150 km long and hosts three carbonate mound provinces, the Hovland Mound Province, the Magellan Mound Province and the Belgica Mound Province. The Galway Mound is situated within the Belgica Mound Province (BMP) and represents one of the largest mounds within the BMP (Fig. 1.3). The Galway Mound arises from 920 m to 780 m water depth and is characterized by living coral framework, which covers the flat top and the western flank. It is surrounded by a fringe of dead coral framework and rubble. The

ambient off mound area is characterized by coarse-grained sediments, which shows sand waves and coral patches (Noé et al., 2004; Dorschel et al., 2007). Recent sediment deposition is observed on the flanks and on the top of the Galway Mound, but not at the northern foot of the Mound.

1.2. MATERIALS & METHODS

1.2.1. SEDIMENT TRAP

The sediment trap was mounted on a long-term deep-sea observatory (DOS, GEOMAR Modular Lander). The video-controlled lander was deployed in a coral thicket on the north-western flank of Galway Mound (51°27.28N, 11°43.23W, 806 m water depth), during R/V METEOR cruise M61/1 on 25 April 2004, and it was recovered on 10 August 2004 during R/V Poseidon cruise PO316. The DOS lander was equipped with a CTD, current meters, turbidity and fluorescence sensors in order to continuously monitor particle flux and environmental data from the spring bloom through summer (Linke et al., 2006).

The funnel shaped “Kiel Sediment Trap” designed by K.U.M., Kiel, had a sampling area of 0,238 m². The upper opening was located 2.75 m above the seabed. The trap was equipped with 13 cups, sampling for 8 days each. The cups were filled with artificial sea water with a salinity twice as high as in the near-bottom water. HgCl₂ was added to prevent biotic activity in the sampling cups, in particular to inhibit bacterial growth and the decay of labile organic substances. The samples were stored under cool conditions, split, and analyzed first for their organic chemical inventory. This consumed the whole sample TF3, and the remaining aliquots of the other twelve samples were sufficient to be analyzed for planktonic foraminifera.

The trap samples were rinsed three times with fresh water to desalinate. We first used ammonia buffered distilled water with a pH of 8.2, to prevent corrosion of foraminiferal shells. This buffered water and the sample formed a white Hg(NH₂)Cl precipitate, which is insoluble in cold water. We therefore changed to carbonate-saturated water for desalination, and washed the samples afterwards carefully through a 63-µm mesh. The residues were dried on filter paper at 50°C. The dried samples were fractionated with 630 µm, 500 µm, 400 µm, 315 µm, 250 µm, 150 µm and 125 µm sieves. These size fractions were chosen in order to optimize chemical analyses of the samples. The different size fractions were picked for planktonic foraminifera. The foraminifera

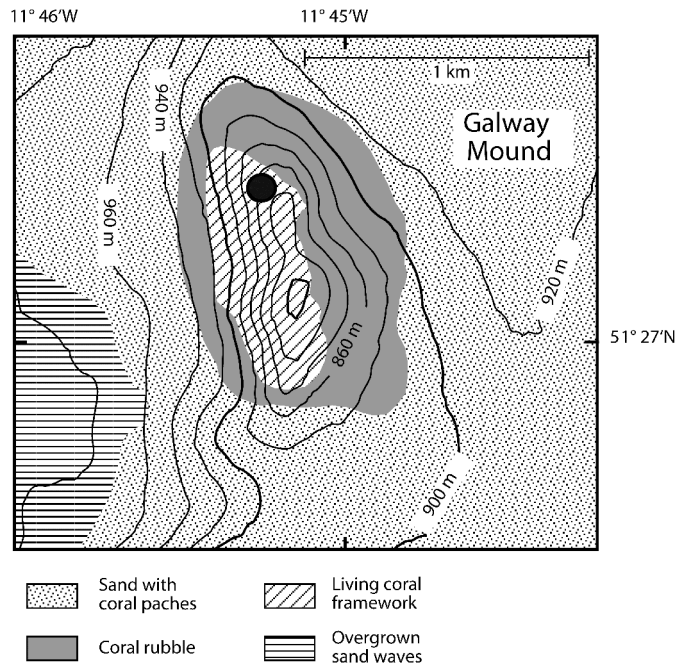

Fig. 1.3: Detailed morphology and facies distribution of Galway Mound after Dorschel et al., 2007 and own observations. The black dot indicates the location where the sediment trap was situated.

were sorted by species, counted, and weighed with a Satorius ME 5-OCE precision balance at the Institute for Geosciences, Kiel University. In addition, the maximum diameter of all specimens was measured with an eyepiece reticle. Only a few individuals show differences between measured and sieved diameter. Such specimens could pass the mesh because their minimum dimension fit the diagonal of the mesh openings. All data are deposited at the Pangaea Data Base (<http://doi.pangaea.de/10.1594/PANGAEA.710798>).

1.2.2. CORE-TOP SAMPLES

The planktonic foraminiferal fauna from the sediment trap was compared with a subfossil assemblage that provides a year-round integration of several decades to centuries. The sediment surface sample closest to the sediment trap was obtained with a Giant Box Corer (GKG) during Meteor cruise M61/3 in June 2004 at station M61/3-552 (51°27.04N, 11°45.12W) on top of

Table 1.1. Trap samples, their aliquots, test and CaCO₃ flux rates. Some fractions were split with an Otto-microsplitter to create a smaller subsample. Tests larger than 63 µm have been counted.

Starting date	Sample	Aliquots	Total tests	CaCO ₃ [mg] total	Test flux [# m ⁻² d ⁻¹]	CaCO ₃ [mg m ⁻² d ⁻¹]
26.04.2004	TF 1	1/8	0	0	0	0
03.05.2004	TF 2	1/4	133	1.201	279	2.527
11.05.2004	TF 3	-	-	-	-	-
19.05.2004	TF 4	1/4	0	0	0	0
27.05.2004	TF 5	1/4	108	1.692	294	3.561
04.06.2004	TF 6	1/4	168	0.615	1077	1.481
12.06.2004	TF 7	1/4	103	1.259	216	2.645
20.06.2004	TF 8	1/4	70	0.385	191	0.813
28.06.2004	TF 9	1/4	50	0.261	155	0.550
06.07.2004	TF 10	1/4	201	0.402	2186	0.908
14.07.2004	TF 11	1/4	64	0.182	403	0.395
22.07.2004	TF 12	1/4	85	0.643	557	1.348
30.07.2004	TF 13	1/4	174	0.575	712	1.208
total			1156	4.152		
mean					506	1.064

Galway Mound, approximately 400 m to the south of the DOS station M61/1-245. The actual sediment surface was well preserved in voids between living and dead corals. During recovery, overlying water was present and was later removed carefully with a narrow hose. A surface sample of 10 cm³ was taken

from the 0-1.5 cm interval with a cut-off syringe. The surface sample was freeze-dried, weighed, soaked with water, and washed through a 63 µm screen. The residue was weighed and fractionated into the same size fractions as the sediment trap samples. The fractions were picked for planktonic foraminifera. The foraminifera were sorted by species, counted, and weighed with a precision balance.

In order to calculate flux rates of foraminiferal tests, and to assess whether the surface sample represents a subrecent faunal assemblage, their age was determined by AMS ¹⁴C dating. Eight hundred specimens of *Globigerina bulloides* from the 250-315 µm fraction were used for analysis of radiocarbon age via accelerator mass spectrometry (AMS) at the Leibniz-Laboratory, Kiel University. The precision was ±30 years (1σ). The ¹⁴C age was calibrated to calendar years by using the web-based CalPal program (www.calpal-online.de/cgi-bin/quickcal.pl) and an ocean age reservoir correction of 408 years. The dating was supported by ¹⁴C dating of coral fragments from

core GeoB9214 from Galway Mound (Eisele et al. 2008). Accumulation rates of surface sediments were calculated with a dry density of 1.12 g cm^{-3} and compared to the flux rates obtained from the sediment trap.

1.2.3. TAXONOMY

The planktonic foraminiferal species were determined after Hemleben et al. (1989), Bé (1977) and Saito et al. (1981). Following to Darling et al. (2006), we use the name *Neogloboquadrina incompta* instead of *Neogloboquadrina pachyderma* dextral. To keep our taxonomic concept consistent with ongoing studies in the northeastern Atlantic, the species were discussed with M. Chapman (University of East Anglia), E. Kandiano and K. Brown (IFM-GEOMAR). Images of representative specimens of the most frequent species were made with a CAM SCAN CS 44 at the Department of Micropalaeontology at the University of Kiel (Plate 1). Samples were prepared with sputter devices Edwards Auto 306 (C+Au) and Emitech K550 (Au).

1.2.4. HYDROGRAPHY AND ASSEMBLAGE DATA

Several CTD measurements were performed during Meteor cruises M61/1, M61/3 and Poseidon cruise PO316 around Galway Mound. These hydrocasts were complemented by continuous sea surface temperature (SST) and weekly median chlorophyll data from satellite images in 2004, Advanced Very High Resolution Radiometer (AVHRR) and Sea-viewing Wide Field-of-view Sensor (SeaWiFS) from NERC Earth Observation Data Acquisition and Analysis Service (NEODAAS). The sedimentation of phytoplankton, as indicated by chlorophyll a concentrations in phytodetritus retrieved with a fluorometer AFLT-030, was obtained from Linke et al. (2006). The overall planktonic foraminiferal assemblage composition in surface sediments in the vicinity of our sediment trap (Fig. 1.1) was retrieved from the GLAMAP 2000 data base (Pflaumann 2002).

1.3. RESULTS

1.3.1. HYDROGRAPHY

The CTD data show surface water temperatures in the sampling months ranging from 11.4°C to 16.3°C (Fig. 1.2a). The surface waters were well mixed in April down to 100 m depth. In June and August, the surface waters were stratified with a pronounced thermocline at 50 m depth. The salinity of the surface water during the sampling month varied from 35.57 to 35.60 (Fig. 1.2b). SST data from CTD measurements and SST data from satellite images are in good agreement. A slight decrease of salinity down to 700 m water depth indicates the influence of Eastern North Atlantic Water (ENAW), below which the Mediterranean Outflow Water (MOW) is characterized by increasing salinity below 700m.

1.3.2. DEPOSITIONAL FLUX

Up to $2100 \text{ tests m}^{-2} \text{ day}^{-1}$ were detected during spring and summer 2004 (Fig. 1.4). In April and May, two samples did not contain any foraminiferal tests (TF1 and TF4). The highest shell sedimentation rate was recorded in early June (TF6), early July (TF10) and early August (TF13). An

opposite trend of shell weight and the numbers of deposited shells was recorded during the sampling interval. The shell weight was high in early summer, but decreased as the summer progressed. The highest foraminiferal shell carbonate deposition was recorded in late May and mid June with up to $3.5 \text{ mg m}^{-2} \text{ day}^{-1}$ (Fig. 1.4d). These trends were not observed in the other recorded

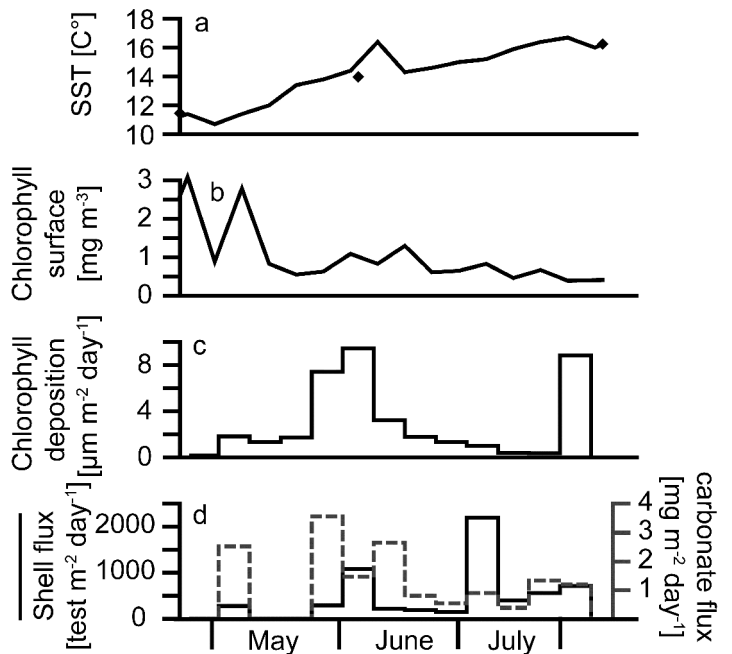

Fig. 1.4: a) Remote Sensing SST of surface water; b) Remote sensing chlorophyll in surface water; c) chlorophyll deposition flux in the sediment trap and d) foraminiferal deposition flux. The black diamonds mark CTD data from R/V *Meteor* cruise 61 and R/V *Poseidon* cruise 316 in summer 2004. The grey dashed line shows the shell weight of deposited foraminiferal tests.

parameters. The SST increased continuously from April to August from about 12°C up to 16°C with a small intermittent maximum in June (Fig. 1.4a). Satellite surface chlorophyll data showed two strong maxima in April and May (Fig. 1.4b). We considered these peaks as part of the spring bloom. Two smaller maxima appear in late May and early June. The deposited chlorophyll shows neither an obvious similarity nor a lagged correspondence with the surface ocean chlorophyll concentrations (Fig. 1.4c). The only similarity is with the shell weight maxima at the end of May and mid June. These probably reflected the surface chlorophyll concentration with an offset of approximately four weeks.

1.3.3. FORAMINIFERAL ASSEMBLAGES

1.3.3.1. Sediment trap

Ten planktonic foraminiferal species were identified in the samples (Appendix 1, Appendix 4). The sediment trap assemblage consists of *Globigerina bulloides*, *Globigerinita glutinata*, *Globorotalia hirsuta*, *Globorotalia inflata*, *Globorotalia scitula*, *Turborotalita quinqueloba*, *Globigerinella siphonifera*, *Neogloboquadrina incompta* and *Neogloboquadrina pachyderma* sinistral. In the core-top sample, *Orbulina universa* was found in addition. More than 70 % of the planktonic foraminifera collected in the sediment trap fall into the $63 \mu\text{m}$ to $125 \mu\text{m}$ size fraction. With a few exceptions, it was not possible to determine them at species level (Fig. 1.5a). In the size fractions $>125 \mu\text{m}$, the most frequent species were *N. incompta* (10.7 %), *G. glutinata* (4.2 %), *G. hirsuta* (3.22 %), *G. bulloides* and *T. quinqueloba* (each $\sim 3\%$). *Globorotalia inflata* ($\sim 1\%$) and *G. siphonifera* (0.5 %) were rare and *G. scitula* and *N. pachyderma* sinistral occurred only as single individuals.

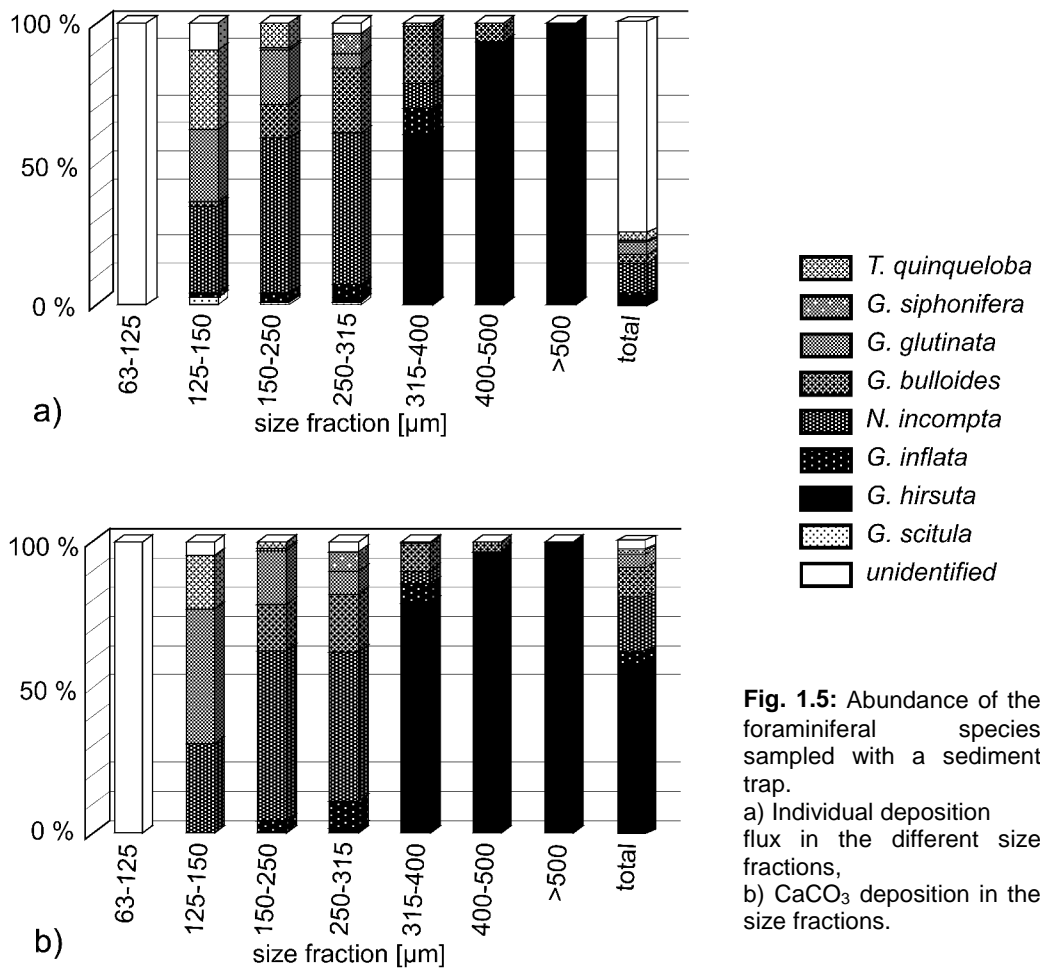

Fig. 1.5: Abundance of the foraminiferal species sampled with a sediment trap.
a) Individual deposition flux in the different size fractions,
b) CaCO₃ deposition in the size fractions.

The total planktonic foraminiferal CaCO₃ weight was mainly contributed by *G. hirsuta* (57.5 %), *N. incompta* (18.5 %) and *G. bulloides* (10 %). In May, June, July and early August these species contributed more than 86 % of total foraminiferal CaCO₃ flux (Fig. 1.5b). The rest of the planktonic foraminiferal CaCO₃ was represented by *G. inflata* (4.7 %), *G. glutinata* (4.4 %), unidentified species (3 %) and *G. siphonifera* (1.3 %), while *T. quinqueloba* and *G. scitula* contributed only 0.6 %.

Almost 4800 individuals from the size fraction 63-125 μm contributed less than 3 % to the foraminiferal CaCO₃ deposition (Fig. 1.6a+b). In contrast, the individuals from the 315-500 μm size fraction, particularly *G. hirsuta*, dominated the total foraminiferal CaCO₃ flux with more than 66 %, (Fig. 1.5b). The size fraction 125-150 μm was dominated by *N. incompta* (31 %), *T. quinqueloba* (28 %) and *G. glutinata* (26 %). *Neogloboquadrina incompta* was, with 55 % of the individuals, even more frequent in the size fraction 150-250 μm, while *G. glutinata* was, with 19 %, less frequent than in the smaller size fraction. The size fraction >250 μm mainly consisted of *N. incompta* (55 %) and *G. bulloides* (23 %).

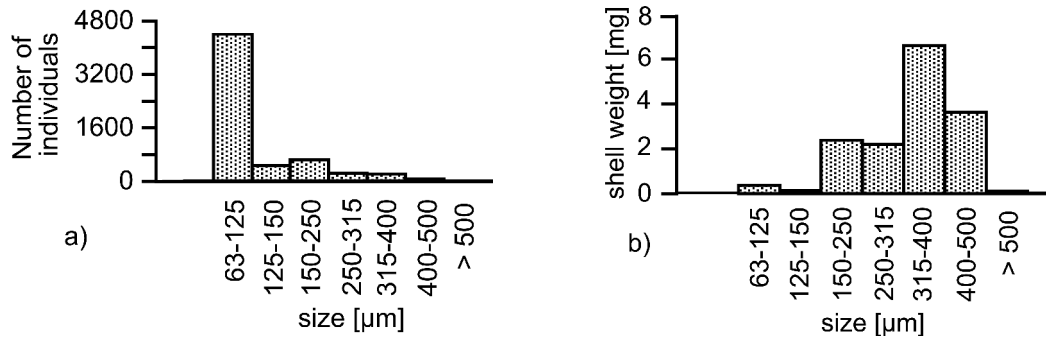

Fig. 1.6: Size distribution of sediment trap sample. a) total abundance of individuals and b) total shell weight.

Average test size could be calculated by taking the mean of all measured tests. For instance, *N. incompta* had an average shell size of $282 \pm 62 \mu\text{m}$, and showed highest fluxes in the size fraction 150-250 μm with $36 \text{ individuals m}^{-2} \text{ day}^{-1}$. *Globigerina bulloides* had an average size of $330 \pm 52 \mu\text{m}$ and was most frequent in the size fraction 150-250 μm with eight individuals $\text{m}^{-2} \text{ day}^{-1}$. *Turborotalita quinqueloba* had highest frequencies in the size fraction 125-150 μm with 13 individuals $\text{m}^{-2} \text{ day}^{-1}$. Its average shell size was $209 \pm 21 \mu\text{m}$. Only the rather globular *G. glutinata*, with a flux rate of $12 \text{ individuals m}^{-2} \text{ day}^{-1}$, displayed an average shell size of $240 \pm 39 \mu\text{m}$ that was within the limits of the 150-250 μm size fraction in which it was most abundant.

1.3.3.2. Core-top assemblage

The core assemblage also showed a high proportion (32 %) of small, indeterminable specimens in the size fraction 63-125 μm . In larger size fractions, the most frequent species were *N. incompta* (32 %), *G. inflata* (12.2 %), *G. bulloides* (11.7 %) and *G. glutinata* (6.5 %). Other species were *T. quinqueloba* (3.2 %), *G. siphonifera* (1.6 %), *O. universa* (0.5 %) and *G. hirsuta* (0.03 %), while *G. scitula* was missing.

The CaCO_3 flux was dominated by *N. incompta* (43.8 %), *G. inflata* (37.5 %), *G. bulloides* (12.6 %) and *O. universa* (~3 %), with the remainder contributed by unidentified species (1.7 %), *G. glutinata* (1.2 %) and *G. hirsuta* (0.25 %). The few specimen of *T. quinqueloba* and *G. siphonifera* were too light to be weighed. The three most common species, *N. incompta*, *G. inflata* and *G. bulloides*, therefore contributed more than 93 % of approximately 44 mg foraminiferal CaCO_3 deposited $\text{m}^{-2} \text{ day}^{-1}$ at the ocean floor. Nearly 30 % of the unidentified individuals within the fraction 63-125 μm contributed only 1.7 % to the total foraminiferal CaCO_3 flux.

The heaviest species appeared in the size fractions 150-400 μm (Fig. 1.6b). Among them, *N. incompta* was most frequent in the size fractions 150-250 μm and 250-315 μm . *Globigerina bulloides* and *G. inflata* were mainly found in the size fractions 250-315 μm and 315-400 μm .

1.3.3.3. Shell and carbonate flux

Comparisons between sediment trap and core-top samples revealed big differences in shell flux (Fig. 1.7a) and CaCO_3 flux (Fig. 1.7b). In general, shell flux was much higher in the core-top sediment than in the sediment trap, with marked differences between the individual size fractions. The sediment trap collected only 400 tests $\text{m}^{-2} \text{ day}^{-1}$ in the 63-125 μm size fraction, while more than 2980 tests $\text{m}^{-2} \text{ day}^{-1}$ accumulated in the core-top sediment. The 125-150 μm size fraction revealed

a 19-times higher shell flux in the sediment sample than the trap sample. Remarkable differences in shell flux were also recorded in the 150-250 μm size fraction, where the sediment sample showed a 53-times higher shell flux, and in the 250-315 μm size fraction, where the shell flux was higher by a factor of 76. In these size fractions, *N. incompta* was the most abundant species, in both sediment trap and core-top sample. Shell flux was 30 times higher in the sediment in the 315-400 μm size

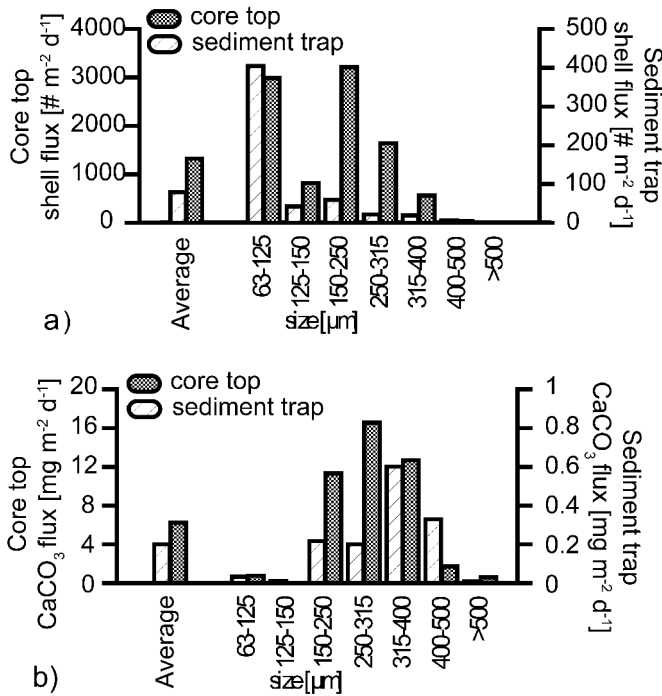

Fig. 1.7: Comparison of a) shell flux $\text{m}^{-2} \text{ day}^{-1}$ and b) CaCO_3 flux $\text{m}^{-2} \text{ day}^{-1}$ in different size fractions between sediment trap and core top sample.

were 82 (250-315 μm), 21 (315-400 μm), 5 (400-500 μm) and 64 (>500 μm) times higher. On average, the near surface sediments under the coral thicket on Galway Mound accumulated about 30 times more planktonic foraminiferal tests, and 40 times more CaCO_3 , than the pelagic rain collected by the sediment trap 2.8m above the sea bed.

Table 1.2. Sedimentation rates of sediment trap and core top assemblage. Flux of CaCO_3 and tests in several size fractions are shown.

Size fraction μm	Core top [$\# \text{ m}^{-2} \text{ d}^{-1}$]	Sediment trap [$\# \text{ m}^{-2} \text{ d}^{-1}$]	Factor	Core top [$\text{mg m}^{-2} \text{ d}^{-1}$]	Sediment trap [$\text{mg m}^{-2} \text{ d}^{-1}$]	Factor
63-125	2985	404	7	0.75	0.03	22
125-150	821	42	20	0.00	0.01	—
150-250	3209	59	54	11.34	0.22	52
250-315	1642	22	76	16.57	0.20	83
315-400	560	19	30	12.69	0.60	21
400-500	32	6	5	1.73	0.33	5
> 500	8	0	40	0.62	0.01	64
Average	1322	79	17	6.24	0.20	31

1.3.4. SPECIES DYNAMICS

Four characteristic maxima were recognized in the test flux of planktonic foraminifera. The five top-ranked species showed the first accumulation maximum in early May (Fig. 1.8).

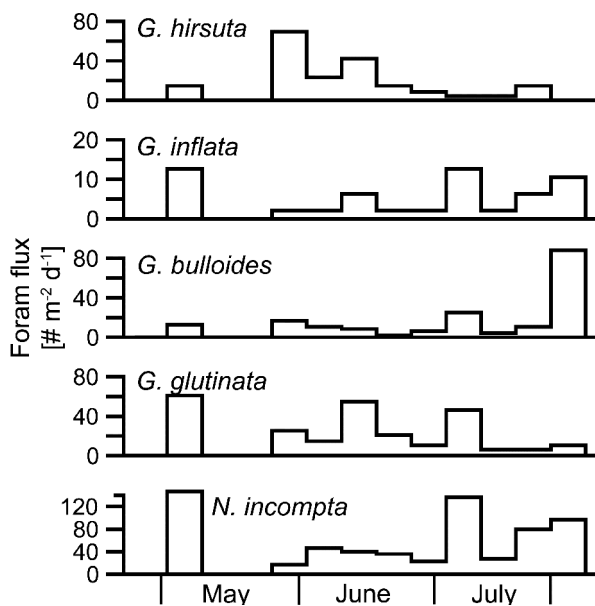

Fig. 1.8: Number of individuals larger than 125 µm of five major species of the foraminiferal assemblage from the sediment trap. Note different scales.

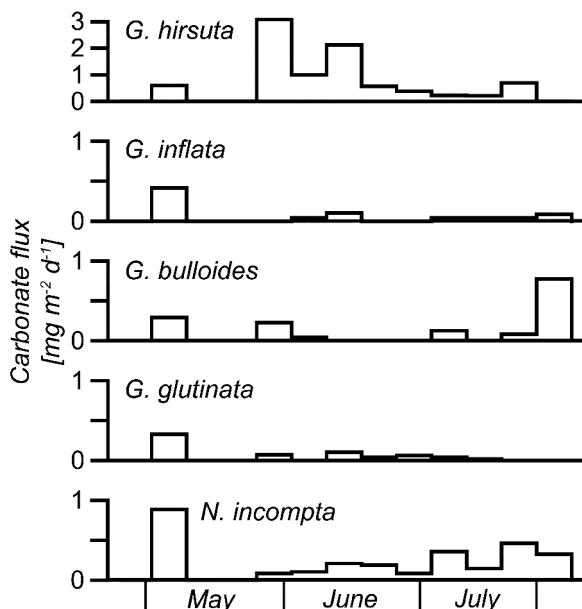

Fig. 1.9: Carbonate flux of five major species in the > 125 µm fraction of the foraminiferal assemblage of the sediment trap. Note the different scales.

Globorotalia hirsuta and *G. glutinata* showed two successive maxima in late May and mid June. A fourth peak in the accumulation rate of *G. inflata*, *G. glutinata* and *N. incompta* occurred in early July.

The dominant species, *N. incompta*, showed its highest abundance in early May and early July. In contrast, *G. bulloides* was present in low numbers in spring and became more abundant by the beginning of August. The deep-dwelling species *G. hirsuta* appeared in only 7 of 11 samples, and it was frequent from the end of May until the end of June. It showed two stronger maxima at the end of May and in mid June.

Globorotalia inflata was relatively abundant in early May, reappeared in low numbers at the end of May and became more frequent as the summer progressed. Strong variations were observed in the abundance of *G. glutinata*. This species showed four peaks of abundance in early May, end of May, mid June and early July.

The shell weight of *G. hirsuta* exhibited two characteristic maxima at the end of May and mid of June (Fig. 1.9). During the rest of the sampling period, it did not show strong variations. The shell weight of *G. glutinata* and *G. inflata* decreased substantially after first maximum in early May. *Globigerina bulloides* showed four weak maxima, in early May, the end of May, and two more in early July and early August, the final one being higher than the earlier

maxima. Regarding the CaCO_3 flux, one test of *N. incompta* weighed nearly 0.006 mg in early May while in early July one test of *N. incompta* weighed only one third of the weight of the specimen in May. During the sampling period, *Neogloboquadrina incompta* had a maximum test weight in early May, a very low weight at the end of May, followed by a slight increase during the summer.

1.3.5. CORE-TOP ANALYSES

We compared foraminiferal assemblages from core-tops recovered during the past decades in the area around the Porcupine Seabight (Table 1.3, Fig. 1.10), even though the sediment trap covered only a 3-month period and the core-top samples contained an assemblage averaged over several decades to centuries. The surface sample M61/3-552 was dated to 780 ± 30 calendar years before present, and the local sedimentation rate of 24.4 cm kyr^{-1} (core GeoB 9214, Eisele et al., 2008) suggested that it had taken about 40 years for a sediment layer of the sample thickness to have accumulated. For the faunal comparison, we considered only major species that were also identified in the $>150 \mu\text{m}$ fraction of the sediment trap samples.

The faunal assemblages from the core-tops used for comparison were taken from the $>150 \mu\text{m}$ size fraction (Pflaumann, 2002). The comparison revealed no significant differences in abundance in *N. incompta* and *G. bulloides*. *Globigerinella siphonifera* did not show a significant regional variability in the core-top assemblages. *Globorotalia inflata*, *G. glutinata* and *T. quinqueloba* displayed a low variability among the core-tops, and *G. glutinata* and *T. quinqueloba* were less frequent in the 2004 sediment trap than in the core-top samples. The subsurface-dwelling species *G. scitula* was rare (800 m) or missing (200 m) in the assemblages from core-tops taken from the upper slope off Ireland. The only exception from this generally good agreement between the sediment trap and core-top assemblages was the large difference in abundance of the subsurface-dwelling subtropical species *G. hirsuta*. This species occurred only as single individuals in 6 out of 13 core-top samples, but was recorded with a very high abundance in the sediment trap sample.

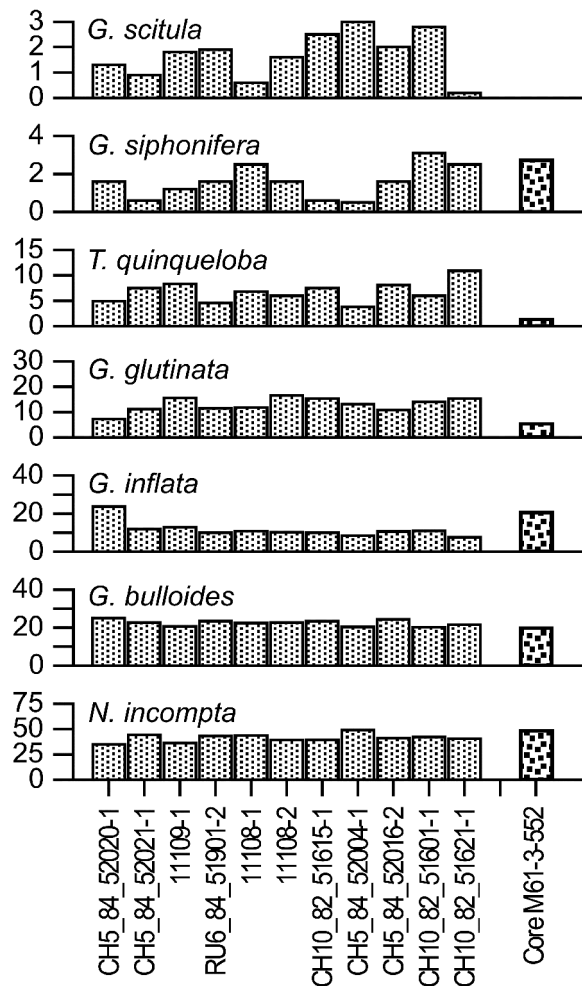

Fig. 1.10: Faunal composition (% abundance) of core tops around the Porcupine Seabight arranged in a West-East direction. Bars with crosshatch indicate the 2004 core-top.

Table 1.3. List of core top samples from the past decades and one 3 month time-series sediment trap sample from 2004. Locations are plotted in figure 1.3. Data obtained from GLAMAP2000 (Pflaumann 2002).

Station	Latitude	Longitude	Sampling year	Water depth [m]	Location in study area
CH5_84_52020-1	51°36.942N	13°51.942W	1984	-493	A
CH5_84_52021-1	51°26.970N	13°36.078W	1984	-743	B
11109-1	51°24.902N	13°0.300W	n/a	-1350	C
RU6_84_51901-2	51°3.000N	13°0.102W	1984	-2000	D
CH10_82_51615-1	51°36.000N	12°59.298W	1982	-1345	E
11108-1	51°3.498N	12°57.900W	n/a	-2000	F
11108-2	51°3.702N	12°56.700W	n/a	-2101	G
CH5_84_52004-1	51°04.008N	12°55.398W	1984	-1988	H
CH5_84_52016-2	51°37.752N	12°55.368W	1984	-1389	I
CH10_82_51601-1	51°05.202N	12°54.900W	1982	-1998	J
Core M61-3-552	51°27.280N	11°45.230W	2004	-810	K
Trap M61-1-245	51°27.040N	11°45.120W	2004	-806	L
CH10_82_51621-1	51°16.002N	11°19.878W	1982	-220	M

1.4. DISCUSSION

The temporal and spatial distribution of planktonic foraminifera is influenced by several factors. Some of these factors, for example preferred living habitats and seasonal successions, are well constrained (Schiebel et al. 2001). Dissolution and overgrowth with secondary calcite has been reported to affect the sinking rates of shells in the water column and to bias the faunal assemblages in the core-top sediment (e.g., Berger, 1971). In the eastern North Atlantic, however, the Calcite Compensation Depth is below 4500m, and dissolution should be negligible. Short-term variations in hydrographic settings are not predictable and may strongly influence the faunal assemblages and the sedimentation of shells they have produced.

1.4.1. SPATIAL DISTRIBUTION

During the sampling period, the northeastern Atlantic Ocean showed quite stable hydrographic conditions in the area of Galway Mound (57°N, 11°W). The upper 100 m show seasonal stratification between April and June 2004. Two characteristic water masses have been identified. The upper 700 m of the water column, corresponds to the Eastern North Atlantic Water/Slope Current, and the waters below show a Mediterranean Outflow Water signature (Rüggeberg and Dodds, 2004). The deep winter mixing that occurs in the study area causes nutrient-rich waters, which can result in large blooms.

The main food of planktonic foraminifera is phytoplankton (e.g., diatoms) and zooplankton (e.g., copepods) (Anderson et al. 1979). Some planktonic foraminifera harbour symbionts, which depend on light (Hemleben et al., 1989; Ortiz et al., 1995). Because planktonic foraminifera are linked to their food source and in some cases to their symbionts, most planktonic foraminifera live in the upper 100 m of the ocean. Sometimes, shallow-living foraminifera are forced to live at greater depths, for instance, when the mixed layer is extended downwards by wind-driven mixing in the northeast Atlantic (Schiebel et al., 1995). Deep-dwellers like *G. hirsuta* and *G. scitula* normally live below the mixed layer (Schiebel and Hemleben, 2000). Regarding the sinking velocity of planktonic

foraminifera, we have to distinguish between larger and smaller specimens and light and heavy individuals, as well as between spinose and non-spinose species. We also have to consider other points, e.g. morphology of their crust and scavenging. Laboratory experiments have revealed sinking velocities of 320 m day^{-1} for individuals $<150 \mu\text{m}$ and up to 1270 m day^{-1} for heavier and larger individuals (Takashi and Bé, 1984). Average sinking velocities of planktonic foraminiferal tests have been calculated by Schiebel and Hemleben (2000), (Table 1.4).

If we apply these data and an inferred size-related sinking velocity relationship to our tests $<125 \mu\text{m}$, and perform an estimation for the larger specimens, we obtain a travel time of 14-190

Table 1.4. Average sinking velocities of planktonic foraminiferal tests obtained from Schiebel and Hemleben, 2000. Travel time of foraminiferal test from the sediment trap in different size fractions.

Sieve size [μm]	Sinking velocity [m d^{-1}]	Travel time [h]
100-125	102	190
125-150	150	129
150-200	227	85
200-250	358	54
250-315	493	39
315-400	685	28
400-500	953	20
>500	1339	14

hours for the analyzed sediment trap and surface sediment samples. Since a straight vertical flux cannot be assumed (Siegel and Deuser, 1997), and from 40 m to 4 m above the bottom internal waves and stronger bottom currents prevail, which keep particles in suspension (P.Linke, pers. comm.; Mienis et al., 2009), the travel time to final sedimentation could last longer.

Above the Porcupine Seabight, the northward flowing ENAW/SC has an average speed of $15\text{-}30 \text{ cm s}^{-1}$ (New and Smythe, 2001). Most of the planktonic foraminifera caught in the sediment trap in the PSB lived in the upper 100 m of the water column and the catchment area therefore would be roughly 5-65 km to the south. Although, Satellite SST and Chlorophyll images showed some spatial variability, no persistent oceanic fronts, eddies, or different surface water masses were observed to the south of the site investigated

during the sampling period. As such, the hydrographic measurements above Galway Mound are considered to be representative of the physical environment in which the planktonic foraminifera lived and produced the shells, that were collected in the sediment trap.

1.4.2. FORAMINIFERAL FLUX

In the open ocean, the global carbonate flux is about 5.7 Gt yr^{-1} . Planktonic foraminifera make a large contribution with an estimated carbonate flux ranging from 1.3 Gt yr^{-1} to 3.2 Gt yr^{-1} (Schiebel 2002). Within a 3 month sampling period, we recorded a total planktonic foraminiferal carbonate flux of approximately $1.4 \text{ mg m}^{-2} \text{ day}^{-1}$ at 800 m water depth. Geographical and species-specific patterns make it difficult to relate the observed local deposition flux to a global budget. There are, however, regional data available for comparison. In the BIOTRANS area, the highest rates were $350\text{-}495 \text{ mg m}^{-2} \text{ day}^{-1}$ at 100 m depth, but only for individuals $>125 \mu\text{m}$ (Schiebel and Hemleben, 2000). Other studies at BIOTRANS give rates of $65\text{-}164 \text{ mg m}^{-2} \text{ day}^{-1}$ ($24 - 60 \text{ g m}^{-2} \text{ yr}^{-1}$) for the size fraction $>20 \mu\text{m}$ at water depths from 1000 to 3500 m (Schiebel, 2002), $30 \text{ mg m}^{-2} \text{ day}^{-1}$ ($11 \text{ g m}^{-2} \text{ yr}^{-1}$) at 1000 m depth (Honjo and Manganini, 1993) and $41 \text{ mg m}^{-2} \text{ day}^{-1}$ ($15 \text{ g m}^{-2} \text{ yr}^{-1}$) at 2000 m. In the central northern Atlantic, an annual carbonate flux of $24.9 \text{ mg m}^{-2} \text{ day}^{-1}$ ($9.1 \text{ g m}^{-2} \text{ yr}^{-1}$) at 32°N , 64°W (3200 m depth) was reported (Deuser, 1986). Neglecting the small, very

light, and very frequent individuals, and the fact that the populations of some species may increase during the rest of the year, we estimate a minimum annual carbonate flux of $0.5 \text{ g m}^{-2} \text{ yr}^{-1}$ at 800m depth. Thus, compared to the planktonic foraminiferal carbonate flux at 100 m depth in the BIOTRANS area, the CaCO_3 flux at Galway Mound is 20 times lower.

We found a very strong relation between chlorophyll-a and the weight of *G. glutinata*, *G. hirsuta* and also of *N. incompta*. While the main food of *G. glutinata* is diatoms, *N. incompta* favors diatoms and eukaryotic algae. *Globorotalia hirsuta* prefers diatoms as well as dinoflagellates, eukaryotic and thecate algae and muscle tissue (Hemleben et al. 1989). Thus, it appears reasonable to assume that the availability of food for planktonic foraminifera was far higher in the BIOTRANS area in 1986 than in the Porcupine Seabight in 2004, even though the spring bloom was only partly sampled there. The primary production in the BIOTRANS area was between $0.65 \text{ g C m}^{-2} \text{ day}^{-1}$ and $0.80 \text{ g C m}^{-2} \text{ day}^{-1}$ in April to September 1978 and 1986. The primary production in the Porcupine Seabight was similar in April, May and June but showed lower values in the summer months of July, August and September ($0.55\text{-}0.65 \text{ g C m}^{-2} \text{ day}^{-1}$), (Antoine et al., 1996). However, these differences would not account for a 20 times higher carbonate flux. Another explanation could be a change in oceans alkalinity. The TTO program (Transient Tracers in the Ocean) between 1980 and 1986 and the OACES cruises (Ocean Atmosphere Carbon Exchange Study) in 1991 and 1993 collected alkalinity in the northeastern Atlantic Ocean. Alkalinity did not change significantly in this area (Millero et al., 1998). Therefore ocean acidification appears to be a less likely cause for different carbonate flux in the Porcupine Seabight and the BIOTRANS area.

A reasonable explanation for the higher carbonate flux in the BIOTRANS area could be the difference in the foraminiferal species composition. Some large and thus heavier species, like *G. hirsuta*, *G. inflata* and *Globorotalia truncatulinoides*, were found in the BIOTRANS area. These species were rare or missing in the Porcupine Seabight.

1.4.2.1. Faunal composition

The planktonic foraminiferal assemblages in the northeastern Atlantic experienced some variability during the past 40 years. The earliest data are those of Cifelli and Smith (1970) who reported planktonic foraminiferal distribution pattern from cruise 13 of R/V Atlantis II in September 1964. Despite a different sampling depth (254 m), water masses and season, similar relative abundances of *N. incompta* (53 %) were recorded at three nearby stations ($41^{\circ}33\text{N}$; $29^{\circ}43\text{W}$ and $41^{\circ}04\text{N}$; $29^{\circ}12\text{W}$). The second most frequent species was *G. ruber*, which did not occur in the Porcupine Seabight. Several other species, including *G. inflata*, *G. siphonifera* (*G. aequilateralis* in Cifelli and Smith, 1970), *Globigerinoides conglobatus*, and *G. glutinata* were rare. During 1988 and 1993, multinet samples were recovered in April to August (Schiebel, 2000) in the BIOTRANS area down to 500 m water depth. Again, the most abundant species was *N. incompta*, followed by *G. bulloides* and *G. glutinata*. Other frequent species were *G. inflata* and *T. quinqueloba*. The fauna showed some differences in abundance from 1988 to 1993 but still, the most common species was *N. incompta*. The OMEX II sediment trap at 600 m water depth covered one full year in 1993/1994 (Antia et al., 1996). Here, the faunal distribution revealed *N. incompta* as the most abundant species followed by *G. bulloides* and *G. inflata* during spring and summer. The occurrence of

G. glutinata, *G. hirsuta*, *G. scitula* and *T. quinqueloba* was mainly restricted to the spring bloom period (Chapman 2007). BIOTRANS, OMEX, and the Porcupine Seabight are mainly influenced by the NAC or SC. Despite the different hydrographical settings, seasonal differences, and the different sampling methods, *N. incompta* was the most frequent species at all times. The abundance of this species did not change substantially during the last 40 years. Also, the faunal assemblage composition did not change greatly, *Globigerina bulloides*, *T. quinqueloba*, *G. inflata* and *G. glutinata* being among the most abundant species during the entire year. A new observation was the occurrence of *Globorotalia hirsuta*. This is a subtropical deep-dwelling species, which reproduces semiannually to annually in winter in the surface waters near Bermuda and has an abundance maximum in March and April (Bé and Hamlin, 1967; Hemleben et al. 1985; Deuser and Ross 1989). *Globorotalia hirsuta* lives below the mixed layer, except during gametogenesis (Bé, 1960; Hemleben et al., 1989), when specimens ascend to shallower waters. The North Atlantic Drift could have carried them to temperate waters in the Porcupine Seabight. This might be one explanation for the presence of *G. hirsuta* here. However, *G. hirsuta* was not only abundant in 2004. It was also recorded in 1994, but not recognized before. Thus, the possibility of a latitudinal extension of the distribution area of *G. hirsuta* has to be considered.

1.4.3. SEDIMENT ACCUMULATION

The comparison of flux rate and assemblage composition of the fauna collected with the sediment trap and the subfossil assemblage from the surface sediments facilitates an assessment of whether the deposited foraminifera from spring and summer 2004 were representative of the long-term depositional process. Large and constant proportions of *N. incompta*, *G. bulloides*, *G. inflata* and *G. glutinata* were recorded in the Porcupine Seabight. *Globorotalia scitula*, *T. quinqueloba* and *G. siphonifera* were recorded in lower and more variable abundances. *Globorotalia hirsuta* occurred only occasionally in the core-top samples but was frequent in the sediment trap sample. This may exclude a casual appearance of *G. hirsuta* in this region but it supports the conclusion that *G. hirsuta* has expanded its biogeographical distribution. In the core-top sample from Galway Mound, small species such as *G. glutinata*, *G. scitula* and *T. quinqueloba* were less frequent than in the other fossil assemblages. This may be because smaller individuals were swept away by strong and variable currents on top of the mound.

There is no substantial, modern accumulation of sediments off the coral mounds. Indeed, the coral mounds themselves grow by sediment baffling. This explains the different pattern of foraminiferal abundance between the core-top sample M61/3-552 and the sediment trap sample. The core-top sample yields a foraminiferal flux rate that is ~17 times higher than the sediment trap. But this number has been considered very carefully since the surface sediments have received older material transported upwards by burrowing organisms.

If we relate this flux discrepancy to the distribution and area of coral mounds in the vicinity of Galway Mound (51°25N to 51°29N, 11°42W to 11°48W; taken from Dorschel et al., 2007, their figure 1), the ratio between coral mound and the surrounding areas of sandy sediments is approximately 1:29. This indicates that the sediment baffling by the mounds is largely driven by lateral advection. In addition, the normal pelagic particle flux prevails about 4m above the coral

thicket, and the lateral advection is confined to the immediate near-bottom waters. The linkage of lateral advection and related depositional processes, and its quantification have been addressed in earlier investigations (Thomsen, 1998; Mienis et al., 2009).

1.5. CONCLUSION

The transitional waters of the northeast Atlantic yield high abundances of *N. incompta* (>40 %) within the size class >125 µm. On the other hand, more than 70 % of the deposited planktonic foraminiferal shells are smaller than 125 µm.

The faunal assemblage did not change substantially except for the appearance of the subtropical species *G. hirsuta*, which appears first in 1994 in this part of the northeast Atlantic. This species occurs between March and July and its biomass is mainly influenced by the availability of nutrients. Whether *G. hirsuta* is a displaced species transported to temperate area by the Gulf Stream, or has successfully settled in the western European waters, needs be determined by monitoring its occurrence over a longer time interval.

The availability (as indicated by chlorophyll-a levels) of diatoms, the main food source for planktonic foraminifera, exerts the main influence on the weight of *G. hirsuta*, *G. glutinata* and *N. incompta*. It remains unclear whether this process amplifies or mimics the effects of ocean acidification.

The carbonate fluxes on the flank of the Galway Mound in the Porcupine Seabight were about 20 times lower than in the BIOTRANS area, even though the primary productivity and alkalinity of surface waters were similar. The main difference between the planktonic foraminiferal assemblages in these areas is that large, deep-dwelling species, for example, *G. inflata* were rare or missing from the Porcupine Seabight. We therefore conclude that the comparatively heavy tests of these deep-dwelling species are previously underestimated contributors to the global foraminiferal carbonate flux.

The sediment accumulation within the coral mounds do not represent the actual planktonic foraminiferal flux due the entrainment of redeposited materials from the surrounding sandy areas. However, the composition of the foraminiferal fauna agrees well with the composition of modern assemblages in the water column. The absence of *G. hirsuta* in the core-top sample supports the assumption that this species has extended its distribution in recent years.

Geographical and vertical distribution of planktonic foraminiferal assemblages in the tropical Atlantic Ocean

ABSTRACT

Apstein-net plankton tows were carried out in the central tropical Atlantic Ocean and in the area of the Cape Verde Islands Santo Antão and São Vicente down to 50 m and 70 m water depth in January and June 2008. The aim of this biogeographic study was to assess the actual planktonic foraminiferal assemblage composition and their habitats in the tropical Atlantic Ocean. The vertical distribution of planktonic foraminiferal habits of certain species, coupled with their size distribution was studied to get fine-scaled information about vertical migration. Surface water temperature and salinities were with 24.6°C in the area of Cape Verde Islands to 27.4°C in the central tropical Atlantic and 35.7 to 36.4 rather constant. Thirteen planktonic foraminiferal species were recorded in the area of Cape Verde Islands. The most abundant species were *Globorotalia menardii* and *Globigerinoides sacculifer*. Predominantly *Globigerinoides sacculifer*, *Globigerinoides ruber* (white and pink) and *G. menardii* were recorded in the central tropical Atlantic Ocean. In these two regions, the standing stock differed distinctly. The most regular behavior was observed in *G. sacculifer*, which had a steady abundance over the entire sampling period in both regions. In contrast, *G. menardii* showed highly variable abundances at the different locations but their depth range was similar. A comparison of the faunal assemblages from the historical data revealed significant changes in foraminiferal assemblage and abundance during the past 80 years. Notably, a distinct change in the abundance of *G. ruber* white was recognized. The observation was confirmed by core-top assemblages. The faunal changes seem to be linked to a general increase of sea surface temperature of approximately 2°C, while the global temperature changed about 0.6°C.

2.1. INTRODUCTION

2.1.1. PLANKTONIC FORAMINIFERAL SURVEY

Spatial, vertical, seasonal, and long-term distribution of planktonic foraminifera depends on several factors. Besides biological factors, like productivity, predation and symbiosis, physical and chemical factors, for instance density, temperature, salinity, nutrients and ocean currents influence the occurrence of planktonic foraminifera. The biogeographical and vertical distribution of planktonic foraminifera has been described by numerous studies (e.g., Schott, 1937; Parker, 1960; Bé, 1960; Bé and Hamlin, 1967; Bé and Tolderlund, 1971; Boltovskoy, 1964, 1973; Erez, 1978; Fairbanks et al., 1980; Hemleben et al., 1989). In general, five major faunal provinces of foraminiferal occurrence were found: polar, subpolar, temperate, subtropical and tropical.

The vertical distribution is divided in shallow-water (0-50 m), intermediate-water (50-100 m) and deep-water species (below 100 m) (Bé, 1977). The aspect of a daily vertical migration of planktonic foraminifera was investigated in several studies (Boltovskoy, 1964; Berger, 1969; Holmes, 1982). They documented different abundances during daytime and nighttime. These

changes of abundance was linked to patchiness and not to diel migration. Furthermore drastic periodic changes of abundance may occur in the photic zone due to the reproduction cycle of planktonic foraminifera (Hemleben et al., 1989). In this study we will describe the faunal composition and the vertical distribution of shallow-living planktonic foraminifera in the tropical Atlantic Ocean. Most planktonic foraminifera live in the upper 100 m of the water column. We focused on the surface mixed layer and carried out high-resolution plankton tows in the upper 50 m (70 m) of the water column, to assess the fine-scale vertical distribution of shallow-living planktonic foraminifera in the so-called surface mixed layer.

2.1.2. OCEANOGRAPHY

2.1.2.1. Central Atlantic

The western part of the study area is mainly influence by the South Equatorial Current (SEC) especially by one of its branches, the central South Equatorial Current (cSEC). The North Equatorial Countercurrent (NECC) influences the central and northern part of the study area (Fig. 2.1).

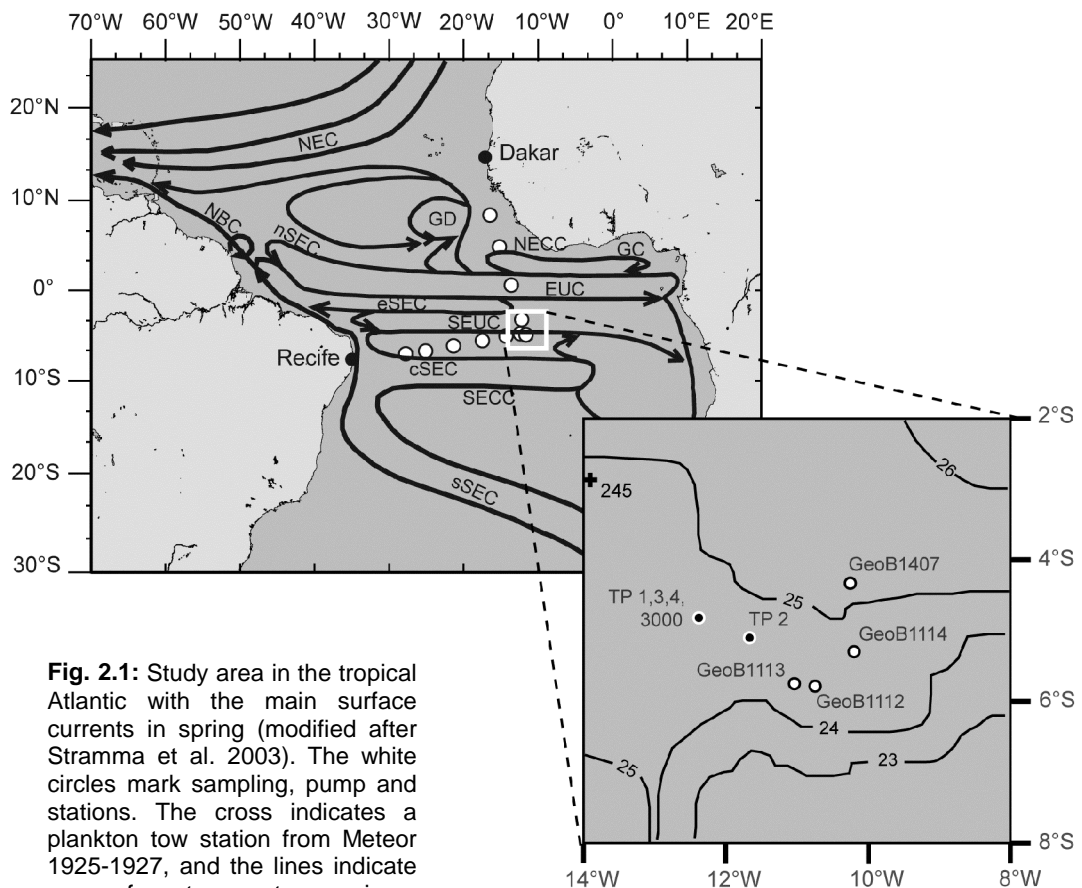

Fig. 2.1: Study area in the tropical Atlantic with the main surface currents in spring (modified after Stramma et al. 2003). The white circles mark sampling, pump and stations. The cross indicates a plankton tow station from Meteor 1925-1927, and the lines indicate sea surface temperature regimes

(modified after <http://oceancolor.gsfc.nasa.gov>). NEC = North Equatorial Current, NBC = North Brazil Current, nSEC = northern South Equatorial Current, GD = Guinea Dome, NECC = North Equatorial Countercurrent, GC = Guinea Current, EUC = Equatorial Undercurrent, eSEC = equatorial South Equatorial Current, SEUC = South Equatorial Undercurrent, cSEC = central South Equatorial Current, SECC = South Equatorial Countercurrent, sSEC = southern South Equatorial Current. The inset shows detailed stations of the plankton tows TP1-TP4 and the surface sample TP3000. GeoB stations mark core-top samples of GLAMAP 2000 data base (Pflaumann 2002).

The SEC is part of the Tropical Surface Water (TSW), and is the major water source for the tropical Atlantic (Stramma et al., 2003). In general, the SEC flows with approximately $11\text{-}16\text{ cm s}^{-1}$ (sSEC) to maximal 30 cm s^{-1} (nSEC) westwards and extends from the surface to approximately 100 m water depth. The latitudinal extension of the SEC reaches from 4°N to $15\text{-}25^{\circ}\text{S}$, and depends on longitudinal location and seasonal variation (Bonhoure et al., 2004). At 16°S , the SEC splits into two branches, the northwardheading North Brazil Current (NBC) and the southwardheading Brazil Current. In the equatorial belt, observation of flow fields are influenced by wave processes (Stramma and Schott, 1999). Instability waves with a periodicity of 25 days may accelerate the SEC westwards up to 50 cm s^{-1} (Weisberg and Weingartner, 1988). Also, Rossby waves and Kelvin waves, which are generated by the zonal wind anomaly exert a seasonal variability the equatorial tropical Atlantic, while the southern band of the SEC (sSEC), shows nearly a constant flow and only a weak variability (Stramma et al., 2003, 2005).

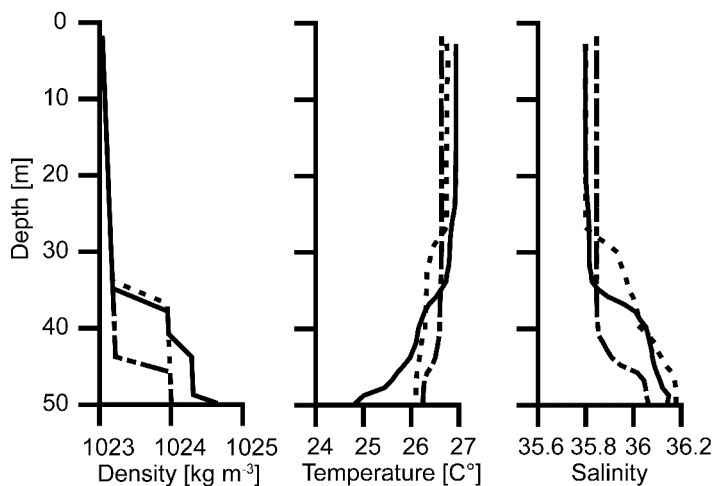

Fig. 2.2: Example of surface water structure in the central Atlantic Ocean. CTD data (Mertens, University Bremen, unpublished data) in the vicinity of the plankton tows was carried out in January 2008. The dashed line shows data from 19 January, the dotted line from 22 January, and the solid line from 24 January.

The NECC is located between 3°N and 10°N , depending on the longitudinal location and seasonal variations. The velocity of the eastwardflowing NECC is on average 42 cm s^{-1} . It may accelerate to 50 cm s^{-1} in winter (Arnault, 1987; Fratantoni, 2001). In the western part of the NECC at 28°W , surface current speeds of 143 cm s^{-1} have been estimated (Richardson and Reverdin, 1987). The NECC is mainly driven by seasonal winds and the location of the Intertropical Convergence Zone (ITCZ). Thus, the NECC is an eastward-flowing current in northern fall with maximum speeds in August, when the ITCZ is in its northernmost position, and a weak westward-flowing current in northern spring (Stramma and Schott, 1999).

The South Equatorial Undercurrent (SEUC) prevails below the thermocline at 80 m, It flows continuously eastwards, and is related to the equatorial thermostat (Stramma and Schott, 1999; Stramma et al., 2003). This water mass is characterized by low salinity and phosphate, but high oxygen values. The Equatorial Undercurrent (EUC) is also an eastwardflowing, but very fast subsurface current ($40\text{-}90\text{ cm s}^{-1}$). It is centered at approximately 100 m water depth (Bonhoure et al., 2004).

Table 2.1. List of CTD stations, carried out in January 2008. The stations are similar to the stations where plankton tows TP1, TP3 and TP4 were carried out.

Date	UTC	Longitude	Latitude
19.01.2008	23:34	12°22.36W	4°47.98S
22.01.2008	09:11	12°22.60W	4°47.39S
24.01.2008	02:28	12°22.40W	4°48.34S

depth at 22 January and 24 January. On 19 January, the pycnocline was recognized at 41 m water depth.

2.1.2.2. Cape Verde

The hydrographic situation in the vicinity of the Cape Verde Islands is mainly influenced by the Canary Current (CC). The CC flows southwards with an average speed of 10-15 cm s⁻¹ (Zhou et al., 2000; Lazaro et al., 2005).

The CC is wider and more intense during winter than in summer, but does not show strong seasonal variability (Lazaro et al., 2005). During summer, the southward winds diminish and the northward flowing Mauretania Current forms near the African coast, which suppresses coastal upwelling (Mittelstaedt, 1983). South of the Cape Verde Islands, the CC is heading southwestwards and joins the NEC (Mittelstaedt, 1991). Stramma and Siedler (1988) described the CC as variable and weak in winter and spring. Also the CC contains large eddies and filaments (Johnson and Stevens, 2000).

In the Cape Verde region, south of São Vicente, the salinity and the temperature profile showed a very steady pattern in the upper 70 m of the water column. Salinity values varied between 36.35 to 36.39. Temperature ranged from 25.22°C to 23.09°C (Fig. 2.4). Since the profiling float does not give a straight vertical profile, the values may be considered with caution. Below 70 m water depth, temperature decreased strongly to 18°C and salinity to 36.06 at 115 m water depth. This results in a pycnocline at 65 m depth.

Three CTD casts were conducted during R/V Atalante cruise MARSUED IV in January 2008. They recorded surface water temperatures between 26°C and 27°C and surface salinities of about 35.8 (Fig. 2.2, Table 2.1). The surface waters were well mixed down to 30 m depth and showed a distinct pycnocline at 35 m water

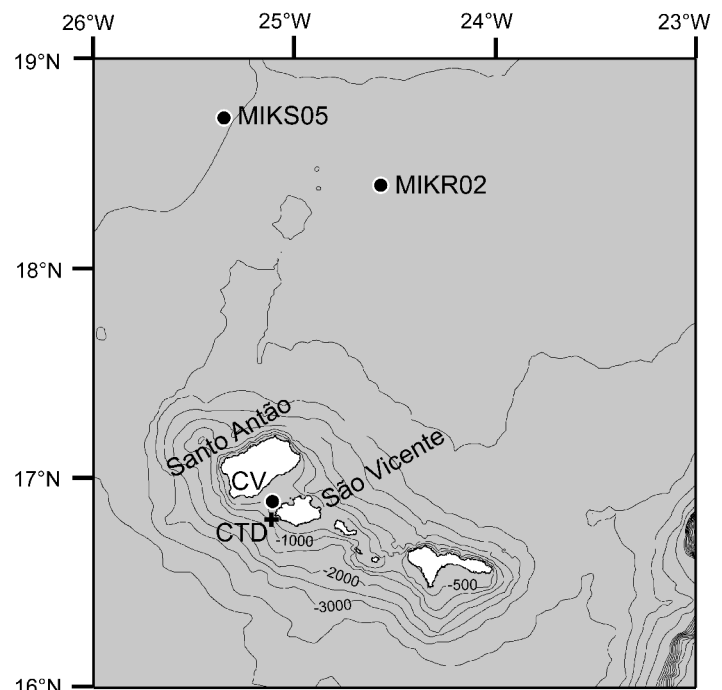

Fig. 2.3: Study area in the vicinity of the Cape Verde Islands. CV= towing site, MIKS05 and MIKRO2 = core tops

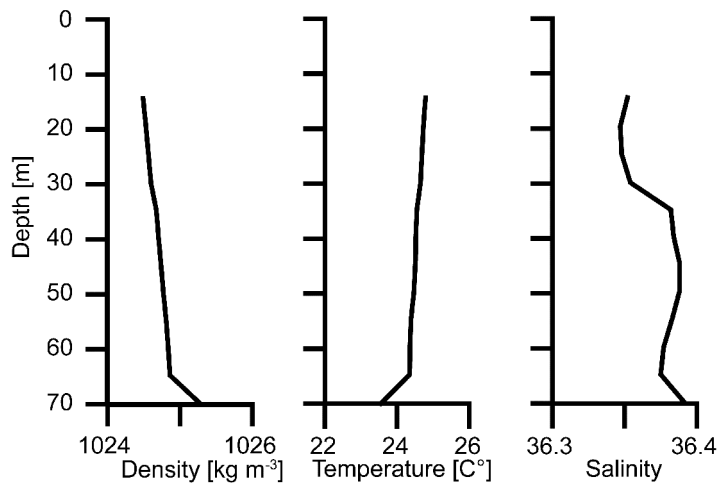

Fig. 2.4: Overview of surface water hydrographic structure in the Cape Verde area. Profiling float data (Fiedler, IFM-GEOMAR, unpublished data) from 28 June 2008. The profiling float was deployed at 16.77N, 25°06W.

2.2. MATERIALS AND METHODS

2.2.1. PLANKTON SAMPLING

2.2.1.1. Central Atlantic

Planktonic foraminifera were collected on R/V *Atalante* cruise MARSUED IV, leg 2 from Recife (Brazil) to Dakar (Senegal) in January 2008 (Fig. 2.1), by using the ship's system integrated pump. Thirty-two samples have been collected between 9 January and 29 January 2008 (Table 2.2). The first two samples RD1 and RD2 had a volume of 1 m³. Because of low planktonic foraminiferal inventory, the volume was raised to approximately 3 m³. Sample RD8 from 12 January 2008 has been omitted from the results, because it was contaminated by wastewater particles during filtering. Seawater was filtered two times a day through a 63- μ m sieve. The water was pumped from below the vessel, between 5 and 7 m depth.

Other 18 samples were taken on several days with an Apstein net with a 100- μ m mesh and an aperture of 17 cm diameter. We deployed 10-m hauls down to 50 m water depth. The net was slacked and lifted with 0.3 m s⁻¹ five times at each section, so approximately 1 m³ was filtered (Table 2.3). To assure a vertical deployment, a lead weight was attached to the intake cone of the net. The samples were rinsed with fresh water and conserved with 98 % ethanol. One surface sediment sample (TP3000) could be recovered during the cruise with the Remotely Operated Vehicle (ROV) Kiel 6000 at approximately the same location as the net samples were taken (Figure 2.1, inset). This sample is a filling of a crack of fresh Mid Ocean Ridge basalt recovered near the Wideawake hydrothermal field. The basalt is considered to be only a few years old (Melchert and Paulick, 2008).

2.2.1.2. Cape Verde

Hand-hauled plankton tows were carried out during a research visit on the Cape Verde Island São Vicente in June 2008. Ten cruises with R/V *Sinagoga* have been conducted between the Islands São Vicente and Santo Antão, in cooperation with the Instituto Nacional de Desenvolvimento das Pescas (INDP). With an 100 μ m Apstein-net, plankton tows were performed down to 70 m water depth on seven days in June 2008 (Table 2.5). Six samples were wet picked in the laboratories of the INDP.

Table 2.2. Specifications of pump samples

Sample	Date	UTC		Longitude		Latitude		Ship's velocity [kn]	Linear distance [nm]	Duration [min]	Volume [m ³]	Yield [m ³ /h]	Tests total	Tests m ⁻³
		Start	Stop	Start	Stop	Start	Stop							
RD 1	09.01.2008	11:36	12:30	27°37.700W	27°45.880W	07°03.443S	07°02.250S	9,13	8,22	54	1,005	1,12	14	13,93
RD 2	09.01.2008	16:00	17:13	27°27.723W	27°28.445W	07°02.144S	07°02.440S	0,62	0,75	73	1	0,82	5	5,00
RD 3	10.01.2008	9:46	12:02	24°46.878W	25°07.930W	06°42.355S	06°39.245S	9,32	21,12	136	3	1,32	92	30,67
RD 4	10.01.2008	15:50	18:06	23°51.278W	24°11.740W	06°34.055S	06°31.088S	9,02	20,44	136	3,01	1,33	45	14,95
RD 5	11.01.2008	9:50	12:22	20°57.900W	21°22.808W	06°09.079S	06°05.390S	9,93	25,16	152	3	1,18	25	8,33
RD 6	11.01.2008	15:54	18:39	19°57.322W	20°23.920W	06°00.368S	05°56.585S	9,68	26,62	165	3	1,09	41	13,67
RD 7	12.01.2008	9:45	11:40	17°12.581W	17°30.957W	05°34.876S	05°32.145S	9,69	18,57	115	3,001	1,57	122	40,65
RD 8	12.01.2008	14:33	17:28	16°22.940W	16°45.324W	05°27.412S	05°22.640S	7,79	22,73	175	2,903	1,00	4	1,38
RD 9	13.01.2008	9:01	11:39	13°52.626W	14°17.077W	05°05.019S	05°01.616S	9,35	24,62	158	3,001	1,14	110	36,65
RD 10	13.01.2008	14:48	17:32	12°57.190W	13°22.850W	04°57.474S	04°53.745S	9,48	25,91	164	3	1,10	84	28,00
RD 11	14.01.2008	9:18	11:40	12°22.427W	12°22.632W	04°48.379S	04°48.583S	0,11	0,27	142	3,005	1,27	316	105,16
RD 12	14.01.2008	14:50	17:27	12°22.416W	12°22.412W	04°48.594S	04°48.590S	0,00	0,01	157	3,015	1,15	213	70,65
RD 13	17.01.2008	10:55	13:45	11°59.704W	12°22.332W	04°48.857S	05°00.285S	8,84	25,05	170	2,94	1,04	458	155,78
RD 14	17.01.2008	15:49	18:43	11°42.113W	11°45.261W	05°09.764S	05°06.959S	1,45	4,21	174	2,794	0,96	224	80,17
RD 15	18.01.2008	9:24	12:28	12°22.346W	12°22.314W	04°48.442S	04°48.610S	0,05	0,16	184	2,83	0,92	378	133,57
RD 16	18.01.2008	15:50	18:51	12°22.364W	12°22.359W	04°48.588S	04°48.586S	0,00	0,01	181	3,025	1,00	314	103,80
RD 17	20.01.2008	10:11	12:57	12°22.268W	12°22.282W	04°48.121S	04°48.198S	0,03	0,08	166	2,72	0,98	418	153,68
RD 18	20.01.2008	15:53	18:13	12°22.267W	12°22.275W	04°48.193S	04°48.200S	0,00	0,01	140	2,99	1,28	770	257,53
RD 19	22.01.2008	11:36	13:44	12°22.599W	12°22.604W	04°47.395S	04°47.389S	0,00	0,01	128	3	1,41	648	216,00
RD 20	22.01.2008	17:05	19:45	12°22.600W	12°22.600W	04°47.391S	04°47.398S	0,00	0,01	160	3	1,13	418	139,33
RD 21	24.01.2008	9:11	11:36	12°22.297W	12°22.721W	04°48.626S	04°48.852S	0,18	0,43	145	3,01	1,25	403	133,89
RD 22	24.01.2008	16:50	19:46	12°22.347W	12°22.425W	04°48.044S	04°48.114S	0,03	0,10	176	3,02	1,03	321	106,29
RD 23	25.01.2008	9:36	12:02	11°36.996W	11°39.493W	04°56.021S	04°56.506S	1,05	2,55	146	3	1,23	383	127,67
RD 24	25.01.2008	14:57	17:37	11°37.002W	11°37.002W	04°56.501S	04°56.339S	0,06	0,16	160	3,01	1,13	303	100,66
RD 25	26.01.2008	10:32	12:32	12°21.219W	12°13.800W	03°14.099S	02°53.613S	10,80	21,60	120	3,05	1,53	646	211,80
RD 26	26.01.2008	15:50	18:43	12°43.476W	12°33.066W	02°20.826S	01°52.050S	10,52	30,35	173	3	1,04	256	85,33
RD 27	27.01.2008	9:07	11:10	13°43.866W	13°36.325W	00°34.227N	00°55.074N	10,64	21,81	123	3,03	1,48	331	109,24
RD 28	27.01.2008	15:26	17:17	14°06.715W	13°58.752W	01°39.038N	01°58.295N	11,21	20,73	111	2,98	1,61	317	106,38
RD 29	28.01.2008	10:03	12:12	15°17.890W	15°10.118W	04°53.398N	05°14.830N	10,50	22,57	129	2,92	1,36	217	74,32
RD 30	28.01.2008	15:36	17:32	15°34.293W	15°30.120W	05°48.503N	05°59.988N	6,09	11,77	116	2,95	1,53	246	83,39
RD 31	29.01.2008	09:25	11:33	16°34.351W	16°26.805W	08°24.125N	08°44.798N	10,38	22,14	128	2,85	1,34	49	17,19
RD 32	29.01.2008	15:27	17:30	16°48.481W	16°47.439W	09°20.454N	09°21.026N	0,59	1,21	123	2,9	1,41	12	4,14

2.2.2. TAXONOMY

The planktonic foraminiferal species were determined after Hemleben et al. (1989), Saito et al. (1981) and Bé (1977). Because of their low abundance, *Globigerinella calida* and *Globigerinella siphonifera* have been combined and named *Globigerinella spp.* Discussions with E. Kandiano and K. Brown (IFM-GEOMAR) supported our taxonomic concept. Representative specimen of the most frequent species were photographed with a CAM SCAN CS 44 in the Institute for Geosciences at Kiel University. Samples were prepared with the sputter device Emitech K550 (Au+Pd).

2.2.3. FAUNAL ANALYSES

The planktonic foraminiferal samples taken in the Central Atlantic Ocean were stored at 4°C at IFM-GEOMAR, Kiel. Each pump sample was rinsed with fresh water through a 63-µm sieve and was dried on filter paper at 50°C. The foraminifera were brushed off the paper and transferred to a cell slide, where they were examined and counted.

The net samples from the Central Atlantic and Cape Verde were wet picked and dried at room temperature. Then the largest diameter of the single tests were measured with an eyepiece reticle.

In the wet samples of the Cape Verde region, a high number of Chaetognatha was observed, especially sticking to *G. menardii*. In the wet samples of both study areas, we found also some copepods. Additionally we had to separate planktonic foraminifera from parts of jellyfish.

In order to remove the protoplasm of the planktonic foraminifera, the samples were cleaned with H₂O₂ (3 %) and rinsed with ethanol.

2.2.4. HYDROGRAPHY

During MARSUED IV several CTD measurements were performed with Sea-Bird Electronics, Inc. SBE 911plus system. The CTD was attached to a SBE 32 carousel water sampler with 24 Niskin bottles and was equipped with double temperature, conductivity, and oxygen sensors as well as with a Wetlab C-Star transmissometer (D. Quadfasel, Univ. Hamburg). The CTD data were provided by C. Martens from Bremen University. The data of surface temperature and salinity were measured with a ship's thermosalinograph.

During the research visit on the Cape Verde Island São Vicente, a CTD profile was obtained with a Nemo-CO₂ Profiling Float (Prototype), Optimare AG, Bremerhaven, Germany. The CTD data were provided by B. Fiedler, IFM-GEOMAR, Kiel. In situ surface temperature and salinity was obtained with a WTW conductivity meter LF320.

Density was calculated from temperature and salinity data after Fofonoff and Millard (1983) (<http://www.es.flinders.edu.au/~mattom/Utilities/density.html>).

2.2.5. SURFACE SEDIMENT DATA

One surface sample could be recovered during MARSUED IV at 4°48.159S and 12°22.298W in 3000 m water depth. The foraminiferal assemblage composition in surface sediments in the vicinity of our plankton tows (Fig. 2.1) was obtained from the GLAMAP 2000 data base (Pflaumann 2002). For comparison, we considered other plankton tows reported in the literature. In conformance with the GLAMAP 2000 data set, we used only individuals >150 µm.

2.2.6. HISTORICAL DATA

Historical data on past planktonic foraminiferal distribution were retrieved from the literature. However, earlier surveys used different methods and devices.

Plankton tows at stations 245, 246, 247 and 270 have been carried out in 1927 by Schott with a Nansen closing net (70 μm) in depth intervals of 50 m. Information of the deployment speed and intake size was not given. Foraminifera larger than 200 μm were considered for faunal analysis.

Plankton tows by Bé and Tolderlund (1971) have been carried out with nylon plankton nets with a 200 μm mesh and a 50 cm opening and a length of 3 m. The deployments were carried out between 1955 and 1966.

Boltovskoy (1964) obtained planktonic foraminiferal samples in March and April 1963 during the cruise Equalant I. He used a nylon net with 158 μm mesh size and took samples in 0-25 m, 25-40 m, 40-50 m, 50-60 m, 60-70 m, 70-75m, 75-80 m, 80-90 m, and beyond down to 300 m water depth.

Plankton tows in 1988 and 1991 by Kemle-von Mücke (1999a,b) and Oberhänsli et al. (1992) have been carried out with 64 μm mesh Multiple Opening-Closing Net and an intake of 0.25 m^2 . Only specimen larger than 100 μm were identified. Plankton samples have been obtained from 0-25 m, 25-50 m, 50-100 m, 100-150 m and 150-300m (1988) as well as 0-50 m, 50-100 m, 100-300 m and deeper section (1991). The net was towed with 0.3 m s^{-1} .

2.3. RESULTS

2.3.1. FORAMINIFERAL ASSEMBLAGE

2.3.1.1. *Central Atlantic (underway data)*

The abundance of planktonic foraminiferal assemblages in the upper 5 to 7 m of the water column showed a distinct variability along the transit route from Recife to Dakar in January 2008 (Fig. 2.5).

The first ten pumped samples RD1 to RD10 contained a maximum of 41 individuals m^{-3} . These samples have been recovered during waxing moon and on the eastward transit to the working area in the central Atlantic, above the Mid Atlantic Ridge (MAR). Two current system, the cSEC and the SEUC have been passed during this transit. Salinity and temperature values did not vary strongly. Salinity ranged from 36.08 to 36.34, temperature showed values between 26.16°C and 27.55°C.

Pump samples RD11 to RD24 were recovered from 14 January to 25 January. The ship has been on station at this time and was located in the SEUC system. Over this period of sampling, the temperature varied between 26.73°C to 27.7°C with increasing values to the east. Salinity showed quite stable conditions but a slightly eastward decrease from 35.92 to 35.54. This sampling period covered crescent, full moon and the beginning of waning moon. The abundance of the planktonic foraminiferal assemblage ranged from 71 individuals m^{-3} to a maximum of 257 specimen m^{-3} .

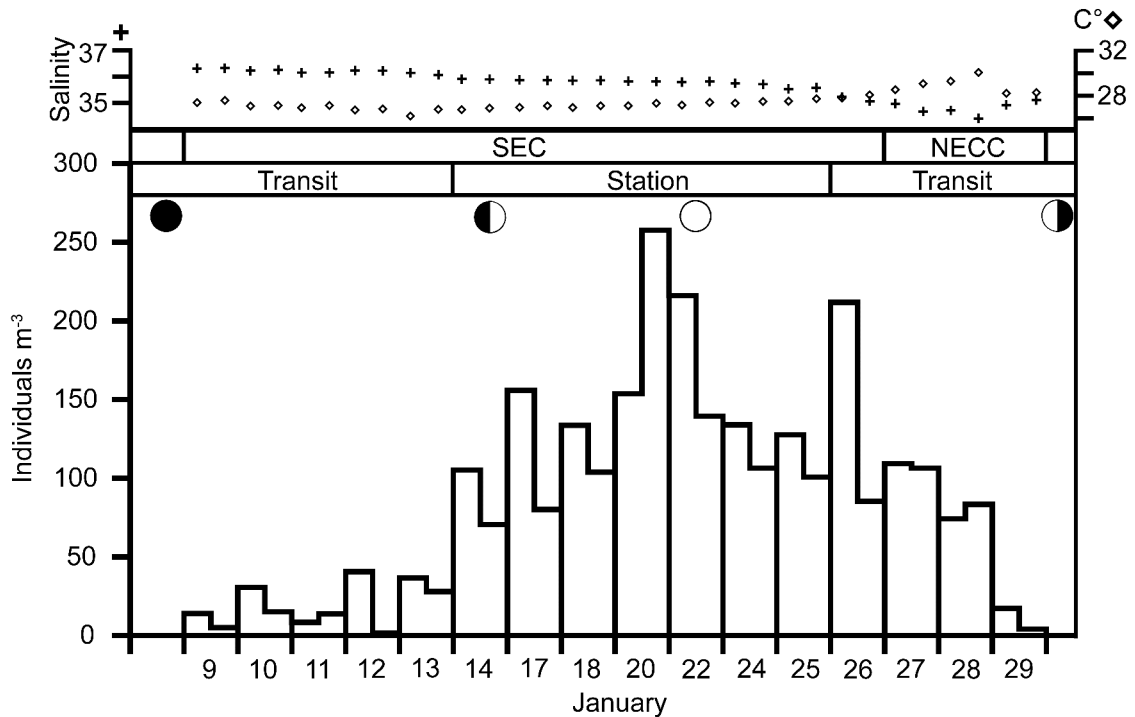

Fig. 2.5: Planktonic foraminiferal abundances in the upper 5m to 7m of the water column between 9 January to 29 January 2008. Sampling with the pump was done two times a day over a 63- μm sieve. SEC = South Equatorial Current; NECC = North Equatorial Countercurrent. The circles mark the phases of the moon. Temperature (diamonds) and salinity (crosses) data are surface water values measured with the ship's thermosalinograph.

The last eight samples RD25 to RD32 were recovered during the northward transit to Dakar starting on 26 January. Two current systems have been passed, the EUC and the NECC. A strong change in temperature values and salinity could be observed during this transit. The salinity values firstly showed a strong decrease from 35.59 down to 34.42, then increased just as strong to 35.12. On the contrary the temperature first increased from 27.48°C to 30.05°C, then decreased to a minimum of 28.2°C. The abundance of planktonic foraminifera showed decreasing values from 212 individuals m^{-3} to a minimum of 4 tests m^{-3} .

A general, unexpected pattern emerged in that antemeridian pump samples showed systematically higher abundances than the samples taken in the afternoon. We calculated an average difference of $24 \pm 35.7\%$ (1σ) for all samples. Only a few exceptions were observed, e.g., on the 11, 20 and 28 January. In the morning of 11 January the sample RD5 showed 8 individuals m^{-3} , while RD6 bore 14 individuals m^{-3} . Two days before full moon, on 20 January, sample 17 showed 154 foraminiferal tests m^{-3} in the morning, and RD18 showed in the afternoon an outstanding maximum of 258 individuals m^{-3} . A smaller difference was recognized between samples RD29 with 74 individuals m^{-3} in the morning and sample RD30 with 83 foraminifera m^{-3} in the afternoon of 28 January.

2.3.1.2. Central Atlantic (plankton tows)

During the cruise of L'Atalante in January 2008, four plankton tows were carried out between 15 January and 24 January. These plankton tows were exclusively in the SEC and above the SEUC system.

Table 2.3. List of plankton tows carried in the central Atlantic Ocean.

Sample	Date	UTC start	Longitude	Latitude	Volume per section [m ³]	Number of tests	Tests m ⁻³
TP 1	15.01.2008	10:31	12°22.354W	04°48.632S	1,134/*1.36	39	6,61
TP 2	19.01.2008	15:04	11°39.961W	05°05.697S	1,134	57	16,75
TP 3	21.01.2008	11:00	12°22.450W	04°48.572S	1,134	67	11,82
TP 4	24.01.2008	15:04	12°22.661W	04°48.832S	1,134	46	8,11

*In depth section 10-20 m, the Apstein-net was deployed six times.

In the upper 50 m of the water column planktonic foraminiferal abundances with a maximum of 17 individuals m⁻³ were recovered in tows at TP2 (Fig. 2.6). Plankton tows TP1, TP3 and TP4 have been carried out at nearly the same location (Table 2.3). A population density between 6 individuals m⁻³ (TP1) and 12 individuals m⁻³ (TP3) was observed in the upper 50 m of the water column. At this stations, surface water temperature showed increasing values between 36.8°C and

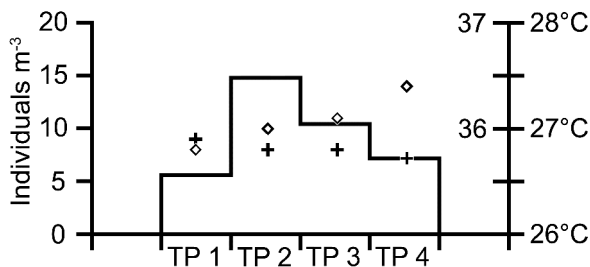

Fig. 2.6: Planktonic foraminiferal abundances of plankton tows. The diamonds mark temperature and the crosses mark salinity values from the water surface.

27.4°C. On the other hand salinity of the surface water showed decreasing values from 35.9 to 35.72. The foraminiferal assemblages showed fourteen different planktonic foraminiferal species (Appendix 2.1, Appendix 4). *Globigerinoides sacculifer* was highly abundant in every of the four tow samples with a maximum at TP2 with approximately 51 % (Fig. 2.7). This species was the most abundant planktonic foraminiferal species with an average

proportion of 39 %. *Globgerinita glutinata*, which was the second ranked species, showed a maximum proportion at TP1 with more than 37 %. The average proportion of *G. glutinata* was approximately 17 %. Other frequent species were *Globigerinoides ruber* pink, with a maximum abundance of nearly 20 % in TP2 and an average proportion of 12 %. *Globorotalia menardii* was frequent in tow sample TP1 with a proportion of more than 23 %. This species is the fourth most common species with an average of nearly 11 %. *Globigerinoides ruber* white is common with an average of nearly 7 % and a maximum proportion of 13 % in TP4. Other planktonic foraminiferal species with an average of 5 % or less were *Globoturborotalia rubescens*, *Orbulina universa*, *Turborotalita quinqueloba*, *Globorotalia scitula*, *Tenuitella parkerae*, *Globigerinella* spp., *Streptochilus globigerus*, *Dentagloborotalia anfracta* and *Pulleniatina obliquiloculata*.

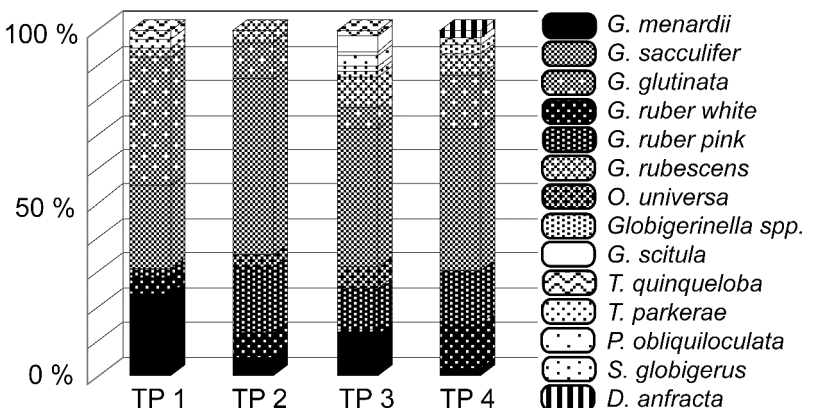

Fig. 2.7: Proportion of planktonic foraminifera of four tow samples taken in January 2008. TP1, TP3 and TP4 were taken at similar location.

The size distribution of planktonic foraminiferal species from tow samples TP1, TP3 and TP4 was combined, because of their close sampling location (Fig. 2.8). The smallest size fraction 100 µm to 150 µm contained only three planktonic foraminiferal species, *G. sacculifer*, *G. glutinata* and *G. rubescens*. The highest diversity was recognized in the size fraction 150 to 250 µm, where thirteen different species were found. The most abundant species in the size fraction 150 to 250 µm were *G. sacculifer* and *G. glutinata*. The size fraction 250 to 315 µm contained seven foraminiferal species. More than 60 % were contributed by *G. sacculifer* and *G. ruber* pink. The size fractions larger 315 µm contained *G. sacculifer*, the most abundant species with more than 60 %, and *G. menardii*, *O. universa* and *P. obliquiloculata*.

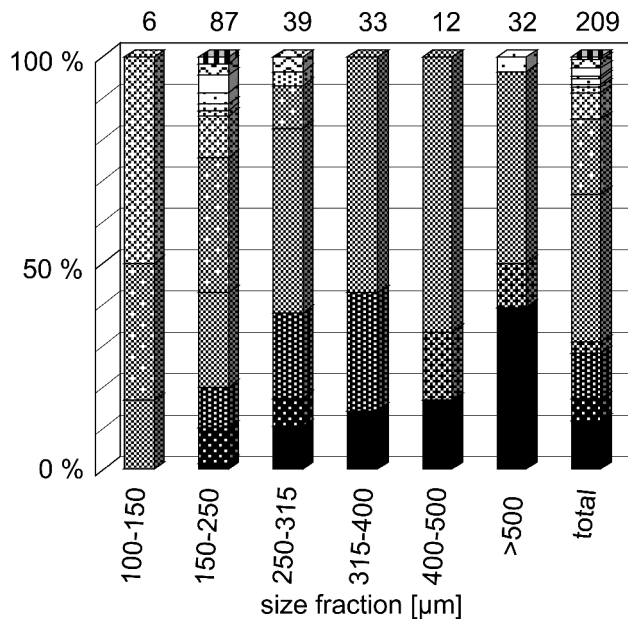

Fig. 2.8: Proportion of planktonic foraminifera of combined samples TP1, TP3 and TP4 in several size fractions. The numbers above the columns show the number of foraminifera found. Legend, see figure 2.7.

2.3.1.3. Cape Verde

In the area of the Cape Verde region, plankton tows down to 70 m water depth have been carried out in June 2008. A minimum population density of nearly 5 individuals m⁻³ was found in the first plankton tow (Fig. 2.9). A steady increase of population density from 13-35 individuals m⁻³ was recognized from sample CV2 to CV4. Plankton tow sampling CV5 has been cancelled due to bad weather. Plankton tow CV6 contained approximately 20 individuals m⁻³. The highest population

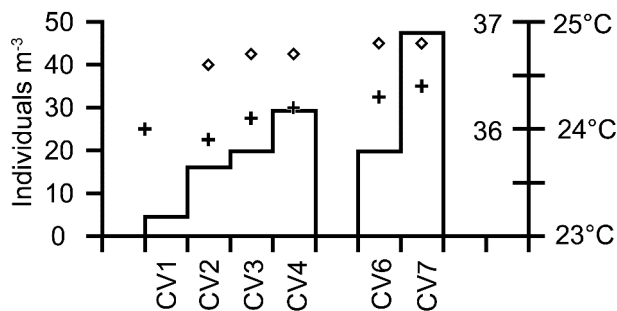

Fig. 2.9: Population dynamics of planktonic foraminifera in the Cape Verde region. Depth sections were pooled. Diamonds = temperature; crosses = salinity.

density could be observed in plankton tow CV7 with a maximum of nearly 47 individuals m⁻³. The surface salinity values during the sampling days varied between 35.9 and 36.4. The surface temperature only slightly increased from 24.6°C to 24.8°C.

The planktonic foraminiferal assemblage consisted of thirteen different species (Appendix 2.2, Appendix 4). The most abundant species were *G. menardii*,

with an average of approximately 29 %, and *G. sacculifer* with an average of 26 %. Less abundant but still common species were *G. ruber* white with an average of 10 % and *G. glutinata* with an average of nearly 8 %. Other planktonic foraminiferal species as *G. ruber* pink, *Globigerinella* spp., and *G. rubescens* had on average 5-6 %. *Orbulina universa*, *N. dutertrei*, *T. parkerae*, *G. tenella*, *H. pelagica*, *T. quinqueloba* and some unidentified individuals occurred only as single individuals.

The most abundant species, *G. menardii* occurred with 17 % on the first sampling day, increased its proportion to 58 % in the following days, but decreased then strongly to only 8 % on the last sampling day

CV7. The second ranked foraminiferal species *G. sacculifer* was evenly distributed and showed quite stable abundances in the first three plankton tows with 26-32 %. On CV4, the abundance was only 21 %, increased to 28 % on the following tow, and decreased again to 20 % on the last sampling

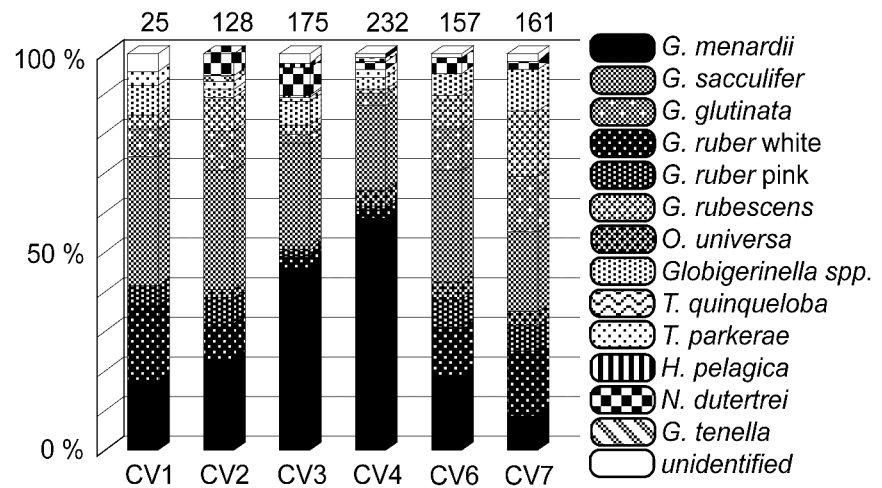

Fig. 2.10: Proportion of planktonic foraminifera in the Cape Verde (CV) region. The numbers above the columns show the number of foraminifera found.

day. *Globigerinoides ruber* white showed with 19 % on the first sampling day its highest abundance, and decreased in the following days to 2 % only. On the last two sampling days, the abundance of *G. ruber* white increased again to 12-17 %. The fourth ranked planktonic foraminiferal species was *G. glutinata*, which showed its highest abundance on the first two and last two sampling days with 7-13 %, but very low abundances of 2-3 % on CV3 and CV4.

2.3.2. VERTICAL DYNAMICS

2.3.2.1. Central Atlantic

Plankton tows in the central Atlantic Ocean have been carried out in 10 m intervals down to 50 m water depth. The population density of the upper 50 m of the water column showed some variability in respect to the different sampling days and depth sections. In the upper 10 m of the water column a population density between 4.4 individuals m^{-3} (TP1) and 19 tests m^{-3} (TP2) was found (Fig. 2.11). In the third tow sample TP3, the foraminiferal assemblage consisted of 8 individuals m^{-3} and nearly 9 tests m^{-3} were found in TP4. A similar distribution was recognized in the 10 m to 20 m depth section. Here, the lowest density of approximately 7 tests m^{-3} was seen in the first tow sample TP1, followed by a much higher population density of 19 tests m^{-3} in TP2. Again, the third tow sample contained a lower number of individuals with 11 m^{-3} and TP4 consisted of nearly 13 individuals m^{-3} . In the following depth section 20-30 m, a very constant population density

of 8 to approximately 11 tests m^{-3} was observed. The depth sections 30 m to 40 m showed a standing stock between 3.5 individuals m^{-3} (TP4) and 15 individuals m^{-3} (TP3).

The second tow sampling was not carried out in this depth section and the deeper depth section 40 m to 50 m. In the water section 40-50 m, the highest population density was seen in TP3

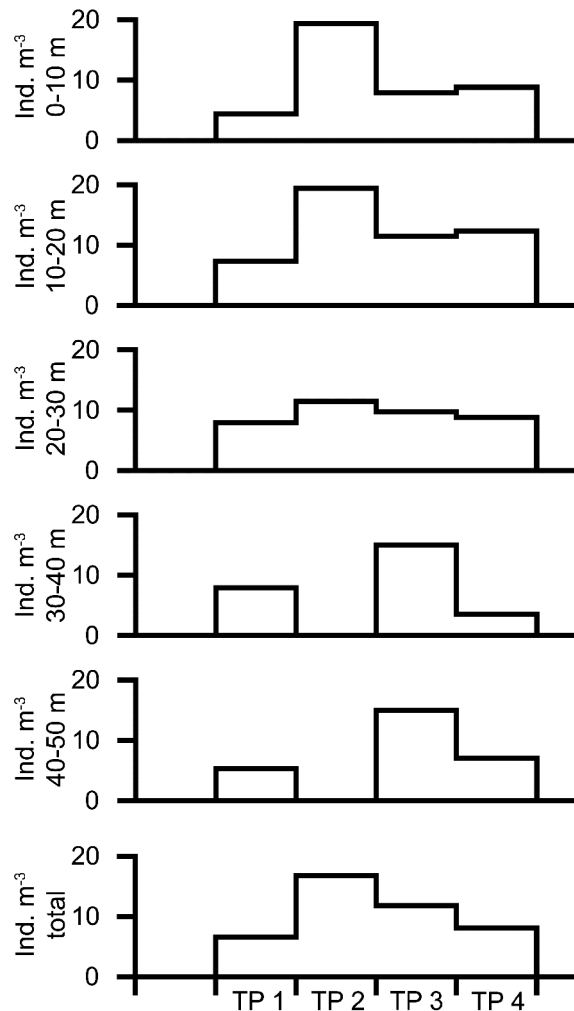

Fig. 2.11: Vertical distribution of planktonic foraminifera in the central Atlantic. TP1, TP3 and TP4 were taken at similar locations. Tow sampling TP2 was aborted after 20 m to 30 m depth section because of strong sideward drifting of the ship.

(TP1,3,4) and a maximum of 3.5 individuals m^{-3} (TP2) was observed. Larger individuals of *G. ruber* white were found in TP1 and TP2, whereas the tests of *G. ruber* white in tow samples TP3 and TP4 were all from the 150-250 μm size fraction.

The planktonic foraminiferal species *G. ruber* pink had a very low population density in the first plankton tow TP1. Only in depth section 10-20 m, a notable standing stock of 0.73 tests m^{-3} was recorded. In plankton tow TP2, *G. ruber* pink in the upper 30 m of the water column revealed a standing stock between 0.9 and 4.4 individuals m^{-3} . In tow sample TP3, *G. ruber* pink was recovered from the upper 40 m of the water column. A maximum population density of 3.5 tests m^{-3} was observed in the surface water. The standing stock of *G. ruber* pink decreased with depth down

with 15 m^{-3} and TP4 contained 7 individuals m^{-3} .

Three shallow-living foraminiferal species, *G. ruber* white, *G. ruber* pink and *G. sacculifer* as well as the deep-dwelling species *G. menardii* were analysed in detail. The population density of *G. menardii* was very uniform in the upper 50 m water depth within the first plankton tow TP1 (Fig. 2.12). A standing stock of *G. menardii* between 0.7 and 2.6 individuals m^{-3} was found in TP1. The occurrence in the later tow samples was restricted to single depth intervals. In tow sample TP2, *G. menardii* occurred from 10 m to 30 m with a maximum of 0.9 and 1.8 tests m^{-3} . The deeper tow sections were not carried out, so it cannot be excluded, that *G. menardii* prevailed also in deeper habitats. In tow sample TP3, *G. menardii* occurred only in the deeper tow sections 30 m to 50 m with a population density of 0.9 to 6.2 individuals m^{-3} . In the last tow sample TP4, *G. menardii* was observed with only 0.9 individuals m^{-3} in 40-50 m water depth. The size distribution changed distinctly between the tow sections. Large individuals were found in surface water as well as at 50 m water depth.

Globigerinoides ruber white was limited to the upper 30 m of the water column. A population density between 0.9 individuals m^{-3}

to 0.9 individuals m^{-3} in 30-40 m water depth. The population density of *G. ruber* pink in plankton tow TP4, was recognized between 0.9 and 2.65 tests m^{-3} . The size distribution of *G. ruber* pink seemed to be randomly distributed in the depth sections studied.

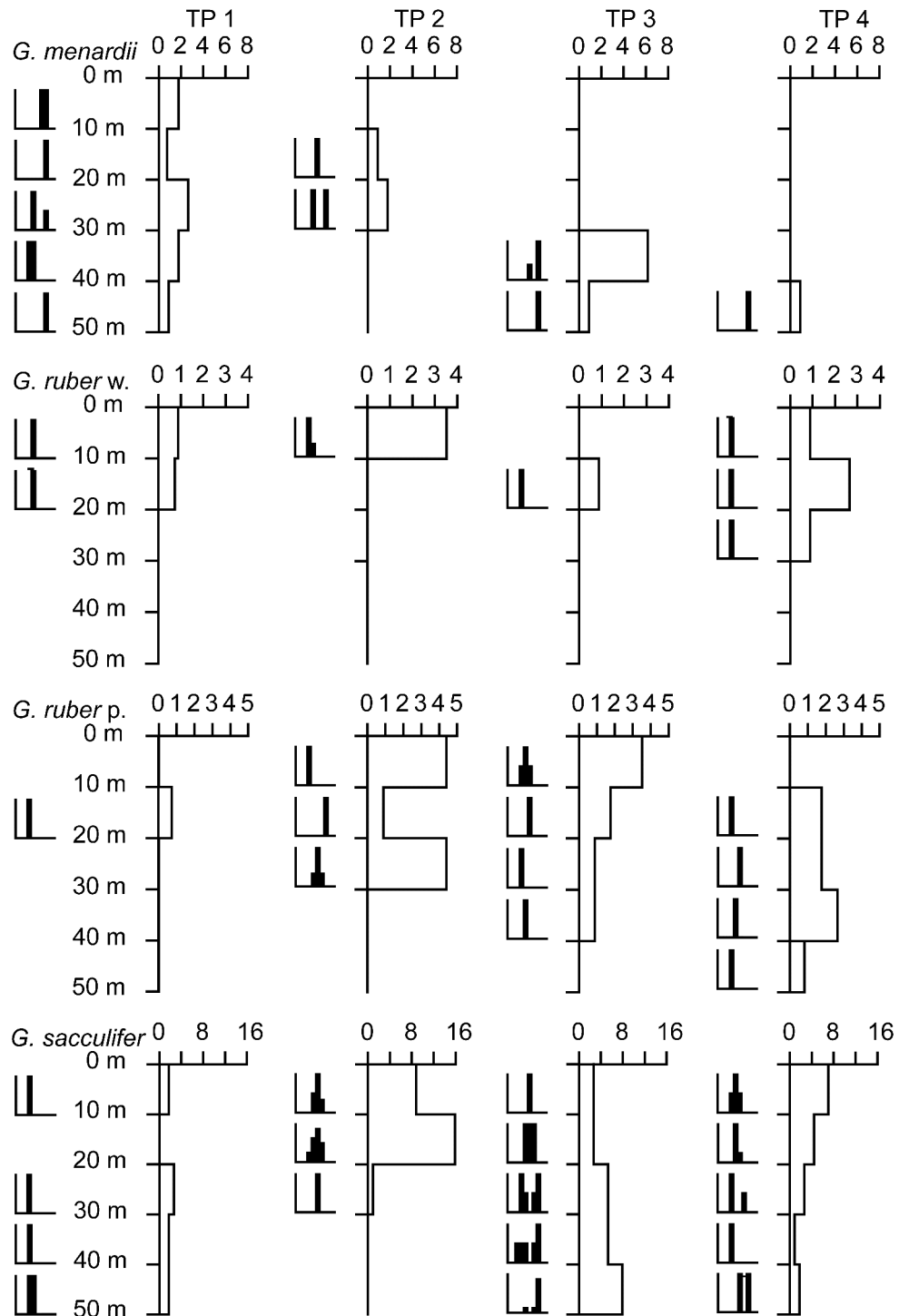

Fig. 2.12: Vertical distribution of four major planktonic foraminiferal species on 4 different days in the Central Atlantic in specimen m^{-3} . The size distribution [%] is given in size fractions: 100-125 μm , 125-150 μm , 150-250 μm , 250-315 μm , 315-400 μm , 400-500 μm and >500 μm .

The most abundant species was *G. sacculifer*, which occurred with one exception in every tow section at high numbers (Fig. 2.12). In the first tow sample TP1, the population density of *G. sacculifer* was quite uniform with 1.8 and 2.65 individuals m^{-3} . A very erratic population density was observed in plankton tow TP2. The standing stock changed between 8.9, 15.9 and a very low

density of 0.9 individuals m^{-3} . The population density in plankton tow TP3 increased with water depth from 2.65 to 7.9 individuals m^{-3} . In contrast, the standing stock in TP4 decreased with depth from 7.1 in the surface water to 0.9 individuals m^{-3} in 40-50 m water depth. The size distribution in plankton tow TP1 was very constant. Most tests of *G. sacculifer* were found in the 150-250 μm size fraction. In the deepest tow section 40-50 m, the tests were observed between 150 μm and 315 μm . The test sizes of *G. sacculifer* in TP2 was between 150 μm and 500 μm and well distributed in the depth sections. Also, the test size of the individuals in tow TP3 covered nearly every size fraction between 125 μm and $> 500 \mu m$ down to 40 m water depth. A similar range of tests size was observed in TP4 (125-500 μm). In 40-50 m water depth, the tests of *G. sacculifer* in TP3 and TP4 were some larger and ranged between 250 μm and $> 500 \mu m$.

2.3.2.2. Cape Verde

Plankton tows in the vicinity of the Cape Verde Islands São Vicente and Santo Antão have been carried out in 10 m intervals down to 50 m water depth and one 20 m interval from 50 m to 70 m water depth. The vertical distribution in the several depth sections showed strong differences between the sampling days but also between the single depth sections (Fig. 2.13).

The first plankton tows on CV1 revealed with 4.4 to 7.9 individuals m^{-3} the lowest total standing stock of all samples. In contrast, the second tow sample CV2 yielded markedly higher population densities between 12.3 and 33.5 tests m^{-3} . On sampling day CV3, the minimum standing stock was 15 individuals m^{-3} , while the highest population density revealed 67 tests m^{-3} . A very steady standing stock was observed on sampling day CV4. In the upper 40 m of the water column, the standing stock ranged between 27.3 and 39.7 individuals m^{-3} . In the deepest tow section, the maximum standing stock with 66.6 tests m^{-3} was observed. A similar constant population density with depth was also seen on sampling day CV6. Here, the population density ranged from 20.3 to 31.8 individuals m^{-3} in all sections. Quite high population density was observed in tow samples CV7, which revealed a standing stock between 44.1 and 63.5 individuals m^{-3} .

The depth and size distribution of four major planktonic foraminiferal species show strong differences between the species and between the several depth sections (Fig. 2.14). The deep-dwelling and highly abundant species, *G. menardii* showed a strongly varying behavior in its depth distribution. On the first sampling day, *G. menardii* showed low population densities with nearly 0.9-1.8 individuals m^{-3} . The second sampling day, CV2, revealed a standing stock between 1.8 and 8.8 individuals m^{-3} . The highest population density was observed in 10-20 m and 30-50 m water depth. The specimen of *G. menardii* recovered on the third sampling day CV3 showed higher values with in general 3.5 to 11.9 individuals m^{-3} , and 44.1 individuals m^{-3} in depth section 40-50 m. By far, the highest standing stock was observed on the fourth sampling day CV4. In the upper 40 m of the water column, the standing stock was constant between 15.9 and 23.8 tests m^{-3} . In 50-70 m water depth the population density increased to 52.9 individuals m^{-3} . On the fifth sampling day CV5, bad weather and a spring tide deflected a straight vertical deployment, so these data were not considered. The population density decreased on the sixth sampling day (CV6) and varied between 1.9 and 7.9 individuals m^{-3} . The illustration of the tow sampling in 50-70 m water depth was omitted, because the flap of the Apstein-net did not close. Sampling day CV7 revealed with 1.8 to 7.1 individuals m^{-3} also a quite low population density in the upper 30 m of the water column. The size

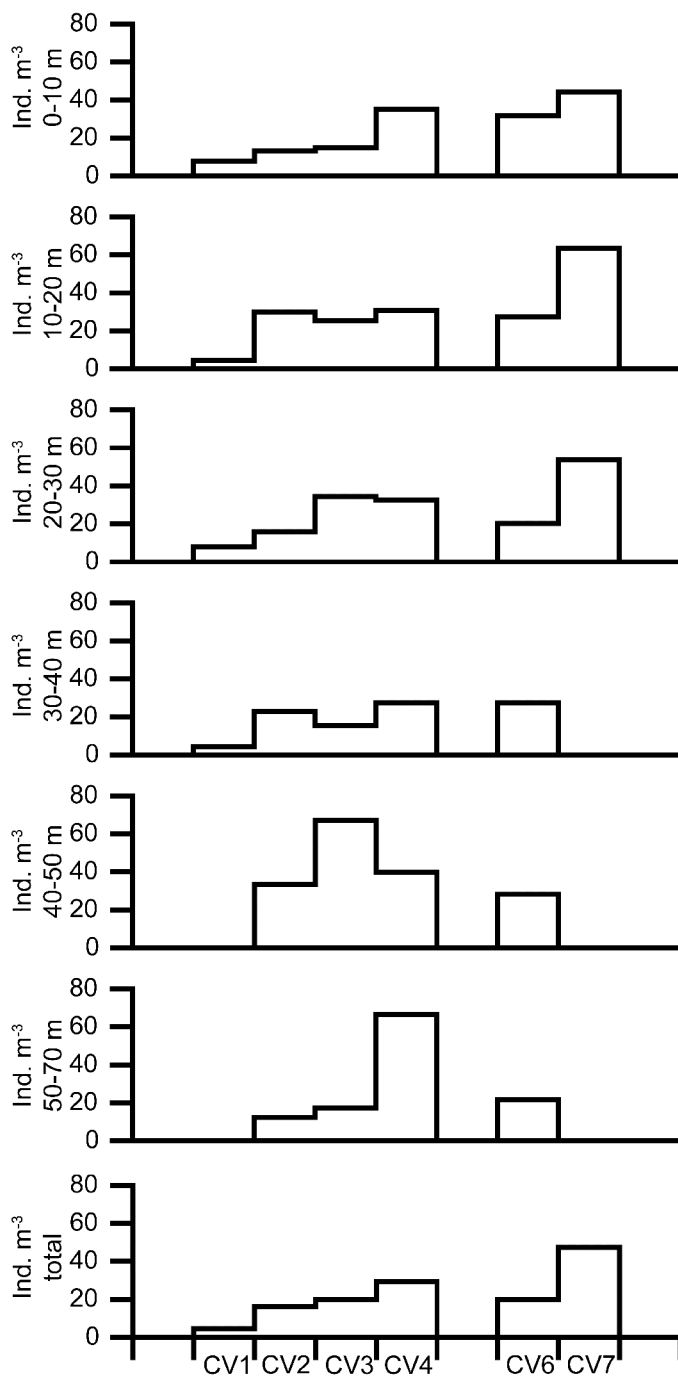

Fig. 2.13: Vertical distribution of planktonic foraminifera in the vicinity of the Cape Verde Islands. The samples CV1 was aborted after tow section 30-40 m, due to a destroyed catchment container.

between 0.6 and 2.6 tests m^{-3} . On sampling day CV4, *G. ruber* white was recovered only in the upper 20 m of the water column with a population density of 0.9 individuals m^{-3} in each section. The sixth sampling day bore a standing stock in a range of 0.9 to 7.1 tests m^{-3} , whereas most of the individuals were found in the upper 20 m of the water column. The highest population density of *G. ruber* white was observed on sampling day CV7 with 5.3 to 14.1 individuals m^{-3} . A large amount of *G. ruber* white tests was with 125-315 μm rather small, and showed a constant size distribution with depth.

distribution of *G. menardii* covered the entire range of size fractions analyzed. On CV2, small and large tests were found in the upper 70 m of the water column. On CV3, most of the tests were observed in size fraction larger than 315 μm . This observation was seen also in the upper 20 m of the water column on the next sampling day CV4. On this day, also smaller tests were detected in a water depth of 20-50 m. In the deeper tow section, many large tests were found. On the following two sampling days, large tests were found in general in every tow section, but in 30-40 m water depth also small individuals were observed.

The population densities of *G. ruber* white showed strong differences between the sampling days and the single tow sections. In contrast to *G. menardii*, *G. ruber* white represented much lower abundances. A maximum standing stock of 2.6 individuals m^{-3} was recovered on the first sampling day CV1 (Fig. 2.14). On the second sampling day, specimen of *G. ruber* white were observed in every tow section, in a range of 0.9 to 3.5 individuals m^{-3} . The third sampling day revealed no tests in 10 m and in 20-30 m of the water column. The other tow section yielded a low standing stock

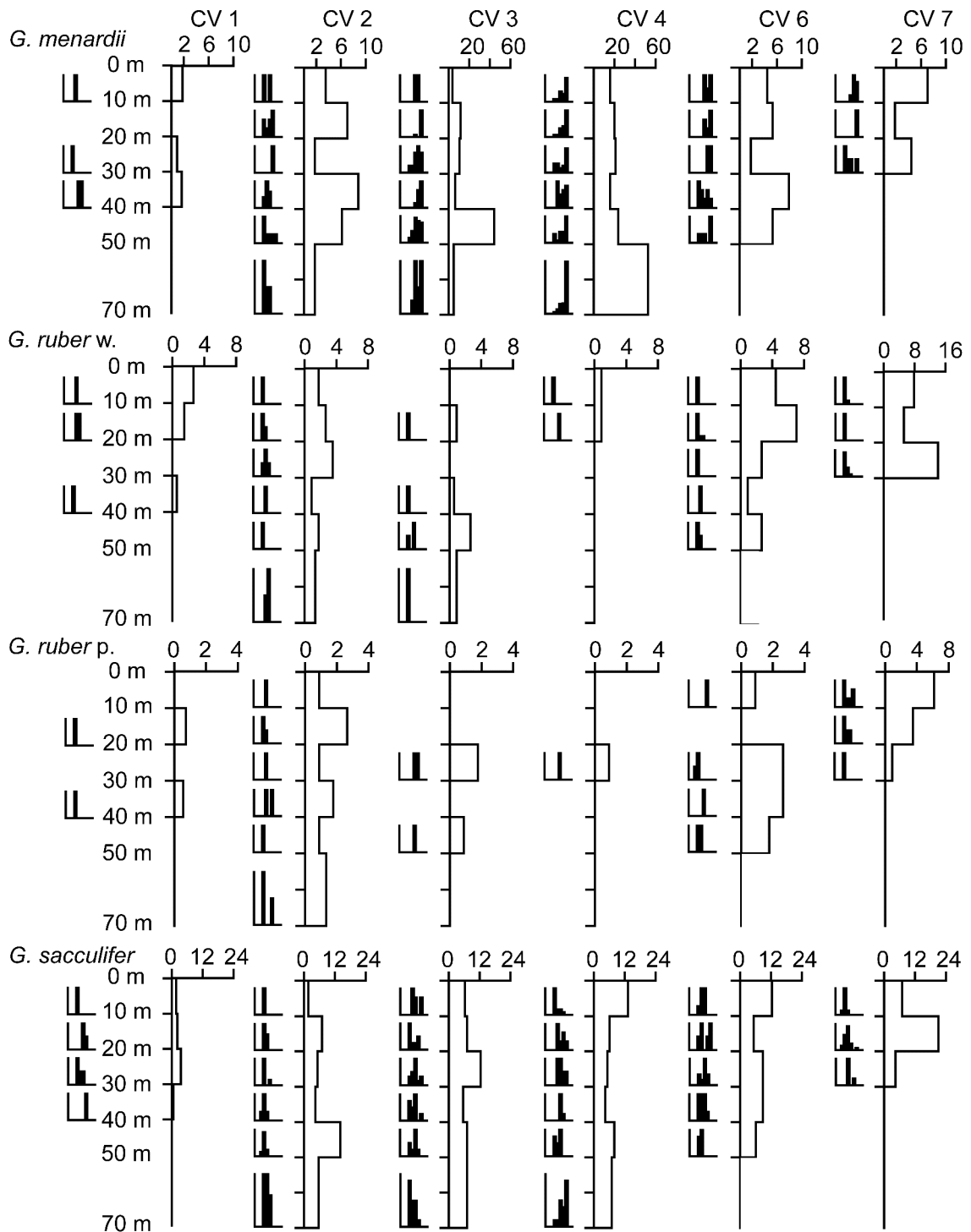

Fig. 2.14: Vertical distribution of four major planktonic foraminiferal species on six different days in the vicinity of the Cape Verde Islands São Vicente and Santo Antão in specimen m^{-3} . The size distribution [%] is given in the fractions 100-125 μm , 125-150 μm , 150-250 μm , 250-315 μm , 315-400 μm , 400-500 μm and >500 μm .

Globigerinoides ruber pink occurred only sporadically and with only low abundances. On the first sampling day CV1, *G. ruber* pink was recognized only in depth sections 10-20 m and 30-40 m with population densities of 0.6-0.7 individuals m^{-3} . The second sampling day revealed a standing stock of 0.9 to 2.6 individuals m^{-3} , whereas the highest density occurred in 10-20 m water depth. On sampling day CV3, *G. ruber* pink occurred only in two depth sections. In 20-30 m water depth, 1.8

individuals m^{-3} were recognized and in 40-50 m, 0.9 individuals m^{-3} were found. Only in one tow section, 20-30 m, 0.9 tests m^{-3} of *G. ruber* pink were caught on sampling day CV4. The sixth sampling day CV6 showed a standing stock between 0.9 and 2.6 individuals m^{-3} . A quite higher population density of 6.2 individuals m^{-3} was observed in the upper 10 m of the water column on sampling day CV7. In the following tow sections, 3.5 individuals m^{-3} and 0.9 tests m^{-3} were recognized. Most of these *G. ruber* pink individuals are smaller than 315 μm . Some larger tests were found on CV3, CV4, CV6 and CV7.

The planktonic foraminiferal species *G. sacculifer* occurred without exception in every tow sample. In contrast to the following sampling days, the population density showed on the first sampling day, with a maximum of 3.5 individuals m^{-3} the lowest standing stock of all. The minimum standing stock on the first sampling day was 0.6 tests m^{-3} . On the second sampling day, showed a low population density in the upper 10 m of the water column with 1.8 individuals m^{-3} . The population density in the following tow section varied between 4.4 and 14.1 individuals m^{-3} , whereas the highest population density occurred in 40-50 m water depth. The third sampling day showed a standing stock between 5.5 and 12.3 tests m^{-3} , though the highest population density occurred in 20-30 m water depth this time. On the fourth sampling day CV4, the maximum population density of 13.2 tests m^{-3} was observed the upper 10 m of the water column. Lower values between 4.4 and 7.9 individuals m^{-3} were found in the deeper tow sections. The sixth sampling day, yielded also a maximum population density of 12.3 tests m^{-3} in the upper 10 m and a range of 5.3 to 8.8 individuals m^{-3} in the following depth sections. On the last sampling day CV7, the maximum population density of 21.2 individuals m^{-3} was recovered from 10-20 m water depth. In contrast to this high population density, only 4.4 and 7.1 individuals m^{-3} were observed above and below. The first sampling day revealed tests in nearly every size fraction, while most of the tests in the second sample, are smaller than 315 μm . The test size distribution on sampling day CV3 covered nearly the entire range of size fraction in each depth section. On the fourth sampling day, smaller individuals were observed in the surface water, while more larger tests were observed in the deeper tow sections, especially in 50-70 m water depth. The last two sampling days revealed, again a large range of size fraction in each depth section.

2.3.3. CORE-TOP ANALYSIS

2.3.3.1. Central Atlantic

In the vicinity of the towing stations in the central tropical Atlantic, a core-top sample (TP3000) was recovered (Table 2.3, Fig. 2.1, inset). The faunal assemblage from this sample was compared to several other core-top samples from this area (Pflaumann 2002) (Fig. 2.15). The tow samples TP1-TP4 were added to the chart, because predominantly shallow living planktonic foraminiferal species, >150 μm were considered for comparison.

Table 2.4. List of core-top station and tow samples from 2008, as well as four GeoB core-top stations from GLAMAP 2000.

Station	Latitude	Longitude	Sampling year	Water depth [m]
TP3000	4°48.600S	12°22.300W	2008	3000
TP1	4°48.632S	12°22.354W	2008	*50
TP2	5°05.697S	11°39.961W	2008	*30
TP3	4°48.572S	12°22.450W	2008	*50
TP4	4°48.832S	12°22.661W	2008	*50
GeoB1407-7	4°19.698S	10°15.198W	1991	3520
GeoB1114-4	5°17.100S	10°12.198W	1989	3416
GeoB1113-4	5°44.700S	11°02.202W	1989	2374
GeoB1112-4	5°46.698S	10°45.000W	1989	3125

* maximum sampling depth

The proportion of *G. menardii* in the central tropical Atlantic did not show strong differences within the core-top samples with values between 5.4 – 8.3 %. The proportion of this species in the tow samples will not be considered, since *G. menardii* is commonly referred as a deep-dwelling

species and the tows reached only a water depth of 50 m. On the other hand, *G. glutinata* as a surface dweller differed strongly within the tow samples. The proportion of *G. glutinata* in the core-tops varied between 9.8 % and 12.2 %.

Omitting TP1, the other plankton tows showed similar values between 6 % and 15 %. Marked differences were observed in *G. ruber white*, when the core-tops showed very high proportions (>30 %), the core-top sample TP3000 and the plankton tows, on the other hand showed less than half of the proportions from GLAMAP samples. The proportion of *G. ruber pink* did not vary strongly within the core-top samples with values between 9 % and 13 %. The proportion of *G. ruber pink* in the plankton tows TP2, TP3 and TP4 showed quite higher values up to 19 %. The proportion of *G. sacculifer* showed quite higher values (24-51 %) in the plankton tows and the surface sediment of TP3000 than in the other core-tops (13-20 %).

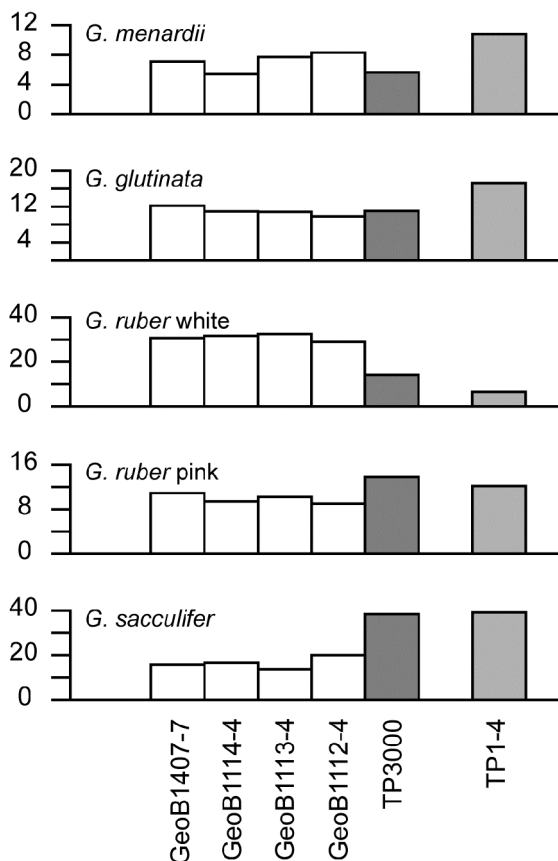

Fig. 2.15: Faunal composition of core-tops and combined plankton tows (light grey bar) in the central tropical Atlantic. The dark grey bar shows the 2008 recovered surface sample. The white bars mark the GeoB core-top samples from 1989 and 1991 (GLAMAP 2000).

2.3.3.2. Cape Verde

North of the plankton tows in the Cape Verde region, faunal assemblage data of two surface samples were retrieved from the GLAMAP data base (Table 2.5, Fig. 2.3). The comparison of five major planktonic foraminiferal species showed strong differences in the proportion of *G. menardii* and *G. ruber* white and minor differences in *G. ruber* pink and *G. sacculifer* (Fig. 2.16).

Table 2.5. Station list tow samples from 2008, and two core-top samples from GLAMAP 2000.

Station	Latitude	Longitude	Sampling year	Water depth [m]
CV1	n/a	n/a	2008	*40
CV2	16°51.986N	25°06.552W	2008	*70
CV3	16°52.003N	25°06.512W	2008	*70
CV4	16°52.491N	25°05.846W	2008	*70
CV6	n/a	n/a	2008	*70
CV7	16°52.335N	25°05.746W	2008	*30
MIKR02	18°23.988N	24°34.188W	n/a	3794
MIKS05	18°43.188N	25°21.000W	n/a	3830

* maximum sampling depth

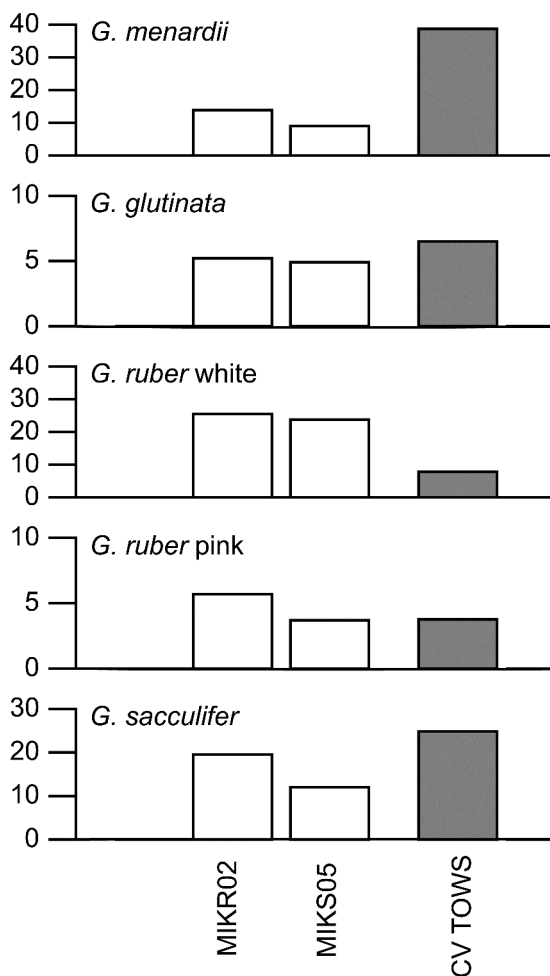

The comparison of *G. glutinata* did not show significant differences between the surface sediment samples and the tow samples. *Globorotalia menardii* is highly abundant in the tow samples and showed only 10-15 % in the surface samples from GLAMAP. On the other hand, *G. ruber* white was observed in a smaller proportion in the tow sample with 8 % and in higher proportions in the surface sample with approximately 25 %. The proportion of *G. ruber* pink was similar with approximately 4 % in the tow samples and in surface sample MIKS05. The other surface sample MIKR02 showed a slightly higher *G. ruber* pink proportion of 6 %. *Globigerinoides sacculifer* showed the highest proportion in the tow samples with 25 %. A proportion of 12 % and 20 % were found in the surface samples.

Fig. 2.16: Faunal composition of planktonic foraminifera from surface sediments in the vicinity of the Cape Verde Islands compared to our plankton tows. The core-top samples MIKR02 and MIKS05 were taken from GLAMAP 2000. Specimen (>150 µm) of all plankton tows (CV1 to CV7) have been combined.

2.4. DISCUSSION

2.4.1. SAMPLING INTERFERENCES

2.4.1.1. Pump sampling

The pump samples revealed strong differences in the distribution and abundance of planktonic foraminifera in the surface water of the open ocean. The pump samples, which were obtained from a small depth section at 5-7 m need detailed consideration. Is the daily varying abundance of planktonic foraminifera a species specific feature or an effect of sampling interferences?

At a first glance, the changing abundance of planktonic foraminifera in the surface waters can be attributed to salinity or temperature changes nor related to different current systems. The largest part of the study area is influenced by the SEC and temperature and salinity values differed only insignificantly between the morning and afternoon samples. Whether the SEUC and EUC at 80m and 100 m water depth, respectively, influence the abundance of planktonic foraminifera cannot be ruled out, but has to be considered. A direct comparison of plankton tows in 0-50 m and 50-100 m water depth of GeoB 1407-2 in April 1991 revealed a lower population density in the 50-100 m section than in the surface water (Kemle-von Mücke and Oberhänsli, 1999). Especially *G. sacculifer* and *G. ruber* white were much more abundant in the surface water than in 50-100 m depth.

Mesoscale variability like eddies, meandering currents or fronts are able to influence the abundance and assemblage composition of planktonic foraminifera (Lončarić, 2005; Schiebel et al., 1995), but they have not been detected in the study area. Comparisons between the planktonic foraminiferal abundance and the cruise speed of the vessel showed no covariance. The foraminiferal abundance is therefore not influenced by the cruise velocity on collection. Another focus was on the pump yield, but even this does not show any correlation to the changing abundances of planktonic foraminifera (Table 2.2). The consistency of the ante meridiem-post meridiem differences thus excludes a technical reason and raises the question of a daily vertical migration of planktonic foraminifera.

2.4.1.2. Daily vertical migration

The distinct ante meridiem-post meridiem distribution is recognized in most samples, but there are three exceptions. It may be supposed, that this pattern was caused by a daily vertical migration. Earliest studies assumed that the foraminiferal fauna of the surface water ascend in the morning and descend in the evening, because the abundance of planktonic foraminifera has been higher during the day than during nighttime (Rhumbler, 1911; Bradshaw, 1959; Bé and Hamlin, 1967). On the other hand, Boltovskoy (1964) concluded, that no daily vertical migration takes place in planktonic foraminifera in his study area (Boltovskoy 1964, figure 4). Recent observations lack any evidence that daily vertical migration of planktonic foraminifera takes place.

A possible reason for the am-pm difference may be food availability. The luminous exitance changes in the course of a day, and so the phytoplankton, and subsequently the symbiont-bearing planktonic foraminifera react on this change. Primary production by marine organism is depending on the spectral and angular distribution of underwater light (Herman and Platt, 1986; Agusti and

Philips, 1992; Llamas et al., 2009). Also it has been observed, that phytoplankton distribution is related to changes in light quality during a daily cycle. For instance, small phytoplankton maxima were found between 3 and 4 m water depth in the morning and high amounts of phytoplankton were observed at 5 m water depth at noon (Figueroa et al., 1994).

Another important fact is the high abundance of planktonic foraminifera in the afternoon on 20 January, shortly before full moon. A lunar influence can only be speculated due to the lack of detailed data on species distribution and the short sampling period. In this case, the hydrographic data should be taken into account. On the night before 20 January, the pycnocline was approximately 10 m deeper than during the days after full moon. Normally, higher wind speed or air-water temperature differences would deepen the pycnocline. Between 19 and 24 January, however, neither wind speed and direction nor temperature anomalies have been observed. It can not be excluded, that meteorological events (e.g., troughs, storms etc.) or internal waves occurred in some distance, influenced the vertical water structure and were carried to the study area by the SEC.

2.4.1.3. Tow sampling

Since physical properties of the oceans are a main driver for the distribution of planktonic foraminifera (e.g. Boltovskoy et al., 1999), the water masses of the tropical Atlantic are to be considered when regarding the fine-scaled vertical distribution in the upper 50 or 70 m of the water column. In this part of the discussion, parameters, which may influence the vertical distribution of planktonic foraminifera will be addressed. The planktonic foraminiferal fauna, which is to be discussed in detail below, can be influenced by eddies and upwelling conditions (Lončarić, 2005). Also, physical parameterizations, like equatorial Kelvin waves (Ripa and Hayes, 1981; Lukas et al., 1984) and internal waves may influence the vertical water structure in a way that planktonic foraminifera have to react on. When regarding the hydrographic data of the central Atlantic ocean, the mixed layer depth seems to be very constant at 30 m and only a small variability is seen in 30-50 m water depth.

South of the Cape Verde Island São Vicente, the mixed layer extended down to 65 m water depth. The float measurement followed not a straight vertical line and was deployed near to the shore. Nevertheless, we regard the measurements to reflect the situation in the channel, where the tow sampling was carried out, because of the good agreement between surface and CTD temperature and salinity.

Another influence may be the microphysical structure, which was formed during the slacking and hauling. Small turbulences may catch some individuals from outside the straight vertical haul. But since the sampling area is located in an ocean with currents, these micro-turbulences can be neglected. How much the ships drift influences the planktonic foraminiferal abundance or whether they are distributed patch-like in the water column, cannot be determined, and is an aspect for future three-dimensional surveys.

2.4.2. HISTORICAL CHANGES IN FAUNAL COMPOSITION

2.4.2.1. Central Atlantic

Bé and Tolderlund (1971), investigated the upper 10 m of the Atlantic Ocean. According to their maps, the southern part of our study area is characterized by a population density of 1-9 specimen m^{-3} . If we regard only the $> 200 \mu m$ tests of our 0-10 m section (tow samples TP1 – TP4), we find a population density of 9.04 tests m^{-3} , which is the same order of magnitude. In the region of the Atlantic Ocean where the pump samples RD27 and RD28 were obtained, Bé and Tolderlund (1971) describe a population density of 10-99 tests m^{-3} . In the pump samples RD27, we found 3 tests m^{-3} and in RD28 we found 2.3 tests m^{-3} , which were larger than $200 \mu m$. These numbers refer to a small section in the water column between 5 and 7m. As such, we have to assume, that the population density in the entire upper 10 m of this region would be slightly higher. Indeed, smaller planktonic foraminifera show much higher population densities in the uppermost ocean, in some cases more than 200 specimen m^{-3} like in pump sample RD18 and 19. Since the Apstein-net has a $100\text{-}\mu m$ mesh, we have to assume, that not only in a small section between 5-7 m water depth the abundance of small planktonic foraminifera ($<100 \mu m$) is high, but also in the entire upper water column.

The planktonic foraminiferal fauna in the upper part of the water column of the Atlantic ocean has been described in many studies (e.g. Schott, 1937; Bé and Tolderlund, 1971; Boltovskoy, 1973; Hemleben et al., 1989; Kemle-von Mücke et al., 1999; Boltovskoy, 1999). One of earliest plankton tows in the equatorial Atlantic have been carried out during “Deutsche Atlantische Expedition” with R.V. Meteor in 1925-1927. We compare to these data, because sampling stations were in the vicinity of our plankton tows and they were also performed in January. Though the samples were taken in other depth intervals and during a waning moon phase, we attempt a comparison to the foraminiferal fauna, found at that time (Table 2.6). In respect to changing taxonomy, we thought to simplify the table as followed. Schott described a proportion of 2-5 % of *G. bulloides* at his stations 245-247 and referred to Brady (1884, Plate 77 and 79, figures 1-7). He also referred the presence of *G. bulloides* at stations 245-247 to a cold-tongue of the SEC, which was described by Krümmel (1911). Since figure 5 on plate 77 of Brady (1884) indeed is a *G. ruber* white, we therefore compared our proportion of *G. ruber* white with proportions of Schott's ‘*G. bulloides*’. The species *Globigerina dubia* is equivalent to *N. dutertrei*. Schott referred to Brady (Plate 79, figure 11-16) when he described *Globigerinoides rubra*, which is indeed *G. ruber* pink (Jones 1994)

If we disregard the different mesh size, the different depth intervals at Schott's stations 245 and 246 and possible taxonomic inconsistencies, we can find similar proportions of the observed planktonic foraminifera *G. sacculifer*, *G. ruber* pink and *G. menardii* at station 246 and our samples. Our and Schott's samples were located within the SEC system, but we see lower SST values in 1927 than in 2008. Differences in the species proportions and abundances may be caused by different water temperatures, provided a correct taxonomic identification and no other changes in the physical parameters of the SEC.

Table 2.6. List of historical (1927) and recent (2008) planktonic foraminiferal assemblages in the tropical Atlantic Ocean.

Station	*245 2°8 S; 13°59 W	*246 2°40 S; 16°37 W	*247 3°7 S; 19°24 W	**TP 4°48 S 12°22 W	*270 17°1 N; 24°57 W	**CV 16°86 N; 25°06 W	
<i>G. ruber</i> white ¹ [%]	5	4	2	6	14	8	4
<i>G. dutertrei</i> ² [%]	5	6	0	0	0	4	3
<i>G. inflata</i> [%]	5	0	0	0	0	0	0
<i>Globigerinella</i> spp. ³ [%]	0	6	0	1	0	5	3
<i>G. ruber</i> pink ⁴ [%]	5	17	9	13	0	4	3
<i>G. sacculifer</i> ⁵ [%]	63	43	66	41	43	25	22
<i>G. menardii</i> [%]	0	13	22	10	14	35	53
<i>O. universa</i> [%]	5	13	2	3	29	3	6
<i>P. obliquiloculata</i> [%]	11	0	0	0	0	0	0
other [%]	0	0	0	26	0	17	7
Number of foraminifera	19	54	58	209	14	1143	267
Depth [m]	50-100	42-81	0-43	0-50	50-100	0-70	50-70
SST [°C]	25.00	25.30	25.70	27.08	20.80	24.73	24.73

*Meteor 1925-1927, Deutsche Atlantische Expedition; **combined tow samples from this study;

¹*Globigerina bulloides*, ²*Globigerina dubia*, ³*Globigerinella aequilateralis*, ⁴*Globigerinoides rubra*,

⁵*Globigerinoides sacculifera*, in Schott (1937)

Detailed studies of vertical distribution of planktonic foraminifera in 1964 in the western equatorial Atlantic (32°W-44°W; 8°S-10°N) revealed the highest population density between 30-50 m depth (Boltovskoy, 1964). Boltovskoy observed 21 different planktonic foraminiferal species, but the high population density mainly consisted of *G. ruber* and *G. trilobus* in the upper 25 m of the water column. Boltovskoy, (1964) did not differ between *G. ruber* white and pink and we did not distinguish between *G. trilobus* and *G. sacculifer*, so we may assimilate both datasets. Then it emerges, that Boltovskoy found only a small amount of *G. menardii* of 0.6 %, but we recorded a substantially higher proportion of 6.8 % *G. menardii* in the upper 20 m of the water column. This may be due to geographic differences or to different sampling times (January vs. March/April). Also, the proportion of *G. ruber* (white and pink) differs between 33.4 % (Boltovskoy, 1964) in 0-25 m depth and our calculation of 24.8 % as average of the upper 20 m of the water column. Therefore, it is more surprising that we found similar values in the abundance *G. sacculifer* including *G. trilobus*, when we regard the average abundance in the upper 20 m of the water column. Boltovskoy found a proportion of 43.4 % and we calculated a proportion of 42.4 %. Regarding the differences in the planktonic foraminiferal assemblage and abundance between 1964 and 2008, we have to consider the geographical distance, even the study area of Boltovskoy is mainly influenced by the eSEC and the nSEC.

Later studies by Kemle-von Mücke and others (1999 a,b) and Oberhänsli (1992) showed the vertical and horizontal distribution of planktonic foraminifera from tow samples obtained in the Southeast Atlantic in 1988. They recognized three hydrographic regimes, which are characterized by certain planktonic foraminiferal species. One is the South Equatorial Current Regime, which in general is characterized by a high foraminiferal standing stock (Kemle-von Mücke and Oberhänsli, 1999). At tow sample 1046 (7°20N and 20°28W) from March 1988, the most abundant species in the upper 25 m of the water column was *G. glutinata*, followed by *G. ruber* white and pink and *G. sacculifer* (Oberhänsli, 1992). In the water depth 25-50 m, the planktonic foraminiferal assemblage changed and the population density decreased. Still, *G. glutinata* was the most abundant species,

followed by *G. hirsuta* and *T. quinqueloba*. Though the tow sample from station 1046 and our tow samples are located in the SEC system, a comparison does show strong differences in the planktonic foraminiferal composition and abundance. The SST in April 1988 was with 25.7°C slightly lower than the SST in January 2008 as well as the SSS value, which was 0.3-0.5 higher in 1988 than in 2008. These differences may influence the planktonic foraminiferal assemblage and their population density. Also, it can not be excluded that the hydrographic parameters were influenced by a seasonal or mesoscale variability.

Comparisons of our tow samples with GLAMAP surface samples showed some differences (Fig. 2.15). In general, the comparison of plankton tows and surface samples is difficult, because of bioturbation, changing sedimentation rates, and dissolution in the water column. In this case, the ocean bottom is a very young magmatic ground. If we omit plankton tow TP1, the abundance of *G. menardii* and *G. glutinata* do not show distinct differences. Also, our surface sample TP3000 does not reveal different species abundances than the GLAMAP surface samples, but *G. ruber* white and *G. menardii* discriminate. Our surface sample and plankton tows show similar species proportions, which leads to the assumption that some planktonic foraminiferal species changed in abundance within the last decades, in particular *G. ruber* white and *G. sacculifer*.

2.4.2.2. Cape Verde

One plankton tow (270) in the vicinity of the Cape Verde Islands has been carried out on 2 March 1927. The most abundant planktonic foraminiferal species was *G. sacculifer*, followed by *Orbulina universa* and *G. ruber* white as well as *G. menardii* in 50-100 m water depth in 1927 (Table 2.6). Thus, the planktonic foraminiferal assemblage differed strongly between 1927 and 2008. These differences maybe depend on seasonal influences. In the northeast Atlantic Ocean and Cariaco Basin, planktonic foraminifera reveal a strong seasonal signal (Tedesco and Thunnell, 2003; Retailleau et al., 2009; Harbers et al., 2010). One aspect is the SST, which was 4°C colder in March 1927 than in June 2008. Satellite images (NEODAAS, MODIS AQUA, 11 µm) revealed an approximate SST of 23°C on 2 March 2008, which therefore is 2°C warmer than in March 1927. In contrast, the global temperature raised 0.6°C since 1927 (<http://data.giss.nasa.gov/gistemp>).

However, one remarkable difference is, that the abundance of *G. menardii* in 1927 is similar to the proportion in the surface samples of GLAMAP. In contrast, the very high population density of *G. menardii* in 2008 is probably caused by a short term variability or their still unknown reproduction cycle. Another strong difference is the absence of *G. glutinata* and *G. ruber* pink in March 1927, though species these have a very steady abundance in the surface sample and the plankton tows in 2008. Since we could not observe any other similarities between the GLAMAP data and the recent plankton tows, we assume, that differences between the plankton tows and the surface samples are influenced by their geographical setting. Eventually, the differences between the plankton tows and the northern surface samples are due to changing current speeds, eddies or filaments, which were described by Johnson and Stevens (2000).

2.5. CONCLUSION

The waters of the tropical Atlantic Ocean bear a lot of characteristics, which could influence the abundance and composition of planktonic foraminifera. In this case, neither mesoscale variability like eddies, meandering currents or fronts nor meteorological events were detected.

A daily vertical migration has been suggested or declined in several former studies. We see in the pump samples a recurrence of a distinct ante meridiem-post meridiem distribution nearly every day. However, we can exclude systematic variations in ship operations. Thus, we conclude, that most planktonic foraminifera follow the phytoplankton migration, which is influenced by light quality and intensity. But, some planktonic foraminiferal species migrate vertically during their reproduction cycle. Thus, we cannot entirely exclude that the observed vertical migration reflects their nutrition strategy. Especially the vertical distribution of the pump sample RD18 on 20 January as well as the high abundance of *G. menardii* in tow sample CV4 may be caused by lunar influence, in particular by tidal effects.

Comparisons to results of investigations 80 years ago reveal a distinct historical change in planktonic foraminiferal composition and abundance. Despite some taxonomic ambiguity, we clearly see historical changes, especially in paleoceanographic and stratigraphic important species like *G. menardii*, *G. sacculifer* and *G. ruber* white. Interestingly, these changes are coupled with surface water temperature increase of approximately 2°C, while the global temperature raised about 0.6°C. Comparisons of recent plankton tows to core-tops and tows of the past decades reveal a substantial decrease in abundance of *G. ruber* white during the past decades. Thus, we may assume, that planktonic foraminifera, in particular *G. ruber* white, are affected by global warming in the tropical Atlantic.

Chemical characteristics of recent planktonic foraminifera in the Atlantic Ocean – a LA - ICP - MS study

ABSTRACT

Planktonic foraminifera from the Atlantic Ocean were analyzed by laser ablation inductively coupled plasma mass spectrometry in order to investigate species-specific chemical characteristics. Stable isotope measurements were performed on the same samples in order to gain new insight in the use of planktonic foraminifera as temperature proxies. The laser ablation revealed strong variations of chemical composition in species, specimens and chambers. Despite higher B/Ca and Ba/Ca ratios compared to other studies, the data infer that non-spinose species incorporate more barium than spinose species and that symbiont-bearing foraminifera show higher $\delta^{11}\text{B}$ values compared to symbiont-barren foraminifera. U/Ca ratios in intermediate living species show higher values in the plankton tow sample than in the core-top sample, whereas the surface dwelling species revealed a higher U/Ca in the core-top sample. The difference may be due to post-depositional changes or species-specific offsets. Calculation of calcification temperatures using in situ $\delta^{18}\text{O}_w$ revealed 0.5°C and 2.6°C higher temperatures for *G. menardii* and *G. sacculifer* following established paleotemperature equations. The results imply that the equations fit for surface dwelling species from core-tops but not for living specimens. Comparing the new tow data with the calcification data sets of the established equations, the new results depicted a much higher accuracy over the high-temperature range of tropical Oceans.

3.1. INTRODUCTION

Planktonic foraminifera are major carbonate producers and contribute substantially to the fossil record (Milliman, 1993; Schiebel, 2002). They are of high ecologic and paleoceanographic significance. They are used in studies as proxies and their tests are reliable geochemical signal carrier (Berger, 1971; Erez, 1983; Kroon and Ganssen, 1989; Nürnberg et al., 1996; Mulitza et al., 1997). One of the most important tools for the reconstruction of ancient seawater temperature is the Mg/Ca ratio in planktonic foraminiferal tests. (Nürnberg et al., 1996; Elderfield and Ganssen, 2000; Anand et. al., 2003; Eggins et al., 2003; Sadekov et al., 2009). Furthermore, the shells of planktonic foraminifera bear substantial information about its ambient seawater. Thus, proxies like $\delta^{13}\text{C}$, $\delta^{18}\text{O}$, B/Ca, Ba/Ca, Sr/Ca, U/Ca in foraminiferal shells have become an important tool for the reconstruction of seawater chemistry (Lea and Boyle, 1991; Sanyal et al., 1996; Lea, 1999; Hathorne et al., 2003; Mulitza et al., 2003; Lončarić, 2005; Mortyn et al., 2005; Ni et al., 2007; Yu et al., 2007,2008; Cléroux et al., 2008; Regenberg et al., 2009; Steph et al., 2009; Wilke et al., 2009; Katz et al., 2010; Regenberg et al., 2010). The mineralization of a planktonic foraminiferal shell is not a simple procedure and includes some unpredictable aspects. One of them is the so-called vital effect, which varies with species and shell size (Elderfield et al., 2002; Hönisch et al., 2003; Hathorne and James, 2006; Ni et al., 2007).

Variations in Mg/Ca were explained by the vertical migration of planktonic foraminifera, but newer studies (Eggins et al., 2004; Anand and Elderfield, 2005) do not support this explanation, because the range of Mg/Ca is too large (~1 to 10 mmol/mol). In contrary, the range of Sr/Ca is much smaller as compared to other elements (Eggins et al., 2004; Anand and Elderfield, 2005).

In this study we investigated the chemical composition of the three youngest chambers of several floating and deposited planktonic foraminiferal species in order to demonstrate the variability with species and geographical origin. Another focus of our study was to better constrain the understanding of temperature reconstructions from foraminiferal shells.

3.2. MATERIALS AND METHODS

Our study includes chemical analyses of living and dead planktonic foraminifera from three parts of the Atlantic Ocean (Fig. 3.1). The chemical analyses were conducted on several planktonic foraminiferal species of temperate, sub-tropical and tropical water.

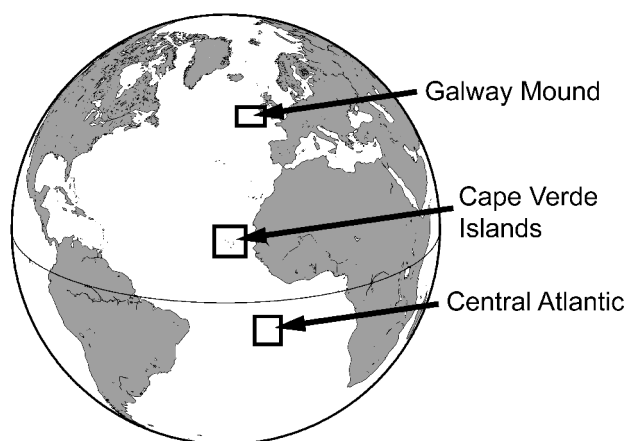

Fig. 3.1: Study areas in the Atlantic Ocean.

3.2.1. PLANKTON SAMPLES

3.2.1.1. *Porcupine Seabight*

A long-term deep-sea observatory (DOS, GEOMAR Modular Lander, Fig. B) was deployed in a coral thicket on the north-western flank of Galway Mound at station M61/1-245 (51°27.28N, 11°43.23W) in 806 m water depth between April and August 2004. Samples were obtained with 13 cups attached to the lander, sampling for 8 days each. The upper opening was located 2.75 m above the seabed. The cups were filled with artificial sea water with a salinity twice as high as in the near-bottom water. Mercury chloride (HgCl₂) was added to prevent biotic activity in the sampling cups, in particular to inhibit bacterial growth and the decay of labile organic substance.

Sediment surface samples were obtained on top of Galway Mound, approximately 400 m to the south of the DOS station M61/1-245 with a Giant Box Corer (GKG) during Meteor cruise M61/3 in June 2004 at station M61/3-552 (51°27.04N, 11°45.12W). A surface sample of 10 cm³ was taken from the 0-1.5 cm interval with a cut-off syringe.

3.2.1.2. *Tropical Atlantic*

Hand-hauled plankton tows were carried out on ten cruises with R/V Sinagoga between the Islands São Vicente and Santo Antão in June 2008 (Fig. 2.3). We used plankton tows with an 100µm Apstein-net and deployed it down to 70 m water depth. Onboard, the samples were conserved with 98 % ethanol for further analyses.

Eighteen tow samples were taken on 4 days during R/V Atalante cruise 2008/2, MARSUED IV, Leg 2 (former MSM 06/3) with an Apstein net with a 100 µm mesh and an aperture of 17 cm. We conducted 10 m hauls down to 50 m water depth. The samples were rinsed with fresh water

and conserved with 98 % ethanol. One surface sediment sample (TP3000) was taken from a crack of fresh Mid Ocean Ridge basalt recovered near the Wideawake hydrothermal field with the Remotely Operated Vehicle (ROV) 6000 Kiel, approximately 3000 m below the tow samples (Fig. 2.1). The basalt is considered to be only few years old (Melchert and Paulick, 2008).

3.2.2. TAXONOMY

The planktonic foraminiferal species were determined after Hemleben et al. (1989), Saito et al. (1981) and Bé (1977). Following Darling et al. (2006), we use the name *Neogloboquadrina incompta* instead of *Neogloboquadrina pachyderma* dextral. Discussions with E. Kandiano, K. Brown (IFM-GEOMAR), and M. Chapman (University of East Anglia), supported our taxonomic concept. Representative specimen of the most frequent species were photographed with a CAM SCAN CS 44 in the Institute for Geosciences at Kiel University. Samples were prepared with sputter device Emitech K550 (Au+Pd).

3.2.3. HYDROGRAPHIC DATA

Temperature and salinity data were acquainted during Meteor cruises M61/1, M61/3 and Poseidon cruise PO316 around Galway Mound. The hydrocasts were complemented by continuous sea surface temperature (SST) and weekly median chlorophyll data from satellite images in 2004, Advanced Very High Resolution Radiometer (AVHRR) and Sea-viewing Wide Field-of-view Sensor (SeaWiFS) from NERC Earth Observation Data Acquisition and Analysis Service (NEODAAS).

During MARSUED IV, several CTD measurements were performed with a Sea-Bird Electronics, Inc. SBE 911plus system with a precision of $\pm 0.001^\circ\text{C}$. The data of surface temperature and salinity were measured with the ship's thermosalinograph. The CTD data were provided by C. Martens from Bremen University.

Water samples for isotopic analysis were taken once a day between 14 January 2008 and 29 January 2008. Seawater was collected with the water pump right before or immediately after the plankton samplings and was stored in 100 ml bottles. Selected samples were intoxicated with Mercury Chloride (HgCl_2) solution to stop bacterial activity.

The CTD data during the research visit on the Cape Verde Island São Vicente was obtained with a Nemo-CO₂ Profiling Float (Prototype), (precision $\pm 0.002^\circ\text{C}$), Optimare AG, Bremerhaven, Germany. The CTD data were provided by B. Fiedler, IFM-GEOMAR, Kiel. In situ surface temperature and salinity was obtained with the WTW conductivity meter LF320. Temperature and salinity data from CTD measurements have been calculated to density after Fofonoff and Millard (1983).

3.2.4. SAMPLE PREPARATION

3.2.4.1. Porcupine Seabight

The trap samples were stored under cool conditions, split, and analyzed first for their organic chemical inventory, which consumed the whole sample TF3. The remaining trap samples were rinsed three times with fresh water to desalinate. In a first attempt we used ammonia buffered distilled water with a pH of 8.2, to prevent corrosion of foraminiferal shells. The buffered water and

the sample formed a white $\text{Hg}(\text{NH}_2)\text{Cl}$ precipitate, which is insoluble in cold water. For this reason we changed to carbonate-saturated water for desalination, and washed the samples carefully through a 63 μm mesh. The residues were dried on filter paper at 50°C and afterwards fractionated with 630 μm , 500 μm , 400 μm , 315 μm , 250 μm , 150 μm and 125 μm sieves.

The surface sample was freeze-dried, weighed, soaked with water, and washed through a 63 μm screen. Just as the trap samples, the surface sample was fractionated with 630 μm , 500 μm , 400 μm , 315 μm , 250 μm , 150 μm and 125 μm sieves.

For chemical analysis, specimens of *Globigerina bulloides*, *Globigerinita glutinata*, *Globorotalia inflata*, *Globorotalia hirsuta*, and *Neogloboquadrina incompta* were selected from different size fractions (Appendix 3). We chose specimens without visible coatings, as far as possible to recognize under microscope. The specimens were cleaned and adhered to adhesive tape for laser ablation or were used for $\delta^{13}\text{C}$ and $\delta^{18}\text{O}$ measurements.

3.2.4.2. Tropical Atlantic

The net samples from the Central Atlantic and the Cape Verde area were wet picked and dried at room temperature. To remove the protoplasm of the planktonic foraminifera, the specimens were cleaned with H_2O_2 (3 %) solution and rinsed with ethanol. Dry specimens of *Globigerina bulloides*, *Globigerinoides ruber* pink, *Globigerinoides sacculifer*, *Globorotalia crassaformis*, *Globorotalia inflata*, *Globorotalia menardii*, *Neogloboquadrina dutertrei*, and *Neogloboquadrina incompta* were adhered to adhesive tape for laser ablation (Appendix 4). Some specimens were also used for $\delta^{13}\text{C}$ and $\delta^{18}\text{O}$ measurements.

3.2.4.3. Cleaning procedure

The first step in this cleaning procedure was the mechanical removal of clay particles from the tests. For this, 500 μl vials filled with ethanol and single foraminifera were put into an ultrasonic bath. To avoid crashes, only one foraminifera was put into a vial. The samples for the stable isotope measurements were crushed between two glass plates and transferred into the vials. After this procedure, the ethanol was removed and new ethanol was added and resisted for 5 minutes in the vials to remove lipids. Again, the ethanol was removed and 250 μl of a 3 % H_2O_2 solution (H_2O_2 + NaOH (0.1 mol)) was added to remove the organic material. The vials were now put into a hot water bath for 15 minutes. During this 15 minutes the rack with the vials was shaken every 3 minutes to prevent bubble formation around the tests. The hot water bath was carried out a second time with new H_2O_2 solution. At the end of the cleaning procedure, the solution was removed and the foraminifera were rinsed with ethanol three times and dried at room temperature.

3.2.5. CHEMICAL ANALYSES

3.2.5.1. Laser ablation

Laser ablation (LA) was performed at the department of Geosciences at Bremen University with a New Wave UP193 nm Nd/YAG Solid State Laser Ablation System and a Thermo-Finnigan Element 2 sector field inductively coupled plasma mass spectrometer (ICP-MS). Larger coatings, manganese overgrowth and other contaminations on the test and even within the pores, which

could not be removed by the cleaning, were detected by a camera attached to the laser system. The recognition depended on color and size of contamination.

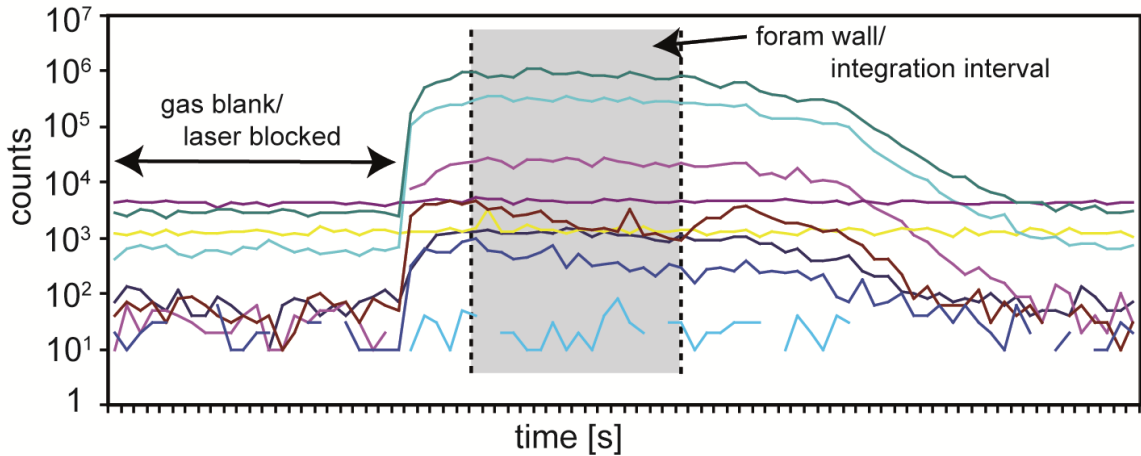

Fig. 3.2: A typical measurement process of a final chamber of *G. sacculifer* (CV 4, 0-10m, June 2008). One entire measurement last at least 2 minutes. The lines indicate different elements.

Several elemental isotopes, like ¹¹B, ²⁵Mg, ²⁷Al, ⁴³Ca, ⁵⁵Mn, ⁶⁶Zn, ⁸⁸Sr, ¹³⁷Ba, and ²³⁸U were measured with the LA-ICP-MS system (Fig. 3.2). Laser operations were conducted with a power of 2.6-3.0 J/cm² and a repetition rate of 5 Hz. As far as possible, we shoot two holes with an average diameter of 50 μm in the final three chambers of each foraminiferal test. After shooting 10-12 foraminiferal holes, we used to ablate 2 times a NIST 610 (75 μm laser diameter) standard for calibration and data processing. The internal standard was ⁴³Ca. Data reduction was carried out using the GEOPRO software. For the presentation in the figures 3.3 – 3.10, the two holes of each chamber were averaged. Raw data are given in Appendix 3.

3.2.5.2. Stable isotopes $\delta^{13}\text{C}$ and $\delta^{18}\text{O}$

The isotope measurements were conducted at the Leibniz Laboratory for Radiometry Dating and Stable Isotope Research. The stable isotope measurements were performed with a Finnigan MAT 251 mass spectrometer with a Kiel 1 prototype preparation device.

For the calculation of calcification temperature (T_C), we applied the equations of Shackleton (1974),

$$T_C = 16.9 - 4.38 (\delta^{18}\text{O}_C - \delta^{18}\text{O}_W) + 0.1 (\delta^{18}\text{O}_C - \delta^{18}\text{O}_W)^2 \quad (1)$$

and Bemis (1998),

$$T_C = 15.7 - 4.46 (\delta^{18}\text{O}_C - \delta^{18}\text{O}_W) + 0.35 (\delta^{18}\text{O}_C - \delta^{18}\text{O}_W)^2 \quad (2)$$

The O_C values are $\delta^{18}\text{O}$ isotope ratios of planktonic foraminiferal carbonate, which were obtained from different species, and the values are an average of 3-7 specimens (Table 3.1). The $\delta^{18}\text{O}_W$ values were measured from surface seawater and have been transferred from Standard Mean Ocean Water (SMOW) scale to calcite on the Peedee Belemnite (PDB) scale by subtracting 0.27 ‰ (Hut, 1987).

Table 3.1. Calcification temperature [T_C] calculated after Shackleton and Bemis, and by using measured in situ δ¹⁸O_w.

	Location	n	weight [μg]	δ ¹⁸ O _w	δ ¹⁸ O _c	T in situ [°C]	T _C Shackleton [°C]	T _C Bemis [°C]
<i>G. menardii</i>	CV 4 0-10m	6	36	0,57	-1,35	25,02	25,66	25,53
	CV 7 0-10m	6	30	0,58	-1,27	25,02	25,36	25,16
	TP 3 30-40m	5	94	0,48	-1,72	26,33	26,99	27,17
	CV 4 50-70m	6	119	0,57	-1,08	24,05	24,40	24,01
	CV 4 50-70m	7	133	0,57	-1,07	24,05	24,33	23,94
	TSP	7	486	0,48	0,52		16,72	15,52
<i>G. sacculifer</i>	TP 4 0-10m	3	5,8	0,49	-2,44	26,76	30,56	31,73
	CV 3 20-30m	4	11	0,59	-1,51	24,67	26,56	26,64
	TP 3 40-50m	4	45	0,48	-2,11	26,16	28,89	29,56
	CV 4 50-70m	4	54	0,57	-1,45	24,05	26,15	26,13
	TSP	5	273	0,48	-1,44		25,63	25,50

n = number of specimen

3.3. RESULTS

3.3.1. CHEMICAL COMPOSITION OF PLANKTONIC FORAMINIFERAL SPECIES

Element/Ca ratios in the last three chambers of eight planktonic foraminiferal species are presented in figures 3.3 – 3.10, average data is shown in Table 3.2. We concentrated on magnesium, boron, barium and uranium. The aluminium and manganese contents are given as comparison to reveal possible coatings or contaminations.

Five different specimens of the surface dwelling planktonic foraminifera *G. sacculifer* were ablated. Only the specimen from the surface sediment sample, (TP3000) showed a slightly contamination of manganese and aluminium in the youngest chamber (F). Another strong difference is seen in the Ba/Ca ratio. The barium content increased through the last three chambers of the sedimentary *G. sacculifer*, while a decrease of barium can be observed in the living specimen of *G. sacculifer*. The living specimens of the Cape Verde region revealed a contrary pattern regarding the Mg/Ca ratio. One specimen showed a decrease, the other an increase through the last three chambers (Fig. 3.3).

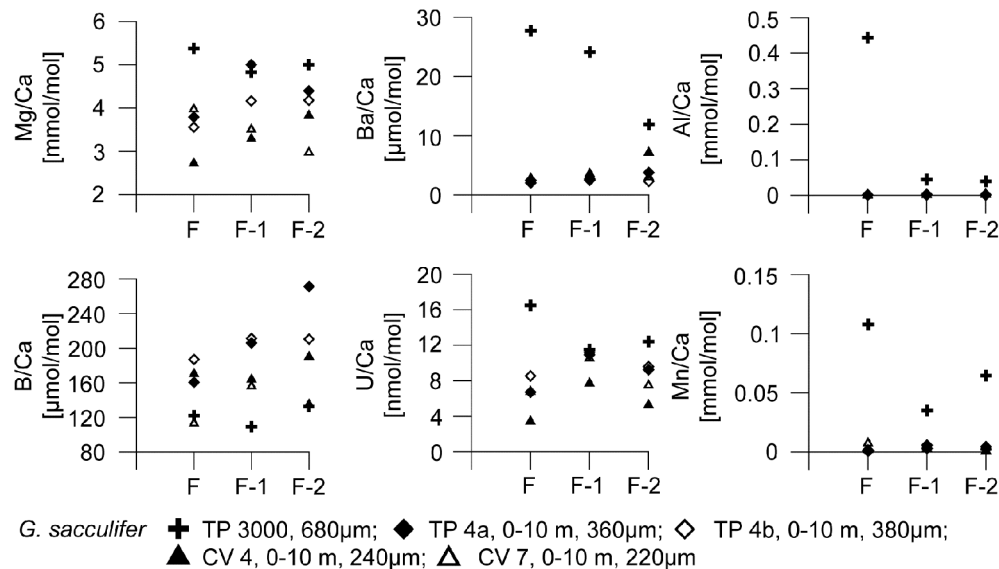

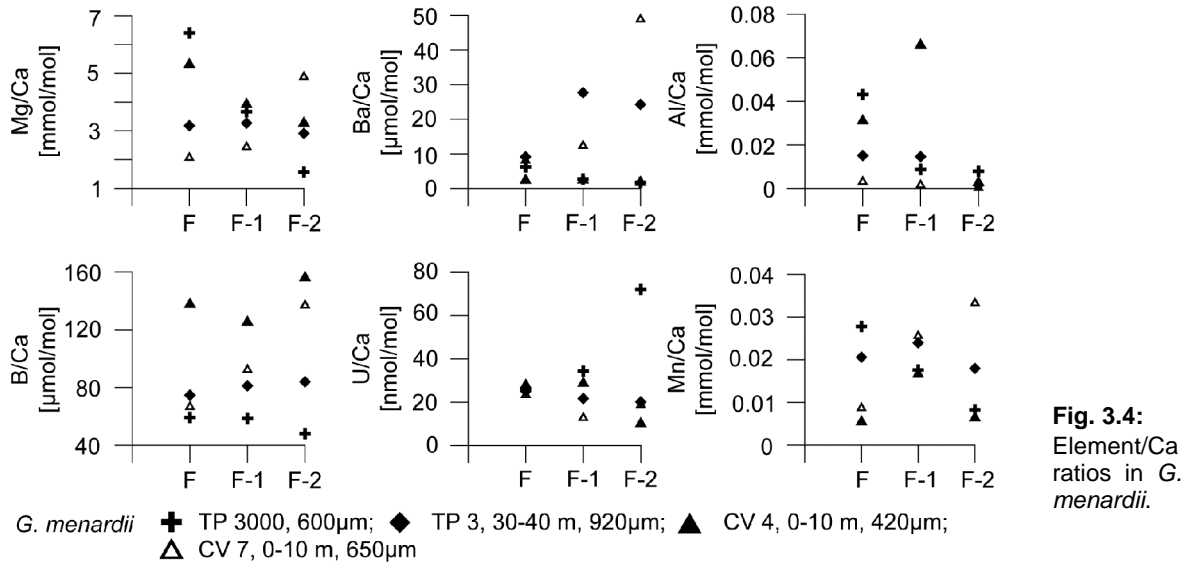

Fig. 3.4: Element/Ca ratios in *G. menardii*.

Neither the living, nor the sedimentary specimens of the intermediate dwelling *G. menardii* showed a significant aluminium and manganese contamination. The two living specimens of *G. menardii* (CV4 and CV7) in the Cape Verde region revealed also a distinct pattern regarding the Mg/Ca ratio. In contrary to *G. sacculifer*, one specimen decreased, the other increased its magnesium content through the last three chambers. Another important observation is the enrichment of barium in the pre-final chambers of two living tropical *G. menardii* (Fig. 3.4).

The sedimentary specimens of the deep dwelling planktonic foraminifera *G. crassaformis* and the intermediate living *N. dutertrei* do not show a significant aluminium and manganese contamination. In comparison to most of the other planktonic foraminifera analyzed, these specimens exhibited lower ratios of all elements measured, above all, in boron (Fig. 3.5 and 3.6).

Furthermore, two specimens of surface-dwelling *G. ruber* pink were analyzed by LA-ICP-MS. The element/Ca ratios of the living specimens showed lower values than the sedimentary specimen, except in the boron of its pre-final chamber (Fig. 3.7).

Another deep-dwelling species, *G. hirsuta* revealed also a very low content of manganese and aluminium. Their element contents cover a large range of values (Fig. 3.8). The distribution of elements in the same chamber of different specimens displayed a similar pattern, especially in boron. Like the boron content in *G. crassaformis* and *N. dutertrei*, the values in *G. hirsuta* are also lower than in the surface-dwelling foraminifera.

The boron content of the species that were only found in the North Atlantic, *N. incompta* and *G. bulloides*, showed also lower values, with the exception of the sediment surface sample of *G. bulloides* (Fig. 3.9). In particular, the surface samples of both, *G. bulloides* and *N. incompta* (Fig. 3.10) are highly enriched in aluminium and manganese. Furthermore, these two species showed a very low content in barium.

The Mg/Ca ratios of all species vary over a large range of values between 0.67 mmol/mol in the deposited specimen of *N. dutertrei* and 10.6 mmol/mol in the deposited, but also contaminated specimen of *G. bulloides*. The Mg/Ca ratios of living specimen vary between 0.97 mmol/mol in *G. hirsuta* and 6.57 mmol/mol in *N. dutertrei* (Appendix 3).

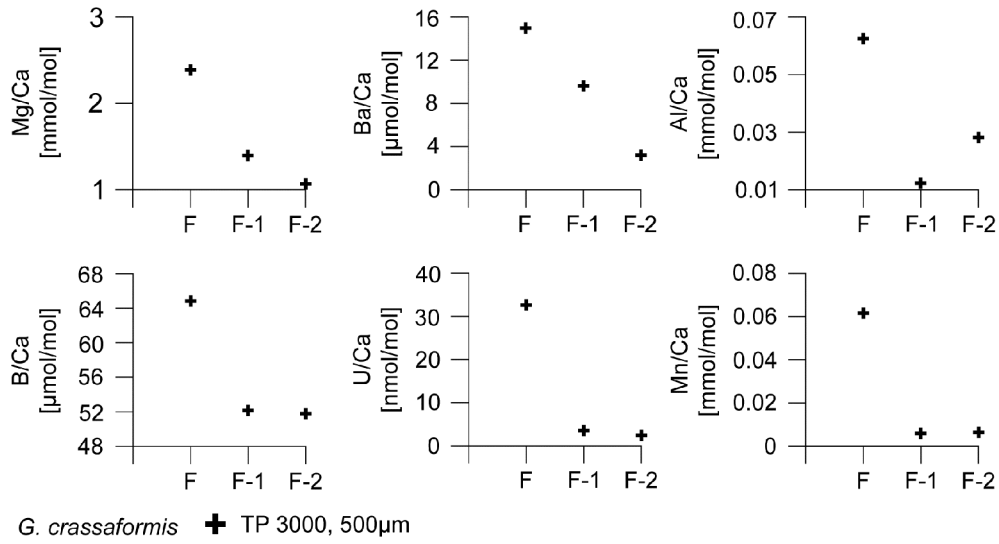

Fig. 3.5: Element/Ca ratios in *G. crassaformis*.

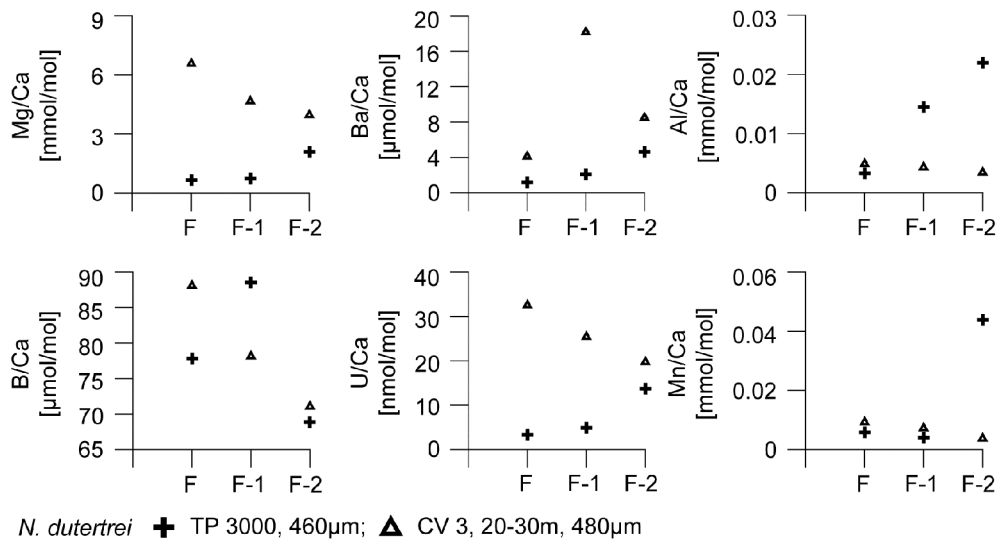

Fig. 3.6: Element/Ca ratios in *N. dutertrei*.

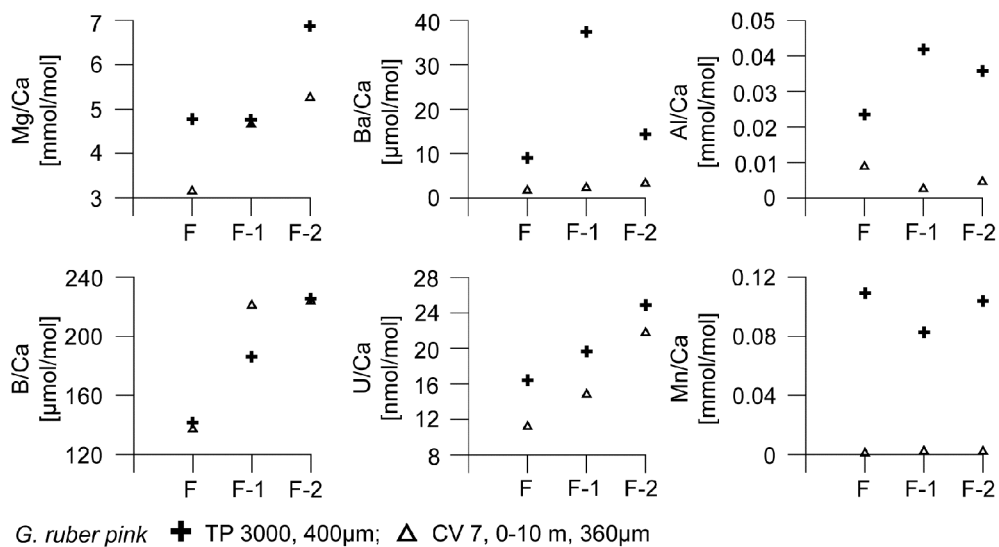

Fig. 3.7: Element/Ca ratios in *G. ruber pink*.

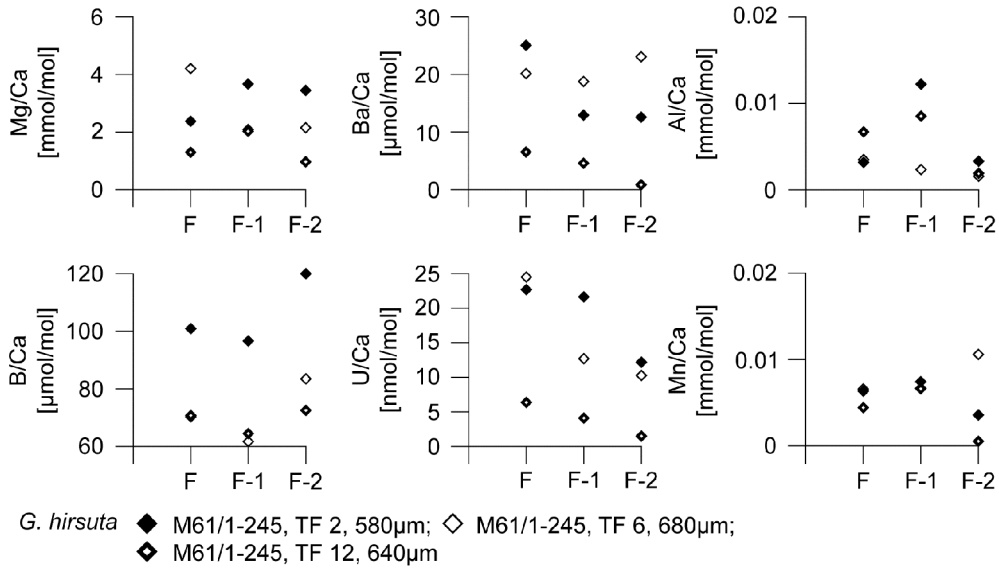

Fig. 3.8: Element/Ca ratios in *G. hirsuta*.

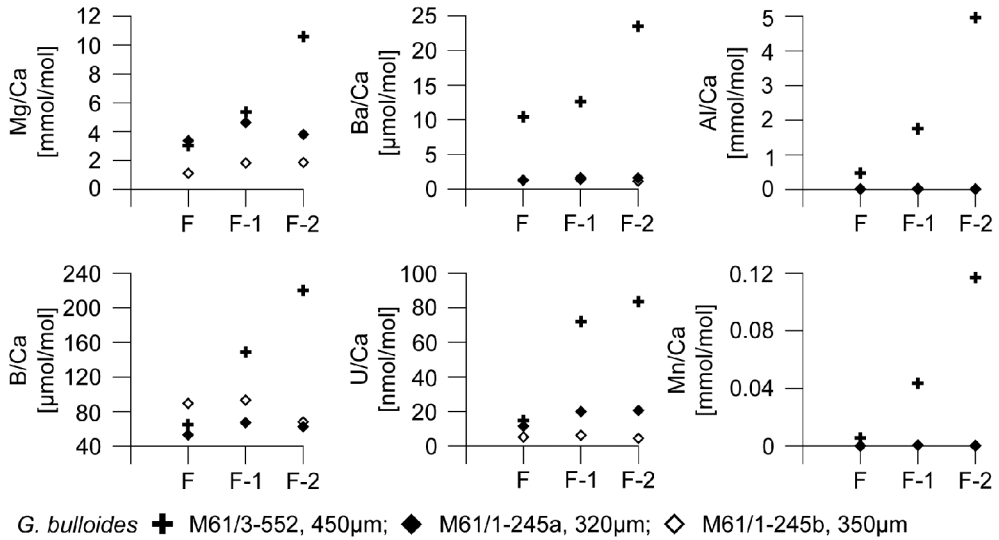

Fig. 3.9: Element/Ca ratios in *G. bulloides*.

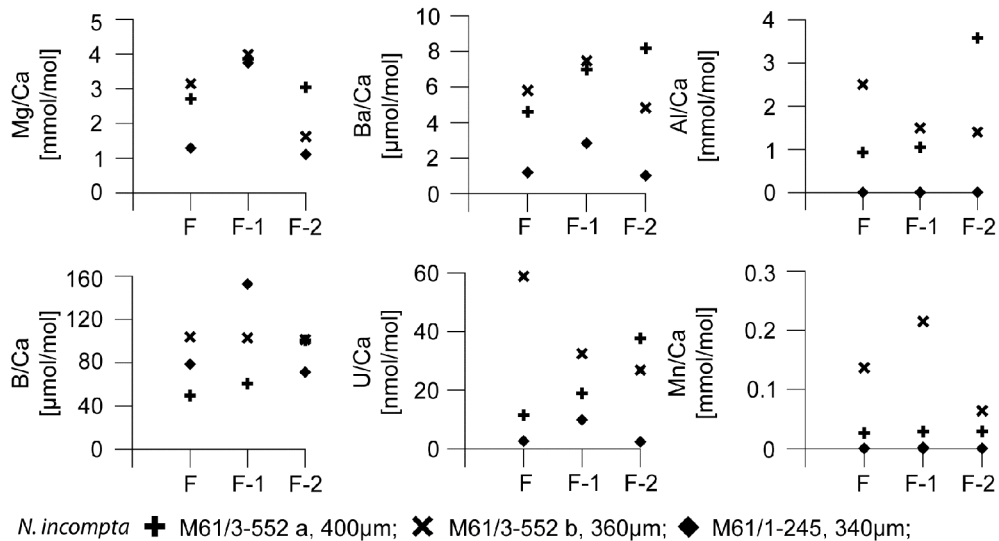

Fig. 3.10: Element/Ca ratios in *N. incompta*.

3.3.2. G. SACCULIFER AND G. MENARDII AS TEMPERATURE PROXIES

In the context of this study, we acquired all environmental data in situ, which are to be used for the calculation of the calcification temperatures (T_C) of planktonic foraminiferal species *G. sacculifer* and *G. menardii* following Shackleton (1974) or Bemis (1998). The results were compared to the measured temperatures, at the living depth and stations where the specimens were collected. We considered 8 specimens of *G. sacculifer* of 2 Cape Verde samples and 8 specimens of 2 samples from the Central Atlantic. One sample with 5 specimens from the Central Atlantic and 4 Cape Verde samples with 25 specimens were considered for calculation of *G. menardii*. The data presented are mean values for each sampling site/interval. The averages resulted in 4-5 data points covering a temperature of 24 to 26.5°C, which is considered to well represent the tropical Atlantic Ocean.

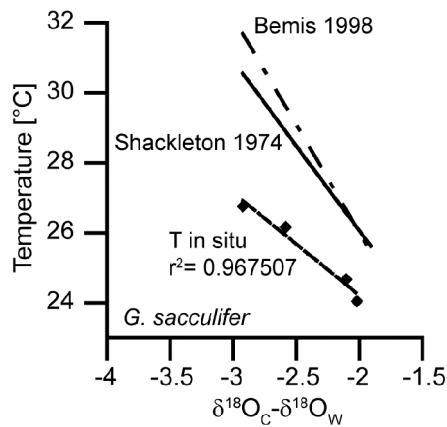

Fig. 3.11. Calcification temperature of *G. sacculifer* according to in situ temperature and to calculation of Shackleton and Bemis. $Y = -2.93 \cdot X + 18.355$

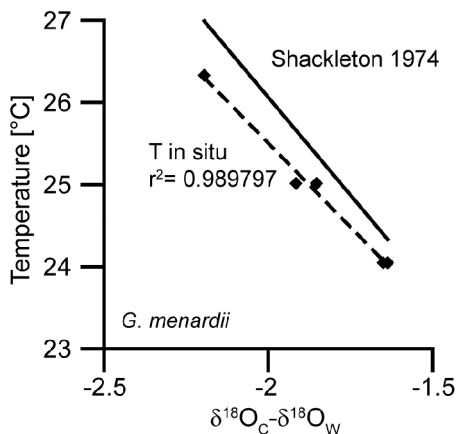

Fig. 3.12. Calcification temperature of *G. menardii* according to in situ temperature and to calculation of Shackleton. $Y = -4.09 \cdot X + 17.325$.

The $\delta^{18}\text{O}_C - \delta^{18}\text{O}_W$ data showed a linear relationship with temperature as inferred from previously published temperature equations. Surprisingly, the calcification temperatures of *G. sacculifer* (Fig. 3.11) showed strong differences between the equation of both Shackleton (1974) and Bemis (1998) and the in situ temperature of the sampling stations. The largest differences between calculated calcification temperatures and in situ temperatures can be seen in the Central Atlantic Ocean. In the Cape Verde region, the in situ temperature and the calcification temperature after Shackleton differ by 1.89°C and 2.1°C. Larger differences (2.72°C and 3.8°C) can be observed in the Central Atlantic. The temperature differences between the calculated calcification temperature of Bemis and our in situ temperature are even larger and vary between 1.97°C and 4.97°C.

Since the equation of Bemis was close to Shackleton's calcification temperatures, we did not apply Bemis' fit for temperature comparisons in *G. menardii*, though the values are shown in Table 3.1. The calculation of the T_C of *G. menardii* showed also a difference our in situ temperatures. We considered 5 data points and found temperature differences between 0.29 to 0.66°C. The highest difference of 0.66°C was observed in the Central Atlantic sample TP3.

3.4. DISCUSSION

3.4.1. CHEMICAL CHARACTERISTICS

Large numbers of geochemical analyses of calcareous tests of foraminifera have been conducted and the data were described in numerous studies during the past decades. The resolution of analytical devices is getting more and more accurate. Preference is still given to wet chemical methods, which integrate over 10 to 20 specimens, and thus approach an integrated average. Microprobe or laser ablation analyses examine a single test or chamber, that may have been precipitated under certain condition not necessarily matching a long-term average. As a complete suite of accompanying in situ environmental parameters were available in the present study, we decided to use a laser ablation system to reveal differences in single foraminiferal chambers of living specimens.

Since the living specimens and the sedimentary samples did not show a significant aluminium and manganese content, the elemental concentrations are considered as not being biased by clay or manganese coatings. Some specimens of the trap samples from the PSB, however, showed a high aluminium content and were slightly enriched in manganese. The specimens were probably deposited and were trapped after resuspension. A resuspension is possible in this area due to high bottom currents (Mienis et al., 2009; Linke, pers. comm.). As such, it has to be assumed that even small aluminium and manganese contamination, coatings or nodules were ablated during laser operations.

Table 3.2. Average element/Ca ratios of planktonic foraminifera

	n	B/Ca	σ	Mg/Ca	σ	Al/Ca	σ	Mn/Ca	σ	Zn/Ca	σ	Sr/Ca	σ	Ba/Ca	σ	U/Ca	σ
<i>G. sacculifer</i>																	
TP	9 (2)	206,63	31,59	4,07	0,49	0,00	0,00	0,00	0,00	0,03	0,01	1,62	0,11	2,62	0,48	9,60	1,84
CV	16 (4)	145,59	22,00	3,40	0,51	0,00	0,00	0,00	0,00	0,02	0,03	1,44	0,12	2,47	1,47	8,04	2,73
TP3000	5 (1)	119,04	13,54	5,08	0,46	0,20	0,26	0,07	0,04	0,22	0,19	1,45	0,13	23,14	8,28	13,68	6,56
<i>G. menardii</i>																	
TP	35 (6)	86,37	14,37	2,69	0,71	0,01	0,01	0,01	0,01	0,02	0,01	1,17	0,17	14,78	10,26	16,65	9,10
CV	8 (1)	127,21	50,44	3,82	1,37	0,06	0,17	0,01	0,01	0,04	0,06	1,39	0,30	7,84	8,19	35,72	34,28
TP3000	9 (2)	53,50	6,26	2,70	2,27	0,01	0,02	0,01	0,01	0,02	0,01	1,26	0,13	3,15	2,41	20,11	23,30
<i>G. bulloides</i>																	
M61/3-552 CT	6 (1)	150,48	66,94	6,15	3,86	2,35	2,53	0,06	0,05	0,04	0,02	1,24	0,13	13,97	9,08	56,37	34,24
M61/1-245 ST	14 (2)	71,09	14,96	2,93	1,43	0,01	0,01	0,00	0,00	0,00	0,00	1,35	0,09	1,42	0,31	12,11	7,91
<i>N. incompta</i>																	
M61/3-552 CT	8 (2)	85,29	33,67	3,19	0,91	1,87	1,16	0,09	0,09	0,02	0,01	1,26	0,17	6,44	2,71	31,47	20,67
M61/1-245 ST	11 (2)	98,41	26,60	2,63	1,40	0,06	0,14	0,00	0,00	0,01	0,01	1,32	0,09	2,32	1,12	9,81	7,69
<i>G. crassaformis</i>																	
TP 3000	6 (1)	56,24	7,91	1,62	0,68	0,03	0,02	0,02	0,03	0,08	0,10	1,32	0,25	9,27	6,84	12,84	15,51
<i>N. dutertrei</i>																	
CV	7 (1)	78,96	8,01	4,78	1,36	0,00	0,00	0,01	0,00	0,01	0,00	1,11	0,18	9,56	6,50	24,18	7,07
TP3000	11 (2)	71,27	8,99	1,70	0,98	0,02	0,02	0,01	0,01	0,02	0,02	1,38	0,09	2,39	1,38	6,91	4,91
<i>G. ruberpink</i>																	
CV	5 (1)	188,00	46,41	4,17	0,98	0,01	0,01	0,00	0,00	0,02	0,01	1,30	0,05	2,24	0,81	14,75	4,37
TP 3000	4 (1)	173,77	41,36	5,30	1,18	0,03	0,01	0,10	0,02	0,15	0,02	1,32	0,07	17,48	13,67	19,36	4,35
<i>G. inflata</i>																	
M61/3-552 CT	23 (4)	79,74	25,05	1,69	1,40	1,09	2,65	0,00	0,00	0,01	0,01	0,00	0,01	1,37	0,16	17,46	32,57
<i>G. hirsuta</i>																	
M61/1-245 ST	18 (3)	84,13	22,05	2,57	1,11	0,01	0,00	0,01	0,00	0,01	0,01	1,40	0,35	17,72	20,69	14,00	10,04

n = number of holes, in brackets number of specimen

The incorporation of barium into foraminiferal tests occurs in direct proportion to seawater concentration and does not vary with salinity or temperature (Lea and Boyle, 1991; Lea and Spero, 1992, 1994). Recent studies used barium as an indicator of past fluvial and meltwater input into the oceans (Hall, 2002; Weldeab et al., 2007). Barium concentration in the surface waters of the ocean is quite stable. In the Atlantic Ocean, the barium content is about 41 nmol/kg, and in the Pacific about 34 nmol/mol (Chan et al., 1977; Ostlund et al., 1987). It is assumed that higher barium concentrations in the Atlantic are caused by riverine or meltwater input (Chan et al., 1977), which is enriched in barium as a result of continental weathering (Martin and Meybeck, 1979). In contrast to deeper water, the surface waters of the oceans are depleted in barium due to the formation of barite (BaSO_4) (Bishop, 1988; Dehairs et al., 1980). Lea and Boyle (1991) listed Ba/Ca ratios of foraminiferal tests (*Orbulina universa*, *Globigerinoides ruber*, *Globigerinoides sacculifer* and *Globigerinoides conglobatus*) from numerous stations, most of them sediment core-tops, some sediment traps and plankton tows and they revealed a mean foraminiferal Ba/Ca ratio of 0.77 $\mu\text{mol/mol}$ ($\sigma = 0.12 \mu\text{mol/mol}$) and strong species differences in the Atlantic Ocean. In general, our sample show twice as high values than detected by Lea and Boyle (1991). The average Ba/Ca of two *G. sacculifer* from a subtropical plankton tow was 0.66 $\mu\text{mol/mol}$ ($\sigma = 0.02 \mu\text{mol/mol}$), while in the present study, the mean Ba/Ca ratio of 4 *G. sacculifer* in the Cape Verde is 2.47 $\mu\text{mol/mol}$ ($\sigma = 1.47 \mu\text{mol/mol}$), and 2.62 $\mu\text{mol/mol}$ ($\sigma = 0.48 \mu\text{mol/mol}$) of 2 specimens in the central Atlantic Ocean. Another surface-dwelling species, *G. ruber* (n=5) revealed 1.01 $\mu\text{mol/mol}$ ($\sigma = 0.12 \mu\text{mol/mol}$) (Lea and Boyle, 1991) and 1.96 $\mu\text{mol/mol}$ in 2 specimens from a sediment trap, which were cleaned without reductive steps (hydrazine ammonium citrate). We therefore, found 2.2 $\mu\text{mol/mol}$ ($\sigma = 0.8 \mu\text{mol/mol}$) in the Cape Verde region. The values of Ba/Ca in *N. dutertrei* vary between 0.86 and 4.7 $\mu\text{mol/mol}$ in three sediment trap samples in Lea and Boyle (1991). One specimen of *N. dutertrei* from the Cape Verde region shows a mean value of 9.56 $\mu\text{mol/mol}$ ($\sigma = 6.5 \mu\text{mol/mol}$). The planktonic foraminiferal species *G. menardii* showed 6.6 $\mu\text{mol/mol}$ ($\sigma = 2.2 \mu\text{mol/mol}$) in 2 specimens (Lea and Boyle 1991), We found 7.8 $\mu\text{mol/mol}$ ($\sigma = 8.2 \mu\text{mol/mol}$) in 5 specimens from the Cape Verde region but 14.8 $\mu\text{mol/mol}$ ($\sigma = 10.3 \mu\text{mol/mol}$) in the central Atlantic Ocean. The lower values of Lea and Boyle (1991), may caused by their chemical treatment with hydrazine-ammonium citrate and alkaline diethylenetriamine-pentaacetic acid (DTPA), which dissolves the foraminiferal carbonate shell, if not used extremely carefully (Lea and Boyle, 1991, 1993). However, the general pattern that non-spinose species incorporate more barium than spinose species (Lea, 1999) is supported by our data.

Boron has been demonstrated as a proxy for surface seawater pH in several studies. The estimation of paleo- CO_2 concentrations and the reconstruction of surface pH variations on glacial/interglacial timescales were carried out with boron isotopes (Spivack et al., 1993; Sanyal et al., 1996; Sanyal et al., 1997; Sanyal and Bijma, 1999; Hönisch et al., 2003; Hönisch and Hemming, 2005; Yu et al., 2007). Yu analyzed planktonic foraminiferal species *G. inflata* and *G. bulloides* from North Atlantic core tops. Those B/Ca values in *G. inflata* varied between 52 and 79 $\mu\text{mol/mol}$ and in *G. bulloides* between 31 and 50 $\mu\text{mol/mol}$. Our boron analyses of *G. inflata* from the Porcupine Seabight sediment sample (Appendix 3) revealed also a similar B/Ca ratio of 79.9 $\mu\text{mol/mol}$ ($\sigma =$

25.1 $\mu\text{mol/mol}$), and the B/Ca ratio of *G. bulloides* in the sediment trap revealed a slightly lower value of 71.1 $\mu\text{mol/mol}$ ($\sigma = 15.0 \mu\text{mol/mol}$), but the B/Ca ratio of *G. bulloides* in the sediment sample a much higher value of 150.0 $\mu\text{mol/mol}$ ($\sigma = 66.9 \mu\text{mol/mol}$). Other studies reported much lower B/Ca ratios of *G. bulloides*, 19.0 $\mu\text{mol/mol}$ ($\sigma = 0.9 \mu\text{mol/mol}$) (Hönisch et al., 2003) and $\sim 20 \mu\text{mol/mol}$ (Hathorne et al., 2009). Microprofiling studies depicted the variation of pH in the microenvironment of symbiont-bearing foraminifera due to light levels (Jørgensen et al., 1985; Rink et al., 1998) and thus invoke a relationship of boron to photosynthesis and respiration. According to the result of Hönisch et al (2003), symbiont-bearing foraminifera would show higher boron values compared to symbiont-barren species, in particular *G. sacculifer* and *G. ruber* should show higher B/Ca ratios than *G. bulloides* and *G. hirsuta*. This assumption is corroborated by our data. We obtained a mean B/Ca ratio of $\sim 167 \mu\text{mol/mol}$ in *G. sacculifer* and $\sim 186 \mu\text{mol/mol}$ in *G. ruber* pink (average of 6 and 1 plankton tow specimens). In contrary, we found 71 $\mu\text{mol/mol}$ in *G. bulloides* and 84 $\mu\text{mol/mol}$ in *G. hirsuta* (average of 2 and 3 sediment trap specimens). The planktonic foraminiferal species *G. menardii*, *G. dutertrei* and *G. inflata* may bear symbionts facultatively, and thus their values are with 120 $\mu\text{mol/mol}$ (7 specimen), 79 $\mu\text{mol/mol}$ (1 specimen) and 79 $\mu\text{mol/mol}$ (4 specimen; core-top) in between the symbiont and non-symbiont bearing species.

Trace element magnesium has been reported in numerous studies and is used as a proxy for temperature. Clarke and Wheeler (1922) already recognized that carbonate shells, which precipitate in warmer water show more Mg than shells precipitating in colder water. Following studies analyzed Mg/Ca ratios in several planktonic foraminifera and demonstrated the relationship of temperature and Mg concentration in foraminiferal shells. Mg/Ca ratio in planktonic foraminiferal tests is considered to range between 0.5 and 5.0 mmol/mol (Delaney et al., 1985; Rosenthal and Boyle, 1993). Several later studies considered post-depositional effects on Mg, like dissolution, early diagenesis, and the use of Mg/Ca as a proxy for temperature reconstruction (Eggins et al., 2003; Anand and Elderfield, 2005; Nürnberg, et al., 1996; Regenberg et al., 2006; Cléroux et al., 2008; Sadekov et al., 2008; Hoogakker et al., 2009; Mathien-Blard and Bassinot, 2009; Regenberg et al., 2009). The Mg/Ca ratio of our plankton agree well with data reported in earlier studies and vary averaged between 2.6 and 4.8 mmol/mol with species. In general, we found also a temperature variation between species from the tropical Atlantic and the Northeastern Atlantic with 2.6 and 2.9 mmol/mol in *G. bulloides*, *G. hirsuta* and *N. incompta* and higher values (3.4 to 4.8 mmol/mol) for *G. sacculifer*, *N. dutertrei*, and *G. ruber* pink. The *G. menardii* specimens of the tropical Atlantic show high values of approximately 3.6 mmol/mol, but we also found one specimen with a distinct intertest variability between the shell with 3.2 mmol/mol ($\sigma = 0.18 \text{ mmol/mol}$) and the keel with 1.9 mmol/mol ($\sigma = 0.48 \text{ mmol/mol}$).

Experiments with cultured planktonic foraminifera show a relationship between foraminiferal U/Ca and temperature (Russell et al, 2004). Recent studies revealed a strong temperature effect on the incorporation of uranium in foraminiferal tests (Yu et al., 2008). Their core-top results led to the conclusion that U/Ca ratios increase with decreasing latitude. Their U/Ca from core-tops, do not show significant differences to the data from our sediment trap in the PSB. Whereas, our core-top data of *G. bulloides* ($\sim 56 \text{ nmol/mol}$) is five times higher, *G. inflata* ($\sim 17.5 \text{ nmol/mol}$) two times higher, and *N. incompta* ($\sim 31.5 \text{ nmol/mol}$) approximately 7 times higher than reported in Yu et al

(2008). These strong differences may be caused by different cleaning procedures. Yu also used the reductive step used in Lea and Boyle (1991). Supported is this assumption by the comparison of Mn/Ca and U/Ca in the core-top sample *G. bulloides* (Appendix 3.7), which show a systematic relation. In contrary to the hypothesis that U/Ca increases with decreasing latitude, the U/Ca values of our central Atlantic sediment samples (TP 3000) show much lower values than the core-top samples of the PSB in the North Atlantic. This observation is supported by our sediment trap and plankton tow samples, which do not vary with latitude, but with species. *Neogloboquadrina incompta* from PSB, for example, yield 9.8 nmol/mol whereas *G. sacculifer* from Cape Verde region yield 8.0 nmol/mol. The LA-ICP-MS methods allowed us to reveal a remarkable intertest difference in *G. menardii*. The mean U/Ca ratio in the shell of *G. menardii* from the tropical Atlantic plankton tows is 3 – 3.4 times higher than the U/Ca ratio in the keel of *G. menardii*. The factor increases to 4.5 in the sedimentary specimen. The keel develops after the formation of the first 5-7 chambers (Hemleben et al., 1989), which implies that the keel of the final three chambers contain similar uranium content than the chamber walls. A closer view on SEM images of *G. menardii* (Appendix 4) reveal a smooth keel, but micropores on the chamber walls. This leads to the assumption, that unremovable nano-material could be stucked within the micropores and lead to higher uranium values.

Besides the differences to other studies, the difference within our samples, species, specimens and even chambers should not be influenced by manganese and ferric oxides or organic matter. The LA-ICP-MS analyses demonstrate strong intertest variabilities and underline the importance of so-called vital-effects, for example, the variation of chemistry with shell size and related systematic variations of Mg/Ca, Mn/Ca, Ba/Ca and Zn/Ca (Elderfield et al., 2002; Hathorne and James, 2006; Ni et al., 2007). Though the comparisons of our element/Ca data neither show significant changes with size of the specimens nor variations with any other element in particular, we revealed, besides chemical treatments and element distribution in the oceans, that the analyzed elements are not homogenously distributed in a foraminiferal shell. The high variability of elements within one specimen must question the use of a single foraminifer as a proxy carrier. And it supports the idea to blend several specimen to be analyzed by wet chemical methods to rule out the internal variability to avoid this problem.

3.4.2. TEMPERATURE PROXIES

Several studies considered the calcification temperature of planktonic foraminifera and even deduced the apparent calcification depth from estimated and calculated $\delta^{18}\text{O}$ values (Anand et al., 2003; Eggins et al., 2003; Mulitza et al., 2003; Anand and Elderfield, 2005; Lončarić, 2005; Cléroux et al., 2008; Sadekov et al., 2008; Regenberget al., 2009; Steph et al., 2009; Wilke et al., 2009). This study could calculate the calcification temperature of the surface dwelling species *G. sacculifer* and intermediate living *G. menardii* following Shackleton (1974) and Bemis et al. (1998) with surface water $\delta^{18}\text{O}$ values. The application of both equations resulted in higher calcification temperatures than even the highest in situ temperatures. This puts the reliability of foraminiferal $\delta^{18}\text{O}$ in question. Planktonic foraminifera migrate vertically through the water column during their ontogenic cycle and add chambers to their shells at different stages. *Globigerinoides sacculifer* is

known as a surface dweller and calcifies within the upper 50 m of the water column. Regarding our CTD data, we sampled in a well mixed layer with constant temperature and salinity and therefore, the foraminiferal bulk $\delta^{18}\text{O}$ values should be reliable. Similar studies with plankton tow samples did also reveal lower temperature than predicted by the equation of Shackleton (1974), (Mulitza et al., 2003). Their data agreed well with regressions derived from culture experiments with controlled pH (Bemis et al., 1998). But also calculated calcification temperatures derived of Bemis' equation were much higher. On the other hand, Bemis' and Shackleton's equations fitted with only little offset to the calcification temperature of living specimens of the intermediate living *G. menardii*. Gametogenic calcite, which forms at greater depth, approximately 16 hours before gamete release could influence the foraminiferal bulk $\delta^{18}\text{O}$. Since *G. sacculifer* is known to live and reproduce in the upper 50 m of the water column, which is in the study area a well mixed water layer, an influence of gametogenic calcite on the foraminiferal bulk $\delta^{18}\text{O}$ is not given. Besides living specimens, we also calculated the calcification temperature of a specimen of *G. sacculifer* from a core-top, whose value matches the recent in situ temperature at the living depth. According to its $\delta^{18}\text{O}$ value, the specimen seems not to be covered with a secondary calcite layer, which is often formed in deeper water. But its higher Mg/Ca ratio implies a diagenetic overprint, since inorganic calcite contains more Mg than foraminiferal calcite (Katz 1973; Mucci 1987). The sedimentary specimen of *G. menardii*, in contrast, shows a much lower calcification temperature, but also shows a high Mg/Ca ratio. The offsets in calcification temperatures, which are also detected by Kozdon et al (2009) may be explained by the fact, that former studies compared foraminiferal bulk $\delta^{18}\text{O}$, including secondary encrustations, to surface water conditions. More data on primary calcite are therefore needed to better constrain the composition of primary calcite and, more importantly, to better assess the bias induced by secondary calcification.

3.5. CONCLUSION

The chemical composition of planktonic foraminifera vary strongly between species, but also between specimen, and single chambers. No systematic variation regarding different sized specimens, could be observed. Since we analyzed cleaned living specimens, the, in some cases much higher U/Ca, B/Ca and Ba/Ca ratios compared to other studies, can be caused by different cleaning procedures.

Despite strong variations, we can support the assumption that non-spinose species incorporate more barium than spinose species and that symbiont-bearing foraminifera show higher $\delta^{11}\text{B}$ values compared to symbiont-barren foraminifera. In contrary, we can not support the thesis that U/Ca is affected by temperature. We therefore conducted a difference in U/Ca ratios in intermediate living species *G. menardii*, which showed higher values in the chamber walls than in keel, which question the influence of vital-effects and infers the possibility of nano-material containing more uranium within the pores.

The importance of understanding the life of a planktonic foraminifera gets clear while we interpret the calcification temperatures following Shackleton by using in situ $\delta^{18}\text{O}_w$. The results imply that former studies compared encrusted foraminiferal bulk $\delta^{18}\text{O}$ to surface water

conditions. So should future surveys contain more than plankton sampling. The acquaintance of water samples for chemical and isotope measurements from the relevant habitat/sampling section and in situ pH, temperature and salinity observation would be necessary to create a reliable proxy. This, in particular holds true for the tropical oceans where the temperatures and offsets to established equations are high. A reliable description of past changes from the fossil record requires a much better precision than what is possible to date.

Outlook – The significance of lunar cycles

In this study, I focused on planktonic foraminifera in the Atlantic Ocean (Fig. A). Besides the main focus of our study, I found another aspect worth to discuss. The data of the previous chapters reveal also information about the reproduction cycles of several planktonic foraminiferal species.

The reproductive strategies of planktonic foraminifera relate pelagic carbonate production in the upper water column to carbonate deposition at the ocean floor. Occurrence and distribution of planktonic foraminifera are strongly influenced by their reproduction cycle. All near surface dwelling species are suspected to have some form of lunar entrainment for reproduction while deep dwellers have a semi-annual to annual cycle (Hemleben et al, 1989). However, *Hastigerina pelagica* is the only planktonic foraminifera with a proved lunar cyclicity (Lončarić et al., 2005). Laboratory cultures showed in 85.4 % of the individuals from a *Hastigerina pelagica* population that gametogenesis occurred 5 ± 2 days after full moon (Spindler et al., 1979). Other studies with a detailed plankton sampling revealed that *G. sacculifer* is also subjected to a lunar cycle. Young individuals are found in surface water 7-8 days after full moon, they grow rapidly until they start to descend (Erez, 1991; Kawahata et al., 2002). Field observations indicated a lunar reproductive cycle for *G. bulloides* and *O. universa*. Whereas semi-lunar reproduction is characteristic for *G. ruber* and *G. siphonifera* (Bijma et al., 1990). Volkmann (2000) assumed a lunar reproductive cycle for the planktonic foraminifera *T. quinqueloba* and *N. pachyderma* sinistral.

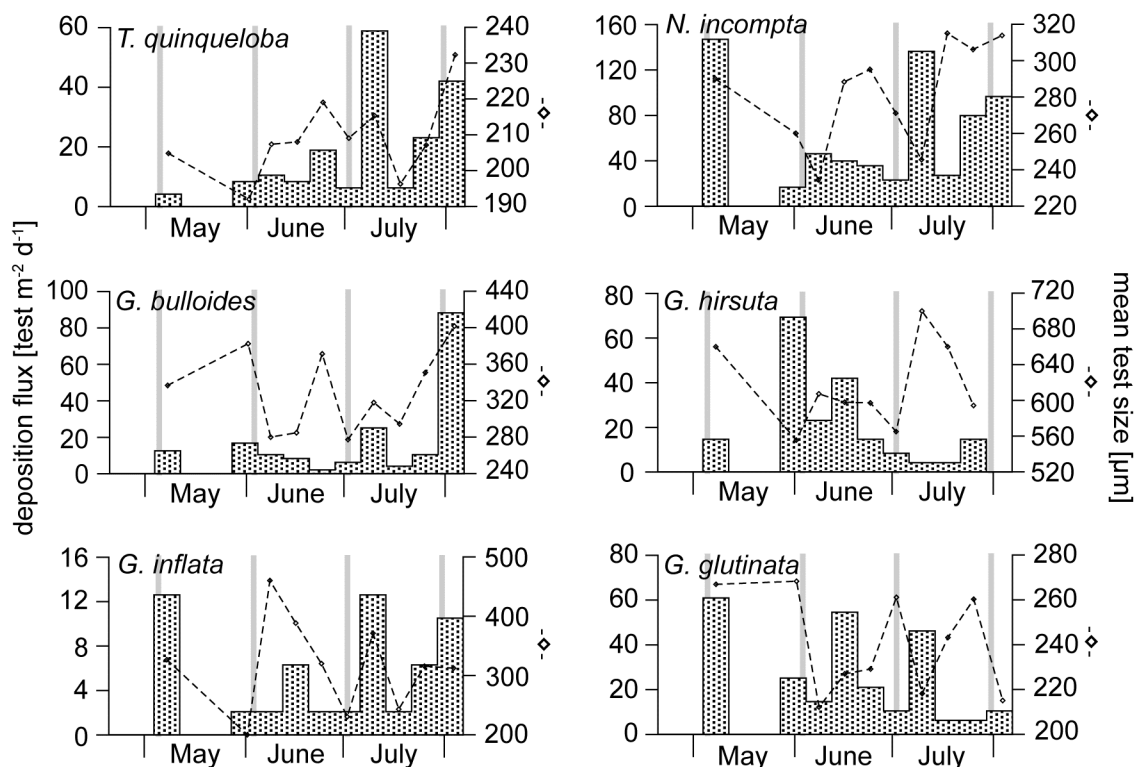

Fig. 4.1.: Deposition flux in comparison to mean size fraction of major species. Grey bars indicate full moon.

Thus, I applied the assumption of lunar periodicity to our 3-month time-series, which covered four lunar cycles. A comparison of catches of planktonic foraminifera from different phases of a synodic cycle is difficult. I therefore examined the short-term variability of deposition fluxes and mean shell size of the dominant species in detail. In this chapter, I infer synodic reproduction by plotting the mean size of deposited individuals versus sampling interval (Fig 4.1). Comparisons between these two parameters revealed several patterns.

The reproductive pattern of *G. bulloides* as described by Bijma and others (1990) is in good agreement to the results from our study. Especially large individuals of *G. bulloides* were deposited around full moon. Regarding the sinking velocities of planktonic foraminifera, the gametogenesis should have happened 2-3 days before deposition. For instance, the mean shell size of *G. bulloides* and *G. glutinata* shows a pronounced 24-day lunar cyclicity. The mean shell size was up to 25 % smaller shortly after full moon. In the course of the lunar cycle, the shell mean size increased until just before full moon. *G. inflata* has a 31-day cycle with large shell sizes shortly after full moon and a decrease in course of the following lunar cycle. *Neogloboquadrina incompta*, and *G. hirsuta* displayed a similar shell size variability, but their periodicity was not in congruence with a lunar cycle. *Globorotalia hirsuta* is known to reproduce semi-annually in the surface waters in the vicinity of the Bermuda Islands during winter (Bé and Hamlin, 1967; Hemleben et al. 1985; Deuser and Ross 1989). Instead of a lunar reproductive cycle of *T. quinqueloba*, as it has been described from Arctic waters (Volkman, 2000), I found no distinct cycle for this species. But *T. quinqueloba* reaches its maturity within the size class 125-250 μm , and the largest individuals occur with a lag of 6 weeks.

Regarding the population density of the surface-dwelling *G. sacculifer* in the tropical Atlantic samples, the assumption that this species is subjected to a lunar cycle can be supported. The vertical distribution of *G. sacculifer* in the Cape Verde region (Fig. 2.14) reveal larger individuals in the tow sample 3 days after full moon and smaller specimen in the tow sample 6 days after full moon. This distribution pattern matches the observations by Erez (1991) and Kawahata et al (2002). The investigation on population densities with pump sampling revealed also distinct pattern (Fig. 2.5). Besides a daily vertical migration, a high population density of small individuals were found several days before and after full moon. Despite the occurrence of small shaped species, like *G. rubescens*, young individuals of *G. sacculifer*, *G. ruber*, and maybe other monthly reproducing species may cause the high population densities around full moon.

References

- Agusti, S., Philips, E.J., 1992. Light absorption by cyanobacteria: Implications of the colonial growth form. *Limnology Oceanography* 37, 434-441.
- Anand, P., Elderfield, H., Conte, M.H., 2003. Calibration of Mg/Ca thermometry in planktonic foraminifera from sediment trap time series. *Paleoceanography* 18, 15pp.
- Anand, P., Elderfield, H., 2005. Variability of Mg/Ca and Sr/Ca between and within the planktonic foraminifers *Globigerina bulloides* and *Globorotalia truncatulinoides*. *Geochemistry, Geophysics, Geosystems* 6, 15pp.
- Anderson, O.R., Spindler, M., Bè, A.W.H., Hemleben, C., 1979. Trophic activity of planktonic foraminifera. *Journal of the Marine Biological Association of the United Kingdom* 59, 791-799.
- Antia, A. N., Erasmi, W., Lampitt, R. S., Kumbier, T., Lehnert, G., 1996. Particle flux in situ Marine Aggregate Studies at the Continental Margin, in Koltermann, K. P., Pfannkuche, O., Meinke, J. (eds.), JGOFS, OMEX and WOCE in the North Atlantic 1994. *Meteor Berichte* 96-3, Cruise No. 30, 33 – 42.
- Antoine, D., Andre, J.-M., Morel, A., 1996. Ocean primary production – 2. Estimation at global scale from satellite (coastal zone color scanner) chlorophyll. *Global Biochemical Cycles* 10, No. 1, 57 – 69.
- Arnault, S., 1987. Tropical Atlantic geostrophic currents and ship drifts. *Journal of Physical Oceanography* 18, 1050-1060.
- Bè, A. W. H., 1960. Ecology of Recent planktonic Foraminifera. Part 2. Bathymetric and seasonal distributions in the Sargasso Sea off Bermuda. *Micropaleontology* 6, 373 – 392.
- Bè, A. W. H., 1977. Recent planktonic foraminifera, in Ramsay, A.T.S., (Ed.). *An Ecological, Zoographic and Taxonomic Review of Recent Planktonic Foraminifera*. 1 – 100.
- Bè, A. W. H., Hamlin, W.H., 1967. Ecology of Recent planktonic Foraminifera. Part 3. Distribution in the North Atlantic during the summer to 1962. *Micropaleontology* 13, 87 – 106.
- Bè, A. W. H., Tolderlund, D.S., 1971. Distribution and ecology of living planktonic foraminifera in surface waters of the Atlantic and Indian Ocean. In: B.M Funnel and W.R Riedel, Editors, *The Micropaleontology of Oceans*, Cambridge Univ. Press, London (1971), 105–149.
- Beckmann, W., Auras, A., Hemleben, C., 1987. Cyclonic cold-core eddy in the eastern North Atlantic. III. Zooplankton. *Marine Ecology – Progress Series* 39, 165-173.
- Bemis, B., Spero, H., Bijma, B., Lea, D., 1998. Reevaluation of the oxygen isotope composition of planktonic foraminifera: Experimental results and revised paleotemperature equations. *Paleoceanography* 13, 150-160.
- Berger, W. H., 1969. Ecological patterns of living planktonic foraminifera. *Deep Sea Research* 16, 1-24.
- Berger, W. H., 1971. Sedimentation of planktonic foraminifera. *Marine Geology* 11, 325 – 358.
- Bersch, M., 1995. On the circulation of the northeastern North Atlantic. *Deep Sea Research I*, 42, 1583 – 1607.

- Bijma, J., Erez, J., Hemleben, C., 1990. Lunar and semi-lunar reproductive cycles in some spinose foraminifers. *Journal of Foraminiferal Research* 20, 117-127.
- Bischof, B., Mariano, A., Ryan, E., 2004. "The North Equatorial Countercurrent." *Ocean Surface Currents*. <http://oceancurrents.rsmas.miami.edu>
- Bishop, J., 1988. The barite-opal-organic carbon association in oceanic particulate matter. *Nature* 332, 341-343.
- Boltovskoy, E., 1964. Distribution of the living planktonic foraminifera in the equatorial Atlantic, Western part. *Secretaria de Marina, Servicio de hidrografia Naval*, H639, 53pp.
- Boltovskoy, E., 1973. Daily vertical migration and absolute abundance of living foraminifera. *Journal of foraminiferal Research* 3, 89-94.
- Boltovskoy, D., Gibbons, M.J., Hutchings, L., Binet, D., 1999. General biological Features of the South Atlantic. In: Boltovskoy, D. (Ed.). *South Atlantic Zooplankton*. Backhuys Publishers, Leiden, 1999, 1-42.
- Bonhoure, D., Rowe, E., Mariano, A., Ryan, E., 2004. "The South Equatorial Sys Current". *Ocean Surface Currents*. <http://oceancurrents.rsmas.miami.edu>
- Bradshaw, J.S., 1961. Laboratory experiments on the ecology of foraminifera. *Cushman Foundation Research Contribution* 12, 87-106.
- Brady, H.B., 1884. Report on the Foraminifera dredged by HMS Challenger during the years 1873-1876. Report on the Scientific Results of the Voyage of HMS Challenger during the years 1873-1876. *Zoology* IX.
- Chan, L., Drummond, J., Edmond, J., Grant, B., 1977. On the barium data from the GEOSECS expedition. *Deep Sea Reseach* 24, 613-649.
- Chapman, M., 2007. Northeast Atlantic Ocean: Implications for holocene paleotemperature Reconstructions. 9th International Conference on Paleoceanography. Shanghai, China, p.227
- Cifelli, R., Smith, R. K., 1970. Distribution of planktonic foraminifera in the vicinity of the North Atlantic Current. *Smithsonian contributions to Paleobiology* 4, 1 – 52.
- Clarke, R., Wheeler, W., 1922. The inorganic constituents of marine invertebrates. U.S. Geological Survey, Prof. Paper Reston, Virginia, USA, 62pp.
- Cléroux, C., Cortijo, E., Anand, P., Labeyrie, L., Bassinot, F., Caillon, N., Duplessy, J., 2008. Mg/Ca and Sr/Ca ratios in planktonic foraminifera : Proxies for upper water column temperature reconstruction. *Paleoceanography* 23, 16pp.
- Darling, K., Kucera, M., Kroon, D., Wade, M., 2006. A resolution for the coiling direction paradox in *Neogloboquadrina pachyderma*. *Paleoceanography* 21.
- Dehairs, F., Chesselet, R., Jedwab, J., 1980. Discrete suspended particles of barite and the barium cycle in the open ocean. *Earth and Planetary Science Letters* 49, 528-550.
- Delaney, M., Bè, A.W.H., Boyle, E., 1985. Li, Sr, Mg, and Na in foraminiferal calcite shells from laboratory culture, sediment traps, and sediment cores. *Geochimica et Cosmochimica Acta* 49, 1327-1341.

- Deuser, W. G., 1986. Seasonal and interannual variations in deep-water particle fluxes in the Sargasso Sea and their relation to surface hydrography. *Deep Sea Research* 33, 225 – 246.
- Deuser, W. G., Ross, E. H., 1989. Seasonally abundant planktonic foraminifera of the Sargasso Sea – succession, deep-water fluxes, isotopic composition & paleoceanographic implications. *Journal of Foraminiferal Research* 19, 268 – 293.
- Dickson, R. R., Gould, W. J., Mueller, T.J. and Maillard, C., 1985. Estimates of the mean circulation in the deep (>2000 m) layer of the eastern North Atlantic. *Progress in Oceanography* 14, 103 – 127.
- D'Orbigny, A., 1826. Tableau Méthodique de la Classe des Céphalopodes. *Annales des Sciences Naturelles, Paris (series 1)* 7, 245-314.
- Dorschel, B., Hebbeln, D., Foubert, A., White, M., Wheeler, A.J., 2007. Hydrodynamics and cold-water coral facies distribution related to recent sedimentary processes at Galway Mound west of Ireland. *Marine Geology* 244, 184-195.
- Eggins, S., DeDeckker, P., Marshall, J., 2003. Mg/Ca variation in planktonic foraminifera tests: implications for reconstruction palaeo-seawater temperature and habitat migration. *Earth and Planetary Science Letters* 212, 291-306.
- Eggins, S., Sadekov, A., DeDeckker, P., 2004. Modulation and daily banding of Mg/Ca in *Orbulina universa* tests by symbiont photosynthesis and respiration: a complication for seawater thermometry. *Earth and Planetary Science Letters* 225, 411-419.
- Eisele, M., Hebbeln, D., Wienberg, C., 2008. Growth history of a cold-water coral covered carbonate mound – Galway Mound, Porcupine Seabight, NE-Atlantic. *Marine Geology* 253, 163-169.
- Elderfield, H., Ganssen, G., 2000. Past temperature and $\delta^{18}\text{O}$ of surface ocean waters inferred from foraminiferal Mg/Ca ratios. *Nature* 405, 442-445.
- Elderfield, H., Vautravers, M., Cooper, M., 2002. The relationship between shell size and Mg/Ca, Sr/Ca, $\delta^{18}\text{O}$, and $\delta^{13}\text{C}$ of species of planktonic foraminifera. *Geochemistry, Geophysics, Geosystems* 3, 13pp.
- Erez, J., 1978. Vital effects on stable isotope composition seen in foraminifera and coral skeletons. *Nature* 273, 199-202.
- Erez, J., 1983. Calcification rates, photosynthesis and light in planktonic foraminifera. In: *Biom mineralization and Biological Metal. Accumulation Biological and Geological Perspectives* [Westbroek, P., De Jong, E.W. (Eds.)]. Reidel, Dordrecht, 307 – 312.
- Erez, J., Almogi-Labin, A., Avraham, S., 1991. On the life history of planktonic foraminifera: Lunar reproduction cycle in *Globigerinoides sacculifer* (Brady). *Paleoceanography* 6, 295-306.
- Fairbanks, R.G., Wiebe, P.H., 1980. Foraminifera and chlorophyll maximum: Vertical distribution, seasonal succession, and paleoceanographic significance. *Science* 209, 15424-15426.
- Fedoseev, A., 1970. Geostrophic circulation of surface water on the shelf of northwest Africa. *Rapports et Proces-Verbaux des Reunions (Conseil Permanent International pour l'Exploration de la Mer* 159, 32-37.

- Figuroa, F., Jimenez-Gomez, F., Villarino, M.L., Rodriguez, J., Figueiras, F., 1994. Underwater light field and phytoplankton distribution during a daily cycle in the Ría of Vigo (NW Spain). *Scientia Marina* 58, 119-130.
- Fofonoff, N.P., Millard, R.C., 1983. Algorithms for computation of fundamental properties of seawater. *UNESCO Technical papers in marine science* 44, 58 pp.
- Fratantoni, D., M., 2001. North Atlantic Surface Circulation during the 1990's observed with satellite-tracked drifters. *Journal of Geophysical Research* 106, 22067-22093.
- Hackett, B., Røed L., 1998. A numerical study of the slope current northwest of the British Isles. *Continental Shelf Research* 18, 1 – 30.
- Hall, J., 2002. Barium and lithium in foraminifera: Glacial-interglacial changes in the North Atlantic. PhD thesis.
- Harbers, A., Schönfeld, J., Rüggeberg, A., Pfannkuche, O., 2010. Short term dynamics of planktonic foraminiferal sedimentation in the Porcupine Seabight. *Micropaleontology* 56, 259-274.
- Hathorne, E., Alard, O., James, R., Rogers, N., 2003. Determination of intratest variability of trace elements in foraminifera by laser ablation inductively coupled plasma-mass spectrometry. *Geochemistry, Geophysics, Geosystems* 4, 14pp.
- Hathorne, E., James, R., 2006. Temporal record of lithium in seawater: A tracer for silicate weathering? *Earth and Planetary Science Letters* 246, 393-406.
- Hathorne, E., James, R., Lampitt, R., 2009. Environmental versus biomineralization controls on the intratest variation in the trace element composition of the planktonic foraminifera *G. inflata* and *G. scitula*. *Paleoceanography* 24, 14pp.
- Hemleben, C., Spindler, M., Breiting, I., Deuser, W. G., 1985. Field and laboratory studies on the ontogeny and ecology of some globorotaliid species from the Sargasso Sea off Bermuda. *Journal of Foraminiferal Research* 15, 254 – 272.
- Hemleben, C., Spindler, M., Anderson, O.R., 1989. *Modern planktonic foraminifera*. Springer, Berlin 363pp.
- Hentschel, E., 1932. Die biologischen Methoden und das biologische Beobachtungsmaterial der Meteor-Expedition. In: Defant, A. (Ed.), *Wissenschaftliche Ergebnisse X, Deutsche Atlantische Expedition der METEOR 1925-1927*, 1-274.
- Herman, A.W., Platt, T., Primary production profiles in the ocean: estimation from a chlorophyll/light model. *Oceanological Acta* 9, 31-40.
- Hönisch, B., Bijma, J., Russell, A., Spero, H., Palmer, M., Zeebe, R., Eisenhauer, A., 2003. The influence of symbiont photosynthesis on the boron isotopic composition of foraminifera shells. *Marine Micropaleontology* 49, 87-96.
- Hönisch, B., Hemming, N., 2005. Surface ocean pH response to variations in pCO₂ through two full glacial cycles. *Earth and Planetary Letters* 236, 305-314.
- Holmes, N.A., 1982. Diel vertical variations in abundance of some planktonic foraminifera from The Rockall Trough, Northeastern Atlantic Ocean. *Journal of Foraminiferal Research* 12, 145-150.

- Hoogakker, B., Klinkhammer, G., Elderfield, H., Rohling, E., Hayward, C., 2009. Mg/Ca paleothermometry in high salinity environments. *Earth and Planetary Science Letters* 284, 583-589.
- Honjo, S., Manganini, S. J., 1993. Annual biogenic particle fluxes to the interior of the North Atlantic Ocean; studied at 34°N 21°W and 48°N 21°W. *Deep Sea Research* 40, 587 – 607.
- Hut, G., 1987. Stable isotope reference samples for geochemical and hydrological investigations. Consultants Group Meeting IAEA, Vienna 16.-18. Sept. 1985. Report to the Director General, International Atomic Energy Agency, Vienna 42.
- Johnson, J., Stevens, I., 2000. A fine resolution model of the eastern North Atlantic between the Azores, the Canary Islands and the Gibraltar Strait. *Deep Sea Research*, 47, 875-899.
- Jones, R.W., 1994. *The Challenger Foraminifera*. Oxford University Press, Oxford, 149pp.
- Jørgensen, B., Erez, J., Revsbech, N., Cohen, Y., 1985. Symbiotic photosynthesis in a planktonic foraminifera, *Globigerinoides sacculifer* (Brady), studied with microelectrodes. *Limnology Oceanography* 30, 1253-1267.
- Katz, A., 1973. The interaction of magnesium with calcite during crystal growth at 25-90°C and one atmosphere. *Geochimica et Cosmochimica Acta* 37, 1563-1586.
- Katz, M., Cramer, B., Franzese A., Hönisch, B., Miller, K., Rosenthal, Y., Wright, J., 2010. Traditional and emerging geochemical proxies in foraminifera. *Journal of Foraminiferal Research* 40, 165-192.
- Kawahata, H., Nishimura, A., Gagan, M., 2002. Seasonal change in foraminiferal production in the western equatorial Pacific warm pool: evidence from sediment trap experiments. *Deep Sea Research* 49, 2783-2800.
- Kemle-von Mücke, S., Oberhänsli, H., 1999. The distribution of living planktonic Foraminifera in relation to the southeast Atlantic Oceanography. In: Fischer, G., Wefer, G. (Eds). *Use of Proxies in Paleoceanography: Examples from the South Atlantic*. Springer, Berlin, 1999, 91-115.
- Kemle-von Mücke, S., Hemleben, C., 1999. Foraminifera. In: Boltovskoy, D. (Ed.). *South Atlantic Zooplankton*. Backhuys Publishers, Leiden, 1999, 43-73.
- Kozdon, R., Ushikubo, T., Kita, N., Spicuzza, M., Valley, J., 2009. Intratest oxygen isotope variability in the planktonic foraminifer *N. pachyderma*: Real vs. apparent vital effects by ion microprobe. *Chemical Geology* 258, 327-337.
- Kroon, D., Ganssen, G., 1989. Northern Indian Ocean upwelling cells and the stable isotope composition of living planktonic foraminifers. *Deep Sea Research A*, 36, 1219 – 1236.
- Krümmel, O., 1911. *Handbuch der Ozeanographie*. Band I und II, STUTTGART.
- Lazaro, C., Fernandes, J., Santos, M., Oliveira, P., 2005. Seasonal and interannual variability of surface circulation in the Cape Verde region from 8 years of merged T/P and ERS-2 altimeter data. *Remote Sensing of Environment* 98, 45-62.
- Lea, D., 1999. Trace elements in foraminiferal calcite. In: Gupta, B., [ed.]. *Modern foraminifera*. 1999. Kluwer Academic Publishers, Great Britain. 259-277.

- Lea, D., Boyle, E., 1991. Barium in planktonic foraminifera. *Geochimica et Cosmochimica Acta* 55, 3321-3331.
- Lea, D., Boyle, E., 1993. Determination of carbonate-bound barium in foraminifera and coral by isotope dilution plasma-mass spectrometry. *Chemical Geology* 103, 73-84.
- Lea, D., Spero, H., 1992. Experimental determination of barium uptake in shells of the planktonic foraminifera *Orbulina universa* at 22°C. *Geochimica et Cosmochimica Acta* 56, 2673-2680.
- Lea, D., Spero, H., 1994. Assessing the reliability of paleochemical tracers: Barium uptake in the shells of planktonic foraminifera. *Paleoceanography* 9, 445-452.
- Linke, P., Pfannkuche, O., Karstensen, J., Beuck, L., 2006. Long-term observation of a cold water coral mound in the Porcupine Seabight and implications for the ESONET/CELTNET programme. Proc. 4th Int. Workshop on Scientific Use of Submarine Cables. Dublin, Ireland, pp. 6.
- Llames, M.E., Lagomarsino, L., Diovisalvi, N., Torremorell, A.M., Perez, G., Unrein, F., Bustingorry, J., Escaray, R., Ferraro, M., Zagarese, H.E., 2009. The effects of light availability in shallow, turbid waters: a mesocosm study. *Journal of Plankton Research* 31, 1517-1529.
- Lončarić, N., 2005. Planktic foraminiferal response to changing SE Atlantic oceanography. PhD thesis.
- Lukas, R., Hayes, S.P., Wyrski, K., 1984. Equatorial sea level response during the 1982-1983 El-Niño. *Journal of Geophysical Research* 89, 10425-10430.
- Mathien-Blard, E., Bassinot, F., 2009. Salinity bias on the foraminifera Mg/Ca thermometry: Correction procedure and implications for past ocean hydrographic reconstructions. *Geochemistry, Geophysics, Geosystems* 10, 17pp.
- Martin, J., Meybeck, M., 1979. Elemental mass-balance of material carried by major world rivers. *Marine Chemistry* 7, 173-206.
- Melchert, B., Paulick, H., 2008. Volcanic rocks. In: Cruise Report, Atalante Cruise Leg 2 – MARSUED VI, 2008, 52-57.
- Mienis, F., de Stigter, H.C., de Haas, H., van Weering, T.C.E., 2009. Near-bed particle deposition and resuspension in a cold-water coral mound area at the Southwest Rockall Trough margin, NE Atlantic. *Deep Sea Research* 56, 1026-1038.
- Millero, F. J., Lee, K., Roche, M., 1998. Distribution of alkalinity in the surface waters of the major Oceans. *Marine Chemistry* 60, 111 – 130.
- Milliman, J. D., 1993. Production and accumulation of calcium carbonate in the ocean: budget of an unsteady state. *Global Biogeochemical Cycles* 7, 927 – 957.
- Mittelstaedt, E., 1983. The upwelling area off Northwest Africa – a description of phenomena related to coastal upwelling. *Progress in Oceanography* 12, 307-331.
- Mittelstaedt, E., 1987. Cyclonic cold-core eddy in the eastern North Atlantic. I. Physical description. *Marine Ecology – Progress Series* 39, 145-152.
- Mittelstaedt, E., 1991. The ocean boundary along the northwest African coast: Circulation and oceanographic properties at the sea surface. *Oceanography* 26, 307-355.

- Mortyn, G., Elderfield, H., Anand, P., Greaves, M., 2005. An evaluation of controls on planktonic foraminiferal Sr/Ca: Comparison of water column and core-top data from a North Atlantic transect. *Geochemistry, Geophysics, Geosystems* 6, 12pp.
- Mucci, A., 1987. Influence of temperature on the composition of magnesian calcite overgrowth precipitated from seawater. *Geochimica et Cosmochimica Acta* 51, 1977-1984.
- Mulitza, S., Duerkopp, A., Hale, W., Wefer, G., Niebler, H. S., 1997. Planktonic foraminifera as recorders of past surface-water stratification. *Geology* 25, 335 – 338.
- Mulitza, S., Boltovskoy, D., Donner, B., Meggers, H., Paul, A., Wefer, G., 2003. Temperature: $\delta^{18}\text{O}$ relationships of planktonic foraminifera collected from surface waters. *Palaeogeography, Palaeoclimatology, Palaeoecology* 202, 143-152.
- Murray, J., 1897. On the distribution of the pelagic Foraminifera at the surface and on the floor of the Ocean. *Natural Science (ecology)* 11, 17-27.
- New, A. L., Smythe-Wright, D., 2001. Aspects of the circulation in the Rockall Trough. *Continental Shelf Research* 21, 777 – 810.
- Ni, Y., Foster, G., Bailey, T., Elliott, T., Schmidt, D., Pearson, P., Haley, B., Coath, C., 2007. A core-top assessment of proxies for the ocean carbonate system in surface-dwelling foraminifera. *Paleoceanography* 22, 14pp.
- Nikulina, A., Polovodova, I., Schönfeld, J., 2008. Foraminiferal response to environmental changes in Kiel Fjord, SW Baltic Sea. *eEarth* 3, 37 – 49.
- Noè, S., Beck, T., Foubert, A., Grehan, A., 2004. Surface Samples. In: Ratmeyer, V., Beck, T., Belling, R., Bergenthal, M., Beuck, L., Brakel, C., Buhmann, S., Dodds, L., Dorschel, B., Engemann, G., Foubert, A., Gault, J., Grehan, A., Hayn, C., Jurkiw, A., Kahl, G., Kaiser, J., Klar, S., Lutz, M., Noe, S., Papstein, H., Rüggeberg, A., Ruhland, G., Schewe, F., Schmidt, W., Schröder, M., Seiter, C., Truscheit, T., Wienberg, C. (Eds.), *Northeast Atlantic 2004 - Development of Carbonate Mounds on the Celtic Continental Margin*. Meteor Berichte 06-2, Cruise No.61, Leg 3, 22 – 23.
- Nürnberg, D., Bijma, J., Hemleben, C., 1996. Assessing the reliability of magnesium in foraminiferal calcite as a proxy for water mass temperature. *Geochimica et Cosmochimica Acta* 60, 803 – 814.
- Oberhänsli, H., Bènier, C., Meineke, G., Schmidt, H., Schneider, R., Wefer, G., 1992. Planktonic foraminifera as tracers of ocean currents in the eastern south Atlantic. *Paleoceanography* 7, 607-632.
- Ortiz, J. D., Mix, A. C., Collier, R. W., 1995. Environmental control of living symbiotic and asymbiotic foraminifera of the California Current. *Paleoceanography* 10, 987 – 1009.
- Ostlund, H., Craig, H., Broecker, W., Spencer, D., 1987. *GEOSECS Atlantic, Pacific, and Indian Ocean Expeditions. Volume 7: Shorebased data and graphics*. National Science Foundation.
- Ottens, J., 1991. Planktic foraminifera as north Atlantic water mass indicators. *Oceanologica Acta* 14, 123 – 140.
- Parker, F.L., 1960. Living planktonic foraminifera from the equatorial and south east Pacific, *Tohoku University Science Reports, Ser. 2, (4), 71–82*.

- Pflaumann, U., 2002. Distribution of planktonic foraminifera in the surface sediments of the Atlantic Ocean (ATL947), Pangaea, doi:10.1594/PANGAEA.77352
- Pingree, R. D., Le Cann, B., 1990. Structure, strength and seasonality of the slope currents in the Bay of Biscay region. *Journal of the Marine Biological Association of the United Kingdom* 70, 857 – 885.
- Pingree, R. D., 1993. Flow of surface waters to the west of the British Isles and in the Bay of Biscay. *Deep Sea Research II* 40, 369-388.
- Regenberg, M., Nürnberg, D., Steph, S., Groeneveld, J., Garbe-Schönberg, D., Tiedemann, R., Dullo, W.-C., 2006. Assessing the dissolution effect on planktonic foraminiferal Mg/Ca ratios: Evidence from Caribbean core-tops. *Geochemistry, Geophysics, Geosystems* 7, 23pp.
- Regenberg, M., Steph, S., Nürnberg, D., Tiedemann, R., Garbe-Schönberg, D., 2009. Calibrating Mg/Ca ratios of multiple planktonic foraminiferal species with $\delta^{18}\text{O}$ -calcification temperatures: Paleothermometry for the upper water column. *Earth and Planetary Science Letters* 278, 324-336.
- Regenberg, M., Nielsen, S., Kuhnt, W., Holbourn, A., Garbe-Schönberg, D., Andersen, N., 2010. Morphological, geochemical, and ecological differences of the extant menardiform planktonic foraminifera *Globorotalia menardii* and *Globorotalia cultrata*. *Marine Micropaleontology*, doi: 10.1016/j.marmicro.2010.01.002
- Retailleau, S., Howa, H., Schiebel, R., Lombard, L., Eynaud, F., Schmidt, S., Jorissen, F., Labeyrie, L., 2009. Planktic foraminiferal production along an offshore-onshore transect in the south-eastern Bay of Biscay. *Continental Shelf Research* 29, 1123-1135.
- Rhumbler, L., 1911. Die Foraminiferen (Thalamophoren) der Plankton-Expedition. Erster Teil: Die allgemeinen Organisations-Verhältnisse der Foraminiferen. *Ergebnisse der Humboldt-Stiftung* 3, 331pp.
- Richardson, P.L., Reverdin, G., 1987. Seasonal cycle of velocity in the Atlantic North Equatorial Countercurrent as measured by surface drifters, current meters, and ship drifts. *Journal of Geophysical Research* 92, 3691-3708.
- Riebesell, U., Zondervan, I., Rost, B., Tortell, P., Zeebe, R., Morel, F., 2000. Reduced calcification of marine plankton in response to increased atmospheric CO_2 . *Nature* 407, 364 – 367.
- Rink, S., Kühl, M., Bijma, J., Spero, H., 1998. Microsensor studies of photosynthesis and respiration in the symbiotic foraminifer *Orbulina universa*. *Marine Biology* 131, 583-595.
- Ripa, P., Hayes, S.P., 1981. Evidence for equatorial trapped waves at the Galapagos Islands. *Journal of Geophysical Research* 86, 6509-6515.
- Rosenthal, Y., Boyle, E., 1983. Factor controlling the fluoride content of planktonic foraminifera: an evaluation of its paleoceanographic applicability. *Geochimica et Cosmochimica Acta* 57, 335-346.
- Royal Society, 2005. Ocean acidification due to increasing atmospheric carbon dioxide.

- Rüggeberg, A., Dodds, L., 2004. Hydrography in the Belgica Mound Province. In: Ratmeyer, V., Beck, T., Belling, R., Bergenthal, M., Beuck, L., Brakel, C., Buhmann, S., Dodds, L., Dorschel, B., Engemann, G., Foubert, A., Gault, J., Grehan, A., Hayn, C., Jurkiw, A., Kahl, G., Kaiser, J., Klar, S., Lutz, M., Noe, S., Papstein, H., Rüggeberg, A., Ruhland, G., Schewe, F., Schmidt, W., Schröder, M., Seiter, C., Truscheit, T., Wienberg, C. (Eds.), Northeast Atlantic 2004 - Development of Carbonate Mounds on the Celtic Continental Margin. Meteor Berichte 06-2, Cruise No.61, Leg 3, 20 – 21.
- Russell, A., Hönlisch, B., Spero, H., Lea, D., 2004. Effects of seawater carbonate ion concentration and temperature on shell U, Mg, and Sr in cultured planktonic foraminifera. *Geochimica et Cosmochimica Acta* 68, 4347-4361.
- Sadekov, A., Eggins, S., DeDeckker, P., Kroon, D., 2008. Uncertainties in seawater thermometry deriving from intratest and intertest Mg/Ca variability in *Globigerinoides ruber*. *Paleoceanography* 23, 12 pp.
- Sadekov, A., Eggins, S., DeDeckker, P., Ninnemann, U., Kuhnt, W., Bassinot, F., 2009. Surface and subsurface seawater temperature reconstruction using Mg/Ca microanalysis of planktonic foraminifera *Globigerinoides ruber*, *Globigerinoides sacculifer*, and *Pulleniatina obliquiloculata*. *Paleoceanography* 24, 17pp.
- Saito, T., Thompson, P. R., Breger, D., 1981. Systematic index of Recent and Pleistocene planktonic Foraminifera. University of Tokyo Press, Japan. 251pp.
- Sanyal, A., Hemming, N., Broecker, W., Lea, D., Spero, H., Hanson, G., 1996. Oceanic pH control on the boron isotopic composition of foraminifera: Evidence from culture experiments. *Paleoceanography* 11, 513-517.
- Sanyal, A., Hemming, N., Broecker, W., 1997. Changes in pH in the eastern equatorial Pacific across stage 5-6 boundary based on boron isotopes in foraminifera. *Global biogeochemical Cycles* 11, 125-133.
- Sanyal, A., Bijma, J., 1999. A comparative study of northwest Africa and eastern equatorial Pacific upwelling zones as sources of CO₂ during glacial periods based on boron isotope paleo-pH estimation. *Paleoceanography* 14, 753-759.
- Schiebel, R., Hiller, B., Hemleben, C., 1995. Impacts of storms on Recent planktic foraminiferal test production and CaCO₃ flux in the North Atlantic at 47°N, 20°W (JGOFS). *Marine Micropaleontology* 26, 115 – 129.
- Schiebel, R., Hemleben, C., 2000. Interannual variability of planktonic foraminiferal populations and test flux in the eastern North Atlantic Ocean (JGOFS). *Deep Sea Research II* 47, 1809 – 1852.
- Schiebel, R., Waniek, J., Bork, M., Hemleben, C., 2001. Planktic foraminiferal production stimulated by chlorophyll redistribution and entrainment of nutrients. *Deep Sea Research I* 48, 721 – 740
- Schiebel, R., 2002. Planktic foraminiferal sedimentation in the marine calcite budget. *Global Biogeochemical Cycles* 16.
- Schiebel, R., Hemleben, C., 2005. Modern planktic foraminifera. *Paläontologische Zeitschrift* 79, 135 – 148

- Schönfeld, J., Numberger, L., 2007. The benthic foraminiferal response to the 2004 spring bloom in the western Baltic Sea. *Marine Micropaleontology* 65, 78 – 95.
- Schott, W., 1937. Die Foraminiferen in dem äquatorialen Teil des Atlantischen Ozeans. In: Defant, A. (Ed.), *Wissenschaftliche Ergebnisse III, Deutsche Atlantische Expedition der METEOR 1925-1927*, 1-132.
- Shackleton, N., 1974. Attainment of isotopic equilibrium between ocean water and the benthonic foraminifera genus *Uvigerina*: Isotopic changes in the ocean during the last glacial. *Colloq. Int. CNRS* 219, 203-209.
- Spindler, M., Hemleben, C., Bayer, U., Bè, A.W.H., Anderson, O., 1979. Lunar periodicity of reproduction in the planktonic foraminifer *Hastigerina pelagica*. *Marine ecology* 1, 61-64.
- Siegel, D.A., Deuser, W.G., 1997. Trajectories of sinking particles in the Sargasso Sea: modeling of statistical funnels above deep-ocean sediment traps. *Deep Sea Research* 44, No. 9-10, 1519-1541.
- Spivack, A., You, C., Smith, H., 1993. Foraminiferal boron isotope ratios as a proxy for surface ocean pH over the past 21 Myr. *Nature* 363, 149-151.
- Steph, S., Regenberg, M., Tiedemann, R., Mulitza, S., Nürnberg, D., 2009. Stable isotopes of planktonic foraminifera from tropical Atlantic/Caribbean core-tops: Implications for reconstructing upper ocean stratigraphy. *Marine Micropaleontology* 71, 1-19.
- Stramma, L., Siedler, G., 1988. Seasonal changes in the North Atlantic sub-tropical gyre. *Journal of Geophysical Research* 93, 8111-8118.
- Stramma, L., Schott, F., 1999. The mean flow field of the tropical Atlantic Ocean. *Deep Sea Research II* 46, 279-303.
- Stramma, L., Fischer, J., Brandt, P., Schott, F., 2003. Circulation, variability and near-equatorial meridional flow in the central tropical Atlantic. *Elsevier Oceanography Series* 68, 22 pp.
- Stramma, L., Hüttl, S., Schafstall, J., 2005. Water masses and currents in the upper tropical northeast Atlantic off northwest Africa. *Journal of Geophysical Research* 110, C12006, doi: 10.1029/2005JC002939.
- Takashi, K., Bè, A. W. H., 1984. Planktonic foraminifera – factors controlling sinking speed. *Deep Sea Research* 31, 1477 – 1500
- Tedesco, K.A., Thunnell, R.C., 2003. Seasonal and Interannual variations in planktonic foraminiferal flux and assemblage composition in the Cariaco Basin, Venezuela. *Journal of Foraminiferal Research* 33, 192-210.
- Thomsen, L., 1998. Prozesse in der Bodengrenzschicht an Kontinentalhängen und ihre Bedeutung für den benthischen Kohlenstoffkreislauf. *Habilitationsschrift an der Mathematisch-Naturwissenschaftlichen Fakultät der Christian-Albrechts-Universität zu Kiel*, 1998.
- van Weering, Tj. C. E., Hall, I. R., de Stigter, H. C., McCave, I. N., Thomson, L., 1998. Recent sediments, sediment accumulation and carbon burial at Goban Spur, N.W. European Continental Margin (47-50°N). *Progress in Oceanography* 42, 5 – 35.
- Volkman, R., 2000. Planktonic foraminifers in the outer Laptev Sea and the Fram Strait - modern distribution and ecology. *Journal of Foraminiferal Research* 30, 157-176.

- Wattenberg, H., 1932. Das chemische Beobachtungsmaterial und seine Gewinnung – Kalziumkarbonat- und Kohlensäuregehalt des Meerwassers. In: Defant, A. (Ed.), *Wissenschaftliche Ergebnisse VIII, Deutsche Atlantische Expedition der METEOR 1925-1927*, 1-333.
- Weisberg, R. H., Weingartner, T.J., 1988. Instability waves in the equatorial Atlantic Ocean. *Journal of Physical Oceanography* 18, 1641-1657.
- Weldeab, S., Schneider, R., Müller, P., 2007. Comparison of Mg/Ca- and alkenone-based sea surface temperature estimates in the fresh water-influenced Gulf of Guinea, eastern equatorial Atlantic. *Geochemistry, Geophysics, Geosystems* 8, 10pp.
- White, M., 2007. Benthic dynamics at the carbonate mound regions of the Porcupine Sea Bight continental margin. *Geologische Rundschau* 96, 1 – 9.
- Wilke, I., Meggers, H., Bickert, T., 2009. Depth habitats and seasonal distributions of recent planktic foraminifers in the Canary Islands region (29°N) based on oxygen isotopes. *Deep Sea Research I* 56, 89-106.
- Yu, J., Elderfield, H., Zhangdong, J., Booth, L., 2008. A strong temperature effect on U/Ca in planktonic foraminiferal carbonates. *Geochimica et Cosmochimica Acta* 72, 4988-5000.
- Yu, J., Elderfield, H., Hönisch, B., 2008. B/Ca in planktonic foraminifera as a proxy for surface seawater pH. *Paleoceanography* 22, 17pp.
- Zhou, M., Paduan, J.D., Niiler, P.P., 2000. Surface currents in the Canary Basin from drifter Observations. *Journal of Geophysical Research* 105, 21893-21911.

APPENDIX

Appendix 1

Appendix 1. Faunal composition [%] of planktonic foraminifera from Galway Mound sediment trap and core-top.

Species [%]	TF 2	TF 5	TF 6	TF 7	TF 8	TF 9	TF 10	TF 11	TF 12	TF 13	M61/3-552
<i>O. universa</i>	0	0	0	0	0	0	0	0	0	0	1
<i>G. scitula</i>	0	3	0	0	0	0	2	0	4	0	0
<i>G. hirsuta</i>	6	43	21	25	14	12	1	8	10	0	0
<i>G. inflata</i>	5	1	2	4	2	3	4	4	4	4	18
<i>N. incompta</i>	58	11	42	24	35	32	45	54	52	39	47
<i>G. bulloides</i>	5	11	9	5	2	9	8	8	7	35	17
<i>G. glutinata</i>	24	16	13	33	20	15	15	13	4	4	10
<i>G. siphonifera</i>	1	4	4	5	0	3	0	0	0	1	2
<i>T. quinqueloba</i>	2	5	9	5	18	9	19	13	15	17	5
other	0	7	0	0	8	18	5	0	4	0	0
total* (1/4 Split)	121	76	53	80	49	34	145	24	73	119	
total*	484	304	212	320	196	136	580	96	292	476	86048

* number of specimen

Appendix 2

Appendix 2.1. Faunal composition [%] from central Atlantic Ocean. Specimen >100 µm were considered.

Sample	Depth	<i>G. menardii</i>	<i>G. ruber</i> white	<i>G. ruber</i> pink	<i>O. universa</i>	<i>G. sacculifer</i>	<i>G. glutinata</i>	<i>G. rubescens</i>	<i>Globigerinella</i> <i>spp.</i>	<i>T. parkerae</i>	<i>S. globigerus</i>	<i>P. obliquiloculata</i>	<i>G. scitula</i>	<i>T. quinqueloba</i>	<i>D. anfracta</i>	total*
TP1	0-10m	40	20	0	0	40	0	0	0	0	0	0	0	0	0	5
	10-20m	10	10	10	0	0	60	10	0	0	0	0	0	0	0	10
	20-30m	33	0	0	0	33	22	0	0	11	0	0	0	0	0	9
	30-40m	22	0	0	0	22	44	0	0	0	0	0	0	11	0	9
	40-50m	17	0	0	0	33	50	0	0	0	0	0	0	0	0	6
TP2	0-10m	0	18	23	5	45	9	0	0	0	0	0	0	0	0	22
	10-20m	5	0	5	0	82	0	9	0	0	0	0	0	0	0	22
	20-30m	15	0	38	8	8	31	0	0	0	0	0	0	0	0	13
TP3	0-10m	0	0	44	11	33	0	0	11	0	0	0	0	0	0	9
	10-20m	0	8	15	0	23	15	0	0	0	15	0	15	8	0	13
	20-30m	0	0	9	0	55	9	18	0	0	0	0	9	0	0	11
	30-40m	41	0	6	0	35	0	6	0	6	0	6	0	0	0	17
	40-50m	6	0	0	18	53	6	18	0	0	0	0	0	0	0	17
TP4	0-10m	0	10	0	0	80	0	0	0	0	0	0	0	0	10	10
	10-20m	0	21	14	0	36	14	14	0	0	0	0	0	0	0	14
	20-30m	0	10	20	0	30	10	10	10	0	0	0	0	10	0	10
	30-40m	0	0	75	0	25	0	0	0	0	0	0	0	0	0	4
	40-50m	13	0	13	0	25	50	0	0	0	0	0	0	0	0	8

* number of specimen

Appendix 2.2. Faunal composition [%] from Cape Verde region. Specimen >100 µm were considered.

Sample	Depth	<i>G. menardii</i>	<i>G. ruber</i> white	<i>G. ruber</i> pink	<i>O. universa</i>	<i>G. sacculifer</i>	<i>G. glutinata</i>	<i>G. rubescens</i>	<i>Globigerinella</i> spp.	<i>T. parkerae</i>	<i>G. tenella</i>	<i>N. dutertrei</i>	<i>T. quinqueloba</i>	<i>G. minuta</i>	<i>H. pelagica</i>	other	total*
CV 1	0-10m	22	33	0	0	22	11	0	11	0	0	0	0	0	0	0	9
	10-20m	0	33	17	0	50	0	0	0	0	0	0	0	0	0	0	6
	20-30m	11	0	0	0	44	11	11	11	11	0	0	0	0	0	0	9
	30-40m	38	13	13	0	13	0	0	0	0	0	0	0	0	0	25	8
CV 2	0-10m	27	13	7	0	13	7	7	7	0	13	7	0	0	0	0	15
	10-20m	24	9	9	3	24	15	3	3	3	0	9	0	0	0	0	34
	20-30m	11	22	6	6	33	11	0	0	11	0	0	0	0	0	0	18
	30-40m	38	4	8	0	19	12	15	0	0	0	4	0	0	0	0	26
	40-50m	18	5	3	0	42	11	16	3	0	0	3	0	0	0	0	38
CV 3	50-70m	14	11	11	4	46	0	0	0	0	0	14	0	0	0	0	28
	0-10m	24	0	0	0	41	6	0	0	0	0	24	0	0	6	0	17
	10-20m	45	3	0	0	28	0	7	7	0	0	0	0	0	0	10	29
	20-30m	31	0	5	0	36	0	5	5	5	0	10	0	0	3	0	39
	30-40m	39	4	0	0	36	7	0	4	0	0	4	0	0	0	7	28
CV 4	40-50m	66	4	1	0	11	3	1	7	0	1	7	0	0	0	0	76
	50-70m	28	5	0	10	41	0	0	10	0	0	5	0	0	0	0	39
	0-10m	45	3	0	0	38	5	0	3	5	0	3	0	0	0	0	40
	10-20m	66	3	0	0	20	0	0	0	3	0	6	0	0	0	3	35
	20-30m	65	0	3	5	16	5	0	5	0	0	0	0	0	0	0	37
CV 6	30-40m	58	0	0	10	16	3	0	3	0	3	0	3	0	0	3	31
	40-50m	60	0	0	4	20	2	2	7	2	0	2	0	0	0	0	45
	50-70m	79	0	0	5	11	1	0	2	0	0	1	0	0	0	0	151
	0-10m	14	14	3	6	39	6	6	3	3	0	0	6	0	0	3	36
	10-20m	19	26	0	13	19	10	6	3	0	0	3	0	0	0	0	31
CV 7	20-30m	9	13	13	0	43	0	4	9	0	0	9	0	0	0	0	23
	30-40m	29	3	10	3	32	10	3	10	0	0	0	0	0	0	0	31
	40-50m	19	9	6	0	22	9	16	6	0	0	9	0	0	0	3	32
	50-70m	14	10	8	6	27	24	10	0	0	0	0	0	0	0	0	49
	0-10m	16	18	14	4	16	12	10	8	0	0	2	0	0	0	0	50
CV 7	10-20m	3	8	6	3	33	6	26	11	0	0	1	0	0	0	3	72
	20-30m	8	26	2	3	8	25	11	11	0	0	3	0	0	0	2	61

*number of specimen

Appendix 3.

Trace element distribution

Appendix 3.1. Trace element distribution of *G. sacculifer*. Mg/Ca, Al/Ca, Mn/Ca, Sr/Ca and Zn/Ca are given in mmol/mol. Ba/Ca and B/Ca in $\mu\text{mol/mol}$ and U/Ca in nmol/mol.

	Test size		Laser								
	[μm]	Chamber	diameter [μm]	B/Ca	Mg/Ca	Al/Ca	Mn/Ca	Zn/Ca	Sr/Ca	Ba/Ca	U/Ca
TP 4 0-10m (a)	360	F	50	214,73	3,83	0,00	0,00	0,03	1,74	2,74	10,51
		F	50	160,60	3,79	0,00	0,00	0,03	1,55	2,04	6,73
		F-1	50	206,00	5,00	0,00	0,01	0,05	1,75	2,70	10,93
		F-2	50	271,15	4,40	0,00	0,00	0,05	1,76	3,78	9,25
TP 4 0-10m (b)	380	F	50	207,03	3,38	0,00	0,00	0,02	1,50	2,45	9,82
		F	50	167,02	3,73	0,00	0,00	0,02	1,56	2,53	7,26
		F-1	50	209,39	4,48	0,00	0,00	0,03	1,54	2,42	9,48
		F-1	50	213,25	3,84	0,00	0,00	0,03	1,60	2,59	12,83
CV4 0-10m	240	F	50	210,47	4,18	0,00	0,00	0,04	1,53	2,31	9,60
		F	50	136,20	2,69	0,00	0,00	0,04	1,51	2,46	4,32
		F	50	170,26	2,72	0,00	0,00	0,03	1,55	2,59	3,42
		F-1	50	163,82	3,29	0,00	0,00	0,03	1,49	3,07	7,71
CV7 0-10m	220	F	50	189,96	3,83	0,00	0,00	0,10	1,60	7,15	5,26
		F	50	114,87	3,62	0,00	0,01	0,04	1,44	3,25	5,44
		F	50	111,71	4,33	0,00	0,01	0,03	1,41	2,32	8,12
		F-1	50	156,06	3,51	0,00	0,01	0,04	1,66	3,57	10,54
CV4 50-70m	500	F	50	134,98	2,97	0,00	0,00	0,04	1,44	3,01	7,49
		F	50	166,69	2,71	0,00	0,00	0,00	1,31	1,83	9,64
		F	50	135,94	2,91	0,00	0,00	0,00	1,47	1,93	6,44
		F-1	50	134,11	4,12	0,00	0,00	0,00	1,34	1,80	11,87
CV4 50-70m	300	F-1	50	160,11	3,70	0,00	0,00	0,00	1,36	1,08	9,86
		F-2	50	119,47	3,31	0,00	0,00	0,00	1,20	1,09	12,39
		F	50	129,09	3,87	0,00	0,00	0,01	1,36	1,46	11,26
		F-1	50	153,23	3,32	0,00	0,00	0,00	1,37	1,40	8,45
TP3000	680	F-2	50	152,98	3,46	0,00	0,00	0,00	1,57	1,56	6,49
		F	50	114,38	5,84	0,63	0,11	0,54	1,67	33,97	24,70
		F	50	129,73	4,91	0,26	0,10	0,22	1,50	21,51	8,29
		F-1	50	98,70	5,06	0,05	0,04	0,13	1,37	20,48	9,23
			50	119,86	4,60	0,04	0,03	0,07	1,35	27,79	13,78
				F-2	132,56	5,00	0,04	0,06	0,13	1,37	11,93

F= final chamber, F-1=second youngest chamber, F-2=third youngest chamber

Appendix 3.2. Trace element distribution of *G. menardii*. Mg/Ca, Al/Ca, Mn/Ca, Sr/Ca and Zn/Ca are given in mmol/mol. Ba/Ca and B/Ca in $\mu\text{mol/mol}$ and U/Ca in nmol/mol.

	Test size		Laser								
	[μm]	Chamber	diameter [μm]	B/Ca	Mg/Ca	Al/Ca	Mn/Ca	Zn/Ca	Sr/Ca	Ba/Ca	U/Ca
CV4 50-70m	840	F	75	93,10	3,26	0,03	0,02	0,02	1,38	4,12	28,48
		F	75	89,26	3,06	0,01	0,01	0,02	1,31	4,18	30,37
		F	50	124,37	3,88	0,02	0,02	0,01	1,60	3,30	28,25
		F-1	50	104,51	2,27	0,01	0,00	0,01	1,29	3,05	17,54
		F-1	50	106,45	2,57	0,01	0,01	0,00	1,32	3,33	27,40
		F-2	50	153,07	3,64	0,07	0,01	0,01	1,28	3,11	25,92
CV4 50-70m	840	Lip	15	76,34	2,87	0,01	0,00	0,00	1,03	1,36	18,59
CV4 50-70m	520	F	50	181,34	3,50	0,54	0,00	0,05	1,98	7,16	45,02
		F	50	190,17	4,91	0,10	0,00	0,18	1,62	13,44	47,09
		F-1	50	161,35	5,36	0,03	0,01	0,06	1,75	6,63	70,82
CV4 50-70m	1000	F-2	50	175,76	2,63	0,01	0,01	0,01	1,40	2,76	15,88
		F	50	77,47	4,58	0,01	0,02	0,01	1,51	6,01	34,34
		F	50	75,20	3,93	0,01	0,02	0,01	1,42	6,97	34,06
		F-1	50	88,83	4,46	0,00	0,02	0,00	1,38	13,40	19,99
		F-1	50	90,64	4,40	0,00	0,01	0,01	1,40	14,14	24,97
		F-2	50	82,85	3,00	0,00	0,01	0,01	1,25	8,58	9,75
CV4 0-10m	540	F-2	50	88,26	4,00	0,00	0,01	0,01	1,29	11,59	22,10
		F	50	121,70	4,59	0,16	0,01	0,07	1,15	6,07	91,05
		F	50	132,76	3,63	0,04	0,00	0,04	1,15	6,40	50,00
		F-1	50	180,65	3,02	0,02	0,00	0,06	1,34	7,08	51,83
		F-2	50	185,37	5,34	0,02	0,01	0,05	1,58	10,10	90,32
		F-3	50	296,26	6,48	0,17	0,02	0,09	2,55	15,91	191,94
CV4 0-10m	420	F	50	117,78	2,76	0,01	0,00	0,05	1,62	2,70	27,00
		F	50	159,33	7,96	0,05	0,01	0,02	1,32	2,81	29,99
		F-1	50	206,75	5,93	0,85	0,04	0,07	1,33	12,17	55,15
		F-1	50	126,17	3,97	0,07	0,02	0,33	1,10	2,84	29,40
		F-2	50	156,98	3,32	0,00	0,01	0,01	1,53	2,19	10,74
		F	50	52,60	2,01	0,00	0,01	0,02	1,18	9,24	23,56
CV7 0-10m	650	F	50	80,45	2,12	0,00	0,01	0,01	1,10	6,97	23,17
		F-1	50	92,23	2,44	0,00	0,03	0,01	0,90	12,35	12,75
		F-2	50	136,90	4,88	0,00	0,03	0,01	1,37	48,88	18,65
		F (keel)	25	67,91	1,34	0,00	0,00	0,00	1,27	3,22	14,64
CV7 0-10m	650	F-1	25	144,45	3,05	0,01	0,00	0,00	1,01	3,00	3,42
		F-2	25	90,06	4,84	0,00	0,00	0,00	1,54	5,13	1,95
		F	50	70,61	3,28	0,03	0,02	0,02	0,98	11,25	20,10
TP 3 30-40m	920	F	50	78,65	3,08	0,00	0,02	0,02	1,48	7,06	29,96
		F-1	50	85,72	3,38	0,00	0,02	0,03	1,11	29,27	23,54
		F-1	50	76,61	3,16	0,03	0,03	0,03	1,22	26,14	19,80
		F-2	50	83,91	2,91	0,00	0,02	0,02	1,23	24,29	20,10
		F (keel)	35	82,59	1,50	0,00	0,00	0,00	0,94	1,51	4,89
		F-1	25	95,99	1,77	0,00	0,00	0,00	1,22	9,19	4,93
TP3000	600	F-2	25	116,85	2,45	0,00	0,00	0,00	1,15	9,55	9,93
		F (keel)	35	48,43	1,74	0,00	0,01	0,01	1,15	0,95	8,73
		F-1	35	50,26	0,87	0,01	0,01	0,01	1,10	5,74	7,39
TP3000	600	F-2	35	61,94	0,75	0,00	0,00	0,01	1,37	3,41	1,94
		F	50	57,96	6,81	0,04	0,02	0,04	1,38	6,71	21,11
		F	50	60,55	6,01	0,04	0,03	0,04	1,29	5,81	31,44
		F-1	50	58,39	3,67	0,01	0,02	0,02	1,38	2,75	34,42
		F-1	25	51,18	1,58	0,00	0,00	0,00	1,05	0,29	1,84
		F-2	50	48,09	1,58	0,01	0,01	0,02	1,29	1,74	72,28
		F-2	25	44,69	1,30	0,00	0,00	0,01	1,39	0,96	1,83

F= final chamber, F-1=second youngest chamber, F-2=third youngest chamber

Appendix 3.3. Trace element distribution of *G. hirsuta*. Mg/Ca, Al/Ca, Mn/Ca, Sr/Ca and Zn/Ca are given in mmol/mol. Ba/Ca and B/Ca in $\mu\text{mol/mol}$ and U/Ca in nmol/mol.

	Test size		Laser		B/Ca	Mg/Ca	Al/Ca	Mn/Ca	Zn/Ca	Sr/Ca	Ba/Ca	U/Ca
	$[\mu\text{m}]$	Chamber	diameter $[\mu\text{m}]$									
M61/1-245 TF 2	580	F	50	100,93	2,38	0,00	0,01	0,01	1,95	25,05	22,70	
		F	75	107,59	2,74	0,01	0,01	0,03	1,89	26,65	16,81	
		F-1	50	101,96	3,73	0,01	0,01	0,01	1,85	10,74	23,96	
		F-1	50	91,32	3,61	0,02	0,01	0,01	1,89	15,12	19,34	
		F-2	50	129,88	3,38	0,00	0,00	0,01	1,80	8,40	8,83	
M61/1-245 TF 6	680	F	50	70,92	4,55	0,00	0,01	0,01	1,31	19,46	18,86	
		F	50	69,68	3,87	0,00	0,01	0,02	1,37	20,84	30,17	
		F-1	50	58,14	2,30	0,00	0,01	0,01	1,10	32,11	17,82	
		F-1	50	65,28	1,87	0,00	0,00	0,01	1,15	5,44	7,59	
		F-2	75	83,48	2,15	0,00	0,01	0,01	1,27	23,08	10,27	
M61/1-245 TF 12	640	F	50	109,41	3,63	0,00	0,01	0,04	1,66	91,35	36,09	
		F	50	65,13	1,01	0,00	0,00	0,00	1,13	5,97	5,25	
		F	50	76,43	1,58	0,01	0,01	0,00	1,21	7,09	7,47	
		F-1	50	75,28	2,53	0,01	0,01	0,01	1,08	7,41	5,36	
		F-1	50	53,70	1,52	0,00	0,00	0,00	1,03	1,76	2,86	
		F-2	50	56,01	0,92	0,00	0,00	0,00	0,96	0,90	1,90	
		F-2	50	89,08	1,01	0,00	0,00	0,00	1,01	0,79	1,09	

F= final chamber, F-1=second youngest chamber, F-2=third youngest chamber

Appendix 3.4. Trace element distribution of *G. crassaformis*. Mg/Ca, Al/Ca, Mn/Ca, Sr/Ca and Zn/Ca are given in mmol/mol. Ba/Ca and B/Ca in $\mu\text{mol/mol}$ and U/Ca in nmol/mol.

	Test size		Laser		B/Ca	Mg/Ca	Al/Ca	Mn/Ca	Zn/Ca	Sr/Ca	Ba/Ca	U/Ca
	$[\mu\text{m}]$	Chamber	diameter $[\mu\text{m}]$									
TP3000	500	F	50	61,32	2,33	0,06	0,06	0,14	1,48	10,55	29,69	
		F	50	68,33	2,44	0,07	0,06	0,25	1,72	19,42	35,48	
		F-1	50	54,70	1,83	0,02	0,01	0,03	1,32	14,87	6,17	
		F-1	50	49,59	0,96	0,01	0,00	0,01	1,07	4,38	0,88	
		F-2	50	46,57	1,08	0,03	0,01	0,01	1,06	3,71	1,54	
		F-2	50	56,94	1,05	0,02	0,01	0,04	1,27	2,69	3,29	

F= final chamber, F-1=second youngest chamber, F-2=third youngest chamber

Appendix 3.5. Trace element distribution of *G. ruber* pink. Mg/Ca, Al/Ca, Mn/Ca, Sr/Ca and Zn/Ca are given in mmol/mol. Ba/Ca and B/Ca in $\mu\text{mol/mol}$ and U/Ca in nmol/mol.

	Test size		Laser		B/Ca	Mg/Ca	Al/Ca	Mn/Ca	Zn/Ca	Sr/Ca	Ba/Ca	U/Ca
	$[\mu\text{m}]$	Chamber	diameter $[\mu\text{m}]$									
CV7 0-10m	360	F	50	140,31	2,96	0,02	0,00	0,01	1,28	1,07	10,36	
		F	50	134,17	3,34	0,00	0,00	0,02	1,22	2,26	12,02	
		F-1	50	221,76	4,53	0,00	0,00	0,03	1,35	2,03	14,24	
		F-1	50	220,00	4,78	0,00	0,00	0,03	1,31	2,59	15,40	
		F-2	50	223,76	5,26	0,00	0,00	0,03	1,33	3,27	21,75	
TP3000	400	F	50	130,90	5,44	0,01	0,12	0,14	1,29	6,71	18,55	
		F	50	152,38	4,12	0,03	0,10	0,17	1,24	11,40	14,32	
		F-1	75	186,23	4,76	0,04	0,08	0,14	1,36	37,42	19,66	
		F-2	75	225,56	6,87	0,04	0,10	0,15	1,40	14,37	24,89	

F= final chamber, F-1=second youngest chamber, F-2=third youngest chamber

Appendix 3.6. Trace element distribution of *N. dutertrei*. Mg/Ca, Al/Ca, Mn/Ca, Sr/Ca and Zn/Ca are given in mmol/mol. Ba/Ca and B/Ca in $\mu\text{mol/mol}$ and U/Ca in nmol/mol.

	Test size		Laser								
	$[\mu\text{m}]$	Chamber	diameter $[\mu\text{m}]$	B/Ca	Mg/Ca	Al/Ca	Mn/Ca	Zn/Ca	Sr/Ca	Ba/Ca	U/Ca
CV3 20-30m	480	F	50	89,77	6,44	0,00	0,01	0,00	1,21	2,75	30,89
		F	50	86,41	6,70	0,01	0,01	0,01	1,30	5,46	34,15
		F-1	50	73,29	4,55	0,00	0,01	0,01	1,19	18,70	26,70
		F-1	50	82,97	4,79	0,01	0,01	0,01	1,27	17,69	24,15
		F-2	50	75,52	3,51	0,00	0,00	0,01	1,11	11,71	18,22
		F-2	50	66,61	4,42	0,00	0,00	0,01	0,86	5,28	21,22
		F-3	50	78,18	3,10	0,00	0,00	0,02	0,86	5,34	13,93
TP3000	480	F	50	66,39	3,43	0,01	0,03	0,04	1,36	2,75	12,73
		F	50	73,74	3,47	0,02	0,03	0,02	1,38	2,61	14,73
		F-1	35	57,96	1,40	0,01	0,01	0,01	1,19	1,38	4,59
		F-1	35	68,01	1,17	0,01	0,00	0,01	1,34	1,14	1,29
		F-2	35	71,58	1,41	0,01	0,00	0,01	1,31	1,02	4,49
		F-2	35	80,96	1,04	0,00	0,00	0,01	1,52	2,66	1,85
TP3000	460	F	50	77,83	0,67	0,00	0,01	0,01	1,34	1,16	3,33
		F-1	50	88,54	0,74	0,01	0,00	0,01	1,46	2,06	4,92
		F-2	50	68,83	2,09	0,02	0,04	0,08	1,35	4,62	13,72
		F-3	50	71,07	2,11	0,06	0,01	0,04	1,43	5,10	9,85
		F-4	50	59,02	1,17	0,02	0,01	0,02	1,46	1,83	4,55

F= final chamber, F-1=second youngest chamber, F-2=third youngest chamber

Appendix 3.7. Trace element distribution of *G. bulloides*. Mg/Ca, Al/Ca, Mn/Ca, Sr/Ca and Zn/Ca are given in mmol/mol. Ba/Ca and B/Ca in $\mu\text{mol/mol}$ and U/Ca in nmol/mol.

	Test size		Laser								
	$[\mu\text{m}]$	Chamber	diameter $[\mu\text{m}]$	B/Ca	Mg/Ca	Al/Ca	Mn/Ca	Zn/Ca	Sr/Ca	Ba/Ca	U/Ca
M61/3-552	450	F	50	64,85	3,02	0,47	0,01	0,05	1,31	10,42	14,82
		F	50	100,17	1,91	0,25	0,01	0,01	1,03	1,21	12,29
		F-1	50	159,62	3,64	0,76	0,02	0,02	1,23	9,62	82,12
		F-1	50	137,87	7,10	2,74	0,07	0,03	1,20	15,58	61,85
		F-2	50	256,14	10,83	3,00	0,12	0,06	1,31	19,37	80,26
		F-2	50	184,21	10,37	6,92	0,11	0,05	1,39	27,63	86,87
M61/1-245 TF 13a 320	320	F	50	51,59	3,43	0,00	0,00	0,00	1,29	1,35	12,50
		F	50	54,74	3,32	0,00	0,00	0,00	1,39	1,24	10,61
		F-1	50	59,40	4,43	0,00	0,00	0,00	1,38	1,32	22,25
		F-1	50	75,07	4,83	0,00	0,00	0,00	1,40	1,95	17,70
		F-2	50	62,03	4,40	0,01	0,00	0,00	1,29	1,56	22,28
		F-2	50	62,99	3,21	0,02	0,00	0,00	1,50	1,65	19,03
		F-3	50	56,02	5,47	0,00	0,00	0,00	1,49	1,95	26,68
M61/1-245 TF 13b 350	350	F	50	87,29	1,01	0,00	0,00	0,00	1,28	0,84	6,31
		F	50	91,73	1,21	0,03	0,00	0,01	1,32	1,67	4,20
		F-1	50	96,70	1,89	0,04	0,00	0,01	1,30	1,36	5,93
		F-1	50	89,83	1,76	0,01	0,00	0,01	1,23	1,42	6,53
		F-2	50	64,77	1,60	0,00	0,00	0,00	1,20	1,28	4,17
		F-2	50	71,42	2,12	0,00	0,00	0,00	1,39	0,99	4,87
		F-3	50	71,67	2,41	0,01	0,00	0,00	1,37	1,37	6,43

F= final chamber, F-1=second youngest chamber, F-2=third youngest chamber

Appendix 3.8. Trace element distribution of *N. incompta*. Mg/Ca, Al/Ca, Mn/Ca, Sr/Ca and Zn/Ca are given in mmol/mol. Ba/Ca and B/Ca in $\mu\text{mol/mol}$ and U/Ca in nmol/mol.

	Test size [μm]	Laser		B/Ca	Mg/Ca	Al/Ca	Mn/Ca	Zn/Ca	Sr/Ca	Ba/Ca	U/Ca
		Chamber	diameter [μm]								
M61/1-245 TF 12a	320	F	50	104,02	4,57	0,00	0,00	0,01	1,43	3,02	24,07
		F	50	112,50	3,99	0,00	0,00	0,01	1,34	2,49	16,04
		F-1	50	105,58	3,20	0,41	0,00	0,01	1,28	2,63	13,09
		F-2	50	83,67	1,86	0,01	0,00	0,02	1,32	4,20	7,45
M61/1-245 TF 12b	340	F	50	78,36	1,49	0,01	0,00	0,00	1,22	1,49	2,88
		F	50	79,13	1,09	0,00	0,00	0,00	1,36	0,89	2,54
		F-1	50	152,71	3,75	0,01	0,00	0,03	1,40	2,83	9,94
		F-2	50	71,34	1,11	0,00	0,00	0,00	1,17	1,01	2,44
M61/3-552a	400	F	50	43,39	2,86	1,09	0,03	0,00	1,15	4,92	13,19
		F	50	56,18	2,55	0,78	0,02	0,01	1,15	4,28	9,91
		F-1	50	63,13	4,02	0,77	0,01	0,01	1,14	6,63	20,54
		F-1	50	58,75	3,72	1,33	0,04	0,01	1,48	7,33	17,40
		F-2	50	124,46	3,65	4,45	0,04	0,02	1,09	11,62	57,47
		F-2	50	77,38	2,43	2,72	0,01	0,02	1,04	4,72	17,92
M61/3-552b	360	F	50	67,37	2,71	2,06	0,15	0,02	1,31	5,82	73,43
		F	50	140,33	3,58	2,95	0,12	0,01	1,55	5,78	44,36
		F-1	50	132,15	4,96	2,22	0,33	0,05	1,48	11,38	45,66
		F-1	50	73,66	3,03	0,77	0,10	0,01	1,21	3,56	19,34
		F-2	50	101,40	1,63	1,40	0,06	0,02	1,30	4,82	26,91

F= final chamber, F-1=second youngest chamber, F-2=third youngest chamber

Appendix 3.9. Trace element distribution of *G. inflata*. Mg/Ca, Al/Ca, Mn/Ca, Sr/Ca and Zn/Ca are given in mmol/mol. Ba/Ca and B/Ca in $\mu\text{mol/mol}$ and U/Ca in nmol/mol.

	Test size [μm]	Laser		B/Ca	Mg/Ca	Al/Ca	Mn/Ca	Zn/Ca	Sr/Ca	Ba/Ca	U/Ca
		Chamber	diameter [μm]								
M61/3-552	> 400	F	50	76,41	0,87	0,00	0,00	0,00	0,00	1,30	105,69
		F	50	80,41	1,17	0,01	0,00	0,00	0,00	1,43	128,78
		F-1	50	69,45	0,61	0,04	0,00	0,01	0,00	1,35	20,96
		F-1	50	70,99	0,53	0,06	0,00	0,00	0,00	1,34	19,79
		F-2	50	83,86	0,55	0,04	0,00	0,00	0,00	1,34	16,95
		F-2	50	56,45	0,63	0,21	0,00	0,00	0,00	1,21	28,54
M61/3-552	> 400	F	50	74,27	1,65	0,00	0,00	0,00	0,00	1,32	3,29
		F	50	76,54	2,02	0,02	0,00	0,00	0,00	1,38	6,42
		F-1	50	67,81	1,37	0,03	0,00	0,00	0,00	1,24	4,73
		F-1	50	60,28	0,85	0,02	0,00	0,00	0,00	1,31	1,37
		F-2	50	43,28	1,30	0,27	0,00	0,01	0,00	1,33	1,44
		F-2	50	57,18	2,00	0,24	0,00	0,01	0,00	1,28	6,07
M61/3-552	> 400	F	50	77,68	0,84	0,02	0,00	0,00	0,00	1,41	1,54
		F	50	82,94	1,05	0,01	0,00	0,00	0,00	1,41	2,31
		F-1	50	64,04	0,78	0,19	0,00	0,01	0,00	1,21	1,90
		F-1	50	68,07	0,61	0,03	0,00	0,03	0,00	1,24	1,31
		F-2	50	72,46	0,53	0,08	0,00	0,01	0,00	1,27	1,14
		F-2	50	68,36	0,90	0,08	0,00	0,01	0,00	1,29	1,75
M61/3-552	> 400	F	50	87,12	3,91	0,85	0,00	0,01	0,03	1,93	4,85
		F	50	94,11	4,93	3,01	0,00	0,01	0,01	1,72	6,52
		F-1	50	152,40	4,39	10,43	0,00	0,03	0,01	1,35	16,26
		F-1	50	139,92	4,00	7,74	0,00	0,03	0,03	1,43	10,54
		F-2	50	109,92	3,42	1,58	0,00	0,04	0,01	1,34	9,51

F= final chamber, F-1=second youngest chamber, F-2=third youngest chamber

Appendix 4

Plates

Plate 1

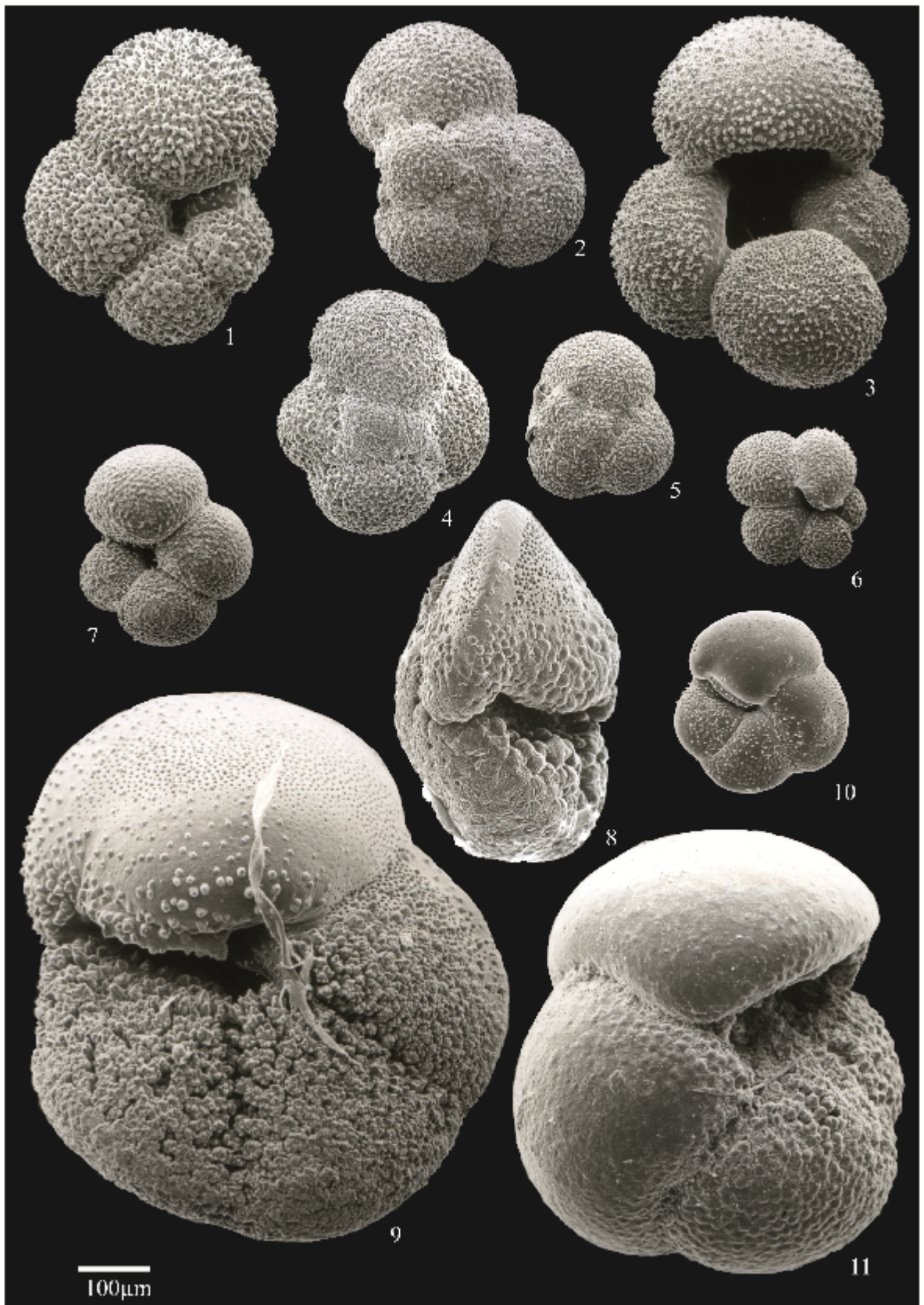

Some species of planktonic foraminifera from the Porcupine Seabight

Fig. 1: *Globigerinella siphonifera*, TF 6, 400-500µm

Fig. 2: *Globigerina bulloides*, core top, 150-250µm

Fig. 3: *Globigerina bulloides*, TF 13, >500µm

Fig. 4: *Globigerinita glutinata*, core top, 250-315µm

Fig. 5: *Globigerinita glutinata*, core top, 150-250µm

Fig. 6: *Turborotalita quinqueloba*, TF 10, 150-250µm

Fig. 7: *Neogloboquadrina incompta*, TF 12, 250-315µm

Fig. 8: *Globorotalia hirsuta*, TF 5, >500µm

Fig. 9: *Globorotalia hirsuta*, TF 6, >500µm

Fig. 10: *Globorotalia scitula*, TF 5, 150-250µm

Fig. 11: *Globorotalia inflata*, core top, >500µm

Plate 2

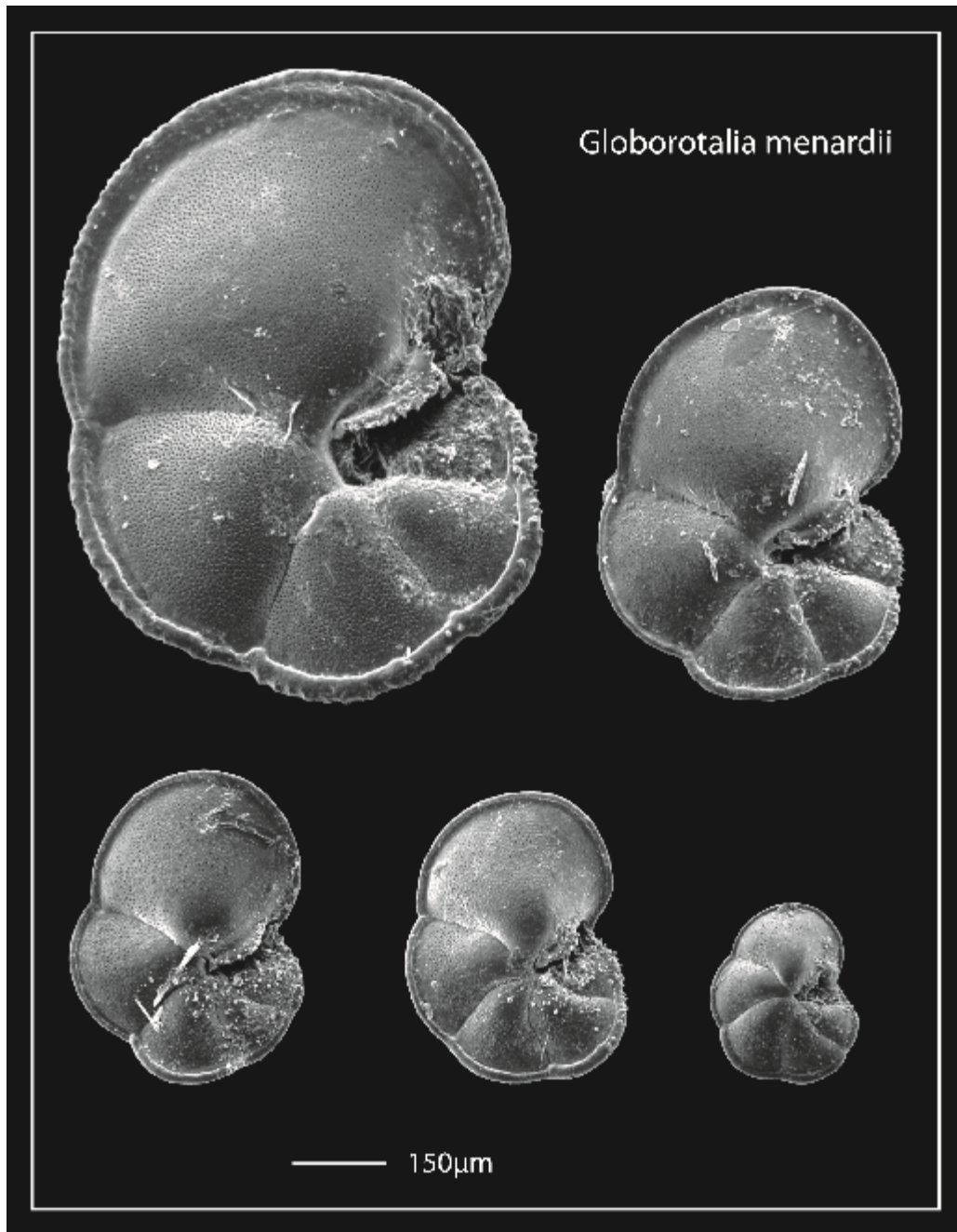

Globorotalia menardii: Cape Verde plankton tows

Plate 3

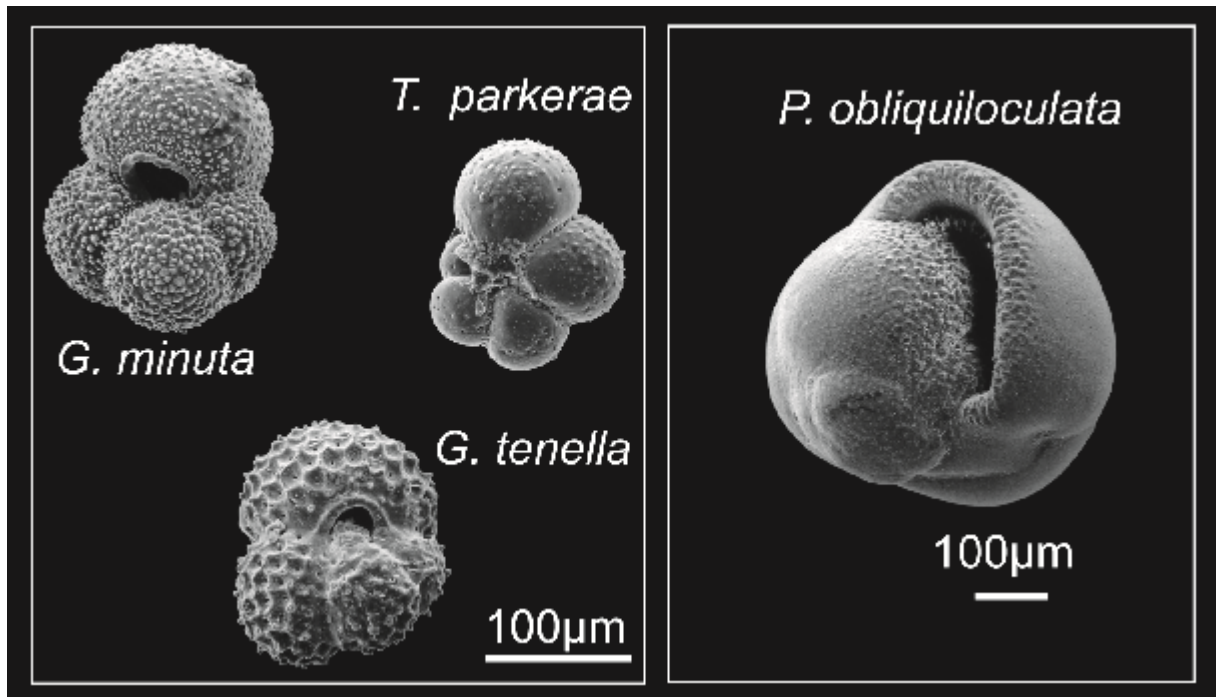

Several species from the tropical Atlantic Ocean

Globigerinita minuta: Central Atlantic plankton tow TP 1

Tenuitella parkerae: Central Atlantic plankton tow TP 1

Globoturborotalita tenella: Cape Verde plankton tow CV 3

Pulleniatina obliquiloculata: TP 3000

Plate 4

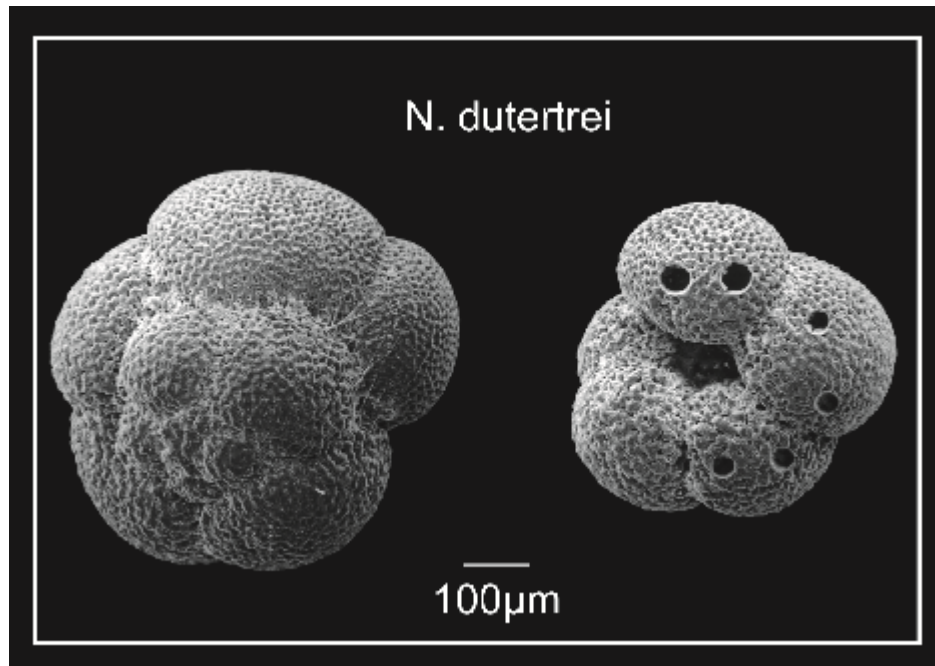

Neogloboquadrina dutertrei: TP 3000 – the specimen on the right shows holes from laserablation

Plate 5

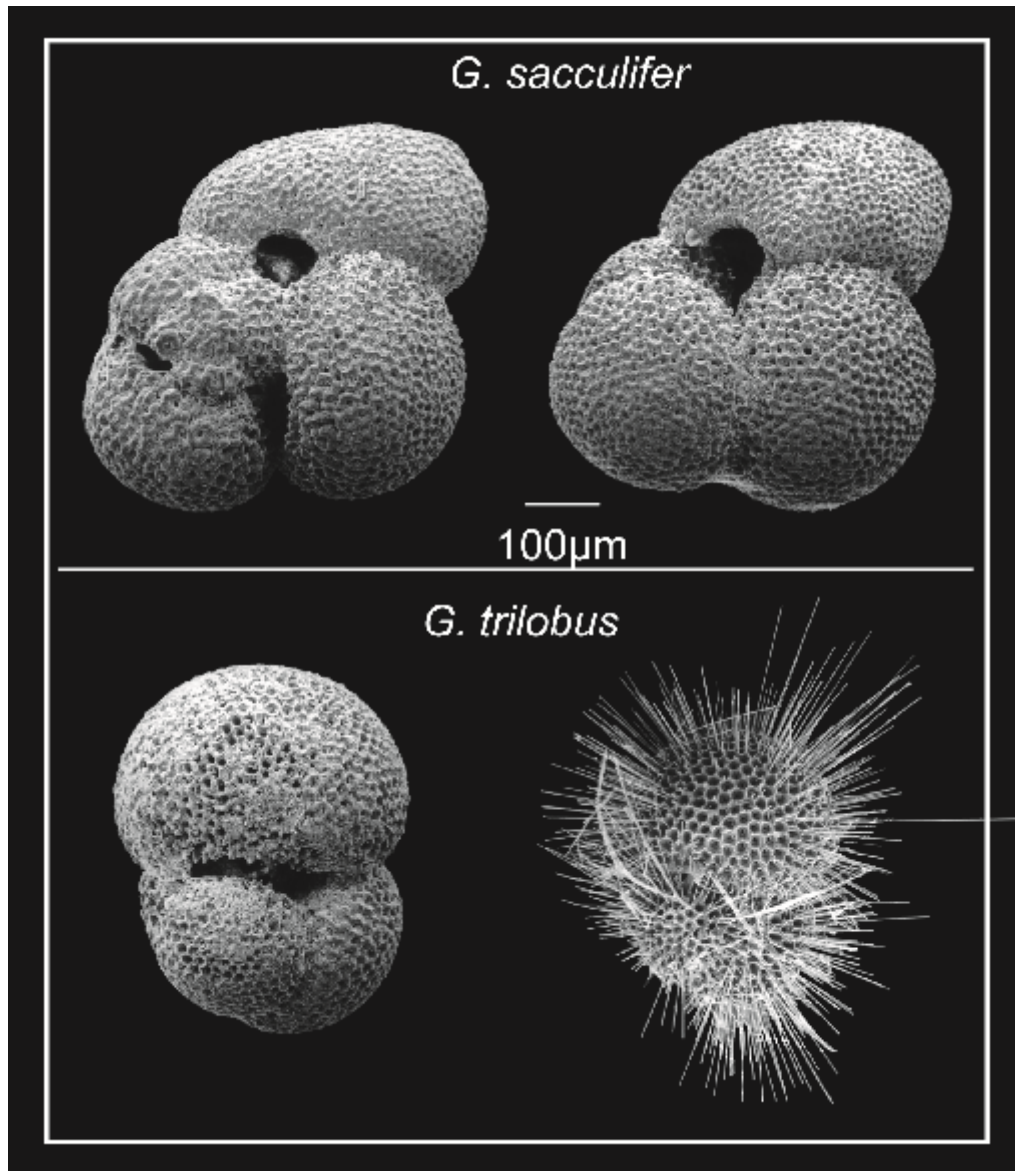

Globigerinoides sacculifer (left + right): TP3000

Globigerinoides trilobus (left): TP3000

Globigerinoides trilobus (right): Cape Verde plankton plankton tow CV 7

Plate 6

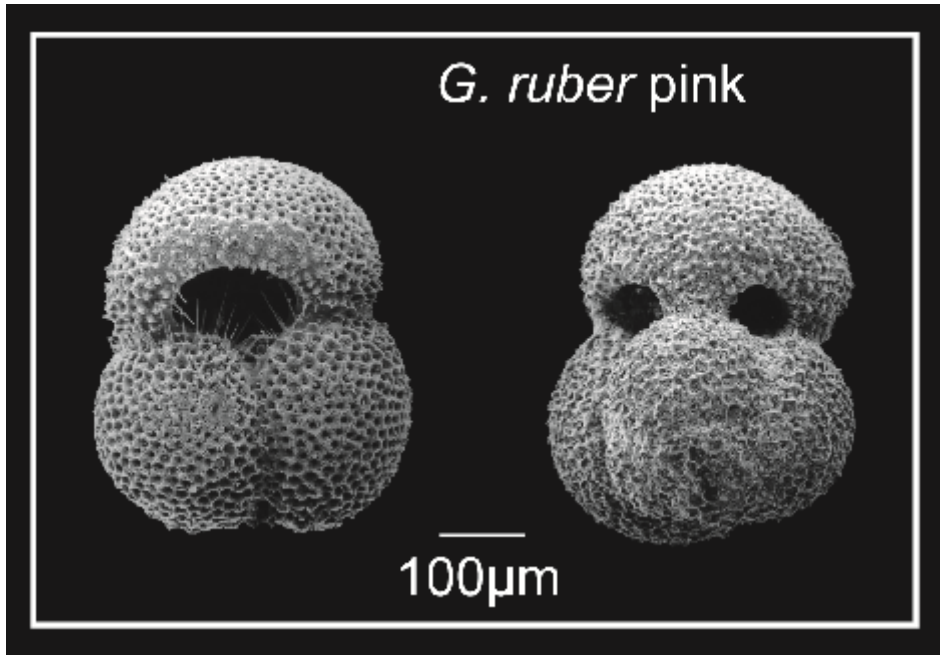

Globigerinoides ruber pink: TP3000

Erklärung gem. § 10 Absatz 2 der PO der Mathematisch-Naturwissenschaftlichen Fakultät

Ich versichere hiermit, daß ich erstmalig an einem Promotionsverfahren teilnehme. Der Inhalt und die Form der hier vorliegenden Dissertation wurde, außer den von mir angegebenen Quellen und Hilfsmitteln und der Beratung durch meine akademischen Berater von mir geschrieben.

Weiterhin erkläre ich, daß ein Teil meiner Dissertation veröffentlicht wurde.

Ich erkläre außerdem, daß diese Dissertation unter Einhaltung der Regeln guter wissenschaftlicher Praxis entstanden ist.