

Aus dem Forschungszentrum Borstel
Leibniz-Zentrum für Medizin und Biowissenschaften
Abteilung Immunologie und Zellbiologie
Laborgruppe Immunbiologie
Laborgruppenleiterin: Prof. Silvia Bulfone-Paus

Regulation of Fc epsilon receptor I-mediated mast cell degranulation

Dissertation

zur Erlangung des Doktorgrades
der Mathematisch-Naturwissenschaftlichen Fakultät
der Christian-Albrechts-Universität
zu Kiel

vorgelegt von

Katharina Biethahn

Kiel, Juli 2011

Referent/in: Prof. Dr. Dr. Silvia Bulfone-Paus

Korreferent/in: Prof. Dr. Thomas Röder

Tag der mündlichen Prüfung: 16.09.2011

Zum Druck genehmigt: 16.09.2011

Table of contents	page
List of figures	V
List of tables	VII
Abbreviations	VIII
1 Introduction	1
1.1 Mast cells	1
1.1.1 Differentiation and distribution of mast cells	1
1.1.2 Mast cell functions	3
1.1.3 Activation of mast cells	4
1.1.4 Regulation of mast cell activation	7
1.2 Adaptor proteins	8
1.2.1 Adaptor protein SAMSN1	9
1.3 MicroRNAs	9
1.3.1 Biogenesis and operating principle of miRNAs	10
1.3.2 MicroRNA function in mast cells	12
1.3.3 MicroRNA miR-155	12
1.4 Aim of the study	13
2 Material	16
2.1 Organisms	16
2.2 Chemicals	16
2.3 Reagents	17
2.4 Buffers and solutions	18
2.5 Media	18
2.6 Primers	19
2.7 Antibodies	20
2.7.1 Antibodies for flow cytometry	20
2.7.2 Antibodies for Western blot	21
2.8 Vectors	21
2.9 Kits	21
2.10 Laboratory supplies	21
2.11 Laboratory equipment	22
2.12 Analyzing software	23

3	Methods	24
3.1	Cell culture.....	24
3.1.1	Generation and cultivation of BMMCs.....	24
3.1.2	Cell counting.....	24
3.2	Giemsa staining of mast cells.....	25
3.3	RNA isolation.....	25
3.3.1	Total RNA isolation.....	25
3.3.2	miRNA isolation.....	25
3.4	cDNA synthesis.....	25
3.4.1	cDNA from total RNA.....	25
3.4.2	cDNA from microRNAs.....	26
3.5	Polymerase chain reaction (PCR).....	26
3.6	Real-time PCR.....	27
3.6.1	Conventional real-time PCR.....	27
3.6.2	miRNA-specific real-time PCR.....	28
3.7	Microarray.....	28
3.8	Agarose gel electrophoresis.....	29
3.9	Extraction of DNA from agarose gels.....	29
3.10	DNA digestion.....	29
3.11	Ligation.....	29
3.12	Transformation.....	29
3.13	Colony PCR screen.....	30
3.14	Purification of nucleic acids.....	30
3.15	Quantification of nucleic acids.....	30
3.16	Sequencing.....	30
3.17	Transfection.....	30
3.18	Flow cytometry.....	31
3.19	Mast cell stimulation.....	31
3.20	Cytokine measurement.....	31
3.21	Degranulation assays.....	32
3.21.1	β -Hexosaminidase measurement.....	32
3.21.2	LAMP1 staining.....	32
3.22	Migration assay.....	33
3.23	Protease measurement.....	33
3.24	Signaling assay.....	34

3.25	SDS Polyacrylamide Gel Electrophoresis (PAGE).....	34
3.26	Western blot	35
3.27	Statistical analysis	35
4	Results	36
4.1	Adaptor protein SAMSN1	36
4.1.1	Analysis of <i>Samsn1</i> mRNA expression in BMMCs	36
4.1.2	SAMSN1 overexpression in BMMCs does not affect mast cell degranulation ..	38
4.1.3	<i>Samsn1</i> ^{-/-} BMMCs proliferate and differentiate normally <i>in vitro</i>	40
4.1.4	<i>Samsn1</i> ^{-/-} BMMCs show normal degranulation	42
4.1.5	<i>Samsn1</i> ^{-/-} and WT BMMCs do not differ in cytokine release	44
4.1.6	<i>Samsn1</i> ^{-/-} BMMCs display normal FcεRI-mediated signaling.....	44
4.1.7	Migration of <i>Samsn1</i> ^{-/-} BMMCs towards SCF is unaffected	46
4.2	MicroRNA miR-155	47
4.2.1	<i>miR-155</i> expression in mast cells	48
4.2.2	<i>miR-155</i> ^{-/-} BMMCs show normal development	49
4.2.3	<i>miR-155</i> ^{-/-} mast cells show enhanced FcεRI-mediated degranulation.....	54
4.2.4	Increased cytokine release by <i>miR-155</i> ^{-/-} BMMCs upon FcεRI-stimulation	57
4.2.5	Expression of potential miR-155 targets in BMMCs.....	59
4.2.6	Increased AKT phosphorylation in FcεRI-stimulated <i>miR-155</i> ^{-/-} BMMCs	65
5	Discussion.....	69
5.1	Role of adaptor protein SAMSN1.....	69
5.2	Role of microRNA miR-155	71
5.3	Conclusion and perspective.....	77
6	References	80
7	Abstract.....	89
8	Zusammenfassung.....	90
9	Appendix	91
9.1	Vector map	91
9.2	Sequence of <i>Samsn1</i> -Flag-pIRES2-EGFP construct	91
	Acknowledgements.....	93
	Eidesstattliche Erklärung.....	94

List of figures

Figure 1-1 Simplified model of FcεRI-mediated signaling events.	6
Figure 1-2 miRNA biogenesis and RNA interference.	11
Figure 1-3 Scheme of control mechanisms in FcεRI-mediated mast cell degranulation.	14
Figure 4-1 Expression of <i>Samsn1</i> in different murine cells and tissues.....	37
Figure 4-2 Expression of <i>Samsn1</i> and <i>Sly1</i> mRNA in WT BMMCs.....	38
Figure 4-3 Comparable LAMP1 expression in BMMCs overexpressing SAMS1.	39
Figure 4-4 <i>Samsn1</i> ^{-/-} BMMCs grow at a comparable rate to WT BMMCs.	41
Figure 4-5 <i>Samsn1</i> ^{-/-} BMMCs show typical mast cell marker expression.	42
Figure 4-6 Normal BMMC degranulation in <i>Samsn1</i> ^{-/-} BMMCs.	43
Figure 4-7 Cytokine release in <i>Samsn1</i> ^{-/-} BMMCs is not defective.....	44
Figure 4-8 Normal ERK MAPK signaling in <i>Samsn1</i> ^{-/-} mast cells.....	45
Figure 4-9 Comparable migration towards SCF between WT and <i>Samsn1</i> ^{-/-} BMMCs.....	47
Figure 4-10 <i>miR-155</i> is expressed in BMMCs.....	49
Figure 4-11 Fold proliferation of mast cells during 1 week of cultivation.	50
Figure 4-12 WT and <i>miR-155</i> ^{-/-} BMMCs show comparable morphology.	51
Figure 4-13 <i>miR-155</i> ^{-/-} BMMCs show normal mast cell marker expression.	52
Figure 4-14 Comparable mast cell protease content in WT and <i>miR-155</i> ^{-/-} BMMCs.....	53
Figure 4-15 Comparable protease activity in WT and <i>miR-155</i> ^{-/-} mast cells.	53
Figure 4-16 Increased β-hexosaminidase release in <i>miR-155</i> ^{-/-} compared to WT BMMCs. ...	55
Figure 4-17 Increased LAMP1 expression in <i>miR-155</i> ^{-/-} compared to WT BMMCs.....	56
Figure 4-18 Increased cytokine release in <i>miR-155</i> ^{-/-} BMMCs.....	58
Figure 4-19 mRNA expression of potential miR-155 targets.	62
Figure 4-20 <i>Ship1</i> and <i>Socs1</i> mRNA expression is unaffected in <i>miR-155</i> ^{-/-} BMMCs.	63

Figure 4-21 No difference in SHIP1 protein levels were detected in <i>miR-155</i> ^{-/-} compared to WT BMMCs.....	64
Figure 4-22 Increased protein expression of PIK3R5 in <i>miR-155</i> ^{-/-} BMMCs.....	65
Figure 4-23 Increase in AKT, but not in ERK phosphorylation in <i>miR-155</i> ^{-/-} BMMCs.....	67
Figure 4-24 Increased AKT phosphorylation in <i>miR-155</i> ^{-/-} compared to WT BMMCs.	68
Figure 5-1 Proposed role of miR-155 in FcεRI-mediated mast cell degranulation.	77
Figure 9-1 Vector map of pIRES2-EGFP vector and Samsn1-Flag insert.	91

List of tables

Table 1-1 Mediators synthesized by mast cells.....	3
Table 2-1 Primer sequences for reverse transcriptase PCR	19
Table 2-2 Primer sequences for real-time PCR.....	20
Table 3-1 Mastermix for cDNA synthesis	26
Table 3-2 PCR reaction mix.....	27
Table 3-3 Components of gels for SDS-PAGE.....	35
Table 4-1 Differential gene expression in BMMCs after stimulation with IgE and antigen. ...	59

Abbreviations

Ag	DNP-HSA antigen
BMMC	bone marrow-derived mast cell
BSA	bovine serum albumin
bp	base pairs
cDNA	complementary deoxyribonucleic acid
ctrl	control
DC	dendritic cell
DNA	deoxyribonucleic acid
dNTP	deoxynucleotide triphosphate
DTT	dithiothreitol
EDTA	ethylenediaminetetraacetic acid
ELISA	enzyme-linked immunosorbent assay
FACS	fluorescence-activated cell sorting
FCS	fetal calf serum
FITC	fluorescein isothiocyanate
FSC	forward scatter
g	gram or gravity
GFP	green fluorescent protein
h	hour
hprt	hypoxanthine phosphoribosyltransferase
HRP	horse radish peroxidase
HRP	horse radish peroxidase
HSA	human serum albumin
Ig	immunoglobulin
IL	interleukin
IMDM	Iscove's modified Dulbecco's medium
Iono	ionomycin
kb	kilobases
kDa	kilodalton

LB	lysogeny broth
MC	mast cell
min	minute
ND	not detectable
neg	negative
NS	not significant
PAGE	polyacrylamide gel electrophoresis
PBS	phosphate buffered saline
PCR	polymerase chain reaction
PE	phycoerythrin
PMA	phorbol 12-myristate 13-acetate
pos	positive
RNA	ribonucleic acid
RT	room temperature
SCF	stem cell factor
SDS	sodium dodecylsulfate
sec	seconds
SSC	sideward scatter
TBE	Tris/Borate/EDTA
Tris	Tris(hydroxymethyl)aminomethane
U	Units
v/v	volume per volume
w/v	weight per volume

1 Introduction

1.1 Mast cells

Mast cells have been first described by Paul Ehrlich in 1878 as large, granular cells of the connective tissue, whose granular content displays a high reactivity to aniline dyes. He termed the cells mast cells because of their appearance of being “well fed” cells due to numerous granula and their localization in tissues which needed enhanced nutrition (Riley, 1954).

Today we know that mast cells do not internalize extracellular components or other cells, but contain granules with different prestored mediators that are released upon activation of the cell. Mast cells can be found in epithelia, vascularized tissue, close to blood vessels, nerves and smooth muscle cells. They are especially present in the skin, airways and gastrointestinal tract, all of which are frequently exposed to the environment and pathogens, where mast cells, together with dendritic cells, serve as a first line of defense against pathogens, allergens and other antigens (Galli et al., 2005).

1.1.1 Differentiation and distribution of mast cells

Mast cells derive from hematopoietic stem cells in the bone marrow. These mast cell precursors circulate in the blood and only differentiate into mature, long-lived cells after homing to specific tissues (Kalesnikoff and Galli, 2008). The process of homing and maturation of the mast cell precursors depends strongly on the micro-environment that the cells are exposed to at the site of their homing.

The homing process is mainly dependent on stem cell factor (SCF), which is produced by fibroblasts, stromal and endothelial cells and binds specifically to the receptor tyrosine kinase c-kit on the mast cell membrane (Stone et al., 2009). Binding of SCF also regulates processes like survival of mast cell precursors, mast cell adherence and proliferation (Galli et al., 1994). Other important factors that regulate mast cell numbers and phenotype are interleukin (IL)-3, IL-4, IL-9 (Galli et al., 2005), IL-2, IL-18, monocyte chemoattractant protein 1, RANTES as well as nerve growth factor (NGF) (Metz and Maurer, 2007).

Depending on their location and mast cell protease expression pattern, mast cells can be categorized into different subtypes: mucosal and connective tissue mast cells. Mucosal mast

cells are characterized by the presence of tryptase (MC_T cells) and are localized mainly in the mucosa of the gastrointestinal and respiratory tracts. Connective tissue mast cells are present mostly in the dermis, submucosa of the gastrointestinal tract, heart, conjunctivae and perivascular tissues and are characterized by the presence of tryptase as well as mast cell-specific chymase (MC_{TC} cells) (Bienenstock et al., 1982; Metcalfe, 2008).

A unique characteristic of mast cells are their intracellular granules. Each mast cell contains large numbers of these granules, which consist next to tryptases and chymases of preformed mediators like histamine, heparin and proteases (Galli et al., 2005; Schwartz and Austen, 1980). Upon stimulation, mast cells release these mediators to the extracellular space by fusion of the granula membrane with the plasma membrane.

In addition to the release of prestored mediators, mast cells also synthesize and release numerous cytokines, chemokines, growth factors and lipid mediators upon activation, as shown in Table 1-1 (Galli et al., 2005).

Table 1-1 Mediators synthesized by mast cells.

CCL, CC-chemokine ligand; CXCL, CXC-chemokine ligand; FGF2, fibroblast growth factor 2; GM-CSF, granulocyte/macrophage colony-stimulating factor; IFN, interferon; IL, interleukin; LIF, leukaemia inhibitory factor; LTB₄, leukotriene B₄; LTC₄, leukotriene C₄; PGD₂, prostaglandin D₂; PGE₂, prostaglandin E₂; TGF- β , transforming growth factor- β ; TNF, tumour-necrosis factor; VEGF, vascular endothelial growth factor (Marshall, 2004).

Mediators	Example of function
Granule-associated	
Histamine and serotonin	Alter vascular permeability
Heparin and/or chondroitin sulphate peptidoglycans	Enhance chemokine and/or cytokine function and angiogenesis
Tryptase, chymase, carboxypeptidase and other proteases	Remodel tissue and recruit effector cells
TNF, VEGF and FGF2	Recruit effector cells and enhance angiogenesis
Lipid-derived	
LTC ₄ , LTB ₄ , PGD ₂ and PGE ₂	Recruit effector cells, regulate immune responses, and promote angiogenesis, oedema and bronchoconstriction
Platelet-activating factor	Activates effector cells, enhances angiogenesis and induces physiological inflammation
Cytokine	
TNF, IL-1 α , IL-1 β , IL-6, IL-18, GM-CSF, LIF, IFN- α and IFN- β	Induce inflammation
IL-3, IL-4, IL-5, IL-9, IL-13, IL-15 and IL-16	Functions of T helper 2-type cytokines
IL-12 and IFN- γ	Functions of T helper 1-type cytokines
IL-10, TGF- β and VEGF	Regulate inflammation and angiogenesis
Chemokine	
CCL2, CCL3, CCL4, CCL5, CCL11 and CCL20	Recruit effector cells, including dendritic cells, and regulate immune responses
CXCL1, CXCL2, CXCL8, CXCL9, CXCL10 and CXCL11	Recruit effector cells and regulate immune responses
Other	
Nitric oxide and superoxide radicals	Bactericidal
Antimicrobial peptides	Bactericidal

1.1.2 Mast cell functions

The functions of mast cells are very diverse and yet not well defined. Depending on the situation mast cells encounter, they have been implicated in the regulation of blood vessel formation, tissue repair and fibrosis, maintenance of tissue growth, differentiation, survival and wound healing (Maurer et al., 2003).

The pathological role of mast cells is mostly focused on innate immune responses triggering mainly IgE-mediated hypersensitivity reactions. This is caused by degranulation of mast cells upon activation of the Fc epsilon receptor I (FcεRI), followed by the release and *de novo* synthesis of mediators that lead to symptoms of allergic diseases and asthma like bronchoconstriction, vasodilation, tissue edema, recruitment of leukocytes and other inflammatory reactions in the mucosa (Roth et al., 2008).

Type I hypersensitivity reactions are inappropriate reactions towards a harmless antigen, also called allergen. The acute allergic reaction occurs within minutes of encountering the allergen and can also turn into a late phase reaction even after the acute phase symptoms have subsided. Furthermore, the allergic reaction can extend to a chronic phase that may last for years (Williams and Galli, 2000).

Other functions of mast cells in limiting pathology include the control of bacterial (Di Nardo et al., 2003; Xu et al., 2006) and viral (Orinska et al., 2005) infections as well as the clearance of parasites (Furuta et al., 2006; McDermott et al., 2003). In addition, mast cells have been shown to act as regulators of autoimmune diseases like experimental autoimmune encephalomyelitis (Gregory et al., 2006; Sayed et al., 2011) and autoimmune inflammatory arthritis (Nigrovic et al., 2007).

During the last two decades mast cells have also been implicated in the regulation of adaptive immune responses. They were described to act as antigen-presenting cells (Banovac et al., 1989; Fox et al., 1994; Frandji et al., 1993) and modulate B cell (Gauchat et al., 1993; Tkaczyk et al., 1996), dendritic cell (DC) (Caron et al., 2001; Skokos et al., 2003) as well as T cell responses (Stelekati et al., 2007).

1.1.3 Activation of mast cells

Due to their diversity in phenotype, location and function, mast cells display diverse activation mechanisms. As already mentioned, mast cells can be activated by cross-linking the tetrameric IgE-receptor FcεRI on the surface of mast cells via IgE and specific antigen (Turner and Kinet, 1999). FcεRI is composed of an α-, a β- and a homodimeric γ-chain, the two latter of which are phosphorylated at their immunoreceptor tyrosine-based activation motifs (ITAMs) by LYN kinase. This leads to the recruitment of other kinases like FYN and SYK and to the phosphorylation of adaptor proteins like GAB2 and GRB2. GAB2 activation

is necessary for the initiation of the phosphoinositide 3-kinase (PI3K) pathway. During this process, phosphatidylinositol 4,5-bisphosphate (PIP₂) is phosphorylated to phosphatidylinositol 3,4,5-triphosphate (PIP₃). PIP₃ mediates the recruitment of AKT (also known as PKB) to the plasma membrane and its phosphorylation. The direct downstream targets of AKT in mast cells are relatively unknown, but activation of AKT leads to the activation of transcription factors NF- κ B, NFAT and AP-1, resulting in increased cytokine production. Also, AKT activation in the PI3K pathway is likely to result in the regulation of growth and homeostasis (Kim et al., 2008). Other adaptor proteins like LAT1 are responsible for the activation of phospholipase C gamma (PLCgamma), which hydrolyzes PIP₂ into diacylglycerol (DAG) and inositol 1,4,5-trisphosphate (IP₃). Both of these processes terminate in an increase of intracellular calcium levels. The activation of adaptor proteins like LAT1 and LAT2 also leads to the recruitment of guanine nucleotide exchange factors like SOS, which in turn activate mitogen-activated protein kinases (MAPK) like extracellular signal-regulated kinase (ERK) or p38. These signaling events direct mast cell degranulation, cytokine production and activation of transcription factors which control gene expression (Alvarez-Errico et al., 2009; Gilfillan and Tkaczyk, 2006; Roth et al., 2008). The described signaling events are depicted in Figure 1-1.

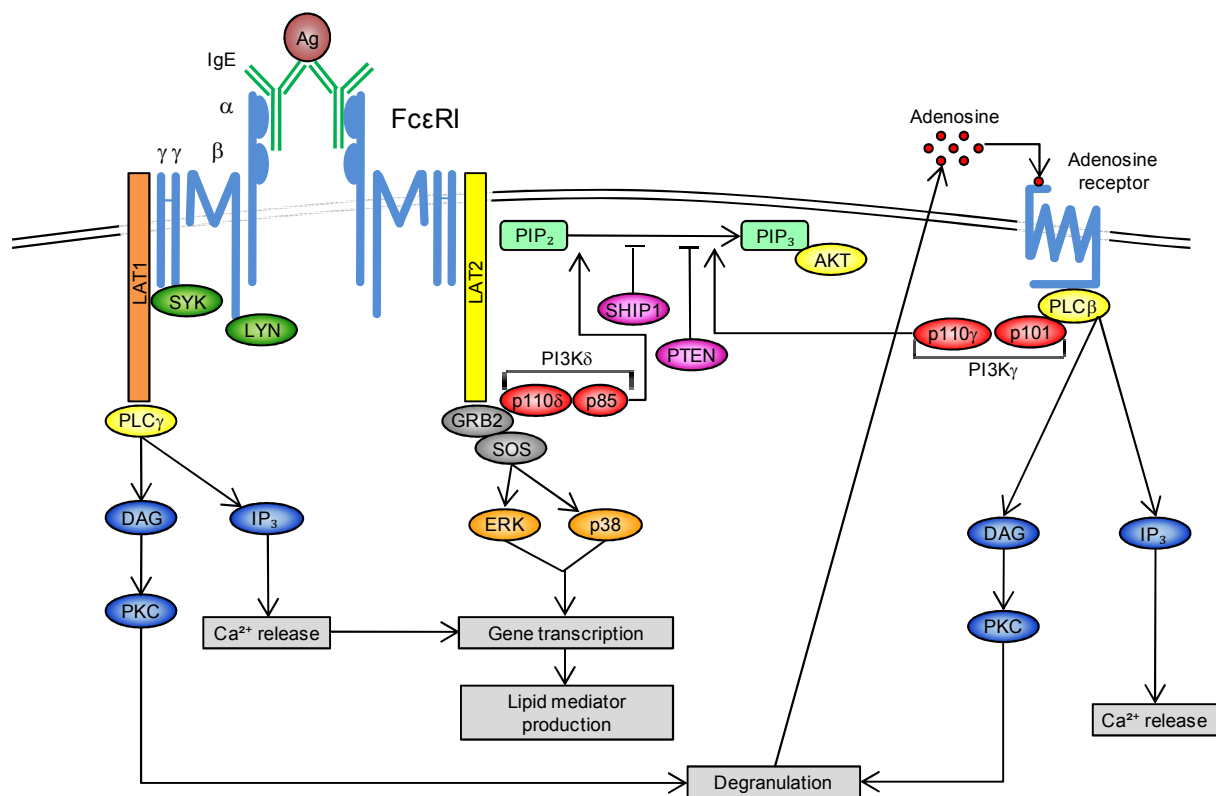

Figure 1-1 Simplified model of FcεRI-mediated signaling events.
(adapted from Rommel et al., 2007)

In addition to the classical mast cell activation via IgE and antigen, other receptors expressed by mast cells can lead to their activation. One of those is FcγRIII, a multichain receptor that initiates the release of inflammatory mediators like serotonin and cytokines like TNF- α when aggregated with multivalent IgG (Daeron et al., 1992; Latour et al., 1992). Many of the mast cell surface receptors belong to the family of pattern recognition receptors (PRRs) that can bind directly to pathogen-associated molecular patterns (PAMPs), which are shared by groups of pathogens. Toll-like receptors (TLRs) belong to the family of PRRs and various TLRs are expressed on mast cells (Stelekati et al., 2007). For example, TLR-2 and -4 engagement with peptidoglycan and LPS, respectively, activates mast cells and leads to degranulation and cytokine production (Masuda et al., 2002; Supajatura et al., 2002). Also other cell surface receptors like cytokine receptors or G-protein coupled receptors (GPCRs) are able to activate mast cells. GPCRs bind adenosine, chemokines or components of the complement system like C3a, which results in the potentiation of mast cell activation and mediator release (Gilfillan and Tkaczyk, 2006). This is also true for NGF, which is released by T helper type 2 cells,

eosinophils as well as mast cells and which binds to its receptor on the mast cell surface and exerts a priming effect on FcεRI-mediated degranulation (Bonini et al., 2002).

Furthermore, mast cells can be activated via binding of SCF to the c-kit receptor. This binding leads to an increased release of mediators from the mast cell and amplifies the FcεRI-mediated release of granule content (Coleman et al., 1993; Columbo et al., 1992).

1.1.4 Regulation of mast cell activation

The activation of mast cells leads to the release and production of highly potent mediators which can direct a number of potentially harmful reactions. Therefore this process has to be tightly regulated at several levels of the activation process. This regulation can take place at the receptor level by the engagement of negative signaling receptors on the mast cell surface. An example of a negative signaling receptor is the single chain receptor FcγRII, which inhibits the FcεRI-mediated degranulation when cross-linked with IgG (Daeron et al., 1995). Furthermore, proteases like src homology 2 (SH2)-containing inositol phosphatase 1 (SHIP1), which regulates the FcεRI-inducible levels of PIP₃ through its hydrolyzation, and the phosphatase and tensin homolog (PTEN), which counteracts the PI3K activation by dephosphorylation of PIP₃, play a central role in controlling mast cell activation (Huber et al., 1998; Roth et al., 2008)

Inhibitory adaptor proteins like downstream of tyrosine kinase 1 (DOK1) have also been shown to act as regulators of antigen-mediated mast cell activation by suppression of the ERK pathway (Hiragun et al., 2005) as well as Src-like adaptor protein 1 (SLAP1), which suppresses signaling events by dephosphorylation of SYK, LAT, PLCγ2 and ERK (Hiragun et al., 2006).

A regulation of mast cell activation usually results in the activation or inhibition of transcription factors like NF-κB or NFAT and therefore in a change of gene expression (Hutchinson and McCloskey, 1995; Marquardt and Walker, 2000). Another way to regulate gene expression is via microRNAs (miRNAs), which inhibit the translation of mRNA to a functional protein and therefore limit the targeted gene to express its protein.

Due to the possible regulation of FcεRI-mediated mast cell activation on different levels, the role of the adaptor protein SAMS1 (SAM domain, SH3 domain and nuclear localization signals 1) (see section 1.2.1) as well as the regulation of mast cell activation at the

translational level via microRNAs, especially microRNA-155 (see section 1.3.2) were investigated in this study.

1.2 Adaptor proteins

Complex signaling cascades that consist of various molecules – from receptors on the cell surface down to transcription factors in the nucleus - are necessary for cells to be able to react to specific signals. Important players in these pathways are adaptor proteins. In contrast to kinases and phosphatases, these proteins lack intrinsic enzymatic activities but mediate specific protein-protein interactions and facilitate the formation of larger signaling complexes within cells. Thus they act as a linker between receptor and effector and coordinate the activation of signaling pathways in both the spatial and temporal manner (Flynn, 2001; Pawson, 2007).

Among the best studied protein domains required for signaling are the Src homology 2 (SH2) and Src homology 3 (SH3) domains. They were first described as being important for signal transduction in the Src protein in 1991 (Hidaka et al., 1991). Signaling starts with ligand/receptor binding, whereupon the receptor is clustered and the Src family kinases, which comprise of an SH3, an SH2 and a kinase domain, are able to phosphorylate the immunoreceptor tyrosine-based activation motif (ITAM) on the receptor itself or on adaptor proteins (Underhill and Goodridge, 2007). SH2 domains bind preferentially to phosphotyrosyl residues on activated receptors, whereas SH3 domains bind polyproline motifs on other target proteins. Therefore, a protein which contains an SH2 as well as an SH3 domain can bind to more than one partner, leading to the formation of a signaling complex (Pawson and Scott, 1997).

Other important signaling domains of proteins are the sterile-alpha-motif (SAM) domains. These domains were first described in the fruit fly *Drosophila melanogaster* and the yeast *Saccharomyces cerevesiae* and are named after their profusion in sex determining proteins and high content of α -helices. SAM domains are distributed throughout the whole mammalian genome and mediate protein-protein interactions by the formation of homodimers. Their function, however, has still to be clearly defined (Qiao and Bowie, 2005).

1.2.1 Adaptor protein SAMSN1

SAMSN1, which is also known as HACSN1, NASH1 or SLY2, has been first described in 2001 by two different groups as a signaling or an adaptor protein which contains a nuclear localization signal (NLS), an SH3 and a SAM domain and which might play a role in mast cell signaling in the nucleus (Claudio et al., 2001; Uchida et al., 2001). It belongs to the SLY protein family, which includes two other proteins, namely SLY1 and SASH1/SLY3 (Beer et al., 2001; Zeller et al., 2003). All family members are characterized by the presence of an NLS at the N-terminus of the protein followed by an SH3 and a SAM domain.

SAMSN1 is localized on mouse chromosome 16 and consists of 11 exons which encode a protein of 364 amino acids and 42 kDa. The murine SAMSN1 shows 87% homology to the human protein and has been shown to be expressed in cultured DCs as well as activated B cells. SAMSN1 is described to act in the signaling cascades of B cells responsible for B cell activation and differentiation into plasma cells (Zhu et al., 2004b). In 2010, *Samsn1*-deficient mice were generated. These mice are viable and fertile and displayed normal B and T cell development. Despite that, T cells from *Samsn1*^{-/-} mice showed an enhanced humoral immune response and the activation of B cells led to increased B cell receptor signaling and tyrosine phosphorylation. Therefore, SAMSN1 was proposed to function as an inhibitory adaptor molecule (Wang et al., 2010). A recent publication also describes SAMSN1 as a regulator of the cytoskeleton, mainly involved in the regulation of cell morphology and cell spreading (von Holleben et al., 2011).

Little is known about the physiological function of SAMSN1 in other cells of the immune system and no studies have been performed on the role of this adaptor protein in mast cells. Therefore one part of this work focuses on the expression and function of SAMSN1 in murine mast cells.

1.3 MicroRNAs

MicroRNAs are small, 21-25 bp long, single-stranded and non-protein-coding RNAs, which are processed from mRNA transcripts of genes mainly located within introns and intergenic regions. They regulate the expression of proteins by binding to target mRNAs and thereby inhibit translation. At least 30% of the mammalian genome is predicted to be targeted by miRNAs. Many different microRNAs have been described to play a role in immune cells,

especially in maturation, proliferation, differentiation, activation as well as apoptosis (He and Hannon, 2004; Lewis et al., 2005; O'Connell et al., 2010).

The first miRNA to be described was lin-4 in *Caenorhabditis elegans* in 1993 (Lee et al., 1993; Wightman et al., 1993). The term miRNA itself was first used in 2001 (Lee and Ambros, 2001) and since then extensive studies on different miRNAs in various cells of the immune system have been published. As an example it was shown that miR-9, miR-146a and miR-155 play a role in the innate immune response in myeloid cells and that miR-155 and miR-181a are responsible for the regulation of T cell responses (Tsitsiou and Lindsay, 2009).

1.3.1 Biogenesis and operating principle of miRNAs

miRNA genes can be organized as single unit genes or in a gene cluster. These clustered miRNA genes are expected to be transcribed together and code for miRNAs that target mRNAs of proteins with related functions (Brameier and Wiuf, 2007).

The multistep process which miRNAs use to exert their function is called RNA interference (RNAi). First described by the group of Craig Mello in 1998 in *C. elegans* it is now known to not only function in an *in vitro* setting by insertion of double-stranded RNA but it is also the physiological mode of action of miRNAs (Fire et al., 1998). RNAi and the biogenesis of miRNAs are shown in Figure 1-2.

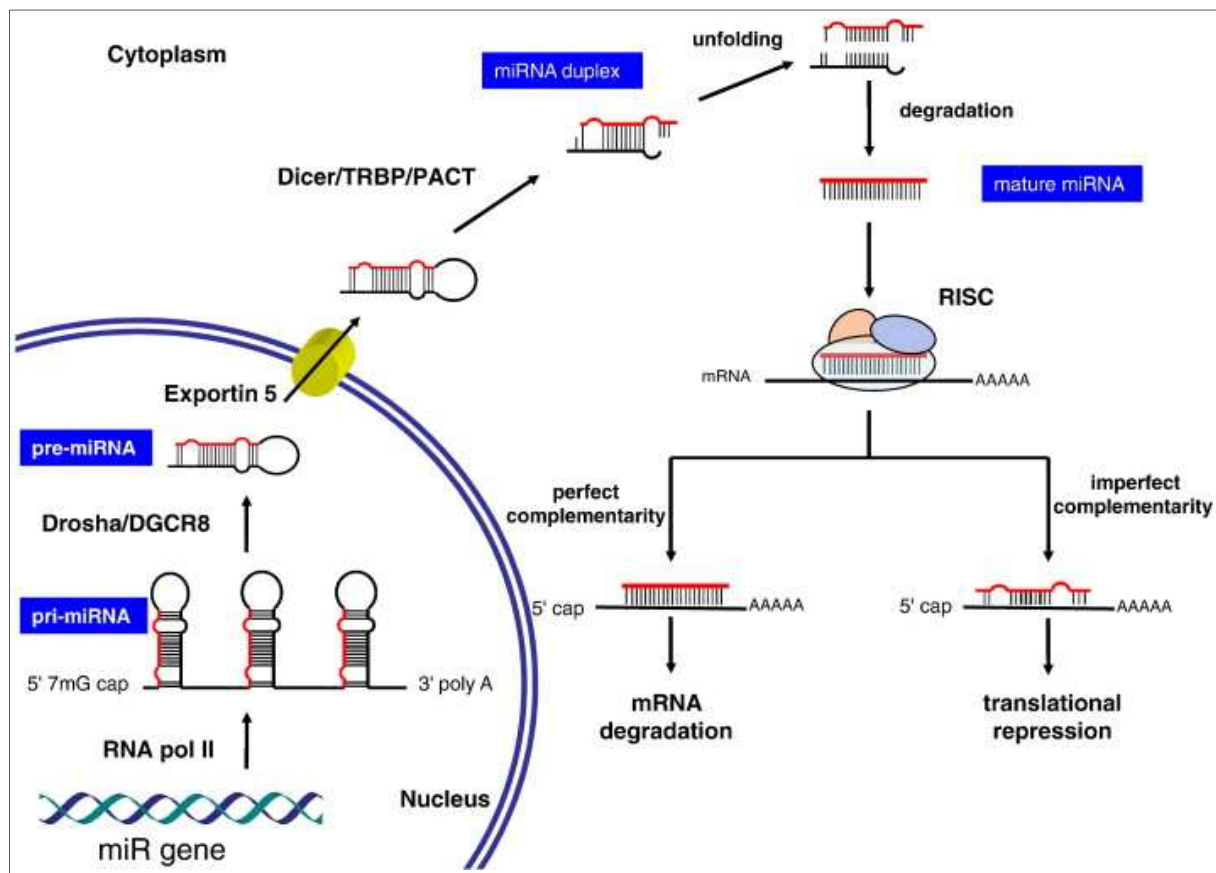

Figure 1-2 miRNA biogenesis and RNA interference.

miRNA is transcribed into primary-miRNA (pri-miRNA) in the nucleus, then processed into precursor-miRNA (pre-miRNA) by Drosha and DGCR8 proteins and exported to the cytoplasm by Exportin 5. There, a miRNA duplex is formed by Dicer, TRBP and PACT proteins, which is then unfolded. The miRNA guide strand is loaded onto the RNA induced silencing complex (RISC) and binds to the complementary mRNA. This leads to mRNA degradation or transcriptional repression (Faraoni et al., 2009).

The biogenesis of miRNAs starts with the transcription of the miRNA gene in the nucleus by RNA polymerase II. This results in a 5'-capped and 3'-polyadenylated RNA transcript, which can contain multiple miRNA transcripts and is called primary miRNA (pri-miRNA). The pri-miRNA is then cleaved by the RNase III Drosha complexed with the RNA-binding protein DGCR8 (DiGeorge syndrome critical region gene 8) into a precursor miRNA (pre-miRNA) of about 70 nucleotides. The pre-miRNA is transported to the cytoplasm by the exportin 5 complex. There the endonuclease Dicer, which forms a complex with TAR RNA-binding protein (TRBP) and PKR-activating protein (PACT), cleaves the pre-miRNA stem-loop and forms a 21-24 bp miRNA duplex. From this duplex, one strand – the so-called guide strand – is selected and loaded onto the RNA induced silencing complex (RISC), whereas the other strand – named passenger strand – is degraded. Mature miRNAs then bind to complementary mRNA molecules. In case of a perfect match between miRNA and mRNA, the mRNA will be

degraded. If miRNA and mRNA are not completely complementary, the translation of mRNA will be repressed (Faraoni et al., 2009).

1.3.2 MicroRNA function in mast cells

Despite a number of studies on miRNA function in immune cells, only few studies have been published on the role of miRNAs in mast cells. MicroRNA profiling by use of miRNA microarrays revealed differences between the expression pattern of miRNAs in hematopoietic and non-hematopoietic cells and similarities in differentiated cells like T cells and mast cells proposing a role of miRNAs in murine mast cell differentiation (Monticelli et al., 2005). But functional characterization of the role of miRNAs in mast cells remains ill-defined and only two publications can be found on this topic. First, it was shown that miR-15b and miR-16-2, which are organized in a cluster on murine chromosome 3, are able to regulate primary murine mast cell's BCL2 expression via STAT5 binding (Cimmino et al., 2005; Li et al., 2010). In addition, studies confirmed that miR-221-222 is able to regulate the cell cycle and to dampen proliferation in activated murine bone marrow-derived mast cells (BMMCs) (Mayoral et al., 2009).

1.3.3 MicroRNA miR-155

One specific miRNA – miR-155 – came into focus because it has been shown to target the inositol phosphatase SHIP1 in macrophages (O'Connell et al., 2009). As described in section 1.1.4, SHIP1 is known to regulate the FcεRI-mediated mast cell degranulation by reducing the intracellular levels of PIP₃. Therefore, a potential connection between miR-155 and mast cells arose.

miR-155 is a typical, multifunctional microRNA with a size of 22 nucleotides, which was first described in 2002. It is processed from an exon of a non-coding RNA transcribed from the B cell integration cluster (BIC) (Lagos-Quintana et al., 2002). It is known to be expressed in various cell types like B cells, T cells, macrophages and dendritic cells and to target mRNAs of genes like *Ship1*, *PU.1*, *AiD*, *Socs1*, and *CEBPB* (O'Connell et al., 2010). miR-155 has also been shown to be upregulated upon stimulation of Toll-like receptors or with pro-inflammatory cytokines (O'Connell et al., 2007; Taganov et al., 2006). The function of miR-155 has been well described to be critical for hematopoiesis as well as B cell maturation (O'Connell et al., 2008; Rodriguez et al., 2007; Thai et al., 2007) and its dysregulation is

associated with different cancer types, cardiovascular disease and viral infection (Eis et al., 2005; Gottwein et al., 2007; Kluiver et al., 2005; Sethupathy et al., 2007; Skalsky et al., 2007).

While the role of miR-155 in B cells and cells of the myeloid origin is well established, only one publication describes the function of another miRNA in mast cells (Mayoral et al., 2009) (see section 1.3.2). As described before, miR-155 is known to target proteins like SHIP1 and SOCS1, which are both expressed in mast cells and have been shown to regulate mast cell activation and in particular FcεRI-mediated mast cell degranulation. Therefore, I investigated the expression and function of miR-155 in murine BMMCs from wild-type and *miR-155*^{-/-} mice.

1.4 Aim of the study

Mast cells are important players in the development and maintenance of IgE-mediated allergic disorders as well as in the regulation of innate and adaptive immune responses. The complex and multidirectional effects these cells exert need to be tightly regulated on several levels in the activation cascade. Therefore, understanding the activation of mast cells and their regulation is an important prerequisite for the development of novel therapeutic applications to treat allergy and asthma.

Promising approaches in therapy have been performed by blocking the FcεRI-mediated mast cell activation with anti-IgE and therefore inhibiting its cross-linking with antigen. Mast cell signaling is also controlled by kinases and adaptor proteins, which act as regulators of mast cell signaling. Apart from the signaling itself, an approach in the regulation of mast cell activation could also be achieved by modulating gene expression as well as the fusion of granules with the mast cell membrane. Another important way to regulate the effects of mast cell degranulation is by blocking the function of histamine using histamine antagonists. These regulatory mechanisms of mast cell activation are pictured in Figure 1-3.

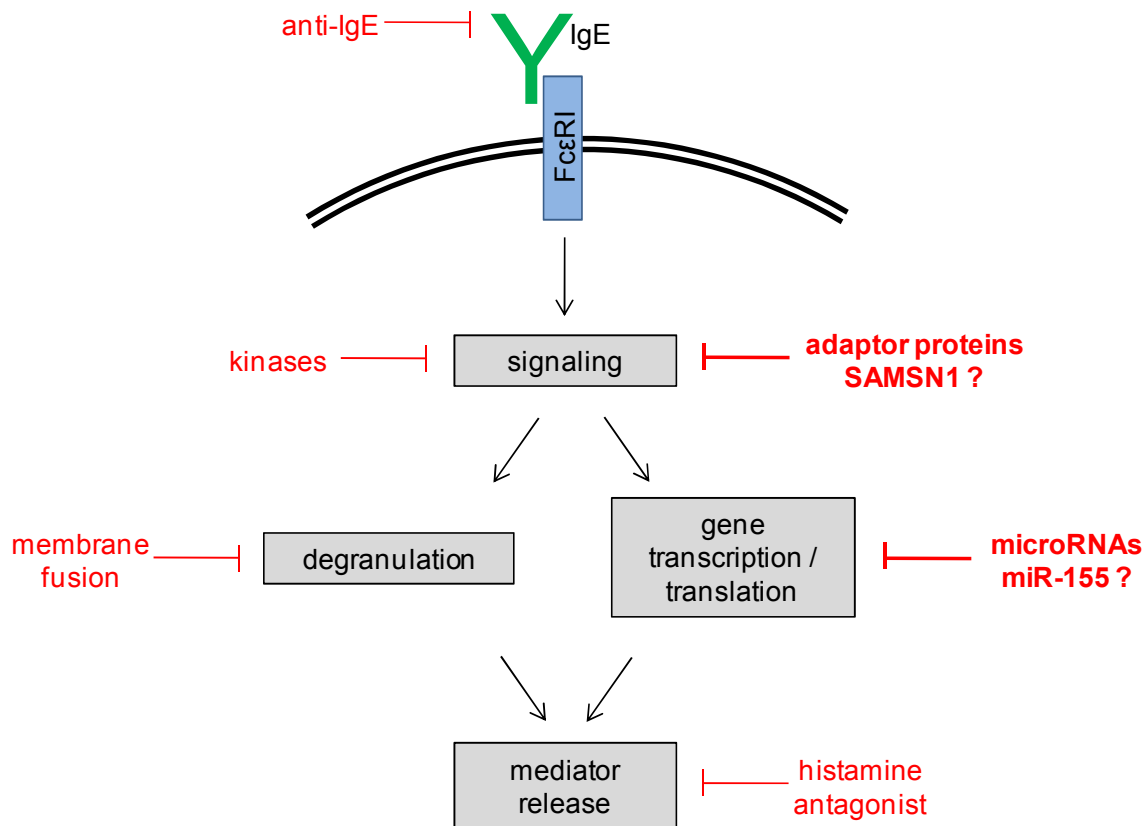

Figure 1-3 Scheme of control mechanisms in FcεRI-mediated mast cell degranulation.

FcεRI-mediated mast cell degranulation can be controlled on several levels including the receptor binding, signaling, degranulation and mediator release. Little is known about the regulation via miRNAs. The goal of the present study is to investigate the role of adaptor protein SAMS1 and that of miR-155 in mast cell degranulation.

To elucidate novel mechanisms by which FcεRI-mediated mast cell activation can be regulated, two possible regulatory mechanisms were analyzed. One part focused on the role of adaptor proteins, which function as switches in mast cell signaling and are critical regulators of mast cell function. The second part concentrated on the function of miRNAs in mast cell activation. Increasing evidence on miRNA function in cells of the hematopoietic lineage suggests a regulatory role of these small RNAs also in mast cells.

Therefore, the goal of this work was to study the expression and function of adaptor protein SAMS1 and microRNA miR-155 in mast cells using BMMCs from wild-type as well as *Sams1*^{-/-} and *miR-155*^{-/-} mice as an experimental model.

In this aspect, BMMCs from *Samsn1*^{-/-} and *miR-155*^{-/-} mice were characterized to verify their normal proliferation, differentiation and phenotype. To determine the role of the adaptor protein SAMSN1 and the microRNA miR-155 in the regulation of mast cell activation, functional analyses of degranulation, cytokine production and signaling were performed to reveal a mechanism by which mast cell activation could be regulated.

2 Material

2.1 Organisms

<i>E.coli</i> XL1 Blue	Stratagene
<i>miR-155</i> ^{-/-} mice (C57BL/6 N Background)	Dr. Elena Vigorito, Babraham Institute, Cambridge, United Kingdom
<i>Samsn1</i> ^{-/-} mice (mixed Background)	Dr. Sandra Beer-Hammer Prof. Dr. Klaus Pfeffer Universitätsklinikum Düsseldorf

2.2 Chemicals

Agarose	Peqlab
Ammonium chloride	Roth
Ampicillin	Sigma
Bacto Agar	BD Biosciences
BSA	Biochrom
Ciprofloxacin	Ratiopharm
DTT	Invitrogen
EDTA	Roth
Ethanol	Sigma
Ethidium bromide	Sigma
FCS	Biochrom AG
Glucose	Roth
Glycine	Roth
Hepes buffer	PAA
IMDM	PAA
Ionomycin	Sigma
L-Glutamine	PAA
Magnesium chloride	Roth
Methanol	Sigma
Non-essential amino acids	Gibco BRL
PBS 10x	PAN – Biotech

Penicillin/Streptomycin	PAA
PMA	Sigma
Potassium chloride	Roth
Propidium iodide	Sigma
Recombinant murine IL-3	R&D Systems
Recombinant murine SCF	R&D Systems
S.O.C. medium	Invitrogen
Sodium carbonate	Roth
Sodium chloride	Roth
Sodium pyruvate	Gibco BRL
Sodium vanadate	Sigma
Tris	Roth
Triton X-100	Sigma
Trypan blue	Biochrom AG
Tryptone	Sigma
Tween 20	Sigma
Universal agarose	Peqlab
Vitamins	Gibco BRL
Yeast Extract	BD Biosciences
β -Mercaptoethanol	Gibco BRL

2.3 Reagents

10x Reaction Buffer S	Peqlab
5x First Strand reaction buffer	Invitrogen
anti-DNP IgE	Sigma
Aqua B. Braun	B. Braun
dNTPs	Fermentas
LightCycler 480 Probes Master	Roche
RNase Inhibitor	Fermentas
SuperScript II Reverse Transcriptase	Invitrogen
<i>Taq</i> -Polymerase	Peqlab
TBE Buffer	Bio-Rad

2.4 Buffers and solutions

10x electrode buffer	0.3% (w/v) Tris base 1.44% (w/v) glycine
Erythrocyte lysis buffer	0.83% (w/v) NH ₄ Cl 0.168% (w/v) Na ₂ CO ₃ 1 mM EDTA pH 7.3 sterile filtrated
Tyrode's buffer	10 mM Hepes buffer 130 mM NaCl 5 mM KCl 1.4 mM CaCl ₂ 1 mM MgCl ₂ 5.6 mM glucose 0.1% (w/v) BSA pH 7.4 sterile filtrated

2.5 Media

LB agar	LB medium 1.5% (w/v) agar
LB medium	1% (w/v) tryptone 0.5% (w/v) yeast extract 1% (w/v) NaCl

Mast cell medium	IMDM
	10% (v/v) heat-inactivated FCS
	50 μ M β -mercaptoethanol
	2 mM L-glutamine
	100 U/ml penicillin
	100 μ g/ml streptomycin
	1-fold non-essential amino acids
	1 mM sodium pyruvate

2.6 Primers

The used primers shown in Table 2-1 and Table 2-2 were purchased from Metabion.

Table 2-1 Primer sequences for reverse transcriptase PCR

Primers	Sequences (5'-3')	T _m (C°)
mMCP1-F	AAA GCC CCC TGC AGT CTT CAC C	60
mMCP1-R	AGC TGC TGG AGG TTA GGT C	60
mMCP2-F2	ATG CAG GCC CTA CTA TTC CT	57
mMCP2-R2	ACA CCT CTC CTT CGA ACC GT	57
mMCP5-F	GAA CTA CCT GTC GGC CTG CAG	60
mMCP5-R	AGA ACC TTC TGG AAG CTC AGG	60
mMCP9-F1	AAA ATC TCT CTC CAG ACT GCG A	60
mMCP9-R1	AAG ACT CTG ATG CAC GCA GGT CA	60
Samsn1(372)FlagStopEcoRI R	GGC GTA GAA TTC ACT TGT CAT CGT CGT CCT TGT AGT CGT CAC TGG ATT CTG TGA TGG	55
XhoIKozakSamsn1(1) F	GGC GTA CTC GAG CAC AAC CAT GCT AAA GAG GAA GCC ATC	55
β -Actin F	GTG GGG CGC CCC AGG CAC CA	60
β -Actin R	CTC CTT AAT GTC ACG CAC GAT TTC	60

Primers used for real-time PCR were always combined with the Universal Probe Library (UPL) system from Roche (see section 3.6.1), which uses one standard running protocol and therefore no melting temperature for the primers is given.

Table 2-2 Primer sequences for real-time PCR

Primers	Sequences (5'-3')	UPL Probe #
CCL1-UPL-L	GAA GAA AGA GCT TCC CCT GAA	47
CCL1-UPL-R	CGC AGC TTT CTC TAC CTT TGT T	
Pik3r6-UPL-L	TTC CAG CTG GTG ACA CTG AA	69
Pik3r6-UPL-R	ACA CTG ACG TGC AGA CAG GA	
Serpinb9b-UPL-L	TGT GAG CAT CTC CTC TGC TCT A	79
Serpinb9b-UPL-R	TTC TCT TTC TTC AAA CCA AGT GC	
Taqman Sams F	AAT ACA TCA AAG CTC TTT CTG AGG A	55
Taqman Sams R	TGG GAT CAC TGT TCC GAT ATG	
Taqman-mHprt-F	TCC TCC TCA GAC CGC TTT T	95
Taqman-mHprt-R	CCT GGT TCA TCA TCG CTA ATC	
UPL-Pik3cg-F (PI3Kgamma)	GCT TAG AGG ACG ATG ACG TTT T	78
UPL-Pik3cg-R (PI3Kgamma)	CTG TCG TGG TAC GGT TCA AA	
UPL-Pik3r5-F	GAG CCT ACA GGA GCT GGT CA	79
UPL-Pik3r5-R	GGT GCC TTT CTC TTG GAC CT	
UPL-Pten-F	CCA CAA ACA GAA CAA GAT CGT C	6
UPL-Pten-R	CTT CCA TTT TCC ACT TTT TCT GA	
UPL-SHIP-1-F	CCT CTG TCG CCA AAG AAG TT	76
UPL-SHIP-1-R	AGC TTC CAC CTT TCC CAG AT	
UPL-Socs1-L	GTG GTT GTG GAG GGT GAG AT	19
UPL-Socs1-R	CCC TGA GAG GTG GGA TGA G	

2.7 Antibodies

2.7.1 Antibodies for flow cytometry

CD107a (LAMP1) (1D4B) Alexa-647	eBioscience
CD117/c-kit (2B8) FITC	BD Biosciences
CD16/CD32 (2.4G2)	BD Biosciences
FcεRIα (MAR-1) PE	eBioscience
T1/ST2 (DJ8) FITC	MD Bioproducts

Armenian hamster IgG isotype control PE	eBioscience
Rat IgG _{2b} , κ isotype control PE	Biolegend
Rat IgG ₁ , κ isotype control FITC	BD Bioscience

Antibodies for flow cytometry were fluorescent labeled and diluted 1:100.

2.7.2 Antibodies for Western blot

ACTIN (I-19)	Santa Cruz Biotechnology
AKT (55/PKBa/Akt)	BD Biosciences
p44/42 MAPK (Erk1/2)	Cell Signaling
Phospho-p44/42 MAPK (Erk1/2) (Thr202/Tyr204) (D13.14.4E)	Cell Signaling
Phospho-AKT XP (Ser 473) (D9E)	Cell Signaling
PIK3R5	Protein Tech Group
SHIP-1 (P1C1)	Santa Cruz Biotechnology
Sheep anti-mouse IgG, HRP-linked	GE Healthcare
Goat anti-rat IgG, peroxidase conjugated	Pierce
Rabbit anti-goat IgG, peroxidase conjugated	Pierce

2.8 Vectors

pIRES-EGFP	Clontech
Rac1-V12-pIRES2-EGFP	Dr. Niko Föger (Research Center Borstel)

2.9 Kits

DuoSet Elisa	R&D Systems
miRNA Assay	Applied Biosystems
miRNeasy Kit	Qiagen
RNeasy Kit	Qiagen

2.10 Laboratory supplies

6-/24-/96-well plates	Nunc
Culture flasks	Sarstedt
FACS tubes	Sarstedt

Centrifugation tubes	Sarstedt
Microcentrifuge tubes	Sarstedt
Petri dishes	Sarstedt
Pipette tips	Sarstedt
Plastic pipettes	Greiner Bio-One
Transwell, 6.5 mm, 8.0µm Pore	Corning

2.11 Laboratory equipment

Bench XR-200s	Kojair
Centrifuge MiniSpin	Eppendorf
Centrifuge 5810 R	Eppendorf
Cytocentrifuge (Cytospin3)	Shandon
ELISA reader	Tecan
ELISA washer	Tecan
FACS Calibur flow cytometer	BD Biosciences
Incubator Hera Cell 150	Heraeus
LightCycler 480 System	Roche
Thermomixer	Eppendorf
Microscope CK40	Olympus
pH meter	Mettler Toledo
Pipettes	Eppendorf
Power supply (Power PAC Universal)	Bio-Rad Laboratories
Precision Balance	A&D Instruments
Thermocycler T3000	Biometra
Thermoblock	Grant Instruments
Transluminator	Biometra
Minishaker MS2	IKA
Waterbath	Memmert

2.12 Analyzing software

FlowJo

Tree Star Inc.

Magellan

Tecan

Prism

GraphPad

ImageJ

National Institutes of Health, NIH

3 Methods

3.1 Cell culture

3.1.1 Generation and cultivation of BMMCs

To study mast cell (MC) phenotype and function, bone marrow-derived mast cells (BMMCs) were used. BMMCs were generated as previously described by Razin et al. (Razin et al., 1984) and Dvorak et al. (Dvorak et al., 1994). Bone marrow of femur and tibia of mice was flushed using phosphate buffered saline (PBS). Cells were centrifuged at 270 x g for 5 min at RT and erythrocytes were lysed with 1 ml of erythrocyte lysis buffer (see section 2.4) for 10 min at RT. Cells were then washed with mast cell medium and cultivated in a 75 cm² flask with 20 ml MC medium and 5 ng/ml recombinant murine IL-3 and 10 ng/ml recombinant murine SCF. Every week, cells were collected, washed in MC medium and taken up in fresh medium with supplements. Starting from week 4, cells were counted (section 3.1.2) and seeded out at a density of 0.4x10⁶ cells/ml. During the first two weeks Ciprofloxacin was added at a concentration of 10 µg/ml. Mast cells were maintained at 37°C and 7,5% CO₂.

At five weeks of culture, cells were tested for surface expression of FcεRIα, CD117 (c-kit) and T1/ST2 using flow cytometry (see section 3.18).

3.1.2 Cell counting

Trypan blue dye permeates the membrane of dead cells and stains them blue, enabling the exclusion of dead cells. Working solution of trypan blue was prepared by diluting trypan blue 1:10 in 0.9% NaCl. The cell suspension to be counted was diluted 1:10 in the working solution of trypan blue and cells were counted using a Neubauer counting chamber under the optical microscope.

3.2 Giemsa staining of mast cells

To check MC populations phenotypically, cells were stained with GS500 Giemsa dye (Sigma). For this, cytopspins of MCs were prepared using a cytocentrifuge on 76 x 26 mm microscope slides. After drying for up to 36 h, cells were fixed with methanol for 5 min and air dried. To stain cells, Giemsa dye was diluted 1:20 in distilled water and added to the cells for 30 min. Microscope slides were then washed with distilled water and air-dried before being evaluated using a microscope.

3.3 RNA isolation

3.3.1 Total RNA isolation

Total RNA extraction of immune cells was performed using the RNeasy Mini Kit from Qiagen according to the manufacturer's instructions.

3.3.2 miRNA isolation

To isolate total RNA including microRNAs, the miRNeasy Mini Kit (Qiagen) was used following the company's protocol.

3.4 cDNA synthesis

3.4.1 cDNA from total RNA

For checking the expression of genes by conventional or real-time PCR a cDNA synthesis was performed using oligo(dT)-primers. For this 2.5 µg RNA together with 1.25 µl of cDNA-Synthesis-Primer (10 pmol/µl) and filled with H₂O to obtain a total volume of 12.5 µl, were incubated at 70°C for 10 minutes. For each sample 12.5 µl of the mastermix shown in Table 3-1 were added. The reverse transcription was performed at 42°C for 3 hours following 15 minutes at 70°C. Each sample was diluted 1:5 with water.

Table 3-1 Mastermix for cDNA synthesis

Components	Volume [μ l]
5x first strand reaction buffer	5
DTT (0.1 M)	2.5
dNTPs (10 mM)	1.25
RNase inhibitor	0.5
H ₂ O	2.75
Superscript II (200 U/ μ l)	0.5
Σ	12.5

3.4.2 cDNA from microRNAs

To generate cDNA for the measurement of miRNA expression the TaqMan MicroRNA Assay (Applied Biosystems) was used according to the manufacturer's protocol. This assay includes reverse transcription with a miRNA-specific primer and real-time PCR with a TaqMan probe.

3.5 Polymerase chain reaction (PCR)

Polymerase Chain Reaction is a method to specifically amplify DNA. First DNA was denatured into single stranded DNA (denaturation step). During the annealing reaction, sequence-specific primers bind to the single stranded DNA (annealing step). Afterwards, the thermostable Taq DNA polymerase is then able to elongate the annealed primers in the direction of the 3' end (elongation step) (Saiki et al., 1988).

Primers used for PCR analysis are shown in section 2.6. A standard PCR reaction contains the components illustrated in Table 3-2.

Table 3-2 PCR reaction mix

Component	Volume [μ l]
H ₂ O	13.82
10x reaction buffer S	2
Primer A (10 μ M)	1
Primer B (10 μ M)	1
dNTPs (10 mM)	0.36
Taq polymerase	0.32
Σ	18.5

To this PCR reaction mix 1.5 μ l of diluted cDNA was added. A typical PCR reaction includes the following steps:

initial denaturation	95°C	5 min	
denaturation	93°C	30 sec	} 30 cycles
annealing	T_m	30 sec	
elongation	72°C	20 sec	
final elongation	72°C	10 min	

The annealing temperature T_m is dependent on the GC content of used primers, which is about 5°C lower than the melting temperature of the primers and which is given in Table 2-1.

3.6 Real-time PCR

3.6.1 Conventional real-time PCR

For analyzing gene expression the Universal Probe Library (UPL) System (Roche) was used. Fluorescent labeled TaqMan probes work in combination with target gene-specific primers.

The primers together with the corresponding UPL Probes are found in section 2.6. The samples were measured in a Roche LightCycler 480 System using the following program:

initial denaturation	95°C	10 min	
amplification	95°C	15 sec	} 55 cycles
annealing	60°C	30 sec	
elongation	60°C	1 sec	

3.6.2 miRNA-specific real-time PCR

For the measurement of each miRNA expression the TaqMan MicroRNA Assay (Applied Biosystems) was used according to the manufacturer's protocol. The samples were measured in a Roche LightCycler 480 System with the following program:

initial denaturation	95°C	10 min	
amplification	95°C	15 sec	} 55 cycles
annealing	60°C	1 min	
elongation	60°C	1 sec	

3.7 Microarray

Gene ST microarray analysis was performed by the Expression Core Facility of the Institute for Medical Microbiology, Immunology and Hygiene from the Technical University Munich.

3.8 Agarose gel electrophoresis

To separate nucleic acids agarose gels (1.5% to 2% (w/v) agarose in 1x TBE) supplemented with 0.07% (v/v) ethidium bromide were used. Samples were taken up in DNA Loading Dye (Fermentas). The electrophoresis was performed in horizontal gel chambers (Bio-Rad) with 1x TBE (Bio-Rad) at 100 volt. Fragment sizes were estimated using DNA ladders (Fermentas).

3.9 Extraction of DNA from agarose gels

Nucleic acids that were separated on agarose gels were excised under UV light and purified using the High Pure PCR Product Purification Kit (Roche) according to the manufacturer's protocol.

3.10 DNA digestion

Amplified PCR products which were used as inserts for ligation as well as vectors were cut with restriction enzymes. For this, 1 µg of DNA was incubated with 1 unit of the designated FastDigest enzyme in FastDigest Buffer (Fermentas) according to the manufacturer's protocol.

3.11 Ligation

Purified DNA fragments were ligated into linearized plasmids using 1 unit T4 DNA ligase (Fermentas) with 5 fold molar excess of insert. The reaction was incubated for 30 min at RT.

3.12 Transformation

E.coli XL1-blue chemocompetent cells (Stratagene) were mixed with 5 µl of ligation reaction, incubation for 30 minutes on ice and heat shocked (35 seconds, 42°C). Then, 250 µl prewarmed S.O.C. medium was added followed by further incubation at 37°C for 60 minutes with agitation. From this reaction 100 µl were plated on prewarmed LB agar plates supplemented with 50 ng/ml kanamycin and incubated over night at 37°C.

3.13 Colony PCR screen

After the transformation (see section 3.12) the clones grown on the agar plate were picked with an autoclaved tooth pick and transferred to a PCR reaction mix. Using PCR the presence of the insert was checked. For this the same primers as for the amplification were used (see section 2.6).

3.14 Purification of nucleic acids

Plasmid DNA was purified using the FastPlasmid Mini Kit (Eppendorf) according to manufacturer's protocol.

3.15 Quantification of nucleic acids

The concentration of nucleic acids was quantified using optical density (OD) by measuring absorbance at 230, 260 and 280 nm.

3.16 Sequencing

Sequencing of plasmid DNA was performed by Agowa GmbH by using the method of DNA sequencing with chain-terminating inhibitors (Sanger et al., 1977).

3.17 Transfection

For transfection of plasmid DNA into BMDCs the Nucleofector Technology by Lonza was used. For this, 2×10^6 cells were taken up in Nucleofector Solution T, transferred into the provided cuvette and electroporated using program T-16 of the Nucleofector II device. After this the transfected cells were plated in MC medium in 6-well plates with supplemented with 1 ng/ml rm-IL-3.

One day post transfection the transfected cells were incubated over night with 0.2 ng/ml DNP-specific IgE and LAMP1 degranulation assay (see section 3.21.2) was performed.

3.18 Flow cytometry

For surface FACS staining, 2×10^5 BMDCs were washed once and resuspended in 100 μ l PBS + 2% FCS before adding the antibody (see section 2.7.1). Isotype control stained cells were used as a negative control. Staining was performed in a 96-well round-bottom plate.

After adding the antibody the cells were incubated in the dark at 4°C for 30 min. After washing the cells three times with 100 μ l PBS + 2% FCS, the cells were transferred into 5 ml FACS tubes for measurement in the FACS Calibur flow cytometer. Gates were set on alive cells according to the forward-sideward scatter and then according to the staining that was performed as stated in the experiments. Analysis was done using FlowJo software.

3.19 Mast cell stimulation

One day prior to stimulation BMDCs were seeded in 6-well plates at a density of 1×10^6 cells/ml in MC medium supplemented with 1 ng/ml rm-IL-3 and 0.2 μ g/ml DNP-specific IgE.

For stimulation, mast cells were washed with PBS, counted and seeded into 48-well plates at a density of 2×10^6 cells/ml in MC medium supplemented with 1 ng/ml rm-IL-3. 250 μ l of 2x concentrated stimulus (or MC medium for the unstimulated control) was added and cells were incubated for the time indicated in each experiment. After this the supernatant was collected, centrifuged at 1600 rpm and 4°C and frozen at -20°C.

3.20 Cytokine measurement

Supernatants from stimulated mast cells (see section 3.19) were used to analyze the cytokine production. For that, enzyme-linked immunosorbent assay (ELISA) was performed using DuoSet ELISA Development Kits (R&D Systems) measuring IL-6 and TNF- α concentration according to the manufacturer's protocol.

3.21 Degranulation assays

3.21.1 β -Hexosaminidase measurement

Degranulation of mast cells measuring the β -hexosaminidase release was measured as described by Oda et al. (Oda et al., 2009). BMMCs were sensitized with 0.2 μ g/ml anti-DNP IgE in MC medium with 1 ng/ml rm-IL-3 and incubated over night at 37°C. Cells were then washed once in PBS, centrifuged at 270 x g for 5 min at RT and washed again in Tyrode's buffer. After the washing the cells were resuspended in Tyrode's buffer at a density of about 7×10^6 cells/ml and for each stimulation 50 μ l of the cell suspension was transferred into a 96-well round bottom plate. For stimulation DNP-HSA was added to obtain the indicated final concentrations and PMA (100 ng/ml) and ionomycin (1 μ M) for the positive control. The cells serving as negative control were treated with Tyrode's buffer only. The cells were then incubated at 37°C for 10 min followed by centrifugation as above. Keeping the centrifuged plate on ice, the supernatant from each sample was collected and the remaining cell pellet lysed in 50 μ l Tyrode's buffer + 0.5% Triton-X100 for 10 min at RT. After centrifugation the lysed cells as well as the supernatant (5 μ l per sample in triplicates) were mixed with the substrate (1.3 mg/ml p-nitrophenyl-N-acetyl- β -D-glucosamine/ml in 0,1 M sodium citrate, pH 4.5) and incubated for 25 min at 37°C. The reaction results in p-nitrophenol production, which was stopped by adding 0.2 M glycine (pH 10.7). p-nitrophenol production was assessed by measuring the absorbance at 405 nm.

Percent degranulation was calculated by dividing the absorbance of p-nitrophenol in the supernatants by the sum of the absorbance in supernatant and total cell lysates times 100.

3.21.2 LAMP1 staining

To analyze the degranulation of BMMCs the expression of lysosomal-associated membrane protein 1 (LAMP1) on the cell surface was measured.

For this, BMMCs were plated in 6-well plates (2×10^6 cells/well), sensitized with 0.2 μ g/ml anti-DNP IgE in MC medium supplemented with 1 ng/ml rm-IL-3 and incubated over night at 37°C. Cells were then washed once with PBS, centrifuged at 270 x g for 5 min at RT, washed again and resuspended in Tyrode's buffer. Cells were then transferred to a 96-well round bottom plate and stimulated with the different concentrations of DNP-HSA, PMA (100 ng/ml)

and ionomycin (1 μM) as positive control or with only Tyrode's buffer as negative control for 10 min at 37°C. The reaction was stopped with cold PBS + 2% FCS and cells were washed. To block non-antigen-specific binding the cells were incubated with 5 $\mu\text{g}/\text{ml}$ anti-mouse CD16/CD32 antibody diluted in PBS supplemented with 2% FCS for 15 min on ice. After centrifugation, AlexaFluor 647-labeled anti-mouse CD107a (LAMP1) antibody (eBioscience) was added at a concentration of 2 $\mu\text{g}/\text{ml}$ and incubated for 30 min on ice. Afterwards, washed cells were analyzed by flow cytometry (see section 3.18).

3.22 Migration assay

To assess the migration of bone marrow-derived mast cells towards rm-SCF, mast cells were cultured over a period of 4 weeks without rm-SCF and seeded out at a concentration of 1×10^6 cells/ml with 1 ng/ml rm-IL-3 one day prior to the experiment. The next day cells were washed with PBS, followed by washing with MC medium supplemented with 0.5% BSA and resuspended in 1 ml MC medium containing 0.5% BSA. 100 μl of this cell suspension was added to the upper chamber of the transwell in a 24-well plate. The bottom of the well was filled with 600 μl MC medium containing 0.5% BSA with or without recombinant murine SCF in different concentrations. To control the input of cells, 10 μl (=10%) of the cell suspension was seeded in 600 μl MC medium containing 0.5% BSA in a well without insertion of the transwell. This input control was done in triplicates, the stimulated cells in duplicates. The cells were incubated for 4 h at 37°C.

After the incubation time, the transwell was removed, cells were resuspended thoroughly and transferred into FACS tubes. Cells were counted in the FACS calibur by measuring for a period of 50 sec. The number of cells from the transwells was calculated as a ratio of the 10-fold input control.

3.23 Protease measurement

The total protease activity was measured analyzing the casein degradation of total mast cell lysates. For this, EnzCheck Protease Assay Kit (Molecular Probes) was used with the following changes: 2×10^6 cells were washed in Tyrode's buffer and lysed for 30 min on ice in 200 μl lysis buffer (150 mM NaCl, 50 mM Tris-HCl, 1 mM MgCl_2 , 1 mM CaCl_2 , 2 ZnCl_2 ,

0.5% NP-40, pH 7.4). After centrifugation, lysates were incubated in substrate buffer (10 $\mu\text{g/ml}$ BODIPY FL casein solution in 1x digestion buffer) and samples were incubated at 37°C for 24 h. Fluorescence was measured at 485 nm excitation and 530 nm emission. As positive control 2.5 $\mu\text{g/ml}$ trypsin was used and lysis buffer without cells served as negative control.

3.24 Signaling assay

To study signaling in BMMCs, 2×10^6 cells/ml were sensitized with 0.2 $\mu\text{g/ml}$ anti-DNP IgE in MC medium supplemented with 1 ng/ml rm-IL-3 and incubated over night at 37°C. The next day, cells were washed in PBS and resuspended in Tyrode's buffer. Counted cells were adjusted to a concentration of 5×10^6 cells/ml and for each stimulation timepoint 1×10^6 cells were used. Tubes were prewarmed at 37°C for 15 minutes. Cells were stimulated DNP-HSA antigen at 37°C with shaking and centrifuged at maximum speed for 15 sec. The supernatant was aspirated and the cell pellet lysed in 100 μl lysis buffer (150 mM NaCl, 10 mM Tris-HCl pH 8.8, 1% NP-40, 1 mM Na_3VO_4 , 10 mM NaF, Roche Protease Inhibitor Cocktail Tablet) for 20 minutes on ice. After another centrifugation step, lysates were collected and used for SDS-PAGE (see section 3.25) or stored at -20°C for further analysis.

3.25 SDS Polyacrylamide Gel Electrophoresis (PAGE)

SDS-PAGE is a method to separate proteins according to their molecular weight, which can then be visualized in a Western blot.

In brief, the cell lysates were diluted in 4x Laemmli buffer (62.5 mM Tris-HCl pH 6.8, 20% glycerol, 2% SDS, 5% β -mercaptoethanol, 0.025% bromophenol blue) and denatured at 95°C for 5 minutes. The samples were loaded onto 3.9% stacking gel and the separated using gels from 7-15% (see Table 3-3) depending on the molecular weight of the analyzed proteins.

Table 3-3 Components of gels for SDS-PAGE

	stacking gel 3.9%	separating gel 7-15%
Tris-HCl pH 6.8	-	25%
Tris-HCl pH 8.8	25%	-
SDS 10%	1%	1%
30% Acrylamide / Bisacrylamide	13%	23.5-49.5%
10% Ammonium persulfate	0.50%	0.50%
TEMED	0.03%	0.03%

Gel electrophoresis was done using the Mini Protean Tetra Cell System (Bio-Rad) with running buffer (1x electrode buffer, 1% SDS) and a current of 60 volt for 25 minutes followed by 120 volt for 65 minutes. As a standard Precise Plus Protein Dual Color Standard (Bio-Rad) was used.

3.26 Western blot

Proteins separated by SDS-PAGE were transferred to Immobilon-P PVDF membrane (Millipore) using the Mini Protean Tetra Cell System (Bio-Rad) and blotting buffer (1x electrode buffer, 10% methanol, 0.025% SDS). Afterwards, the membrane was blocked in SuperBlock T20 (TBS) Blocking (Thermo Scientific) for 1 hour at RT and incubated with the primary antibody diluted in SuperBlock over night at 4°C. Following washing of the membrane with washing buffer (8.5% NaCl, 10 mM Tris-HCl pH 7.4, 0.05% Tween), the membrane was incubated with the secondary antibody diluted in washing buffer for 1 hour at RT. After washing, the membrane was developed using the Immobilon Western Chemiluminescent HRP Substrate (Millipore) and signals were detected using the Kodak Developing Machine II.

3.27 Statistical analysis

All parametric data are presented as mean values \pm standard error of mean (SEM). For statistical analysis the Mann-Whitney test was performed, unless otherwise stated. A p-value of <0.05 was considered statistically significant.

4 Results

4.1 Adaptor protein SAMSN1

SAMSN1, also known as HACSI1, NASH1 or SLY2 has been described to be an adaptor protein belonging to the SLY protein family. It was shown to be expressed in cell lines from human B cell malignancies and cultured dendritic cells (Wang et al., 2010). Its low expression in memory and naïve B cells increased after the B cell activation with interleukin (IL)-4, CD40L, and anti-IgM (Zhu et al., 2004b). Furthermore, early studies have reported SAMSN1 expression in human cord blood-derived mast cells (Uchida et al., 2001).

However, the functional role of SAMSN1 in mast cells is yet unknown. Because of its high expression in human mast cells (Uchida et al., 2001), the investigation of its function *in vitro* as well as *in vivo* appeared an interesting goal to pursue. To this purpose, the expression and function of SAMSN1 was investigated in the murine system using both murine bone marrow-derived mast cells (BMMCs) overexpressing *Samsn1* as well as BMMCs deficient for *Samsn1* obtained from *Samsn1*^{-/-} mice.

4.1.1 Analysis of *Samsn1* mRNA expression in BMMCs

As mentioned above, *Samsn1* expression has only been described in human cord blood mast cells (Uchida et al., 2001), but not in murine mast cells of any origin. To gain more insight into the current available information on *Samsn1* expression in murine mast cells, data from the program BioGPS (<http://biogps.gnf.org>), a centralized gene portal that collects data from microarray analyses, were utilized (Wu et al., 2009). The data used for *Samsn1* expression originate from the group of Matthew Sweet (Lattin et al., 2008) and revealed that *Samsn1* is expressed in macrophages, DCs, follicular B cells, at very high levels in the Baf3 cell line and interestingly in murine naïve as well as activated mast cells (Figure 4-1). Thus, *Samsn1* is interestingly most highly expressed in mast cells and the level of expression is not affected by FcεRI cross-linking with IgE and antigen. This is different in macrophages, in which *Samsn1* is expressed at constitutive low levels but inducible after LPS stimulation.



Figure 4-1 Expression of *Samsn1* in different murine cells and tissues.

Expression of *Samsn1* in unstimulated and IgE and antigen stimulated mast cells (red bars), B cells (turquoise bars), dendritic cells (blue bars) and macrophages (orange bars). Expression data obtained from BioGPS (<http://biogps.gnf.org>).

To verify that primary murine mast cells derived from the bone marrow of wild-type (WT) mice do express *Samsn1*, real-time PCR analysis was performed. Levels of *Samsn1* gene expression were measured and normalized to the expression of the housekeeping gene *hypoxanthine phosphoribosyltransferase (hprt)* in each sample. Results obtained show a high expression of *Samsn1* mRNA in WT BMMCs and no expression in *Samsn1*^{-/-} BMMCs, which were used as a negative control to verify the specificity of the assay (Figure 4-2, A). *Sly1*, another SLY family protein, did not show a difference in mRNA expression between WT and *Samsn1*^{-/-} BMMCs (Figure 4-2, B).

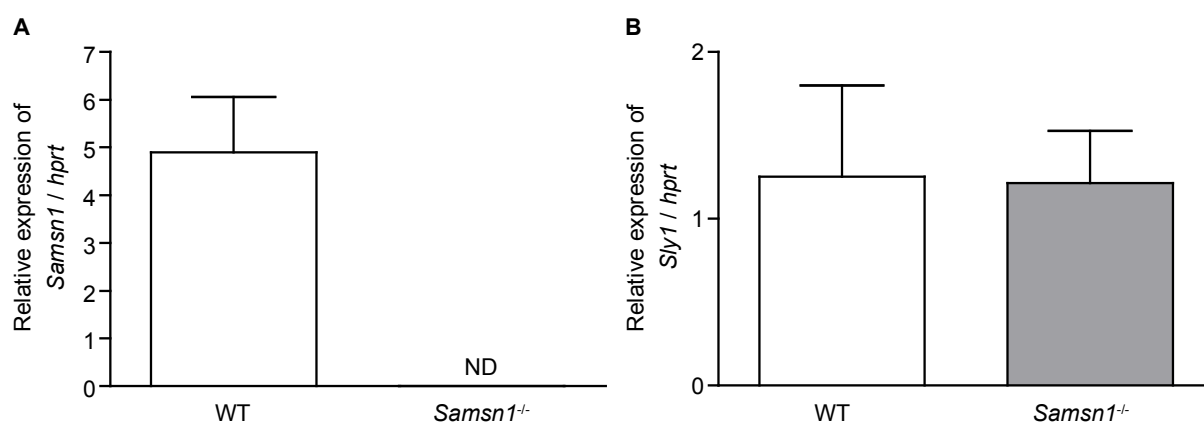

Figure 4-2 Expression of *Samsn1* and *Sly1* mRNA in WT BMMCs.

RNA isolated from unstimulated WT and *Samsn1*^{-/-} BMMCs (n=6) was reverse transcribed to cDNA. Real-time PCR was performed to evaluate *Samsn1* (A) and *Sly1* (B) mRNA expression normalized to *hprt*. WT BMMCs show high expression of *Samsn1* mRNA whereas the *Samsn1*^{-/-} BMMCs show no *Samsn1* gene expression. *Sly1* mRNA is expressed at a comparable level in WT and *Samsn1*^{-/-} BMMCs. ND – not detectable.

4.1.2 SAMSIN1 overexpression in BMMCs does not affect mast cell degranulation

As a first approach to test SAMSIN1 function in BMMCs and to test whether mast cell activities such as FcεRI-mediated degranulation are influenced by SAMSIN1 expression, SAMSIN1 was overexpressed in BMMCs from WT mice. To this purpose I generated a construct encoding the SAMSIN1. This was done by amplification of the SAMSIN1 coding sequence from mast cell cDNA with the addition of a FLAG-tag, which was then cloned into a pIRES2-EGFP vector. pIRES2-EGFP includes an internal ribosomal entry site (IRES), which allows the translation of the gene of interest and the EGFP gene from one bicistronic

mRNA. Therefore, transfected cells can be selected on the basis of high GFP expression using flow cytometry.

Using the Lonza Nucleofector system, the resulting construct was transfected into C57BL/6 WT mast cells followed by sensitization with IgE and stimulation with or without antigen. Transfecting the cells with the empty pIRES-EGFP vector served as a negative control. As a positive control, cells were transfected with a pIRES-EGFP plasmid containing a constitutive active point mutant of Rac1 (Rac1-V12). Rac1 has been shown to be essential for and enhance mast cell degranulation (Price et al., 1995).

Degranulation of transfected cells was analyzed via flow cytometry by measuring LAMP1 surface expression. Alive cells were gated on GFP positive for transfected cells and on GFP negative for untransfected cells.

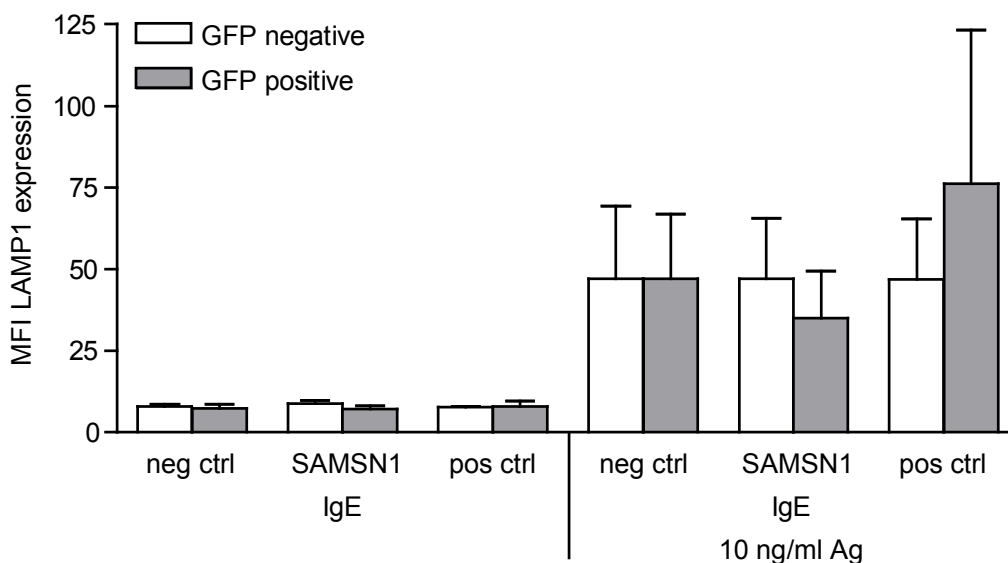

Figure 4-3 Comparable LAMP1 expression in BMDCs overexpressing SAMSN1.

Bone marrow-derived mast cells were transfected with an empty pIRES2-EGFP vector (neg ctrl), Samsn1-Flag-pIRES2-EGFP construct (SAMSN1) or a constitutive active Rac1-V12-pIRES2-EGFP vector (pos ctrl). 24h post transfection, cells were sensitized with anti-DNP IgE over night and then stimulated with 10 ng/ml DNP-HSA antigen (Ag) for 10 min. Using FACS analysis, alive cells were gated on either low (GFP negative) or high (GFP positive) GFP expression. Results show mean fluorescence intensity (MFI) of LAMP1 expression of 2 experiments (n=2).

As shown in Figure 4-3, BMDCs transfected with the empty vector (negative control) and SAMSN1 overexpressing cells as well as cells overexpression the constitutive active form of Rac1 (Rac1-V12, positive control) do not display any LAMP1 staining by simple exposure to IgE. Upon stimulation with specific antigen, both GFP negative and GFP positive cells

overexpressing SAMS1 show a clear but comparable LAMP1 expression and therefore degranulation. Results show mean fluorescence intensity (MFI) of LAMP1 surface expression, which represents the amount of bound fluorochromes measured per particle. Cells transfected with the empty vector served as negative control and show an equal degranulation, positive control cells overexpressing Rac1-V12 display a higher LAMP1 expression in the GFP positive cells.

In conclusion, the overexpression approach did not reveal a specific function for SAMS1 in the regulation of FcεRI-mediated degranulation. One explanation could be the already high expression of SAMS1 in mast cells. Therefore, overexpressing the protein might not lead to any detectable differences in FcεRI-mediated mast cell degranulation.

Since overexpressing SAMS1 does not lead to a change in degranulation in BMMCs, further functional analyses in primary murine mast cells were studied in BMMCs deficient for *Samsn1*. This model allows comparing BMMC function from WT mice with cells from *Samsn1*^{-/-} mice and therefore studying which functions are impaired or enhanced in the absence of SAMS1.

4.1.3 *Samsn1*^{-/-} BMMCs proliferate and differentiate normally *in vitro*

In mice, SAMS1 is expressed in lymph node sinusoids and splenic red pulp and its expression is upregulated in splenic B cells after stimulation with IL-4, CD40L and anti-IgM (Zhu et al., 2004b).

Recently, SAMS1 has been described to function as an inhibitory adaptor protein modulating B cell receptor (BCR)-mediated cell activation (Wang et al., 2010).

Thus, I was interested to analyze whether mast cells deficient for *Samsn1* are anomalous in function. *Samsn1*^{-/-} mice and the matching WT controls were kindly provided by Dr. Sandra Beer-Hammer and Prof. Klaus Pfeffer (University Düsseldorf). From these mice, BMMCs were generated *in vitro* for the following experiments.

During the culture, WT and *Samsn1*^{-/-} BMMCs were seeded at a defined concentration and counted weekly to investigate whether proliferation was affected in *Samsn1*^{-/-} BMMCs. Figure 4-4 shows the fold increase in cell number of WT and *Samsn1*^{-/-} BMMCs from week 5 to week 6 of culture. Since the growing rate is comparable, SAMS1 deficiency does not affect the proliferation of murine BMMCs.

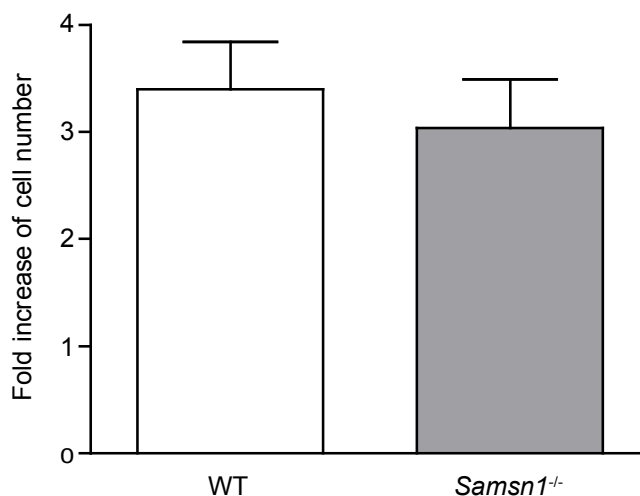

Figure 4-4 *Samsn1*^{-/-} BMMCs grow at a comparable rate to WT BMMCs.

BMMCs from WT and *Samsn1*^{-/-} mice were seeded out at a concentration of 2×10^6 cells/ml and cultured in mast cell medium with rm-IL-3 and rm-SCF. After one week of culture, the cells were counted and the fold increase of cells was calculated. Data obtained from 6 weeks old cells (n=8).

The purity of mast cell cultures was defined by testing the expression of specific mast cell markers on the surface of the cells. These markers include c-kit (CD117), FcεRI and T1/ST2. A high expression of all three markers could be observed both in WT and *Samsn1*^{-/-} mast cells compared to the matching isotype controls. Yet no difference in the extent of expression of these markers between WT and *Samsn1*^{-/-} BMMCs was detected (Figure 4-5). Hence, these data suggest that the differentiation of bone marrow stem cells to mature mast cells is unaffected by the absence of SAMSIN1 protein expression.

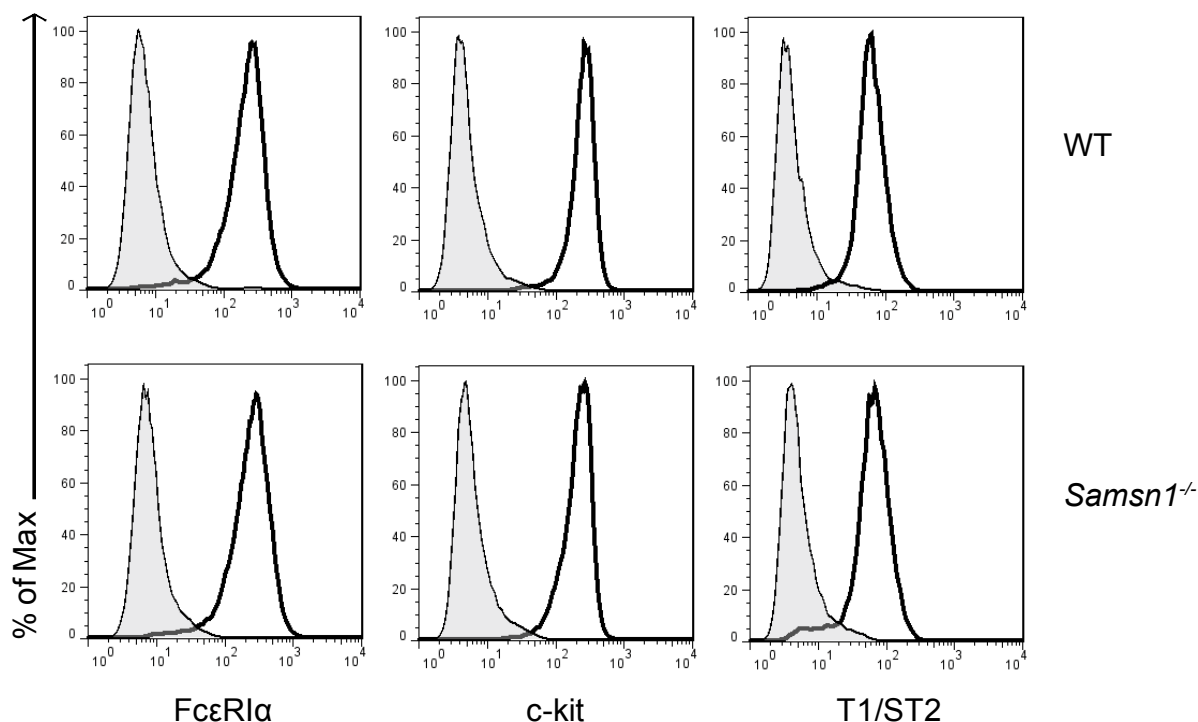

Figure 4-5 *Samsn1*^{-/-} BMDCs show typical mast cell marker expression.

BMDCs from WT (top panel) and *Samsn1*^{-/-} mice (bottom panel) were stained with antibodies directed against FcεRIα, c-kit (CD117) and T1/ST2. Results show representative experiment of surface expression of these mast cell-specific markers. Bold lines show staining for the specific marker and filled histograms show the matching isotype controls.

4.1.4 *Samsn1*^{-/-} BMDCs show normal degranulation

One of the most important functions of mast cells is the release of their cytoplasmic granula. This process of degranulation can be assessed with different methods. Among those is the measurement of surface expression of the lysosomal associated membrane protein 1 (LAMP1), which is expressed on the granula membrane and can be measured on the surface of the cell upon degranulation using flow cytometry (Raposo et al., 1997). Another assay measures the β-hexosaminidase release from the granula of the mast cell (Oda et al., 2009). In both assays, cells are loaded with IgE and then stimulated with antigen for 10 minutes. Both of the above described methods were used to determine if mast cell degranulation differs in *Samsn1*^{-/-} compared to WT BMDCs.

Measurement of LAMP1 expression on the surface of the mast cells shows hardly any degranulation when BMDCs were sensitized with IgE only. Upon stimulation with increasing concentrations of antigen (Ag), a dose-dependent increase of LAMP1 expression was observed. Stimulation of cells with phorbol 12-myristate 13-acetate (PMA) and the ionophore

ionomycin (Iono) served as a positive control for degranulation. PMA directly activates protein kinase C (PKC) and ionomycin stimulates cells by mobilizing free calcium ions, thereby inducing degranulation without activation of the FcεRI pathway. LAMP1 expression and therefore degranulation was significantly decreased in *Samsn1*-deficient BMMCs when sensitized with IgE and stimulated with 10 ng/ml antigen compared to WT BMMCs. However, this result could not be extended to other concentrations of antigen (Figure 4-6, A).

Measurement of β-hexosaminidase release was comparable between the WT and *Samsn1*^{-/-} BMMCs (Figure 4-6, B). Only low levels of β-hexosaminidase were released upon sensitization of BMMCs with IgE, whereas the release increased upon stimulation of cells with increasing concentrations of DNP-HSA antigen in a dose-dependent manner. Again stimulation with PMA and ionomycin served as a positive control and revealed no difference between the degranulation of WT and *Samsn1*^{-/-} BMMCs.

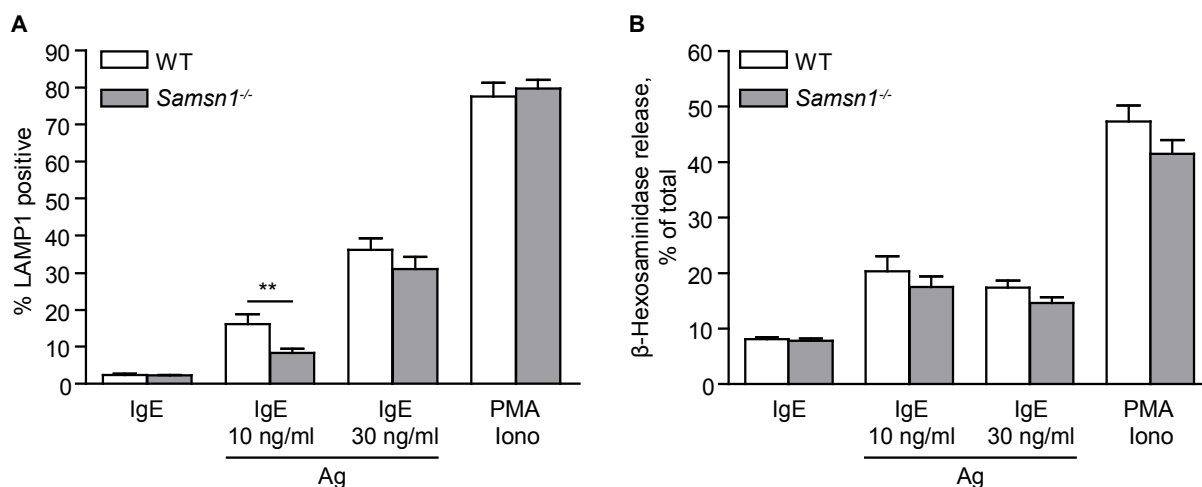

Figure 4-6 Normal BMMC degranulation in *Samsn1*^{-/-} BMMCs.

BMMCs from WT and *Samsn1*^{-/-} mice were sensitized with anti-DNP IgE over night and stimulated for 10 minutes with 5 and 20 ng/ml DNP-HSA antigen (Ag), PMA and ionomycin (Iono) or left unstimulated. **A** – Degranulation of LAMP1 expression was measured via flow cytometry. Percentage of LAMP1 positive cells is shown from 4 experiments with WT (n=9) and *Samsn1*^{-/-} (n=12) mast cells. **p<0.005. **B** – β-Hexosaminidase release from granules of mast cells was measured. Data show results from 3 experiments with WT (n=7) and *Samsn1*^{-/-} (n=9) BMMCs.

In conclusion, no consistent differences in the degranulation between WT and *Samsn1*^{-/-} BMMCs could be shown by both assays used.

4.1.5 *Samsn1*^{-/-} and WT BMDCs do not differ in cytokine release

To further investigate the role of SAMS1 in regulating mast cell activities, the release of cytokines such as IL-6 and TNF- α , was measured by ELISA. For this, the mast cells were sensitized with anti-DNP IgE and then stimulated with the indicated concentrations of DNP-HSA antigen for 4 hours. Stimulation of cells with PMA and the ionophore ionomycin served as a positive control. After stimulation, supernatants were tested for cytokine levels.

As seen in Figure 4-7, WT BMDCs as well as BMDCs deficient for *Samsn1* were able to produce the two cytokines upon stimulation with antigen and PMA/ionomycin. However, BMDCs from WT and *Samsn1*^{-/-} mice did not show considerable differences in the levels of TNF- α (Figure 4-7, A) and IL-6 secretion (Figure 4-7, B) when stimulated with different concentrations of antigen.

Taken together, no difference in the release of these two selected cytokines could be detected in *Samsn1*^{-/-} BMDCs compared to WT control mast cells.

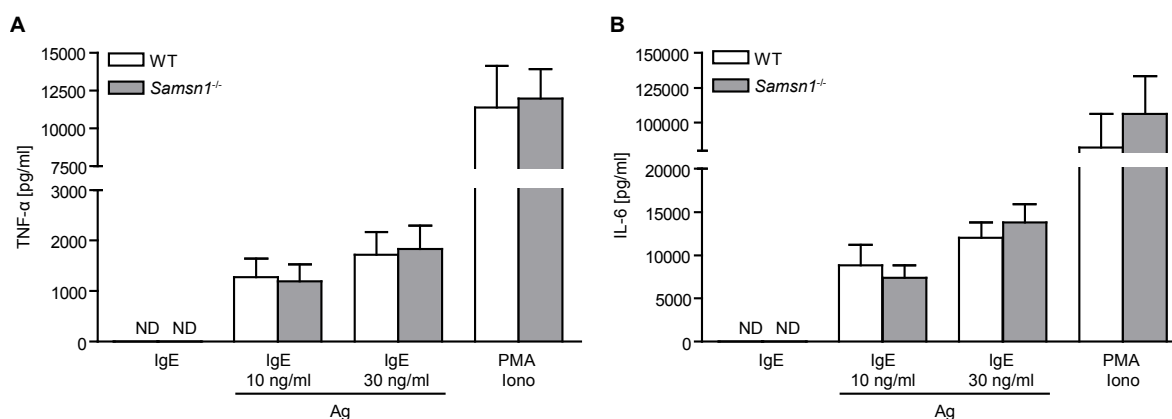

Figure 4-7 Cytokine release in *Samsn1*^{-/-} BMDCs is not defective.

BMDCs from WT and *Samsn1*^{-/-} mice were sensitized with anti-DNP IgE over night followed by stimulation with or without DNP-HSA antigen (Ag) or with PMA and ionomycin (Iono) for 4h. BMDCs from *Samsn1*^{-/-} mice show no change in TNF- α (A) and IL-6 (B) release after stimulation with different concentrations of antigen. Data show results from 3 experiments with BMDC from WT (n=6) and *Samsn1*^{-/-} (n=7) mice. ND – not detectable.

4.1.6 *Samsn1*^{-/-} BMDCs display normal Fc ϵ RI-mediated signaling

The signaling pathways that are activated after binding of IgE to the Fc ϵ RI followed by cross-linking with antigen involve various different molecules and lead to the rearrangement of the

cytoskeleton, movement of vesicles and to the activation of mitogen-activated protein kinases (MAPK) (Alvarez-Errico et al., 2009). To examine the role of MAPK signaling in *Samsn1*^{-/-} BMMCs compared to WT cells, FcεRI-mediated phosphorylation of the MAPK extracellular signal-regulated kinase (ERK) was analyzed.

For the analysis of signaling in WT and *Samsn1*^{-/-} BMMCs, Western blotting was performed using lysates of cells that were sensitized with IgE and stimulated with DNP-HSA antigen at different time points as indicated. These lysates were then blotted and proteins were detected with antibodies against phosphorylated ERK and total ERK. Without antigen stimulation, no phosphorylation of ERK protein was detectable. Upon antigen stimulation, phosphorylation of ERK was initiated and maintained at a constant level until 5 min of stimulation. After 10 min, ERK phosphorylation decreased again. However, no difference in the ERK-phosphorylation between WT and *Samsn1*^{-/-} BMMCs was detectable. Total ERK protein levels were comparable between WT and *Samsn1*^{-/-} BMMCs (Figure 4-8).

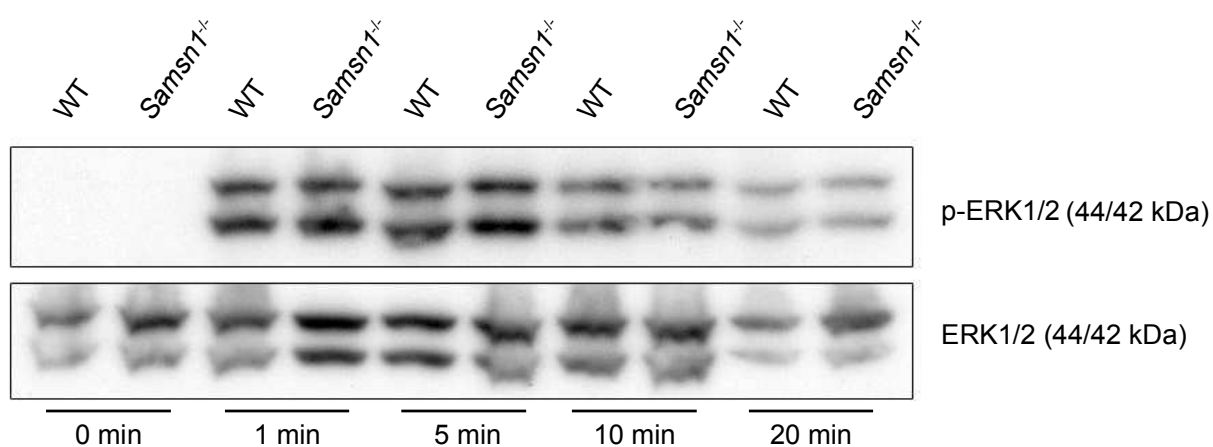

Figure 4-8 Normal ERK MAPK signaling in *Samsn1*^{-/-} mast cells.

Representative Western blot analysis of BMMCs from WT and *Samsn1*^{-/-} mice sensitized with anti-DNP IgE and stimulated with 25 ng/ml DNP-HSA antigen for different time points and stained for phosphorylated ERK1/2 and total ERK1/2 protein levels. No difference can be observed in the signaling of this pathway.

Consistent with the functional data, comparable phosphorylation of ERK in *Samsn1*^{-/-} and WT BMMCs indicates that SAMS1 is not essential in the initiation or modulation of the ERK-mediated MAPK pathway and may play a role at a different position in the activation cascade taking place after FcεRI stimulation or in a different mast cell function.

4.1.7 Migration of *Samsn1*^{-/-} BMDCs towards SCF is unaffected

Recent studies have provided evidence that SAMS1 is interacting with the actin nucleation-promoting factor cortactin and that SAMS1 might therefore regulate actin cytoskeletal reorganization (von Holleben et al., 2011). Lymphocytes express the hematopoietic cell-specific cortactin homologue HS1, which is phosphorylated upon mast cell activation via FcεRI stimulation in human cord blood mast cells (Suzuki et al., 1997). This could be an indication that in *Samsn1*^{-/-} mast cells the cytoskeletal dynamics might be impaired. Since directed cell migration leads to a polarization of the cytoskeleton and movement of the cell towards chemotactic stimuli, a potential function of SAMS1 in controlling migration was investigated.

To test the role of SAMS1 in cytoskeletal reorganization, migration of *Samsn1*^{-/-} BMDCs induced by SCF was analyzed. SCF binds to the receptor c-kit, a widely studied activating receptor on the mast cell surface. c-kit signaling is the most potent signal for regulation of mast cell proliferation and phenotype (Galli et al., 2005) and SCF also acts as a chemoattractant to mast cells (Nilsson et al., 1994).

For studying migration, WT and *Samsn1*^{-/-} BMDCs were cultured with only recombinant murine (rm)-IL-3 and without rm-SCF. These mast cells were then used in a transwell migration assay, where they were exposed to a gradient of different SCF concentrations. After 4 hours, the transwell inserts were removed from the wells and migrated cells in the lower chamber were counted. This was done using the flow cytometer and determining the number of cells taken up in 50 sec. To be able to verify the cell number added to the transwell at the beginning of the experiment, 10% of the cell suspension added to the transwell were seeded into medium without a transwell and counted in the same way as the migrated cells. This input control was done in triplicates and the total cell number added to the transwell was calculated from the mean of the input controls. Cells that migrated from the transwell to the well with medium and SCF were calculated as percentage of the input.

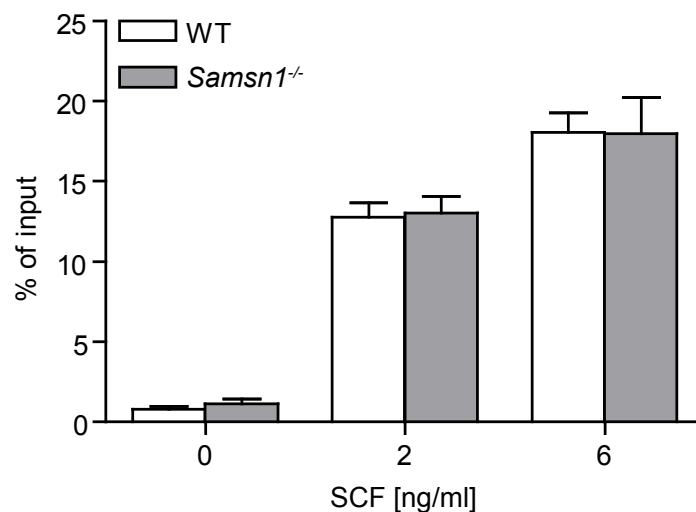

Figure 4-9 Comparable migration towards SCF between WT and *Samsn1*^{-/-} BMMCs.

BMMCs were seeded into transwell inserts in wells with medium plus 0, 2 or 6 ng/ml SCF. After 4h, the transwells were removed and the migrated cells were counted in the FACS. Results show data from 2 experiments with WT (n=4) and *Samsn1*^{-/-} (n=5) mast cell cultures.

Without SCF, only small numbers of cells migrated from the transwell to the bottom of the well. Upon addition of increasing concentrations of SCF, growing numbers of WT and *Samsn1*^{-/-} BMMCs migrated towards the stimulus in a dose-dependent manner. However, no difference in migration could be detected between WT and *Samsn1*^{-/-} BMMCs, suggesting that SAMS1 is not required for SCF-induced migration of BMMCs.

In conclusion, no functional phenotype could be revealed for *Samsn1*^{-/-} BMMCs in the parameters tested.

4.2 MicroRNA miR-155

MicroRNAs (miRNAs) are small, single-stranded RNAs that regulate mRNA translation via RNA interference. Lately miRNAs have been demonstrated to play a role in the maturation, proliferation, differentiation and activation of immune cells.

miR-155 has been shown to play an important role in the differentiation of T helper cells as well as in B cell maturation processes and the regulation of immune responses (Rodriguez et al., 2007; Thai et al., 2007). Up to now, no studies have been published on miR-155 expression or function in mast cells. Recent studies in macrophages revealed that miR-155 is regulating the expression of SH2-containing inositol phosphatase 1 (SHIP1) (O'Connell et al., 2009). SHIP1 is also known to be a regulator of mast cell degranulation (Gimborn et al.,

2005) and reduces the FcεRI-inducible levels of PIP₃ through its hydrolyzation, leading to less calcium influx and therefore decreasing mast cell granule release. Thus, miR-155 seems likely to be a regulator of mast cell function.

BMMCs were used as a model to investigate mast cell function in the presence or absence of miR-155. For this, mast cells were cultivated from WT C57BL/6 and *miR-155*^{-/-} mice for a period of 5 weeks with rm-IL-3 and rm-SCF.

4.2.1 *miR-155* expression in mast cells

So far only little is known about the expression of miRNAs in mast cells and a regulatory function has only been proposed for a small number of miRNAs in these cells. For example miR-221 and -222 have been shown to regulate proliferation in mast cells (Mayoral et al., 2009). Therefore, the interest was focused on miR-155 and its potential regulatory function on mast cell degranulation. First, *miR-155* expression during mast cell differentiation and activation was investigated. This was done using stem-loop real-time PCR, in which the miRNA is reverse transcribed using a stem-loop primer. The resulting product of the reverse transcription is measured with forward and reverse primers and a dye-labeled TaqMan probe using real-time PCR (Chen et al., 2005). Expression of *miR-155* was measured and normalized to the expression of the widely expressed small nucleolar RNA *snoRNA135* in each sample.

BMMCs expressed increasing levels of *miR-155* during their development from the stem cell stage (week 0) to functional mature mast cells (week 5) (Figure 4-10, A). In addition, the constitutive expression levels of *miR-155* were not affected by mast cell stimulation with DNP-specific IgE and DNP-HSA antigen (Figure 4-10, B). *miR-155* expression could not be detected in the *miR-155*^{-/-} BMMCs.

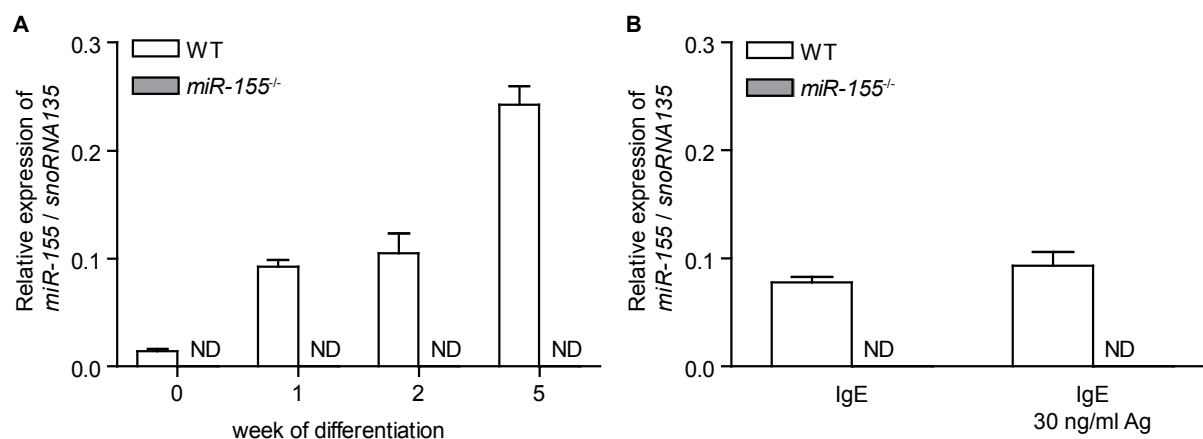

Figure 4-10 *miR-155* is expressed in BMMCs.

A – Bone marrow-derived mast cells from wild-type (WT) mice show an increase in *miR-155* expression during the development from stem cells to mature mast cells, whereas *miR-155*^{-/-} mast cells show no *miR-155* expression. WT n=4, *miR-155*^{-/-} n=2. **B** – *miR-155* expression is not upregulated after stimulation with anti-DNP IgE and 30 ng/ml DNP-HSA antigen (Ag) n=5. Results show expression of *miR-155* relative to mature miRNA control *snoRNA135* expression. ND – not detectable.

As it could be shown that *miR-155* is expressed in murine BMMCs, these cells can be used as an experimental model to investigate the function of this specific miRNA.

4.2.2 *miR-155*^{-/-} BMMCs show normal development

To investigate whether mast cells generated from WT and *miR-155*^{-/-} mice develop normally, different parameters like proliferation, morphology and surface marker expression were tested.

First, proliferation of WT and *miR-155*^{-/-} BMMCs was assessed. For this, cells were seeded out in a defined concentration and counted weekly. The fold proliferation from one week to the next showed no relevant difference between the two mast cell cultures and demonstrated that both WT and *miR-155*^{-/-} BMMCs grew at a comparable rate (Figure 4-11).

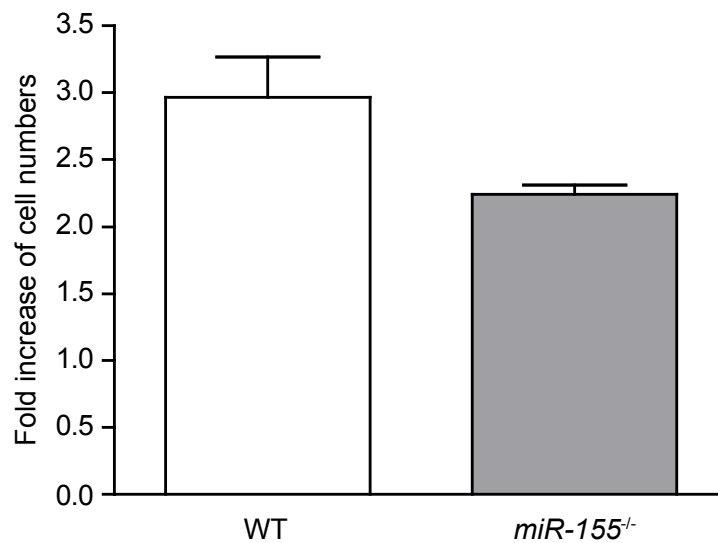

Figure 4-11 Fold proliferation of mast cells during 1 week of cultivation.

BMMCs were seeded out at a concentration of 2×10^6 cells/ml and cultured in mast cell medium with rm-IL-3 and rm-SCF. After one week of culture, the cells were counted and the fold increase of cells was calculated. Data show representative results obtained from 6 weeks old cells. WT n=2, *miR-155*^{-/-} n=4.

To evaluate the morphology of the two different mast cell cultures, cells were stained with Giemsa dye and examined under the microscope. Giemsa dye stains the cytoplasmic granules of the mast cells metachromatically and gives them a magenta color, whereas the nucleus shows a blue color (Damsgaard et al., 1997). There was no obvious difference in morphological structures like size and granularity between WT and *miR-155*^{-/-} BMMCs (Figure 4-12).

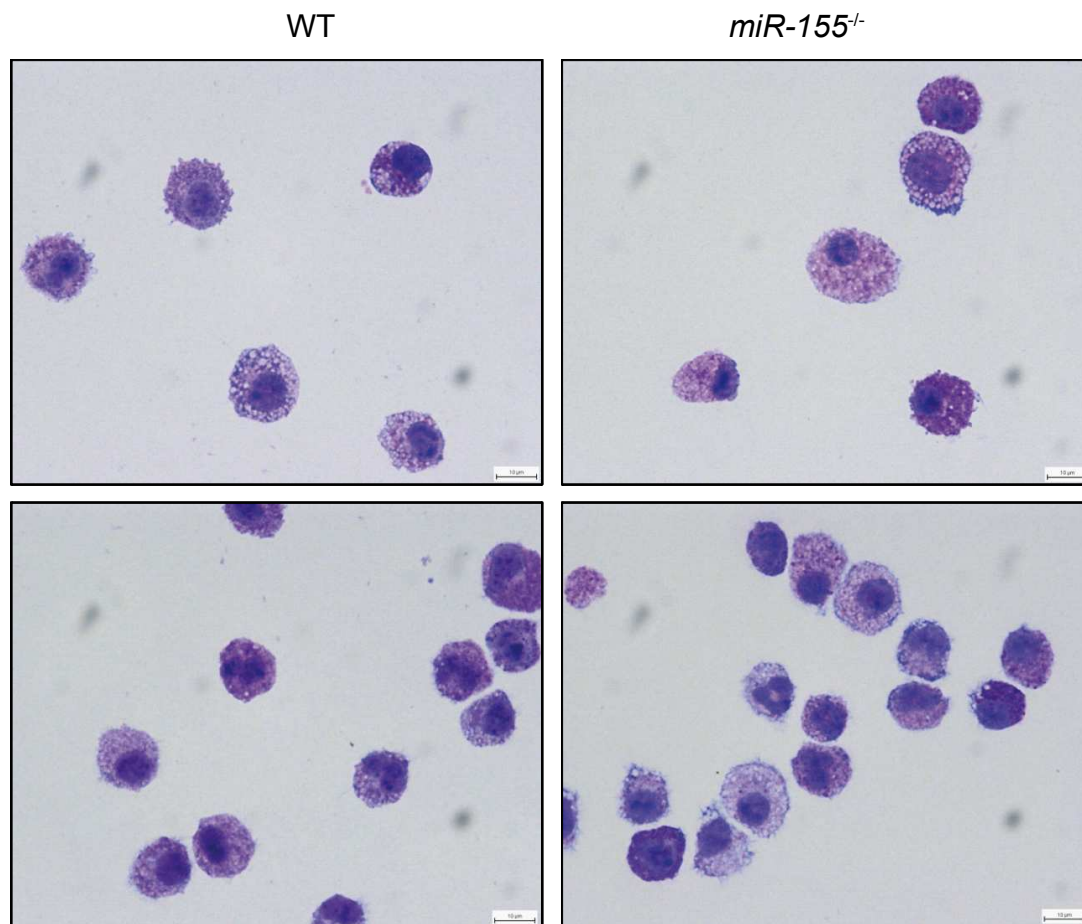

Figure 4-12 WT and *miR-155*^{-/-} BMMCs show comparable morphology.

Cytopins of two different WT and *miR-155*^{-/-} BMMC cultures stained with Giemsa dye. Bars represent 10 µm.

The purity of mast cell cultures was defined by testing specific mast cell marker expression on the surface of the cells. These surface markers include c-kit (CD117), FcεRI as well as T1/ST2 and were measured by flow cytometry (Figure 4-13). Cells were gated on typical size and granularity of mast cells in the forward- and side scatter (FCS/SSC). Figure 4-13 shows that *miR-155*-deficient as well as WT mast cells displayed a high expression of all three markers (heavy line) compared to the matching isotype controls (shaded histograms). It was also clear that *miR-155*^{-/-} mast cells show a comparable mast cell-specific marker expression than WT mast cells.

Therefore, the data suggest that differentiation of BMMCs is unaffected by the absence of miR-155.

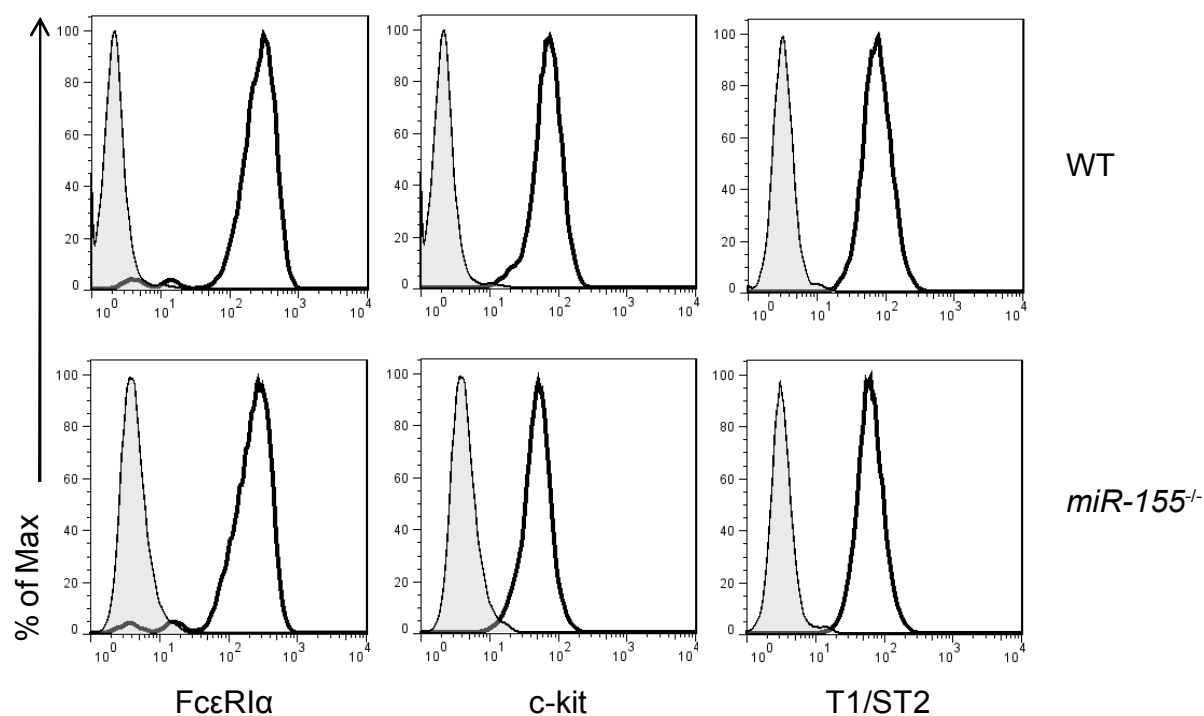

Figure 4-13 *miR-155*^{-/-} BMMCs show normal mast cell marker expression.

Representative FACS staining of mast cell-specific surface markers FcεRIα (left), c-kit (middle) and T1/ST2 (right) of bone marrow-derived mast cells from WT (upper panel) and *miR-155*^{-/-} mice (lower panel). Heavy lines show staining with specific antibody, filled histograms depict matching isotype controls.

Mast cells hold high numbers of granula in their cytoplasm, which in turn contain large amounts of prestored mediators, like histamine, proteoglycans and proteases as depicted in Table 1-1 (Metcalf et al., 1997). The composition of mast cell proteases (MCPs) varies between different tissue-specific mast cell types and can also change due to tissue or cytokine milieu (Bischoff, 2007) Therefore the content of selected mast cell protease mRNA in WT and *miR-155*^{-/-} BMMCs was assessed using reverse transcriptase PCR. Measured were MCP-1, -2, -5 and -9 as well as β-Actin as loading control.

For all tested mast cell proteases, mRNA expression was detectable. However, none of the MCPs displayed a difference in mRNA expression between WT and *miR-155*^{-/-} BMMCs. mRNA expression of β-Actin showed that comparable amounts of cDNA were used for the PCR (Figure 4-14).

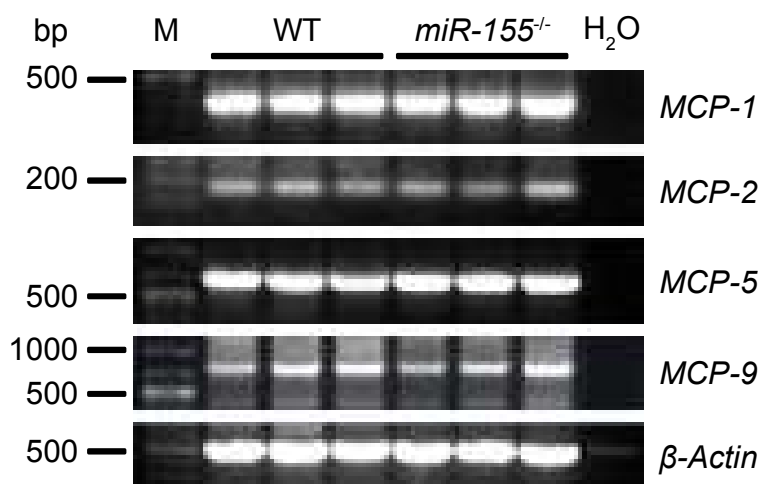

Figure 4-14 Comparable mast cell protease content in WT and *miR-155*^{-/-} BMMCs.

RNA of unstimulated BMMCs from 3 WT and 3 *miR-155*^{-/-} mice was isolated, cDNA synthesized and reverse transcriptase PCR performed. All mast cell proteases (MCPs) are expressed at the mRNA level in WT and *miR-155*^{-/-} mast cells and no difference between WT and *miR-155*^{-/-} mast cells could be detected. β -Actin mRNA expression serves as loading control. bp – base pairs; M – marker.

To verify that the activity of prestored proteases contained in the granula of mast cells is comparable between WT and *miR-155*-deficient mast cells, total protease activity was measured by degradation of fluorescent casein. As seen in Figure 4-15, the activity of mast cell proteases is comparable between BMMCs deficient for *miR-155* and WT BMMCs.

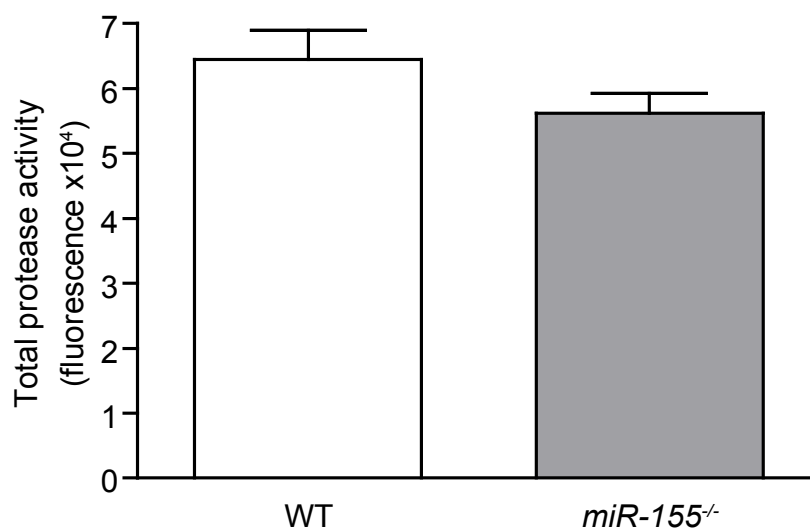

Figure 4-15 Comparable protease activity in WT and *miR-155*^{-/-} mast cells.

WT and *miR-155*^{-/-} BMMCs show similar protease activity (n=5). Fluorescence was measured after degradation of fluorescent casein in total cell lysates for a period of 36h.

Conclusively, BMMCs deficient for *miR-155* did not show any difference in proliferation, morphology, mast cell-specific marker expression or protease content and activity compared to WT BMMCs. Thus, *miR-155* does not affect mast cell differentiation and survival and therefore *miR-155*^{-/-} BMMCs are a suitable model to study the function of this miRNA in the regulation of mast cell activities.

4.2.3 *miR-155*^{-/-} mast cells show enhanced FcεRI-mediated degranulation

Among the most important functions of mast cells is their ability to degranulate upon FcεRI stimulation and the consequential release of preformed mediators like histamine, heparin and *de novo* synthesis of cytokines, chemokines and lipid mediators.

To assess the ability of mast cells to degranulate, different assays are used. The gold standard is the measurement of β-hexosaminidase release, a preformed mast cell granule component. In addition to that, mast cell degranulation can be assessed by LAMP1 surface expression on mast cells.

The release of β-hexosaminidase from mast cell granules was measured in mast cell supernatants after sensitization of cells with IgE and stimulation with specific antigen as well as with PMA and ionomycin. Stimulation with PMA and the ionophore ionomycin led to an FcεRI-independent degranulation and serves as a positive control for mast cell degranulation. This results from the activation of PKC by PMA and the mobilization of free calcium by ionomycin. The amount of β-hexosaminidase is calculated as the percentage of total β-hexosaminidase in the mast cell's supernatants divided by the sum of β-hexosaminidase in cell lysates and supernatant (Orinska et al., 2005). Figure 4-16 shows only a low level of β-hexosaminidase release in IgE-sensitized cells. Upon stimulation with 5 and 20 ng/ml antigen, a significant increase in β-hexosaminidase release in *miR-155*^{-/-} BMMCs compared to WT BMMCs was detectable. Stimulation of cells with PMA and ionomycin (Iono) did not lead to a significant difference in the release of β-hexosaminidase. This demonstrates that mast cells deficient for *miR-155* display an increased response upon FcεRI stimulation with antigen.

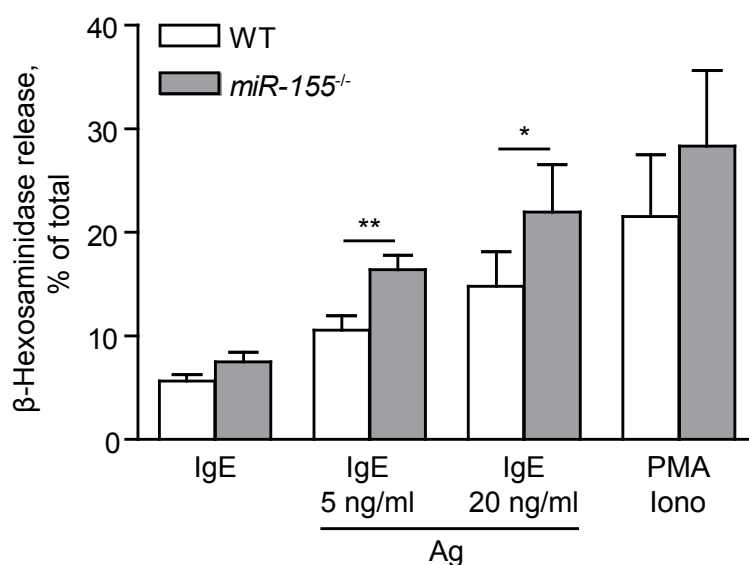

Figure 4-16 Increased β -hexosaminidase release in *miR-155*^{-/-} compared to WT BMMCs.

Bone marrow-derived mast cells were sensitized with anti-DNP IgE over night and stimulated for 10 minutes with 5 and 20 ng/ml DNP-HSA antigen (Ag), PMA and ionomycin (Iono) or left unstimulated. Data show results from 3 experiments (IgE n=13, 5 ng/ml n=10, 20 ng/ml n=13, PMA-Iono n=13), *p<0.05, **p<0.005.

To confirm the hyperdegranulation of *miR-155*^{-/-} BMMCs, LAMP1 protein expression on the surface of mast cells was measured. LAMP1, lysosomal associated membrane protein 1, localizes in mast cell granules and is released together with the granule's content upon degranulation of the mast cell (Raposo et al., 1997). Thus, LAMP1 can be detected via flow cytometry on the surface of degranulated mast cells.

A representative experiment of LAMP1 expression (Figure 4-17, A) in WT and *miR-155*^{-/-} BMMCs showed only little degranulation in WT BMMCs after sensitization with IgE. Upon stimulation with antigen, a dose-dependent increase of LAMP1 surface expression and therefore degranulation was observed (top panel). In *miR-155*^{-/-} BMMCs, this dose-dependency can be appreciated as well, the level of degranulation however was significantly higher compared to the one observed in WT BMMCs (bottom panel). No significant difference was detected in BMMCs stimulated with PMA and ionomycin (Iono), which served as positive control for degranulation.

This representative result was confirmed by repetition of experiments. Summarized data from different degranulation experiments are shown in Figure 4-17, B. Using the percentages of LAMP1 positive cells from the obtained FACS data, I could show that there was indeed a significant increase in LAMP1 expression and therefore an increase in degranulation in *miR-155*^{-/-} BMMCs upon stimulation with IgE and 20 ng/ml antigen compared to WT

BMMCs. This difference was not detectable by using PMA and ionomycin as stimulus. Therefore, the absence of miR-155 in BMMCs leads to an increase of FcεRI-specific degranulation.

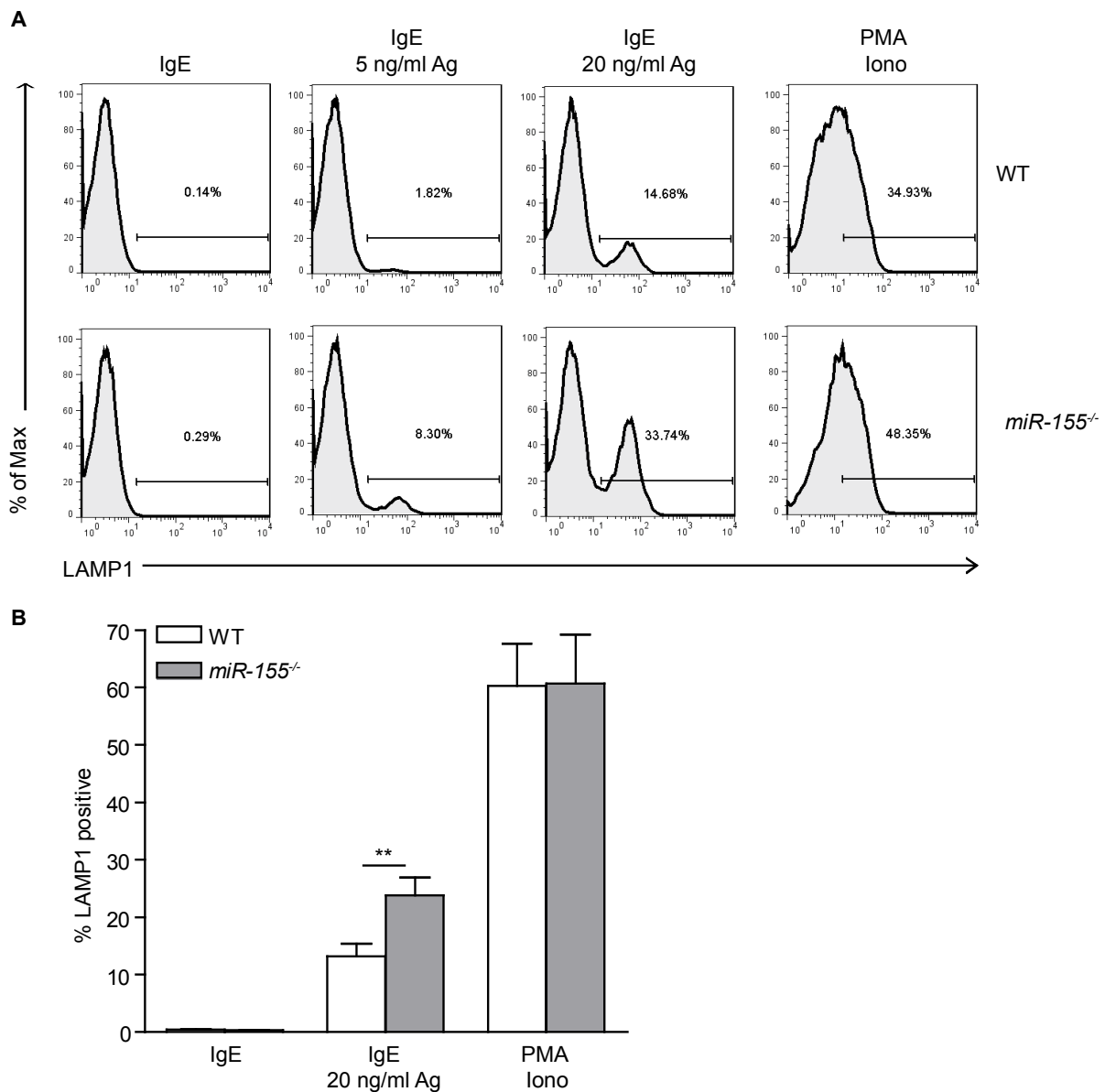

Figure 4-17 Increased LAMP1 expression in *miR-155*^{-/-} compared to WT BMMCs.

Bone marrow-derived mast cells were sensitized with anti-DNP IgE over night followed by stimulation with DNP-HSA antigen (Ag) or PMA and ionomycin (Iono) for 10 min. **A** – Representative experiment of LAMP1 surface expression measured by FACS. *miR-155*^{-/-} BMMCs (bottom panel) show higher LAMP1 expression when stimulated with anti-DNP-IgE and 5 or 20 ng/ml DNP-HSA antigen (Ag) compared to WT mast cells (top panel). **B** – *miR-155*^{-/-} BMMCs display a significant increase in LAMP1 surface expression compared to WT mast cells. Data show results from 3 experiments with WT n=13 and *miR-155*^{-/-} n=12. **p<0.005.

Taken together, these results demonstrate a hyperdegranulation in BMMCs deficient for *miR-155* and suggest that miR-155 functions as a negative regulator for FcεRI-mediated mast cell activation and degranulation.

4.2.4 Increased cytokine release by *miR-155*^{-/-} BMMCs upon FcεRI-stimulation

Upon cross-linking of FcεRI with IgE and specific antigen, mast cells degranulate and release – among others – cytokines from their cytoplasmic granules. Additionally, stimulated mast cells newly synthesize cytokines. These cytokines can be measured in the supernatant of stimulated cells by ELISA.

For this, both BMMCs from WT and *miR-155*^{-/-} mice were stimulated with anti-DNP IgE followed by stimulation with different concentrations of DNP-HSA antigen or stimulation with PMA and ionomycin. ELISAs were performed for the key mast cell cytokines TNF-α and IL-6.

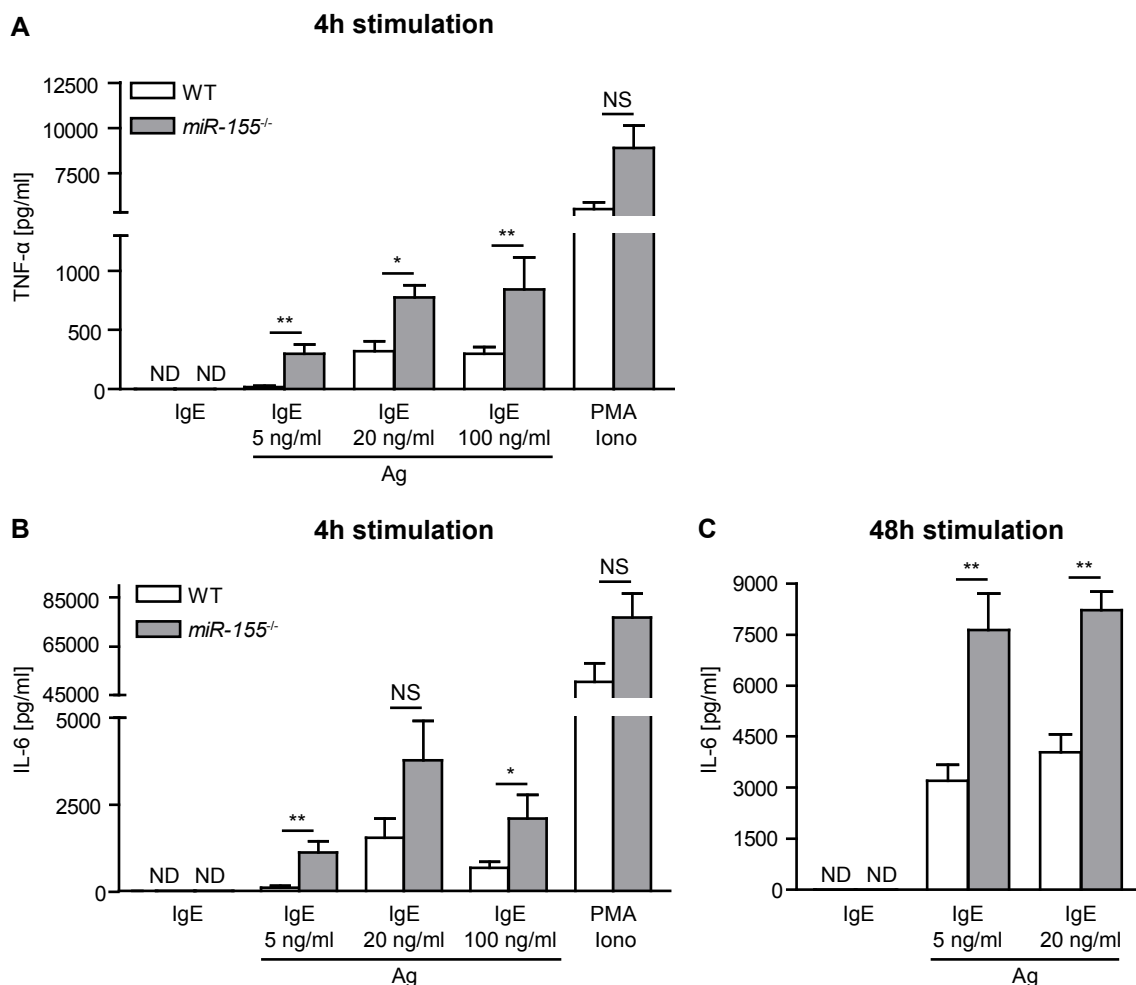

Figure 4-18 Increased cytokine release in *miR-155*^{-/-} BMMCs.

BMMCs from WT and *miR-155*^{-/-} mice were sensitized with anti-DNP IgE over night followed by stimulation with or without DNP-HSA antigen (Ag) or with PMA and ionomycin (Iono) for 4h (A, B) or 48h (C). BMMCs from *miR-155*^{-/-} mice show an increase in TNF- α (A) and IL-6 (B) release 4h after stimulation with different concentrations of antigen. IL-6 is also significantly increased after 48h of stimulation. Data show results from one experiment each with BMMCs from 5 WT and 5 *miR-155*^{-/-} mice. * $p < 0.05$, ** $p < 0.005$, NS – not significant, ND – not detectable.

Figure 4-18 showed that BMMCs secrete increasing amounts of both TNF- α as well as IL-6 after 4 hours of stimulation with IgE and growing amounts of specific antigen. It was also evident that BMMCs deficient for *miR-155* release significantly higher amounts of TNF- α (A) as well as IL-6 (B) than WT BMMCs. After 48 hours of stimulation, the total amount of IL-6 detected in the supernatant of *miR-155*^{-/-} BMMCs was clearly significantly higher than in WT cells (Figure 4-18, C). The increasing difference in IL-6 concentrations after 48h can be explained by both accumulation and stability of this cytokine.

From this I conclude that *miR-155* plays a role in regulating the Fc ϵ RI-mediated mast cell degranulation and cytokine release.

4.2.5 Expression of potential miR-155 targets in BMMCs

The mechanism by which miRNAs function is called RNA interference. This process includes the binding of miRNA to the target mRNA, which then leads to degradation or transcriptional repression of the target mRNA (Montgomery et al., 1998). Thus, to find the target mRNA to a miRNA is one of the major goals in miRNA research.

To get a first impression of possible targets of miR-155, two microarray experiments were performed. For the first array, unstimulated WT and *miR-155*^{-/-} BMMCs were used, the other one used BMMCs from WT and *miR-155*^{-/-} mice that were sensitized with IgE and stimulated with 20 ng/ml antigen. Each array contained mast cell RNA from three different WT and three different *miR-155*^{-/-} mice. Results are shown in a linear way. With this experiment, one is able to see differentially expressed genes in *miR-155*^{-/-} BMMCs in comparison to the WT cells.

The analysis for this microarray was done by M.Sc. Olivia Prazeres da Costa from the Expression Core Facility of the Institute for Medical Microbiology, Immunology and Hygiene at the Technical University Munich. None of the genes from unstimulated BMMCs were highly differentially expressed in the *miR-155*^{-/-} cells compared to WT cells (data not shown). In the IgE/antigen-stimulated cells, however, 18 genes displayed a differential expression, from which 7 showed a more than 4-fold higher expression in *miR-155*^{-/-} BMMCs in comparison to the WT mast cells (Table 4-1). Only one gene was found to be slightly downregulated (data not shown).

Table 4-1 Differential gene expression in BMMCs after stimulation with IgE and antigen.

BMMCs from WT and *miR-155*^{-/-} mice were sensitized with anti-DNP IgE and stimulated with 20 ng/ml DNP-HSA antigen. Linear expression of the mean of 3 WT and 3 *miR-155*^{-/-} mast cell cultures was calculated. Fold expression is shown as the mean expression of *miR-155*^{-/-} divided by the mean expression of WT mast cells and is displayed only for upregulation of more than 4-fold.

Gene Symbol	Gene Title	Fold Expression <i>miR-155</i> ^{-/-} / WT
<i>Tnip3</i>	TNFAIP3 interacting protein 3	17,2374842
<i>Serpinb9b</i>	Serine (or cysteine) peptidase inhibitor, clade B, member 9b	6,9263821
<i>Ccl1</i>	Chemokine (C-C motif) ligand 1	5,6449392
<i>Pik3r6</i>	Phosphoinositide 3-kinase, regulatory subunit 6	5,2373524
<i>Ccl9</i>	Chemokine (C-C motif) ligand 9	5,1612249
<i>Gda</i>	Guanine deaminase	4,4920629
<i>Pik3r5</i>	Phosphoinositide 3-kinase, regulatory subunit 5, p101	4,2879164

TNIP3 (ABIN-3), which shows the highest differential expression in *miR-155*^{-/-} BMMCs compared to WT BMMCs, is known to bind the ubiquitin-editing nuclear factor-kappaB (NF-κB) inhibitor protein A20 and its expression is NF-κB dependent (Verstrepen et al., 2009). Expression of TNIP3 has been shown in both human and mouse monocytes/macrophages and is induced after stimulation with IL-10 and LPS (Weaver et al., 2007). Functionally, TNIP3 has been described to negatively regulate NF-κB-mediated responses to TNF-α, TLRs and NOD2 signaling. *Tnip3*-deficient mice show multi-organ inflammation (Elsby et al., 2010).

Serine (or cysteine) peptidase inhibitor, clade B, member 9b (*Serpinc9b*), also known as SPI-CI, has been shown to be expressed in cytotoxic T cells, NK-like cells and at immune-privileged sites like placenta, testis and brain. It has been demonstrated to inhibit the function of granzyme M (Bots et al., 2005).

The chemokine CCL1, also known as I-309, binds to the chemokine receptor CCR8 and is secreted by activated monocytes/macrophages and T cells (Miller et al., 1990). CCR8 has been implicated in the recruitment of T helper type 2 cells, suggesting a role for this receptor and its ligand in allergic responses (Romagnani, 2002).

Two genes, namely *Pik3r5* (*p101*) and *Pikr6* (*p84*, *p87*^{PIKAP}), were upregulated in *miR-155*^{-/-} BMMCs and both code for proteins which act as regulatory subunits for the phosphoinositide 3-kinase gamma (PI3Kgamma) (Stephens et al., 1997; Suire et al., 2005). This suggests that miR-155 is involved either directly or indirectly in the regulation of the PI3Kgamma pathway.

To verify the results obtained in the microarray, real-time PCR was performed for the most important candidate genes found in the microarray analysis. For this the precise method of using TaqMan Probes by Roche in combination with gene-specific primers was applied.

The gene that showed the highest differential expression in the microarray analysis was *Tnip3*. This gene could not be detected in the real-time PCR in unstimulated or stimulated BMMCs.

The results of the real-time PCR analysis shown in Figure 4-19 largely confirm the results obtained in the microarray. It could be verified that the mRNA expression of PI3Kgamma subunits *Pik3r5* (Figure 4-19, A) and *Pik3r6* (Figure 4-19, B) were significantly upregulated in *miR-155*^{-/-} BMMCs compared to WT BMMCs on a constitutive level as well as after stimulation with IgE and antigen. The mRNA of the chemokine *Ccl1* was hardly expressed in unstimulated BMMCs, but highly induced after stimulation with IgE and antigen and

expression was significantly higher in *miR-155*^{-/-} BMMCs in comparison to WT BMMCs (Figure 4-19, C). The same is true for the *Serpinb9b*, which is not detectable in non-stimulated cells, but is highly induced in *miR-155*^{-/-} BMMCs after stimulation with IgE and antigen (Figure 4-19, D).

Since *Pik3r5* and *Pik3r6* are subunits of PI3Kgamma, expression of *Pi3kgamma* and the phosphatase and tensin homolog *Pten*, which acts as a negative regulator of PI3Kgamma signaling (Maehama and Dixon, 1998), was also determined via real-time PCR. Expression analysis of *Pi3kgamma* showed no difference in the unstimulated cells but a significant decrease in *Pi3kgamma* expression in IgE/antigen-stimulated *miR-155*^{-/-} BMMCs compared to WT BMMCs (Figure 4-19, E). *Pten* mRNA expression revealed no difference in resting BMMCs or BMMCs stimulated with antigen (Figure 4-19, F).

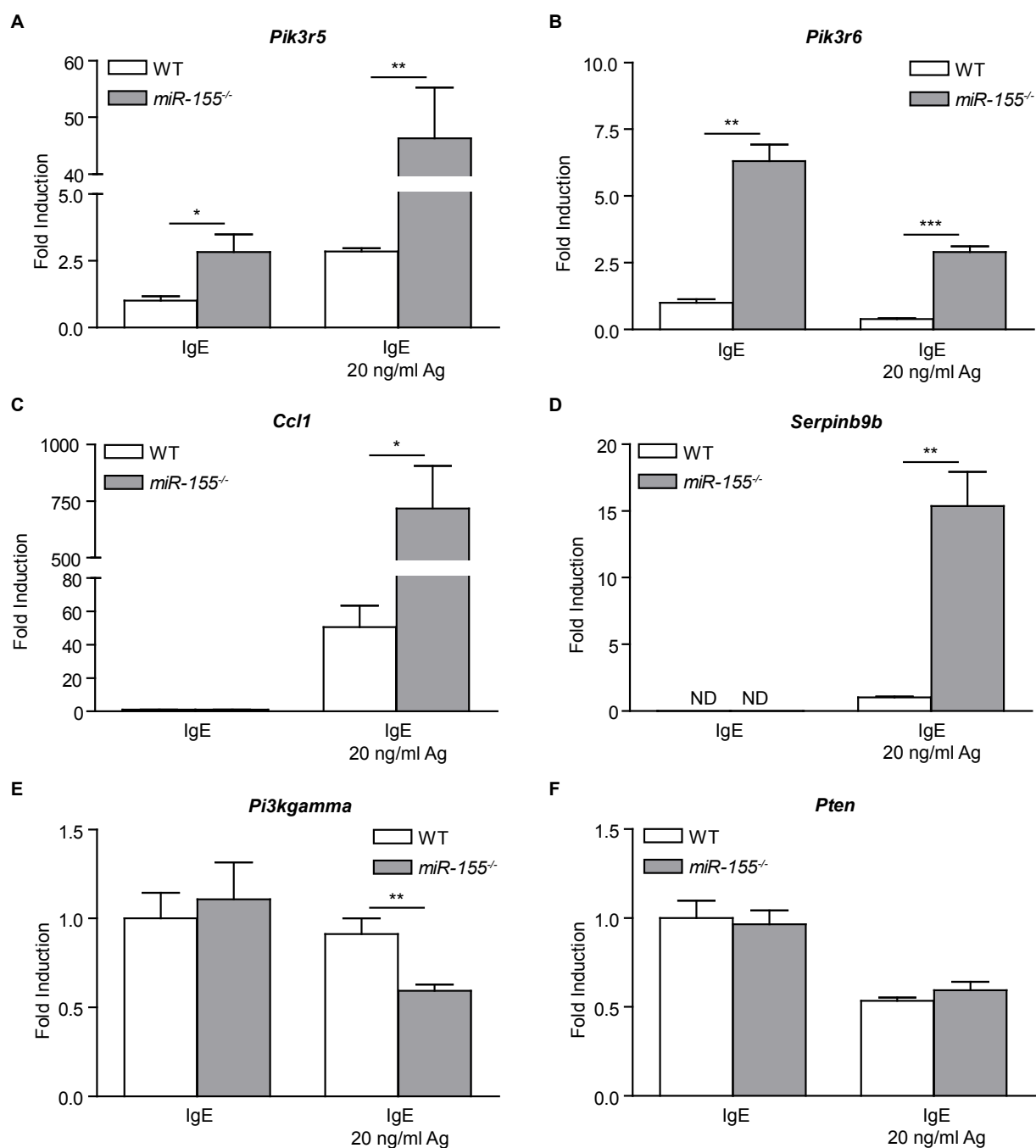

Figure 4-19 mRNA expression of potential miR-155 targets.

IgE-sensitized BMMCs from WT and *miR-155*^{-/-} mice were either left untreated (IgE) or stimulated with 20 ng/ml antigen (Ag). RNA was isolated and cDNA prepared. Real-time PCR analysis confirmed results of the microarray analysis. The enhanced expression of *Pik3r5* (A, n=5) and *Pik3r6* (B, n=3) in unstimulated as well as stimulated *miR-155*^{-/-} BMMCs and the increase in *Ccl1* (C, n=3) and *Serpinb9b* (D, n=3) in stimulated cells could be verified. Analysis of *Pi3kgamma* (E, n=5) only shows a difference when cells are stimulated with antigen, whereas *Pten* expression (F, n=5) revealed no significant differences in expression between WT and *miR-155*^{-/-} BMMCs in unstimulated and stimulated conditions. Fold induction is calculated by setting the mean value of IgE-sensitized WT BMMCs to 1. Analysis was performed using Student's t-test, *p<0.05, **p<0.005, ***p<0.0005. ND – not detectable.

Ship1 and *Socs1* have been described to be targets of miR-155 in macrophages (O'Connell et al., 2009) and in regulatory T cells (Lu et al., 2009), respectively. Therefore, these genes were also tested as potential targets in *miR-155*^{-/-} BMMCs. Microarray analysis revealed no significant changes in the expression of *Socs1* or *Ship1* in *miR-155*^{-/-} compared to WT BMMCs (data not shown) and also real-time PCR data could not detect any significant differences in the gene expression of *Ship1* and *Socs1* from WT to *miR-155*^{-/-} (Figure 4-20).

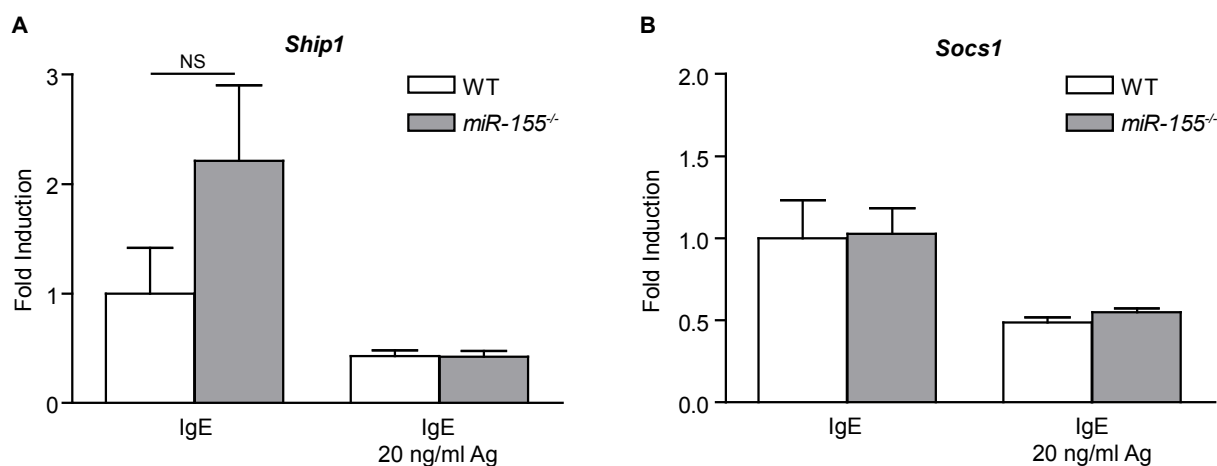

Figure 4-20 *Ship1* and *Socs1* mRNA expression is unaffected in *miR-155*^{-/-} BMMCs.

Real-time PCR data of IgE-sensitized and untreated (IgE) or antigen-treated BMMCs from WT and *miR-155*^{-/-} mice. **A** – *Ship1* mRNA expression is not modulated by miR-155 in unstimulated or stimulated BMMCs. IgE n=10, IgE + 20 ng/ml Ag n=5. **B** – mRNA expression of *Socs1* does not differ in BMMCs from WT or *miR-155*^{-/-} mice. WT n=5, *miR-155*^{-/-} n=4. Fold induction is calculated by setting the mean value of IgE-sensitized WT BMMCs to 1. NS – not significant.

To confirm *Socs1* and *Ship1* gene expression at the protein level, Western blot analysis was performed. SOCS1 protein could not be detected in murine mast cells (data not shown). Detection of SHIP1 protein showed no difference in the amount of SHIP1 in WT compared to *miR-155*^{-/-} BMMCs. As a loading control, ACTIN protein was blotted (Figure 4-21, A). To verify this result, the ratio of SHIP1 protein expression relative to ACTIN protein levels was calculated by using the ImageJ software for densitometric analysis. This confirmed the comparable protein level of SHIP1 in both WT and *miR-155*^{-/-} BMMCs (Figure 4-21, B).

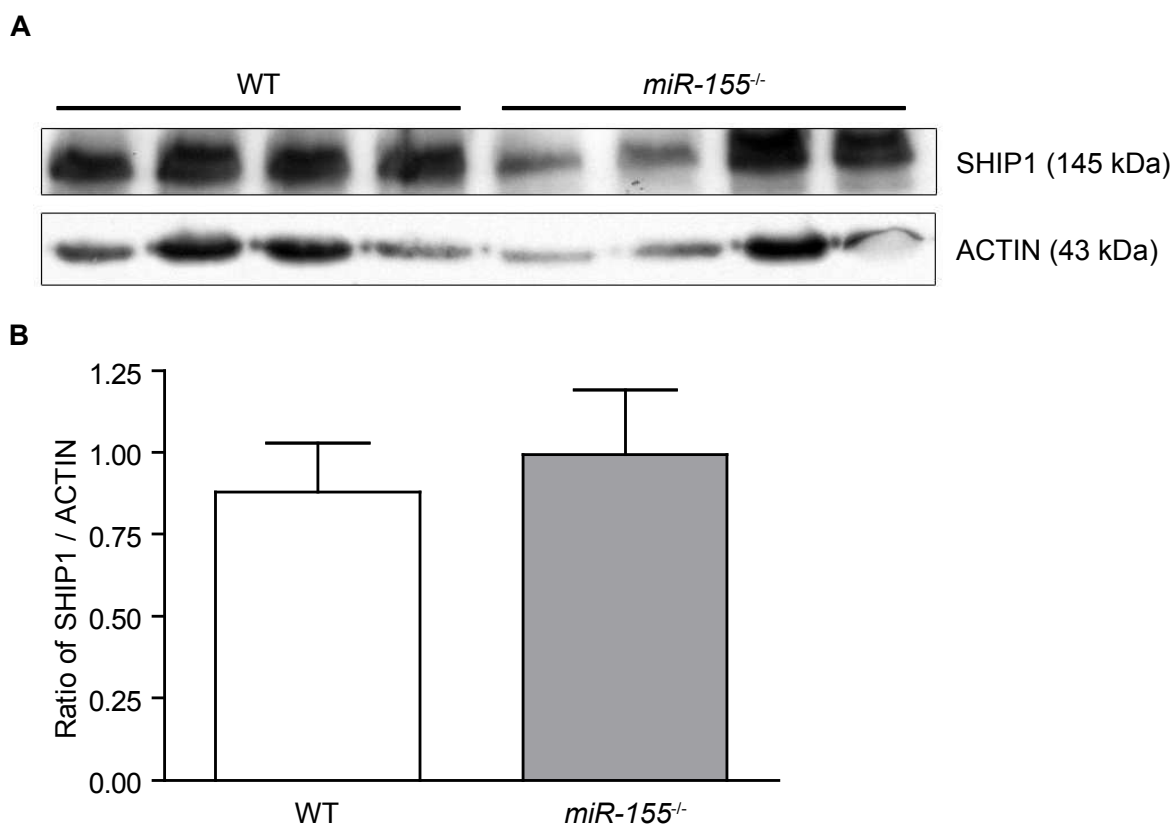

Figure 4-21 No difference in SHIP1 protein levels were detected in *miR-155*^{-/-} compared to WT BMMCs.

A –Western blot analysis of unstimulated WT and *miR-155*^{-/-} BMMCs tested for SHIP1 protein (145 kDa) and ACTIN protein (43 kDa) as loading control revealed no differences in protein levels in WT compared to *miR-155*^{-/-} BMMCs. **B** – Densitometry of SHIP1 protein levels relative to ACTIN protein expression revealed no difference between WT and *miR-155*^{-/-} BMMCs.

In summary, the comparable mRNA and protein expression of both SOCS1 and SHIP1 in WT and *miR-155*^{-/-} BMMCs led to the conclusion that the expression of these molecules in mast cells is not dependent on miR-155 regulation at least in resting cells or under specific FcεRI-mediated stimulation.

Because SHIP1 and SOCS1 protein levels are comparable between WT and *miR-155*^{-/-} BMMCs and hence appear not to be targeted by miR-155, these proteins seem not to be responsible for the increased FcεRI-mediated degranulation in these cells. Therefore, the focus was directed at the PI3Kgamma regulatory subunits PIK3R5 and PIK3R6, which were highly upregulated in *miR-155*-deficient mast cells.

Since no antibody is currently available to detect PIK3R6 protein levels, only PIK3R5 protein expression could be investigated by Western blotting. As shown in Figure 4-22, Western blot analysis detects more protein in three out of four *miR-155*^{-/-} BMMC cultures compared to the WT BMMC controls (Figure 4-22, A). To get more insight on the difference of PIK3R5

protein expression in *miR-155*^{-/-} BMMCs compared to WT BMMCs, densitometric analysis using the ImageJ software was performed. This software allows the normalization of protein expression of PIK3R5 to protein levels of ACTIN, which served as a loading control. This analysis confirmed higher PIK3R5 protein levels in *miR-155*^{-/-} mast cells (Figure 4-22, B).

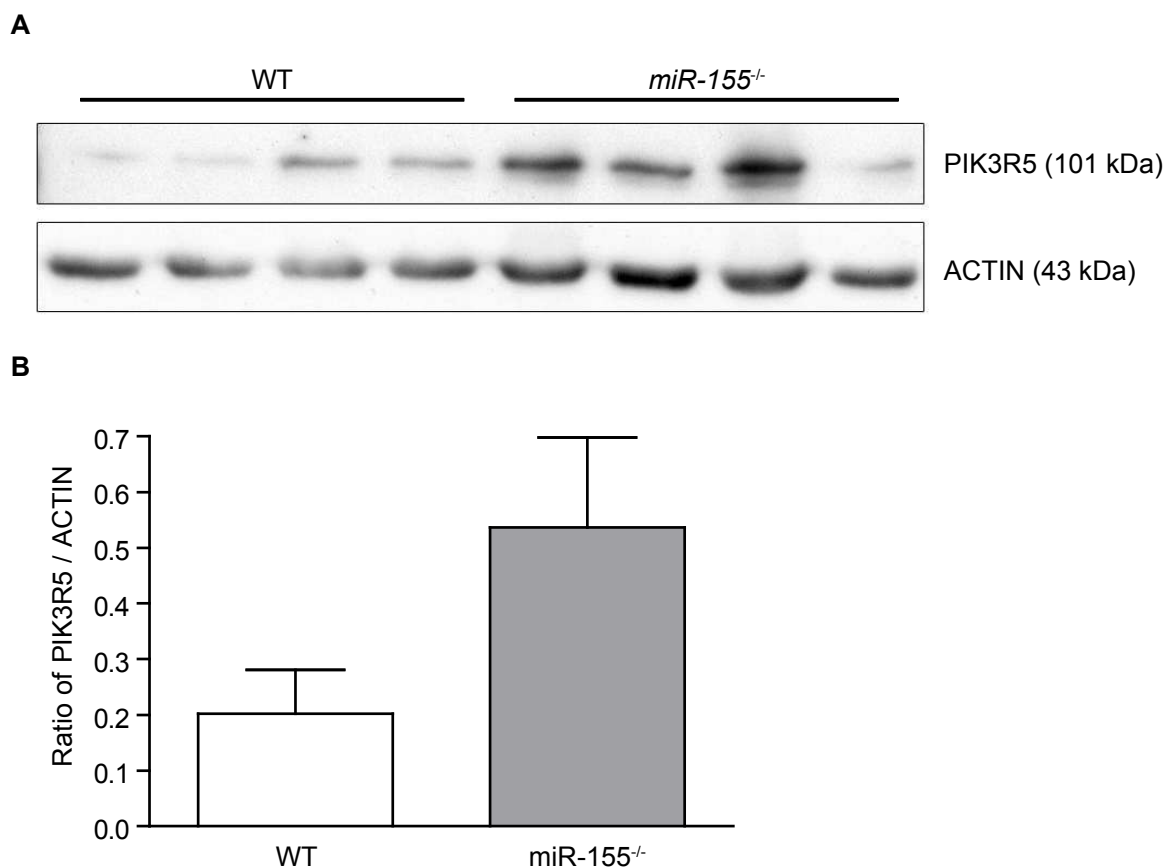

Figure 4-22 Increased protein expression of PIK3R5 in *miR-155*^{-/-} BMMCs.

A – Western blot analysis showing the PIK3R5 protein at a size of 101 kDa in WT and *miR-155*^{-/-} BMMCs (top panel) and the ACTIN protein as loading control (bottom panel). **B** – Ratio of PIK3R5 protein expression relative to ACTIN loading control. Results show data from Western blot (A).

4.2.6 Increased AKT phosphorylation in FcεRI-stimulated *miR-155*^{-/-} BMMCs

To further understand the way in which *miR-155* affects mast cell degranulation, signaling pathways that are activated after FcεRI engagement were investigated.

After stimulating IgE-sensitized mast cells with antigen for different times and analyzing cell lysates from these stimulated cells, the phosphorylation of different molecules that are active in different signaling pathways was investigated.

One of the best described signaling pathways involved in a range of different processes like growth, differentiation and development is the mitogen-activated protein kinase (MAPK) cascade. In mast cells, FcεRI-mediated MAPK activation leads to the release of arachidonic acid, which then forms leukotrienes and prostaglandins, and to the production of cytokines (Roth et al., 2008).

Another important signaling cascade described in mast cell degranulation is the PI3K pathway. Since two PI3Kγ subunits were shown to be upregulated in *miR-155*^{-/-} mast cells, this pathway was investigated more closely. An important molecule activated in the PI3Kγ cascade is AKT (also known as protein kinase B, PKB). AKT is activated after FcεRI engagement by binding to the lipid second messenger phosphatidylinositol 3,4,5-trisphosphate (PIP₃), which results in an increased cytokine production and cell survival (Alvarez-Errico et al., 2009; Roth et al., 2008). Using the pan-PI3K inhibitor wortmannin, it has been shown that FcεRI-mediated mast cell degranulation depends on the activation of both class IA and class IB PI3Ks (Barker et al., 1995; Yano et al., 1993). More precisely it was described that PI3Kγ is not activated in a direct manner by FcεRI engagement, but acts in a secondary autocrine and paracrine activation loop, which leads to an enhancement of mast cells activation (Laffargue et al., 2002; Rommel et al., 2007).

To test if one of these pathways is involved in the increase of degranulation in *miR-155*^{-/-} mast cells, Western blot analysis was performed with lysates of WT and *miR-155*^{-/-} mast cells, that were sensitized with anti-DNP IgE and stimulated with specific antigen. Figure 4-23 (two top panels) shows the phosphorylation of the MAPKs extracellular signal-regulated kinase ERK1 and -2 together with the total amount of ERK1/2, which served as a loading control (two top panels). In WT as well as in *miR-155*^{-/-} BMMCs, ERK phosphorylation was detectable already after stimulation with antigen for 1 minute, was maintained at the same level after 5 min of stimulation, and then decreased. After 20 min of stimulation, ERK phosphorylation was barely visible anymore. Importantly, there was no difference in the level of phosphorylation between WT and *miR-155*-deficient BMMCs.

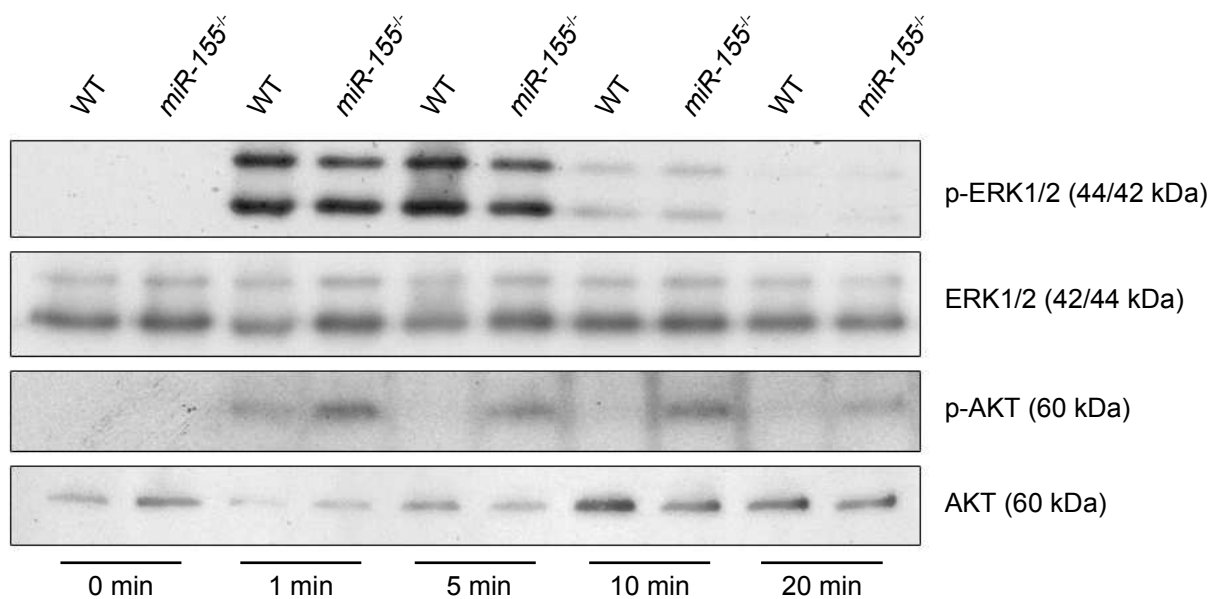

Figure 4-23 Increase in AKT, but not in ERK phosphorylation in *miR-155*^{-/-} BMMCs.

Immunoblot of bone marrow-derived mast cells from anti-DNP IgE-sensitized WT and *miR-155*^{-/-} mice stimulated with 25 ng/ml DNP-HSA antigen for different times indicated and stained for phosphorylated ERK1/2 (p-ERK1/2), total ERK2, phosphorylated AKT (p-AKT) and total AKT. No difference was detected for p-ERK1/2. Phosphorylation of AKT is upregulated in BMMCs deficient for *miR-155* compared to WT BMMCs.

Phosphorylation of AKT was also tested by Western blot and total AKT was used as a loading control (Figure 4-23, two bottom panels). Upon 1 min of stimulation with antigen, phosphorylation of AKT can be easily appreciated. However, in *miR-155*^{-/-} mast cells, the level of phosphorylation, readable as intensity of the detected bands, was much stronger than in WT BMMCs. After 5 min of stimulation, the phosphorylation of AKT in WT mast cells decreased already and remained at a low level until 20 min of stimulation, whereas in the *miR-155*^{-/-} mast cells the phosphorylation stayed relatively stable throughout the 10 min stimulation and only decreased slightly after 20 min of stimulation.

To quantify the differences, a densitometrical analysis of the data was performed. With this analysis, the density of the detected bands from the phosphorylated antibody is normalized to the density of bands from total protein. This analysis confirmed that there is no difference in the ERK phosphorylation between WT and *miR-155*^{-/-} mast cells (Figure 4-24, A). For the AKT phosphorylation instead a significant increase could be detected in the *miR-155*^{-/-} BMMCs compared to WT mast cells (Figure 4-24, B).

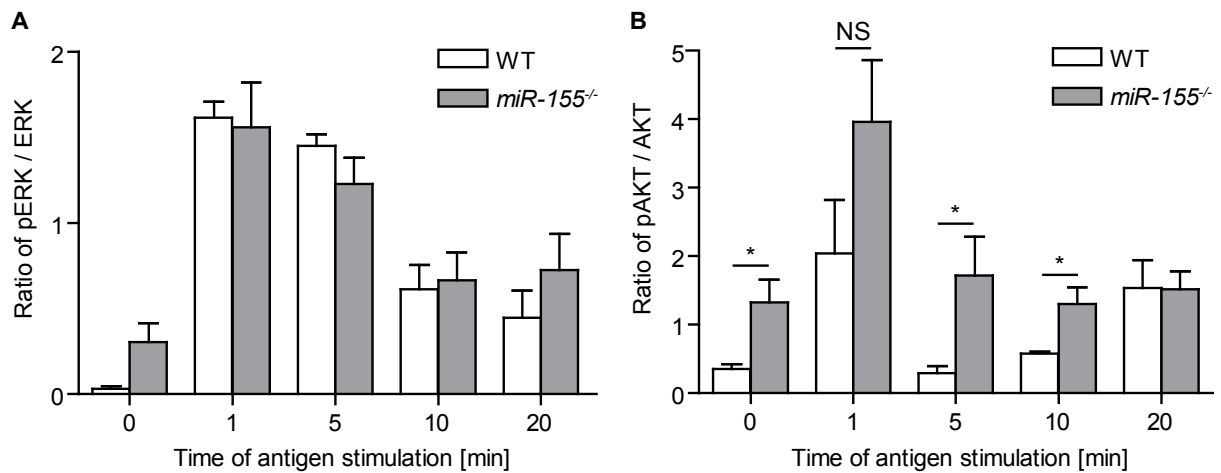

Figure 4-24 Increased AKT phosphorylation in *miR-155*^{-/-} compared to WT BMMCs.

Densitometric analysis of ERK1/2 phosphorylation relative to total Erk1/2 (A) and AKT phosphorylation relative to total AKT (B) of data obtained from Western blots. Results show data from two different experiments (n=4), including Figure 4-23. *p<0.05. NS – not significant.

Together, these results lead to the conclusion that MAPK activation does not account for the higher degranulation in *miR-155*^{-/-} mast cells. Instead, these results strongly suggest that the PI3Kgamma pathway is a target of miR-155 and becomes dysregulated in its absence.

5 Discussion

Activation of mast cells via the FcεRI is essential for the innate immune system to react against antigens as well as pathogens and presents a first line of defense. Recently it has been shown that the activation of mast cells is also important for the initiation and regulation of the adaptive immune responses (Stelekati et al., 2007). A reaction of mast cells against otherwise harmless antigens or a dysregulation of mast cell activation leads to severe conditions like allergic asthma and autoimmune diseases such as rheumatoid arthritis and multiple sclerosis (Christy and Brown, 2007; Prussin and Metcalfe, 2003).

The activation of mast cells by cross-linking the FcεRI with IgE and antigen is a complex process involving various steps which in the end lead to the degranulation of the cell and the release of prestored and newly synthesized mediators (Metz and Maurer, 2007). These mediators arbitrate versatile reactions including the regulation of immune responses as well as recruitment of effector cells (Marshall, 2004). Since the activation of mast cells contributes to long-lasting and fundamental changes in the immune system, the regulation of mast cell activation has to be tightly controlled. This control can occur on several levels. In this study, I focused on two of these possible regulation mechanisms at the signaling and at the gene transcriptional/translational level, which include the role of the adaptor protein SAMS1 and the microRNA miR-155 in murine FcεRI-mediated bone marrow-derived mast cell (BMMC) degranulation.

5.1 Role of adaptor protein SAMS1

Many different adaptor proteins involved in mast cell signaling have been described so far. These adaptors function as linkers between proteins which are active in the signaling cascade and bring them closer to their place of action. SAMS1 has been described to be an adaptor protein in human cord-blood mast cells and shows very high expression in murine mast cells (Lattin et al., 2008; Uchida et al., 2001). Functionally, SAMS1 acts in the negative regulation of B cell activation and differentiation (Zhu et al., 2004b), T cell responses (Wang et al., 2010) as well as in the regulation of the actin cytoskeleton (von Holleben et al., 2011). Yet no function has been described for SAMS1 in mast cells of any origin. Therefore the interest was raised to investigate the role of this protein in murine BMMC function.

In this study it was shown that BMMCs express *Samsn1* mRNA at high levels. The acquired data verified published microarray results about high levels of *Samsn1* mRNA expression in unstimulated and IgE/antigen-stimulated murine mast cells (Lattin et al., 2008). SLY1, which also belongs to the SLY protein family and which shows great homology to SAMS1, did not show a difference in mRNA expression between WT and *Samsn1*^{-/-} BMMCs. Even though *Samsn1* is highly expressed in BMMCs, *Samsn1*^{-/-} BMMCs develop and differentiate normally and it was demonstrated that this protein is not essential for proliferation, FcεRI-mediated degranulation, cytokine release and signaling as well as for stem cell factor (SCF)-induced migration.

Overexpression of SAMS1 in BMMCs did not show any difference in the degranulation upon IgE and antigen stimulation compared to WT BMMCs. This might be due to the fact that SAMS1 is already highly expressed in mast cells at the levels required for a potential regulatory function. Therefore, an overexpression of the protein might not lead to a difference in FcεRI-mediated degranulation.

In a knock-out approach, SAMS1 function was studied. Mice deficient for *Samsn1* are viable and fertile and mast cells generated from the bone marrow of these mice develop in a comparable way than WT mice. *Samsn1*^{-/-} BMMCs showed normal proliferation and typical BMMC-specific surface marker expression. Surprisingly, *Samsn1*^{-/-} BMMCs did not display any defects in FcεRI-mediated degranulation as well as in cytokine release. In addition, the ERK-mediated MAPK signaling pathway was activated in a comparable manner in *Samsn1*^{-/-} BMMCs and WT control cells. In contrast to these findings, other adaptor proteins like LAT1 and LAT2 were shown to regulate FcεRI-mediated degranulation, cytokine production and MAPK signaling in murine BMMCs in either a negative or a positive manner (Saitoh et al., 2000; Zhu et al., 2004a). This shows that adaptor proteins are generally important mediators in the positive as well as in the negative regulation of signaling and degranulation in murine mast cells. However, a negative regulatory function described for SAMS1 in other cell types like B and T cells, could not be shown in murine BMMCs. Since other members of the SLY protein family, especially SLY1, show great sequence homology to SAMS1 (SLY2), they might exert a compensatory effect on the deficiency of SAMS1. This is supported by reports showing the expression of SLY1 in hematopoietic cells like macrophages, dendritic cells, B and T cells as well as in resting and antigen-stimulated mast cells (data from <http://biogps.gnf.org>) (Lattin et al., 2008). Data showing that *Sly1* mRNA is expressed at

comparable levels as *Samsn1* mRNA in BMMCs does not contradict this hypothesis, because protein levels of SLY1 might still be upregulated in mast cells deficient for *Samsn1* and take over its function, therefore compensating a deficiency for SAMSN1.

SAMSN1 has recently been described to act as a regulator of the actin cytoskeleton reorganization by interaction with HS1, the lymphocyte-specific homologue of cortactin (von Holleben et al., 2011). To examine the function of SAMSN1 in the organization of the actin cytoskeleton, a migration assay was performed using the major mast cell chemoattractant SCF, which binds to the c-kit receptor on the mast cell surface. The resulting data did not give an indication that migration of BMMCs from *Samsn1*^{-/-} mice is impaired compared to WT cells. Therefore the conclusion can be drawn that SAMSN1 is not required for cell migration or for the regulation of the actin cytoskeleton in BMMCs.

In conclusion, the study of SAMSN1 in BMMCs did not reveal a function for this adaptor protein in the functional activities tested. This might be due to a compensatory effect of other SLY family members like SLY1, which is also expressed in mast cells. Even though *Sly1* mRNA is not increased in BMMCs deficient for *Samsn1*, this protein might still exert a function overlapping the one of SAMSN1. Another possible explanation is the redundancy of signaling pathways involving SAMSN1. The function of these yet unknown pathways in mast cells might be taken over by other pathways which exert the same or a comparable role. Additionally, SAMSN1 may play an essential role in other mast cell activities like antigen-presentation or Toll-like receptor signaling that have not been investigated in this study.

5.2 Role of microRNA miR-155

MicroRNAs (miRNAs) are small RNAs with a length of 21-25 bp that play an important role in the regulation of gene expression. Until now, 1223 human and 1055 mouse miRNAs have been identified, which are hypothesized to target 30-92% of the human genome (Dai and Ahmed, 2011; He and Hannon, 2004). Many miRNAs have been described to be expressed in myeloid and lymphoid cells, where they regulate processes like differentiation, proliferation, activation and antigen presentation (O'Connell et al., 2010).

The miRNA investigated in this study, miR-155, is known to be expressed in B cells, T cells, macrophages and dendritic cells. There, it has been described to target proteins like SHIP1 and SOCS1 or transcription factors like PU.1 and CEBPB (Lu et al., 2009; O'Connell et al., 2009; O'Connell et al., 2010; Vigorito et al., 2007). Until now, the expression of miR-155 or

its function in mast cells is yet unknown and only the activities of another miRNA family – miR-221-222 – has been described in mast cells (Mayoral et al., 2009). But since SHIP1 is a candidate target for miR-155 and is known to negatively regulate FcεRI-mediated mast cell degranulation (Huber et al., 1998), a function for miR-155 in mast cell activation can be hypothesized.

In this study I could demonstrate on a genetic basis that miR-155 functions as a negative regulator of mast cell degranulation. This is the first indication that a miRNA plays a role in mast cell activation and effector function. Although BMMCs show normal development, morphology, proliferation as well as mast cell protease content and activity in the absence of miR-155, this miRNA is important for the activation of mast cells induced by the high-affinity IgE receptor FcεRI. BMMCs deficient for *miR-155* show an increase in FcεRI-mediated degranulation and release of pro-inflammatory cytokines TNF-α and IL-6.

Based on the little information available about miR-155 in mast cells, its expression in murine BMMCs was investigated first. This showed to be increasing during BMMC development, but not upregulated upon stimulation with IgE and antigen. Although *miR-155* mRNA expression increased during mast cell development, proliferation, morphology and mast cell-specific surface marker expression were normal in BMMCs deficient for *miR-155* compared to WT BMMCs. In addition, mRNA expression of selected mast cell proteases and total mast cell protease activity were comparable between WT and *miR-155*^{-/-} BMMCs. In contrast, the only other miRNA which has been described to play a role in BMMCs – miR-221-222 – shows an upregulation of gene expression in BMMCs upon PMA and ionomycin stimulation and is suggested to play a role in the proliferation and cell cycle (Mayoral et al., 2009). A function of miR-221-222 in the activation process of mast cells was not described. A role for miR-155 in the proliferation of BMMCs could be excluded in this study. In conclusion, normal mast cell proliferation, differentiation and development in *miR-155*^{-/-} BMMCs are the basis for studying miR-155 function in BMMCs and in addition exclude an essential role for miR-155 on the maturation process of mast cells.

Functional analysis of miR-155 in BMMCs showed an increase in degranulation upon FcεRI stimulation in the absence of miR-155, according with increased TNF-α and IL-6 release. The increase of both degranulation and cytokine release led to the conclusion that miR-155 functions upstream in the FcεRI-mediated signaling and is not reduced to one effect of FcεRI

activation, but disrupts a more general signaling pathway in the activation of mast cells upon IgE and antigen stimulation.

The increase in degranulation in *miR-155*^{-/-} BMMCs conflicts with published data about possible targets of miR-155. One of these targets is SHIP1, which has been described to be repressed by miR-155 in macrophages (O'Connell et al., 2009). SHIP1 is also long known to negatively regulate FcεRI-mediated mast cell degranulation (Huber et al., 1998; O'Connell et al., 2009). In this study I could show that SHIP1 expression on mRNA as well as on protein level was comparable between *miR-155*^{-/-} BMMCs and WT control cells. If SHIP1 is a target of miR-155 in murine BMMCs, the finding of hyperdegranulation in *miR-155*^{-/-} BMMCs would contradict the published data about SHIP1, which would then be upregulated in the absence of miR-155. Therefore, the increased degranulation in *miR-155*^{-/-} BMMCs together with the comparable SHIP1 expression suggest that SHIP1 is not a target of miR-155 in mast cells and that miR-155 directly or indirectly interacts with other pathways involved in the degranulation of BMMCs.

In addition to the enhanced degranulation, an increase in TNF-α as well as IL-6 release was observed in BMMCs deficient for *miR-155*. The opposite effect was described for BMMCs deficient for the paracaspase *mucosa-associated lymphoid tissue 1 (Malt1)* or caspase recruitment domain protein *B cell lymphoma 10 (Bcl10)*. BMMCs from these mice showed normal FcεRI-mediated degranulation, lipid-mediator release and MAPK signaling. However, nuclear factor-kappaB (NF-κB) activation as well as the release of IL-6 and TNF-α were impaired in the absence of BCL10 and MALT1 (Klemm et al., 2006). In general, cytokine release is regulated by transcription factors, which are activated by intracellular calcium, protein kinase C (PKC) or AKT (Kraft and Kinet, 2007). Because of normal AKT activation and MAPK signaling in *Malt1*^{-/-} or *Bcl10*^{-/-} BMMCs, these two proteins presumably function downstream of MAPK ERK and p38 and do not involve AKT signaling. Since the opposite effect was demonstrated in *miR-155*^{-/-} BMMCs, this indicates that miR-155 acts upstream of MAPK signaling and supports the hypothesis that miR-155 has a more general effect on mast cell activation.

The search for specific miR-155 targets started with a microarray analysis, which revealed that constitutively no genes were differentially expressed in *miR-155*^{-/-} BMMCs compared to WT BMMCs. Upon sensitization with IgE and stimulation with antigen, only a few genes were significantly higher expressed. Most of these differentially expressed genes were

examined more closely by real-time PCR. TNIP3, which showed the highest differential gene expression in the microarray analysis in *miR-155*^{-/-} compared to WT BMMCs, is described to be expressed in human and mouse monocytes and macrophages and its expression is NF-κB dependent (Verstrepen et al., 2009; Weaver et al., 2007). Functionally it acts as a negative regulator of NF-κB-mediated responses (Elsby et al., 2010). Its high differential expression in BMMCs deficient for *miR-155* could suggest that miR-155 has an effect on signaling pathways involving NF-κB activation. Other genes like *Ccl1* and *Serpina9b* displayed a very low constitutive expression, but a strong increase after stimulation of FcεRI. The chemokine CCL1, which is a ligand of chemokine receptor CCR8, has been implicated with the recruitment of T helper type 2 cells in allergic inflammation (Romagnani, 2002). *Serpina9b* was shown to inhibit the function of granzyme M and protect cells from perforin/granzyme M-induced lysis in tumor cell lines as well as NK-like cells (Bots et al., 2005). The upregulated expression of both genes after stimulation with IgE and antigen indicates that the increased gene expression is due to a secondary effect of enhanced degranulation in *miR-155*^{-/-} BMMCs. In addition, microarray analysis shows an upregulation of the chemokine *Ccl9* in IgE/antigen-stimulated BMMCs. CCL9 (also known as MIP-1γ) is a pro-inflammatory, cancer-derived chemokine which binds the chemokine receptor CCR1 (Koizumi et al., 2007). Reports have shown that upon activation with IgE and antigen, mRNA expression of chemokines including *Ccl9* increases and FcεRI-mediated signaling is prolonged and exaggerated. This results in increased ERK and AKT phosphorylation as well as secretion and cytokine production (Hernandez-Hansen et al., 2005). Thus, the increase in *Ccl9* mRNA expression in *miR-155*^{-/-} BMMCs upon antigen-stimulation might also be an effect of increased FcεRI-signaling.

Two genes belonging to the same protein family and signaling pathway, *Pik3r5* (*p101*) and *Pik3r6* (*p84*, *p87*^{PIKAP}), showed an upregulation of mRNA expression and in case of PIK3R5 also of protein levels in unstimulated as well as antigen-stimulated BMMCs of *miR-155*^{-/-} mice compared to WT control cells. Both proteins are regulatory subunits of phosphoinositide 3-kinase gamma (PI3Kgamma) (Stephens et al., 1997; Suire et al., 2005). PI3Kgamma, the only class IB PI3K isoform described, consists of the catalytic subunit p110gamma together with one of the two regulatory subunits PIK3R5 or PIK3R6. PI3Kgamma is not directly activated in mast cells after engagement of FcεRI. First, activation of a class IA PI3K, PI3Kdelta, is induced upon binding of IgE to FcεRI followed by antigen cross-linking, which leads to a limited degranulation and release of chemokines and adenosine. Adenosine can then

bind and activate G-protein coupled receptors (GPCR) on the mast cell surface, leading to a secondary autocrine and paracrine amplification of degranulation involving the activation of PI3Kgamma (Rommel et al., 2007). Thus, from the upregulation of regulatory subunits PIK3R5 and PIK3R6 in *miR-155*^{-/-} BMMCs, the conclusion can be drawn that miR-155 acts as a negative regulator of FcεRI-mediated degranulation, inhibition of hyperdegranulation responses or termination of the degranulation process by involving the PI3Kgamma pathway. Consistent with this hypothesis, SHIP1 has been shown to only counteract class IA PI3Ks and not class IB PI3K, which includes PI3Kgamma (Wymann et al., 2003). Therefore, the results showing no increase in SHIP1 mRNA or protein levels in *miR-155*^{-/-} BMMCs compared to WT controls provide a second indication that not PI3Kdelta or other class IA PI3Ks are involved, but that the target of miR-155 in FcεRI-activated BMMCs lies within the PI3Kgamma pathway.

The gene expression of *Pi3kgamma* was comparable between unstimulated WT and *miR-155*^{-/-} BMMCs, but significantly decreased in antigen-stimulated BMMCs in the absence of miR-155. Mast cells from *Pi3kgamma*-deficient mice show reduced degranulation upon FcεRI cross-linking (Laffargue et al., 2002). However, no data is available on cytokine release in *Pi3kgamma*^{-/-} mast cells. Therefore, it can be suggested that miR-155 regulates PI3K signaling via the regulatory subunits of PI3Kgamma without affecting the expression of the catalytic subunit of PI3Kgamma, p110gamma. This could be due to an excess of catalytic subunits in the cell, which only form the functional enzyme together with the regulatory subunit. If more regulatory subunits are present, which seems to be true in *miR-155*^{-/-} BMMCs, more functional enzyme can be formed. Thus, more functionally active PI3Kgamma will result in an increase in PI3Kgamma signaling, including AKT phosphorylation. An alternative explanation for the decreased *Pi3kgamma* mRNA expression could be due to a reduced stability of the catalytic subunit p110gamma in comparison to the one of the regulatory subunit PIK3R6 (Voigt et al., 2006). Furthermore, I cannot exclude that other cell type-specific regulatory mechanisms could account for the differences in mRNA expression of catalytic and regulatory subunits of PI3Kgamma during activation of *miR-155*^{-/-} BMMCs.

The tumor suppressor protein phosphatase and tensin homologue (PTEN) has been shown to negatively regulate PI3K signaling by dephosphorylation of phosphatidylinositol 3,4,5-triphosphate (PIP₃) to phosphatidylinositol 4,5-bisphosphate (PIP₂) and therefore leads to reduced phosphorylation of AKT (Maehama and Dixon, 1998). Here I can show that *Pten*

gene expression is comparable between unstimulated and IgE/antigen-stimulated WT and *miR-155*^{-/-} BMMCs. PTEN acts at the same position in FcεRI-mediated signaling as SHIP1 and also negatively regulates PIP₃ levels. As stated before, SHIP1 only functions in the hydrolysis of PIP₃ derived from class IA PI3K signaling and does not affect PIP₃ production through class IB PI3K, namely PI3Kγ. Since *Ship1*-deficient mast cells show nearly the same phenotype as *Pten*-deficient mast cells, a redundancy for SHIP1 and PTEN in the regulation of PIP₃ levels has been suggested (Furumoto et al., 2006). This could be an indication that PTEN does not play a role in the control of PIP₃ levels in PI3Kγ signaling upon FcεRI-stimulation. Therefore, PTEN expression remains unaffected by the absence of miR-155.

Another finding consistent with the previous results was the increased AKT phosphorylation in *miR-155*^{-/-} BMMCs compared to WT BMMCs. Unlike ERK phosphorylation, which was comparable between antigen-stimulated WT and *miR-155*^{-/-} BMMCs, AKT showed a significant and dose-dependent higher increase in phosphorylation in BMMCs deficient for *miR-155* after FcεRI stimulation. It is known that PI3Kγ signaling induces the phosphorylation of AKT, which then leads to the release of pro-inflammatory cytokines like IL-6, TNF-α and IL-12 (Bohnacker et al., 2009; Cremer et al., 2011). Thus, the findings of increased AKT phosphorylation are consistent with increased cytokine production in *miR-155*^{-/-} BMMCs.

Taken together, miR-155 acts as a negative regulator of FcεRI-mediated mast cell degranulation and regulates the PI3Kγ pathway by directly or indirectly inhibiting the expression of PI3Kγ regulatory subunits PIK3R5 (p101) and PIK3R6 (p84, p87^{PIKAP}). This leads to a decrease in AKT but not ERK phosphorylation and terminates in the decrease of FcεRI-mediated degranulation and cytokine release. SHIP1 and SOCS1, which have been described to be targeted by miR-155 in other cell types, as well as PTEN, seem not to be involved in this process.

5.3 Conclusion and perspective

FcεRI-mediated mast cell degranulation is a complex process which has to be regulated on several levels. In this study I could show that the adaptor protein SAMSN1 is not an essential regulator of degranulation and cytokine secretion in murine BMMC upon FcεRI cross-linking with IgE and antigen. Additionally, SCF-induced BMMC migration is not regulated by SAMSN1. Therefore, the role of SAMSN1 in mast cells remains to be elucidated.

By contrast, I could show that microRNA miR-155 acts as a negative regulator in IgE/antigen-mediated mast cell degranulation. My data strongly indicate that this negative regulation is exerted via the PI3Kγ signaling pathway by inhibiting the expression of PI3Kγ regulatory subunits PIK3R5 (p101) and PIK3R6 (p84, p87^{PIKAP}) resulting in decreased AKT phosphorylation. This leads to reduced degranulation and pro-inflammatory cytokine release. The proposed role of miR-155 and its mechanism is depicted in Figure 5-1.

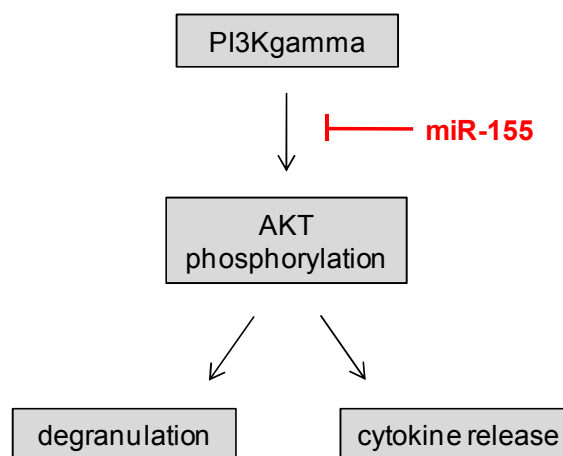

Figure 5-1 Proposed role of miR-155 in FcεRI-mediated mast cell degranulation.

The exact mRNA targets which miR-155 binds to still remain elusive. Therefore the study of specific miR-155 targets continues to be an important aspect in finding the complete mode of action of miR-155. Preliminary data using specific PI3Kγ inhibitors show the inhibition of enhanced degranulation in *miR-155*^{-/-} BMMCs compared to WT cells. As a result, *miR-155*^{-/-} BMMCs treated with PI3Kγ inhibitors show a comparable level of FcεRI-mediated degranulation than WT BMMCs. These preliminary data need to be confirmed,

however, together with the data shown in this thesis, strongly suggest that one target of miR-155 in BMDCs lies within the PI3Kgamma pathway.

Further research is needed regarding the verification of the here presented results in an *in vivo* setting. For this, mast cells from the peritoneal cavity of *miR-155^{-/-}* mice could be directly isolated and examined for enhanced degranulation. Since only a minor population of the entire peritoneal cell population consists of mast cells, it is technically difficult to perform this type of experiment. Therefore, to verify the function of miR-155 in regulating mast cell degranulation in mice *in vivo*, an anaphylaxis model can be utilized. The two classical anaphylaxis models are passive cutaneous anaphylaxis (PCA) and passive systemic anaphylaxis (PSA). PCA is performed by injecting IgE subcutaneously into one ear of a mouse, whereas the other ear is injected with saline, which serves as a negative control. After 24 hours, specific antigen is injected intravenously into the mouse to induce mast cell activation at the place of injected IgE (Klemm et al., 2006). Read out of this model is the swelling of the IgE-injected body parts compared to saline-injected control areas. In contrast, PSA is induced by intravenous injection of IgE and antigen into the mouse to induce a systemic anaphylaxis reaction. This model leads to an allergic reaction in the complete body. Read outs include the measurement of body temperature, respiratory parameters, blood pressure and plasma histamine concentrations (Makabe-Kobayashi et al., 2002). Since mice lacking the catalytic subunit p110gamma and both regulatory subunits of PI3Kgamma are protected against systemic anaphylaxis (Kurig et al., 2009), the outcome of inducing PSA in *miR-155^{-/-}* mice, which express more PI3Kgamma regulatory subunits PIK3R5 and PIK3R6, should be opposite. This indicates that the comparison of the anaphylactic reaction shown by WT mice compared to *miR-155^{-/-}* mice in a mouse model should result in increased mast cell activation in the absence of miR-155.

The demonstrated ability of miR-155 to regulate mast cell function displays a new aspect of miRNA and mast cell research. As stated before, only miR-221-222 has been described to regulate the cell cycle in murine mast cells and no function for this or another miRNA was shown in mast cells. This study shows for the first time that miRNAs are capable of regulating mast cell function and raises the hypothesis that additional miRNAs aside from miR-221-222 and miR-155 play a role in regulating FcεRI-mediated activation or other mast cell-specific processes. Therefore, miRNAs could represent a novel level of mast cell degranulation control in addition to the currently available ones which are based on blocking FcεRI

signaling directly for example with anti-IgE or which block released mediators with histamine antagonists.

Thus, this study is pointing towards a new direction in the regulation of mast cell activation and allergy research, where miRNAs could be a new therapeutic target in the regulation of allergic disorders by decreasing degranulation and the resulting mediator release.

6 References

- Alvarez-Errico, D., Lessmann, E., and Rivera, J. (2009). Adapters in the organization of mast cell signaling. *Immunol Rev* 232, 195-217.
- Banovac, K., Neylan, D., Leone, J., Ghandur-Mnaymneh, L., and Rabinovitch, A. (1989). Are the mast cells antigen presenting cells? *Immunol Invest* 18, 901-906.
- Barker, S.A., Caldwell, K.K., Hall, A., Martinez, A.M., Pfeiffer, J.R., Oliver, J.M., and Wilson, B.S. (1995). Wortmannin blocks lipid and protein kinase activities associated with PI 3-kinase and inhibits a subset of responses induced by Fc epsilon R1 cross-linking. *Mol Biol Cell* 6, 1145-1158.
- Beer, S., Simins, A.B., Schuster, A., and Holzmann, B. (2001). Molecular cloning and characterization of a novel SH3 protein (SLY) preferentially expressed in lymphoid cells. *Biochim Biophys Acta* 1520, 89-93.
- Bienenstock, J., Befus, A.D., Pearce, F., Denburg, J., and Goodacre, R. (1982). Mast cell heterogeneity: derivation and function, with emphasis on the intestine. *J Allergy Clin Immunol* 70, 407-412.
- Bischoff, S.C. (2007). Role of mast cells in allergic and non-allergic immune responses: comparison of human and murine data. *Nat Rev Immunol* 7, 93-104.
- Bohnacker, T., Marone, R., Collmann, E., Calvez, R., Hirsch, E., and Wymann, M.P. (2009). PI3Kgamma adaptor subunits define coupling to degranulation and cell motility by distinct PtdIns(3,4,5)P3 pools in mast cells. *Sci Signal* 2, ra27.
- Bonini, S., Lambiase, A., Lapucci, G., Properzi, F., Bresciani, M., Bracci Laudiero, M.L., Mancini, M.J., Procoli, A., Micera, A., Sacerdoti, G., *et al.* (2002). Nerve growth factor and asthma. *Allergy* 57 Suppl 72, 13-15.
- Bots, M., Kolfshoten, I.G., Bres, S.A., Rademaker, M.T., de Roo, G.M., Kruse, M., Franken, K.L., Hahne, M., Froelich, C.J., Melief, C.J., *et al.* (2005). SPI-CI and SPI-6 cooperate in the protection from effector cell-mediated cytotoxicity. *Blood* 105, 1153-1161.
- Brameier, M., and Wiuf, C. (2007). Ab initio identification of human microRNAs based on structure motifs. *BMC Bioinformatics* 8, 478.
- Caron, G., Delneste, Y., Roelandts, E., Duez, C., Bonnefoy, J.Y., Pestel, J., and Jeannin, P. (2001). Histamine polarizes human dendritic cells into Th2 cell-promoting effector dendritic cells. *J Immunol* 167, 3682-3686.
- Chen, C., Ridzon, D.A., Broomer, A.J., Zhou, Z., Lee, D.H., Nguyen, J.T., Barbisin, M., Xu, N.L., Mahuvakar, V.R., Andersen, M.R., *et al.* (2005). Real-time quantification of microRNAs by stem-loop RT-PCR. *Nucleic Acids Res* 33, e179.
- Christy, A.L., and Brown, M.A. (2007). The multitasking mast cell: positive and negative roles in the progression of autoimmunity. *J Immunol* 179, 2673-2679.
- Cimmino, A., Calin, G.A., Fabbri, M., Iorio, M.V., Ferracin, M., Shimizu, M., Wojcik, S.E., Aqeilan, R.I., Zupo, S., Dono, M., *et al.* (2005). miR-15 and miR-16 induce apoptosis by targeting BCL2. *Proc Natl Acad Sci U S A* 102, 13944-13949.

- Claudio, J.O., Zhu, Y.X., Benn, S.J., Shukla, A.H., McGlade, C.J., Falcioni, N., and Stewart, A.K. (2001). HACS1 encodes a novel SH3-SAM adaptor protein differentially expressed in normal and malignant hematopoietic cells. *Oncogene* 20, 5373-5377.
- Coleman, J.W., Holliday, M.R., Kimber, I., Zsebo, K.M., and Galli, S.J. (1993). Regulation of mouse peritoneal mast cell secretory function by stem cell factor, IL-3 or IL-4. *J Immunol* 150, 556-562.
- Columbo, M., Horowitz, E.M., Botana, L.M., MacGlashan, D.W., Jr., Bochner, B.S., Gillis, S., Zsebo, K.M., Galli, S.J., and Lichtenstein, L.M. (1992). The human recombinant c-kit receptor ligand, rhSCF, induces mediator release from human cutaneous mast cells and enhances IgE-dependent mediator release from both skin mast cells and peripheral blood basophils. *J Immunol* 149, 599-608.
- Cremer, T.J., Butchar, J.P., and Tridandapani, S. (2011). Francisella Subverts Innate Immune Signaling: Focus On PI3K/Akt. *Front Microbiol* 5, 13.
- Daeron, M., Bonnerot, C., Latour, S., and Fridman, W.H. (1992). Murine recombinant Fc gamma RIII, but not Fc gamma RII, trigger serotonin release in rat basophilic leukemia cells. *J Immunol* 149, 1365-1373.
- Daeron, M., Malbec, O., Latour, S., Arock, M., and Fridman, W.H. (1995). Regulation of high-affinity IgE receptor-mediated mast cell activation by murine low-affinity IgG receptors. *J Clin Invest* 95, 577-585.
- Dai, R., and Ahmed, S.A. (2011). MicroRNA, a new paradigm for understanding immunoregulation, inflammation, and autoimmune diseases. *Transl Res* 157, 163-179.
- Damsgaard, T.E., Olesen, A.B., Sorensen, F.B., Thestrup-Pedersen, K., and Schiotz, P.O. (1997). Mast cells and atopic dermatitis. Stereological quantification of mast cells in atopic dermatitis and normal human skin. *Arch Dermatol Res* 289, 256-260.
- Di Nardo, A., Vitiello, A., and Gallo, R.L. (2003). Cutting edge: mast cell antimicrobial activity is mediated by expression of cathelicidin antimicrobial peptide. *J Immunol* 170, 2274-2278.
- Dvorak, A.M., Seder, R.A., Paul, W.E., Morgan, E.S., and Galli, S.J. (1994). Effects of interleukin-3 with or without the c-kit ligand, stem cell factor, on the survival and cytoplasmic granule formation of mouse basophils and mast cells in vitro. *Am J Pathol* 144, 160-170.
- Eis, P.S., Tam, W., Sun, L., Chadburn, A., Li, Z., Gomez, M.F., Lund, E., and Dahlberg, J.E. (2005). Accumulation of miR-155 and BIC RNA in human B cell lymphomas. *Proc Natl Acad Sci U S A* 102, 3627-3632.
- Elsby, L.M., Orozco, G., Denton, J., Worthington, J., Ray, D.W., and Donn, R.P. (2010). Functional evaluation of TNFAIP3 (A20) in rheumatoid arthritis. *Clin Exp Rheumatol* 28, 708-714.
- Faraoni, I., Antonetti, F.R., Cardone, J., and Bonmassar, E. (2009). miR-155 gene: a typical multifunctional microRNA. *Biochim Biophys Acta* 1792, 497-505.
- Fire, A., Xu, S., Montgomery, M.K., Kostas, S.A., Driver, S.E., and Mello, C.C. (1998). Potent and specific genetic interference by double-stranded RNA in *Caenorhabditis elegans*. *Nature* 391, 806-811.
- Flynn, D.C. (2001). Adaptor proteins. *Oncogene* 20, 6270-6272.

- Fox, C.C., Jewell, S.D., and Whitacre, C.C. (1994). Rat peritoneal mast cells present antigen to a PPD-specific T cell line. *Cell Immunol* *158*, 253-264.
- Frandji, P., Oskeritzian, C., Cacaraci, F., Lapeyre, J., Peronet, R., David, B., Guillet, J.G., and Mecheri, S. (1993). Antigen-dependent stimulation by bone marrow-derived mast cells of MHC class II-restricted T cell hybridoma. *J Immunol* *151*, 6318-6328.
- Furumoto, Y., Brooks, S., Olivera, A., Takagi, Y., Miyagishi, M., Taira, K., Casellas, R., Beaven, M.A., Gilfillan, A.M., and Rivera, J. (2006). Cutting Edge: Lentiviral short hairpin RNA silencing of PTEN in human mast cells reveals constitutive signals that promote cytokine secretion and cell survival. *J Immunol* *176*, 5167-5171.
- Furuta, T., Kikuchi, T., Iwakura, Y., and Watanabe, N. (2006). Protective roles of mast cells and mast cell-derived TNF in murine malaria. *J Immunol* *177*, 3294-3302.
- Galli, S.J., Nakae, S., and Tsai, M. (2005). Mast cells in the development of adaptive immune responses. *Nat Immunol* *6*, 135-142.
- Galli, S.J., Zsebo, K.M., and Geissler, E.N. (1994). The kit ligand, stem cell factor. *Adv Immunol* *55*, 1-96.
- Gauchat, J.F., Henchoz, S., Mazzei, G., Aubry, J.P., Brunner, T., Blasey, H., Life, P., Talabot, D., Flores-Romo, L., Thompson, J., and et al. (1993). Induction of human IgE synthesis in B cells by mast cells and basophils. *Nature* *365*, 340-343.
- Gilfillan, A.M., and Tkaczyk, C. (2006). Integrated signalling pathways for mast-cell activation. *Nat Rev Immunol* *6*, 218-230.
- Gimborn, K., Lessmann, E., Kuppig, S., Krystal, G., and Huber, M. (2005). SHIP down-regulates FcepsilonR1-induced degranulation at supraoptimal IgE or antigen levels. *J Immunol* *174*, 507-516.
- Gottwein, E., Mukherjee, N., Sachse, C., Frenzel, C., Majoros, W.H., Chi, J.T., Braich, R., Manoharan, M., Soutschek, J., Ohler, U., and Cullen, B.R. (2007). A viral microRNA functions as an orthologue of cellular miR-155. *Nature* *450*, 1096-1099.
- Gregory, G.D., Raju, S.S., Winandy, S., and Brown, M.A. (2006). Mast cell IL-4 expression is regulated by Ikaros and influences encephalitogenic Th1 responses in EAE. *J Clin Invest* *116*, 1327-1336.
- He, L., and Hannon, G.J. (2004). MicroRNAs: small RNAs with a big role in gene regulation. *Nat Rev Genet* *5*, 522-531.
- Hernandez-Hansen, V., Bard, J.D., Tarleton, C.A., Wilder, J.A., Lowell, C.A., Wilson, B.S., and Oliver, J.M. (2005). Increased expression of genes linked to FcepsilonRI Signaling and to cytokine and chemokine production in Lyn-deficient mast cells. *J Immunol* *175*, 7880-7888.
- Hidaka, M., Homma, Y., and Takenawa, T. (1991). Highly conserved eight amino acid sequence in SH2 is important for recognition of phosphotyrosine site. *Biochem Biophys Res Commun* *180*, 1490-1497.
- Hiragun, T., Peng, Z., and Beaven, M.A. (2005). Dexamethasone up-regulates the inhibitory adaptor protein Dok-1 and suppresses downstream activation of the mitogen-activated protein kinase pathway in antigen-stimulated RBL-2H3 mast cells. *Mol Pharmacol* *67*, 598-603.
- Hiragun, T., Peng, Z., and Beaven, M.A. (2006). Cutting edge: dexamethasone negatively regulates Syk in mast cells by up-regulating SRC-like adaptor protein. *J Immunol* *177*, 2047-2050.

- Huber, M., Helgason, C.D., Damen, J.E., Liu, L., Humphries, R.K., and Krystal, G. (1998). The src homology 2-containing inositol phosphatase (SHIP) is the gatekeeper of mast cell degranulation. *Proc Natl Acad Sci U S A* *95*, 11330-11335.
- Hutchinson, L.E., and McCloskey, M.A. (1995). Fc epsilon RI-mediated induction of nuclear factor of activated T-cells. *J Biol Chem* *270*, 16333-16338.
- Kalesnikoff, J., and Galli, S.J. (2008). New developments in mast cell biology. *Nat Immunol* *9*, 1215-1223.
- Kim, M.S., Radinger, M., and Gilfillan, A.M. (2008). The multiple roles of phosphoinositide 3-kinase in mast cell biology. *Trends Immunol* *29*, 493-501.
- Klemm, S., Gutermuth, J., Hultner, L., Sparwasser, T., Behrendt, H., Peschel, C., Mak, T.W., Jakob, T., and Ruland, J. (2006). The Bcl10-Malt1 complex segregates Fc epsilon RI-mediated nuclear factor kappa B activation and cytokine production from mast cell degranulation. *J Exp Med* *203*, 337-347.
- Kluiver, J., Poppema, S., de Jong, D., Blokzijl, T., Harms, G., Jacobs, S., Kroesen, B.J., and van den Berg, A. (2005). BIC and miR-155 are highly expressed in Hodgkin, primary mediastinal and diffuse large B cell lymphomas. *J Pathol* *207*, 243-249.
- Koizumi, K., Hojo, S., Akashi, T., Yasumoto, K., and Saiki, I. (2007). Chemokine receptors in cancer metastasis and cancer cell-derived chemokines in host immune response. *Cancer Sci* *98*, 1652-1658.
- Kraft, S., and Kinet, J.P. (2007). New developments in FcepsilonRI regulation, function and inhibition. *Nat Rev Immunol* *7*, 365-378.
- Kurig, B., Shymanets, A., Bohnacker, T., Prajwal, Brock, C., Ahmadian, M.R., Schaefer, M., Gohla, A., Harteneck, C., Wymann, M.P., *et al.* (2009). Ras is an indispensable coregulator of the class IB phosphoinositide 3-kinase p87/p110gamma. *Proc Natl Acad Sci U S A* *106*, 20312-20317.
- Laffargue, M., Calvez, R., Finan, P., Trifilieff, A., Barbier, M., Altruda, F., Hirsch, E., and Wymann, M.P. (2002). Phosphoinositide 3-kinase gamma is an essential amplifier of mast cell function. *Immunity* *16*, 441-451.
- Lagos-Quintana, M., Rauhut, R., Yalcin, A., Meyer, J., Lendeckel, W., and Tuschl, T. (2002). Identification of tissue-specific microRNAs from mouse. *Curr Biol* *12*, 735-739.
- Latour, S., Bonnerot, C., Fridman, W.H., and Daeron, M. (1992). Induction of tumor necrosis factor-alpha production by mast cells via Fc gamma R. Role of the Fc gamma RIII gamma subunit. *J Immunol* *149*, 2155-2162.
- Lattin, J.E., Schroder, K., Su, A.I., Walker, J.R., Zhang, J., Wiltshire, T., Saijo, K., Glass, C.K., Hume, D.A., Kellie, S., and Sweet, M.J. (2008). Expression analysis of G Protein-Coupled Receptors in mouse macrophages. *Immunome Res* *4*, 5.
- Lee, R.C., and Ambros, V. (2001). An extensive class of small RNAs in *Caenorhabditis elegans*. *Science* *294*, 862-864.
- Lee, R.C., Feinbaum, R.L., and Ambros, V. (1993). The *C. elegans* heterochronic gene *lin-4* encodes small RNAs with antisense complementarity to *lin-14*. *Cell* *75*, 843-854.
- Lewis, B.P., Burge, C.B., and Bartel, D.P. (2005). Conserved seed pairing, often flanked by adenosines, indicates that thousands of human genes are microRNA targets. *Cell* *120*, 15-20.

- Li, G., Miskimen, K.L., Wang, Z., Xie, X.Y., Brenzovich, J., Ryan, J.J., Tse, W., Moriggl, R., and Bunting, K.D. (2010). STAT5 requires the N-domain for suppression of miR15/16, induction of bcl-2, and survival signaling in myeloproliferative disease. *Blood* *115*, 1416-1424.
- Lu, L.F., Thai, T.H., Calado, D.P., Chaudhry, A., Kubo, M., Tanaka, K., Loeb, G.B., Lee, H., Yoshimura, A., Rajewsky, K., and Rudensky, A.Y. (2009). Foxp3-dependent microRNA155 confers competitive fitness to regulatory T cells by targeting SOCS1 protein. *Immunity* *30*, 80-91.
- Maehama, T., and Dixon, J.E. (1998). The tumor suppressor, PTEN/MMAC1, dephosphorylates the lipid second messenger, phosphatidylinositol 3,4,5-trisphosphate. *J Biol Chem* *273*, 13375-13378.
- Makabe-Kobayashi, Y., Hori, Y., Adachi, T., Ishigaki-Suzuki, S., Kikuchi, Y., Kagaya, Y., Shirato, K., Nagy, A., Ujike, A., Takai, T., *et al.* (2002). The control effect of histamine on body temperature and respiratory function in IgE-dependent systemic anaphylaxis. *J Allergy Clin Immunol* *110*, 298-303.
- Marquardt, D.L., and Walker, L.L. (2000). Dependence of mast cell IgE-mediated cytokine production on nuclear factor-kappaB activity. *J Allergy Clin Immunol* *105*, 500-505.
- Marshall, J.S. (2004). Mast-cell responses to pathogens. *Nat Rev Immunol* *4*, 787-799.
- Masuda, A., Yoshikai, Y., Aiba, K., and Matsuguchi, T. (2002). Th2 cytokine production from mast cells is directly induced by lipopolysaccharide and distinctly regulated by c-Jun N-terminal kinase and p38 pathways. *J Immunol* *169*, 3801-3810.
- Maurer, M., Theoharides, T., Granstein, R.D., Bischoff, S.C., Bienenstock, J., Henz, B., Kovanen, P., Piliponsky, A.M., Kambe, N., Vliagoftis, H., *et al.* (2003). What is the physiological function of mast cells? *Exp Dermatol* *12*, 886-910.
- Mayoral, R.J., Pipkin, M.E., Pachkov, M., van Nimwegen, E., Rao, A., and Monticelli, S. (2009). MicroRNA-221-222 regulate the cell cycle in mast cells. *J Immunol* *182*, 433-445.
- McDermott, J.R., Bartram, R.E., Knight, P.A., Miller, H.R., Garrod, D.R., and Grencis, R.K. (2003). Mast cells disrupt epithelial barrier function during enteric nematode infection. *Proc Natl Acad Sci U S A* *100*, 7761-7766.
- Metcalfe, D.D. (2008). Mast cells and mastocytosis. *Blood* *112*, 946-956.
- Metcalfe, D.D., Baram, D., and Mekori, Y.A. (1997). Mast cells. *Physiol Rev* *77*, 1033-1079.
- Metz, M., and Maurer, M. (2007). Mast cells--key effector cells in immune responses. *Trends Immunol* *28*, 234-241.
- Miller, M.D., Wilson, S.D., Dorf, M.E., Seuanez, H.N., O'Brien, S.J., and Krangel, M.S. (1990). Sequence and chromosomal location of the I-309 gene. Relationship to genes encoding a family of inflammatory cytokines. *J Immunol* *145*, 2737-2744.
- Montgomery, M.K., Xu, S., and Fire, A. (1998). RNA as a target of double-stranded RNA-mediated genetic interference in *Caenorhabditis elegans*. *Proc Natl Acad Sci U S A* *95*, 15502-15507.
- Monticelli, S., Ansel, K.M., Xiao, C., Socci, N.D., Krichevsky, A.M., Thai, T.H., Rajewsky, N., Marks, D.S., Sander, C., Rajewsky, K., *et al.* (2005). MicroRNA profiling of the murine hematopoietic system. *Genome Biol* *6*, R71.

- Nigrovic, P.A., Binstadt, B.A., Monach, P.A., Johnsen, A., Gurish, M., Iwakura, Y., Benoist, C., Mathis, D., and Lee, D.M. (2007). Mast cells contribute to initiation of autoantibody-mediated arthritis via IL-1. *Proc Natl Acad Sci U S A* *104*, 2325-2330.
- Nilsson, G., Butterfield, J.H., Nilsson, K., and Siegbahn, A. (1994). Stem cell factor is a chemotactic factor for human mast cells. *J Immunol* *153*, 3717-3723.
- O'Connell, R.M., Chaudhuri, A.A., Rao, D.S., and Baltimore, D. (2009). Inositol phosphatase SHIP1 is a primary target of miR-155. *Proc Natl Acad Sci U S A* *106*, 7113-7118.
- O'Connell, R.M., Rao, D.S., Chaudhuri, A.A., and Baltimore, D. (2010). Physiological and pathological roles for microRNAs in the immune system. *Nat Rev Immunol* *10*, 111-122.
- O'Connell, R.M., Rao, D.S., Chaudhuri, A.A., Boldin, M.P., Taganov, K.D., Nicoll, J., Paquette, R.L., and Baltimore, D. (2008). Sustained expression of microRNA-155 in hematopoietic stem cells causes a myeloproliferative disorder. *J Exp Med* *205*, 585-594.
- O'Connell, R.M., Taganov, K.D., Boldin, M.P., Cheng, G., and Baltimore, D. (2007). MicroRNA-155 is induced during the macrophage inflammatory response. *Proc Natl Acad Sci U S A* *104*, 1604-1609.
- Oda, H., Fujimoto, M., Patrick, M.S., Chida, D., Sato, Y., Azuma, Y., Aoki, H., Abe, T., Suzuki, H., and Shirai, M. (2009). RhoH plays critical roles in Fc epsilon RI-dependent signal transduction in mast cells. *J Immunol* *182*, 957-962.
- Orinska, Z., Bulanova, E., Budagian, V., Metz, M., Maurer, M., and Bulfone-Paus, S. (2005). TLR3-induced activation of mast cells modulates CD8+ T-cell recruitment. *Blood* *106*, 978-987.
- Pawson, T. (2007). Dynamic control of signaling by modular adaptor proteins. *Curr Opin Cell Biol* *19*, 112-116.
- Pawson, T., and Scott, J.D. (1997). Signaling through scaffold, anchoring, and adaptor proteins. *Science* *278*, 2075-2080.
- Price, L.S., Norman, J.C., Ridley, A.J., and Koffer, A. (1995). The small GTPases Rac and Rho as regulators of secretion in mast cells. *Curr Biol* *5*, 68-73.
- Prussin, C., and Metcalfe, D.D. (2003). 4. IgE, mast cells, basophils, and eosinophils. *J Allergy Clin Immunol* *111*, S486-494.
- Qiao, F., and Bowie, J.U. (2005). The many faces of SAM. *Sci STKE* *2005*, re7.
- Raposo, G., Tenza, D., Mecheri, S., Peronet, R., Bonnerot, C., and Desaymard, C. (1997). Accumulation of major histocompatibility complex class II molecules in mast cell secretory granules and their release upon degranulation. *Mol Biol Cell* *8*, 2631-2645.
- Razin, E., Ihle, J.N., Seldin, D., Mencia-Huerta, J.M., Katz, H.R., LeBlanc, P.A., Hein, A., Caulfield, J.P., Austen, K.F., and Stevens, R.L. (1984). Interleukin 3: A differentiation and growth factor for the mouse mast cell that contains chondroitin sulfate E proteoglycan. *J Immunol* *132*, 1479-1486.
- Riley, J. (1954). The riddle of the mast cells; a tribute to Paul Ehrlich. *Lancet* *266*, 841-843.
- Rodriguez, A., Vigorito, E., Clare, S., Warren, M.V., Couttet, P., Soond, D.R., van Dongen, S., Grocock, R.J., Das, P.P., Miska, E.A., *et al.* (2007). Requirement of bic/microRNA-155 for normal immune function. *Science* *316*, 608-611.

- Romagnani, S. (2002). Cytokines and chemoattractants in allergic inflammation. *Mol Immunol* 38, 881-885.
- Rommel, C., Camps, M., and Ji, H. (2007). PI3K delta and PI3K gamma: partners in crime in inflammation in rheumatoid arthritis and beyond? *Nat Rev Immunol* 7, 191-201.
- Roth, K., Chen, W.M., and Lin, T.J. (2008). Positive and negative regulatory mechanisms in high-affinity IgE receptor-mediated mast cell activation. *Arch Immunol Ther Exp (Warsz)* 56, 385-399.
- Saiki, R.K., Gelfand, D.H., Stoffel, S., Scharf, S.J., Higuchi, R., Horn, G.T., Mullis, K.B., and Erlich, H.A. (1988). Primer-directed enzymatic amplification of DNA with a thermostable DNA polymerase. *Science* 239, 487-491.
- Saitoh, S., Arudchandran, R., Manetz, T.S., Zhang, W., Sommers, C.L., Love, P.E., Rivera, J., and Samelson, L.E. (2000). LAT is essential for Fc(epsilon)RI-mediated mast cell activation. *Immunity* 12, 525-535.
- Sanger, F., Nicklen, S., and Coulson, A.R. (1977). DNA sequencing with chain-terminating inhibitors. *Proc Natl Acad Sci U S A* 74, 5463-5467.
- Sayed, B.A., Walker, M.E., and Brown, M.A. (2011). Cutting edge: mast cells regulate disease severity in a relapsing-remitting model of multiple sclerosis. *J Immunol* 186, 3294-3298.
- Schwartz, L.B., and Austen, K.F. (1980). Enzymes of the mast cell granule. *J Invest Dermatol* 74, 349-353.
- Sethupathy, P., Borel, C., Gagnebin, M., Grant, G.R., Deutsch, S., Elton, T.S., Hatzigeorgiou, A.G., and Antonarakis, S.E. (2007). Human microRNA-155 on chromosome 21 differentially interacts with its polymorphic target in the AGTR1 3' untranslated region: a mechanism for functional single-nucleotide polymorphisms related to phenotypes. *Am J Hum Genet* 81, 405-413.
- Skalsky, R.L., Samols, M.A., Plaisance, K.B., Boss, I.W., Riva, A., Lopez, M.C., Baker, H.V., and Renne, R. (2007). Kaposi's sarcoma-associated herpesvirus encodes an ortholog of miR-155. *J Virol* 81, 12836-12845.
- Skokos, D., Botros, H.G., Demeure, C., Morin, J., Peronet, R., Birkenmeier, G., Boudaly, S., and Mecheri, S. (2003). Mast cell-derived exosomes induce phenotypic and functional maturation of dendritic cells and elicit specific immune responses in vivo. *J Immunol* 170, 3037-3045.
- Stelekati, E., Orinska, Z., and Bulfone-Paus, S. (2007). Mast cells in allergy: innate instructors of adaptive responses. *Immunobiology* 212, 505-519.
- Stephens, L.R., Eguinoa, A., Erdjument-Bromage, H., Lui, M., Cooke, F., Coadwell, J., Smrcka, A.S., Thelen, M., Cadwallader, K., Tempst, P., and Hawkins, P.T. (1997). The G beta gamma sensitivity of a PI3K is dependent upon a tightly associated adaptor, p101. *Cell* 89, 105-114.
- Stone, K.D., Prussin, C., and Metcalfe, D.D. (2009). IgE, mast cells, basophils, and eosinophils. *J Allergy Clin Immunol* 125, S73-80.
- Suire, S., Coadwell, J., Ferguson, G.J., Davidson, K., Hawkins, P., and Stephens, L. (2005). p84, a new Gbetagamma-activated regulatory subunit of the type IB phosphoinositide 3-kinase p110gamma. *Curr Biol* 15, 566-570.

- Supajatura, V., Ushio, H., Nakao, A., Akira, S., Okumura, K., Ra, C., and Ogawa, H. (2002). Differential responses of mast cell Toll-like receptors 2 and 4 in allergy and innate immunity. *J Clin Invest* *109*, 1351-1359.
- Suzuki, H., Takei, M., Yanagida, M., Nakahata, T., Kawakami, T., and Fukamachi, H. (1997). Early and late events in Fc epsilon RI signal transduction in human cultured mast cells. *J Immunol* *159*, 5881-5888.
- Taganov, K.D., Boldin, M.P., Chang, K.J., and Baltimore, D. (2006). NF-kappaB-dependent induction of microRNA miR-146, an inhibitor targeted to signaling proteins of innate immune responses. *Proc Natl Acad Sci U S A* *103*, 12481-12486.
- Thai, T.H., Calado, D.P., Casola, S., Ansel, K.M., Xiao, C., Xue, Y., Murphy, A., Frenthewey, D., Valenzuela, D., Kutok, J.L., *et al.* (2007). Regulation of the germinal center response by microRNA-155. *Science* *316*, 604-608.
- Tkaczyk, C., Frandji, P., Botros, H.G., Poncet, P., Lapeyre, J., Peronet, R., David, B., and Mecheri, S. (1996). Mouse bone marrow-derived mast cells and mast cell lines constitutively produce B cell growth and differentiation activities. *J Immunol* *157*, 1720-1728.
- Tsitsiou, E., and Lindsay, M.A. (2009). microRNAs and the immune response. *Curr Opin Pharmacol* *9*, 514-520.
- Turner, H., and Kinet, J.P. (1999). Signalling through the high-affinity IgE receptor Fc epsilonRI. *Nature* *402*, B24-30.
- Uchida, T., Nakao, A., Nakano, N., Kuramasu, A., Saito, H., Okumura, K., Ra, C., and Ogawa, H. (2001). Identification of Nash1, a novel protein containing a nuclear localization signal, a sterile alpha motif, and an SH3 domain preferentially expressed in mast cells. *Biochem Biophys Res Commun* *288*, 137-141.
- Underhill, D.M., and Goodridge, H.S. (2007). The many faces of ITAMs. *Trends Immunol* *28*, 66-73.
- Verstrepen, L., Carpentier, I., Verhelst, K., and Beyaert, R. (2009). ABINs: A20 binding inhibitors of NF-kappa B and apoptosis signaling. *Biochem Pharmacol* *78*, 105-114.
- Vigorito, E., Perks, K.L., Abreu-Goodger, C., Bunting, S., Xiang, Z., Kohlhaas, S., Das, P.P., Miska, E.A., Rodriguez, A., Bradley, A., *et al.* (2007). microRNA-155 regulates the generation of immunoglobulin class-switched plasma cells. *Immunity* *27*, 847-859.
- Voigt, P., Dorner, M.B., and Schaefer, M. (2006). Characterization of p87PIKAP, a novel regulatory subunit of phosphoinositide 3-kinase gamma that is highly expressed in heart and interacts with PDE3B. *J Biol Chem* *281*, 9977-9986.
- von Holleben, M., Gohla, A., Janssen, K.P., Iritani, B.M., and Beer-Hammer, S. (2011). Immunoinhibitory adapter protein Src homology domain 3 lymphocyte protein 2 (SLy2) regulates actin dynamics and B cell spreading. *J Biol Chem* *286*, 13489-13501.
- Wang, D., Stewart, A.K., Zhuang, L., Zhu, Y., Wang, Y., Shi, C., Keating, A., Slutsky, A., Zhang, H., and Wen, X.Y. (2010). Enhanced adaptive immunity in mice lacking the immunoinhibitory adaptor Hacs1. *FASEB J* *24*, 947-956.
- Weaver, B.K., Bohn, E., Judd, B.A., Gil, M.P., and Schreiber, R.D. (2007). ABIN-3: a molecular basis for species divergence in interleukin-10-induced anti-inflammatory actions. *Mol Cell Biol* *27*, 4603-4616.

- Wightman, B., Ha, I., and Ruvkun, G. (1993). Posttranscriptional regulation of the heterochronic gene *lin-14* by *lin-4* mediates temporal pattern formation in *C. elegans*. *Cell* *75*, 855-862.
- Williams, C.M., and Galli, S.J. (2000). The diverse potential effector and immunoregulatory roles of mast cells in allergic disease. *J Allergy Clin Immunol* *105*, 847-859.
- Wu, C., Orozco, C., Boyer, J., Leglise, M., Goodale, J., Batalov, S., Hodge, C.L., Haase, J., Janes, J., Huss, J.W., 3rd, and Su, A.I. (2009). BioGPS: an extensible and customizable portal for querying and organizing gene annotation resources. *Genome Biol* *10*, R130.
- Wymann, M.P., Bjorklof, K., Calvez, R., Finan, P., Thomast, M., Trifilieff, A., Barbier, M., Altruda, F., Hirsch, E., and Laffargue, M. (2003). Phosphoinositide 3-kinase gamma: a key modulator in inflammation and allergy. *Biochem Soc Trans* *31*, 275-280.
- Xu, X., Zhang, D., Lyubynska, N., Wolters, P.J., Killeen, N.P., Baluk, P., McDonald, D.M., Hawgood, S., and Caughey, G.H. (2006). Mast cells protect mice from *Mycoplasma pneumoniae*. *Am J Respir Crit Care Med* *173*, 219-225.
- Yano, H., Nakanishi, S., Kimura, K., Hanai, N., Saitoh, Y., Fukui, Y., Nonomura, Y., and Matsuda, Y. (1993). Inhibition of histamine secretion by wortmannin through the blockade of phosphatidylinositol 3-kinase in RBL-2H3 cells. *J Biol Chem* *268*, 25846-25856.
- Zeller, C., Hinzmann, B., Seitz, S., Prokoph, H., Burkhard-Goettges, E., Fischer, J., Jandrig, B., Schwarz, L.E., Rosenthal, A., and Scherneck, S. (2003). SASH1: a candidate tumor suppressor gene on chromosome 6q24.3 is downregulated in breast cancer. *Oncogene* *22*, 2972-2983.
- Zhu, M., Liu, Y., Koonpaew, S., Granillo, O., and Zhang, W. (2004a). Positive and negative regulation of FcepsilonRI-mediated signaling by the adaptor protein LAB/NTAL. *J Exp Med* *200*, 991-1000.
- Zhu, Y.X., Benn, S., Li, Z.H., Wei, E., Masih-Khan, E., Trieu, Y., Bali, M., McGlade, C.J., Claudio, J.O., and Stewart, A.K. (2004b). The SH3-SAM adaptor HACS1 is up-regulated in B cell activation signaling cascades. *J Exp Med* *200*, 737-747.

7 Abstract

Mast cells (MCs) play an important role in acute inflammatory and allergic immune reactions. The activation of MCs via antigen-mediated triggering of the high-affinity IgE receptor FcεRI causes immediate degranulation and release of preformed mediators from secretory granules, as well as *de novo* synthesis of lipid mediators and cytokines. The regulation of this complex process is crucial for the maintenance of a balanced immune system. Therefore, the goal of this study was to understand the regulatory mechanisms underlying MC activation, in particular the role of adaptor protein SAMSN1 and microRNA miR-155. To this purpose IgE/antigen-mediated MC degranulation was investigated using murine bone marrow-derived mast cells (BMMCs) deficient for either *Samsn1* or *miR-155*.

Murine SAMSN1 (also known as HACS1 or SLY2) is a putative adaptor and scaffold protein, which is predominantly expressed in hematopoietic tissues. *Samsn1* mRNA was shown to be highly expressed in BMMCs, *Samsn1*^{-/-} BMMC development however was normal. Surprisingly, *Samsn1*^{-/-} BMMCs were not impaired in any of the FcεRI-mediated MC activities investigated, including MC degranulation, cytokine production of IL-6 and TNF-α and ERK signaling. Also cell migration towards the c-kit ligand SCF was normal in *Samsn1*^{-/-} BMMCs.

MicroRNAs (miRNAs) are small, single-stranded RNAs that regulate mRNA translation via RNA interference. miRNAs play a role in the maturation, proliferation, differentiation and activation of different immune cells. miR-155 is expressed in a number of immune cell types and regulates targets such as SHIP1, which is also known to control mast cell degranulation.

miR-155^{-/-} BMMCs proliferated and differentiated normally and their protease content and activity was comparable to wild-type (WT) BMMCs. Functionally, *miR-155*^{-/-} BMMCs exhibited significantly enhanced degranulation in response to FcεRI-triggering both by measurement of β-hexosaminidase release and surface expression of LAMP1 as well as increased TNF-α and IL-6 secretion. Furthermore, *miR-155*^{-/-} BMMCs displayed higher expression of phosphoinositide 3-kinase gamma (PI3Kgamma) subunits *Pik3r5* (*p101*) and *Pik3r6* (*p84*, *p87*^{PIKAP}) mRNA as well as PIK3R5 protein compared to WT BMMCs, which correlated with an increased activation of AKT upon antigen stimulation of BMMCs.

Together, these results strongly suggest that miR-155 has a critical role in FcεRI-mediated MC degranulation and cytokine release by modulating the expression of adaptor proteins belonging to the PI3Kgamma pathway.

8 Zusammenfassung

Mastzellen (MZ) spielen eine wichtige Rolle in entzündlichen und allergischen Immunreaktionen. Durch die Bindung von Antigen an den hochaffinen IgE-Rezeptor FcεRI auf der Mastzelloberfläche wird eine Mastzellaktivierung eingeleitet. Dies führt zur sofortigen Degranulation und Freisetzung von präformierten Mediatoren aus den Mastzellgranula sowie zur Neusynthese von Lipidmediatoren und Zytokinen. Eine strenge Regulation dieses komplexen Prozesses ist essentiell um das Immunsystem im Gleichgewicht zu halten. Das Ziel dieser Arbeit war daher, die regulatorischen Mechanismen der Mastzellaktivierung besser zu verstehen und dabei die Rolle des Adapterproteins SAMSN1 und der microRNA miR-155 zu untersuchen. Zu diesem Zweck wurde die Antigen-vermittelte Mastzelldegranulation in Knochenmark-differenzierten MZ von *Samsn1*- und *miR-155*-defizienten Mäusen untersucht.

SAMSN1 (auch HACSI, SLY2) ist ein Adapter- und Gerüstprotein, welches hauptsächlich in hämatopoietischen Geweben exprimiert wird. MZ exprimieren große Mengen an *Samsn1* mRNA, wobei die Entwicklung von *Samsn1*^{-/-} MZ unverändert war. Überraschenderweise waren FcεRI-vermittelte Funktionen wie Degranulation, Zytokinproduktion von IL-6 und TNF-α und ERK-Signalgebung in *Samsn1*^{-/-} MZ nicht beeinträchtigt. Ebenso war die SCF-vermittelte Migration von *Samsn1*^{-/-} MZ nicht verändert.

MicroRNAs (miRNAs) sind kurze, einzelsträngige RNAs, die die Translation von mRNA via RNA-Interferenz regulieren. miRNAs sind wichtig für die Reifung, Proliferation, Differenzierung und Aktivierung verschiedener Immunzellen. miR-155 ist in einer Vielzahl von Immunzellarten exprimiert und reguliert Proteine wie SHIP1, welches die Mastzelldegranulation kontrolliert.

miR-155^{-/-} MZ proliferierten und entwickelten sich normal und ihr Gehalt an Proteasen sowie deren Aktivität war vergleichbar mit Wildtyp-MZ. Funktionell zeigten *miR-155*^{-/-} MZ eine signifikant gesteigerte FcεRI-vermittelte Degranulation, was sowohl durch Messung der β-Hexosaminidase-Freisetzung als auch der LAMP1 Oberflächenexpression bestimmt wurde und einen Anstieg in der TNF-α- und IL-6-Sekretion. Zudem exprimierten *miR-155*^{-/-} MZ mehr mRNA der Phosphoinositid-3-Kinase gamma (PI3Kgamma)-Untereinheiten *Pik3r5* (*p101*) und *Pik3r6* (*p84*, *p87*^{PIKAP}) sowie mehr PIK3R5 Protein, was mit einer gesteigerten Aktivierung von AKT nach Antigenstimulation korreliert.

Zusammengefasst weisen die hier gezeigten Ergebnisse darauf hin, dass miR-155 eine entscheidende Rolle in der FcεRI-vermittelten Degranulation und Zytokinfreisetzung spielt, welche durch die Modulation der Untereinheiten des PI3Kgamma Signalwegs vermittelt wird.

9 Appendix

9.1 Vector map

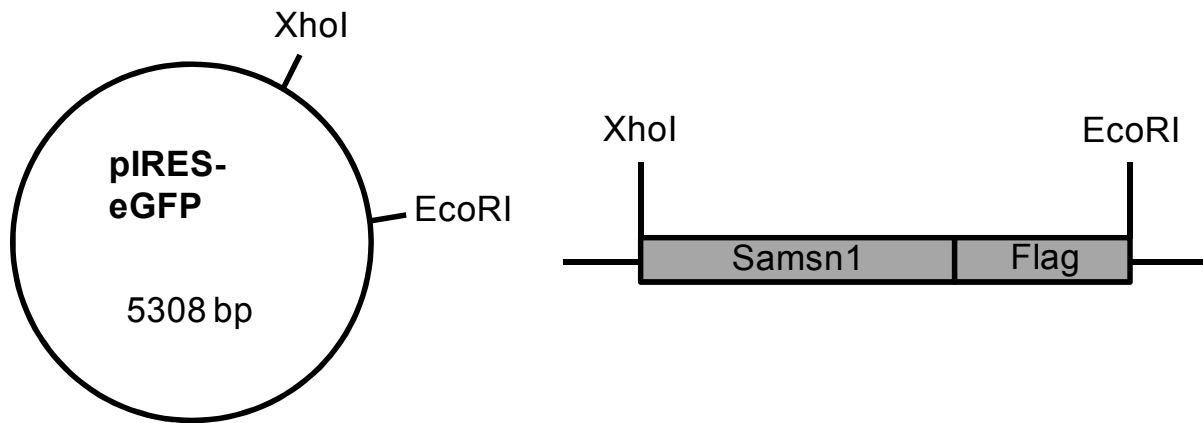

Figure 9-1 Vector map of pIRES2-EGFP vector and Samsn1-Flag insert.

9.2 Sequence of Samsn1-Flag-pIRES2-EGFP construct

```

TAGTTATTAATAGTAATCAATTACGGGGTCATTAGTTCATAGCCCATATATGGAGTTCGCGTTACATAACTTACGGTAAATG
GCCCCCTGGCTGACCGCCCAACGACCCCCGCCATTGACGTCAATAATGACGTATGTTCCCATAGTAACGCCAATAGGGACT
TTCCATTGACGTCAATGGGTGGAGTATTTACGGTAAACTGCCACTTGGCAGTACATCAAGTGTATCATATGCCAAGTACGCC
CCCTATTGACGTCAATGACGGTAAATGGCCCCCTGGCATTATGCCAGTACATGACCTTATGGGACTTTCCTACTTGGCAGT
ACATCTACGTATTAGTCATCGCTATTACCATGGTGATGCGGTTTTGGCAGTACATCAATGGGCGTGGATAGCGGTTTGACTCA
CGGGGATTTCCAAGTCTCCACCCCATGACGTCAATGGGAGTTTTGTTTTGGCACAAAATCAACGGGACTTTCAAAATGTGCG
TAACAACCTCCGCCCATGACGCAATGGGCGGTAGGCGTGTACGGTGGGAGGTCTATATAAGCAGAGCTGGTTTTAGTGAACC
GTCAGATCCGCTAGCGCTACCGGACTCAGATCTCGAGCACAACCATGCTAAAGAGGAAGCCATCCAATGCCTCAGACAAGGAG
AAACACCAAAAACCGAAGCGCAGCAGCAGTTTTGGGAATTTTGACCGTTTTCGGAATAATTCCGTATCAAAATCTGATGACTC
AATTGAGGTCCATGACAGGGAACGACAAATGGAAGTGAAGAACAAGCAAGACTTCAAGCAGTGGAGGAAGTCTAGGTAAAA
AAGTGAGGGCTATTTTCATGGACAATGAAGAAAAAGTAGGAAAAAATACATCAAAGCTTTTCTGAGGAAAAAGAGGAAGAA
AGTGAGAGGAAGCCCTCCCATATCGGAACAGTGATCCCATGATTGGAACACATACAGAGAAGATCTCACTCAAAGCCAGCGA
CTCTATGGACAGTCTTTACAGTGGGCAGAGTTCATCAAGTGAATAACAAGCTGTTTCAGATGGAACAAGTAATCGGGACAGCT
TCCGACTGGATGATGACAGCCCCTACTCAGGGCCATTCTGTGGCCGGGCCAAAGTGCACACAGACTTCAGCCAAGTCCCTAT
GACACCGACTCCCTTAAAATCAAGAAAGGAGACATCATAGACATTATCTGCAAAACACCAATGGGAATGTGGACAGGGATGCT
GAACAATAAAGTGGGAAACTTCAAATTTATTTATGTGGATGTTATCTTAGAAGAGGAAGCAGCTCCTAAGAAGATAAAGTCC
CCAGAAGCAGGAGAAGAGAGAACCACCAGACTATCCAGGAGTTCCTTAGAGAGGATTCACCTTCAGGAATACACTTCAACACTT
CTGCTTAATGGCTATGAGACCCTGGATGACTTGAAGGATATCAAAGAAAGTTCATCTCATTGAATTAACATTGCAGATCCAGA
AGACAGGGCGAGGCTGCTGTCTGCTGCCGAGAGTCTCCTGGATGAAGAAACCACTGTAGAACATGAAAAGGAATCCGTGCCTC
TATCTCAAACCCAGACATCTTGAGTGCATCACAGCTAGAGGACTGCCCGAGGGACTCTGGCTGTTATATCTCATCGGAAAAAC
TCAGATAATGGCAAGGAAGATCTGGAGTCAGAAAATCTGTCTGACATGGTGCAGAAGATTGCCATCACAGAATCCAGTGACGA
CTACAAGGACGACGATGACAAGTGAATTTCTGCAGTCGACGGTACCGCGGGCCCGGGATCCGCCCTCTCCCTCCCCCCCCCT
AACGTTACTGGCCGAAGCCGCTTGGAAATAAGGCCGGTGTGCGTTTTGTCTATATGTTATTTTCCACCATATTGCCGTCTTTTGG
CAATGTGAGGGCCCCGAAACCTGGCCCTGTCTTCTTGACGAGCATTCCTAGGGGTCTTCCCCTCTCGCCAAAGGAATGCAAG
GTCTGTTGAATGTCGTGAAGGAAGCAGTTCCTCTGGAAGCTTCTTGAAGACAAACAACGTCTGTAGCGACCCTTTGCAGGCAG
CGGAACCCCCACCTGGCGACAGGTGCCTCTGCGGCCAAAAGCCACGTGTATAAGATACACCTGCAAAGCGGCACAAACCCCA

```

GTGCCACGTTGTGAGTTGGATAGTTGTGGAAAGAGTCAAATGGCTCTCCTCAAGCGTATCAACAAGGGGCTGAAGGATGCC
AGAAGGTACCCCATTTGATGGGATCTGATCTGGGGCTCGGTGCACATGCTTTACATGTGTTTAGTCGAGGTTAAAAAACGT
CTAGGCCCCCGAACCACGGGGACGTGGTTTTCTTTGAAAAACACGATGATAATATGGCCACAACCATGGTGAGCAAGGGCG
AGGAGCTGTTACCGGGGTGGTGCCATCCTGGTCGAGCTGGACGGCAGCTAAACGGCCACAAGTTCAGCGTGTCCGGCGAG
GGCGAGGGCGATGCCACCTACGGCAAGCTGACCCCTGAAGTTCATCTGCACCACCGCAAGCTGCCCGTGCCTGGCCACCCCT
CGTGACCACCTGACCTACGGCGTGCAGTGTTCAGCCGCTACCCCGACCACATGAAGCAGCAGACTTCTTCAAGTCCGCCA
TGCCCGAAGGCTACGTCCAGGAGCGCACCATCTTCTTCAAGGACGACGGCAACTACAAGACCCGCGCCGAGGTGAAGTTCGAG
GGCGACACCCTGGTGAACCGCATCGAGCTGAAGGGCATCGACTTCAAGGAGGACGGCAACATCCTGGGGACAAGCTGGAGTA
CAACTACAACAGCCACAACGTCTATATCATGGCCGACAAGCAGAAGAACGGCATCAAGGTGAAGTTCAGATCCGCCACAACA
TCGAGGACGGCAGCGTGCAGCTCGCCGACCCTACCAGCAGAACACCCCATCGGGCAGCGCCCGTGTGCTGCCCGACAAC
CACTACCTGAGCACCAGTCCGCCCTGAGCAAAGACCCCAACGAGAAGCGCGATCACATGGTCTGTGGAGTTCGTGACCCG
CGCCGGGATCACTCTCGGCATGGACGAGCTGTACAAGTAAAGCGGCCGCGACTCTAGATCATAATCAGCCATACCACATTTGT
AGAGGTTTTACTTGTCTTAAAAACCTCCACACCTCCCCCTGAACCTGAAACATAAAATGAATGCAATTTGTTGTTAACT
TGTTTATTGCAGCTTATAATGGTTACAAAATAAGCAATAGCATCACAAATTTACAAAATAAAGCATTTTTTTCACTGCATTCT
AGTTGTGGTTTTGTCCAAACTCATCAATGTATCTTAAGCGTAAATTTGTAAGCGTAAATATTTTGTAAAAATTCGCGTTAAAT
TTTTGTAAATCAGCTCATTTTTTAAACCAATAGGCCGAAATCGGCAAAATCCCTTATAAATCAAAAGAATAGACCGAGATAGGG
TTGAGTGTGTTCCAGTTTGAACAAGAGTCCACTATTAAGAACGTGGACTCCAACGTCAAAGGGCGAAAAACCGTCTATCA
GGCGATGGCCACTACGTGAACCATCACCTAATCAAGTTTTTTGGGGTCGAGGTCCGTAAAGCACTAAATCGGAACCCTA
AAGGGAGCCCCGATTTAGAGCTTGACGGGAAAGCCGGCAACGTGGCGAGAAAGGAAGGAAGAAAGCGAAAGGAGCGGGC
GCTAGGGCGCTGGCAAGTGTAGCGGTACGCTGCGCGTAAACCACACACCCGCGCGCTTAATGCGCCGCTACAGGGCGCGT
AGGTGGCACTTTTCGGGAAATGTGCGCGAACCCTATTTGTTTATTTTCTAAATACATTCAAATATGTATCCGCTCATGA
GACAATAACCTGATAAATGCTTCAATAATATTGAAAAAGGAAGAGTCTGAGGGCGAAAGAACCAGCTGTGGAATGTGTGTC
AGTTAGGGTGTGGAAAGTCCCAGGCTCCCAGCAGGCAAGATGCAAAGCATGCATCTCAATTAGTCAGCAACCAGTCCCGCCCTAAC
GGAAAGTCCCAGGCTCCCAGCAGGCAAGATGCAAAGCATGCATCTCAATTAGTCAGCAACCATAGTCCCGCCCTAAC
TCCGCCCATCCCAGCCCTAACTCCGCCAGTTCCGCCATTCTCCGCCCATGGCTGACTAATTTTTTTTTTATTTATGCAGAGG
CCGAGGCCCTCGGCTCTGAGCTATCCAGAAGTAGTGAGGAGGCTTTTTTGGAGGCTAGGCTTTTGCAAAGATCGATCA
AGAGACAGGATGAGGATCGTTTTCGCATGATTGAACAAGATGGATTGCACGCAGGTTCTCCGGCCGCTTGGGTGGAGAGGCTAT
TCGGCTATGACTGGGCACAACAGACAATCGGCTGCTCTGATGCCCGCTGTTCCGGCTGTGACGCGAGGGGCGCCCGTTCTT
TTTTGTCAAGACCGACTGTCCGGTGCCTGAATGAACTGCAAGACGAGGCGAGCGCGCTATCGTGGCTGGCCACGACGGCGT
TCCTTGCGCAGCTGTGCTCGACGTTGTCACTGAAGCGGGAAGGGACTGGCTGCTATTGGGCGAAGTGCCGGGGCAGGATCTCC
TGTCATCTCACCTGTCTCTGCGAGAAAAGTATCCATCATGGCTGATGCAATGCGGCGGCTGCATACGCTTGATCCGGCTACC
TGCCCATTCGACCACAAGCGAAACATCGCATCGAGCGAGCAGTACTCGGATGGAAGCCGGTCTTGTGATCAGGATGATCT
GGACGAAGAGCATCAGGGGCTCGCGCCAGCCGAAGTTCGCCAGGCTCAAGGCGAGCATGCCCGACGGCGAGGATCTCGTCG
TGACCCATGGCGATGCCTGCTTGCCGAATATCATGGTGGAAAATGGCCGCTTTTCTGGATTTCATCGACTGTGGCCGGCTGGGT
GTGGCGGACCGCTATCAGGACATAGCGTTGGCTACCCGTGATATTGCTGAAGAGCTTGGCGGCAATGGGCTGACCGCTTCT
CGTGTCTTACGGTATCGCGCTCCCGATTGCGAGCGCATCGCCTTCTATCGCCTTCTTGACGAGTCTTCTGAGCGGGACTCT
GGGTTTCGAAATGACCGACCAAGCGACGCCAACCTGCCATCACGAGATTTGATTCACCGCCGCTTCTATGAAAGGTTGG
GCTTCGGAATCGTTTTCCGGGACCGCGCTGGATGATCCTCCAGCGCGGGGATCTCATGCTGGAGTCTTCCGCCACCCTAGG
GGGAGGCTAACTGAAACACGGAAGGAGACAATACCGGAAGGAACCCGCGCTATGACGGCAATAAAAAGACAGAATAAAACGCA
CGGTGTTGGGTCGTTTGTTCATAAACCGGGGTTCCGGTCCCAGGGCTGGCACTCTGTCGATACCCACCGAGACCCCATGGG
GCCAATACGCCCGCTTTCTTCTTTTCCCCACCCACCCCAAGTTCGGGTGAAGGCCAGGGCTCGCAGCCAACGTCGGG
GCGGACGGCCCTGCCATAGCCTCAGGTTACTCATATATACTTTAGATTGATTTAAACTTCATTTTTTAAATTTAAAAGGATCTA
GGTGAAGATCCTTTTTGATAATCTCATGACCAAAATCCCTAACGTGAGTTTTTCGTTCCACTGAGCGTCAGACCCCGTAGAAA
AGATCAAAGGATCTTCTTGAGATCCTTTTTTCTGCGGTAATCTGCTGCTTGCAAACAAAAAACCACCGCTACCAGCGGTG
GTTTTGTTGCCGGATCAAGAGCTACCAACTCTTTTTCCGAAGGTAACGGCTTCAGCAGAGCGCAGATACCAAATACTGTCT
TCTAGTGTAGCCGTAGTTAGGCCACCACTTCAAGAACTCTGTAGCACCGCTACATACCTCGCTCTGCTAATCCTGTTACCAG
TGGCTGCTGCCAGTGGCGATAAGTCGTGCTTACCAGGTTGGACTCAAGACGATAGTTACCGGATAAGGCGCAGCGGTCCGGC
TGAACGGGGGGTTCGTGCACACAGCCAGCTTGGAGCGAACGACCTACACCGAAGTGAAGATACCTACAGCGTGAGCTATGAGA
AAGCGCCACGCTTCCCGAAGGGAGAAAGGCGGACAGGTATCCGGTAAGCGGCGAGGGTCGGAACAGGAGAGCGCACGAGGGGAGC
TTCCAGGGGGAAACGCTGGTATCTTTATAGTCTGTCCGGTTTTCCGCCACCTCTGACTTGAGCGTGCATTTTTGTGATGCTCG
TCAGGGGGGCGGAGCCTATGAAAAACGCCAGCAACCGCGCTTTTTACGGTTCTGGCCTTTTGCTGGCCTTTTGCTCACAT
GTTCTTCTGCGTTATCCCCTGATTTCTGTGGATAACCGTATTACCGCCATGCAT

Acknowledgements

Diese Doktorarbeit wäre ohne die Hilfe und Unterstützung von vielen Menschen nicht zustande gekommen. Dafür möchte ich mich im Folgenden bei allen Beteiligten ganz herzlich bedanken.

Besonderer Dank gilt Frau Prof. Silvia Bulfone-Paus für die Überlassung dieses vielseitigen und spannenden Themas sowie für die hervorragende Betreuung und das mir entgegengebrachte Vertrauen. Ihre Fähigkeit, mich immer wieder für wissenschaftliche Zusammenhänge zu begeistern, gab mir auch in schwierigen Phasen dieser Arbeit neue Motivation.

Großer Dank gilt Dr. Niko Föger für die intensive Betreuung im Labor, für sein offenes Ohr und für Rat und Tat in allen Dingen des Laboralltags. Seine Hilfsbereitschaft und die kritischen Diskussionen haben maßgeblich zum Gelingen dieser Arbeit beigetragen.

Allen Mitarbeitern der Arbeitsgruppe Immunbiologie danke ich für die gute Arbeitsatmosphäre und die Hilfsbereitschaft. Den technischen Assistenten danke ich für ihre Unterstützung insbesondere während der Endphase dieser Arbeit.

Ganz besonders herzlich möchte ich Rabea Langenhaun, Dr. Rajia Bahri und Dr. Orietta D'Orlando danken. Ohne ihre Hilfe, die gute Atmosphäre in unserem Büro und die vielen Gespräche – sowohl fachlich als auch privat – sowie reichlich Kaffee und Kuchen wäre diese Zeit nicht halb so schön gewesen.

Dr. Martin Ernst gilt großer Dank für die Hilfe bei der statistischen Auswertung der Daten und für die kritische Beratung zur Fertigstellung dieser Arbeit.

Dr. Sandra Beer-Hammer und Prof. Dr. Klaus Pfeffer (Universität Düsseldorf) danke ich für die *Samsn1*^{-/-} Mäuse und Dr. Elena Vigorito (Babraham Institute, Cambridge) für die Bereitstellung der Knochen von *miR-155*^{-/-} Mäusen.

Das größte Dankeschön aber geht an meine Familie und meinen Mann! Ohne ihre Unterstützung in allen Lebenslagen und ihre unendliche Geduld mit mir wäre es um einiges schwerer geworden, bis hierher zu kommen.

Eidesstattliche Erklärung

Hiermit erkläre ich an Eides statt, dass ich die vorliegende Arbeit nach den Regeln guter wissenschaftlicher Praxis selbständig verfasst und keine weiteren als die darin angegebenen Quellen und Hilfsmittel verwendet habe. Dabei habe ich keine Hilfe außer der wissenschaftlichen Beratung durch meine Doktormutter Prof. Silvia Bulfone-Paus in Anspruch genommen. Diese Arbeit hat weder in gleicher noch in ähnlicher Form an anderer Stelle im Rahmen eines Prüfungsverfahrens vorgelegen.

Kiel, den 19.07.2011

Katharina Biethahn