

Aus dem Institut für Tierzucht und Tierhaltung  
der Agrar- und Ernährungswissenschaftlichen Fakultät  
der Christian-Albrechts-Universität zu Kiel

---

The technical  
development and application of a  
recirculating aquaculture respirometer system  
(RARS)  
for fish metabolism studies

Dissertation

zur Erlangung des Doktorgrades

der Agrar- und Ernährungswissenschaftlichen Fakultät

der Christian-Albrechts-Universität zu Kiel

vorgelegt von

Diplom-Biologe

Kevin Torben Stiller

aus Kiel

Kiel, 2016

---

Dekan: Prof. Dr. Eberhard Hartung

Erster Berichterstatter: Prof. Dr. Carsten Schulz

Zweiter Berichterstatter: Prof. Dr. Ulfert Focken

Tag der mündlichen Prüfung: 03.05.2016

---

Die Arbeit wurde vom Ministerium für Wissenschaft, Wirtschaft und Verkehr des Landes Schleswig-Holstein (Projekt-Nr. 122-08-008), von der Innovationsstiftung Schleswig-Holstein (ISH, später IKSH; Projekt-Nr.: 2010-43) und aus dem Zukunftsprogramm Wirtschaft (2007-2013) mit Mitteln des Europäischen Fonds für regionale Entwicklung (EFRE) und Landesmitteln des Ministeriums für Wirtschaft, Arbeit, Verkehr und Technologie des Landes Schleswig-Holstein (Projekt-Nr. 122-13-004) gefördert.

# TABLE OF CONTENTS

<b>GENERAL INTRODUCTION .....</b>	<b>1</b>
<b>1 Aquaculture systems .....</b>	<b>1</b>
<b>2 Fish metabolism .....</b>	<b>3</b>
<b>3 Respirometry.....</b>	<b>5</b>
<b>4 Water quality monitoring.....</b>	<b>7</b>
<b>References .....</b>	<b>10</b>

## CHAPTER 1

<b>A novel respirometer for online detection of metabolites in aquaculture research: evaluation and first applications .....</b>	<b>15</b>
<b>Abstract.....</b>	<b>16</b>
<b>1 Introduction .....</b>	<b>17</b>
1.1 <i>Aquatic respirometry and its application in aquaculture .....</i>	17
1.2 <i>Measurement of dissolved metabolites .....</i>	18
<b>2 Material and methods .....</b>	<b>21</b>
2.1 <i>Description of the respirometer system .....</i>	21
2.1.1 <i>Water recirculation.....</i>	22
2.1.2 <i>Tanks.....</i>	22
2.1.3 <i>Filtration unit and temperature control.....</i>	24
2.1.4 <i>Measurement/control circuit .....</i>	24
2.2 <i>Water metabolite measurements .....</i>	25
2.2.1 <i>CO<sub>2</sub> analyzer response time .....</i>	27
2.3 <i>Respirometry experiments .....</i>	28
2.3.1 <i>Automated measurements in freshwater with rainbow trout .....</i>	28
2.3.2 <i>Automated respirometry in seawater with turbot .....</i>	29
2.4 <i>Data handling and statistics .....</i>	30
<b>3 Results and discussion .....</b>	<b>31</b>
3.1 <i>The importance of accounting for washout .....</i>	31
3.2 <i>Calculating washout-corrected metabolic rates.....</i>	32
3.3 <i>CO<sub>2</sub> analyzer response time .....</i>	35
3.4 <i>Automated measurements in freshwater with rainbow trout .....</i>	36
3.5 <i>Automated measurements in saltwater with turbot .....</i>	37
3.6 <i>Maintenance, utility and limitations.....</i>	38
<b>Acknowledgements .....</b>	<b>40</b>
<b>References .....</b>	<b>40</b>

**CHAPTER 2**

**The effect of carbon dioxide on growth and metabolism in juvenile turbot**

*Scophthalmus maximus* L.....43

**Abstract..... 44**

**1 Introduction ..... 45**

**2 Material and methods ..... 47**

    2.1 *Fish husbandry and respirometer system*..... 47

    2.2 *CO<sub>2</sub> dosing* ..... 49

    2.3 *Growth performance and condition variables*..... 50

    2.4 *Whole body analysis*..... 50

    2.5 *Metabolic data* ..... 51

    2.6 *Statistical analysis*..... 52

**3 Results..... 54**

    3.1 *Water quality*..... 54

    3.2 *Growth and condition*..... 54

    3.3 *Feed intake and conversion*..... 57

    3.4 *Body composition* ..... 57

    3.5 *Metabolic data* ..... 58

**4 Discussion..... 61**

**Acknowledgements ..... 65**

**References ..... 66**

**CHAPTER 3**

**The effect of diet, temperature and intermittent low oxygen on the metabolism of rainbow trout**.....69

**Abstract..... 70**

**1 Introduction ..... 71**

**2 Material and methods ..... 73**

    2.1 *Experimental fish and diets* ..... 73

    2.2 *Chemical analysis of the diet*..... 74

    2.3 *Experimental setup*..... 75

    2.4 *Fish husbandry and respirometer system*..... 76

    2.5 *Growth performance* ..... 77

    2.6 *Metabolic data* ..... 78

    2.7 *Energy budget* ..... 79

    2.8 *Statistical analysis*..... 80

<b>3</b>	<b>Results</b> .....	<b>81</b>
3.1	<i>Water quality variables</i> .....	81
3.2	<i>Growth performance</i> .....	82
3.3	<i>Metabolic variables</i> .....	84
3.3.1	Oxygen.....	84
3.3.2	Ammonia.....	86
3.3.3	Energy budget .....	88
<b>4</b>	<b>Discussion</b> .....	<b>91</b>
<b>5</b>	<b>Conclusion</b> .....	<b>94</b>
	<b>Acknowledgments</b> .....	<b>95</b>
	<b>References</b> .....	<b>95</b>
 <b>GENERAL DISCUSSION</b> .....		<b>101</b>
<b>1</b>	<b>Aquaculture systems</b> .....	<b>102</b>
<b>2</b>	<b>Water quality monitoring</b> .....	<b>104</b>
<b>3</b>	<b>Fish metabolism</b> .....	<b>107</b>
3.1	<i>Protein fuel use</i> .....	107
3.2	<i>Carbohydrate and lipid fuel use</i> .....	108
<b>4</b>	<b>Conclusion</b> .....	<b>110</b>
	<b>References</b> .....	<b>111</b>
<b>SUMMARY</b> .....		<b>115</b>
<b>ZUSAMMENFASSUNG</b> .....		<b>119</b>
<b>ACKNOWLEDGEMENTS</b> .....		<b>123</b>
<b>CURRICULUM VITAE</b> .....		<b>124</b>

# LIST OF TABLES

<b>Table 1-1:</b> Specific features of the measurement devices build in the respirometer system. ....	<b>26</b>
<b>Table 1-2:</b> Comparison of oxygen consumption rates resulting from different calculative methods. Extreme, mean and sum values (n=9) of rainbow trout (153.8 ± 35.9 g) fed two times within a single day at 1.4% BW, at a water temperature of 13.0 ± 0.7 °C. ....	<b>34</b>
<b>Table 2-1:</b> Carbonate chemistry parameters (mean ± SD) of the experiment. Salinity 20 ‰, temperature 17.7 °C.....	<b>49</b>
<b>Table 2-2:</b> Comparison of growth and condition variables of turbot reared for 56 days under three different dissolved CO <sub>2</sub> environments: high (42 mg l <sup>-1</sup> ), medium (26 mg l <sup>-1</sup> ), and low (5 mg l <sup>-1</sup> ). ....	<b>55</b>
<b>Table 2-3:</b> Body composition [% of original substance] and gross energy [MJ kg <sup>-1</sup> ] contents of whole turbot body held under different dissolved carbon dioxide concentrations: high (42 mg l <sup>-1</sup> ), medium (26 mg l <sup>-1</sup> ), and low (5 mg l <sup>-1</sup> ). ....	<b>58</b>
<b>Table 3-1:</b> Nutrient composition, digestible energy, ingredients and chemical composition of the test diets. Pellet size 4 mm. ....	<b>74</b>
<b>Table 3-2:</b> Comparison of growth variables of rainbow trout fed the standard protein (SP; 42.5% crude protein) and the high protein (HP; 49.5% crude protein) diet for three temperature periods.....	<b>83</b>
<b>Table 3-3:</b> Comparison of the effect of diet protein content and post hoc test results on mass specific oxygen consumption [mg kg <sup>-0.8</sup> h <sup>-1</sup> ] of rainbow trout fed a standard protein diet (SP = 42.5% crude protein) and a high protein diet (HP = 49.5% crude protein) under an unmanipulated oxygen (UO) period and a manipulated oxygen (MO) period. Data is divided into the mean values from 10AM-2PM (= day values) and 10PM-2AM (= night values). Day and night data was used from the 5 <sup>th</sup> day of UO and MO period from every temperature phase. ....	<b>85</b>
<b>Table 3-4:</b> Quantitative comparison of the effect of diet protein content of relative protein usage in energy metabolism [%] and post hoc test results of rainbow trout fed a standard protein diet (SP = 42.5% crude protein) and a high protein diet (HP = 49.5% crude protein) at a unmanipulated oxygen (UO) period and a unmanipulated (MO) period as mean of measured values from 10AM-2PM (= day values) and 10PM-2AM (= night values). Day and night data was used from the 5 <sup>th</sup> day of UO and MO period from every temperature phase. ....	<b>87</b>
<b>Table 3-5:</b> Energy budgets (kJ kg <sup>-0.8</sup> day <sup>-1</sup> ) of rainbow trout fed experimental diets intake of rainbow trout fed a standard protein diet (SP = 42.5% crude protein) and a high protein diet (HP = 49.5% crude protein) at a unmanipulated oxygen (UO) period and a manipulated (MO) period as mean of measured values from 12 PM to 6 AM (excluding cleaning in the morning and the period from 4 to 6 PM when the water inflow was downregulated for the MO period). Day and night data was used from the 5 <sup>th</sup> day of UO and MO period from every temperature phase.....	<b>89</b>

# LIST OF FIGURES

<b>Fig. 1:</b> Central cascade of catabolic metabolism of ammonotelic animals; the minor fraction of additional nitrogen waste products are not shown (changed to Müller and Frings, 2009).....	<b>4</b>
<b>Fig. 2:</b> Percent of ammonia (NH <sub>3</sub> ) and ammonium (NH <sub>4</sub> <sup>+</sup> ) as a function of pH (T. F. S. I., 2003). .....	<b>8</b>
<b>Fig. 3:</b> Bjerrum plot: Carbonate fraction (dissolved carbon dioxide (CO <sub>2</sub> ); Bicarbonate HCO <sub>3</sub> <sup>-</sup> and Carbonate CO <sub>3</sub> <sup>2-</sup> ) examples for different temperatures (T), and salinities (S) (Zeebe and Wolf-Gladrow, 2001). .....	<b>9</b>
<b>Fig. 1-1:</b> Plan view of respirometer system: (1) recirculation pump; (2) manometer; (3) water distribution circuit; (4) pressure regulating valve; (5) tank inflow; (6) respirometry tank; and (7) overflow line; (8) sedimentation barrel; (9) sedimentation tank; (10) sump; (11) trickling filter; (12) metabolite sampling circuit from tank; (13) directional valve; (14) sensors; (15) online control unit; (16) main power switch; (17) online control unit; (18) data transfer; (19) temperature circuit pump; (20) heat exchanger; (21) temperature sensors; and (22) water jet pumps. ....	<b>21</b>
<b>Fig. 1-2:</b> Schematic of 250 l respirometry tank and stand: (1) overflow protection; (2) overflow; (3) cover plate; (4) inflow; (5) outflow to measurement section; (6) coupling for flow-generating pump; (7) additional connector port; and (8) drainage outlet (modified drawing of Kunststoff-Spranger). .....	<b>23</b>
<b>Fig. 1-3:</b> Calculated washout time for the 250 l respirometry tanks over the range of possible flow rates [l h <sup>-1</sup> ]. .....	<b>32</b>
<b>Fig. 1-4:</b> The profile of oxygen consumption of rainbow trout for one day using a washout corrected (solid line) versus uncorrected (dashed line) calculative approach. The rainbow trout (mean weight 153.8 ± 35.9 g) were fed a 1.4% BW ration split between 08:00 and 18:00. Water temperature was 13.0 ± 0.7 °C. Each data point is a mean ± SD of 9 replicate tanks. ....	<b>34</b>
<b>Fig. 1-5:</b> Response time of the CO <sub>2</sub> analyzer to a change in dissolved CO <sub>2</sub> concentration. The measured CO <sub>2</sub> concentration was stable (corresponding to 100% span) at 18 to 20 min. The water flow through the equilibrator of the CO <sub>2</sub> analyzer was 3 l min <sup>-1</sup> , sampling rate 30 s per sample, temperature 20 °C and salinity 7‰. The symbols correspond to the time taken to reach 95% and 99% of the total span. ....	<b>35</b>
<b>Fig. 1-6:</b> Diurnal variations (24 h starting 8:00) in oxygen consumption of rainbow trout (mean weight 153.8 ± 35.9 g) fed differing ration sizes (0.7, 1.4, and 2.8% initial body weight per day). Feed was given twice a day at 08:00 and 18:00. The last 8 days were without feeding. Data points are mean ± SD. Solid line is hourly average (n=9); dashed line is daily average (n=216). Water temperature was 13.0 ± 0.7°C. ....	<b>36</b>

- Fig. 1-7:** Diurnal variation (24 h starting 8:00) in metabolic rates of turbot ( $144.0 \pm 22.3$  g) fed to satiation once per day. Metabolic rates given for O<sub>2</sub> consumption (black solid line); relative CO<sub>2</sub> production (see section 2.4 for definition, dashed line) and NH<sub>3</sub> excretion (x 10, solid gray line, measured as total ammonia nitrogen). Feeding time and ration size is defined by symbol 'x'. Each data point is a mean  $\pm$  SD of 3 replicate tanks. pH  $7.37 \pm 0.03$ , salinity  $20.2 \pm 0.8$  ‰, temperature  $17.8 \pm 0.1$  °C.....37
- Fig. 2-1:** Tank schematic (left corner; drawing by Kunststoff-Spranger) and plan view of recirculating aquaculture respirometer system: (1) recirculation pump; (2) manometer; (3) water distribution circuit; (4) pressure regulating valve; (5) tank inflow; (6) tank; (7) overflow line; (8) sedimentation barrel; (9) sedimentation tank; (10) sump; (11) trickling filter; (12) sampling circuit from tank; (13) pipe junction; (14) sensors; (15) temperature circuit pump; (16) heat exchanger; (17) temperature sensors; and (18) water jet pumps (Modified from Stiller et al. (2013)). .....48
- Fig. 2-2:** The biweekly effect of dissolved CO<sub>2</sub> concentration on (a) conditions factor (CF), (b) weight, width and length (mean  $\pm$  SD, n = 42) of turbot. Data points with a symbol are significantly different from data points that do not share the same symbol within the sampling period (p < 0.05). The three CO<sub>2</sub> treatments are high (solid line, 42 mg l<sup>-1</sup>), medium (dashed line, 26 mg l<sup>-1</sup>), and low (dotted line, 5 mg l<sup>-1</sup>). .....55
- Fig. 2-3:** The effect of dissolved CO<sub>2</sub> concentration on SGR versus geometric mean individual weight and also expressed as biweekly period expressed as numbers (2, 4, 6, 8) in the symbols (mean  $\pm$  SD) of turbot. Data points with a symbol are significantly different from data points that do not share the same symbol within the sampling period (p < 0.05). The three CO<sub>2</sub> treatments are high (42 mg l<sup>-1</sup>), medium (26 mg l<sup>-1</sup>), and low (5 mg l<sup>-1</sup>). .....56
- Fig. 2-4:** The effect of dissolved CO<sub>2</sub> concentration on daily feed intake (DFI, black) and feed conversion ratio (FCR, grey), in two week intervals for turbot. Data points with a symbol are significantly different from data points that do not share the same symbol within the sampling period (p < 0.05). The three CO<sub>2</sub> treatments are high (42 mg l<sup>-1</sup>), medium (26 mg l<sup>-1</sup>), and low (5 mg l<sup>-1</sup>). .....57
- Fig. 2-5:** Mean metabolic mass specific total ammonia nitrogen (TAN) excretion rate (gray lines) and mean metabolic mass specific oxygen consumption rate (black lines) of turbot expressed as: mean of two 16 h (weekly measurements; representing approximately 6 PM to 8 AM) measurements at three dissolved CO<sub>2</sub> concentration levels. Values are taken from days (4/5 + 10/11), (16/17 + 25/26), (31/32 + 39/40), (49/50 + 54/55). Data points with a symbol are significantly different from data points that do not share the same symbol within the sampling period (p < 0.05). The three CO<sub>2</sub> treatments are high (42 mg l<sup>-1</sup>), medium (26 mg l<sup>-1</sup>), and low (5 mg l<sup>-1</sup>). .....58



- Fig. 2-6:** Summarized biweekly ammonia quotient (AQ) measurements of turbot over two 16 h (weekly measurements; representing approximately 6 PM to 8 AM) measurements at three dissolved CO<sub>2</sub> concentration levels. Data points with a symbol are significantly different from data points that do not share the same symbol within the sampling period ( $p < 0.05$ ). Values (expressed as biweekly period: 2, 4, 6, 8) are from the measurement periods: days (4/5 + 10/11), (16/17 + 25/26), (31/32 + 39/40), (49/50 + 54/55). The three CO<sub>2</sub> treatments are high (42 mg l<sup>-1</sup>), medium (26 mg l<sup>-1</sup>), and low (5 mg l<sup>-1</sup>). .....59
- Fig. 2-7:** (a), (b) Metabolic mass specific total ammonia nitrogen (TAN) excretion rate (gray lines) and mean metabolic mass specific oxygen consumption rate (black lines) of turbot; and (c), (d) ammonia quotient (AQ) and estimate protein catabolism rate for the final two measurement periods of the trial. The three CO<sub>2</sub> treatments are high (42 mg l<sup>-1</sup>), medium (26 mg l<sup>-1</sup>), and low (5 mg l<sup>-1</sup>). The daily feed intake (DFI) is inset as bars into each figure: high (black), medium (white striped), and low (white dotted). .....61
- Fig. 3-1:** Experimental setup for the three temperature phases (12, 16 and 20 °C). 4 days acclimation, 5 days unmanipulated oxygen (UO) period, 5 days manipulated oxygen (MO) period, 1 day fasting and 1 day weighing / biomass reduction (BM). Arrows indicate the time of down and upregulation of dissolved oxygen saturation during the periods. ....76
- Fig. 3-2:** Dissolved oxygen and total ammonia nitrogen concentrations in the test tanks stocked with rainbow trout fed a standard protein diet (SP = 42.5% crude protein) and a high protein diet (HP = 49.5% crude protein). Data were recorded at three temperatures and under an unmanipulated oxygen period and a manipulated oxygen period. Fasting days are also reported. ....82
- Fig. 3-3:** Metabolisable energy and retained energy (% digestible energy) of rainbow trout fed a standard protein diet (SP = 42.5% crude protein) and a high protein diet (HP = 49.5% crude protein) reared under an unmanipulated oxygen [black bars] and a manipulated oxygen [grey bars] period. Test tanks oxygen concentrations were at: 12 °C = 70%, 16 °C = 60% and 20 °C 50% for both oxygen periods at the day (8 AM to 4 PM). Intermittent low oxygen challenge concentrations at the night (4 PM to 8 PM) in the manipulated oxygen period were at: 12 °C = 50%, 16 °C = 50% and 20 °C = 40%. Presented values were calculated as mean between 12 AM to 6 AM from the 5th day of each oxygen period and experimental temperature. Different superscript letters indicate significant difference between diets (unmanipulated oxygen period: a, b; manipulated oxygen period: α, β). Difference in oxygen period were indicated by an X inserted into the bar ( $p < 0.05$ ). .....90



# GENERAL INTRODUCTION

## 1 Aquaculture systems

In general the methods of aquaculture are differentiated by the type of water supply: ponds, flow-through systems, net cages and recirculating aquaculture systems (RAS). Ponds are usually artificially built, stocked moderately with fish or other animals. They are exposed to the outside conditions and changes due to the environment are difficult to compensate. Flow-through systems like tanks or channels can use river, lake or sea water directly. Stocking densities can be much higher compared to pond production. Influence on the water quality is not possible without high effort. Within these housing channels and tanks a water quality gradient can occur (Borges et al., 2012) and after passing the environment can be severely polluted by feed residues and metabolites. Net cages are used directly in lakes or coastal areas at usually high stocking densities. The net cage production is highly influenced by the surrounding conditions whereas the impact on the environment is comparable to flow-through systems. RAS are production systems in which the production water is biologically and mechanically cleaned with a daily water exchange of usually <10% of the RAS volume. RAS are completely independent from the environment due to technically controlled housing conditions and can achieve high stocking densities (Bostock et al., 2010; Timmons and Ebeling, 2010). The need of suitable water supply, waste water problems, varying production conditions during the year (Enders and Boisclair, 2016) including natural hazards can be reduced with an RAS. Environmental conditions can be held almost constant within a certain range but this requires suitable technology, energy supply and qualified employees.

The most challenging aspects in aquacultural research are: water quality and quantity, feed, diseases, animal welfare and energy demand (Bostock et al., 2010; Boyd and Tucker, 2012; Noble et al., 2012; Summerfelt, 2015; Terjesen et al., 2013; Timmons and Ebeling, 2010).

These variables apply to all aquaculture methods but with slightly different proportions of importance. For all intensive aquaculture production methods a huge industry and many scientists were developing new and innovative technologies that keep aquaculture water as the most important variable in a good state for production purpose (Dalsgaard, 2013; Murray et al., 2014). New online measuring techniques for toxic or other dissolved substances and computer development make it possible to monitor certain water variables online continuously and remotely (Terjesen et al., 2013). Dissolved substances in the rearing water can negatively influence animals either acutely or chronically. In the former, farmers must react immediately to limit damages (Wuertz et al., 2013) whereas in the latter (Moran and Støttrup, 2011) problems may not be recognized, ignored or will be discovered with delay with large consequences. Due to high stocking densities and high feeding rates metabolite accumulation and oxygen depletion, sometimes in combination with suboptimal temperatures, are the main reasons for chronic stress in fish aquaculture. Long-term suboptimal water quality usually firstly decreases feed intake (Wang et al., 2009) resulting in reduced growth. The impact of growth reduction correlates with the intensity of the environmental challenge. The water quality as a key factor gives direct feedback to all the mentioned variables above. Consequently the water monitoring with stable online measuring technology can help to avoid physiologically challenging conditions mostly initiated by fish and bacteria metabolism in RAS and as a conglomerate of environmental factors and fish metabolism in intensive production systems like flow-through systems or net cages.

## 2 Fish metabolism

The stable monitoring systems observe mainly water quality variables that influenced by the fish metabolism. Metabolism is in the broadest sense all the chemical reactions that occur in an organism (Randall et al., 2002). Energy in natural science is generally the ability of a body or system to perform work. Work must always be done when a body is moved over a certain distance (Beinbrech and Penzlin, 2005). Metabolism consists of three components: I. “catabolism” where organic molecules are converted by releasing energy, II. “anabolism” where organic molecules are synthesized consuming energy, and III. “intermediary metabolism” which is used for building or degrading of transitional molecules (Palstra and Planas, 2012). Nearly all living aerobic animals use the same central metabolic pathways to provide the general energy source ATP (adenosine triphosphate) (Jobling, 1994). The “input” or “resources” to power an aerobic organism are feed and oxygen (O<sub>2</sub>) (Eq. 0). The energy sources of ingested feed were converted in oxidative degradation to dischargeable “waste metabolites”, water and usable energy. Waste metabolites in mainly ammonotelic fish are carbon dioxide (CO<sub>2</sub>) and ammonia (NH<sub>3</sub>). However fish generate a minor fraction of urea (~10-15%) additional to a tiny proportion of other nitrogen waste end products in catabolism (Dosdat et al., 1995; Dosdat et al., 1996; France and Kebreab, 2008; Kajimura et al., 2004).

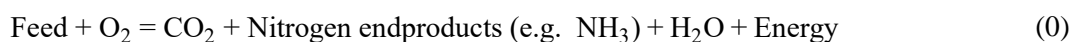

Physiologists can use the information about the input and output variables to evaluate diet processing. The resource feed will be divided into three “primary energy sources”, also called “macro nutrients” or “metabolic fuels (MBF)” (Alsop and Wood, 1997; Lauff and Wood, 1996a, b, 1997). Digestion breaks down the MBF carbohydrates, lipids and proteins using different metabolic pathways to small molecules like mono- and disaccharides, fatty acids,

amino acids and di- and tri-peptides. This happens in the intermediary metabolism so that these molecules can be introduced into a central cascade of energy-releasing catabolism (Fig. 1) which includes three sub-processes: glycolysis, the citric acid cycle and the electron transport chain (Müller and Frings, 2009).

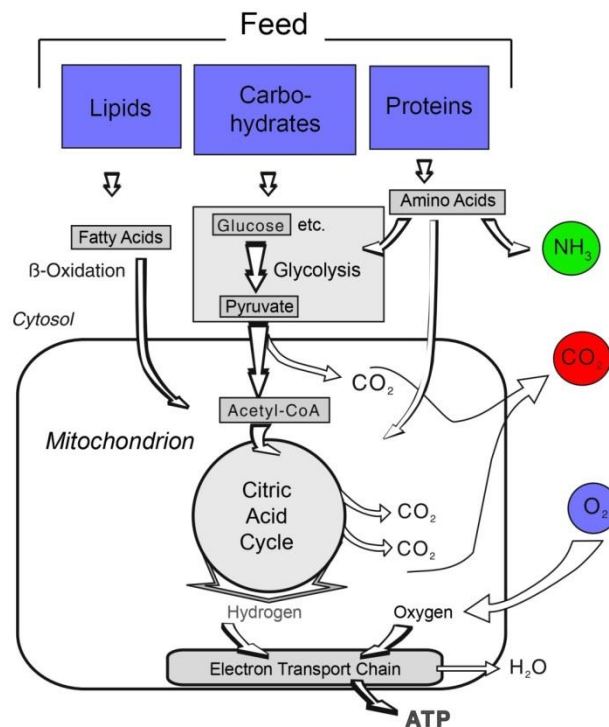

**Fig. 1:** Central cascade of catabolic metabolism of ammonotelic animals; the minor fraction of additional nitrogen waste products are not shown (changed to Müller and Frings, 2009).

Catabolic use of the primary energy sources (MBF) lead to different proportions of consumed and produced molecules (Jobling, 1994). The catabolic proportions of lipids, proteins and carbohydrates of a diet can be evaluated by using the so called “instantaneous method” (Lauff and Wood, 1996a, b, 1997; Magnoni et al., 2013). Here moles of  $\text{CO}_2$  or nitrogen waste products produced (Eq. 0) are normalised to moles of  $\text{O}_2$  consumed which is called respiratory quotient or nitrogen quotient, respectively (Alsop and Wood, 1997). However since the late 1990s the metabolic fuel evaluation by the “instantaneous method” introduced for fish physiology by (Alsop and Wood, 1997; Kiffer et al., 1998; Lauff and Wood, 1996a, b, 1997; Sanz Rus et al., 2000) has not made any significant progress (Magnoni et al., 2013), probably due to difficulties in the precise measurement of the water chemistry.

### **3       Respirometry**

Precise metabolic flux data measurements can be used in special facilities to generate information additional to monitoring thresholds for metabolite accumulation. Measurements of catabolic activity can be done indirectly by quantifying the metabolic flux non-invasively (Gnaiger, 1983; Lampert, 1984) by measuring the gas exchange. This procedure is called respirometry (Lampert, 1984) and can be performed using three methods: “closed”, “intermittent flow” and “flow-through” respirometry (Steffensen, 1989).

For closed respirometry a single aquatic animal is placed into a usually small container which is atmospherically closed with no water exchange. The concentration of oxygen or metabolites is measured before the animal is placed into the container and again after a certain time interval. From the difference the corresponding metabolic rate can be calculated. Due to metabolite accumulation, oxygen depletion and possible handling stress of the animal in the container, closed respirometry is not used anymore.

Flow-through respirometry consists of metabolite concentration measurements at the inflow and outflow of a rearing tank with measuring equipment (respirometer) combined with the water flow rate and tank volume resulting in a mass balance calculation to determine metabolic rates (Ege and Krogh, 1914). Flow-through respirometry can be done continuously and without disturbances for the simulation of fish production conditions (Remen et al., 2013).

Intermittent flow respirometry is a mixture of closed and flow-through respirometry (Svendsen et al., 2016). Such systems are programmed to alternate flushing and closing the oxygenated water supply. The concentration differences between the beginning and the end of each closed interval are used for calculating metabolic rates (Steffensen, 1989). Intermittent flow respirometry is normally used for basic physiological studies (Chabot et al., 2016) and not for experiments comparable to culture conditions where flow-through respirometry is

usually used (Lupatsch et al., 2010) Respirometry under aquaculture like conditions (Lupatsch et al., 2010) is rarely practiced compared to basic physiological research (Nelson, 2016).

In addition to the examination of metabolic fuel use, another useful application of respirometry is the quantification of CO<sub>2</sub> and NH<sub>3</sub> excretion, which is important in recirculation systems where CO<sub>2</sub> needs to be mechanically off-gassed and NH<sub>3</sub> needs to be metabolized in biofilters to maintain water quality. Knowledge of the CO<sub>2</sub> and NH<sub>3</sub> excretion rate can assist sizing of degassing and biofiltration units (Terjesen et al., 2013). The development of large prototype computer controlled RARS for doing physiological studies under culture-like conditions is limited to research institutions at the moment (Sanz Rus et al., 2000; Skov et al., 2015; Tran-Duy et al., 2008). Such systems for nutritional and/or challenging rearing condition studies probably are a good opportunity for R&D departments of feed or fish producers.

Standardized systems are not available and even prototype systems are rare for example the aquatic metabolic unit consisting of 12 tanks of 200 l each (Wageningen, The Netherlands) (Lupatsch et al., 2010; Saravanan, 2013; Tran-Duy et al., 2008). A company in Denmark (Loligo Systems, Tjele, Denmark) provides respiratory equipment for basic physiological studies for aquatic breeders (Chabot et al., 2016; Paltra and Planas, 2012). They usually offer small swim flume respirometers which are generally restricted to DO measurements and not designed for housing fish groups during growth under culture like conditions. The artificial setting of a swim flume for measurements requires some training of the fish to swim in a regular fashion and/or to show their regular behavior (e.g. feeding and social interaction) (Kiffer et al., 1998; Paltra and Planas, 2012). It would be beneficial for basic physiological studies to use NH<sub>3</sub> measurement in combination to DO measurement because fish catabolism is based on protein as a fuel source (Wood, 2001).

Developments of computer and analyzer technology for RAS help to build long-term stable RARS (Lupatsch et al., 2010; Mamun et al., 2013; Saravanan et al., 2013). Here is still huge



potential for improvement of good and easy-to-use probe technologies. Especially nitrogen measurement is promising. It will help to describe the protein catabolism in respirometer systems and will improve nutritional studies.

## **4 Water quality monitoring**

Online monitoring of the fish metabolism variables with probes and analyzers will assist fish production as a suitable  $O_2$  supply is needed and  $CO_2$  and  $NH_3$  are toxic in higher concentrations. For less intensive production facilities spot check measurement via portable meters and chemical test kits are sufficient to preserve the water quality. It seems easy to measure water quality variables as one can buy probes for a lot of applications. However, there are no standard aquaculture online sensors for nitrogen waste products on the market. The few existing analyzers are unpractical and/or expensive. For dissolved  $CO_2$  it is not long ago that the first standard aquaculture meter was described (Moran et al., 2010).

Dissolved oxygen (DO) is relatively easy and affordable to measure (Friehs et al., 2005; Gnaiger and Forstner, 1983; Kramer, 1987; Lampert, 1984) and can be quantified online fast and precisely with amperometric or optical probes (Friehs et al., 2005; Tengberg et al., 2006). For all of the gaseous variables a salinity and temperature dependent solubility in the rearing water has to be considered (Henry's Law). More challenging than DO is the measurement of Ammonia ( $NH_3$ ) because it is influenced by the pH of the rearing water (Fig. 2). The un-ionized  $NH_3$  molecule is considered to be more toxic compared to the ammonium ion ( $NH_4^+$ ) because  $NH_3$  can dissolve freely through cell membranes (Colt, 2006).

There is online measuring equipment available for  $NH_3$ ,  $NH_4^+$  and the sum of both the total ammonia nitrogen (TAN) but not purpose-built for aquaculture (Ozório et al., 2001; Sanz Rus et al., 2000; Zhou and Boyd, 2016). For precise TAN measurements there is still the need to take a water sample and add reagents to induce chemical reactions converting all  $NH_4^+$  to  $NH_3$  for subsequent fluorescence or absorption spectroscopy measurement of the total  $NH_3$  amount

(Dosdat et al., 1996; G lineau et al., 1998; Schneider et al., 2013; Skov et al., 2015; Zhou and Boyd, 2016). In theory by using a precise pH, temperature and salinity measuring system it would be possible to calculate the desired proportion of molecules by knowing only one of the variables (Colt, 2006; Schram et al., 2009).

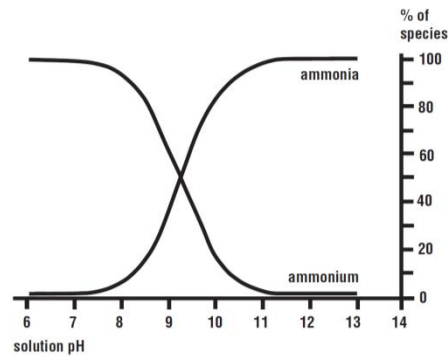

**Fig. 2:** Percent of ammonia ( $\text{NH}_3$ ) and ammonium ( $\text{NH}_4^+$ ) as a function of pH (T. F. S. I., 2003).

Metabolically produced  $\text{CO}_2$  is also very much influenced by water pH (Stumm and Morgan, 1996; Zeebe and Wolf-Gladrow, 2001) (Fig. 3). The sum of all 3 inorganic carbon fractions in the rearing water is the dissolved total inorganic carbon (TIC or DIC) which can be separated in dissolved  $\text{CO}_2$ , bicarbonate ( $\text{HCO}_3^-$ ) and carbonate ( $\text{CO}_3^{2-}$ ) (Dickson et al., 2007; Stumm and Morgan, 1996; Zeebe and Wolf-Gladrow, 2001). When looking at Fig. 3 the fraction of dissolved  $\text{CO}_2$  at a neutral pH is extremely low compared to  $\text{HCO}_3^-$ . The  $\text{CO}_2$  excreted by the fish reacts with water to ions which are present in high concentrations in the water anyway. The dissolved  $\text{CO}_2$  is the molecule that affects fish welfare directly (Fivelstad, 2013; Hjeltnes et al., 2012; Schreckenbach, 2002). In theory by using a precise pH (Abmann et al., 2011, McGraw et al., 2010), temperature and salinity measuring system it would be possible to calculate the desired proportion by measuring only one of the variables additionally (Dickson et al., 2007). The usually high background carbonate content compared to a low fraction of dissolved  $\text{CO}_2$  makes it useful to measure the dissolved  $\text{CO}_2$  concentration. In the recent past the negative impacts of dissolved  $\text{CO}_2$  on fish growth became better understood (Fivelstad, 2013). Therefore, the demand for suitable measuring technology

for aquaculture increased (Borges et al., 2012; Moran et al., 2010; Pfeiffer et al., 2011; Watten et al., 2004). For measuring the dissolved carbon dioxide online there are some technologies available (Atamanchuk et al., 2014; Foss et al., 2003; Holan and Kolarevic, 2015; Pfeiffer et al., 2011; Stiller et al., 2014). Analyzers for aquaculture in most cases use infrared spectroscopy (Moran et al., 2010). These analyzers usually have long response times (Moran et al., 2010) compared to DO probes (Moran et al., 2010, Timmer et al., 2005). More precise dissolved CO<sub>2</sub> analyzers were developed for studying ocean acidification (Jutfelt et al., 2013) but these are designed for measuring CO<sub>2</sub> levels far lower than those observed in an aquaculture facility.

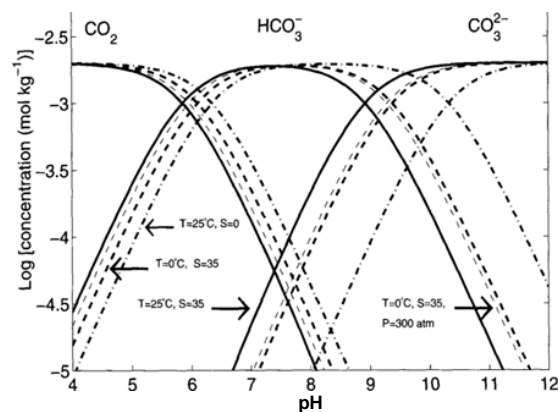

**Fig. 3:** Bjerrum plot: Carbonate fraction (dissolved carbon dioxide (CO<sub>2</sub>); Bicarbonate HCO<sub>3</sub><sup>-</sup> and Carbonate CO<sub>3</sub><sup>2-</sup>) examples for different temperatures (T), and salinities (S) (Zeebe and Wolf-Gladrow, 2001).

In the present thesis high precision analyzer technology is integrated in an online recirculating aquaculture respirometer system (RARS) for studying fish metabolism under challenging aquaculture relevant environmental conditions and the evaluation process of this system is described.

*Chapter 1* clarifies if the installed technologies are suitable for measurements of metabolic rates. *Chapter 2* investigates if chronically elevated CO<sub>2</sub> concentrations have an effect on growth and catabolism of turbot. *Chapter 3* evaluates if a higher dietary protein inclusion has an effect on rainbow trout metabolism and energy budget under intermittent challenging low

O<sub>2</sub> environments and different temperatures. The three chapters broaden our knowledge about the technical functionality of automated RARS to evaluate the bioenergetics of different fish species in challenging aquaculture settings.

## References

- Alsop, D.H., Wood, C.M., 1997. The interactive effects of feeding and exercise on oxygen consumption, swimming performance and protein usage in juvenile rainbow trout (*Oncorhynchus mykiss*). *Journal of Experimental Biology* 200, 2337-2346.
- Aßmann, S., Frank, C., Körtzinger, A., 2011. Spectrophotometric high-precision seawater pH determination for use in underway measuring systems. *Ocean Science* 7, 597-607.
- Atamanchuk, D., Tengberg, A., Thomas, P.J., Hovdenes, J., Apostolidis, A., Huber, C., Hall, P.O., 2014. Performance of a lifetime-based optode for measuring partial pressure of carbon dioxide in natural waters. *Limnology and Oceanography: Methods* 12, 63-73.
- Beinbrech, G., Penzlin, H., 2005. *Lehrbuch der Tierphysiologie*. Elsevier, Spektrum, Akademischer Verlag.
- Borges, M.-T., Domingues, J.O., Jesus, J.M., Pereira, C.M., 2012. Direct and continuous dissolved CO<sub>2</sub> monitoring in shallow raceway systems: from laboratory to commercial-scale applications. *Aquacultural Engineering* 49, 10-17.
- Bostock, J., McAndrew, B., Richards, R., Jauncey, K., Telfer, T., Lorenzen, K., Little, D., Ross, L., Handisyde, N., Gatward, I., 2010. Aquaculture: global status and trends. *Philosophical Transactions of the Royal Society of London B: Biological Sciences* 365, 2897-2912.
- Boyd, C.E., Tucker, C.S., 2012. *Pond aquaculture water quality management*. Springer Science & Business Media.
- Chabot, D., McKenzie, D., Craig, J., 2016. Metabolic rate in fishes: definitions, methods and significance for conservation physiology. *Journal of Fish Biology* 88, 1-9.
- Colt, J., 2006. Water quality requirements for reuse systems. *Aquacultural Engineering* 34, 143-156.
- Dalsgaard, A.J.T., 2013. 2nd Workshop on Recirculating Aquaculture Systems Aalborg, Denmark, 10-11 October 2013: Program and Abstracts. National Institute of Aquatic Resources, Technical University of Denmark.
- Dickson, A.G., Sabine, C.L., Christian, J.R., 2007. *Guide to Best Practices for Ocean CO<sub>2</sub> Measurements*.
- Dosdat, A., Metailler, R., Tetu, N., Servais, F., Chartois, H., Huelvan, C., Desbruyeres, E., 1995. Nitrogenous excretion in juvenile turbot, *Scophthalmus maximus* (L.), under controlled conditions. *Aquaculture Research* 26, 639-650.
- Dosdat, A., Servais, F., Metailler, R., Huelvan, C., Desbruyeres, E., 1996. Comparison of nitrogenous losses in five teleost fish species. *Aquaculture* 141, 107-127.
- Ege, R., Krogh, A., 1914. On the relation between the temperature and the respiratory exchange in fishes. *Internationale Revue der gesamten Hydrobiologie und Hydrographie* 7, 48-55.
- Enders, E., Boisclair, D., 2016. Effects of environmental fluctuations on fish metabolism: Atlantic salmon *Salmo salar* as a case study. *Journal of Fish Biology* 88, 344-358.

- Fivelstad, S., 2013. Long-term carbon dioxide experiments with salmonids. *Aquacultural Engineering* 53, 40-48.
- Foss, A., Røsnes, B., Øiestad, V., 2003. Graded environmental hypercapnia in juvenile spotted wolffish (*Anarhichas minor* Olafsen): effects on growth, food conversion efficiency and nephrocalcinosis. *Aquaculture* 220, 607-617.
- France, J., Kebreab, E., 2008. *Mathematical modelling in animal nutrition*. Cabi international UK.
- Friehs, K., Hitzmann, B., Scheper, T., 2005. 15 Prozessanalytik. *Angewandte Mikrobiologie*, 267.
- Gélineau, A., Corraze, G., Boujard, T., 1998. Effects of restricted ration, time-restricted access and reward level on voluntary food intake, growth and growth heterogeneity of rainbow trout (*Oncorhynchus mykiss*) fed on demand with self-feeders. *Aquaculture* 167, 247-258.
- Gnaiger, E., 1983. Calculation of energetic and biochemical equivalents of respiratory oxygen consumption, Polarographic Oxygen Sensors. Springer, pp. 337-345.
- Gnaiger, E., Forstner, H., 1983 *Polarographic Oxygen Sensors: aquatic and physiological applications*. Springer Science & Business Media.
- Hjeltnes, B., Bæverfjord, G., Erikson, U., Mortensen, S., Rosten, T., Østergård, P., 2012. Risk assessment of recirculating systems in Salmonid hatcheries. Norwegian Scientific Committee for Food Safety.
- Holan, A.B., Kolarevic, J., 2015. Postsmoltproduksjon i resirkulert sjøvann på land. Nofima Rapport 40.
- Jobling, M., 1994. Respiration and metabolism. *Fish Bioenergetics* 8, 121-146.
- Jutfelt, F., de Souza, K.B., Vuylsteke, A., Sturve, J., 2013. Behavioural disturbances in a temperate fish exposed to sustained high-CO<sub>2</sub> levels. *PLOS One* 8, e65825.
- Kajimura, M., Croke, S.J., Glover, C.N., Wood, C.M., 2004. Dogmas and controversies in the handling of nitrogenous wastes: the effect of feeding and fasting on the excretion of ammonia, urea and other nitrogenous waste products in rainbow trout. *Journal of Experimental Biology* 207, 1993-2002.
- Kieffer, J.D., Alsop, D., Wood, C.M., 1998. A respirometric analysis of fuel use during aerobic swimming at different temperatures in rainbow trout (*Oncorhynchus mykiss*). *Journal of Experimental Biology* (Pt 22), 3123-3133.
- Kramer, D.L., 1987. Dissolved oxygen and fish behavior. *Environmental Biology of Fishes* 18, 81-92.
- Lampert, W., 1984. *The measurement of respiration. A manual on methods for the assessment of secondary production in fresh waters*. Blackwell Scientific, 413-468.
- Lauff, R.F., Wood, C.M., 1996a. Respiratory gas exchange, nitrogenous waste excretion, and fuel usage during aerobic swimming in juvenile rainbow trout. *Journal of Comparative Physiology B* 166, 501-509.
- Lauff, R.F., Wood, C.M., 1996b. Respiratory gas exchange, nitrogenous waste excretion, and fuel usage during starvation in juvenile rainbow trout, *Oncorhynchus mykiss*. *Journal of comparative physiology. B, Biochemical, Systemic, and Environmental Physiology* 165, 542-551.
- Lauff, R.F., Wood, C.M., 1997. Effects of training on respiratory gas exchange, nitrogenous waste excretion, and fuel usage during aerobic swimming in juvenile rainbow trout (*Oncorhynchus mykiss*). *Canadian Journal of Fisheries and Aquatic Sciences* 54, 566-571.
- Lupatsch, I., Santos, G., Schrama, J., Verreth, J., 2010. Effect of stocking density and feeding level on energy expenditure and stress responsiveness in European sea bass *Dicentrarchus labrax*. *Aquaculture* 298, 245-250.

- Magnoni, L., Felip, O., Blasco, J., Planas, J., 2013. Metabolic fuel utilization during swimming: optimizing nutritional requirements for enhanced performance, *Swimming Physiology of Fish*. Springer, pp. 203-235.
- Mamun, S.M., Focken, U., Becker, K., 2013. A respirometer system to measure critical and recovery oxygen tensions of fish under simulated diurnal fluctuations in dissolved oxygen. *Aquaculture International* 21, 31-44.
- McGraw, C.M., Cornwall, C.E., Reid, M.R., Currie, K.I., Hepburn, C.D., Boyd, P., Hurd, C.L., Hunter, K.A., 2010. An automated pH-controlled culture system for laboratory-based ocean acidification experiments. *Limnology and Oceanography: Methods* 8, 686-694.
- Moran, D., Støttrup, J., 2011. The effect of carbon dioxide on growth of juvenile Atlantic cod *Gadus morhua* L. *Aquatic Toxicology* 102, 24-30.
- Moran, D., Tirsgård, B., Steffensen, J.F., 2010. The accuracy and limitations of a new meter used to measure aqueous carbon dioxide. *Aquacultural Engineering* 43, 101-107.
- Müller, W., Frings, S., 2009. *Tier-und Humanphysiologie: eine Einführung*. Springer-Verlag.
- Murray, F., Bostock, J., Fletcher, D., 2014. Review of recirculation aquaculture system technologies and their commercial application. *Highlands and Islands Enterprise*. University of Stirling Aquaculture.
- Nelson, J., 2016. Oxygen consumption rate v. rate of energy utilization of fishes: a comparison and brief history of the two measurements. *Journal of Fish Biology* 88, 10-25.
- Noble, C., Kankainen, M., Setälä, J., Berrill, I.K., Ruohonen, K., Damsgård, B., Toften, H., 2012. The bio-economic costs and benefits of improving productivity and fish welfare in aquaculture: utilizing CO<sub>2</sub> stripping technology in Norwegian Atlantic Salmon Smolt production. *Aquaculture Economics & Management* 16, 414-428.
- Ozório, R., Van Eekeren, T., Huisman, E., Verreth, J., 2001. Effects of dietary carnitine and protein energy: nonprotein energy ratios on growth, ammonia excretion and respiratory quotient in African catfish, *Clarias gariepinus* (Burchell) juveniles. *Aquaculture Research* 32, 406-414.
- Palstra, A.P., Planas, J.V., 2012. *Swimming Physiology of Fish: Towards Using Exercise to Farm a Fit Fish in Sustainable Aquaculture*. Springer Science & Business Media.
- Pfeiffer, T.J., Summerfelt, S.T., Watten, B.J., 2011. Comparative performance of CO<sub>2</sub> measuring methods: marine aquaculture recirculation system application. *Aquacultural Engineering* 44, 1-9.
- Randall, D.J., Eckert, R., Burggren, W., French, K., 2002. *Tierphysiologie*. Georg Thieme Verlag.
- Remen, M., Oppedal, F., Imsland, A.K., Olsen, R.E., Torgersen, T., 2013. Hypoxia tolerance thresholds for post-smolt Atlantic salmon: Dependency of temperature and hypoxia acclimation. *Aquaculture* 416, 41-47.
- Sanz Rus, A.S., Enjuto, C, Morales, A.E., Hidalgo, M.C, Garcia-Gallego, M., 2000. Description of a facility for studying energy metabolism in fish: application to aquaculture. *Aquacultural Engineering* 21, 169-180.
- Saravanan, S., Geurden, I., Figueiredo-Silva, A.C., Kaushik, S., Verreth, J., Schrama, J.W., 2013. Voluntary Feed Intake in Rainbow Trout Is Regulated by Diet-Induced Differences in Oxygen Use. *Journal of Nutrition* 143, 781-787.
- Schneider, K., Silverman, J., Kravitz, B., Rivlin, T., Schneider-Mor, A., Barbosa, S., Byrne, M., Caldeira, K., 2013. Inorganic carbon turnover caused by digestion of carbonate sands and metabolic activity of holothurians. *Estuarine, Coastal and Shelf Science* 133, 217-223.

- Schram, E., Verdegem, M.C.J., Widjaja, R.T.O.B.H., Kloet, C.J., Foss, A., Schelvis-Smit, R., Roth, B., Imsland, A.K., 2009. Impact of increased flow rate on specific growth rate of juvenile turbot (*Scophthalmus maximus*, Rafinesque 1810). *Aquaculture* 292, 46-52.
- Schreckenbach, K., 2002. Einfluss von Umwelt und Ernährung bei der Aufzucht und beim Besatz von Fischen. *VDSF-Schriftenreihe Fischerei & Naturschutz* 4, 55-73.
- Skov, P.V., Lund, I., Pargana, A.M., 2015. No evidence for a bioenergetic advantage from forced swimming in rainbow trout under a restrictive feeding regime. *Frontiers in Physiology* 6.
- Steffensen, J.F., 1989. Some errors in respirometry of aquatic breathers: how to avoid and correct for them. *Fish Physiology and Biochemistry* 6, 49-59.
- Stillier, K.T., Moran, D., Vanselow K.H., Schulz C., 2014. Available technologies for CO<sub>2</sub> measurements in RAS. In: Book of Abstracts. Fremtidens Smoltproduksjon (Future smolt production) – Tredje konferanse om resirkulering av ann i akvakultur. Sunndalsøra, Norwegen. p 21.
- Stumm, W., Morgan, J., 1996. *Aquatic chemistry: chemical equilibria and rates in natural waters.* (3rd ed.)Wiley-Interscience, New York, U.S.A.
- Summerfelt, S., Thompson J., McCowan N., 2015. CO<sub>2</sub> Removal and Stripping Column Ventilation Rate at Bell Aquaculture. 3rd NordicRAS Workshop on Recirculating Aquaculture Systems. Molde, Norway, 30 September - 1 October 2015. Book of Abstracts. DTU Aqua Report No. 301-15. National Institute of Aquatic Resources, Technical University of Denmark, 56 pp.
- Svendsen, M., Bushnell, P., Steffensen, J., 2016. Design and setup of intermittent-flow respirometry system for aquatic organisms. *Journal of Fish Biology* 88, 26-50.
- Tengberg, A., Hovdenes, J., Andersson, H.J., Brocandel, O., Diaz, R., Hebert, D., Arnerich, T., Huber, C., Körtzinger, A., Khripounoff, A., 2006. Evaluation of a lifetime-based optode to measure oxygen in aquatic systems. *Limnology and Oceanography: Methods* 4, 7-17.
- Terjesen, B.F., Summerfelt, S.T., Nerland, S., Ulgenes, Y., Fjæra, S.O., Reiten, B.K.M., Selset, R., Kolarevic, J., Brunsvik, P., Bæverfjord, G., 2013. Design, dimensioning, and performance of a research facility for studies on the requirements of fish in RAS environments. *Aquacultural Engineering* 54, 49-63.
- T. F. S. I., 2003. *Manual Orion 95-12 Ammonia Electrode*, Thermo Fisher Scientific Inc., USA, 34.
- Timmer, B., Olthuis, W., Van Den Berg, A., 2005. Ammonia sensors and their applications—a review. *Sensors and Actuators B: Chemical* 107, 666-677.
- Timmons, M.B., Ebeling, J.M., 2010. *Recirculating Aquaculture.* second ed. Cayuga Aquaculture Ventures, Ithaca, New York.
- Tran-Duy, A., Schrama, J.W., van Dam, A.A., Verreth, J.A., 2008. Effects of oxygen concentration and body weight on maximum feed intake, growth and hematological parameters of Nile tilapia, *Oreochromis niloticus*. *Aquaculture* 275, 152-162.
- Wang, T., Lefevre, S., Huong, D.T.T., Van Cong, M., 2009. The effects of hypoxia on growth and digestion. In: Richards, J.J., Brauner, C.J., Farrell, A.P. (Eds.), *Hypoxia. Fish Physiology*, vol. 27. Academic Press/Elsevier, San Diego, California, pp. 361–396.
- Watten, B.J., Boyd, C.E., Schwartz, M.F., Summerfelt, S.T., Brazil, B.L., 2004. Feasibility of measuring dissolved carbon dioxide based on head space partial pressures. *Aquacultural Engineering* 30, 83-101.
- Wood, C.M., 2001. Influence of feeding, exercise, and temperature on nitrogen metabolism and excretion, *Fish Physiology*. Academic Press, pp. 201-238.

- Wuertz, S., Schulze, S., Eberhardt, U., Schulz, C., Schroeder, J., 2013. Acute and chronic nitrite toxicity in juvenile pike-perch (*Sander lucioperca*) and its compensation by chloride. *Comparative Biochemistry and Physiology Part C: Toxicology & Pharmacology* 157, 352-360.
- Zeebe, R.E., Wolf-Gladrow, D.A., 2001. CO<sub>2</sub> in seawater: equilibrium, kinetics, isotopes. Gulf Professional Publishing.
- Zhou, L., Boyd, C.E., 2016. Comparison of Nessler, phenate, salicylate and ion selective electrode procedures for determination of total ammonia nitrogen in aquaculture. *Aquaculture* 450, 187-193.



# CHAPTER 1

## **A novel respirometer for online detection of metabolites in aquaculture research: evaluation and first applications**

Kevin Torben Stiller<sup>abc</sup>, Damian Moran<sup>d</sup>, Klaus Heinrich Vanselow<sup>a</sup>, Kai Marxen<sup>a</sup>, Sven Wuertz<sup>c</sup> and Carsten Schulz<sup>bc</sup>

<sup>a</sup> Forschungs- und Technologiezentrum Westküste der Universität Kiel, Hafentörn 1, 25761 Büsum, Germany

<sup>b</sup> Gesellschaft für Marine Aquakultur, Hafentörn 3, 25761 Büsum, Germany

<sup>c</sup> Institute of Animal Breeding and Husbandry, Christian-Albrechts-University, Olshausenstraße 40, 24098 Kiel, Germany

<sup>d</sup> Department of Biology, Lund University, Soelvegatan 35, S-223 62 Lund, Sweden

<sup>e</sup> Department of Ecophysiology and Aquaculture, Leibniz-Institute of Freshwater Ecology and Inland Fisheries, Müggelseedamm 310, 12587 Berlin, Germany

---

## Abstract

In this study we describe a novel flow-through respirometer with automated and semi-continuous detection of key water variables. The recirculating aquaculture system was designed to house aquatic organisms in culture-like conditions and allow long-term, high-precision measurements. Nine respirometry tanks (250 l in volume each) housed animals, and a tenth (without animals) acted as a reference tank. A single measurement unit made sequential measurements of each tank to eliminate the problem of sensor variation associated with multi-probe setups. The accuracy of the analyzers in relation to measurement range was:  $O_2 = 1\%$ ;  $CO_2 < 1\%$ ;  $NH_3 = 2\%$ ; temperature  $\leq 0.25\%$ ; and  $pH \pm 0.01$ . Dissolved  $CO_2$  was measured using air-water equilibration coupled with non-dispersive infrared detection of carrier gas, and  $NH_3$  was quantified using a reagent-based assay and fluorometric autoanalyzer. Though expensive and not common in aquaculture or physiology research, these two automated metabolite analyzers could operate in both fresh and seawater, and offered high precision and accuracy. We report on the performance of these instruments for aquaculture research in two trials using a freshwater (rainbow trout, *Oncorhynchus mykiss*) and seawater fish species (turbot, *Scophthalmus maximus*). One of the main constraints imposed by the sequential measurement of multiple tanks was the measurement frequency of each tank. In the aforementioned system,  $NH_3$  analysis took the longest (12 min), followed by  $CO_2$  (7 min),  $O_2$  (6 min) and  $pH$  (3 min).

# 1 Introduction

## 1.1 *Aquatic respirometry and its application in aquaculture*

Respirometry is used in aquaculture for a number of purposes. Some examples include non-invasive measurement of animal physiology in response to particular husbandry conditions (e.g. diet, temperature, water quality, stocking density and live transport), the measurement of metabolic fuel use, and the quantification of metabolite flux (i.e. oxygen O<sub>2</sub>, ammonia NH<sub>3</sub> and carbon dioxide CO<sub>2</sub>) to assist with calculations of system carrying capacity. There are only limited options for the purchase of proprietary aquatic respirometer systems, therefore, these units are often custom designed to suit a particular species, body size, and metabolite measurement goal (e.g. Gehrke et al. 1990; Lucas et al. 1993; Mamun et al., 2013; Sanz Rus et al., 2000; Steffensen et al., 1984; van Ginneken et al., 1994). The majority of systems described in the literature have been designed for studying fundamental questions concerning animal physiology. Intermittent flow respirometry using a flume is the preferred method used by fish physiologists to measure metabolic rate due to its precision (Steffensen, 1989), however, the respirometers are typically small (for a single animal) and designed for short-term use (i.e less than a week), with little capacity to feed animals or treat waste production. This approach is not practical for long-term aquaculture studies requiring replicate tanks and holding conditions that allow feeding, removal of waste products and space enough for groups of fish to swim about. Sanz Rus et al. (2000) give a description of a respirometer system for addressing aquaculture research questions, however, the kinds of metabolite probes described had limited resolution and the tank volumes were not particularly large (50 l).

In this paper we report on a novel flow-through respirometer system designed to maximise measurement precision in all water types, while at the same time being large enough for groups of fish to be fed and maintained over several weeks. In flow-through respirometry metabolites are measured at the inflow and outflow while water flows continuously, and when

these variables are combined with water flow rate one can derive metabolic rate (Ege and Krogh, 1914). The so called “washout effect” can complicate the mass balance calculations as it often takes a significant amount of time (hours) for the water to be exchanged in the respirometry tank, and the outflow metabolite concentration may not reflect the metabolic rate of the animal at the time of measurement (Eriksen, 2002). Steffensen (1989) and Eriksen (2002) provide an analyzes of the problems associated with incorrectly applying steady-state mass balance models to respirometry measurements. However, with a suitable numerical correction for the washout effect and the use of appropriately sensitive instruments, a flow-through respirometer system can achieve high levels of precision (Eriksen, 2002). In the present study we address the importance of accounting for the washout effect when calculating metabolic rate, as this correction is often overlooked, particularly in the aquaculture literature.

## ***1.2 Measurement of dissolved metabolites***

During the design and construction of our respirometer system particular attention was paid to the installation of very precise and automated water metabolite measurement equipment. The water metabolite variables measured were O<sub>2</sub>, pH, NH<sub>3</sub> and CO<sub>2</sub>. While the kind of amperometric O<sub>2</sub> electrode we used is common to many respirometer systems (e.g. Mamum et al., 2013; Sanz Rus et al., 2000; Steffensen et al., 1984), pH, and CO<sub>2</sub> were measured using approaches not commonly employed in commercial or research aquaculture. Obtaining accurate (better than 0.1 pH unit) long-term measurements of water pH (i.e. in excess of 1 week) is extremely difficult, especially in saltwater due to the high concentration of ions (Covington and Whitfield, 1988). Standard pH probes quickly start to drift if immersed continuously in saltwater. We used an intermediate junction probe, which has an exchangeable electrolyte bridge between the reference electrolyte and measuring solution.

Clogging effects of the porous ceramic or plastic frit of standard pH probes are significantly reduced when the probe is readily serviceable.

The measurement of  $\text{NH}_3$  and  $\text{CO}_2$  excretion rates from respirometry studies are much less common than  $\text{O}_2$  consumption due to the difficulties in accurately measuring these former metabolites, in particular measuring in an automated fashion and in seawater. Our respirometer system quantified these metabolites using the same equipment ocean chemist's use. Such systems tend to be expensive (in excess of US\$10,000) compared to the traditional methods used by aquaculturists or aquatic physiologists, however, these traditional methods are generally inferior in terms of accuracy, precision and processing time. In our study  $\text{NH}_3$  was measured using an autoanalyzer that takes a water sample and auto-injects reagents to perform a colour reaction, which is subsequently measured spectrophotometrically. This technique is superior to the use of the ion-selective (ISE) or gas sensing ISE combination probes often used in wastewater treatment, as these probes have poor resolution at the comparatively low  $\text{NH}_3$  concentrations encountered under aquatic respirometry.

Dissolved  $\text{CO}_2$  is a particularly difficult metabolite to measure, especially in seawater. Pfeiffer et al. (2011) summarized the advantages and disadvantages of different  $\text{CO}_2$  measurement systems for aquaculture, however, their paper focuses on monitoring threshold limit values and not on respirometry studies. The measurement principle of the  $\text{CO}_2$  analyzer used in our study was air-water equilibration coupled with non-dispersive infrared detection of  $\text{CO}_2$  in a carrier gas. This measurement approach is considerably faster (and more accurate and precise) than a submersible  $\text{CO}_2$  analyzer commonly used in aquaculture (Borges et al., 2012; Moran et al., 2010), which is important for a system that needs to measure 10 tanks repeatedly in as short a time as possible.

The accurate measurement of dissolved  $\text{CO}_2$  is important for studies investigating the effects of this gas on fish welfare (Fivelstad, 2013), a research field that has been often hampered by inaccurate measurements and the reporting of widely varying effect

concentrations (reviewed in Moran and Støttrup, 2011). Measuring dissolved CO<sub>2</sub> accurately not only results in meaningful dose-response studies, but it also allows for the profiling of in-tank CO<sub>2</sub> levels during different husbandry activities. A common misconception (that frequently makes its way into publication) is that by measuring dissolved CO<sub>2</sub> one can calculate the CO<sub>2</sub> excretion rate from aquatic animals. Most of the CO<sub>2</sub> excreted from an aquatic animal will form dissolved carbonates, therefore, one needs to measure total dissolved inorganic carbon to measure CO<sub>2</sub> excretion. As with virtually all other respirometry studies, our system lacked the necessary accuracy and precision in pH measurement to calculate dissolved inorganic carbon. Despite this limitation, the ability to correctly determine dissolved CO<sub>2</sub> in an automated fashion is a particularly novel attribute of the respirometer system described in this paper, and will likely be of general interest as CO<sub>2</sub> is increasingly recognized as a major factor in maintaining the welfare of animals reared in intensively stocked systems. In addition to providing a description of the respirometer system and addressing the importance of accounting for the washout effect when calculating metabolic rate, we present data from two trials (in fresh and seawater) using trout (*Oncorhynchus mykiss*) and turbot (*Scophthalmus maximus*) to evaluate the utility of such a system.

## 2 Material and methods

### 2.1 Description of the respirometer system

The respirometer system was designed as a recirculating system for the same reasons this technology is used in commercial aquaculture, namely, it allows heat conservation in a relatively large volume of water and a high degree of control of water quality. The respirometer system (Fig. 1-1) consists of five basic elements: water recirculation system; 10 respirometry tanks; filtration unit; temperature regulation; measurement/control circuit.

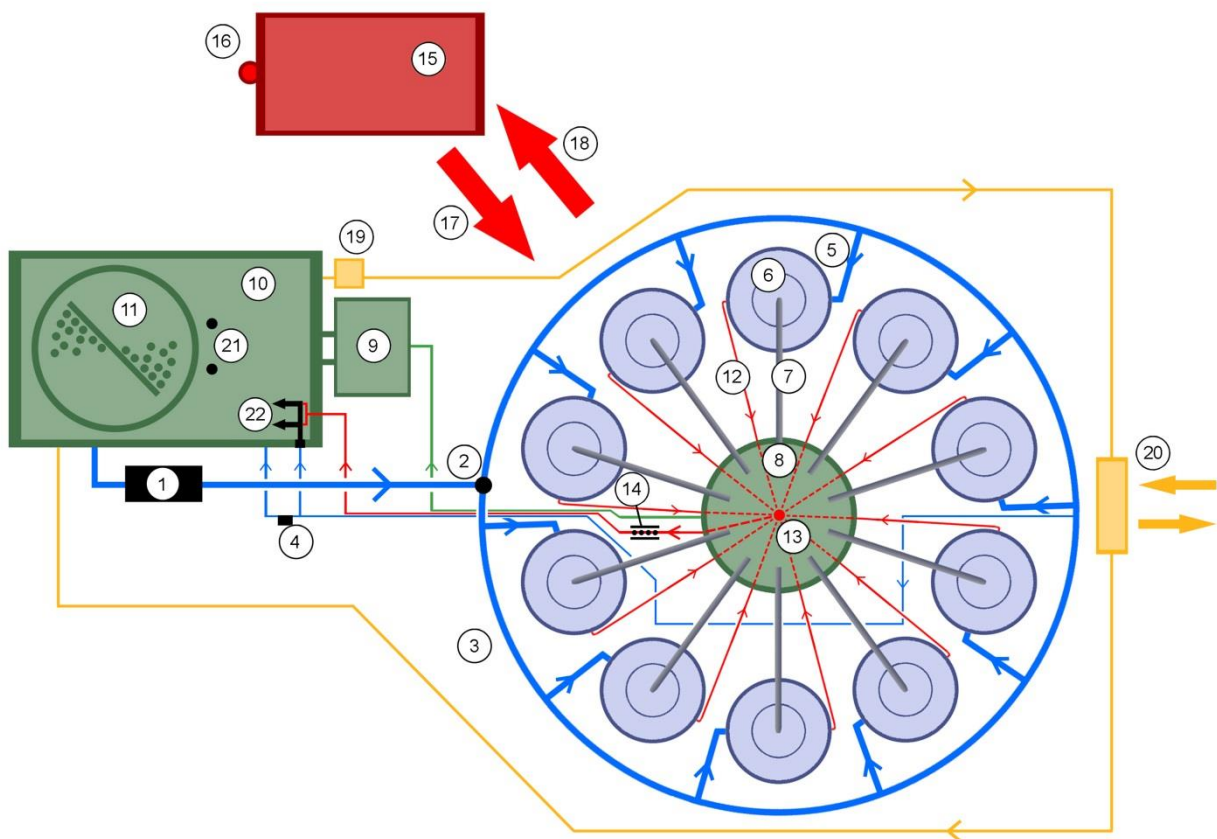

**Fig. 1-1:** Plan view of respirometer system: (1) recirculation pump; (2) manometer; (3) water distribution circuit; (4) pressure regulating valve; (5) tank inflow; (6) respirometry tank; and (7) overflow line; (8) sedimentation barrel; (9) sedimentation tank; (10) sump; (11) trickling filter; (12) metabolite sampling circuit from tank; (13) directional valve; (14) sensors; (15) online control unit; (16) main power switch; (17) online control unit; (18) data transfer; (19) temperature circuit pump; (20) heat exchanger; (21) temperature sensors; and (22) water jet pumps.

### **2.1.1**      *Water recirculation*

Each tank receives filtered water from the circular supply pipeline (Fig. 1-1, No. 3) connected to the inflow of the tanks (Fig. 1-1, No. 5) with a modifiable pressure of 1-2 bar (Fig. 1-1, No. 2, 4). The flow rate (adjustable between 150 - 300 l h<sup>-1</sup>) in all ten tanks is controlled by a PID (proportional-integral-derivative) controller, a proportional valve with valve control unit and a flow meter. A three-phase pump draws from the biofiltration sump to pressurize the delivery circuit (Fig. 1-1, No. 3). Effluent water from each tank is directed to a central sedimentation barrel (Fig. 1-1, No. 8), whereafter it flows under gravity to the filtration unit (Fig. 1-1, No. 9, 10, 11). During a measurement cycle for a given tank a computer controlled solenoid valve opens and directs a portion of the effluent water through the measurement section under gravity (Fig. 1-1, No. 14). After exiting the measurement section the water is directed to the sump of the biofilter (Fig. 1-1, No. 10) via concurrent suction with water from the supply ring overflow by water jet pumps (Fig. 1-1, No. 22).

### **2.1.2**      *Tanks*

The ten circular tanks and stands (total height 2.1 m, Fig. 1-2) were purpose built by Kunststoff-Spranger GmbH (Plauen, Germany). Each PVC tank has a volume of 250 l, with part of the tank made of translucent PVC. The sides and the back are made of opaque PVC in order to avoid visual stressors from the surrounding.



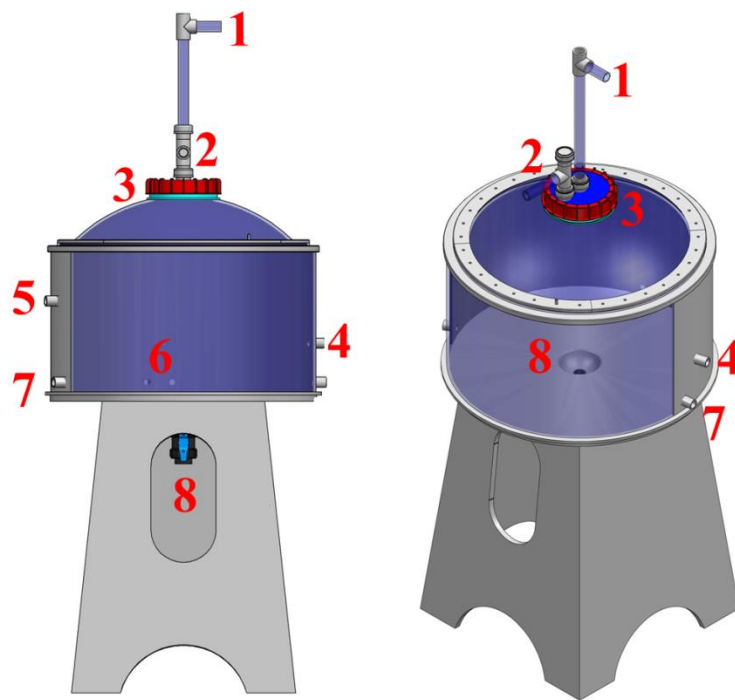

**Fig. 1-2:** Schematic of 250 l respirometry tank and stand: (1) overflow protection; (2) overflow; (3) cover plate; (4) inflow; (5) outflow to measurement section; (6) coupling for flow-generating pump; (7) additional connector port; and (8) drainage outlet (modified drawing of Kunststoff-Spranger).

The tanks are completely enclosed, with a dome-shaped top, and can be accessed via a threaded cover plate (Fig. 1-2, No. 3; 25 cm diameter) on the top of the dome. The influent water enters near the middle of the tank wall (Fig. 1-2, No. 4). The water is directed to the measurement section via a pipe with an intake located in the middle of the tank wall (Fig. 1-2, No. 5), and when measurements are not being made the water exits via the uppermost outlet (Fig. 1-2, No. 2). The influent and effluent outlets are placed in the middle of the tank to ensure the best mixing of water possible. At the back of the tank is an inflow and outflow connection for an external pump to generate a circular flow (Fig. 1-2, No. 6) and help concentrate waste in the central bottom funnel, thereby allowing settled solids to be drained via a ball valve (Fig. 1-2, No. 8). The tank circulation pump can run intermittently to concentrate settled solids, or operate permanently to provide a high level of internal water

circulation for animals which prefer current. Two ports are available on the outside of the tank (Fig. 1-2, No. 7) for the installation of trial-specific peripheral devices. The cover plate is equipped with two openings (Fig. 1-2, No. 1 and 2). In the first opening an overflow pipe (Fig. 1-2, No. 2) is installed which directs surplus water to the sedimentation barrel (Fig. 1-1, No. 8) and back to the sump. A second pipe is installed for feeding the animals and serves as an overflow protection (Fig. 1-2, No. 1). For any given experiment, one of the ten tanks is left empty of fish to act as a reference tank to account for physicochemical and microbial variations in the variables of interest.

### **2.1.3      *Filtration unit and temperature control***

The filtration unit consists of four components: a sedimentation barrel (Fig. 1-1, No. 8); a sedimentation tank (Fig. 1-1, No. 9) with optional mechanical filtration; a 1500 l sump (Fig. 1-1, No. 10) and a cylindrical 500 l trickling filter (Fig. 1-1, No. 11) filled with approximately 350 l of media (NOR-PAC Hochleistungsfüllkörper, Norddeutsche Seekabelwerke GmbH, Nordenham, Germany). Temperature within the system is controlled via a side-loop cooling or heating system (Fig. 1-1, No. 19, 20, 21) connected to the biofilter sump. The cooling bypass circuit is connected to the sump and is driven by a circulating pump (Fig. 1-1, No. 19). Water from the sump is pumped through a titanium plate heat exchanger with control unit (TSC 510; Behncke GmbH, Munich, Germany; Fig. 1-1, No. 20) and the cooled/heated water then passes back into the sump. Two temperature sensors are located in the sump (Fig. 1-1, No. 21). The heat exchanger is connected to the coolant/heating circuit of the entire production facility (Fig. 1-1, No. 20 arrows). The adjustable temperature range is approximately 10 - 35°C.

### **2.1.4      *Measurement/control circuit***

Pipe lengths leading from the tanks to the measurement section are standardized to eliminate dead spaces and ensure the same conditions for comparable readings between tanks. The

measurement unit of the system has five sensors (Fig. 1-1; No. 14): All water quality measurements are performed in the same test section to avoid measurement errors that can arise using multiple probes installed in each tank (van Ginneken et al., 1994). The tanks are measured sequentially via control of the solenoid valves that direct water from the respirometry tanks to the measurement section (flow rate  $3 \text{ l min}^{-1}$ ). The sampling time and the tanks to be measured can be adjusted via the automated control system. Salinity is measured manually via refractometry and inputted into the control computer for salinity compensation of measured variables. The control unit is housed inside a waterproof control cabinet, and is composed of a standard personal computer and all the control and monitoring electronics. The following data are processed and logged by the control unit: a) all data from the water quality measuring sensors; b) data of the flow and PID controllers (flow rates); c) data of the water circulation pressure; and d) trigger information for the sampling valves of the tanks and the trigger for the  $\text{NH}_3$  analyzer. The data for each measured variable can be monitored graphically online. The data communication to the PC is carried out by a process control system (Beckhoff Automation GmbH, Verl, Germany) and a Controller Area Network bus card with associated software (TwinCAT, Beckhoff Automation GmbH). The software used to control, monitor and log data within the system was custom designed and written in C++. A summary of the data is saved in a MySQL database.

## **2.2**      *Water metabolite measurements*

A description of each of the measurement devices is given in Table 1-1.

**Table 2-1:** Specific features of the measurement devices build in the respirometer system.

Sensor	Type	Manufacturer	Measuring principle	Accuracy	Response time	Calibration and maintenance
O <sub>2</sub>	dTRANS O2 01; sensor for long-term online measurements	JUMO GmbH & Co. KG, Fulda, Germany	Amperometric	± 1% of reading	3 min to 90% span (25°C)	Temperature, salinity and pressure compensated recalibration: 7 days <sup>1</sup> .
pCO <sub>2</sub>	(Purpose built) OceanPack pCO <sub>2</sub> RAS – System with Li-840x CO <sub>2</sub> /H <sub>2</sub> O analyzer (LI-COR Biosciences, Nebraska, United States)	SubCtech GmbH, Osdorf, Germany	Air-water equilib. (headspace) coupled with non-dispersive infrared detection of gas with water vapour, pressure, and temperature compensation.	< 1% of reading Full scale: (20°C; 0‰) 34 mg/L (digital, 14 bit) > 34 mg l <sup>-1</sup> (analog; lower accuracy). Example accuracy: ± 0.005 mg l <sup>-1</sup> with measuring 1.7 mg l <sup>-1</sup> range	3.5 min to 95% span, ≤ 7 min to 99% span (20°C; water flow rate ≥ 3 l min <sup>-1</sup> .)	Recalibration is recommended every 12 months, while the internal auto-calibration is performed once per day. Cleaning of the headspace unit depends on the level of suspended solids.
NH <sub>3</sub> <sup>2</sup>	µMac, total ammonia nitrogen loop flow autoanalyzer	SYSTEVA S.p.A., Anagni, Italy	Fluorometric orthophthaldehyde (OPA) (ISO 9001:2008; Certificate number AJAEU/10/121116)	2% of reading Full scale: 1 mg L <sup>-1</sup> Example accuracy: < 0.01 mg L <sup>-1</sup> with measuring 0.4 mg L <sup>-1</sup> range	12 min	A filtration unit reduces the amount of particulates entering the auto-analyzer. Auto recalibration is programmable (typical daily); 2.5 ml reagents consumption; sample volume 22 ml; The analyzer was adapted to our measuring range and speed.
pH	Ionode IJ44 <sup>3</sup>	TPS Pty Ltd, Brisbane, Australia	ISE; intermediate junction probe; glass potentiometric electrode	0.1 - 0.01 pH depending on recalibration frequency possible errors e.g.: clogging effect minimized by intermediate junction; positive ion errors	3 min	KCl gel electrolyte bridge exchanged weekly. For optimal performance under continual immersion manufacturer recommends recalibration hourly. We calibrate weekly. <sup>4</sup>
Temp	201085/16 <sup>3</sup>	JUMO GmbH & Co. KG, Fulda, Germany	PT100	≤ 0.25% of reading	3 min	Calibration by a reference thermometer.

<sup>1</sup> Verified using a daily-calibrated hand-held oxygen meter (Handy Polaris; OxyGuard International, Birkerød, Denmark) and Winkler titration. The probe was found to deviate from the values given by the other methods after 8 days, indicating that a recalibration was necessary at least weekly (Stiller, 2010).

<sup>2</sup> During a measurement cycle the ammonia analyzer receives a signal to obtain a water sample via pumping from the equilibrator of the CO<sub>2</sub> analyzer.

<sup>3</sup> Coupled to an online controller (202530, JUMO GmbH & Co. KG).

<sup>4</sup> We use standard NBS pH calibration buffers, but recognize that these low ionic concentration buffers are not entirely appropriate for pH measurement in seawater. However, the use of NBS buffers is the norm for virtually all aquaculture and physiology studies, and specific calibration buffers are not traceable to the IUPAC definition of pH.

### **2.2.1 *CO<sub>2</sub> analyzer response time***

While the response time of most of the water metabolite analyzers were known from manufacturer information, the response time of the CO<sub>2</sub> analyzer (SubCtech GmbH, Osdorf, Germany) needed to be quantified as the equilibrators were custom built. The main factor determining the response time of the analyzer was the time it took for the gas in the equilibrator headspace to be replaced, and response time was important as this set the minimum time interval required for sequential measurements. The response time was tested at 20°C and a salinity of 7‰ by injecting different flow rates of food grade CO<sub>2</sub> into four tanks using fine pore ceramic diffusers. The CO<sub>2</sub> dosing was controlled via a needle valve and a minimum volume flow meter, and the four CO<sub>2</sub> test concentrations corresponded to 33.01, 15.21, 1.96 and 1.91 mg l<sup>-1</sup>. The ingassing was carried out over several days to allow the system to reach equilibrium between ingassing and degassing. The response time of the analyzer to a higher or lower CO<sub>2</sub> concentration was then tested over 20 min. The CO<sub>2</sub> measurement was found to be stable (i.e. 100% of the span attained) after 18 min. The solubility equation of Weiss (1974) was used to convert the pCO<sub>2</sub> values from the analyzer into dissolved CO<sub>2</sub> values of mg l<sup>-1</sup>.

## 2.3 *Respirometry experiments*

### 2.3.1 *Automated measurements in freshwater with rainbow trout*

The performance of the respirometer system in resolving short time interval O<sub>2</sub> consumption rates between the tanks was investigated by running a two week experiment with rainbow trout fed differing rations. A stable O<sub>2</sub> measurement could be obtained within 6 min, meaning that a measurement cycle for all 10 respirometry tanks took 60 min (24 measurements per tank per day). Besides temperature and pH, O<sub>2</sub> was the only water quality variable measured in this study, as oxygen measurements stabilize more quickly between successive measurements and we were interested in resolving patterns in respiration on short time scales. Sixteen rainbow trout (mean  $\pm$  SD individual weight 153.8  $\pm$  35.9 g) were stocked into each of 9 experimental tanks so that the total fish weight was 2.46  $\pm$  0.05 kg (tank stocking density = 9.6 kg m<sup>-3</sup>). The tank metabolic body weight (MBW) was calculated as (mean fish body weight (BW) (kg))<sup>0.8</sup> x number of fish in the tank (Cho and Kaushik, 1990). The tank flow rates used in this experimental (150 l h<sup>-1</sup>) were calculated on the basis of biomass and estimated respiration rate, with the aim to maintain an O<sub>2</sub> concentration above 7 mg l<sup>-1</sup>. Temperature was maintained at 13.0  $\pm$  0.7°C (mean  $\pm$  SD) and pH at 7.62  $\pm$  0.17 for the duration of the trial. Feed was administered twice a day at 08:00 and 18:00. A photoperiod of 12 hours light starting at 06:00 and 12 hour dark was controlled by the artificial lighting of the fish production hall. The fish were fed a standard commercial feed (64/17 Ex 5 mm; ALLER Aqua, Christiansfeld, Denmark), and portion size was doubled every three days from 0.7% to 1.4% and then to 2.8% of BW. After the 9th day the ration was abruptly reduced to 0% BW. The fish in each tank ingested almost all of the feed administered. The data were analyzed in the following manner. (1) The difference in apparent oxygen consumption rate as calculated by a steady state (Eq. (3) in section 3.2) versus unsteady state mass balance equation (Eq. (5) in section 3.2). The data for a single day were selected (day 4 when 1.4% BW was

administered) to illustrate the washout effect; (2) a plot was made of mean oxygen consumption rate for the 9 tanks over the 17 day trial (using the unsteady state mass balance from Equation (5) in section 3.2); and (3) a summary data table was made of total daily O<sub>2</sub> use, and also maximum, mean and minimum daily O<sub>2</sub> use.

### **2.3.2      *Automated respirometry in seawater with turbot***

The performance of the CO<sub>2</sub> and NH<sub>3</sub> analyzers in seawater was investigated as part of a two-week feeding trial with turbot. The measurement frequency was limited by the NH<sub>3</sub> autoanalyzer, which takes the longest time of the instruments to complete a measurement (in this measurement protocol 16 min tank<sup>-1</sup>), resulting in 9 measurements per day for each of the ten tanks. For brevity, the data from only three tanks containing fish are presented in this paper (the other six tanks containing fish are not presented as they were exposed to different conditions for an unrelated experiment). The NH<sub>3</sub> analyzer was tested for two sessions of 2.5 days, which we deemed sufficient to assess its utility, and allowed us to make higher resolution measurement of CO<sub>2</sub> and O<sub>2</sub> for the remainder of the trial (the measurement period can be reduced from 16 to 8 min per tank). Fourteen turbot were stocked into each tank (mean individual weight 144.0 ± 22.3 g, mean biomass 2.02 ± 0.04 kg, MBW was calculated as (mean fish body weight (kg))<sup>0.8</sup> x number of fish in the tank (Brafield, 1985). The flow rates through the test tanks (300 l h<sup>-1</sup>) were set on the basis of the fastest possible washout from one measurement to another. Fish were maintained at a salinity of 20.2 ± 0.8‰, pH of 7.37 ± 0.03 and 17.7 ± 0.1°C and fed daily ad libitum with a commercial diet (ALLER 505 EX 9 mm, ALLER Aqua, Christiansfeld, Denmark, macro nutrient profile: crude protein 50%, crude fat 16%, ash 9%, fibre 1%). The photoperiod was controlled via artificial room lighting, and set to 12:12 light:dark, with sunrise starting at 06:00. All water quality variables were within the range favorable for the growth of animals (Imslund et al., 2001).

## **2.4**      *Data handling and statistics*

All data are presented as mean  $\pm$  SD. The comparisons between washout corrected and uncorrected data (see section 3.2 Eq. (3) and Eq. (5)) was performed via t-test. The absolute CO<sub>2</sub> production rate could not be determined as we did not make a measure of the total inorganic carbon content of the water. We therefore used the term ‘relative CO<sub>2</sub> production’ to represent the difference in CO<sub>2</sub> concentration between the reference tank and respirometry tanks housing fish. All daily curves of NH<sub>3</sub> and relative CO<sub>2</sub> production and O<sub>2</sub> consumption were corrected for washout (see chapter 3.2 Eq. (5)). The data used to account for background respiration in each respirometry tank was interpolated from the reference tank measurements. The expected reference value for a given respirometry tank was calculated using a linear interpolation between two successive reference tank measurements. Each tank received a value dependent on the temporal distance between to the two reference measurements.



## 3 Results and discussion

### 3.1 *The importance of accounting for washout*

When using flow-through respirometry to calculate metabolic rate it must be considered whether the water body is in a steady state or unsteady state situation. The former implies that all factors that affect the calculation of metabolic rate are constant, such as the metabolite flux by the animal, water flow rate, influent metabolite concentration and so on. When the washout rate of the respirometer is relatively low (30 min or more), and the metabolic rate changes over short time periods (such as during digestion and assimilation) the use of a steady state model such as that described by Timmons and Ebeling (2010) (Eq. (3.2), 2010) to calculate mass balance will incorrectly estimate (and likely significantly) the true metabolic rate. To calculate the washout time for the respirometry tanks in our system we used the following equation given by Steffensen (1989):

$$t = V/F * \ln ((100 - E)/100) \quad (1)$$

where  $F$  is the flow rate through the respiration tank [ $\text{l h}^{-1}$ ],  $V$  is the tank volume [l],  $E$  is the tank-water exchange rate [%] and  $t$  is time [h]. Figure 3 shows the theoretical washout times with the corresponding flow rates in our system. The highest water exchange rate through the respirometry tanks is  $300 \text{ l h}^{-1}$ , meaning the fastest time to 95% washout possible in these tanks is 2.5 h. The rate at which the fish within a tank may change  $\text{O}_2$  consumption rate is in the order of minutes (for example following a feeding event), so clearly the use of a steady state method to calculate oxygen consumption for our flow-through system will grossly under or over-estimate the instantaneous oxygen consumption rate depending on whether the true rate is increasing or decreasing. For this reason it is necessary to account for the washout effect when calculating the oxygen consumption rate using an unsteady state mass balance equation.

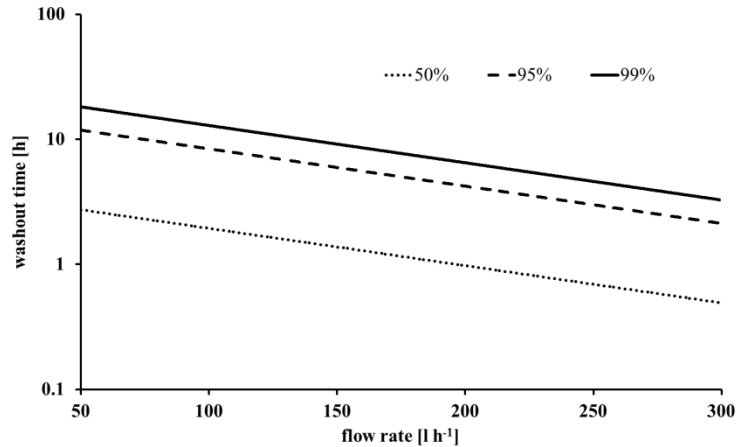

**Fig. 1-3:** Calculated washout time for the 250 l respirometry tanks over the range of possible flow rates [l h<sup>-1</sup>].

### 3.2 Calculating washout-corrected metabolic rates

Based on the equations of Eriksen (2002) and the boundary conditions in which they apply, we derived a washout correction formula for equidistant time steps for our system. The unsteady-state mass balance equation for dissolved O<sub>2</sub> in accordance to Equation (1) in Eriksen (2002) is:

$$dc/dt * V = F * (c_{in} - c) - Q_{O_2} \quad (2)$$

where  $c$ ,  $c_{out}$  (effluent) and  $c_{in}$  (influent) are dissolved O<sub>2</sub> concentrations [mg l<sup>-1</sup>] of the test tank and reference tank, respectively,  $F$  is the flow rate through the respiration tank [l h<sup>-1</sup>],  $V$  is the tank volume [l],  $Q_{O_2}$  is the total rate of O<sub>2</sub> consumption [mg h<sup>-1</sup>], and  $t$  is time [h].

The partial solution for  $dc/dt = 0$  of Equation (2) can be written as:

$$Q_{O_2}(t-t_0) = F * [c_{in}(t_0) - c_{out}(t-t_0)] \quad (3)$$

If the experimental protocol gives data at equidistant time intervals of  $t_1, t_2, t_3, \dots, t_n, t_{n+1}, \dots$  and  $n$  is a natural number, Equation (2) can be expressed for any desired and successive time points  $t_n$  and  $t_{n+1}$  of the experiment as:

$$[c_{out}(t_{n+1}) - c_{out}(t_n)] * V / (t_{n+1} - t_n) = F * [c_{in}(t_n) - c_{out}(t_n)] - Q_{O_2}(t_n) \quad (4)$$

Equation (4) is comparable to Equation (6) in Eriksen (2002) and can be rewritten as solution of  $Q$  to:

$$Q_{O_2}(t_n) = [c_{out}(t_n) - c_{out}(t_{n+1})] * V / (t_{n+1} - t_n) + F * [c_{in}(t_n) - c_{out}(t_n)] \quad (5)$$

The corrections work for  $CO_2$  and  $NH_3$  concentrations in the same way, however, the concentrations of the fish tanks are subtracted from the concentrations of the reference tank as these metabolites are excreted rather than consumed. Table 1-2 presents the summary  $O_2$  consumption statistics for a single day of rainbow trout respiration using a steady state versus unsteady state calculative method to derive metabolic rate. The only statistically significant difference in summary statistics between the two calculative methods was for the maximum  $O_2$  consumption rates ( $n = 9$ ; t-test,  $P < 0.05$ ).

**Table 1-2:** Comparison of oxygen consumption rates resulting from different calculative methods. Extreme, mean and sum values (n=9) of rainbow trout (153.8 ± 35.9 g) fed two times within a single day at 1.4% BW, at a water temperature of 13.0 ± 0.7 °C.

O <sub>2</sub> consumption [mg kg <sup>0.8</sup> h <sup>-1</sup> ]	Washout corrected	Washout uncorrected
Max	125.79 ± 13.36*	111.60 ± 11.50*
Min	68.72 ± 4.11	64.46 ± 5.44
Mean	84.00 ± 5.02	82.97 ± 5.13
Sum	2016.07 ± 120.55	1991.37 ± 123.11

Values are mean ± standard deviation. \* Significant difference by t-test, p < 0.05.

Figure 1-4 displays a daily metabolic profile for rainbow trout using two different approaches for calculating O<sub>2</sub> consumption from concentration data from our flow-through respirometers. The use of a steady state calculative method significantly underestimates instantaneous O<sub>2</sub> consumption when the true rate rapidly increases (for example at feeding time), and overestimates O<sub>2</sub> consumption during the subsequent reduction of metabolic rate during the digestive process (Fig. 1-4).

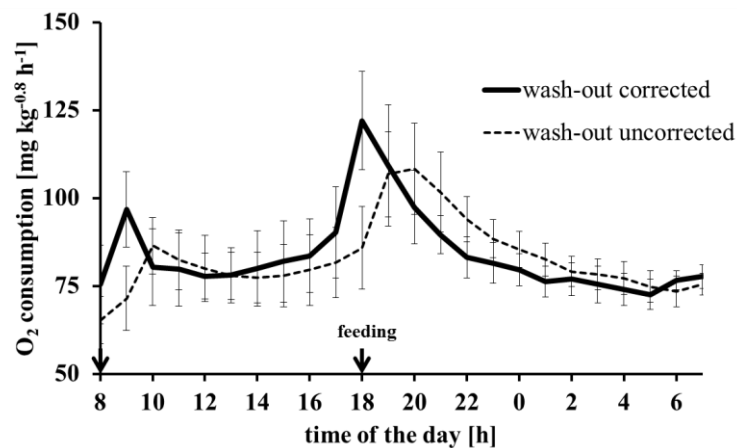

**Fig. 1-4:** The profile of oxygen consumption of rainbow trout for one day using a washout corrected (solid line) versus uncorrected (dashed line) calculative approach. The rainbow trout (mean weight 153.8 ± 35.9 g) were fed a 1.4% BW ration split between 08:00 and 18:00. Water temperature was 13.0 ± 0.7 °C. Each data point is a mean ± SD of 9 replicate tanks.

When the data was averaged over long periods, such as a day, there was no difference in each calculative approach (Tab. 1-2), however, if one desires metabolic rate in terms of minutes or hours, Figure 4 implies that it is important to use an unsteady state calculative

approach to account for the washout effect. The respirometer system performed well enough to detect inter-tank variation in metabolic activity. During the dark period there was less variation in oxygen consumption between tanks compared to the light period, when spontaneous activity, feeding and digestion significantly modifies metabolism (Fig. 1-4).

### 3.3 *CO<sub>2</sub> analyzer response time*

The analyzer response time to 99% measurement span ( $t_{99}$ ) was 5-7 min (Fig. 1-3). By setting the sampling interval in the water quality test section to 7 min we could be sure to achieve precise dissolved CO<sub>2</sub> measurements.

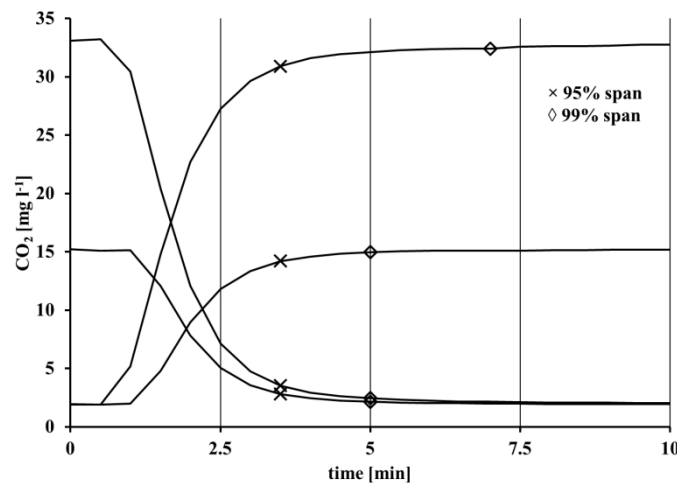
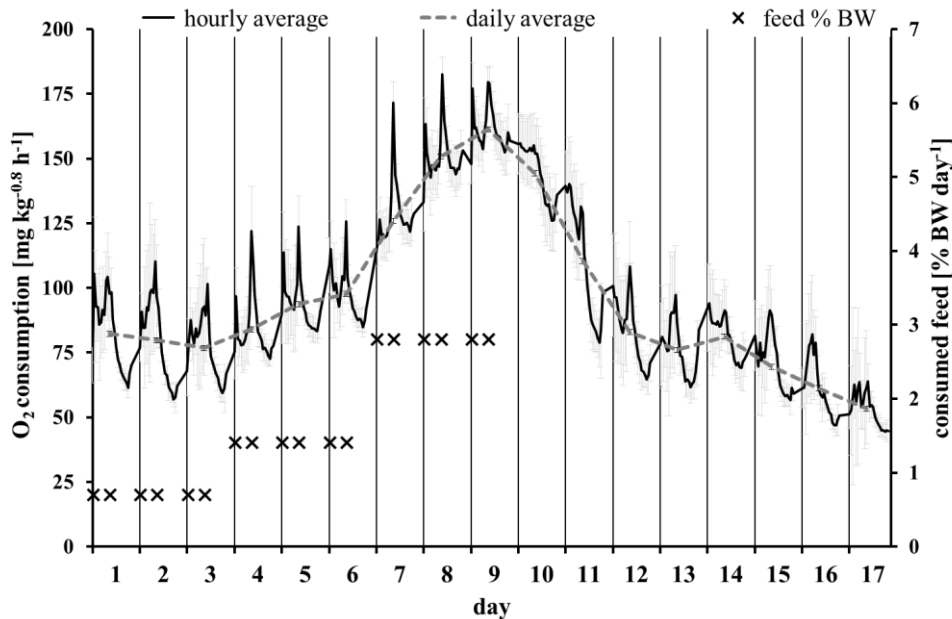

**Fig. 1-5:** Response time of the CO<sub>2</sub> analyzer to a change in dissolved CO<sub>2</sub> concentration. The measured CO<sub>2</sub> concentration was stable (corresponding to 100% span) at 18 to 20 min. The water flow through the equilibrator of the CO<sub>2</sub> analyzer was 3 l min<sup>-1</sup>, sampling rate 30 s per sample, temperature 20 °C and salinity 7‰. The symbols correspond to the time taken to reach 95% and 99% of the total span.

This measurement interval is faster (at a flow rate of 3 l min<sup>-1</sup>) than that achieved by the OxyGuard submersible CO<sub>2</sub> analyzer commonly used in aquaculture (Borges et al., 2012; Moran et al., 2010), although it is important to emphasize that these analyzers differ substantially in their precision, price and intended application.

### 3.4 Automated measurements in freshwater with rainbow trout

The respirometer system performed well in detecting the effect of increasing and decreasing ration size on the O<sub>2</sub> consumption of rainbow trout. The use of nine replicate tanks for a single treatment helped resolve in detail the diurnal rhythm in feeding and digestion followed by a return to resting levels (Fig. 1-6).



**Fig. 1-6:** Diurnal variations (24 h starting 8:00) in oxygen consumption of rainbow trout (mean weight  $153.8 \pm 35.9$  g) fed differing ration sizes (0.7, 1.4, and 2.8% initial body weight per day). Feed was given twice a day at 08:00 and 18:00. The last 8 days were without feeding. Data points are mean  $\pm$  SD. Solid line is hourly average ( $n=9$ ); dashed line is daily average ( $n=216$ ). Water temperature was  $13.0 \pm 0.7^\circ\text{C}$ .

As alluded to above, there was a clear difference in the rate of O<sub>2</sub> consumption throughout the day, with higher variation in metabolism during the daytime when feeding occurred compared to the night period (Fig. 1-4). A daily “M shape” rhythm was visible, with O<sub>2</sub> consumption maxima coincident with feeding events. The O<sub>2</sub> consumption rate increased with increasing meal size, both in terms of maxima and minima values (Fig. 6). After the 2.8% BW feeding trial a starvation period followed. Fig. 6 illustrates a weakening of the diurnal “M shape” and a reduction in metabolic rate following food restriction. A very rapid decrease of

O<sub>2</sub> consumption was observed during the first days of starvation, after which it decreased at a slower rate. After two days a clear adaptation of the fish to food restriction was detected. The diurnal pattern of O<sub>2</sub> consumption observed during the feeding period was not evident during food restriction, although the metabolic rate tended to be higher and more variable during the daylight hours.

### 3.5 Automated measurements in saltwater with turbot

Fig. 1-7 displays the data from the trial where turbot were fed to satiation daily for 10 days. There was a clearly observable pattern in the NH<sub>3</sub> and relative CO<sub>2</sub> production and O<sub>2</sub> consumption related to feeding events. After a feeding event (which occurred over an hour as the animals were fed to satiation) there was an increase in O<sub>2</sub> consumption and relative CO<sub>2</sub> production, and a 3-4 h later an increase in NH<sub>3</sub> production. This time delay is also described by Dosdat et al. (1996), who showed that for 100 g turbot the post-prandial hourly NH<sub>3</sub> excretion rate increased 5-8 h after feeding. It is presently difficult for us to comment on the relative CO<sub>2</sub> production data because to the best of our knowledge there are no CO<sub>2</sub> excretion rates available for turbot, and generally little reliable data from other marine fish.

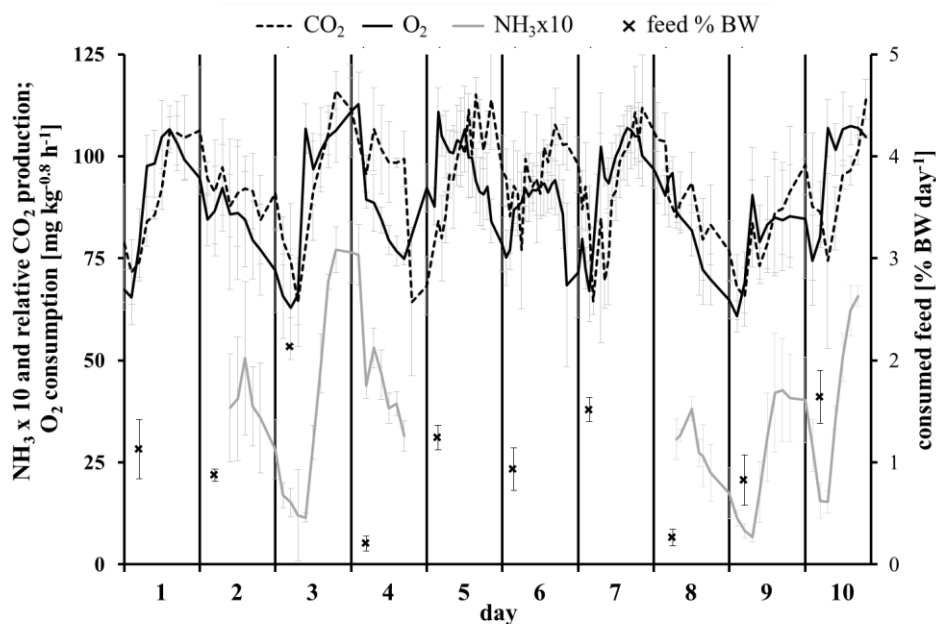

**Fig. 1-7:** Diurnal variation (24 h starting 8:00) in metabolic rates of turbot ( $144.0 \pm 22.3$  g) fed to satiation once per day. Metabolic rates given for O<sub>2</sub> consumption (black solid line); relative CO<sub>2</sub> production (see section 2.4 for

definition, dashed line) and  $\text{NH}_3$  excretion ( $\times 10$ , solid gray line, measured as total ammonia nitrogen). Feeding time and ration size is defined by symbol 'x'. Each data point is a mean  $\pm$  SD of 3 replicate tanks. pH  $7.37 \pm 0.03$ , salinity  $20.2 \pm 0.8$  ‰, temperature  $17.8 \pm 0.1$  °C.

### **3.6**      *Maintenance, utility and limitations*

The combination of a proportional valve, flow meter and PID controller was good option for a long-term measurement system as it made it easy to control and monitor flow rates into each tank. Although a more expensive option than a flow meter and manual valve, this system was not hampered by fouling and variable flow rates over time, which is important in long-term flow-through respirometry. While we were satisfied with the operation of amperometric oxygen electrode and were able to determine a maintenance and recalibration schedule that gave suitable operation (along with replacement every 6 months), we would consider switching to an oxygen optode for future studies. Optodes are less susceptible to fouling and drift, although presently it is expensive and difficult to find stationary probes that can easily be substituted for electrochemical probes. The  $\text{CO}_2$  analyzer required some adaption to avoid fouling problems. The equilibrator was cleaned once a week to remove the biofilm. A  $\text{CO}_2$  permeable membrane separated the equilibrator headspace from the NDIR system, however, this membrane became clogged over time and the response time of the analyzer slowed considerably. We installed a new membrane less system with the help of the manufacturers to overcome this problem. While in operation the  $\text{NH}_3$  analyzer requires a reasonably large volume of distilled water (70 ml per sample) and reagents (see Tab. 1-1), meaning there needed to be capacity to supply these fluids and hold the waste. The calibration fluid needed to be stored in a refrigerator built into the OceanPack system, adding to footprint taken up by this analyzer. We were satisfied with the performance of orthophthaldehyde based measurement system and did not have to deal with the toxic waste of a phenol based system. We attempted to shorten the measurement interval of the  $\text{NH}_3$  analyzer from 12 to 10 min, however, the wash and flushing time was not sufficient to avoid carryover effects. The



automated self-cleaning filter (driven by air pressure) of the  $\text{NH}_3$  analyzer worked well, and we never found any fouling in the autoanalyzer lines. The total time required to maintain the measurement equipment during a trial was approximately 2 h per week.

The respirometry tanks housing the fish were well designed and easy to work with in terms of handling fish and solid waste management. Both trout and turbot adapted readily to the conditions of the tank despite contrasting lifestyle modes. The tanks were efficient at concentrating uneaten food in the central collection drain following feeding (an important consideration in feed conversion studies), and there was rarely any settleable solid waste observed in the tanks. The auxiliary circulation pump was not necessary for concentrating solids. During a fish re-weighing event the flow rate into the tank needed to be minimized and some water released, and it was easy to catch the fish and put them back with minimal stress imposed. Although the system we constructed can precisely measure a number of water chemistry parameters, there are some limitations imposed on what data can be collected with the use of a single measurement system and analyzers of varying measurement intervals. If the  $\text{NH}_3$  autoanalyzer is being used (measurement interval 12 min), the amount of data that can be collected from a single tank (out of 10 tanks) in a day may not be particularly informative given the strong diurnal variations exhibited by fish feeding and digesting. The experimental plan for a particular trial will need to incorporate factors such as the timing of feeding, the daily measurement frequency for a single tank, the number of replicated tanks and the equipment sampling protocol.

## Acknowledgements

We thank Gero Bojens and Wolfgang Voigt for excellent technical support and discussions. We also thank Stefan Marx and Saskia Heckmann from SubCtech GmbH Germany for their cooperation during the development and adaptation of the analyzers, and Kunststoff Spranger GmbH for constructive discussions and configuration of the tanks. Further thanks to Johnny Ogunji for several suggestions on earlier versions of the manuscript and Ileana Hinz for image development of Fig. 1-1. DM was supported by a Marie Curie Fellowship. The project was supported by the Ministry of Science, Economic Affairs and Transport of the State of Schleswig-Holstein (Project-No: 122-08-008) and its further development by the Innovationsstiftung Schleswig-Holstein (ISH, Project-No: 2010-43).

## References

- Brafield, A.E., 1985. Laboratory studies of energy budgets, in: Tytler, P., Calow, P. (Eds.), *Fish Energetics: New Perspectives*, Croom Helm, London, pp. 257–282.
- Borges, M.T., Domingues, J.O., Jesus, J.M., Pereira, C.M., 2012. Direct and continuous dissolved CO<sub>2</sub> monitoring in shallow raceway systems: from laboratory to commercial-scale applications. *Aquacultural Engineering* 49, 10–17.
- Cho, C.Y., Kaushik, S.J., 1990. Nutritional energetics in fish: energy and protein utilization in rainbow trout (*Salmo gairdneri*). *World Review of Nutrition and Dietetics* 61, 132–172.
- Covington, A.K., Whitfield, M., 1988. Recommendations for the determination of pH in seawater and estuarine waters. *Pure and Applied Chemistry* 60, 865–870.
- Dosdat, A., Servais, F., Metailler, R., Huelvan, C., Desbruyeres, E., 1996. Comparison of nitrogenous losses in five teleost fish species. *Aquaculture* 141, 107–127.
- Ege, R., Krogh, A., 1914. On the relation between the temperature and the respiratory exchange in fishes. *Internationale Revue der gesamten Hydrobiologie und Hydrographie* 7, 48–55.
- Eriksen, N.T., 2002. Accuracy and precision of aquatic respirometers with emphasis on monophasic oxystats. *Fish Physiology and Biochemistry* 26, 139–147.
- Fivelstad, S., 2013. Long-term carbon dioxide experiments with salmonids. *Aquacultural Engineering* 53, 40–48.
- Gehrke, P.C., Fidler, L.E., Mense, D.C., Randall, D.J., 1990. A respirometer with controlled waterquality and computerized data acquisition of experiments with swimming fish. *Fish Physiology and Biochemistry* 8, 61–67.

- Imsland, A. K., Foss, A., Gunnarsson, S., Berntsson, M.H.G., FitzGerald, R., Bonga, S.W., van Ham, E., Naevdal, G., Stefansson, S.O., 2001. The interaction of temperature and salinity on growth and food conversion in juvenile turbot (*Scophthalmus maximus*). *Aquaculture* 198, 353–367.
- Lucas, M.C., Johnstone, A.D.F., Tang, J., 1993. An annular respirometer for measuring aerobic metabolic rates of large, schooling fishes. *The Journal of Experimental Biology* 175, 325–331.
- Mamun, S.M., Focken, U., Becker K., 2013. A respirometer system to measure critical and recovery oxygen tensions of fish under simulated diurnal fluctuations in dissolved oxygen. *Aquaculture International* 21, 31–44.
- Moran, D., Støttrup, J.G., 2011. The effect of carbon dioxide on growth performance of juvenile Atlantic cod *Gadus morhua* L. *Aquatic Toxicology* 102, 24–30.
- Moran, D., Tirsgård, B., Steffensen, J.F., 2010. The accuracy and limitations of a new meter used to measure aqueous carbon dioxide concentration. *Aquacultural Engineering* 43, 101–107.
- Pfeiffer, T.J., Summerfelt, S.T., Watten, B.J., 2011. Comparative performance of CO<sub>2</sub> measuring methods: Marine aquaculture recirculation system application. *Aquacultural Engineering* 44, 1–9.
- Sanz Rus, A.S., Enjuto, C, Morales, A.E., Hidalgo, M.C, Garcia-Gallego, M., 2000. Description of a facility for studying energy metabolism in fish: application to aquaculture. *Aquacultural Engineering* 21, 169–180.
- Steffensen, J.F., Johansen. K., Bushnell, P.G., 1984. An automated swimming respirometer. *Comparativ Biochemistry and Physiology A*: 79, 473-476.
- Steffensen, J.F., 1989. Some errors in respirometry of aquatic breathers: how to avoid and correct them. *Fish Physiology Biochemistry* 6, 49–59.
- Stiller, K.T., 2010. Parametrisierung eines Respirationssystems zur Erfassung von Stoffwechselsituationen bei Fischen (Diploma thesis), Christian-Albrechts-Universität, Kiel, pp. 1–121.
- van Ginneken, V.J.T., Gluvers, A., van der Linden, R.W, Addink, A.D.F, van den Thillart, G.E.E.J.M, 1994. Direct calorimetry of aquatic animals: automated and computerized data-acquisition system for simultaneous direct and indirect calorimetry. *Thermochimica Acta*. 247, 209–224.
- Timmons, M.B., Ebeling, J.M., 2010. *Recirculating Aquaculture*, 2nd ed. Cayuga Aquaculture Ventures, Ithaca, New York.
- Weiss, R.F., 1974. Carbon dioxide in water and seawater: the solubility of a non-ideal gas. *Marine Chemistry* 2, 203–215.



## CHAPTER 2

### **The effect of carbon dioxide on growth and metabolism in juvenile turbot *Scophthalmus maximus* L.**

Kevin Torben Stiller<sup>abc</sup>, Klaus Heinrich Vanselow<sup>a</sup>, Damian Moran<sup>d</sup>, Gero Bojens<sup>a</sup>, Wolfgang Voigt<sup>a</sup>, Stefan Meyer<sup>b</sup> and Carsten Schulz<sup>bc</sup>

<sup>a</sup> Forschungs- und Technologiezentrum Westküste, Christian-Albrechts-Universität zu Kiel, Hafentörn 1, 25761 Büsum, Germany

<sup>b</sup> Gesellschaft für Marine Aquakultur, Hafentörn 3, 25761 Büsum, Germany

<sup>c</sup> Institute of Animal Breeding and Husbandry, Christian-Albrechts-Universität zu Kiel, Olshausenstraße 40, 24098 Kiel, Germany

<sup>d</sup> Seafood Technologies Group, Plant & Food Research, Nelson 7010, New Zealand

---

## Abstract

Land-based aquaculture is an increasingly important method of fish production, and fish grown in such systems may be exposed to substantially higher carbon dioxide concentrations than fish in the wild. Chronic exposure to elevated CO<sub>2</sub> levels in recirculated aquaculture systems can correlate with lower growth and condition indices for many fish species, however, the physiological basis behind this loss of performance is largely unknown. The aim of this study was to investigate the growth, condition and protein catabolism rates of juvenile turbot (55-176 g) reared for 8 weeks at three different dissolved carbon dioxide concentrations: 5, 26, 42 mg l<sup>-1</sup> (~3000, 15000, 25000 µatm; pH 7.37, 6.66, 6.44). A commercial diet was administered once per day until satiation, and uneaten food was collected from a solids collector. Oxygen consumption and ammonia excretion were measured weekly using high precision automated methods in a recirculating aquaculture respirometer system. Increased CO<sub>2</sub> levels were associated with reduced condition factor, feed intake and weight gain. Compared to the low CO<sub>2</sub> treatment, the specific growth rates under the medium and high treatments were reduced by 21% and 58%, respectively. Feed conversion ratios were similar between treatments. The oxygen consumption rates broadly followed a dose-response pattern, where fish in the low CO<sub>2</sub> treatment exhibited the highest respiration rates. Comparison of ammonia quotients over time and at comparable feed intake showed the rates of protein catabolism correlated with CO<sub>2</sub> exposure levels. By the end of the 8 week trial fish from the high CO<sub>2</sub> treatment exhibited up to 3 times the protein catabolism rates observed in the low treatment, and the medium treatment was approximately intermediate between the two. The conclusion from the study was that the loss of growth and condition of turbot reared at elevated CO<sub>2</sub> concentrations (relevant to land-based aquaculture systems) can be traced to decreased feed intake and an increased reliance on protein as a fuel source.

# 1 Introduction

Aquaculture is an increasingly important source of seafood production, and as space for coastal cages becomes limiting there is a growing proportion of fish being cultured in land-based aquaculture systems that recirculate most of the system water. Carbon dioxide (CO<sub>2</sub>) from fish and microbial respiration accumulates in these systems, and while degassing units are used to remove as much CO<sub>2</sub> as possible, the concentration of dissolved CO<sub>2</sub> in these systems is considerably higher (10 times or more) than the atmospheric CO<sub>2</sub> level (Colt, 2006). There are welfare and production concerns about the ability of marine fish to grow and thrive in CO<sub>2</sub> enriched waters associated with recirculating aquaculture systems. Marine fish have evolved in a media highly conducive to the diffusion of CO<sub>2</sub> from the blood to the water, and are accustomed to much lower blood CO<sub>2</sub> levels compared to terrestrial vertebrates (Ishimatsu et al., 2005). Fish have evolved mechanisms to cope with the acute effects of elevated tissue CO<sub>2</sub> (termed hypercapnia) associated with intense exercise, and are able to rapidly modulate blood pH and H<sup>+</sup> transport across the gills in an effort to control the acidification resulting from carbonic acid formation (Claiborne et al., 2002; Heuer and Grosell, 2014).

Compared to acute hypercapnia, much less is known about the physiological and pathological effects of chronic hypercapnic exposure in marine fishes. Fish reared in above-atmospheric CO<sub>2</sub> levels common in recirculating aquaculture systems (approximately 2500 – 20000 µatm, Timmons and Ebeling, 2010) can exhibit reduced growth, feed conversion efficiency, condition factor and welfare indicators (Ben-Asher et al., 2013; Fivelstad et al., 1998; Foss et al., 2003; Musa et al., 2013; Petoichi et al., 2011). While there is plenty of evidence that exposure to chronically elevated CO<sub>2</sub> affects fish growth, there is a poor understanding of the physiological mechanisms that cause reduced growth performance. In this paper we attempt to elucidate the metabolic fuel use of differences in growth and

condition of juvenile turbot (*Scophthalmus maximus* L.) exposed to three levels of dissolved CO<sub>2</sub> relevant to land-based aquaculture. This study utilized a purpose-built set of respirometer tanks that could house fish for long periods of time in order to evaluate metabolic consequences of hypercapnia over several weeks, a much longer time period than other aquatic respirometry trials have been able to undertake. The oxygen consumption rate of juvenile turbot was used as a proxy of metabolic rate to investigate whether there were differences in energy expenditure between CO<sub>2</sub> treatments. Ammonia excretion and oxygen consumption rates were used to estimate protein catabolism rates (Gnaiger, 1983). When protein catabolism rates were combined with feed intake and feed conversion data, it was possible to partition lost growth between decreased protein intake and increased protein catabolism for energy. This was an aspect that offered some interesting insights into the metabolic perturbation caused by long term exposure to elevated CO<sub>2</sub> and stress related protein catabolism.



## 2 Material and methods

### 2.1 *Fish husbandry and respirometer system*

This study was performed at the Gesellschaft für Marine Aquakultur, Büsum, Germany. Prior to experimentation animal ethics approval was obtained. Juvenile turbot were obtained from the Maximus A/S hatchery (Bedsted, Denmark) and were held for two months before experimental manipulation. To start the trial 14 turbot were stocked into each of nine test tanks with a mean weight of approximately 55 g and a similar variance between tanks. Fish were maintained at a salinity of  $20.2 \pm 0.8$  ‰ and  $17.7 \pm 0.1$  °C and fed daily with a commercial diet (ALLER 505 EX 9 mm, ALLER Aqua, Christiansfeld, Denmark, macro nutrient profile: crude protein 50 %, crude fat 16 %, ash 9 %, fibre 1 %). Feed was administered once per day at approximately 12:00 p.m. until apparent satiation. To determine the voluntary daily feed intake (DFI) uneaten pellets were collected by a solid collector located in the bottom centre of the tanks and their equivalent weight was subtracted from the daily feed out weight. Settled solids were removed twice per day by opening the valve under the solids collector. The photoperiod was controlled via artificial room lighting, and set to 12 h : 12 h light : dark.

The experiment was performed in a recirculating aquaculture respirometer system (RARS) designed for growth studies described in detail in Stiller et al., (2013). Briefly, the RARS consisted of 10 tanks (250 l volume each) connected with a recirculated water treatment system (Fig. 2-1). Daily water exchange was around 10 % of total volume. The system utilizes a flow-through approach with a suite of online water chemistry analyzers (Fig. 2-1, No. 14) sequentially measuring metabolite concentrations. The water chemistry analysis unit measured the following parameters: oxygen (O<sub>2</sub>) concentration (amperometric electrode, dTRANS O2 01; JUMO GmbH & Co. KG, Fulda, Germany); water pH (pH<sub>NBS</sub>, intermediate junction electrode, Ionode IJ44, TPS Pty Ltd, Brisbane, Australia); temperature; total

ammonia nitrogen (TAN, loop flow orthophthalaldehyde fluorometric autoanalyzer,  $\mu$ Mac, SYSTEA S.p.A., Anagni, Italy) and dissolved carbon dioxide (purpose built flow through headspace analyzer, MK-2 pCO<sub>2</sub> / Fast Analyser (SubCtech GmbH, Kiel, Germany) with non-dispersive infrared detection, LI-840A (LI-COR Biosciences, Nebraska, United States)). The flow rates through the tanks were set to 300 l h<sup>-1</sup> to allow the fastest possible washout from one measurement to another. The rate of daily data acquisition (9-18 day<sup>-1</sup>) was dependent on the time it takes for the slowest analyzer to complete a measurement. Ammonia measurements were performed weekly (days: 4/5, 10/11, 16/17, 25/26, 31/32, 39/40, 47/50, 54/55) for 24 h with a measurement time of 16 min per tank (i.e. 160 min to measure all 10 tanks). Nitrite and salinity were measured daily and alkalinity weekly. Nitrite was determined manually using a commercial kit, salinity was determined via refractometry, and alkalinity determined via potentiometric titration using an acid standard.

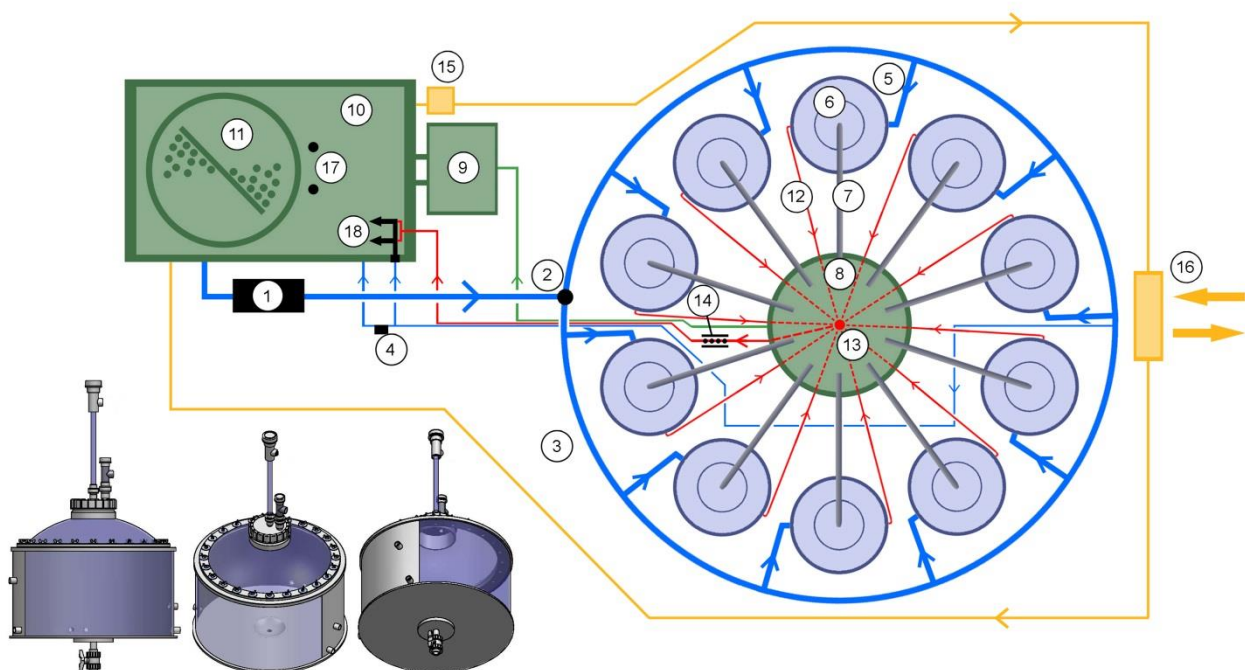

**Fig. 2-1:** Tank schematic (left corner; drawing by Kunststoff-Spranger) and plan view of recirculating aquaculture respirometer system: (1) recirculation pump; (2) manometer; (3) water distribution circuit; (4) pressure regulating valve; (5) tank inflow; (6) tank; (7) overflow line; (8) sedimentation barrel; (9) sedimentation tank; (10) sump; (11) trickling filter; (12) sampling circuit from tank; (13) pipe junction; (14) sensors; (15) temperature circuit pump; (16) heat exchanger; (17) temperature sensors; and (18) water jet pumps (Modified from Stiller et al. (2013)).

## 2.2 *CO<sub>2</sub> dosing*

Three hypercapnic treatments were tested with three replicate tanks per treatment, and one tank was left empty of fish to act as a reference. Food grade CO<sub>2</sub> was injected into 6 tanks using fine pore ceramic diffusers (model MBD075, Point Four Systems Inc., Canada). The CO<sub>2</sub> dosing was controlled via an adjustable needle valve and low volume flow meter, and the CO<sub>2</sub> concentration in each tank was measured using the aforementioned headspace analyzer. Three tanks were without CO<sub>2</sub> ingassing and represented the lowest CO<sub>2</sub> treatment achievable for the system. The low concentration did not represent atmospheric CO<sub>2</sub> conditions plus fish respiration, as this would be nearly impossible to attain in a recirculating system where CO<sub>2</sub> is actively being ingassed. Extra degassing capacity was installed in the water treatment system in the form of increased air/water surface area in the trickling biofilter (Fig. 2-1, No. 11), and an additional sparging in the system sump (Fig. 2-1, No. 10). The rate of CO<sub>2</sub> ingassing into the high and medium treatment tanks occurred gradually over the first 7 days of the experiment to allow the fish to acclimate, and to allow the system to reach an equilibrium following an increase in ingassing. The three CO<sub>2</sub> treatment levels maintained for the remainder of the trial were designated as high (~25000 µatm, 42 mg l<sup>-1</sup>), medium (~15000 µatm, 26 mg l<sup>-1</sup>), and low (~3000 µatm, 5 mg l<sup>-1</sup>). A full description of carbonate chemistry parameters is given in Table 1.

**Table 2-1:** Carbonate chemistry parameters (mean ± SD) of the experiment. Salinity 20 ‰, temperature 17.7 °C.

Variable	Low CO <sub>2</sub>	Medium CO <sub>2</sub>	High CO <sub>2</sub>	
Dissolved CO <sub>2</sub> [µatm]	2924 ± 179	15397 ± 656	24826 ± 1850	Measured
Dissolved CO <sub>2</sub> [mg l <sup>-1</sup> ]	4.9	25.8	41.6	Calculated <sup>1</sup>
pH <sub>NBS</sub>	7.36 ± 0.00	6.66 ± 0.01	6.44 ± 0.00	Measured
pH <sub>TOTAL</sub>	7.22	6.52	6.30	Calculated <sup>2</sup>
Total alkalinity [mmol (kg water) <sup>-1</sup> ]	2.19 ± 0.08	2.21 ± 0.08	2.25 ± 0.09	Measured
Total CO <sub>2</sub> [µmol (kg water) <sup>-1</sup> ]	1984	2531	2827	Calculated <sup>3</sup>

<sup>1</sup>Calculated from dissolved CO<sub>2</sub> using solubility constants given in Weiss (1974).

<sup>2</sup>Estimated from pH<sub>NBS</sub> using CO<sub>2</sub>calc (Robbins et al., 2010).

<sup>3</sup>Calculated from pH<sub>NBS</sub> and dissolved CO<sub>2</sub> using CO<sub>2</sub>calc (Robbins et al., 2010).

### **2.3 Growth performance and condition variables**

Individual (Ind.) body wet weight [g], length [cm], width [cm] and bulk wet weight (biomass [g]) were determined at two week intervals (days 0, 14, 28, 42 and 56). After weighing, the fish of a particular tank were placed in another to account for any tank-specific effects. Absolute weight gain (WG) was calculated as the difference between start and end biomass of a specific tank. Geometric mean body weight (GMBW) was calculated as  $GMBW = (\text{start mean body weight} \times \text{end mean body weight})^{0.5}$ . Specific growth rate (SGR, [% BW day<sup>-1</sup>]) was calculated from the tank biomass using the formula  $SGR = (\ln(\text{end biomass}) - \ln(\text{start biomass})) / (\text{number of feeding days since the last measurement}) \times 100$ . Feed conversion ratio (FCR) was calculated as  $FCR = \text{feed intake} / \text{weight gain}$ . Daily feed intake [% BW day<sup>-1</sup>] was calculated as  $DFI = SGR \times FCR$ . The condition factor (CF) was calculated using the weight and length data following the equation of Arfsten et al. (2010) for flatfish,  $CF = (\text{weight} \times 100) / (\text{length} \times \text{width})^{3/2}$ . At the end of the trial blood was taken from the caudal vein of 5 fish per tank using heparinized syringes. The blood was stored on ice for total hemoglobin (Hgb) analysis (cyanmethemoglobin method; Hemoglobin FS kit, DiaSys Diagnostic Systems GmbH, International, Holzheim, Germany). Hemoglobin concentrations were calculated using a reference standard dilution series (HEM QS, Diaglobal GmbH, Germany). Spleen and liver were removed and weighted from 5 fish to the nearest mg on a precision balance. The spleen and hepatosomatic index (SI and HSI) was calculated as  $\text{spleen or liver weight} / \text{fish final weight} \times 100$ .

### **2.4 Whole body analysis**

At the beginning and end of the experiment five fish from each tank were randomly selected for analysis of whole body composition. Fish were killed by heart puncture, freeze dried, homogenized and stored at -20 °C for later analysis. Analysis of whole body composition (dry matter, ash, crude protein, crude fat and crude fiber) was done following EU guideline (EC)

152/2009. Crude protein content was determined using the Kjeldahl method (InKjel 1225 M, WD 30; Behr, Düsseldorf, Germany), crude fat content was determined via HCl hydrolysis followed by petroleum ether extraction and weighing, dry matter content determined after drying at 103 °C and ash content weighed following 4 h at 550 °C. Gross energy was measured in a bomb calorimeter (C200, IKA, Staufen, Germany).

## 2.5 *Metabolic data*

Oxygen consumption and total ammonia nitrogen (TAN) excretion rates were calculated according to the difference between the tanks housing fish and the fish-less reference tank (including microbial background respiration), along with a correction to account for the washout effect, as outlined in Stiller et al. (2013). A comparison of influent versus effluent dissolved oxygen concentration in the reference tank suggested that microbial respiration was less than 1% of the fish respiration rates. The expected reference value for a given respirometry tank was calculated using a linear interpolation between two successive reference tank measurements. Each tank received a value dependent on the temporal distance between the two reference measurements. Details of the method used to calculate respiration rates are given in Stiller et al. (2013). To account for allometric effects of different fish weights in the treatments the metabolic rates were normalized to a daily calculated mass specific metabolic body weight (MBW). For allometric weight scaling of turbot Waller (1992) reported that the exponential relationship between routine oxygen consumption and body weight followed an exponent of 0.7 (body weight 1.5 - 1073 g) and Jobling (1981) reported a weight exponent of 0.67 for ammonia excretion rates in plaice (*Pleuronectes platessa*; body weight 5 - 90 g). For consistency of allometric weight scaling we used the weight exponent of 0.7 for metabolic mass specific oxygen consumption and ammonia excretion rates. Daily MBW was calculated as  $MBW = ((DFI \text{ previous day [kg]} / FCR + \text{Biomass previous day [kg]}) / \text{number of fish in the tank})^{-0.7}$ . The degree of protein utilization for energy metabolism

was estimated using the ammonia quotient (AQ), where values of 0.27 and 0 correspond to 100% and 0%, respectively, of aerobic energy demand met by amino acid catabolism (Gnaiger, 1983). The value of 100% protein usage differs in the literature (0.27 – 0.33, Gnaiger, 1983; Kutty, 1978) and should only be used as an estimate of relative protein usage in energy metabolism. The expression AQ does not include nitrogen excreted as urea (whereas the nitrogen quotient does, Lauff and Wood (1996)). Urea was considered to be of minor importance as turbot, like other teleost fish, excrete the majority of nitrogenous waste as ammonia (Dosdat et al., 1995). In our study the AQ was calculated as excreted TAN [mol] / consumed O<sub>2</sub> [mol]. AQ data for each tank was investigated over a 16 h period equals 6 measurements per tank (between 6 PM to 10 AM) once a week so that feeding and tank cleaning periods were excluded. The AQ data was summarized per bi-weekly period by calculating the mean value for each replicate tank during the measurement interval (i.e. mean AQ value on days 4-5 and 10-11, days 16-17 and 25-26, days 31-32 and 39-40, and days 49-50 and 54-55). The use of biweekly mean AQ data smoothed out the substantial diurnal variation. A more detailed analysis of daily variation in AQ was performed towards the end of the experiment on days 48-50 and 53-55. The AQ value for each CO<sub>2</sub> treatment and time of day was calculated using the mean of 3 replicate tanks within one measurement cycle of the autoanalyzer (160 min).

## **2.6        *Statistical analysis***

For each variable the treatment mean and standard deviation (SD) was computed from three replicate tanks. When a treatment mean derived from the metabolite autoanalyzer was plotted against time, the data point was associated with the time stamp of the first measurement in a sequence (a 160 min sequence). Variables with single time point observations were tested for normality using a Kolmogorov-Smirnov test, homogeneity of variances using Levene's test and differences between replicated treatments were evaluated by one way analysis of variance

(ANOVA) and Tukey's post hoc test using SPSS 17 (SPSS Inc., Chicago, USA). A Dunnett T3 post hoc test was used where there was not homogeneous variance. Variables with repeated measurements were evaluated using a statistical mixed model (Laird and Ware, 1982; Verbeke and Molenberghs, 2009) in R v3.0.1 (R Core Team, 2013). Data were determined to be normally distributed and heteroscedastic across the different weeks via a graphical residual analysis. The statistical model included CO<sub>2</sub> concentration and week as well as all their interaction terms as fixed factors. Fish group and the interaction of fish group and week were treated as a random factor. Based on this model, an analysis of variances (ANOVA) was conducted, followed by multiple contrast tests (e.g. Bretz et al., 2011; Schaarschmidt and Vaas, 2009) in order to compare the several levels of the influence factors, respectively. For all statistical analyses differences were considered to be significant at  $p < 0.05$ .

## **3 Results**

### **3.1 *Water quality***

With the exception of dissolved CO<sub>2</sub> concentration, the water quality during the trial (Table 2-1) was maintained in a state that would be considered as not harmful for fish health or growth (Wedemeyer, 1996). Nitrite ( $0.19 \pm 0.11$  mg l<sup>-1</sup>) and ammonia concentrations were well below reported negative effect levels (Poxton and Allouse, 1982). Only one fish died over the course of the experiment (day 56, an individual from a high CO<sub>2</sub> treatment), indicating that the CO<sub>2</sub> concentrations used in this study were below lethal effect concentrations. During the first two weeks of CO<sub>2</sub> ingassing, it was observed that fish in the high CO<sub>2</sub> treatment tanks swam more erratically compared to the other treatments, however, this behavior was not observable after approximately two weeks, suggesting that the fish had acclimated to the conditions. Examination of the eyes and gills of individuals from the high CO<sub>2</sub> treatments during the first weighing did not reveal any obvious pathological effects.

### **3.2 *Growth and condition***

Carbon dioxide treatment was found to have an effect on mean individual fish length, width and weight after the 56 day trial (Fig. 2-2b). Fish maintained at the highest CO<sub>2</sub> concentration had 38 % lower weight at the completion of the experiment compared to fish at the lowest concentration. Condition factor (Fig. 2-2a) showed dose-responsive effects with a clear separation between treatments.



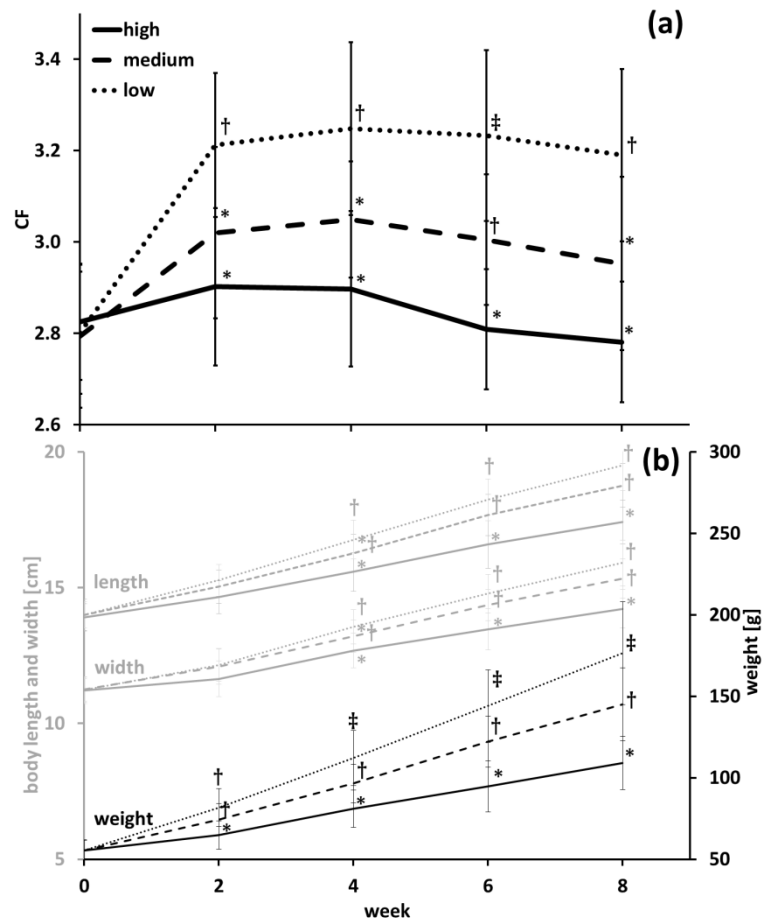

**Fig. 2-2:** The biweekly effect of dissolved CO<sub>2</sub> concentration on (a) conditions factor (CF), (b) weight, width and length (mean  $\pm$  SD, n = 42) of turbot. Data points with a symbol are significantly different from data points that do not share the same symbol within the sampling period ( $p < 0.05$ ). The three CO<sub>2</sub> treatments are high (solid line, 42 mg l<sup>-1</sup>), medium (dashed line, 26 mg l<sup>-1</sup>), and low (dotted line, 5 mg l<sup>-1</sup>).

Spleen index showed no significant differences between treatments. Exposure to elevated concentrations of CO<sub>2</sub> was correlated with decreased total hemoglobin (Hgb) content of the blood and liver index (HSI) (Table 2-2).

**Table 2-2:** Comparison of growth and condition variables of turbot reared for 56 days under three different dissolved CO<sub>2</sub> environments: high (42 mg l<sup>-1</sup>), medium (26 mg l<sup>-1</sup>), and low (5 mg l<sup>-1</sup>).

	Treatment n	Low CO <sub>2</sub>	Medium CO <sub>2</sub>	High CO <sub>2</sub>
Tank start biomass [g]	3	764.67 $\pm$ 9.45	766.33 $\pm$ 8.14	765.33 $\pm$ 5.86
Tank end biomass [g]	3	2446.3 $\pm$ 36.5 <sup>a</sup>	2016.3 $\pm$ 78.5 <sup>b</sup>	1489.8 $\pm$ 83.8 <sup>c</sup>
WG [g]	3	1681.7 $\pm$ 37.9 <sup>a</sup>	1250.0 $\pm$ 83.5 <sup>b</sup>	724.41 $\pm$ 77.96 <sup>c</sup>
HSI [% BW]	15	2.078 $\pm$ 0.410 <sup>a</sup>	1.703 $\pm$ 0.433 <sup>a</sup>	1.262 $\pm$ 0.230 <sup>b</sup>
SI [% BW]	15	0.052 $\pm$ 0.014	0.061 $\pm$ 0.028	0.052 $\pm$ 0.017
Hgb [g dl <sup>-1</sup> ]	15	4.62 $\pm$ 0.43 <sup>a</sup>	4.50 $\pm$ 0.31 <sup>a</sup>	4.06 $\pm$ 0.43 <sup>b</sup>

WG = weight gain; HIS = hepatosomatic index; SI = spleen index; Hgb = Hemoglobin. Values are mean  $\pm$  SD. Superscript letter indicate significant differences between treatment means (Tukey's or Dunnett T3 post-hoc test,  $p < 0.05$ ).

The divergence in growth between treatments was already evident after 2 weeks, with an almost 3-fold difference in SGR between the high and low CO<sub>2</sub> treatments during this period (Fig. 2-3). The SGR of the high CO<sub>2</sub> treatment improved in the second weight measurement period, presumably as a result of fish in this treatment becoming better adjusted to the hypercapnic conditions. The growth rate generally decreased over time as the fish gained mass (the exception was the high CO<sub>2</sub> treatment, which displayed compensatory growth during the second measurement period following slow growth in the first period). To evaluate the effect of CO<sub>2</sub> on the size-specific growth rate a comparison was made of interval-specific SGR versus the geometric mean weight (Fig. 2-3). The growth rate of fish from the low CO<sub>2</sub> treatment decreased by 48% over the course of the experiment, which illustrates the importance of using size-specific growth rates to get meaningful effect magnitudes when comparing treatments. At a body mass of 100 g, turbot from the high, medium and low CO<sub>2</sub> treatments were interpolated from Fig. 3 to be growing at 1.0, 1.9, 2.4% BW day<sup>-1</sup>. The medium and high CO<sub>2</sub> treatments can then be inferred to have caused a 21% and 58% decrease in growth, respectively.

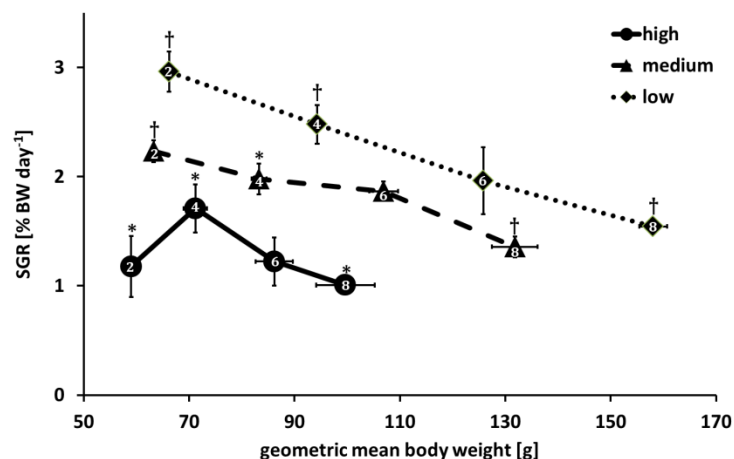

**Fig. 2-3:** The effect of dissolved CO<sub>2</sub> concentration on SGR versus geometric mean individual weight and also expressed as biweekly period expressed as numbers (2, 4, 6, 8) in the symbols (mean ± SD) of turbot. Data points with a symbol are significantly different from data points that do not share the same symbol within the sampling period ( $p < 0.05$ ). The three CO<sub>2</sub> treatments are high (42 mg l<sup>-1</sup>), medium (26 mg l<sup>-1</sup>), and low (5 mg l<sup>-1</sup>).

### 3.3 Feed intake and conversion

For the first half of the trial mean DFI was separated between treatments, with an approximately 40% lower feed intake under the high treatment compared to the low treatment (Fig. 2-4). For the second half of the trial DFI was not significantly different between medium and low treatments, however, the fish in the high treatment still had reduced feed intake relative to the other treatments. While DFI increased noticeably during the second measurement period (after 4 weeks) for all treatments, the general trend among treatments was that DFI decreased with increasing CO<sub>2</sub> concentration (Fig. 2-4). The FCR did not differ over time between the CO<sub>2</sub> treatments.

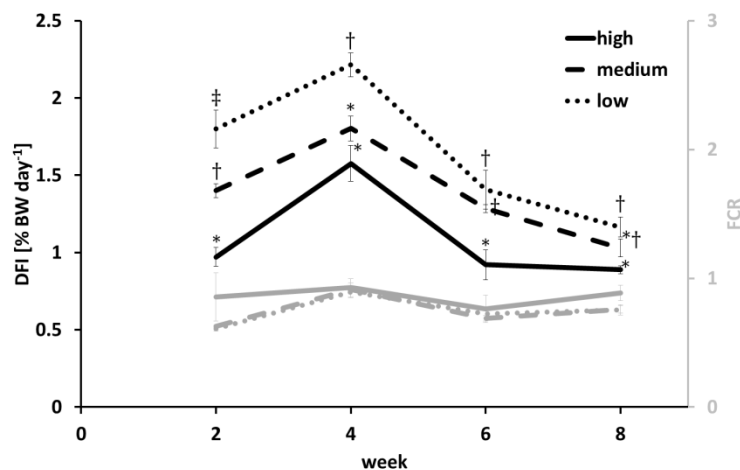

**Fig. 2-4:** The effect of dissolved CO<sub>2</sub> concentration on daily feed intake (DFI, black) and feed conversion ratio (FCR, grey), in two week intervals for turbot. Data points with a symbol are significantly different from data points that do not share the same symbol within the sampling period ( $p < 0.05$ ). The three CO<sub>2</sub> treatments are high (42 mg l<sup>-1</sup>), medium (26 mg l<sup>-1</sup>), and low (5 mg l<sup>-1</sup>).

### 3.4 Body composition

Ash content increased with CO<sub>2</sub> ingassing, while crude fat, protein and energy decreased (Table 3).

**Table 2-3:** Body composition [% of original substance] and gross energy [MJ kg<sup>-1</sup>] contents of whole turbot body held under different dissolved carbon dioxide concentrations: high (42 mg l<sup>-1</sup>), medium (26 mg l<sup>-1</sup>), and low (5 mg l<sup>-1</sup>).

	Initial	Low CO <sub>2</sub>	Medium CO <sub>2</sub>	High CO <sub>2</sub>
Dry matter [%]	23.80	26.56 ± 0.65 <sup>a</sup>	25.73 ± 0.42 <sup>b</sup>	25.19 ± 0.65 <sup>c</sup>
Ash [%]	3.57	3.43 ± 0.13 <sup>a</sup>	3.78 ± 0.05 <sup>b</sup>	4.03 ± 0.07 <sup>c</sup>
Crude protein [%]	15.15	16.26 ± 0.03 <sup>a</sup>	15.60 ± 0.07 <sup>b</sup>	15.51 ± 0.12 <sup>b</sup>
Crude fat [%]	5.08	6.87 ± 0.21 <sup>a</sup>	6.36 ± 0.16 <sup>b</sup>	5.65 ± 0.15 <sup>c</sup>
Energy [MJ kg <sup>-1</sup> ]	5.31	6.40 ± 0.07 <sup>a</sup>	5.98 ± 0.07 <sup>b</sup>	5.65 ± 0.06 <sup>c</sup>

Values are mean ± SD (n = 5 individuals per tank). Superscript letters indicate significant differences between treatment means (Tukey's post-hoc test, p < 0.05).

### 3.5 Metabolic data

The mean oxygen consumption was consistently highest for the low CO<sub>2</sub> treatment at all measurement periods, while the ammonia excretion rate tended to be lowest in the high CO<sub>2</sub> treatment (Fig. 2-5). This pattern is to be expected given the results from the feed intake, where feed intake was inversely proportional to CO<sub>2</sub> treatment level. The oxygen consumption rates in the high CO<sub>2</sub> treatment decreased continuously during the course of the trial, while the ammonia excretion rate tended to increase over time. These effects were not observed in the medium and low CO<sub>2</sub> treatments (Fig. 5).

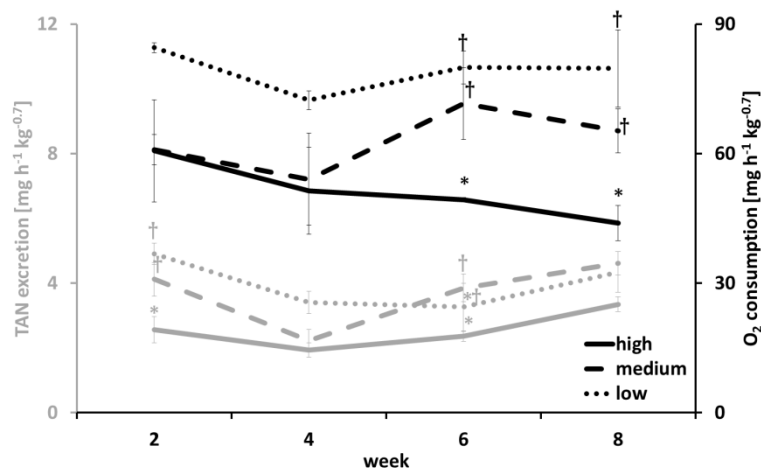

**Fig. 2-5:** Mean metabolic mass specific total ammonia nitrogen (TAN) excretion rate (gray lines) and mean metabolic mass specific oxygen consumption rate (black lines) of turbot expressed as: mean of two 16 h (weekly measurements; representing approximately 6 PM to 8 AM) measurements at three dissolved CO<sub>2</sub> concentration levels. Values are taken from days (4/5 + 10/11), (16/17 + 25/26), (31/32 + 39/40), (49/50 + 54/55). Data points with a symbol are significantly different from data points that do not share the same symbol within the sampling period (p < 0.05). The three CO<sub>2</sub> treatments are high (42 mg l<sup>-1</sup>), medium (26 mg l<sup>-1</sup>), and low (5 mg l<sup>-1</sup>).

The ammonia excretion rate was standardized to the oxygen consumption rate to derive the AQ and estimated protein catabolism rates for each biweekly weight measurement interval plotted against GMBW to account for size-specific differences (Fig. 2-6). Protein catabolism rates trended downward for the first four weeks, which was a period associated with compensatory growth. For the remainder of the trial the medium and high CO<sub>2</sub> treatments exhibited strongly increasing protein catabolism rates (finishing at 57% and 61% protein fuel use, respectively) while the low treatment tended to be stable around 39% protein fuel use (Fig. 2-6). A linear regression was fitted to the post-acclimation AQ data (i.e. weeks 4, 6 and 8) to quantify the magnitude difference in AQ trajectories. Compared to the low CO<sub>2</sub> treatment the slope of the fitted lines of the medium and high treatments increased by a factor of 11 and 26 respectively (Fig. 2-6).

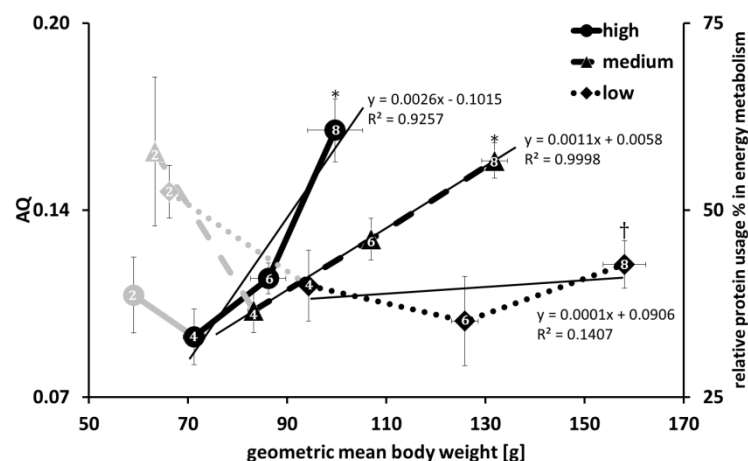
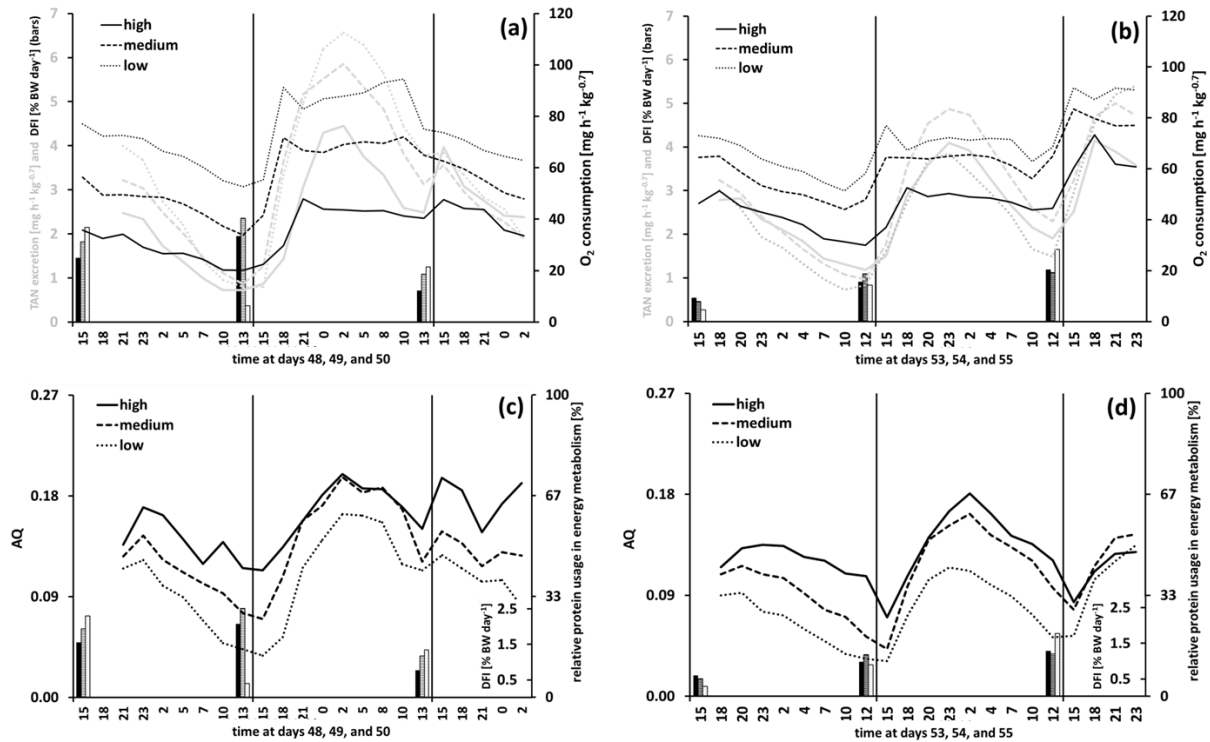

**Fig. 2-6:** Summarized biweekly ammonia quotient (AQ) measurements of turbot over two 16 h (weekly measurements; representing approximately 6 PM to 8 AM) measurements at three dissolved CO<sub>2</sub> concentration levels. Data points with a symbol are significantly different from data points that do not share the same symbol within the sampling period ( $p < 0.05$ ). Values (expressed as biweekly period: 2, 4, 6, 8) are from the measurement periods: days (4/5 + 10/11), (16/17 + 25/26), (31/32 + 39/40), (49/50 + 54/55). The three CO<sub>2</sub> treatments are high (42 mg l<sup>-1</sup>), medium (26 mg l<sup>-1</sup>), and low (5 mg l<sup>-1</sup>).

The final two metabolite flux measurement periods (days 48-50 and 53-55) were analyzed in detail to investigate the effect of dissolved CO<sub>2</sub> exposure on metabolic fuel use at almost comparable feed intake rates (Fig. 2-7). With the exception of day 49, the metabolic mass specific oxygen consumption and ammonia excretion rates increased substantially soon after

feeding (Fig. 2-7a, b). There was a clear dose-dependent relationship between CO<sub>2</sub> treatment and oxygen consumption, where oxygen uptake in the low CO<sub>2</sub> treatment was approximately 1.5-2 times the value recorded in the high treatment. In contrast to oxygen uptake, ammonia excretion rates did not vary much between treatments for the days when there was nearly comparable feed intake (Fig. 2-7a, b).

The ammonia excretion rate was standardized to the oxygen consumption rate to derive the AQ and estimated protein catabolism rates. The percentage of the metabolism powered by protein catabolism increased following feeding for all treatments (Fig. 2-7c, d). As previously observed, there was a clear dose-dependent trend in the data, with fish under the high CO<sub>2</sub> treatment consistently using more protein to power oxidative fuel use. This pattern was not related to differences in feed intake as there were almost identical feed intake rates on most of the days where high frequency AQ measurements were performed (Fig. 2-7c, d). Prior to feeding fish at days 49 and 54 from the low CO<sub>2</sub> treatment were powering around 12-14% of their metabolism via protein catabolism, which increased to a peak of 42-60% following feeding. Fish from the high CO<sub>2</sub> treatment exhibited up to 3 times the protein catabolism rates observed in the low treatment, and the medium treatment was approximately intermediate between the two (Fig. 2-7c, d).



**Fig. 2-7:** (a), (b) Metabolic mass specific total ammonia nitrogen (TAN) excretion rate (gray lines) and mean metabolic mass specific oxygen consumption rate (black lines) of turbot; and (c), (d) ammonia quotient (AQ) and estimate protein catabolism rate for the final two measurement periods of the trial. The three CO<sub>2</sub> treatments are high (42 mg l<sup>-1</sup>), medium (26 mg l<sup>-1</sup>), and low (5 mg l<sup>-1</sup>). The daily feed intake (DFI) is inset as bars into each figure: high (black), medium (white striped), and low (white dotted).

## 4 Discussion

The study described in this paper investigated the effects of chronically elevated CO<sub>2</sub> on turbot and observed previously described hypercapnic pathologies such as reduced growth, condition, and feed intake (Ben-Asher et al., 2013; Fivelstad et al., 1998; Foss et al., 2003; Musa et al., 2013; Petoichi et al., 2011), and also hitherto unknown effects on metabolic fuel use. The time period in our experiment allowed the fish to adjust to hypercapnic conditions, and all traces of compensatory growth following hypercapnic acclimation were no longer evident after approximately the second week. Thereafter all treatments exhibited stable growth trajectories. As expected, turbot growth rate followed a negative dose-dependent relationship, where the highest CO<sub>2</sub> treatment effectively halved the growth rate compared to the low treatment. The high precision dissolved CO<sub>2</sub> measurement unit employed in the

present study gives us the confidence to state that the minimum dissolved CO<sub>2</sub> threshold for growth and metabolism for turbot is below 26 mg l<sup>-1</sup>. Schram et al. (2009) discussed the effect of increased CO<sub>2</sub> concentration on turbot that occurred at reduced water flow rates in test tanks and suggested growth reduction begins at around 10 mg l<sup>-1</sup>. Flow rate reduction studies are difficult to interpret because many water quality factors change simultaneously as the turnover decreases in a tank. The reported minimum dissolved CO<sub>2</sub> threshold for growth varies considerably for marine fish (8-51 mg l<sup>-1</sup>), which reflects species-specific differences and a substantial diversity in experimental approaches to the dosing method and CO<sub>2</sub> measurement accuracy (Ben-Asher et al., 2013; Fivelstad, 2013; Fivelstad et al., 1998; Foss et al., 2003; Moran and Støttrup, 2011; Petochi et al., 2011).

The FCR was similar between treatments and the lack of a strong relationship between FCR and CO<sub>2</sub> exposure suggests that the fish were not experiencing a significant energetic cost in tissue acid-base regulation, gill ventilation and other factors that are thought necessary for homeostasis in a high CO<sub>2</sub> concentration environment (Claiborne et al., 2002; Gräns et al., 2014; Ishimatsu et al., 2008; Methling et al., 2013). The lower oxygen consumption rates of turbot from the elevated CO<sub>2</sub> treatments likewise suggest that chronic hypercapnic exposure did not impose measurable energetic cost increases.

In contrast to FCR, DFI showed a clear negative dose-dependency with CO<sub>2</sub> exposure, thus DFI differences among treatments would have been a significant contributor to differences in growth rates (Saravanan, 2013). The origin for reduced feed intake in the current study cannot be definitively identified, and there is no consensus yet on the reasons why elevated CO<sub>2</sub> concentration might decrease the amount of food ingested (Ritter, 2004). One hypothesis is that high CO<sub>2</sub> doses can have a narcotizing effect and the fish are not able to locate or hunt for feed (Yoshikawa et al., 1994). However, this was unlikely a factor in the current experiment given the nature of the feeding regime (sinking pellets fed in a relatively confined space over a long time period) and because on numerous occasions fish from the high CO<sub>2</sub> treatment



were able to ingest at least as much as fish in the other treatments. We suggest the more likely reasons for reduced DFI under high CO<sub>2</sub> conditions were either a reduction in tissue oxygen delivery capacity with subsequent consequences on digestion (as has been reported for Atlantic cod, (Tirsgaard et al., 2015)) and/or pathological effects of CO<sub>2</sub> on metabolic processes that consequently reduced appetite.

The blood hemoglobin content of turbot from the high CO<sub>2</sub> exposure in our study was significantly lower than that of the other treatments, which suggests that fish in the high CO<sub>2</sub> treatment were encountering blood oxygen transport problems. The oxygen consumption rate of turbot from the high CO<sub>2</sub> treatment also had consistently lower oxygen consumption rates. Loss of blood oxygen carrying capacity is unlikely to be a significant threat for a resting, non-digestive fish, however, in times of elevated oxygen demand, such as during intense exercise or digestion, the lowered scope for oxygen delivery can present a significant challenge (Remen et al., 2013). The lowered blood hemoglobin levels of turbot from the highest CO<sub>2</sub> treatment may be related to a lowered condition and nutritional status, or as Randall et al. (2014) and Rummer et al. (2013) suggest, environmental hypercapnia may promote oxygen delivery and thereby reduce blood hemoglobin requirements. Petoichi et al. (2011) observed reduced hemoglobin concentrations in sea bass after 45 days of chronic exposure to a CO<sub>2</sub> concentration of 51.2 mg l<sup>-1</sup>. These authors suggested that the anemia might be caused by nephrocalcinosis, which hampered the haemopoietic activity of the kidney. We did not evaluate kidney pathology in our study as nephrocalcinosis has typically only been observed in freshwater fish species (Moran and Støttrup, 2011).

Recent studies about the specific dynamic action (SDA) suggest that a loss in oxygen carrying capacity or at least reduced oxygen availability would likely have had an effect on digestion and assimilation, as these processes demand an increase in the duration of the SDA (Jordan and Steffensen, 2007; Methling et al., 2013; Tirsgaard et al., 2015). Methling et al. (2013) and Tirsgaard et al. (2015) found no effects of elevated CO<sub>2</sub> on standard metabolic rate

of European eel (*Anguilla anguilla*) and Atlantic cod (*Gadus morhua*), respectively, however, these studies reported lowered maximum metabolic rate and a reduction in the aerobic scope. If elevated CO<sub>2</sub> concentrations led to a reduced aerobic scope, which extends the SDA duration, this could be a reason for prolonged digestion time (Tirsgaard et al., 2015) and possibly a reduction in DFI. The experimental approach and frequency of oxygen consumption measurements in our study were not designed for investigating specific details about the SDA. Such studies require standardized feeding protocols plus high frequency oxygen consumption measurements. Given the considerable differences in DFI and growth rates observed in the present study, it would appear that considerable progress could be made in the field if there was more effort devoted to understanding the link between CO<sub>2</sub> exposure and appetite.

The use of automated high-precision TAN sampling in this study allowed for observations of protein catabolism rates in fish exposed to elevated CO<sub>2</sub> conditions. There was a positive dose-dependent relationship between protein catabolism rates and CO<sub>2</sub> exposure, such that by the end of the trial fish in the high CO<sub>2</sub> treatment were powering their oxidative metabolism using 1.6 times more protein than low CO<sub>2</sub> treatment fish (although this increased up to 3 times during some periods). Our finding that turbot are increasingly reliant on protein as a metabolic fuel under hypercapnia contrasts with the results of Methling et al. (2013), who did not observe a difference in AQ values in European eels exposed to varying levels of CO<sub>2</sub>. One explanation for the difference observed in fuel use in the present study could be the lowered nutritional status of turbot under hypercapnia, which caused a lack of supply of suitable metabolic fuels. Bar (2014) reviewed starvation in fish and describes three phases: (I) a short transient phase, (II) a long, protein conservation steady state phase with mainly fat oxidation as the primary energy source, and (III) a shift to protein mobilization as a main energy source. These phases might explain the shift in fuel use over time and size in our experiment if the fish from the high CO<sub>2</sub> treatments were nutritionally challenged. The CF, HSI and body

composition analyses showed fish from the high CO<sub>2</sub> treatment had proportionately more bone material, lower liver mass and reduced lipid and protein deposition compared to the low CO<sub>2</sub> treatment. These observations suggest that fish from the later treatment were nutritionally challenged despite exhibiting weight gain, while the lower ash content of the fast growing fish in the low and medium CO<sub>2</sub> treatments were likely a result of higher bone growth rates with low degrees of initial mineralization (Martens et al., 2006).

A second explanation for differences in metabolic fuel use under hypercapnia could be a more direct effect of CO<sub>2</sub> on metabolic pathways. When diurnal metabolic fuel use was investigated in detail it was observed that there was a positive dose-dependent relationship between protein catabolism and CO<sub>2</sub> exposure even on days of comparable feed intake. This suggests that the higher use of protein as a fuel source by the medium and high CO<sub>2</sub> treatments may not have been a consequence of starvation-like physiological responses, but rather the CO<sub>2</sub> was more directly altering fuel use patterns. A study of cultured hepatocytes in two species of Antarctic fish has demonstrated that CO<sub>2</sub> acidification depresses protein biosynthesis (Langenbuch and Pörtner, 2003). There is presently insufficient research into the effects of chronically elevated CO<sub>2</sub> on appetite, digestion and metabolism to evaluate which mechanisms cause changes in metabolic fuel use under hypercapnia. The results from the present study suggest that a significant portion of lost growth and condition performance of fish exposed to chronically elevated CO<sub>2</sub> can be traced to altered metabolic fuel use patterns.

## **Acknowledgements**

We thank Jan Schröder, Marcus Griese, Torge Appel, Anja Winkelbach, Marina Gronemeier, Michael Schlachter, Saskia Kröckel and Arndt von Danwitz for assistance during the experiment or final sampling as well as Carsten Dietz and Ileana V. Hinz for constructive comments and for detailed statistical advices PD Dr. Mario Hasler. We also thank the anonymous reviewers who helped improve this paper. The work was supported by the State of

Schleswig-Holstein (Project-No: 122-08-008 and 122-13-004) and by the Innovationsstiftung Schleswig-Holstein (ISH, later converted into the EKSH, Project-No: 2010-43).

## References

- Arfsten, M., Tetens, J., Thaller, G., 2010. The application of easily recorded body traits to the prediction of performance parameters in turbot. *Züchtungskunde* 82, 371-386.
- Bar, N., 2014. Physiological and hormonal changes during prolonged starvation in fish. *Canadian Journal of Fisheries and Aquatic Sciences* 71, 1447-1458.
- Ben-Asher, R., Seginer, I., Mozes, N., Nir, O., Lahav, O., 2013. Effects of sub-lethal CO<sub>2</sub>(aq) concentrations on the performance of intensively reared gilthead seabream (*Sparus aurata*) in brackish water: Flow-through experiments and full-scale RAS results. *Aquacultural Engineering* 56, 18-25.
- Bretz, F., Hothorn, T., Westfall, P., 2011. *Multiple Comparisons Using R*. CRC Press.
- Claiborne, J.B., Edwards, S.L., Morrison-Shetlar, A.I., 2002. Acid-base regulation in fishes: cellular and molecular mechanisms. *Journal of Experimental Zoology* 293, 302-319.
- Colt, J., 2006. Water quality requirements for reuse systems. *Aquacultural Engineering* 34, 143-156.
- Dosdat, A., Metailler, R., Tetu, N., Servais, F., Chartois, H., Huelvan, C., Desbruyeres, E., 1995. Nitrogen excretion in juvenile turbot, *Scophthalmus maximus* (L.), under controlled conditions. *Aquaculture Research* 26, 639 – 650.
- Fivelstad, S., 2013. Long-term carbon dioxide experiments with salmonids. *Aquacultural Engineering* 53, 40-48.
- Fivelstad, S., Haavik, H., Lovik, G., Olsen, A.B., 1998. Sublethal effects and safe levels of carbon dioxide in seawater for Atlantic salmon postsmolts (*Salmo salar* L.): ion regulation and growth. *Aquaculture* 160, 305-316.
- Foss, A., Rosnes, B.A., Oiestad, V., 2003. Graded environmental hypercapnia in juvenile spotted wolffish (*Anarhichas minor* Olafsen): effects on growth, food conversion efficiency and nephrocalcinosis. *Aquaculture* 220, 607-617.
- Gnaiger, E., 1983. Calculations of energetic and biochemical equivalents of respirometry oxygen consumption. In: Gnaiger, E., Forstener, H. (Eds.), *Polarographic Oxygen Sensors*. Springer, Berlin, pp. 337–345.
- Gräns, A., Jutfelt, F., Sandblom, E., Jonsson, E., Wiklander, K., Seth, H., Olsson, C., Dupont, S., Ortega-Martinez, O., Einarsdottir, I., Bjornsson, B.T., Sundell, K., Axelsson, M., 2014. Aerobic scope fails to explain the detrimental effects on growth resulting from warming and elevated CO<sub>2</sub> in Atlantic halibut. *Journal of Experimental Biology* 217, 711-717.
- Heuer, R.M., Grosell, M., 2014. Physiological impacts of elevated carbon dioxide and ocean acidification on fish. *American Journal of Physiology. Regulatory Integrative and Comparative Physiology* 307, R1061-R1084.
- Ishimatsu, A., Hayashi, M., Lee, K.-S., Kikkawa, T., Kita, J., 2005. Physiological effects on fishes in a high-CO<sub>2</sub> world. *Journal of Geophysical Research* 110, C09S09.
- Ishimatsu, A., Hayashi, M., Kikkawa, T., 2008. Fishes in high-CO<sub>2</sub>, acidified oceans. *Marine Ecology Progress Series* 373, 295-302.

- Jobling, M., 1981. Some Effects of Temperature, Feeding and Body-Weight on nitrogenous excretion in young plaice *Pleuronectes platessa* L. *Journal of Fish Biology* 18, 87-96.
- Jordan, A.D., Steffensen, J.F., 2007. Effects of ration size and hypoxia on specific dynamic action in the cod. *Physiological and Biochemical Zoology* 80, 178-185.
- Kutty, M.N., 1978. Ammonia quotient in sockeye salmon (*Oncorhynchus nerka*). *Journal of the Fisheries Research Board of Canada* 35, 1003-1005.
- Laird, N. M., Ware, J. H., 1982. Random-effects models for longitudinal data. *Biometrics*, 38(4), 963–974.
- Langenbuch, M., Pörtner, H.O., 2003. Energy budget of hepatocytes from Antarctic fish (*Pachycara brachycephalum* and *Lepidonotothen kempfi*) as a function of ambient CO<sub>2</sub>: pH-dependent limitations of cellular protein biosynthesis? *Journal of Experimental Biology* 206, 3895-3903.
- Lauff, R.F., Wood, C.M., 1996. Respiratory gas exchange, nitrogenous waste excretion, and fuel usage during starvation in juvenile rainbow trout, *Oncorhynchus mykiss*. *Journal of Comparative Physiology B* 165, 542-551.
- Martens, L.G., Witten, P.E., Fivelstad, S., Huysseune, A., Saevareid, B., Vikesa, V., Obach, A., 2006. Impact of high water carbon dioxide levels on Atlantic salmon smolts (*Salmo salar* L.): Effects on fish performance, vertebrae composition and structure. *Aquaculture* 261, 80-88.
- Methling, C., Pedersen, P.B., Steffensen, J.F., Skov, P.V., 2013. Hypercapnia adversely affects postprandial metabolism in the European eel (*Anguilla anguilla*). *Aquaculture* 416, 166-172.
- Moran, D., Stottrup, J.G., 2011. The effect of carbon dioxide on growth of juvenile Atlantic cod *Gadus morhua* L. *Aquatic Toxicology* 102, 24-30.
- Musa, S., Kisii, K., Thorarensen, H., 2013. The effects of oxygen saturation and carbon dioxide concentration on the growth and feed conversion of Aquaculture fish. *UNU-Fisheries Training Programme*.
- Petochi, T., Di Marco, P., Priori, A., Finoia, M.G., Mercatali, I., Marino, G., 2011. Coping strategy and stress response of European sea bass *Dicentrarchus labrax* to acute and chronic environmental hypercapnia under hyperoxic conditions. *Aquaculture* 315, 312-320.
- Poxton, M.G., Allouse, S.B., 1982. Water quality criteria for marine fisheries. *Aquacultural Engineering* 1, 153-191.
- R Core Team, 2013. R: A language and environment for statistical computing. R Foundation for Statistical Computing, Vienna, Austria. ISBN 3-900051-07-0, (URL <http://www.R-project.org/>).
- Randall, D., Rummer, J., Wilson, J., Wang, S., Brauner, C., 2014. A unique mode of tissue oxygenation and the adaptive radiation of teleost fishes. *Journal of Experimental Biology* 217, 1205-1214.
- Remen, M., Oppedal, F., Imsland, A.K., Olsen, R.E., Torgersen, T., 2013. Hypoxia tolerance thresholds for post-smolt Atlantic salmon: dependency of temperature and hypoxia acclimation. *Aquaculture* 416, 41-47.
- Ritter, R.C., 2004. Gastrointestinal mechanisms of satiation for food. *Physiology & Behavior* 81, 249-273.
- Robbins, L.L., Hansen, M.E., Kleypas, J.A., Meylan, S.C., 2010. CO<sub>2</sub>calc—a user-friendly seawater carbon calculator for Windows, Max OS X, and iOS (iPhone). *US Geological Survey Open-File Report* 1280 (17), 2010.
- Rummer, J.L., McKenzie, D.J., Innocenti, A., Supuran, C.T., Brauner, C.J., 2013. Root-effect hemoglobin may have evolved to enhance general tissue oxygen delivery. *Science* 340, 1327-1329,

## CHAPTER 2

### The effect of carbon dioxide on growth and metabolism in juvenile turbot *Scophthalmus maximus* L.

- Saravanan, S., 2013. Feed intake and oxygen consumption in fish (Doctoral dissertation), Wageningen University, Wageningen, NL, p. 164.
- Schaarschmidt, F., Vaas, L., 2009. Analysis of trials with complex treatment structure using multiple contrast tests. *HortScience*, 44(1), 188-195.
- Schram, E., Verdegem, M.C.J., Widjaja, R.T.O.B.H., Kloet, C.J., Foss, A., Schelvis-Smit, R., Roth, B., Imstrand, A.K., 2009. Impact of increased flow rate on specific growth rate of juvenile turbot (*Scophthalmus maximus*, Rafinesque 1810). *Aquaculture* 292, 46-52.
- Stiller, K.T., Moran, D., Vanselow, K.H., Marxen, K., Wuertz, S., Schulz, C., 2013. A novel respirometer for online detection of metabolites in aquaculture research: evaluation and first applications. *Aquacultural Engineering* 55, 23-31.
- Timmons, M.B., Ebeling, J.M., 2010. *Recirculating Aquaculture*. second ed. Cayuga Aquaculture Ventures, Ithaca, New York.
- Tirsgaard, B., Moran, D., Steffensen, J.F., 2015. Prolonged SDA and reduced digestive efficiency under elevated CO<sub>2</sub> may explain reduced growth in Atlantic cod (*Gadus morhua*). *Aquatic Toxicology* 158, 171-180.
- Verbeke, G., Molenberghs, G., 2009. *Linear mixed models for longitudinal data*. Springer Verlag, Inc., New York.
- Waller, U. 1992. Factors influencing routine oxygen consumption in turbot, *Scophthalmus maximus*. *Journal of Applied Ichthyology* 8, 62-71.
- Wedemeyer, G., 1996. *Physiology of fish in intensive culture systems*. Springer Science & Business Media.
- Weiss, R.F., 1974. Carbon dioxide in water and seawater: the solubility of an on-ideal gas. *Marine Chemistry* 2, 203-215.
- Yoshikawa, H., Kawai, F., Kanamori, M., 1994. The relationship between the EEG and brain pH in carp, *Cyprinus carpio*, subjected to environmental hypercapnia at an anesthetic level. *Comparative Biochemistry Physiology A* 107, 307-312.

## CHAPTER 3

### **The effect of diet, temperature and intermittent low oxygen on the metabolism of rainbow trout**

Kevin T. Stiller<sup>abc</sup>, Klaus H. Vanselow<sup>a</sup>, Damian Moran<sup>d</sup>, Guido Riesen<sup>e</sup>, Wolfgang Koppe<sup>e</sup>,  
Carsten Dietz<sup>f</sup> and Carsten Schulz<sup>bc</sup>

<sup>a</sup> Forschungs- und Technologiezentrum Westküste, Christian-Albrechts-Universität zu Kiel,  
Hafentörn 1, 25761 Büsum, Germany

<sup>b</sup> Gesellschaft für Marine Aquakultur, Hafentörn 3, 25761 Büsum, Germany

<sup>c</sup> Institute of Animal Breeding and Husbandry, Christian-Albrechts-Universität zu Kiel,  
Olshausenstraße 40, 24098 Kiel, Germany

<sup>d</sup> Seafood Technologies Group, Plant and Food Research, Nelson 7010, New Zealand

<sup>e</sup> Skretting Aquaculture Research Centre, Sjøhagen 15, 4016 Stavanger, Norway

<sup>f</sup> Georg-August-Universität, Wilhelmsplatz 1, 37073 Göttingen, Germany

---

## **Abstract**

An automated recirculating aquaculture respirometer system was used to measure oxygen consumption, protein catabolism as ammonia quotient and the energy budget to evaluate whether the crude protein content of a standard diet (SP) (42.5% crude protein) or a high protein (HP) diet (49.5% crude protein) influences metabolism in rainbow trout under challenging intermittent low dissolved oxygen concentrations. Three temperature phases (12 °C, 16 °C, 20 °C) were split in two oxygen periods with 5 days of unmanipulated oxygen levels (50-70%), followed by 5 days of a manipulated oxygen period (4 PM-8 AM) with low oxygen (40-50%) levels. Protein catabolism was temperature independently 40% higher for the HP diet, not influenced by low oxygen events and lowest at 16 °C for both diets. Compared to the unmanipulated oxygen period, the manipulated oxygen period resulted in an increase in oxygen consumption (SP=11%, HP=6%), decrease in retained energy and stronger lowering of the retained energy at higher temperatures for fish fed the SP diet. The HP diet appeared to moderate the degree of change in oxygen consumption and retained energy during the manipulated oxygen period, however, there was no net benefit over the SP diet as the HP diet was associated with a generally higher oxygen consumption (0-8%) and lower retained energy (1.9–4.8% digestible energy). In this study a HP diet was not found to have obvious benefits over a SP diet especially in case of catabolic protein usage.



# 1 Introduction

The water quality within fish farming systems can vary substantially according to a multitude of biotic (e.g. stocking density, feeding rates, microbial loading) and abiotic (e.g. temperature, aeration and water turnover rates) factors. The dissolved oxygen (DO) concentration and temperature are important water quality variables that affect fish metabolism and health (Brett, 1979; Carter et al., 2008; Colt, 2006; Kramer, 1987; Wang et al., 2009), and the level of DO can change rapidly due to biotic and abiotic forcings. Diurnal fluctuations in DO due to photosynthesis, increasing temperature and varying water exchange in net cages or flow through systems are probably one of the most pronounced water quality changes most farmed fish endure (Davis, 1975; Johansson et al., 2006; Remen et al., 2013). Low DO levels are likely to occur during intensive fish oxygen consumption (OC) associated with feed ingestion and digestion (Eliason and Farrell, 2014; Jordan and Steffensen, 2007; Svensen et al., 2011; Tirsgaard et al., 2015). Additionally, partial DO depletion or intermittent hypoxia can be amplified at night when phytoplankton switches from photosynthesis to respiration (Taylor and Miller, 2001). Furthermore, water exchange through sea net cages varies according to the tidal currents, and slack tides lead to stagnant water periods four times per day. Fish producers in Norway, Chile, Canada and Australia have reported intermittent sub-optimum environmental conditions for salmonid fish production (Carter et al., 2008), however, the impact of temporary diurnal DO limitations on fish physiology is not often studied (Farrell and Richards, 2009).

Chronic sub-lethal hypoxia can cause growth reduction due to reduced appetite, alteration of metabolic pathways, reallocation of energy resources, poor assimilation efficiency, and prolonged digestion (Wang et al., 2009). Davis (1975) summarised DO threshold levels for rainbow trout (*Oncorhynchus mykiss*) at various temperatures (8-20 °C) and animal sizes (larva-1.1 kg), and concluded that the effective threshold was in the range of 50-64% DO

saturation ( $DO_{\text{sat}}$ ). Below this level, blood was less oxygenated, circulatory changes such as a slowing heart frequency occur along with reduction of maximum swimming speed, altered respiratory quotient, elevated breathing amplitude and elevated buccal pressure (Cameron, 1971; Hughes and Saunders, 1970; Itazawa, 1970; Jones, 1971; Kramer, 1987; Kutty, 1978; Randall and Smith, 1967). Compared to our understanding about respiratory physiology, much less is known how chronic or intermittent hypoxia affects digestion and growth in fish. Low oxygen conditions have been observed to alter the Specific Dynamic Action (SDA) of digestion and nutrient assimilation (Wang et al., 2009).

It has been calculated in animal physiology that the production of 1 KJ of energy via ammonotelic catabolism of protein theoretically requires 2.5 mg more  $O_2$  than lipid and 7 mg more  $O_2$  than glucose (Heldmaier and Neuweiler, 2004), which might mean that protein is metabolised differentially according to DO availability. From an aquaculture perspective, it is more desirable to utilise dietary amino acids for body growth rather than as a metabolic fuel source. Carter et al. (2008) summarised the strategic needs to study interactions between diet composition and environmental parameters, and suggested that protein metabolism needs particular attention to maximise growth under limiting environmental conditions. This has led to research into special application feeds for ‘challenging’ conditions such as waters with suboptimal temperature and DO levels (Carter et al., 2008; Glencross, 2009; Glencross and Rutherford, 2010; Glencross et al., 2014; Saravanan, 2013). The idea behind such feeds is that the loss of fish condition normally associated with challenging environments (e.g. diurnal fluctuations in DO levels) can be compensated for tuning the dietary macro- and micronutrient composition. In this paper we attempt to broaden our understanding of fish protein metabolism under diurnal DO variations at different temperatures using juvenile rainbow trout as a model species.

## 2 Material and methods

### 2.1 *Experimental fish and diets*

Juvenile rainbow trout (weight =  $64.9 \pm 6.0$  g) were obtained from the hatchery Forellenzucht Trostadt GbR (Trostadt, Germany). The experimental fish were acclimated to six respirometer tanks (described below) for three weeks prior to the experiment while being fed a standard commercial diet (Skretting Optiline HE, 4.0 mm, Italy, Macro nutrient profile: crude protein 43.0%, crude fat 26.0%, ash 6.0%, fibre 3.0%) at 12 °C. During the acclimation period, the fish were fed by hand in order to determine the absolute amount of feed the animals could ingest. The maximum ingestion quantity was determined to be  $1.37 \pm 0.45$  % of body weight (BW), and this information was used to set the 1% BW ration size in the experiment, a portion size that was completely consumed with no wastage. In the trial two experimental fish groups were fed with iso-energetic diets of varying protein content (digestible energy =  $19.5 \text{ kJ g}^{-1}$  dry matter (DM)) produced at Skretting ARC Technology Plant (Stavanger, Norway). Table 1 gives the feed composition of the two experimental diets. The Standard Protein (SP) diet with 42.5% crude protein was similar to existing commercial diets, while the High Protein (HP) diet contained 49.5% crude protein. The HP diet was compounded isoenergetic to the SP diet by lowering the fat and starch content and increasing the wheat gluten inclusion (Table 3-1). Diets were designed to meet amino acid needs of the animals (NRC, 1993). Feeding started at 10 AM in tank 1 and continued for 12 min before moving onto the next tank steps until the feeding was finished.

**Table 3-1:** Nutrient composition, digestible energy, ingredients and chemical composition of the test diets. Pellet size 4 mm.

Diet	SP	HP
<i>Ingredient and proximate composition [g kg<sup>-1</sup>]</i>		
Wheat (Svenska Lantmannen / Sweden)	131	<b>81</b>
Corn gluten (Cargill Nordic AS / UK)	50	50
Wheat gluten (Cargill Nordic AS / UK)	100	<b>200</b>
Soy protein concentrate (Imcopa / Brasil)	300	300
Purified cellulose (Arcon AS, Norway)	9	0
NA Fishmeal (Welcon AS, Norway)	150	150
Fish oil Nordic (Nordsildmel, Norway)	236	<b>196</b>
AA, Vitamin, Mineral premix* (Trouw, Netherlands)	23	22
Yttrium premix (Trouw, Netherlands)	1	1
<i>Proximate composition [%]</i>		
Dry matter	93.5	93.5
Moisture	6.5	6.5
Crude protein	<b>42.5</b>	<b>49.5</b>
Crude fat	27.3	<b>23.6</b>
Starch	8.6	<b>6.4</b>
Crude fiber	2.8	<b>2.2</b>
Digestible energy [DE <sub>diet</sub> ; kJ g <sup>-1</sup> DM]	19.8	19.8
Gross energy [GE <sub>diet</sub> ; kJ g <sup>-1</sup> DM]	23.4	23.2

\* Recommendation after NRC (1993)

## 2.2 Chemical analysis of the diet

Almost all chemical feed analyses were done in the Skretting ARC laboratory, Stavanger. Dry matter was done gravimetrically by drying the feed for 18 hours at 105 °C. A Kjeltac 2400 Auto System (FOSS Analytical, Denmark) was used to determine the total nitrogen (N) for calculating the protein content (N x 6.25). Nuclear Magnetic Resonance (Maran Ultra NMR, Resonance Instruments Ltd, Witney, UK) was used for measuring the fat concentration. The starch content was determined according to Mcleary et al., 1994 and the crude fiber content according to ISO 6865 (ISO 2000). Gross energy was measured in a (isoperibol) bomb calorimeter (Parr 1281, USA) at Nofima BioLab (Fyllingsdalen, Norway).

### 2.3 *Experimental setup*

For each diet there were three replicate tanks. The experiment was divided in three 16 day rearing temperature phases (TP) (12, 16 and 20 °C, as illustrated in Fig. 3-1). The sequential testing of temperature over time rather than simultaneous testing of temperature alongside the other variables was a constraint imposed by the experimental set up with one water body in the recirculating respirometer system. Temperature acclimation from 12-16 °C and 16-20 °C was done in 1 °C day<sup>-1</sup> increments over 4 days. Following temperature acclimation, five days of respirometer measurements were performed at the maximum tank water inflow rate (300 l h<sup>-1</sup>) (hereafter called the unmanipulated oxygen (UO) period) followed by five days of decreased nightly water inflow, which created a partial low oxygen challenge for the fish (hereafter called the manipulated oxygen (MO) period). To maintain a comparable circular current in the test tanks an additional pump was installed (Stiller et al., 2013). The target oxygen level during the night in the MO period was 40-50 DO<sub>sat</sub>, which corresponded to water inflow of 150, 200, and 225-250 l h<sup>-1</sup> at 12, 16 and 20 °C, respectively. The oxygen challenge was initiated at 4 PM by the use of controllers to decrease water inflow. At 08:00 the next morning the controllers increased water flow rates. Once the MO period finished the fish were fasted for a day and then individual and bulk weighing occurred (Fig. 3-1). At the start of every experimental TP the tank biomass was adjusted to approximately 3.70 kg via the removal of individuals following individual and bulk weighing. At the beginning of the experiment (12 °C) there were 50 fish with a mean weight of 73.4 ± 13.0 g per tank, which was decreased to 42 fish with a mean weight of 90.2 ± 21.8 g at 16 °C and 35 fish with a mean weight of 105.5 ± 30.0 g per tank 20 °C, respectively.

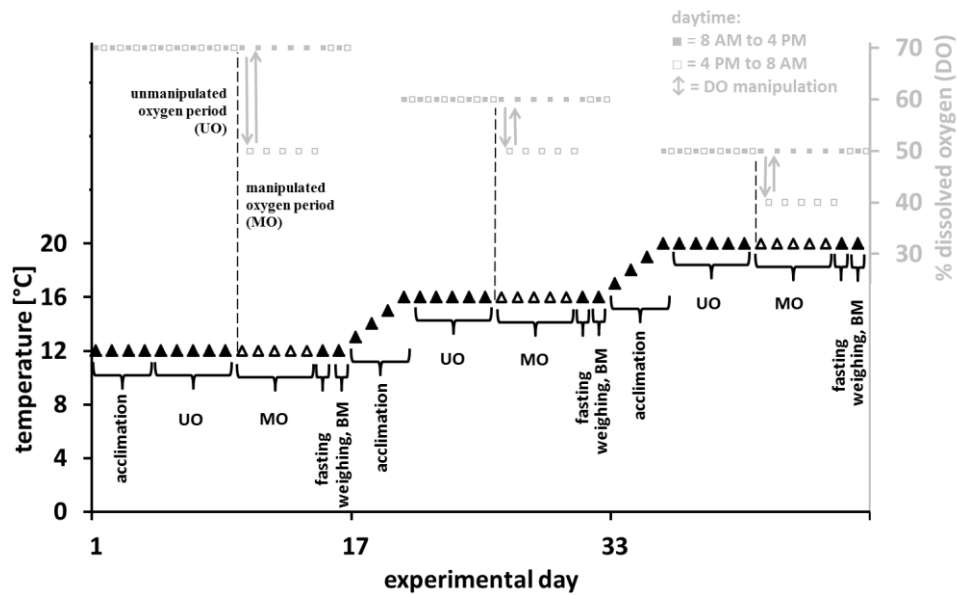

**Fig. 3-1:** Experimental setup for the three temperature phases (12, 16 and 20 °C). 4 days acclimation, 5 days unmanipulated oxygen (UO) period, 5 days manipulated oxygen (MO) period, 1 day fasting and 1 day weighing / biomass reduction (BM). Arrows indicate the time of down and upregulation of dissolved oxygen saturation during the periods.

## 2.4 Fish husbandry and respirometer system

The experiment was performed in a recirculating aquaculture respirometer system (RARS) designed for growth studies described in detail in (Stiller et al., 2013; Stiller et al., 2014). The system consisted of 10 tanks of which 7 were used (250 l volume each) included in a recirculating aquaculture system with mechanical (sedimentation) and biological (trickling filter) treatment units. The system utilises a flow-through approach to measure respiration, where the water metabolite concentration of each tank is measured sequentially by a suite of water chemistry analysers. Respiration rates are calculated based on the differences between test and reference tank metabolite values and water flow rates, with a correction to account for the wash-out effect. Details about the methods used to calculate respiration rates are given in Stiller et al. (2013).

The water chemistry analysis unit measured the following parameters: oxygen ( $O_2$ ) concentration (amperometric electrode, dTRANS O2 01; JUMO GmbH & Co. KG, Fulda, Germany); water pH (intermediate junction electrode, Ionode IJ44, TPS Pty Ltd, Brisbane,

Australia); temperature (thermocouple); total ammonia nitrogen (TAN) (loop flow orthophthalaldehyde fluorometric autoanalyser,  $\mu$ Mac, SYSTEA S.p.A., Anagni, Italy) and dissolved carbon dioxide (CO<sub>2</sub>) (flow through headspace analyser with non-dispersive infra-red detection, SubCtech GmbH, Kiel, Germany). Analysers were calibrated daily. The daily data acquisition was 12 measurements per day and tank, corresponding to a two hour measuring cycle in which every tank was measured successively. The data from six tanks containing fish are presented in this paper. The nitrite [mg l<sup>-1</sup>] (Microquant; Merck KGaA, Germany) concentration and hardness [°dH] (Aquamerck, Merck KGaA, Germany) of the recirculating water body was recorded daily using commercial test kits.

## **2.5 Growth performance**

Individual body wet weight and whole tank wet weight (biomass) in g were determined on day 0, 16, 32 and 48. After weighing the individuals of a particular tank the group were placed in a different tank to account for any tank-specific effects. Trout were anaesthetised using tricaine methanesulfonate (MS-222; Sigma-Aldrich, Germany) before the weighing procedure started. Specific growth rate (SGR, % weight gain per day) was calculated from the tank biomass using the formula  $SGR = (\ln(\text{end biomass}) - \ln(\text{start biomass})) / 14 \text{ days} \times 100$ . Feed conversion ratio (FCR) was calculated using the mass of food ingested and group weight as  $FCR = \text{feed intake [g]} / \text{weight gain [g]}$ .

## 2.6 *Metabolic data*

Oxygen consumption (OC) and total ammonia nitrogen (TAN) excretion rates were calculated according to the difference between the tanks housing fish and the fish-less reference tank (including microbial background respiration), along with a correction to account for the washout effect, as outlined in Stiller et al. (2013). The metabolic rates of a measuring cycle were normalised to a daily specific calculated metabolic body weight (MBW) and expressed as  $[\text{mg h}^{-1} \text{kg}^{-0.8}]$  (Azevedo et al., 1998; Cho and Kaushik, 1985; Killen et al., 2010). The degree of protein utilisation for energy metabolism was estimated using the ammonia quotient (AQ) (Stiller et al., 2015), where values of 0.27 and 0 correspond to 100% and 0%, respectively, of aerobic energy demand met by amino acid catabolism (Gnaiger, 1983). The quotient for 100 % protein usage differs in literature (0.27 – 0.33, (Gnaiger, 1983; Kutty, 1978)), hence, the protein utilisation rates given in this paper are estimates, but sufficient for comparing relative treatment effects within a study. The AQ does not account for any excreted urea, whereas the nitrogen quotient does (Lauff and Wood, 1996a, b; Lauff and Wood, 1997). However, the AQ is likely to be close to the nitrogen quotient as teleost fish excrete the majority of nitrogenous waste as ammonia (Dostat et al., 1995; Dostat et al., 1996; Dalsgaard et al., 2015; Kajimura et al., 2004; Wood, 2001). In our study the AQ was calculated as excreted TAN [mol] / consumed O<sub>2</sub> [mol].

The last day of the five day DO period was used for calculating metabolic response in order to ensure longest animal environmental acclimatisation. The mean values between 10 PM-2 AM and 10 AM-2 PM were chosen for direct comparison between the UO and MO period of the experiment as these time blocks had the most constant readings within a diurnal curve of metabolite measurements and was deemed best for quantitative comparison for day and night response.



## 2.7 *Energy budget*

To estimate an average daily OC and TAN excretion for the EB, mean values from 12 PM to 6 AM were calculated for every tank on the fifth day of each DO period (periods of cleaning and the period from 4 to 6 PM when the water inflow was downregulated for the MO treatment were excluded). The EB was calculated on a daily basis and all results are given in  $\text{kJ kg}^{-0.8} \text{d}^{-1}$ . Calculations of the EB components were as follows:

Gross Energy intake ( $\text{GE}_{\text{in}}$ ) per day:

$$\text{GE}_{\text{diet}} [\text{kJ g}^{-1} \text{DM}] \times \text{FI} [\text{g DM d}^{-1}] / \text{MBW} [\text{kg}^{-0.8}];$$

Digestible Energy intake ( $\text{DE}_{\text{in}}$ ) per day:

$$\text{DE}_{\text{diet}} [\text{kJ g}^{-1} \text{DM}] \times \text{FI} [\text{g DM d}^{-1}] / \text{MBW} [\text{kg}^{-0.8}];$$

$\text{DE}_{\text{diet}} = 19.8 \pm 0.2 \text{ kJ g}^{-1}$ ;  $\text{HP} = 19.8 \pm 0.5 \text{ kJ g}^{-1}$ . Digestible energy were calculated according to Dietz et al. (2013). Faeces were collected by stripping following the main experiment. Due to limiting fish numbers the  $\text{DE}_{\text{diet}}$  was only determined at 16 °C. Analysis of dietary, faecal energy and yttrium were done at Nofima BioLab (Fyllingsdalen, Norway) and at Skretting ARC (Stavanger, Norway), respectively.

Energy of non-fecal Nitrogen (EN):

TAN excretion plus estimated urea fraction [85 %  $\text{NH}_3$  + 15 % Urea; (Dostat et al., 1995; Dostat et al., 1996; France and Kebreab, 2008),  $\text{g day}^{-1}$ ] x energy of excreted protein [energetic equivalents for ammonia N =  $24.9 \text{ kJ g}^{-1}$  and urea N =  $23.1 \text{ kJ g}^{-1}$  (Elliott and Davison, 1975); estimated N content of protein = 16%,  $\text{kJ g}^{-1}$ ] /  $\text{MBW} [\text{kg}^{-0.8}]$ ;

Metabolisable Energy (ME):

$$\text{DE}_{\text{in}} - \text{EN}.$$

Retained Energy (RE):

$\text{ME} - (\text{mean average feeding oxygen consumption} [\text{g d}^{-1}] \times 13.6 \text{ kJ g}^{-1})$  (Dietz et al., 2013).

RE includes SDA and maintenance energy;

Specific Dynamic Action (SDA):

In this study the fasting day was used to define the baseline metabolism without the costs imposed by the SDA and associated feeding activity. To derive the OC associated with the SDA, the mean OC rate at fasting was subtracted from the OC at a specific experimental period. The energetic value was derived by using the conversion factor of 13.6 kJ per g consumed O<sub>2</sub> (Elliott and Davison, 1975).

## **2.8**      *Statistical analysis*

The software package R (R Core Team, 2013) was used to statistically evaluate the data. According to the recommendations of Thorarensen et al. (2015), the data evaluation was based on an appropriate mixed model (Laird and Ware, 1982; Verbeke and Molenberghs, 2009). The data were modelled as normally distributed and heteroscedastic. The model included diet (SP, HP), temperature (12, 16, 20 °C), time of day (day, night) and oxygen condition (UO, MO), as well as all their interaction terms (two-, three- and four-fold) as fixed factors. The fish group and its interaction with time of day were regarded as random factors. Also, the interactions of the measurement values due to the several levels of experimental day were taken into account. The model was used to investigate differences between treatments via analysis of variance (ANOVA) and multiple contrast tests (Bretz et al., 2011; Schaarschmidt and Vaas, 2009). For the growth variables and whole body analysis the same repeated measures approach was used, with a simplified model only including diet, temperature and their interaction term as a fixed factor. Digestibility data was compared using a t-test. For all statistical analyses differences were considered to be significant at  $p < 0.05$ .

## 3 Results

### 3.1 *Water quality variables*

With the exception of DO concentrations, the water quality during the trial was maintained in a state that would be considered as not harmful for fish health or growth. Nitrite values ranged between 0.2 to 0.3 mg l<sup>-1</sup>, hardness from 5.5 to 8.3 °dH, pH between 6.0 to 8.1 (Hjeltnes et al., 2012), dissolved CO<sub>2</sub> below 8.2 mg l<sup>-1</sup> (Good et al., 2010) and TAN below 0.4 mg l<sup>-1</sup> (Hjeltnes et al., 2012; Schreckenbach, 2002). Figure 2 gives an overview of the daily pattern of DO concentrations and TAN concentrations of the tanks throughout the trial. The DO tank concentrations decreased substantially with increasing temperature for both the unmanipulated oxygen (UO) and manipulated oxygen (MO) period as a result of lowered O<sub>2</sub> solubility at elevated temperature. Consequently the DO concentrations at the maximum water inflow of 300 l h<sup>-1</sup> varied between the three temperature phases (TP) even though the feeding rate and biomass were almost constant for each TP. The effect of a down regulation of water inflow at 4 PM during the MO period can be seen as an abrupt decrease in DO concentration (Fig. 3-2). The daily pattern of TAN concentration in the test tanks gives a clear increase in NH<sub>3</sub> after the 10 AM feeding, and was consistently higher for the HP diet (Fig. 3-2). At the 16 °C and 20 °C TP the TAN concentrations slightly increased over the experimental days. The representative DO concentrations at the last (5<sup>th</sup>) day of each DO period (8 AM-4 PM) were

$$\text{UO} = 7.6 \pm 0.3 \text{ mg l}^{-1} / \text{MO} = 7.2 \pm 0.3 \text{ mg l}^{-1} \text{ (70\% DO}_{\text{sat}}) \text{ at } 12 \text{ }^{\circ}\text{C},$$

$$\text{UO} = 5.7 \pm 0.2 \text{ mg l}^{-1} / \text{MO} = 5.4 \pm 0.2 \text{ mg l}^{-1} \text{ (60\% DO}_{\text{sat}}) \text{ at } 16 \text{ }^{\circ}\text{C} \text{ and}$$

$$\text{UO} = 4.6 \pm 0.1 \text{ mg l}^{-1} / \text{MO} = 4.1 \pm 0.2 \text{ mg l}^{-1} \text{ (50\% DO}_{\text{sat}}) \text{ at } 20 \text{ }^{\circ}\text{C}$$

(Fig. 2-2). During the night (4 PM-8 AM) the DO values were

$$\text{UO} = 7.7 \pm 0.2 \text{ mg l}^{-1} \text{ (70\% DO}_{\text{sat}}) / \text{MO} = 5.0 \pm 0.3 \text{ mg l}^{-1} \text{ (50\% DO}_{\text{sat}}) \text{ at } 12 \text{ }^{\circ}\text{C},$$

UO =  $6.1 \pm 0.3 \text{ mg l}^{-1}$  (60% DO<sub>sat</sub>) / MO =  $4.5 \pm 0.2 \text{ mg l}^{-1}$  (50% DO<sub>sat</sub>) at 16 °C and

UO =  $4.7 \pm 0.2 \text{ mg l}^{-1}$  (50% DO<sub>sat</sub>) / MO =  $3.4 \pm 0.2 \text{ mg l}^{-1}$  (40% DO<sub>sat</sub>) at 20 °C.

There were no obvious differences in fish behaviour observed at the different DO periods or TP.

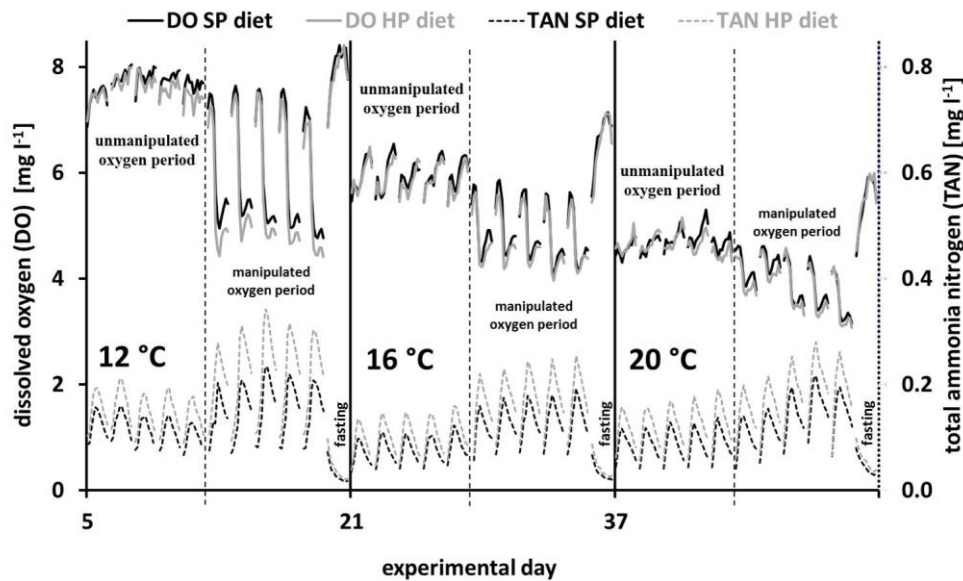

**Fig. 3-2:** Dissolved oxygen and total ammonia nitrogen concentrations in the test tanks stocked with rainbow trout fed a standard protein diet (SP = 42.5% crude protein) and a high protein diet (HP = 49.5% crude protein). Data were recorded at three temperatures and under an unmanipulated oxygen period and a manipulated oxygen period. Fasting days are also reported.

### 3.2 Growth performance

No significant differences were detected between the diets in weight gain, feed intake, SGR or FCR (all comparisons  $p > 0.05$ ). Despite a lack of difference between diets, there were clear differences over time as the fish grew and were exposed to different temperature blocks. The SGR decreased from  $1.27\% \text{ day}^{-1}$  to  $0.81\text{-}0.87\% \text{ day}^{-1}$ , and the FCR increased from 0.78 to 1.20-1.27 (Table 2).

**Table 3-2:** Comparison of growth variables of rainbow trout fed the standard protein (SP; 42.5% crude protein) and the high protein (HP; 49.5% crude protein) diet for three temperature periods.

Temperature period	12°C						16°C						20°C						Post hoc test between temperature blocks within the same diet					
	SP		HP		SP		HP		SP		HP		SP		HP		SP		HP		SP		HP	
	50	50	50	50	42	42	42	42	35	35	35	35	12 vs 16 °C	12 vs 20 °C	16 vs 20 °C	12 vs 16 °C	12 vs 20 °C	16 vs 20 °C	12 vs 16 °C	12 vs 20 °C	16 vs 20 °C			
Number of fish	50	50	50	50	42	42	42	42	35	35	35	35												
Start weight [g]	73.2 ± 12.8	73.5 ± 13.2	89.6 ± 22.5	88.8 ± 21.4	90.4 ± 22.3	90.4 ± 21.9	103.0 ± 31.3	104.1 ± 32.4	105.2 ± 31.4	105.6 ± 30.4	120.7 ± 40.64	119.2 ± 38.9	*	*	*	*	*	*	*	*	*	*	*	
End weight [g]	3654.7 ± 8.2	3656.9 ± 6.0	3707.9 ± 28.0	3734.1 ± 5.9	3707.9 ± 28.0	3734.1 ± 5.9	4302.2 ± 57.6	4334.3 ± 17.1	4141.0 ± 46.3	4114.5 ± 27.8	466.4 ± 5.4	439.9 ± 33.3	*	*	*	*	*	*	*	*	*	*	*	
Start biomass [g]	709.6 ± 14.1	713.0 ± 25.5	555.4 ± 1.2	555.8 ± 1.0	594.30 ± 29.7	600.2 ± 17.8	563.46 ± 4.25	567.5 ± 0.9	558.1 ± 6.7	558.4 ± 2.4	594.30 ± 29.7	600.2 ± 17.8	*	*	*	*	*	*	*	*	*	*	*	
End biomass [g]	1.27 ± 0.02	1.27 ± 0.0	1.06 ± 0.04	1.06 ± 0.03	1.06 ± 0.04	1.06 ± 0.03	1.06 ± 0.04	1.06 ± 0.03	0.85 ± 0.00	0.81 ± 0.06	0.85 ± 0.00	0.81 ± 0.06	*	*	*	*	*	*	*	*	*	*	*	
WG [g]	0.78 ± 0.01	0.78 ± 0.0	0.95 ± 0.04	0.95 ± 0.03	0.95 ± 0.04	0.95 ± 0.03	0.95 ± 0.04	0.95 ± 0.03	1.20 ± 0.01	1.27 ± 0.10	1.20 ± 0.01	1.27 ± 0.10	*	*	*	*	*	*	*	*	*	*	*	
FI [g]																								
SGR (% d <sup>-1</sup> )																								
FCR																								

WG = weight gain; SGR = specific growth rate for 14 feeding days; FI = feed intake; FCR = feed conversion ratio. Values are mean ± SD. Post hoc test columns indicate significant differences (\*) between temperature blocks within a diet. No significant differences were detected between the diets within each temperature period (p < 0.05).

### 3.3 *Metabolic variables*

#### 3.3.1 *Oxygen*

Figure 3-2 summarises the diurnal pattern in DO concentration throughout the experiment. The large changes in DO concentration within each temperature block shown in Figure 2 are due to spontaneous activity associated with feeding and the SDA, and the effect of fasting is evident in all profiles as a drastic increase in DO concentration. Elevated temperatures were seen to decrease the DO concentration. The DO concentration profiles of the two diets broadly overlapped, however, at 12 °C the HP diet was generally below the SP diet (Fig. 3-2).

Table 3-3 compares the day and night mass specific oxygen consumption (OC) on the final feeding day of each two DO periods and the three TP. Temperature had a strong effect on OC ( $F_{2,40} = 39.7$ ,  $p < 0.01$ ), where a 4 °C rise in temperature lead to an increase in OC of around 20 mg kg<sup>-0.8</sup> h<sup>-1</sup>, which was equivalent to a 25-30% elevation. The DO period was also observed to have a significant effect on OC ( $F_{1,40} = 4.4$ ,  $p = 0.04$ ). There was a general trend for a 3-14% higher mean OC in the MO period compared to the UO period for the same diet and time of day, however, the differences were only statistically significant for 16 °C for both diets and at 20°C for the SP diet (see Table 3-3). By comparing the nighttime DO periods for the SP diet there was 11% higher OC in the MO period for 16 °C and 20 °C. This difference in OC could not be detected by trout fed with the HP diet where the highest difference was 6%. As was observed in the continuous time plot of Figure 2 of the DO concentrations in the tanks, the mean OC of fish fed the SP diet tended to be lower (0-8%) than that of fish fed the HP diet under equivalent conditions (Table 3-3), however, this difference was not statistically significant ( $F_{1,4} = 3.2$ ,  $p = 0.15$ ).

**Table 3-3:** Comparison of the effect of diet protein content and post hoc test results on mass specific oxygen consumption [ $\text{mg kg}^{-0.8} \text{h}^{-1}$ ] of rainbow trout fed a standard protein diet (SP = 42.5% crude protein) and a high protein diet (HP = 49.5% crude protein) under an unmanipulated oxygen (UO) period and a manipulated oxygen (MO) period. Data is divided into the mean values from 10AM-2PM (= day values) and 10PM-2AM (= night values). Day and night data was used from the 5<sup>th</sup> day of UO and MO period from every temperature phase.

Period	Unmanipulated DO			Manipulated DO			Post hoc test between DO periods		
	SP	HP	post hoc test	SP	HP	post hoc test	SP	HP	
12 °C	<b>Day 10AM-2PM</b>								
	119.8 ± 2.4 <sup>a</sup>	128.6 ± 8.4 <sup>a</sup>	-	128.9 ± 5.8 <sup>a</sup>	139.3 ± 16.3 <sup>a</sup>	-	-	-	
	146.9 ± 4.8 <sup>b</sup>	152.0 ± 4.4 <sup>b</sup>	-	156.0 ± 1.8 <sup>b</sup>	162.8 ± 2.3 <sup>b</sup>	-	*	*	
20 °C	164.2 ± 7.4 <sup>c</sup>	173.5 ± 5.2 <sup>c</sup>	-	186.4 ± 7.0 <sup>c</sup>	186.1 ± 3.4 <sup>c</sup>	-	*	-	
12 °C	<b>Night 10PM-2AM</b>								
	111.8 ± 5.7 <sup>a</sup>	122.2 ± 6.2 <sup>a</sup>	-	118.5 ± 1.8 <sup>a</sup>	125.8 ± 3.2 <sup>a</sup>	-	-	-	
	128.0 ± 1.2 <sup>b</sup>	134.6 ± 6.3 <sup>a</sup>	-	142.6 ± 2.8 <sup>b</sup>	142.3 ± 3.1 <sup>b</sup>	-	*	*	
20 °C	143.2 ± 8.2 <sup>γ</sup>	155.6 ± 5.6 <sup>β</sup>	-	158.7 ± 1.0 <sup>γ</sup>	162.2 ± 2.9 <sup>γ</sup>	-	*	-	

Values are mean ( $\pm$  SD) of triplicate tanks; within each column (day: a, b, c; night:  $\alpha$ ,  $\beta$ ,  $\gamma$ ) temperature values with different superscript letters are significantly different ( $p < 0.05$ ). Dissolved oxygen (DO) concentrations in the Test tanks: UO and MO day 12 °C = 70%, 16 °C = 60%, 20 °C = 50%, MO night (gray background): 12 °C = 50%, 16 °C = 50%, 20 °C = 40%.

### 3.3.2 *Ammonia*

Figure 3-2 summarises the diurnal pattern in TAN concentration in the test tanks throughout the experiment. The protein concentration difference of the two diets at 1% BW feeding had a noticeable effect on TAN concentration in the tanks and thus protein usage in catabolism. Prior to feeding the TAN concentration was at its lowest daily value. After feeding at 10 AM it increased steadily for 8-10 hours until it peaked at approximately twice the pre-feeding value. The TAN concentration in the tanks was consistently higher for fish fed the HP diet. The decreasing values during the fasting day lead to equal low values between the diets (Fig. 3-2).

The  $\text{NH}_3$  excretion rate was standardised to the OC rate to derive the ammonia quotient (AQ) and estimated protein catabolism rates without urea and other N-fractions. Table 4 compares the day and night AQ on the final feeding day of each of the two DO periods and the three TP. Statistical analysis indicated that temperature had a significant effect on AQ ( $F_{2, 38}=7.1$ ,  $p<0.01$ ), DO period had a significant effect on AQ ( $F_{1, 38}=5.9$ ,  $p=0.02$ ), and temperature and DO period had a significant interaction ( $F_{2, 38}=13.4$ ,  $p<0.01$ ). The catabolic protein fuel use tended to be lowest at 16 °C and higher at 12 and 20 °C (Table 3-4). Low nightly DO concentrations tended to not significantly increase the rate of protein fuel use. Statistically significant differences in DO period were detected only for 16 °C for fish fed the HP diet for nightly measurements and for both diets at daytime measurements. Comparison of the AQ shown in Table 4 suggests that diet had a marked and consistent effect on protein fuel use, as within each temperature and DO period trout fed the HP diet consistently used more protein for aerobic metabolism compared to the SP diet. Statistical analysis confirmed that dietary protein content of the diet had a significant effect on the AQ ( $F_{1, 4}=36.0$ ,  $p<0.01$ ), and post-hoc testing indicated that the significant differences were mainly present during the night. The relative protein usage was approximately 30-40% higher for the HP diet.



**Table 3-4:** Quantitative comparison of the effect of diet protein content of relative protein usage in energy metabolism [%] and post hoc test results of rainbow trout fed a standard protein diet (SP = 42.5% crude protein) and a high protein diet (HP = 49.5% crude protein) at a unmanipulated oxygen (UO) period and a unmanipulated (MO) period as mean of measured values from 10AM-2PM (= day values) and 10PM-2AM (= night values). Day and night data was used from the 5<sup>th</sup> day of UO and MO period from every temperature phase.

Period	Unmanipulated DO			Manipulated DO			Post hoc test between DO periods		
	SP	HP	post hoc test	SP	HP	post hoc test	SP	HP	
12 °C	20.4 ± 2.1 <sup>a</sup>	27.6 ± 1.8 <sup>a</sup>	-	Day 10AM-2PM			*	-	-
				18.8 ± 1.8 <sup>a</sup>	25.8 ± 1.9 <sup>ab</sup>				
				19.0 ± 1.0 <sup>a</sup>	24.1 ± 1.8 <sup>a</sup>				
16 °C	15.8 ± 0.2 <sup>b</sup>	20.9 ± 1.0 <sup>b</sup>	-	Night 10PM-2AM			*	*	*
				21.3 ± 0.7 <sup>a</sup>	28.4 ± 3.6 <sup>b</sup>				
				24.4 ± 1.4 <sup>a</sup>	34.8 ± 1.7 <sup>a</sup>				
20 °C	19.0 ± 1.2 <sup>ab</sup>	25.8 ± 0.8 <sup>a</sup>	-	Day 10AM-2PM			*	-	-
				21.1 ± 0.9 <sup>β</sup>	30.3 ± 1.6 <sup>β</sup>				
				24.2 ± 0.8 <sup>αβ</sup>	31.8 ± 0.5 <sup>αβ</sup>				

Values are mean (± SD) of triplicate tanks; within each column temperature values with different superscript letters are significantly different (\*) (day: a, b, c; night: α, β, γ; p < 0.05). Dissolved oxygen (DO) concentrations in the Test tanks: UO and MO day 12 °C = 70%, 16 °C = 60%, 20 °C 50%, MO night (gray background): 12 °C = 50%, 16 °C = 50%, 20 °C = 40%.

### 3.3.3 *Energy budget*

Diet had a significant effect on Energy of non-fecal Nitrogen (EN) ( $F_{1,4}=334.8$ ,  $p<0.01$ ), which was 26-33% higher for the HP diet compared to the SP diet. Temperature had a significant effect on EN ( $F_{2,20}=136.8$ ,  $p<0.01$ ), and temperature and DO period had a combined significant interaction ( $F_{2,20}=36.1$ ,  $p<0.01$ ). While there was no substantial change in EN between 12-16 °C, there was a 21-26% increase between 16-20°C. An effect of DO period on EN was only observed at 16 and 20°C. Statistical analysis indicated that diet ( $F_{1,4}=126.9$ ,  $p<0.01$ ), temperature ( $F_{2,20}=177.0$ ,  $p<0.01$ ), DO period ( $F_{1,20}=185.7$ ,  $p<0.01$ ), and temperature and DO period interaction ( $F_{2,20}=20.1$ ,  $p<0.01$ ) had a significant effect on the resulting Metabolisable Energy (ME). The ME was 1-2% lower for the HP diet, it decreased by 1-3% between 12 - 20°C, and was 1-2% higher during the MO period. While the Specific Dynamic Action (SDA) tended to be lower for the SP diet, none of the analysed variables had a significant effect on SDA. The SDA during the MO period was 22% (12 °C), 23% (16 °C) and 42% (20 °C) higher for the SP diet and 10% (12 °C), 13% (16 °C) and 18 % (20 °C) for the HP diet compared to the UO period. Diet ( $F_{1,4}=18.1$ ,  $p=0.01$ ) and temperature ( $F_{2,20}=19.4$ ,  $p<0.01$ ) had a significant effect on Retained Energy (RE), however, the DO period did not differ ( $F_{1,20}=0.4$ ,  $p=0.55$ ). The RE data showed a large decrease (12-15%) between 12 - 20°C and the HP diet resulted in 3-8% lower RE than the SP diet.

**Table 3-5:** Energy budgets ( $\text{kJ kg}^{-0.8} \text{ day}^{-1}$ ) of rainbow trout fed experimental diets intake of rainbow trout fed a standard protein diet ( $\text{SP} = 425\%$  crude protein) and a high protein diet ( $\text{HP} = 49.5\%$  crude protein) at a unmanipulated oxygen (UO) period and a manipulated (MO) period as mean of measured values from 12 PM to 6 AM (excluding cleaning in the morning and the period from 4 to 6 PM when the water inflow was downregulated for the MO period). Day and night data was used from the 5th day of UO and MO period from every temperature phase.

Temperature	DO Period	Diet	GE <sub>in</sub>	DE <sub>in</sub>	EN	ME	SDA	RE	
12 °C	Unmanipulated DO	SP	141.3 ± 0.2 <sup>a</sup>	119.7 ± 0.1 <sup>a</sup>	3.7 ± 0.2 <sup>a</sup>	116.0 ± 0.3 <sup>a</sup>	7.3 ± 0.3 <sup>a</sup>	78.8 ± 1.2 <sup>a</sup>	
		HP	140.2 ± 0.3 <sup>a</sup>	119.3 ± 0.3 <sup>a</sup>	5.6 ± 0.0 <sup>a</sup>	113.7 ± 0.2 <sup>a</sup>	9.4 ± 2.6 <sup>a</sup>	72.9 ± 2.3 <sup>a</sup>	
	Post hoc test between diets: 12 °C UO: SP vs. HP		*	-	*	*	-	*	
		Manipulated DO	SP	142.9 ± 0.3 <sup>†</sup>	121.0 ± 0.2 <sup>†</sup>	3.7 ± 0.2 <sup>†</sup>	117.4 ± 0.2 <sup>†</sup>	9.4 ± 0.5 <sup>†</sup>	78.1 ± 0.9 <sup>†</sup>
	12 °C	Post hoc test between diets: 12 °C MO: SP vs. HP	HP	141.8 ± 0.5 <sup>°</sup>	120.7 ± 0.4 <sup>°</sup>	5.5 ± 0.1 <sup>°</sup>	115.2 ± 0.4 <sup>°</sup>	10.4 ± 2.5 <sup>°</sup>	73.3 ± 2.2 <sup>°</sup>
				*	-	*	*	-	*
			*	*	-	*	*	*	-
16 °C	Unmanipulated DO	SP	143.6 ± 0.2 <sup>b</sup>	121.6 ± 0.2 <sup>b</sup>	3.5 ± 0.2 <sup>a</sup>	118.2 ± 0.1 <sup>b</sup>	9.7 ± 1.1 <sup>b</sup>	73.6 ± 0.8 <sup>b</sup>	
		HP	142.7 ± 0.3 <sup>β</sup>	121.5 ± 0.3 <sup>β</sup>	5.0 ± 0.2 <sup>β</sup>	116.5 ± 0.2 <sup>β</sup>	11.0 ± 1.2 <sup>β</sup>	70.0 ± 1.7 <sup>β</sup>	
	Post hoc test between diets: 16 °C UO: SP vs. HP		-	-	*	*	-	-	
		Manipulated DO	SP	146.4 ± 0.4 <sup>†</sup>	124.0 ± 0.4 <sup>†</sup>	4.1 ± 0.2 <sup>†</sup>	119.9 ± 0.1 <sup>†</sup>	12.6 ± 0.8 <sup>†</sup>	72.5 ± 0.5 <sup>†</sup>
	16 °C	Post hoc test between diets: 16 °C MO: SP vs. HP	HP	145.5 ± 0.5 <sup>*</sup>	123.8 ± 0.4 <sup>*</sup>	5.8 ± 0.1 <sup>°</sup>	118.1 ± 0.3 <sup>*</sup>	12.6 ± 0.8 <sup>*</sup>	70.0 ± 0.3 <sup>*</sup>
				-	-	*	*	-	-
			*	*	*	*	*	-	
20 °C	Unmanipulated DO	SP	145.3 ± 0.3 <sup>c</sup>	123.1 ± 0.3 <sup>c</sup>	4.5 ± 0.1 <sup>b</sup>	118.6 ± 0.3 <sup>b</sup>	7.7 ± 4.3 <sup>c</sup>	69.3 ± 2.2 <sup>b</sup>	
		HP	144.6 ± 0.6 <sup>γ</sup>	123.1 ± 0.5 <sup>γ</sup>	6.7 ± 0.1 <sup>γ</sup>	116.4 ± 0.6 <sup>β</sup>	11.6 ± 1.0 <sup>γ</sup>	63.6 ± 2.2 <sup>γ</sup>	
	Post hoc test between diets: 12 °C UO: SP vs. HP		-	-	*	*	-	-	
		Manipulated DO	SP	149.3 ± 0.5 <sup>†</sup>	126.4 ± 0.4 <sup>†</sup>	5.3 ± 0.1 <sup>†</sup>	121.2 ± 0.4 <sup>†</sup>	13.2 ± 0.9 <sup>†</sup>	66.4 ± 1.6 <sup>†</sup>
	20 °C	Post hoc test between diets: 20 °C MO: SP vs. HP	HP	149.0 ± 1.0 <sup>°</sup>	126.8 ± 0.9 <sup>°</sup>	7.2 ± 0.1 <sup>*</sup>	119.6 ± 0.8 <sup>°</sup>	14.1 ± 3.1 <sup>°</sup>	64.2 ± 0.3 <sup>°</sup>
				-	-	*	*	-	-
			*	*	*	*	*	-	

GE, Gross energy; DE, Digestible energy; EN, Energy of non-fecal nitrogen; ME, metabolizable energy; RE, retained energy; SDA, relative Specific dynamic action. Values are mean ± SD of triplicate feeding groups; superscript letters (UO SP: <sup>a, b, c</sup>; UO HP: <sup>α, β, γ</sup>; MO SP: <sup>†, ‡, §</sup>; MO HP: <sup>°, °, °</sup>) denote post hoc test groupings between temperatures. Significant differences for diet and oxygen period are presented as (\*)( $p < 0.05$ ). Dissolved oxygen (DO) concentrations in the Test tanks: UO and MO day 12 °C = 70%, 16 °C = 60%, 20 °C 50%, MO night (gray background): 12 °C = 50%, 16 °C = 50%, 20 °C = 40%.

The energy budget data is visually represented in Figure 3-3, which compares the metabolised and retained energy when the data is normalised to the quantity of digestible energy consumed (Azevedo et al., 1998). The normalised RE ( $RE^*$ ) decreased markedly with increasing temperature (a maximum 12% absolute decrease), whereas normalised ME ( $ME^*$ ) only decreased slightly (maximum 1.3%) over the same range (Fig. 3). While the MO period tended to result in lower  $ME^*$  and  $RE^*$ , diet was observed to have a larger effect. The HP diet consistently resulted in lower  $ME^*$  (1.2 – 1.8%) and  $RE^*$  (1.9 – 4.8%) values compared to the SP diet (Fig. 3-3).

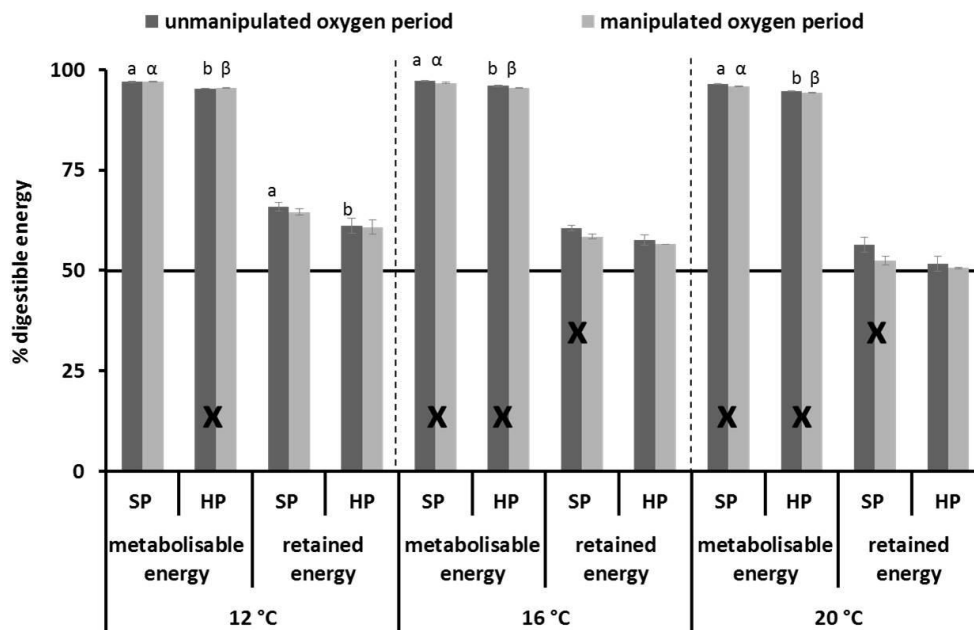

**Fig. 3-3:** Metabolisable energy and retained energy (% digestible energy) of rainbow trout fed a standard protein diet (SP = 42.5% crude protein) and a high protein diet (HP = 49.5% crude protein) reared under an unmanipulated oxygen [black bars] and a manipulated oxygen [grey bars] period. Test tanks oxygen concentrations were at: 12 °C = 70%, 16 °C = 60% and 20 °C 50% for both oxygen periods at the day (8 AM to 4 PM). Intermittent low oxygen challenge concentrations at the night (4 PM to 8 PM) in the manipulated oxygen period were at: 12 °C = 50%, 16 °C = 50% and 20 °C = 40%. Presented values were calculated as mean between 12 AM to 6 AM from the 5th day of each oxygen period and experimental temperature. Different superscript letters indicate significant difference between diets (unmanipulated oxygen period: a, b; manipulated oxygen period: α, β). Difference in oxygen period were indicated by an X inserted into the bar ( $p < 0.05$ ).

## 4 Discussion

The experiment described in the current study used the common approach (Glencross, 2009; Remen et al., 2013; Tran-Duy et al., 2008; Yang et al., 2014) of down-regulating water throughput rate to create a DO challenge. These studies have the disadvantage that many water quality factors other than DO change simultaneously as the turnover through a tank decreases. The present study used high precision CO<sub>2</sub> and NH<sub>3</sub> analysers to measure whether these key water quality variables exceeded thresholds that would likely influence the metabolism of the animals during periods of reduced water exchange. It was determined that CO<sub>2</sub> and TAN concentrations in the present study were below 8.2 mg l<sup>-1</sup> dissolved CO<sub>2</sub> (Good et al., 2010) and below 0.4 mg l<sup>-1</sup> TAN (Colt, 2006) which likely not affected the fish (Hjeltnes et al., 2012; Timmons and Ebeling, 2010). As a result main variables to consider in terms of the results were the target variables of temperature, diet and DO.

The animals in our study acclimated fast and their metabolism quickly stabilised to new temperature conditions and the moderately challenging nighttime DO conditions. This observation is in line with the wide temperature tolerance reported for the species (Wallace et al.; 1993) and their ability to endure moderately hypoxic waters (Matthews and Berg, 1997). The poorer SGR and FCR observed with increasing temperature and experimental time was likely attributable to temperature effects (Cho, 1992). Metabolic rate increases with temperature so that beyond an optimal range elevated energy demand diverts nutrients towards fuel pathways rather than growth (Fry, 1971; Linton et al., 1998; Morgan et al., 2001). This pattern was observed in the current study, where metabolic rate increased with temperature and growth and normalised retained energy (RE<sup>\*</sup>) decreased.

There was no difference in growth rate observed between the two diets, however, growth differences would not likely be observable over a short period such as two weeks. The protein fuel utilisation for fish fed the HP diet at 16 °C are comparable to those reported by Alsop and

Wood (1997) (approximately 25%) for juvenile rainbow trout on a similar diet and ration size (50% protein diet, 1% BW per day). The authors Alsop and Wood (1997) measured ammonia and urea 1 h prior to feeding and 8 h post feeding, and reported protein fuel utilisation as a daily mean value. Analysis of the daily  $\text{NH}_3$  excretion pattern curves from the current study indicate that Alsop and Wood (1997) likely sampled time points that represented the minimum and maximum excretion rates. Estimated protein catabolism rates were comparable between the studies (for the HP diet, a comparable diet to that used by Alsop and Wood (1997)). The present study did not measure urea excretion, which may indicate that true protein catabolism rates of fish in the current study may be higher (France and Kebreab, 2008), however, the analysis presented in the present study excluded pre-feeding ammonia excretion rates values, which complicates direct comparison of absolute rates.

The ammonia quotient (AQ) data of this experiment suggested that fish fed the HP diet were metabolising more protein as a fuel source than fish fed SP diet. In combination with a lower  $\text{RE}^*$  it appears that the 7% higher protein inclusion in the HP diet was used in catabolism and was not invested in improved growth. Alsop and Wood (1997) have suggested that the use of protein as a fuel source is strongly dependent on protein intake quantity and quality (Wilson, 2002). The results from our study propose a similar point, namely that dietary protein supply beyond an upper limit increased dietary protein catabolism. The preferred metabolic pathways are probably fixed ontogenetically (Carter et al., 2008; Glazier, 2015) and protein is used as a fuel depending on the dietary content, quality and variation from the optimum environmental temperature (Dumas et al., 2010). The finding of no observable advantage of a high protein supply under challenging conditions aligns with a study of Atlantic salmon (*Salmo salmar*) fed diets from 41 to 45% crude protein at around 60%  $\text{DO}_{\text{sat}}$  (Carter et al., 2008). Other studies with Barramundi (*Lates calcariferii*) report that a high protein diet reduces the impact of growth retardation at higher temperatures (Carter et al., 2008; Glencross and Rutherford, 2010).

Glencross (2009) concluded that protein utilisation at low DO levels was independent of the DO content of the surrounding water. This is in agreement with the measurements of the AQ in our experiment. The juvenile rainbow trout were not observed to consistently catabolise more protein under low DO conditions for either diet. In general the manipulated oxygen (MO) period tended to elevate oxygen consumption (OC) for fish fed both diets between 3-14%. The higher OC may be attributable to physiological and behavioural actions that were required to cope with suboptimal DO conditions, such as elevated swimming, heart and ventilation rate and prolonged digestion (Cameron, 1971; Hughes and Saunders, 1970; Itazawa, 1970; Jones, 1971; Kramer, 1987; Kutty, 1968; Randall and Schmith, 1967; Wang et al., 2009). The intermittent nighttime low DO challenge resulted in an 11% higher nighttime OC between the unmanipulated oxygen (UO) and MO periods at 16 and 20 °C for fish fed the SP diet. However, fish fed the HP diet increased OC by a maximum of 6% under equivalent conditions. The results of the EB indicated a small but consistent reduction in RE\* under intermittent low DO conditions, which may lead to a loss of growth performance. Longer periods of low DO conditions might also lead to differences in growth and body composition between the test diets. Also the RE\* values for the HP diet were consistently lower compared to the SP diet, although the difference was small in magnitude. In addition, for fish fed the SP diet the increased temperature lead to a bigger difference in RE\* between the DO periods. These differences between diets suggest that a high protein diet had some effect in moderating the metabolic rate under challenging DO conditions. However, a high protein diet was also observed to generally elevate OC and lower RE\*, meaning the HP diet gave no net benefit under challenging conditions. While feed intake is a key variable known to be affected by low DO conditions (Carter et al., 2008; Chabot and Claireaux, 2008; Herrmann et al., 1962; Tran-Duy et al., 2008; Yang et al., 2014), the intermittent nighttime DO period in the current study was not observed to have any effect on the feed intake. However, the restricted ration size used in the current study would be considered low for rainbow trout (Cho, 1992) and there

may be effects of intermittent DO on feed intake at higher ration sizes or with unrestricted feeding.

Fish fed the HP diet tended to have slightly higher (0-8%) OC than animals fed the SP diet and the EB analysis suggested the energy retained by fish fed the HP diet was consistently lower than that of fish reared on the SP diet, although the difference was small in magnitude. The elevated OC rate and lower energy retention observed for fish fed on the HP diet compared to the SP diet may be related to differences in metabolic fuel use. The production of 1 KJ of energy via ammonotelic catabolism of protein theoretically requires 74.1 mg O<sub>2</sub>, whereas lipid and glucose require only 71.6 mg and 67.1 mg O<sub>2</sub>, respectively (Heldmaier and Neuweiler, 2004). The SP diet had higher inclusion rates of lipid and starch (to maintain comparable energy value with the HP diet) and these fuels require less O<sub>2</sub> for oxidative catabolism, so it may have been that fish metabolising the SP diet were utilising a fuel mix that was less oxygen demanding than fish metabolising the HP diet. Saravanan (2013) reported that diet-induced oxygen use declined with increasing dietary fat energy for rainbow trout, which is congruent with findings from the present study.

## **5 Conclusion**

The goal of the present study was to observe any changes in metabolic rate and protein fuel use of juvenile rainbow trout under different temperature, diet and dissolved oxygen periods. Further we aimed to evaluate whether a high protein diet is a valuable (albeit more expensive) method to support fish metabolism during challenging conditions. For both diets catabolic protein usage was lowest at 16 °C and was not altered under challenging dissolved oxygen conditions. A standardised protein supply was found to have obvious benefits over a high protein diet under the optimal environmental conditions and temperature tested in this study. Protein fuel use was consistently 40% higher for fish fed the HP diet at all tested temperatures. The manipulated oxygen period significantly affected the normalised retained



energy and oxygen consumption for fish fed the SP diet, meaning that the beneficial effect under optimal conditions was lost under challenging conditions. This interesting observation should be considered in further special application diet studies to optimise and stabilise nutrient utilisation under common challenging environments.

## Acknowledgments

We thank Stephanie Michl, Faraz Ansari, Simon Klatt, Arndt von Danwitz and Marcus Griese for assistance during the experiment or final sampling as well as for detailed statistical advices Mario Hasler. Also Leo Nankervis and Nafiha Usman for detailed discussion of the raw-data.

## References

- Alsop, D.H., Wood, C.M., 1997. The interactive effects of feeding and exercise on oxygen consumption, swimming performance and protein usage in juvenile rainbow trout (*Oncorhynchus mykiss*). *Journal of Experimental Biologie* 200, 2337-2346.
- Azevedo, P.A., Young Cho, C., Leeson, S., Bureau, D.P., 1998. Effects of feeding level and water temperature on growth, nutrient and energy utilization and waste outputs of rainbow trout (*Oncorhynchus mykiss*). *Aquatic Living Resources* 11, 227-238.
- Brett, J., 1979. 10 Environmental Factors and Growth. *Fish physiology* 8, 599-675.
- Bretz, F., Hothorn, T., Westfall, P., 2011. *Multiple Comparisons Using R*. CRC Press.
- Cameron, J.N., 1971. Oxygen dissociation characteristics of the blood of the rainbow trout, *Salmo gairdneri*. *Comparative biochemistry and physiology. A, Comparative Physiology* 38, 699-704.
- Carter, C.G., Katersky, R.S., Barnes, J.C., Bridle, A.R., Hauler, R., 2008. Assessment of fish growth performance under limiting environmental conditions: Aquaculture Nutrition Subprogram. FRDC final report. FRDC Project No. Project 2004/237. pp147.
- Chabot, D., Claireaux, G., 2008. Environmental hypoxia as a metabolic constraint on fish: the case of Atlantic cod, *Gadus morhua*. *Marine Pollution Bulletin* 57, 287-294.
- Cho, C., Kaushik, S., 1985. Effects of protein intake on metabolizable and net energy values of fish diets. *Nutrition and Feeding in Fish*, 95-117.
- Cho, C.Y., 1992. Feeding systems for rainbow trout and other salmonids with reference to current estimates of energy and protein requirements. *Aquaculture* 100, 107-123.
- Colt, J., 2006. Water quality requirements for reuse systems. *Aquacultural Engineering* 34, 143-156.

## CHAPTER 3

### The effect of diet, temperature and intermittent low oxygen on the metabolism of rainbow trout

---

- Dalsgaard, J., Larsen, B.K., Pedersen, P.B., 2015. Nitrogen waste from rainbow trout (*Oncorhynchus mykiss*) with particular focus on urea. *Aquacultural Engineering* 65, 2-9.
- Davis, J.C., 1975. Minimal Dissolved-Oxygen Requirements of Aquatic Life with Emphasis on Canadian Species - Review. *Journal of the Fisheries Research Board of Canada* 32, 2295-2332.
- Dietz, C., Stiller, K.T., Griese, M., Schulz, C., Susenbeth, A., 2013. Influence of salinity on energy metabolism in juvenile turbot, *Psetta maxima* (L.). *Aquaculture Nutrition* 19, 135-150.
- Dosdat, A., Metailler, R., Tetu, N., Servais, F., Chartois, H., Huelvan, C., Desbruyeres, E., 1995. Nitrogenous excretion in juvenile turbot, *Scophthalmus maximus* (L.), under controlled conditions. *Aquaculture Research* 26, 639-650.
- Dosdat, A., Servais, F., Metailler, R., Huelvan, C., Desbruyeres, E., 1996. Comparison of nitrogenous losses in five teleost fish species. *Aquaculture* 141, 107-127.
- Dumas, A., France, J., Bureau, D., 2010. Modelling growth and body composition in fish nutrition: where have we been and where are we going? *Aquaculture Research* 41, 161-181.
- Eliason, E.J., Farrell, A.P., 2014. Effect of hypoxia on specific dynamic action and postprandial cardiovascular physiology in rainbow trout (*Oncorhynchus mykiss*). *Comparative Biochemistry Physiology A* 171, 44-50.
- Elliott, J., Davison, W., 1975. Energy equivalents of oxygen consumption in animal energetics. *Oecologia* 19, 195-201.
- Farrell, A.P., Richards, J.G., 2009. Defining hypoxia: an integrative synthesis of the responses of fish to hypoxia. *Fish physiology* 27, 487-503.
- France, J., Kebreab, E., 2008. *Mathematical modelling in animal nutrition*. Cabi international UK.
- Fry, F., 1971. 1 The effect of environmental factors on the physiology of fish. *Fish Physiology* 6, 1-98.
- Glazier, D.S., 2015. Is metabolic rate a universal 'pacemaker' for biological processes? *Biological Reviews* 90, 377-407.
- Glencross, B.D., Blyth, D., Irvin, S., Bourne, N., Wade, N., 2014. An analysis of the effects of different dietary macronutrient energy sources on the growth and energy partitioning by juvenile barramundi, *Lates calcarifer*, reveal a preference for protein-derived energy. *Aquaculture Nutrition* 20, 583-594.
- Glencross, B.D., Rutherford, N., 2010. Dietary strategies to improve the growth and feed utilization of barramundi, *Lates calcarifer* under high water temperature conditions. *Aquaculture Nutrition* 16, 343-350.
- Glencross, B.D., 2009. Reduced water oxygen levels affect maximal feed intake, but not protein or energy utilization efficiency of rainbow trout (*Oncorhynchus mykiss*). *Aquaculture Nutrition* 15, 1-8.
- Gnaiger, E., 1983. Calculation of energetic and biochemical equivalents of respiratory oxygen consumption, Polarographic oxygen sensors. Springer, pp. 337-345.
- Good, C., Davidson, J., Welsh, C., Snekvik, K., Summerfelt, S., 2010. The effects of carbon dioxide on performance and histopathology of rainbow trout *Oncorhynchus mykiss* in water recirculation aquaculture systems. *Aquacultural Engineering* 42, 51-56.
- Heldmaier, G., Neuweiler, G., 2004. *Energiehaushalt von Tieren, Vergleichende Tierphysiologie*. Springer Berlin Heidelberg, pp. 53-91.
- Herrmann, R.B., Warren, C.E., Doudoroff, P., 1962. Influence of Oxygen Concentration on the Growth of Juvenile Coho Salmon. *Transactions of the American Fisheries Society* 91, 155-167.

- Hjeltnes, B., Bæverfjord, G., Erikson, U., Mortensen, S., Rosten, T., Østergård, P., 2012. Risk assessment of recirculating systems in Salmonid hatcheries. Norwegian Scientific Committee for Food Safety.
- Hughes, G.M., Saunders, R.L., 1970. Responses of the respiratory pumps to hypoxia in the rainbow trout (*Salmo gairdneri*). *Journal of Experimental Biology* 53, 529-545.
- Itazawa, Y., 1970. Heart rate, cardiac output and circulation time of fish. *Bulletin of the Japanese Society Science Fisheries* 36, 926-931.
- Johansson, D., Ruohonen, K., Kiessling, A., Oppedal, F., Stiansen, J.E., Kelly, M., Juell, J.E., 2006. Effect of environmental factors on swimming depth preferences of Atlantic salmon (*Salmo salar* L.) and temporal and spatial variations in oxygen levels in sea cages at a fjord site. *Aquaculture* 254, 594-605.
- Jones, D.R., 1971. Theoretical analysis of factors which may limit the maximum oxygen uptake of fish: The oxygen cost of the cardiac and branchial pumps. *Journal of Theoretical Biology* 32, 341-349.
- Jordan, A.D., Steffensen, J.F., 2007. Effects of ration size and hypoxia on specific dynamic action in the cod. *Physiological and Biochemical Zoology* 80, 178-185.
- Kajimura, M., Croke, S.J., Glover, C.N., Wood, C.M., 2004. Dogmas and controversies in the handling of nitrogenous wastes: the effect of feeding and fasting on the excretion of ammonia, urea and other nitrogenous waste products in rainbow trout. *Journal of Experimental Biology* 207, 1993-2002.
- Killen, S.S., Atkinson, D., Glazier, D.S., 2010. The intraspecific scaling of metabolic rate with body mass in fishes depends on lifestyle and temperature. *Ecology Letters* 13, 184-193.
- Kramer, D.L., 1987. Dissolved oxygen and fish behavior. *Environmental Biology of Fishes* 18, 81-92.
- Kutty, M., 1978. Ammonia quotient in sockeye salmon (*Oncorhynchus nerka*). *Journal of the Fisheries Board of Canada* 35, 1003-1005.
- Kutty, M.N., 1968. Influence of ambient oxygen on the swimming performance of goldfish and rainbow trout. *Canadian Journal of Zoology* 46, 647-653.
- Laird, N.M., Ware, J.H., 1982. Random-effects models for longitudinal data. *Biometrics*, 963-974.
- Lauff, R.F., Wood, C.M., 1996a. Respiratory gas exchange, nitrogenous waste excretion, and fuel usage during aerobic swimming in juvenile rainbow trout. *Journal of Comparative Physiology B* 166, 501-509.
- Lauff, R.F., Wood, C.M., 1996b. Respiratory gas exchange, nitrogenous waste excretion, and fuel usage during starvation in juvenile rainbow trout, *Oncorhynchus mykiss*. *Journal of Comparative Physiology. B, Biochemical, Systemic, and Environmental Physiology* 165, 542-551.
- Lauff, R.F., Wood, C.M., 1997. Effects of training on respiratory gas exchange, nitrogenous waste excretion, and fuel usage during aerobic swimming in juvenile rainbow trout (*Oncorhynchus mykiss*). *Canadian Journal of Fisheries and Aquatic Sciences* 54, 566-571.
- Linton, T.K., Morgan, I., Walsh, P., Wood, C.M., 1998. Chronic exposure of rainbow trout (*Oncorhynchus mykiss*) to simulated climate warming and sublethal ammonia: a year-long study of their appetite, growth, and metabolism. *Canadian Journal of Fisheries and Aquatic Sciences* 55, 576-586.
- Matthews, K., Berg, N., 1997. Rainbow trout responses to water temperature and dissolved oxygen stress in two southern California stream pools. *Journal of Fish Biology* 50, 50-67.
- Mcleary, B., Gibson, T., Solah, V., Mugford, D., 1994. Total starch measurement in cereal products: interlaboratory evaluation of a rapid enzymic test procedure. *Cereal Chemistry* 71, 501-505.

## CHAPTER 3

### The effect of diet, temperature and intermittent low oxygen on the metabolism of rainbow trout

---

- Morgan, I.J., McDonald, D.G., Wood, C.M., 2001. The cost of living for freshwater fish in a warmer, more polluted world. *Global Change Biology* 7, 345-355.
- NRC (National Research Council), 1993. *Nutrient Requirements of Fish*. National Academy Press, Washington, DC, US, 114 pp.
- R Core Team, 2013. *R: A language and environment for statistical computing*. R Foundation for Statistical Computing, Vienna, Austria. ISBN 3-900051-07-0, (URL <http://www.R-project.org/>).
- Randall, D.J., Smith, J.C., 1967. The Regulation of Cardiac Activity in Fish in a Hypoxic Environment. *Physiological Zoology* 40, 104-113.
- Remen, M., Oppedal, F., Imsland, A.K., Olsen, R.E., Torgersen, T., 2013. Hypoxia tolerance thresholds for post-smolt Atlantic salmon: Dependency of temperature and hypoxia acclimation. *Aquaculture* 416, 41-47.
- Saravanan, S., 2013. *Feed intake and oxygen consumption in fish (Doctoral dissertation)*, Wageningen University, Wageningen, NL, p. 164.
- Schaarschmidt, F., Vaas, L., 2009. Analysis of trials with complex treatment structure using multiple contrast tests. *HortScience*, 44(1), 188-195.
- Schreckenbach, K., 2002. Einfluss von Umwelt und Ernährung bei der Aufzucht und beim Besatz von Fischen. *VDSF-Schriftenreihe Fischerei & Naturschutz* 4, 55-73.
- Stiller, K.T., Moran, D., Vanselow, K.H., Marxen, K., Wuertz, S., Schulz, C., 2013. A novel respirometer for online detection of metabolites in aquaculture research: Evaluation and first applications. *Aquacultural Engineering* 55, 23-31.
- Stiller, K.T., Moran, D., Vanselow, K.H., Marxen, K., Wuertz, S., Schulz, C., 2014. A novel recirculating aquaculture respirometer system (RARS) for online detection of metabolites and gassing trials under culture-like conditions. *Aquacultural Engineering News* 16, 2-3, 10.
- Stiller, K.T., Vanselow, K.H., Moran, D., Bojens, G., Voigt, W., Meyer, S., Schulz, C., 2015. The effect of carbon dioxide on growth and metabolism in juvenile turbot *Scophthalmus maximus* L. *Aquaculture* 444, 143-150.
- Svendsen, J.C., Steffensen, J.F., Aarestrup, K., Frisk, M., Etzerodt, A., Jyde, M., 2011. Excess posthypoxic oxygen consumption in rainbow trout (*Oncorhynchus mykiss*): recovery in normoxia and hypoxia. *Canadian Journal of Zoology* 90, 1-11.
- Taylor, J.C., Miller, J.M., 2001. Physiological performance of juvenile southern flounder, *Paralichthys lethostigma* (Jordan and Gilbert, 1884), in chronic and episodic hypoxia. *Journal of Experimental Marine Biology Ecology* 258, 195-214.
- Thorarensen, H., Kubiriza, G.K., Imsland, A.K., 2015. Experimental design and statistical analyses of fish growth studies. *Aquaculture* 448, 483-490.
- Timmons, M.B., Ebeling, J.M., 2010. *Recirculating Aquaculture*. second ed. Cayuga Aquaculture Ventures, Ithaca, New York.
- Tirsgaard, B., Moran, D., Steffensen, J.F., 2015. Prolonged SDA and reduced digestive efficiency under elevated CO<sub>2</sub> may explain reduced growth in Atlantic cod (*Gadus morhua*). *Aquatic Toxicology* 158, 171-180.
- Tran-Duy, A., Schrama, J.W., van Dam, A.A., Verreth, J.A., 2008. Effects of oxygen concentration and body weight on maximum feed intake, growth and hematological parameters of Nile tilapia, *Oreochromis niloticus*. *Aquaculture* 275, 152-162.

- Verbeke, G., Molenberghs, G., 2009. Linear mixed models for longitudinal data. Springer Verlag, Inc., New York.
- Wallace, J., Heen, K., Monahan, R., Utter, F., 1993. Environmental considerations. *Salmon Aquaculture*, 127-143.
- Wang, T., Lefevre, S., Huong, D.T.T., Van Cong, M., 2009. The effects of hypoxia on growth and digestion. In: Richards, J.J., Brauner, C.J., Farrell, A.P. (Eds.), *Hypoxia. Fish Physiology*, vol. 27. Academic Press/Elsevier, San Diego, California, pp. 361–396.
- Wilson, R.P., 2002. Amino acids and proteins. In: *Fish Nutrition* (ed. by J.E. Halver & R.W. Hardy), 3rd edn, pp.144-181. Academic Press, NewYork, NY, USA.
- Wood, C.M., 2001. Influence of feeding, exercise, and temperature on nitrogen metabolism and excretion, *Fish Physiology*. Academic Press, pp. 201-238.
- Yang, K., Fan, Q., Zhang, L., Li, B., Gao, Y., Zeng, K., Wang, Q., Zhu, S., Fang, G., 2014. Effect of dissolved oxygen levels on growth performance, energy budget and antioxidant responses of yellow catfish, *Pelteobagrus fulvidraco* (Richardson). *Aquaculture Research* 46, 2025-2033.

## CHAPTER 3

The effect of diet, temperature and intermittent low oxygen on the metabolism of rainbow trout

---

# GENERAL DISCUSSION

The present thesis describes the evaluation process of an online recirculating aquaculture respirometer system (RARS) for studying fish metabolism under challenging water quality conditions relevant to aquaculture. In this thesis the RARS was used to study in detail a range of variables relevant to aquaculture production, specifically the effects of dietary composition, oxygen concentrations and metabolite waste accumulation on fish health and performance. The results are described and discussed in the three research chapters of this thesis, and can be summarized as follows.

The first chapter describes the technical development, improvement, testing and verification of the RARS. The key RARS elements investigated were a temperature stabilization system and high precision CO<sub>2</sub> and NH<sub>3</sub> analyzers for measuring waste metabolite concentrations and protein catabolism. The automated metabolite analyzers could operate in both fresh and seawater, and offered a level of precision and accuracy that exceed most systems reported to date. The chapter reports on the performance of these instruments for aquaculture research in two trials using a freshwater (rainbow trout, *Oncorhynchus mykiss*) and seawater fish species (turbot, *Scophthalmus maximus*). To derive the metabolic rates and experimental adaptations for trial evaluation particular attention needed to be given to the water retention characteristics and washout modelling of the tanks, as flow-through respirometers can otherwise have limited utility due to uncertainties regarding instantaneous metabolic rates.

In the second chapter the results of a CO<sub>2</sub> accumulation study was carried out with turbot is presented. It is concluded that the loss of growth and condition of turbot reared at elevated CO<sub>2</sub> concentrations results from decreased feed intake and an increased reliance on protein as a fuel source.

In the third chapter the influence of dietary protein inclusion rate on catabolic fuel use of rainbow trout is investigated under nightly low oxygen concentrations and different temperatures. The protein catabolism rate was found to be 40% higher for a high-protein diet (HP) compared to a standard-protein (SP) diet. The protein fuel use was not influenced by low-oxygen events and was lowest for both diets at 16 °C. The low-oxygen period resulted in an increase of oxygen consumption (SP=11%, HP=6%) and a decrease of retained energy. Although there was no net benefit over the SP diet, the HP diet was associated with a generally higher oxygen consumption (0-8%) and lower retained energy (1.9–4.8% digestible energy) and appeared to moderate the degree of change in oxygen consumption and retained energy during the low-oxygen period.

Accurate implementation of technology and elaborated experiments demonstrated that the RARS can be used for creative experiments in the field of applied and basal aquaculture research. The subsequent section will discuss the potential of the RARS for aquaculture research, i. e. for manipulations of environmental parameters, water quality monitoring, online controlled respirometer studies, effects of waste metabolites, and the usage of waste metabolite data to evaluate protein usage as metabolic fuel.

## **1 Aquaculture systems**

It has been verified that reproducible environmental manipulations (CO<sub>2</sub>, O<sub>2</sub> and temperature) for different aquaculture methods could be simulated and monitored precisely by the installed measuring technique and recorded by the computer system of the RARS (Chapter 2 & 3).

Diurnal oxygen depletion, suboptimal temperatures and water exchange fluctuations (Chapter 3) are an issue in cage farming facilities (Carter et al., 2008; Enders and Boisclair, 2016; Remen et al., 2013). The RARS, with the installed temperature compensation and flow regulation system, allowed an elaborated measuring profile based experiment to simulate different farming conditions. The controlled reduction of the water flow-rates (see Chapter 3)



causes a lower O<sub>2</sub>-supply to simulate night-time cage farming conditions and induces higher CO<sub>2</sub>- and NH<sub>3</sub> accumulation in the tanks. Similar to most of the intensive production systems (Ben-Asher et al., 2013; Fivelstad, 2013) but even more pronounced RAS are susceptible to CO<sub>2</sub> accumulation since the water exchange is minimized in comparison to flow-through and cage systems (Borges et al., 2012; Fivelstad, 2013; Good et al., 2010; Terjesen et al., 2013). By the help of the installed CO<sub>2</sub> gassing system a pure CO<sub>2</sub> accumulation study for a long-term analyzer test (see Chapter 2) has been performed to simulate challenging high rearing density conditions.

In RASs CO<sub>2</sub> accumulation is usually an issue of CO<sub>2</sub> removing efficacy that is directly related to the costs of the used technology and the amount of water exchange (Barrut et al., 2012; Fivelstad, 2013; Moran, 2010a, b; Noble et al., 2012). Aquacultural engineers invented a large variety on technical solutions to solve the hypercapnia problem in fish production (Summerfelt et al., 2000) with simple aeration systems in ponds (Boyd and Tucker, 2012), gas relaxation systems as cascades (Moran, 2010a) or with new CO<sub>2</sub> stripping technologies like vacuum airlifts in RAS systems (Barrut et al., 2012). New research focus on energy-saving technical solutions by using online CO<sub>2</sub> sensors that give feedback to regulate the ventilation frequency of the degassing unit's fan (Summerfelt et al., 2015a).

Until now, one obvious technical limitation was the fact that environmental parameters like the temperature could not be changed within individual tanks. For evaluation of potentially effects of different water quality parameters on fish metabolism the experiments had to be performed sequentially. It would be desirable to separate the tanks or groups of tanks to run experiments simultaneously with varying environmental parameters.

## 2 Water quality monitoring

The validation of the sensors in Chapter 1 provided the guidelines for the following long-term experiments in Chapter 2 & 3.

In all chapters of this thesis an ordinary amperometric sensor for O<sub>2</sub> was used (Friehs et al., 2005). O<sub>2</sub> can be quantified fast and precisely for decades (Gnaiger and Forstner, 1983; Kramer, 1987). Amperometric sensors are based on an electrolyte that leads to a drift in the measuring signal so that a reasonable calibration interval had to be considered for each experiment. To obtain absolute O<sub>2</sub> concentrations a time intensive, cumbersome and inconvenient standardized calibration of the probe had to be done daily (Chapter 3). The sensor drift could be neglected for calculating metabolic rates within a measuring cycle because the long-term drift was too low to be detectable within a 2.5 hours measuring cycle. However, for future long-term respirometry studies it would be beneficial to use an optical probe that do not or at least less frequently need recalibrations (Moran et al., 2014; Svendsen et al., 2011).

The headspace flow-through online prototype infrared CO<sub>2</sub> analyzer that was used in this thesis is faster and more accurate than those which are usually available on the aquaculture market (Moran et al., 2010; Pfeiffer et al., 2011; Stiller et al., 2014) (Chapter I). For measuring dissolved CO<sub>2</sub> online in aquaculture the following technologies exist (Stiller et al., 2014): ion selective electrode (ISE) combined with a gas permeable membrane (Severinghaus principle) (Foss et al., 2003), fluorescence lifetime based measurements (Atamanchuk et al., 2014), solid state detector measurements (Holan and Kolarevic, 2015) and spectroscopy (Pfeiffer et al., 2011). For the dissolved CO<sub>2</sub> measurements in the beginning of this thesis a Severinghaus CO<sub>2</sub> probe and a standard infrared meter for aquaculture had been tested. These were finally replaced due to their extremely slow response time and low measurement accuracy (Borges et al., 2012; Moran et al., 2010; Pfeiffer et al., 2011). A solid state detector

based system (Summerfelt et al., 2015a) that is very stable and does not need extensive calibration was not used due, large size and long response time while fluorescence lifetime measurement based optodes are hardly available and just started its commercialization (Atamanchuk et al., 2014).

The dissolved CO<sub>2</sub> analyzer system is normally used for concentrations from almost 0 ppm to 1000 ppm and not for more than 10 times higher concentrations that can occur in aquaculture facilities (Ben-Asher et al., 2013; Fivelstad, 2013; Heuer and Grosell, 2014; Moran and Støttrup, 2011). Our monitoring study (Chapter 2) has been designed to use the entire measurement range of the analyzer. It documented precisely and fast the resulting higher CO<sub>2</sub> accumulation in the tanks during the down-regulation of the water flow-rates (Chapter 3). The resolution was good enough to monitor diurnal curves of the relative CO<sub>2</sub> production (Chapter I).

For the RARS the analyzer had been adapted as a fast head space flow-through system and was found to work extremely well for aquaculture applications. In its original form (as a membrane based flow-through system) it is used mainly for ocean acidification studies (Bakker et al., 2014) but the setting options are remarkably versatile and the measuring range appropriate for aquaculture applications (Moran et al., 2010).

However, there is still a lack of fast, affordable, user-friendly and precise dissolved CO<sub>2</sub> measuring technologies for aquaculture but a lot of effort is made at the moment (Atamanchuk et al., 2014; Kolarevic et al, 2015).

For TAN measurements in all three chapters an adapted loop flow auto-analyzer with sample filtration and auto sampling has been used. After some modifications the installed TAN analyzer performed extremely well in the RARS. The measuring range had been chosen to a maximal value of 1 mg l<sup>-1</sup> TAN. However, in no experiment of this thesis the measurement reading has been higher than that. This was not the normal range for the used measuring cell (around 0.4 mg l<sup>-1</sup>) for an analyzer that can measure precisely down to 0.01 mg

l<sup>-1</sup>. The manufacturer used a special formula to expand the measuring range of the system for higher values. They had adapted the analyzer for a measuring procedure of 10 min per tank but carry over effects could be seen in pre experimental measurements. Therefore, the intern sampling and wash times had to be extended so that the time for sampling and fluorometric analysis was around 12 minutes (see Chapter 1). To evaluate the NH<sub>3</sub> analyzer completely a trial that included different complex measuring profiles was carried out. The NH<sub>3</sub> analyzer was only used once a week at the 8 weeks experimental time (see Chapter 2). By analysis of the data it was realized that the analyzer was able to give a very good resolution in quite low ammonia concentrations (Chapter 2 & Chapter 3; in sea- and freshwater). The data also illustrate surprisingly well the diurnal variation of NH<sub>3</sub> excretion correlated with feeding and digestion (Dosdat et al., 1996; G lineau et al., 1998). The analyzer was used continuously during the experiment of Chapter 3 without significant difficulties.

For the needed accuracy there was no other option than to buy an online system, that is operating with chemicals (Dosdat et al., 1996; G lineau et al., 1998; Skov et al., 2015). Other online ammonia probes are available: Ion selective probes (ISE) can measure the ammonium ion (NH<sub>4</sub><sup>+</sup>) directly or NH<sub>3</sub> by using a gas permeable membrane where the NH<sub>3</sub> can diffuse and react in an electrolyte to NH<sub>4</sub><sup>+</sup> followed by an ISE probe measurement. In some studies such probes were used (Sanz Rus et al., 2000) but were not established in aquaculture production (Zhou and Boyd, 2016). These kinds of probes were not accurate enough, drift and/or were not usable in seawater due to ion interference. However, membrane/ISE combination probes can be used in seawater. The development of user-friendly nitrogen waste production measuring probes is behind the development of online dissolved CO<sub>2</sub> measuring systems and needs also a lot of progress by aquacultural engineers (Kolarevic et al., 2015). A stable submergible probe would be desirable for online NH<sub>3</sub> monitoring and also solutions for nitrite and nitrate are needed.

## 3 Fish metabolism

### 3.1 *Protein fuel use*

NH<sub>3</sub> is the major nitrogenous waste product (around 85%, France and Kebreab, 2008) of the catabolic protein deamination reactions and can be measured as an excreted metabolite in water to estimate the proportion of metabolism fueled by protein catabolism. Kajimura et al. (2004) summarized the nitrogenous waste production for rainbow trout as follows: Ammonia-N (53–68%) and urea-N (6–10%), nitrogen as amino acids (4–10%) via the gills and as protein (3–11%) probably via the body mucus. Alternative nitrogen products – trimethylamine, trimethylamine oxide, uric acid, nitrite and nitrate – were not excreted in detectable quantities. Creatine-N and creatinine-N outputs were detected but contributed only a small fraction to total nitrogen excretion (<1.4%) and a considerable proportion (12–20%) of nitrogen excretion remains unknown.

Even if the information on the additional nitrogen excretion is vague, by evaluating the ammonia quotient (AQ, the ratio between NH<sub>3</sub> excreted and O<sub>2</sub> consumed) it will provide an estimate of protein versus lipid plus carbohydrate catabolism. The metabolic fuel hierarchy as energy substrates for carnivorous fish is: protein > lipid > starch (Glenncross et al., 2014). This strongly depends on the ingested protein amount. Chapter 2 & 3 demonstrates that fish can rely heavily on protein from the feed as an energy source particularly in the hours following feeding (Wood, 2001).

The first results from Chapter 2 show that the NH<sub>3</sub> analyzer can detect small differences in excreted NH<sub>3</sub> between the test tanks and is well suited for nutritional studies of catabolic protein utilization. The treatments in the different experiments could be separated in case of varying ingested protein amount firstly as amount of eaten feed (Chapter 2; ad libitum feeding) and secondly as amount of protein inclusion of a diet (Chapter 3; restricted feeding, 2 different diets). This was in good agreement with metabolic fuel use measurements of Alsop

and Wood (1997). The oxygen consumption rates differ based upon amount of food eaten (Chapter 1 & 2) whereas the restricted feeding study from Chapter 3 demonstrates that oxygen consumption rates do not differ between treatments, unlike the  $\text{NH}_3$  excretion rate measurements. It is well-known that higher feed intake results in increased  $\text{O}_2$  consumption (Alsop and Wood., 1997) whereas  $\text{O}_2$  consumption rates of fish fed diets that differed in macro nutrient composition did not differ in most cases (Saravanan et al., 2013).

Chapter 2 and Chapter 3 consist of fish in different metabolic conditions (fed, fasting and starving) that could be identified directly in the calculated AQs or  $\text{NH}_3$  excretion data. In Chapter 2 the AQ of apparently starving turbot was measured in the highest  $\text{CO}_2$  treatment. At the end of the 8 week experiment the animals had the highest AQ compared to fish in the low  $\text{CO}_2$  treatment. In contrast at the fasting day in Chapter 3 the rainbow trout had the lowest ammonia excretion. This is in good agreement with the three phases of starvation in fish: (I) a short transient phase, (II) a long, protein conservation steady state phase with mainly fat oxidation as the primary energy source (lipids as dominant metabolic fuel followed by carbohydrates and a low proportion of protein), and (III) a shift to protein mobilization as a main energy source (Bar, 2014).

One of the main targets of nutritional science is to minimize protein use to ensure levels are adequate for anabolism but not so high as to promote catabolism. For fish feed manufacturers the substitution of protein catabolism by lipid/carbohydrate fuel use is the key variable for cost savings and is called “protein sparing effect” (Schulz et al., 2007; Slawski et al., 2012). Future research with AQ measurement in the RARS can help to optimize diet composition for reaching the maximal protein sparing effect in a specific rearing environment.

### **3.2      *Carbohydrate and lipid fuel use***

The AQ alone would not give enough information to differentiate between the three MBFs (Jobling, 1994). For a quantification of all three species of primary energy sources the carbon

dioxide excretion is also needed (Gnaiger, 1983). The CO<sub>2</sub> production rate of aquatic breeders is the most difficult metabolite measurement in aqueous environments (Magnoni et al., 2013). In this thesis I tried to analyze the carbonate system with additional laboratory measurements in order to calculate CO<sub>2</sub> production rates more accurately.

In theory by having the pH and/or the alkalinity (Chapter 2) or one of the other components of the carbonate system it is possible to calculate the missing variables (Dickson et al., 2007; Stumm and Morgan, 1996). However, pH measured using an ISE probe has been found to have an accuracy in seawater of only 0.2 pH units (Illingworth, 1981). Accurate ISE pH measurements in seawater need special calibration buffers (Ben-Asher et al., 2013; Dickson et al., 2007). In freshwater where fewer ions interfere with the operation of ISE probes, standardized and frequent calibration with commercially available buffers are needed. In parallel to the testing of the CO<sub>2</sub> analyzer (Chapter 1) some ISE pH probes with detectable differences in the measurements were compared. These small differences in pH have a major impact on the calculation of the carbonate system variables (Ben-Asher et al., 2013). The ISE pH measurement system (see Chapter 1) as it was used in the RARS, even with standardized daily calibration intervals (see Chapter 3), was not accurate enough to calculate remaining carbonate variables. The installation of a spectrometric pH unit (Aßmann et al., 2011) could be an option for further extension of the water chemistry unit of the RARS in order to describe the carbonate system much better as with an ISE probe (McGraw et al., 2010).

Measurement of total inorganic carbon (TIC) in combination with dissolved CO<sub>2</sub> levels measured with a CO<sub>2</sub> analyzer (Chapter 3) was not precise enough for determining metabolic fuel from calculated respiratory quotients (RQ = 1 or 0.9 = 100% catabolic carbohydrates or protein use; RQ = 0.7 = 100% catabolic lipids use) (Gnaiger, 1983). The resulting RQ values were <0.7 indicating calculated CO<sub>2</sub> production rates were too low and consequently dissolved CO<sub>2</sub> and TIC data were not included in the diet evaluation of Chapter 3.

There is indeed literature on CO<sub>2</sub> excretion rates of fish (Ozório et al., 2001; Ozório et al., 2010) but sometimes the effect of carbonate buffering has not been taken into account (Sanz Rus et al., 2000). As Magnoni et al. (2013) pointed out CO<sub>2</sub> excretion rates were difficult to measure and metabolic fuel use evaluations based on measured CO<sub>2</sub> values should be considered carefully. They also note correctly that since the late 1990s there has been no improvement of the “instantaneous method” from Wood and colleagues (Kieffer et al., 1998; Lauff and Wood, 1996a, b). Wood and colleagues used decarbonated water to avoid problems due to carbonate formation of excreted CO<sub>2</sub> (Kieffer et al., 1998; Lauff and Wood, 1996c) which they found not to affect their fish. However, this is not an option for long-term studies in RAS because the biofilter produces acid during nitrification which would lead to a severe drop in pH with negative effects on fish health and biofilter bacteria (Summerfelt et al., 2015b).

At the moment respirometric differentiation between catabolic carbohydrate and lipid use cannot be done under culture like conditions without a better measuring system of the carbonate chemistry. For further studies the installation of a precise online TIC and/or spectrometric pH analyzer in combination with the installed dissolved CO<sub>2</sub> measuring system would be an improvement for studying carbonate chemistry for aquaculture purposes and also for closing the gap in quantification of carbohydrates and lipids in metabolic fuel use.

## **4 Conclusion**

In this thesis it has been verified that reproducible environmental manipulations (CO<sub>2</sub>, O<sub>2</sub> and temperature) for different aquaculture systems could be simulated, monitored precisely by the installed sensors and recorded by the RARS computer system. The utilized measuring technique for O<sub>2</sub> and NH<sub>3</sub> performed well and exactly so that the data processing was suitable to calculate metabolic rates. The different metabolic conditions of the fish (fed, fasting and starving) could be identified by the computed catabolic protein fuel usage. Quantitative



protein intake, as a result of feed intake or dietary protein content, could be identified by the designed RARS. Actually, respirometric differentiation between catabolic carbohydrate and lipid fuel use via the respiratory quotient is technically not possible as CO<sub>2</sub> determination under culture-like conditions is still too inaccurate, without a better measuring system for describing the carbonate chemistry in the fish tanks. The ammonia quotient alone can differentiate between protein versus lipid plus carbohydrate degradation, which could help to optimize protein sparing diets. Thus, within this thesis a highly flexible respiromer system for basal fish metabolism studies or applied nutritional experiments under changing environments was developed. This system opens new perspectives for aquaculture research, especially for optimized feed formulations.

## References

- Alsop, D.H., Wood, C.M., 1997. The interactive effects of feeding and exercise on oxygen consumption, swimming performance and protein usage in juvenile rainbow trout (*Oncorhynchus mykiss*). *Journal of Experimental Biology* 200, 2337-2346.
- Aßmann, S., Frank, C., Körtzinger, A., 2011. Spectrophotometric high-precision seawater pH determination for use in underway measuring systems. *Ocean Science* 7, 597-607.
- Atamanchuk, D., Tengberg, A., Thomas, P.J., Hovdenes, J., Apostolidis, A., Huber, C., Hall, P.O., 2014. Performance of a lifetime-based optode for measuring partial pressure of carbon dioxide in natural waters. *Limnology and Oceanography: Methods* 12, 63-73.
- Bakker, D., Cai, W.-J., Kozyr, A., Mathis, J., Olsen, A., Pfeil, B., Telszewski, M., Jones, S., 2013. Surface Ocean CO<sub>2</sub> Atlas (SOCAT) side event: Release of Version 2 and Science Highlights. *Proceedings 9th International Carbon Dioxide Conference, Beijing, China*.
- Bar, N., 2014. Physiological and hormonal changes during prolonged starvation in fish. *Canadian Journal of Fisheries and Aquatic Sciences* 71, 1447-1458.
- Barrut, B., Blancheton, J.P., Champagne, J.Y., Grasmick, A., 2012. Mass transfer efficiency of a vacuum airlift-Application to water recycling in aquaculture systems. *Aquacultural Engineering* 46, 18-26.
- Ben-Asher, R., Seginer, I., Mozes, N., Nir, O., Lahav, O., 2013. Effects of sub-lethal CO<sub>2</sub>(aq) concentrations on the performance of intensively reared gilthead seabream (*Sparus aurata*) in brackish water: Flow-through experiments and full-scale RAS results. *Aquacultural Engineering* 56, 18-25.
- Borges, M.-T., Domingues, J.O., Jesus, J.M., Pereira, C.M., 2012. Direct and continuous dissolved CO<sub>2</sub> monitoring in shallow raceway systems: from laboratory to commercial-scale applications. *Aquacultural Engineering* 49, 10-17.
- Boyd, C.E., Tucker, C.S., 2012. *Pond aquaculture water quality management*. Springer Science & Business Media.

- Carter, C.G., Katersky, R.S., Barnes, J.C., Bridle, A.R., Hauler, R., 2008. Assessment of fish growth performance under limiting environmental conditions: Aquaculture Nutrition Subprogram. FRDC final report. FRDC Project No. Project 2004/237. pp147.
- Dickson, A.G., Sabine, C.L., Christian, J.R., 2007. Guide to Best Practices for Ocean CO<sub>2</sub> Measurements.
- Dosdat, A., Servais, F., Metailler, R., Huelvan, C., Desbruyeres, E., 1996. Comparison of nitrogenous losses in five teleost fish species. *Aquaculture* 141, 107-127.
- Enders, E., Boisclair, D., 2016. Effects of environmental fluctuations on fish metabolism: Atlantic salmon *Salmo salar* as a case study. *Journal of Fish Biology* 88, 344-358.
- Fivelstad, S., 2013. Long-term carbon dioxide experiments with salmonids. *Aquacultural Engineering* 53, 40-48.
- Foss, A., Røsnes, B., Øiestad, V., 2003. Graded environmental hypercapnia in juvenile spotted wolffish (*Anarhichas minor* Olafsen): effects on growth, food conversion efficiency and nephrocalcinosis. *Aquaculture* 220, 607-617.
- France, J., Kebreab, E., 2008. Mathematical modelling in animal nutrition. Cabi international UK.
- Friehs, K., Hitzmann, B., Scheper, T., 2005. Prozessanalytik. In *Angewandte Mikrobiologie*. Springer Berlin Heidelberg, 267-288.
- Gélineau, A., Corraze, G., Boujard, T., 1998. Effects of restricted ration, time-restricted access and reward level on voluntary food intake, growth and growth heterogeneity of rainbow trout (*Oncorhynchus mykiss*) fed on demand with self-feeders. *Aquaculture* 167, 247-258.
- Glencross, B.D., Blyth, D., Irvin, S., Bourne, N., Wade, N., 2014. An analysis of the effects of different dietary macronutrient energy sources on the growth and energy partitioning by juvenile barramundi, *Lates calcarifer*, reveal a preference for protein-derived energy. *Aquaculture Nutrition* 20, 583-594.
- Gnaiger, E., 1983. Calculation of energetic and biochemical equivalents of respiratory oxygen consumption, Polarographic Oxygen Sensors. Springer, pp. 337-345.
- Gnaiger, E., Forstner, H., 1983 *Polarographic Oxygen Sensors: aquatic and physiological applications*. Springer Science & Business Media.
- Good, C., Davidson, J., Welsh, C., Snekvik, K., Summerfelt, S., 2010. The effects of carbon dioxide on performance and histopathology of rainbow trout *Oncorhynchus mykiss* in water recirculation aquaculture systems. *Aquacultural Engineering* 42, 51-56.
- Heuer, R.M., Grosell, M., 2014. Physiological impacts of elevated carbon dioxide and ocean acidification on fish. *American Journal of Physiology-Regulatory, Integrative and Comparative Physiology* 307, R1061-R1084.
- Holan, A.B., Kolarevic, J., 2015. Postsmoltproduksjon i resirkulert sjøvann på land. Nofima Rapport 40.
- Illingworth, J.A., 1981. A common source of error in pH measurements. *Biochemical Journal* 195, 259-262.
- Jobling, M., 1994. Respiration and metabolism. *Fish Bioenergetics* 8, 121-146.
- Kajimura, M., Croke, S.J., Glover, C.N., Wood, C.M., 2004. Dogmas and controversies in the handling of nitrogenous wastes: the effect of feeding and fasting on the excretion of ammonia, urea and other nitrogenous waste products in rainbow trout. *Journal of Experimental Biology* 207, 1993-2002.
- Kieffer, J.D., Alsop, D., Wood, C.M., 1998. A respirometric analysis of fuel use during aerobic swimming at different temperatures in rainbow trout (*Oncorhynchus mykiss*). *Journal of Experimental Biology* 201 (Pt 22), 3123-3133.

- Kolarevic, J., Bundgaard, D., Reiten, B.K.M., Nerdal, K.S., Saether, B.S., 2015. The automatization of the water quality monitoring in recirculation aquaculture systems (RAS). 3rd NordicRAS Workshop on Recirculating Aquaculture Systems. Molde, Norway, 30 September - 1 October 2015. Book of Abstracts. DTU Aqua Report No. 301-15. National Institute of Aquatic Resources, Technical University of Denmark, 56 pp.
- Kramer, D.L., 1987. Dissolved oxygen and fish behavior. *Environmental Biology of Fishes* 18, 81-92.
- Lauff, R.F., Wood, C.M., 1996a. Respiratory gas exchange, nitrogenous waste excretion, and fuel usage during aerobic swimming in juvenile rainbow trout. *Journal of Comparative Physiology B* 166, 501-509.
- Lauff, R.F., Wood, C.M., 1996b. Respiratory gas exchange, nitrogenous waste excretion, and fuel usage during starvation in juvenile rainbow trout, *Oncorhynchus mykiss*. *Journal of comparative physiology. B, Biochemical, systemic, and environmental physiology* 165, 542-551.
- Lauff, R.F., Wood, C.M., 1996c. Respiratory gas exchange, nitrogenous waste excretion, and fuel usage during starvation in juvenile rainbow trout, *Oncorhynchus mykiss*. *Journal of Comparative Physiology B-Biochemical Systemic and Environmental Physiology* 165, 542-551.
- Magnoni, L., Felip, O., Blasco, J., Planas, J., 2013. Metabolic fuel utilization during swimming: optimizing nutritional requirements for enhanced performance, *Swimming Physiology of Fish*. Springer, pp. 203-235.
- McGraw, C.M., Cornwall, C.E., Reid, M.R., Currie, K.I., Hepburn, C.D., Boyd, P., Hurd, C.L., Hunter, K.A., 2010. An automated pH-controlled culture system for laboratory-based ocean acidification experiments. *Limnology and Oceanography: Methods* 8, 686-694.
- Moran, D., 2010a. Carbon dioxide degassing in fresh and saline water. I: Degassing performance of a cascade column. *Aquacultural Engineering* 43, 29-36.
- Moran, D., 2010b. Carbon dioxide degassing in fresh and saline water. II: Degassing performance of an air-lift. *Aquacultural Engineering* 43, 120-127.
- Moran, D., Softley, R., Warrant, E.J., 2014. Eyeless Mexican cavefish save energy by eliminating the circadian rhythm in metabolism. *PLOS one* 9, e107877.
- Moran, D., Støttrup, J., 2011. The effect of carbon dioxide on growth of juvenile Atlantic cod *Gadus morhua* L. *Aquatic Toxicology* 102, 24-30.
- Moran, D., Tirsgård, B., Steffensen, J.F., 2010. The accuracy and limitations of a new meter used to measure aqueous carbon dioxide. *Aquacultural Engineering* 43, 101-107.
- Noble, C., Kankainen, M., Setälä, J., Berrill, I.K., Ruohonen, K., Damsgård, B., Toften, H., 2012. The bio-economic costs and benefits of improving productivity and fish welfare in aquaculture: utilizing CO<sub>2</sub> stripping technology in Norwegian Atlantic Salmon Smolt production. *Aquaculture Economics & Management* 16, 414-428.
- Ozório, R.O., Van Eekeren, T., Huisman, E., Verreth, J., 2001. Effects of dietary carnitine and protein energy: nonprotein energy ratios on growth, ammonia excretion and respiratory quotient in African catfish, *Clarias gariepinus* (Burchell) juveniles. *Aquaculture Research* 32, 406-414.
- Ozório, R.O., Van Ginneken, V.J., Bessa, R.J., Verstegen, M.W., Verreth, J.A., Huisman, E.A., 2010. Effects of exercise on l-carnitine and lipid metabolism in African catfish (*Clarias gariepinus*) fed different dietary l-carnitine and lipid levels. *British Journal of Nutrition* 103, 1139-1150.
- Pfeiffer, T.J., Summerfelt, S.T., Watten, B.J., 2011. Comparative performance of CO<sub>2</sub> measuring methods: marine aquaculture recirculation system application. *Aquacultural Engineering* 44, 1-9.
- Remen, M., Oppedal, F., Imsland, A.K., Olsen, R.E., Torgersen, T., 2013. Hypoxia tolerance thresholds for post-smolt Atlantic salmon: Dependency of temperature and hypoxia acclimation. *Aquaculture* 416, 41-47.

- Sanz Rus, A.S., Enjuto, C, Morales, A.E., Hidalgo, M.C, Garcia-Gallego, M., 2000. Description of a facility for studying energy metabolism in fish: application to aquaculture. *Aquacultural Engineering* 21, 169–180.
- Saravanan, S., Geurden, I., Figueiredo-Silva, A.C., Kaushik, S., Verreth, J., Schrama, J.W., 2013. Voluntary Feed Intake in Rainbow Trout is Regulated by Diet-Induced Differences in Oxygen Use. *Journal of Nutrition* 143, 781-787.
- Schulz, C., Böhm, M., Wirth, M., Rennert, B., 2007. Effect of dietary protein on growth, feed conversion, body composition and survival of pike perch fingerlings (*Sander lucioperca*). *Aquaculture Nutrition* 13, 373-380.
- Skov, P.V., Lund, I., Pargana, A.M., 2015. No evidence for a bioenergetic advantage from forced swimming in rainbow trout under a restrictive feeding regime. *Frontiers in Physiology* 6.
- Slawski, H., Adem, H., Tressel, R.P., Wysujack, K., Koops, U., Kotzamanis, Y., Wuertz, S., Schulz, C., 2012. Total fish meal replacement with rapeseed protein concentrate in diets fed to rainbow trout (*Oncorhynchus mykiss* Walbaum). *Aquaculture International* 20, 443-453.
- Stiller, K.T., Moran, D., Vanselow K.H., Schulz C., 2014. Available technologies for CO<sub>2</sub> measurements in RAS. In: Book of Abstracts. Fremtidens Smoltproduksjon (Future smolt production) – Tredje konferanse om resirkulering av ann i akvakultur. Sunndalsøra, Norwegen. p 21.
- Stumm, W., Morgan, J., 1996. Aquatic chemistry, chemical equilibria and rates in natural waters. Environmental Science and Technology Series.
- Summerfelt, S., Thompson J., McCowan N., 2015a. CO<sub>2</sub> Removal and Stripping Column Ventilation Rate at Bell Aquaculture. 3rd NordicRAS Workshop on Recirculating Aquaculture Systems. Molde, Norway, 30 September - 1 October 2015. Book of Abstracts. DTU Aqua Report No. 301-15. National Institute of Aquatic Resources, Technical University of Denmark, 56 pp.
- Summerfelt, S.T., Vinci, B.J., Piedrahita, R.H., 2000. Oxygenation and carbon dioxide control in water reuse systems. *Aquacultural Engineering* 22, 87-108.
- Summerfelt, S.T., Zühlke, A., Kolarevic, J., Reiten, B.K.M., Selset, R., Gutierrez, X., Terjesen, B.F., 2015b. Effects of alkalinity on ammonia removal, carbon dioxide stripping, and system pH in semi-commercial scale water recirculating aquaculture systems operated with moving bed bioreactors. *Aquacultural Engineering* 65, 46-54.
- Svendsen, J.C., Steffensen, J.F., Aarestrup, K., Frisk, M., Etzerodt, A., Jyde, M., 2011. Excess posthypoxic oxygen consumption in rainbow trout (*Oncorhynchus mykiss*): recovery in normoxia and hypoxia. *Canadian Journal of Zoology* 90, 1-11.
- Terjesen, B.F., Summerfelt, S.T., Nerland, S., Ulgenes, Y., Fjæra, S.O., Reiten, B.K.M., Selset, R., Kolarevic, J., Brunsvik, P., Bæverfjord, G., 2013. Design, dimensioning, and performance of a research facility for studies on the requirements of fish in RAS environments. *Aquacultural Engineering* 54, 49-63.
- Wood, C.M., 2001. Influence of feeding, exercise, and temperature on nitrogen metabolism and excretion, *Fish Physiology*. Academic Press, pp. 201-238.
- Zhou, L., Boyd, C.E., 2016. Comparison of Nessler, phenate, salicylate and ion selective electrode procedures for determination of total ammonia nitrogen in aquaculture. *Aquaculture* 450, 187-193.

# SUMMARY

Different aquaculture systems are influenced differently by the environment. For all methods, the water quality is the key factor for a successful fish production. The automation of intensive aquaculture with the help of online water quality measuring instruments has increased in recent decades. Monitoring and quantification of the metabolic end products carbon dioxide (CO<sub>2</sub>) and ammonia (NH<sub>3</sub>) in fish is still not easy, fast and precise. By measuring the gas metabolism of animals in a respirometer-system it is possible to study the energy metabolism. There are only few systems that allow long-term measurement under realistic production conditions. Such facilities need a lot of technology and are mostly adaptable to simulate a variety of artificial rearing conditions. For this purpose, these research units are designed as recirculating aquaculture system (RAS), where environmental influences can be kept almost constant. As a computerized stand-alone research facility with the ability for simulating various environmental conditions it is called recirculating aquaculture respirometer system (RARS). This thesis described the technical development and application possibilities of a RARS for metabolic studies of fish.

*Chapter 1* described the RARS with the installed automated and semi-continuous detection of key water variables. The RARS was designed to house aquatic organisms in culture-like conditions and allow long-term, high-precision measurements. Nine respirometry tanks (250 l in volume each) housed animals and a tenth (without animals) acted as a reference tank. A single measurement unit made sequential measurements of each tank to eliminate the problem of sensor variation associated with multi-probe setups. The accuracies of the analyzers in relation to measurement range were: O<sub>2</sub> = 1%; CO<sub>2</sub> < 1%; NH<sub>3</sub> = 2%; temperature ≤ 0.25%; and pH ± 0.01. Dissolved CO<sub>2</sub> was measured using air-water equilibration coupled with non-dispersive infrared detection of carrier gas, and NH<sub>3</sub> was quantified using a reagent-based assay and fluorometric autoanalyzer. Though expensive and not common in aquaculture or

physiology research, these two automated metabolite analyzers could operate in both fresh and seawater, and offered high precision and accuracy. It is reported on the performance of these instruments for aquaculture research in two trials using a freshwater (rainbow trout, *Oncorhynchus mykiss*) and seawater fish species (turbot, *Scophthalmus maximus*).

*Chapter 2* investigated if chronically elevated CO<sub>2</sub> concentrations have an effect on growth and catabolism of turbot. The aim was to investigate the growth, condition and protein catabolism of juvenile turbot (55-176 g) reared for 8 weeks at three different dissolved carbon dioxide concentrations: 5, 26, 42 mg l<sup>-1</sup> (pH 7.37, 6.66, 6.44). A commercial diet was administered once per day until satiation. Oxygen consumption and ammonia excretion were measured weekly using high precision automated methods. Increased CO<sub>2</sub> levels were associated with reduced condition factor, feed intake and weight gain. Compared to the low CO<sub>2</sub> treatment, the specific growth rates under the medium and high treatments were reduced by 21 % and 58 %, respectively. Feed conversion ratios were similar between treatments. The oxygen consumption rates broadly followed a dose-response pattern, where fish in the low CO<sub>2</sub> treatment exhibited the highest respiration rates. Comparison of ammonia quotients over time and at comparable feed intake showed the rates of protein catabolism correlated with CO<sub>2</sub> exposure levels. By the end of the 8 week trial fish from the high CO<sub>2</sub> treatment exhibited up to 3 times the protein catabolism rates observed in the low treatment, and the medium treatment was approximately intermediate between the two. The conclusion from the study was that the loss of growth and condition of turbot reared at elevated CO<sub>2</sub> concentrations can be traced to decreased feed intake and an increased reliance on protein as a fuel source.

*Chapter 3* evaluated if the crude protein content of a standard diet (42.5% crude protein) or a high protein diet (49.5% crude protein) influences metabolism in rainbow trout under challenging intermittent low dissolved oxygen concentrations. Three temperature phases (12 °C, 16 °C, 20 °C) were split in two oxygen periods with 5 days of unmanipulated oxygen

levels (50-70%), followed by 5 days of a manipulated oxygen period (4 PM-8 AM) with low oxygen (40-50%) levels. Protein catabolism was temperature independently 40% higher for the high protein diet, not influenced by low oxygen events and lowest at 16 °C for both diets. Compared to the unmanipulated oxygen period, the manipulated oxygen period resulted in an increase in oxygen consumption (standard diet=11%, high protein=6%), decrease in retained energy and stronger lowering of the retained energy at higher temperatures for fish fed the standard diet. The high protein diet appeared to moderate the degree of change in oxygen consumption and retained energy during the manipulated oxygen period, however, there was no net benefit over the standard diet as the high protein diet was associated with a generally higher oxygen consumption (0-8%) and lower retained energy (1.9–4.8% digestible energy).

In this thesis it has been verified that reproducible environmental manipulations (CO<sub>2</sub>, O<sub>2</sub> and temperature) for different aquaculture systems could be simulated, monitored precisely by the installed sensors and recorded by the RARS computer system. The utilized measuring technique for O<sub>2</sub> and NH<sub>3</sub> performed well and exactly so that the data processing was suitable to calculate metabolic rates. The different metabolic conditions of the fish (fed, fasting and starving) could be identified by the computed catabolic protein fuel usage. Quantitative protein intake, as a result of feed intake or dietary protein content, could be identified by the designed RARS. Actually, respirometric differentiation between catabolic carbohydrate and lipid fuel use via the respiratory quotient is technically not possible as CO<sub>2</sub> determination under culture-like conditions is still too inaccurate, without a better measuring system for describing the carbonate chemistry in the fish tanks. The ammonia quotient alone can differentiate between protein versus lipid plus carbohydrate degradation, which could help to optimize protein sparing diets. Thus, within this thesis a highly flexible respirometer system for basal fish metabolism studies or applied nutritional experiments under changing environments was developed. This system opens new perspectives for aquaculture research, especially for optimized feed formulations.





# ZUSAMMENFASSUNG

Unterschiedliche Aquakultur-Systeme sind unterschiedlich durch die Umwelt beeinflusst. Bei allen Methoden ist die Wasserqualität der entscheidende Faktor für eine erfolgreiche Fischproduktion. Die Technisierung der intensiven Aquakultur mit Hilfe von online-Wasserqualitätsmessgeräten hat in den letzten Jahrzehnten stark zugenommen. Das Überwachen und die Quantifizierung der Stoffwechselprodukte Kohlenstoffdioxid (CO<sub>2</sub>) und Ammoniak (NH<sub>3</sub>) bei Fischen ist noch weit davon entfernt, einfach, schnell und genau zu sein. Bei der Messung des Gasstoffwechsels von Tieren in Respirometern können mit Hilfe der Messung des Sauerstoffgehaltes und der Stoffwechselprodukte Aussagen über den Energiestoffwechsel der Tiere gemacht werden. Es gibt kaum Anlagen (sogenannte Respirometer-Systeme) oder auch nur Prototypen, die eine Langzeitmessung unter realistischen Produktionsbedingungen zulassen. Derartige Anlagen müssen dann in der Regel so hoch technisiert sein, dass eine Vielzahl künstlicher Haltungsbedingungen simuliert werden können. Hierzu geeignete Versuchsanlagen sind Kreislaufsysteme (RAS = recirculating aquaculture system), bei denen die meisten Haltungsumwelteinflüsse nahezu konstant gehalten werden können. Bei einer eigenständigen computergesteuerten Kreislauf-Respirometer-Versuchsanlage mit der Möglichkeit, diverse Haltungsbedingungen zu simulieren, kann von einem „recirculating aquaculture respirometer system (RARS)“ gesprochen werden. In dieser Arbeit wurden die technische Entwicklung und Anwendungsmöglichkeiten eines RARS für metabolische Studien an Fischen beschrieben.

*Kapitel 1* stellte das RARS und die eingebauten online Messgeräte vor. Das RARS wurde aufgebaut, um aquatische Organismen über längere Zeiträume unter praxisähnlichen Bedingungen zu halten, gekoppelt mit kontinuierlichen hoch genauen Messungen der Wasserqualität in den Haltsbecken. Neun Becken mit jeweils 250 l wurden mit Tieren besetzt. Ein zehntes tierloses Becken diente als Referenz für die Berechnung von

metabolischen Raten. Es ist eine Messtrecke mit allen Sensoren installiert worden, durch die das Probenwasser aller zehn Becken hintereinander geleitet wurde, um sensorbedingte Messwertunterschiede auszuschließen. Die Genauigkeiten der Sensoren, bezogen auf den Messbereich, waren:  $O_2 = 1\%$ ;  $CO_2 < 1\%$ ;  $NH_3 = 2\%$ ; Temperatur  $\leq 0.25\%$  und  $pH \pm 0.01$ . Das im Wasser gelöste  $CO_2$  wurde in einem Gasraum in dem Durchfluss-System äquilibriert und das Trägergasgemisch mit einem nichtdispersiven Infrarotsensor gemessen. Der Gesamtammoniumstickstoff wurde fluorometrisch bestimmt und über ein automatisches Probennahme-, Bearbeitungs- und Reagenzdosier-system gemessen. Alle verwendeten Messgeräte zeigten ausgezeichnete Funktionalität in Süß- und Salzwasser. Die Praktikabilität des RARS wurden durch einige Beispielmessungen an Regenbogenforellen (*Oncorhynchus mykiss*) und Steinbutt, (*Scophthalmus maximus*) gezeigt.

*Kapitel 2* beschrieb den chronischen Einfluss erhöhter  $CO_2$ -Konzentrationen auf das Wachstum und den Stoffwechsel von Steinbutt. Es wurden über 8 Wochen das Wachstum, der Korpulenz-Faktor und die Proteinkatabolismus-Raten von juvenilen Steinbutt (55-176 g) bei drei verschiedenen  $CO_2$ -Konzentrationen im Haltungswasser untersucht: 5, 26, 42  $mg\ l^{-1}$  (pH 7.37, 6.66, 6.44). Ein Standard-Steinbutt-Futtermittel wurde einmal pro Tag *ad libitum* gefüttert. Der Sauerstoffverbrauch und die Ammoniak-Ausscheidung wurden wöchentlich im RARS gemessen. Erhöhte  $CO_2$ -Konzentrationen führten zu reduzierter Futteraufnahme, Gewichtszunahme und geringerem Korpulenz-Faktor. Die spezifische Wachstumsrate bei Tieren, die unter den höchsten  $CO_2$ -Werten gehalten wurden, waren um 21% bzw. 58% reduziert, bezogen auf die Fische, die unter mittleren und niedrigen Konzentrationen gehalten wurden. Die Futtermittelverwertung war nicht durch die verschiedenen  $CO_2$ -Konzentrationen beeinflusst. Die Sauerstoffverbrauchsraten korrelierten mit der Menge des aufgenommenen Futtermittels, wobei die Fische in der niedrigen  $CO_2$ -Gruppe den höchsten Sauerstoffverbrauch aufwiesen. Es zeigte sich beim Vergleich mit dem Ammoniak-Quotienten (AQ), dass die katabole Proteinnutzung mit Erhöhung der  $CO_2$ -Konzentration

zunahm. Am Ende der 8-wöchigen Studie wiesen die Fische, welche unter der höchsten CO<sub>2</sub>-Konzentration gehalten wurden, eine 3-fache Proteinnutzung im Energiestoffwechsel auf, verglichen mit Tieren, die bei den niedrigsten Konzentrationen gehalten wurden. Die Werte der Tiere, die unter der mittleren CO<sub>2</sub>-Konzentration gehalten wurden, lagen dazwischen. Schlussendlich waren die Wachstumseinbußen und die Verringerung des Korpulenz-Faktors der Steinbutt bei erhöhten CO<sub>2</sub>-Konzentrationen maßgeblich durch eine abnehmende Futteraufnahme bedingt.

*Kapitel 3* untersuchte, ob der Rohproteingehalt eines Standardprotein-Futtermittels (42,5% Rohprotein) oder eines Hochprotein-Futtermittels (49,5% Rohprotein) den Stoffwechsel unter nächtlich niedrigen Sauerstoffkonzentrationen beeinflusst. Dies wurde bei Temperaturen von 12, 16 und 20 °C untersucht. So wurde jeweils 5 Tage lang die Sauerstoffsättigung konstant bei 50-70% gehalten, gefolgt von 5 Tagen mit einer nächtlich (von 16:00 bis 8:00 Uhr) niedrigeren Sauerstoffsättigung von 40-50%. Es zeigte sich, dass der Proteinkatabolismus temperaturunabhängig grundsätzlich 40% höher für das Hochprotein-Futtermittel und nicht durch nächtlich niedrige Sauerstoff-Ereignisse beeinflusst war. Für beide Futtermittel war der katabole Proteinstoffwechsel am niedrigsten bei 16 °C. Für Fische, die mit dem Standardprotein-Futtermittel gefüttert wurden, zeigte sich im Vergleich zum Hochprotein-Futtermittel, dass es bei der nächtlichen Absenkung der Sauerstoffgehalte zu einer viel stärkeren Erhöhung des Sauerstoffverbrauchs kam (Standardprotein-Futtermittel=11%, Hochprotein-Futtermittels=6%), verglichen mit den Nächten ohne Absenkung der Sauerstoffkonzentration. Dies galt ebenfalls für die Abnahme der retinierten Energie, wobei die Differenzen zwischen den Sauerstoffkonzentrationen mit zunehmender Temperatur immer größer wurden. Somit scheint das Hochprotein-Futtermittel den Grad der Sauerstoff-Sensibilität abzuschwächen. Dies war jedoch kein Nettogewinn, da die Fütterung des Hochprotein-Futtermittels mit einem im Allgemeinen höheren Sauerstoffverbrauch (0-8%) und niedrigerer retinierter Energie (1,9-4,8% der verdaulichen Energie) verbunden war.

Die Ergebnisse der vorliegenden Arbeit zeigen, dass reproduzierbare Umwelt-Manipulationen ( $\text{CO}_2$ ,  $\text{O}_2$  und Temperatur) für verschiedene Aquakultur-Systeme simuliert und über die installierte Messtechnik überwacht, sowie durch das Computersystem des RARS aufgezeichnet werden konnten. Die verwendete Messtechnik für  $\text{O}_2$  und  $\text{NH}_3$  arbeitete zufriedenstellend und die Daten eigneten sich für die Berechnung von Stoffwechselraten. In den Versuchen konnten verschiedene Stoffwechselzustände von Fischen (gefüttert, fastend und hungernd) respiratorisch mit Hilfe der berechneten katabolen Proteinnutzung identifiziert werden. Weiterhin konnte die quantitative Proteinzufuhr als Folge von Futteraufnahme oder des Futtermittel-Proteingehaltes durch die Messungen mit dem RARS identifiziert werden. Zurzeit, ohne die Installation eines besseren Messsystems für die Beschreibung der Karbonat-Chemie, ist die katabole respirometrische Differenzierung zwischen Kohlenhydraten und Fetten, über den respiratorischen Quotienten, unter praxisnahen Bedingungen nicht möglich. Der Ammonium-Quotient allein kann jedoch zwischen Protein-Katabolismus und der Summe aus Lipid- und Kohlenhydrat-Katabolismus differenzieren. Der Ammonium-Quotient kann für die Optimierung des Proteinanteils in Futtermitteln genutzt werden und ist somit eine Schlüsselvariable für die Kosteneinsparungen bei Fischfutter. Im Rahmen dieser Arbeit wurde ein hochflexibles Respirometer-System für basale Fischmetabolismusstudien und angewandte Ernährungsexperimente unter wechselnden Haltungsumwelten entwickelt. Dieses System eröffnet neue Perspektiven für die Aquakultur-Forschung, vor allem für Studien zur optimalen Futtermittelzusammensetzung.

# ACKNOWLEDGEMENTS

I am very pleased that so many people supported me during my work for this thesis. We all worked on a very complex interdisciplinary work (between: Physics-Biology and Agricultural Sciences) as a cooperation between the *Forschungs- und Technologiezentrum Westküste (FTZ)* and the *Gesellschaft für marine Aquakultur (GMA)* in Büsum.

First, I would like to thank Prof. Dr. Carsten Schulz who left me the interesting topic and supported me with great interest, many good suggestions and professional advice.

For the daily supervision in physical and technical questions as well as sporting and mental support, my thanks to Dr. Klaus Vanselow.

I am very grateful to my friend and mentor Dr. Damian Moran. Some English and a lot of different specialized problems would have been very difficult to cope without him. I'm very grateful for your patient scientific writing and discussion "training". I will carry the learned "Microcosm of Science" skills and especially our exemplified warm, honest and friendly attitude to another corner of science and people I will work with. In the past years I also learned something about an inner fish and the problem of New Zealanders using the word deck. You have done a great job to your "Padawan".

I want to thank my colleagues Daniela Koch, Daniela Martensen-Staginnus, Gero Bojens, Jörn Köppen and Wolfgang Voigt of the FTZ. Each time friendly and helpful even we tinker months at the facility or doing sensor validation.

Also I like to thank my colleagues from the Gesellschaft für marine Aquakultur. Beginning with my two "big brothers" Binian Samuel Fitwi and Jan Paul Schröder which become much more than excellent colleagues over the years. Not at least for our fishing trips to Langeland I very grateful to Markus Griese, Melf Haufler and Hansup Nam Koong. For a lot of practical help and discussion possibilities I like to thank Carstem Dietz, Simon Friedrich Klatt, Arndt von Danwitz, Stefan Meyer and Torge Appel. My apologies for not mention all of my awesome colleagues from the last years directly but otherwise a very long list would be standing here, which would be more in words than one of the presented papers.

Furthermore I want to thank Wolfgang Koppe and Guido Riesen for an interesting collaboration and a nice tripp to Norway.

I'm very grateful to Stefan Marx, Saskia Heckmann, Pompeo Moschetta and Enrico Savino for a well cooperation in terms of analyzer performance and support for presenting the collected data in the United States. In this context I like to thank also Henrik Grundvig and Steve Summerfelt for a nice time in Shepherdstown and Redkey.

My great gratitude goes to Colin Brauner and Jeffrey Richards for their patience to hold my new position at the University of British Columbia for almost a year without giving it to someone else.

For hurried proofreading some days before thesis submission, I'm very grateful to Matthias Kalläne and Colin Brauner.

Many thanks to my sister Sefanie, my brother in law Martin Röper as well my niece Eva and nephew Thorin for many lovely short relaxing familie holiday trips.

Also unlimited gratitude goes to my girlfriend Ileana Hinz for giving me active support and stand by me even through hard times.

At the end many thanks to my parents Helga and Menfred Stiller which kept me free from everyday problems during and especially at the end of the thesis.

# CURRICULUM VITAE

Name: Kevin Torben Stiller

Birthday: 12.09.1981

Birthplace: Kiel, Schleswig-Holstein, Germany

Nationality: German

Civil Status: Single

## School education

1988-1992	Primary school	„Grundschule Russee“, Kiel, Germany
1992-2002	Secondary school	„Abitur“ certificate at „Integrierte Gesamtschule Hassee mit gymnasialer Oberstufe“, Kiel, Germany

## University education

10/2004-02/2011	Diploma course of Biology at the Christian-Albrechts-Universität zu Kiel, Leibniz-Institut für Meereswissenschaften an der Universität Kiel (IFM-Geomar) (Germany)
01/2011-05/2016	PhD student at the Institut of Animal Breeding and Hasbandry at the Christian-Albrecht Universität zu Kiel (Germany)

## Professional career

08/2002-06/2004	Apprenticeship: „Staatlich gepr. Landwirtschaftlich-technischer Assistent“, „Berufsbildende Schulen III“, Lüneburg and „Norddeutsche Pflanzenzucht“, Hohenlieth. (Germany)
10/2010-03/2011	Research assistant: Gesellschaft für marine Aquakultur, Büsum. (Germany)
01/2010-05/2015	Research assistant at Forschungs- und Technologiezentrum Westküste der Christian Albrecht Universität zu Kiel. (Germany)
05/2015-08/2015	Research assistant: Gesellschaft für marine Aquakultur, Büsum. (Germany)