

Biodegradation of petroleum in marine seep sediments

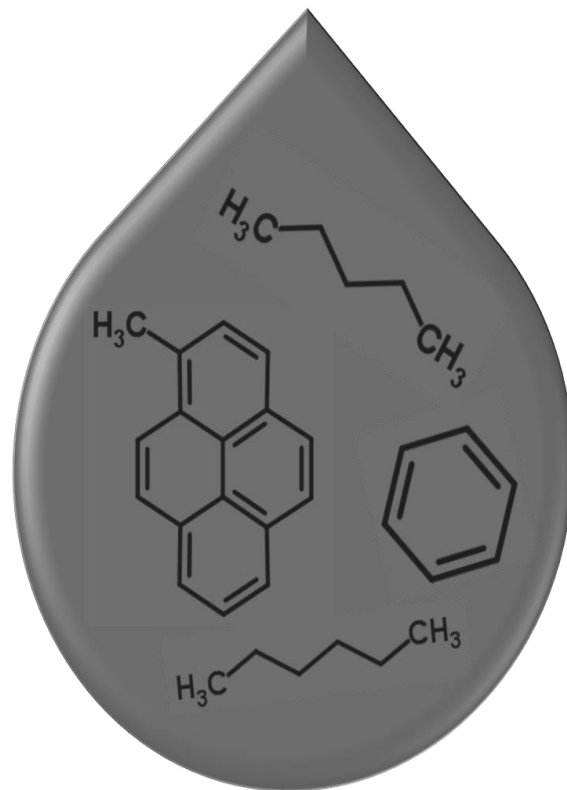

Sonakshi Mishra

Biodegradation of petroleum in marine seep sediments

Dissertation

Submitted for the degree of
Doctorate in Natural Sciences
- Dr. rer. nat. -

Zur Erlangung des Grades eines
Doktors der Naturwissenschaften
- Dr. rer. nat. -

Faculty of Mathematics and Nature Science,
Christian-Albrechts-University of Kiel

Mathematisch-Naturwissenschaftliche Fakultät der
Christian-Albrechts-Universität zu Kiel

Submitted by
Vorgelegt von

Sonakshi Mishra, M.Sc.

Kiel, 2016

Declaration

I, Sonakshi Mishra, hereby declare that apart from the guidance of my supervisors, I have independently and entirely conducted this doctoral work and written the dissertation without any kind of unauthorized aid. Neither this nor a similar work has been published, submitted for publication, or submitted for an examination procedure to another department or institution. I assure that the presented research project has been conducted in full compliance with the rules of good scientific practice laid by the German Research Foundation (DFG).

Kiel,

.....

Sonakshi Mishra, M.Sc.

Erklärung

Hiermit erkläre ich, Sonakshi Mishra, dass ich, abgesehen von der Unterstützung meiner Betreuer, diese Doktorarbeit eigenständig und ohne unerlaubte Hilfe durchgeführt habe. Weder diese noch eine ähnliche Arbeit wurde an einer anderen Abteilung oder Hochschule im Rahmen eines Prüfungsverfahrens vorgelegt, veröffentlicht oder zur Veröffentlichung vorgelegt. Ich versichere, dass die Arbeit unter Einhaltung der guten wissenschaftlichen Praxis der Deutschen Forschungsgemeinschaft entstanden ist.

Kiel,

.....

Sonakshi Mishra, M.Sc.

1. Reviewer: Prof. Dr. Klaus Wallmann

2. Reviewer: Prof. Dr. Tina Treude

Date of PhD defense: 23.03.2016

Place of PhD defense: Kiel, Germany

I dedicate my entire doctoral work to both my beloved grandfathers, Shri Bamadev Mishra (1904 - 2007) and Shri Raghunath Mahapatra (1929 - 2015). This is for you both Bapa and Aja, the first teacher I ever had and the first scientist I ever saw. Thank you for that and a lot more.....

I missed the final goodbye. But this is how I will keep both of you with me, forever.

Contents

Abstract	2
Zusammenfassung	3
1. Introduction	5
1.1 Petroleum: Formation and Composition.....	5
1.2 Sources of petroleum in the ocean.....	6
1.3 Natural seepage of petroleum.....	7
1.4 Fate of petroleum in the marine environment	10
1.5 Biodegradation of petroleum in marine sediments.....	12
2. Objectives	24
3. Outline of manuscripts	26
4. Manuscript I	28
5. Manuscript II	70
6. Manuscript III	110
7. Final Summary and Conclusion	165

Abstract

This study presented for the first time the use of intact sediment cores in a continuous sediment-oil-flow-through (SOFT) system for investigating the degradation of petroleum under a simulated petroleum seepage. It suggests that the use of the SOFT system, which is designed to maintain the natural fabric and heterogeneity of the marine sediments, provides a more comprehensive understanding of the in situ processes involved in petroleum degradation at marine seeps compared to the traditional use of sediment slurries. The SOFT system enabled quasi in situ monitoring of ongoing biogeochemical changes taking place in sediments during petroleum seepage and to the best of our knowledge, showed microbial methanogenic degradation of hydrocarbons in an almost natural setting.

The biogeochemical response of sediments from hydrocarbon adapted sites like the Caspian Sea, North Alex Mud Volcano in the Eastern Mediterranean, the Santa Barbara Channel and non-adapted site like the Eckernfoerde Bay in the Baltic Sea to petroleum seepage was investigated and compared using the SOFT system. Distinct redox zonation was established in the sediment cores that evolved temporally and spatially during the upward migration of petroleum. Sulfate reduction and methanogenesis were identified as two major processes involved in the degradation of petroleum at seeps. The concentrations of n-alkanes decreased successively towards the sediment surface. Methanogenesis was identified to be involved in degradation of mid- to long-chain alkanes whereas sulfate reduction was identified to be the more dominant process involved in both short and mid- to long chain alkane degradation. The microbial diversity decreased in sediments after the onset of petroleum seepage indicating that only few specialized microbes are involved in the degradation of petroleum under in situ conditions. Short-chain volatile alkanes like ethane, propane, isobutane, n-butane, pentane and hexane were almost completely depleted in the sulfate reducing zone. Clade SCA1 and clade LCA2 were identified as two key sulfate reducing bacteria in the Caspian Sea sediments responsible for short-chain alkane degradation and for mid- to long-chain alkane degradation, respectively, whereas

syntrophic archaea of the genus *Methanosarcina* was identified to be involved in the methanogenic degradation of long-chain alkanes.

Among all sites, the fastest response to petroleum addition was seen in the North Alex Mud Volcano sediments followed by sediments from the Caspian Sea, the Santa Barbara Channel and the Eckernförde Bay suggesting that microbial communities in sediments with prior adaptation to hydrocarbon seepage are more efficient in degrading hydrocarbons compared to microbial communities from non-adapted sediments.

Zusammenfassung

Diese Studie zeigt die erstmalige Anwendung intakter Sedimentkerne in einem kontinuierlichen Sediment-Öl-Durchflusssystem (SOFT-System), welches den Abbau von Erdöl unter einem simulierten Erdölaustritt untersuchte. Das SOFT-System, welches entwickelt wurde um die natürliche Struktur und Heterogenität des marinen Sediments aufrechtzuerhalten, ermöglichte ein umfassenderes Verständnis der in situ Prozesse während des Erdölabbaus an den marinen Quellen, als die traditionell genutzten Sediment-Slurries (Sedimentgemische). Das SOFT System ermöglichte quasi in situ Untersuchungen der biogeochemischen Veränderungen, welche im Sediment während des Ölabbaus stattfanden. Des Weiteren wurde, nach bestem Wissen, der mikrobielle methanogene Abbau des Erdöls in einer beinahe natürlichen Umgebung gezeigt.

Die biogeochemische Reaktion der Sedimente in an Kohlenwasserstoffe angepasste Gebieten wie dem Kaspischen Meer, dem North Alex Schlammvulkan im östlichen Mittelmeer und dem Santa Barbara Kanal, wurden mit einem Gebiet das nicht an einen Erdölaustritt angepasst war, der Eckernförder Bucht in der Ostsee, unter Verwendung des SOFT Systems untersucht und verglichen. Es wurde eine ausgeprägte Redox-Zonierung in den Sedimentkernen festgestellt, welche sich mit dem aufsteigenden Erdöl zeitlich und räumlich bildete. Als die zwei, am Erdölabbau beteiligten Hauptprozesse, wurden Sulfatreduktion und Methanogenese identifiziert. Die Konzentration der n-Alkane verringerte sich sukzessiv in Richtung der Sedimentoberfläche. Die Methanogenese wurde

als beteiligter Prozess beim Abbau der mittel- und langkettigen Alkene erkannt, während Sulfatreduktion als dominanter Prozess in beides involviert war, den Abbau der kurz-, sowie der mittel- und langkettigen Alkane. Die mikrobielle Diversität verringerte sich nach Beginn des Erdölaustritts im Sediment, was darauf hinweist, dass nur einige wenige spezialisierte Bakterien in den Erdölabbau unter in situ Bedingungen involviert waren. Kurzkettige, flüchtige Alkane wie Ethan, Propan, Isobutan, n-Butan, Pentan und Hexan wurden beinahe vollständig in der Sulfatreduktionszone aufgebraucht. Die monophyletische Gruppe SCA1 wurde als eine der zwei Hauptsulfatreduzierer im Sediment des Kaspischen Meers identifiziert und war für den Abbau der kurzkettigen Alkane verantwortlich, während die monophyletische Gruppe LCA2 als zweiter Hauptsulfatreduzierer für den Abbau der mittel- und langkettigen Alkane identifiziert wurde. Wohingegen syntrophische Archaea der Gattung *Methanosarcina* für den methanogenen Abbau der langkettigen Alkane identifiziert wurden.

Alle Beprobungsstandorte betrachtend, zeigte die schnellste Reaktion auf die Zugabe von Erdöl das Sediment des North Alex Schlammvulkans, gefolgt vom Sediment des Kaspischen Meeres, dem Santa Barbara Kanal und der Eckernförder Bucht, was darauf schließen lässt, dass mikrobielle Gemeinschaften in Sedimenten, die schon vorher an einen Erdölaustritt angepasst waren, effizienter Erdöl abbauen, als mikrobielle Gemeinschaften in nicht an Erdöl angepassten Sedimenten.

1. Introduction

1.1 Petroleum: Formation and Composition

When buried organic matter in sedimentary basins is exposed to high temperatures and pressures over long periods of geological time, it undergoes structural rearrangement to form petroleum (Tissot & Welte, 1984; Bjorlykke, 2010). Petroleum is a complex mixture of hydrocarbons. Hydrocarbons are organic compounds made up of the two elements, carbon and hydrogen. Hydrocarbons can be formed by thermal degradation of buried organic matter (Tissot & Welte, 1984) or as metabolites of microbial, floral, or faunal activities (Widdel & Rabus, 2001; Widdel et al., 2006). Thus, the two elements carbon and hydrogen alone form more than 97% of the entire petroleum composition with some minor elements like oxygen, sulfur and nitrogen forming the rest (Hunt, 1995).

In nature, petroleum exists in both gaseous and liquid state and the main forms of petroleum are natural gas, condensate and crude oil (Hunt, 1995). The wide range of compounds that comprise petroleum are broadly categorized into four main groups, namely i) saturates or paraffins ii) aromatics iii) resins iv) asphaltenes (Tissot & Welte, 1984; Fig. 1). Saturates consist of normal and branched alkanes and cycloalkanes (naphthenes) that are hydrocarbons with single bonds between the carbon atoms. Cycloalkanes are the most common saturates and can make up to almost 50% of the average crude oil, and the normal alkanes (n-alkanes) are the next major constituents and can form around 15 to 20% of the total petroleum. Aromatics consist of hydrocarbons that contain at least one (monoaromatic) or more (polyaromatic) benzene rings. Resins and asphaltenes are high molecular weight polar, polycyclic compounds containing N, S and O atoms and comprise about half of the total nitrogen and sulfur found in petroleum. Resins are highly polar and more soluble than asphaltenes (Tissot & Welte, 1984; Hunt, 1995; Harayama et al., 1999). The relative contribution of the four groups vary in different kinds of petroleum. For example, in light crude oil, saturates comprise 55 to 90%, aromatics comprise 10 to 35% and resins and asphaltenes form 0 to 10% of the total petroleum.

Whereas in heavier crude oils, the percentage of aromatics, and the polar fraction (resins and asphaltenes) increases to about 15 to 40% and 10 to 40%, respectively (Fingas, 2010).

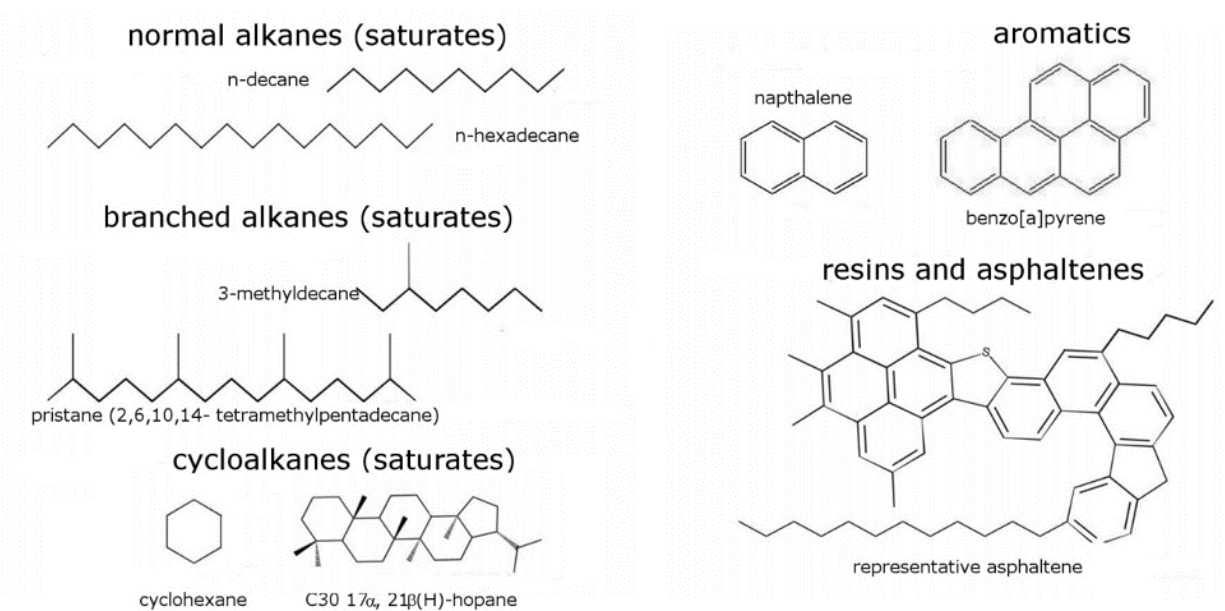

Figure 1. Some representative hydrocarbons of petroleum belonging to the different groups, namely saturates, aromatics, resins, and asphaltenes. *Source:* modified from (Laufer, 2012)

1.2 Sources of petroleum in the ocean

Petroleum enters the earth's ocean through natural and anthropogenic sources. In 2003, a report from the National Academy of Sciences, USA, summarized the state of the art knowledge on the input of petroleum into the marine environment (National Research Council, 2003). With an annual worldwide input of more than 1.3 million tonnes of petroleum per year, the sources of petroleum in the ocean were categorized into four main groups, namely i) natural seepage of petroleum, ii) petroleum extraction or production, iii) petroleum transportation, and iv) petroleum consumption (Fig. 2). Due to the increasing energy demand in the world, there is an increase in the production and consumption of petroleum. Almost 40% of the produced petroleum is transported via water (Prince et al., 2003), either through pipelines or with vessels. Hence, occasional release of petroleum

during the transport along with the accidental spills during extraction process are some of the forms of petroleum contamination by human activity in the marine environment. Petroleum consumption mostly takes place on land in industrialized and rapidly industrializing areas. Therefore, most of the petroleum contamination by human activity is passed onto the oceans from land via rivers and waste water streams, along with the pollution that arises from private boats and non-tank vessels. Although about 53% of petroleum enters the ocean through anthropogenic sources, natural seeps alone account for the rest half of the petroleum input into the ocean. The natural seepage of petroleum into the ocean is discussed in the following section in detail.

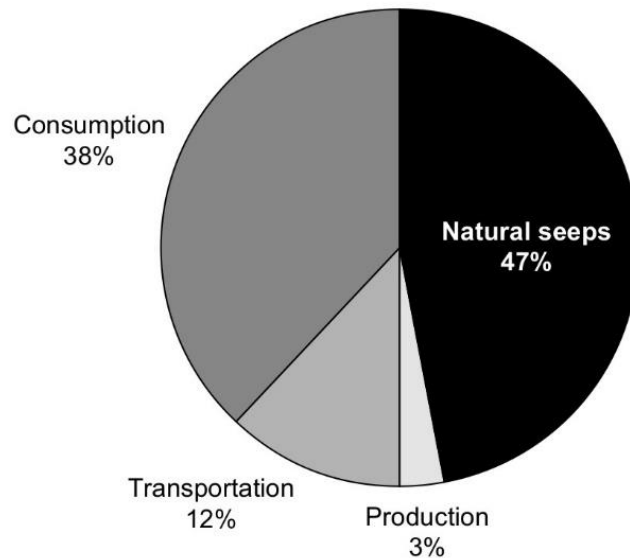

Figure 2. Relative contribution of the individual sources of petroleum in the marine environment.
Source: (Prince et al., 2003)

1.3 Natural seepage of petroleum

After petroleum is generated in subsurface sediments, it undergoes primary and secondary migration until it ends up in reservoirs, from where it may occasionally seep out to the surface.

Petroleum generation:

During the early diagenesis of buried organic matter, complex organic compounds break down to simpler compounds like amino acids and carbohydrates. These smaller compounds then combine to form larger complex compounds that are collectively called kerogen that is insoluble in organic solvents. Hence, kerogen is defined as the insoluble part of buried organic matter and is the precursor of petroleum. At sediment depths of 3 to 4 km, where the temperature is sufficiently high (100°C to 150°), kerogen is converted to petroleum over long geological time periods (Bjorlykke, 2010).

Petroleum migration:

When kerogen matures, oil and gas are expelled from the source bed to adjacent rocks. This release of petroleum from kerogen through the narrow capillaries and pores of the fine grained source bed is called the primary migration (Tissot & Welte, 1984). Once released from the source rock, petroleum flows through more permeable carrier and reservoir rocks before accumulating as oil and gas pools in traps. This represents the secondary migration of petroleum. Secondary migration of petroleum consists of a multiphase flow (oil, gas and water) and is governed by two main forces, buoyancy and capillary pressure. As the density of oil (0.7 to 1 g cm⁻³) is lower than that of water (1 to 1.2 g cm⁻³), the main driver for oil movement through the sediments is buoyancy. However, the buoyancy force must be strong enough to overcome the capillary resistance of the small pore throats in the sediment. During a two phase flow of oil and water in a water saturated system, oil droplets will be held back by the capillary forces due to their low relative permeability whereas the water will flow past them through the pores. Hence, oil saturated pathways are required for the secondary migration of petroleum (Bjorlykke, 2010). During secondary migration, petroleum can cover ten to hundreds of kilometers (Tissot & Welte, 1984). Ultimately, petroleum accumulates as oil and gas pools in traps which may sometimes cause the hydrocarbons to seep out at the surface.

Petroleum seeps:

Petroleum seeps to the surface, where there is a permeable pathway present directly from the source strata up to the surface or when there is a leakage in the hydrocarbon accumulations of the oil reservoirs (Hunt, 1995). Seeps are mostly found along continental margins and in sedimentary rocks that have been folded, faulted and eroded. Areas where petroleum visibly leaks out at the surface of marine sediments with high concentrations of low and high molecular weight hydrocarbons are called active macroseeps, and areas where there is no visible hydrocarbon seepage but only invisible seepage of gaseous hydrocarbons are called microseeps (Meer et al., 2002). Petroleum seeping out of these seeps can end up forming oil slicks in the surface waters that can spread up to tens of kilometers (Leifer et al., 2006) and releasing greenhouse gases like methane into the atmosphere (Solomon et al., 2009). Although natural seeps have been releasing crude oil and have thereby been impacting the marine environment since prehistoric times, the attention on their environmental impact has developed only recently after some of the large scale anthropogenic oil spills occurred in the 1960s (Fingas, 2010). It is estimated that around 600,000 tonnes of petroleum enters the earth's ocean via natural seeps each year, which forms almost half of the total input of petroleum into the ocean per year (National Research Council, 2003; Kvenvolden & Cooper, 2003). The number of regions detected to have seeps have increased over the last years due to improved technology (Kvenvolden & Cooper, 2003, Fig. 3). Some of the world's most intense natural seeps of petroleum are found in the Santa Barbara Channel (Hornafius et al., 1999), the Gulf of Mexico (MacDonald, 1993) and the Caspian Sea (Guliev & Feizullayev, 1996; Guliyev et al., 2003).

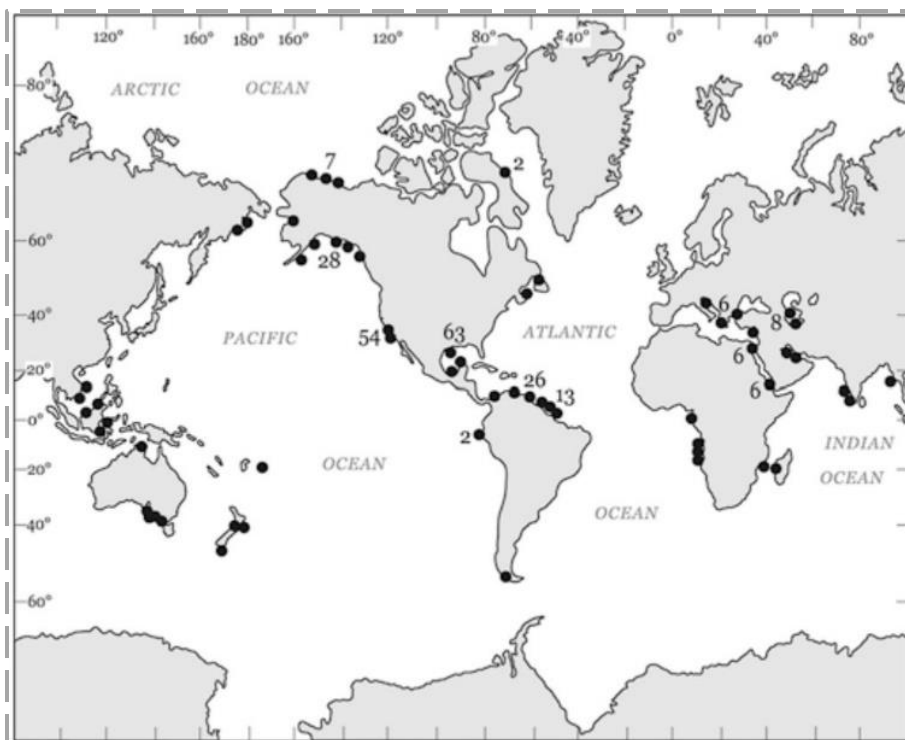

Figure 3. Known locations of naturally occurring crude oil seeps in the marine environment. The numbers allotted to the black dots represent the number of seeps in that region. *Source:* (Kvenvolden & Cooper, 2003)

1.4 Fate of petroleum in the marine environment

Despite the huge amounts of petroleum that enters the earth's ocean each year, the ocean is still not flooded with oil. This is due to the fact that petroleum is subjected to a series of physical, chemical and biological processes collectively called as "weathering" that breaks down the petroleum composition (National Research Council, 2003; Fingas, 2010). The different weathering processes are emulsification, evaporation, dissolution, natural dispersion, photo-oxidation and microbial degradation (Fingas, 2010). Microbial degradation, however, is considered to be the major and the ultimate process of hydrocarbon degradation (Das & Chandran, 2010 and references therein). Microbial degradation can completely convert petroleum hydrocarbons to CO_2 and H_2O , and is considered to be the principal hydrocarbon removal processes in the aquatic environment (National Research Council, 2003). It is stated that without the microbial degradation of petroleum, there would be a thin layer of oil (20 molecules thick) covering the entire

surface of the earth's ocean today (Head et al., 2006). Hence, focus of the thesis will be on microbial degradation (biodegradation) of petroleum.

1.4.1 Biodegradation of petroleum

Microorganisms in the environment can utilize hydrocarbons as the sole or major source of carbon and energy and in the process mineralize them to CO₂ and H₂O (Röling et al., 2002 and references therein). Microbial oxidation of hydrocarbons can take place in both the presence and absence of oxygen and in all cases, a part of the hydrocarbon is stored as cell mass and a part of it is conserved as energy (Widdel & Rabus, 2001). Biodegradation of petroleum in the environment is primarily done by bacteria and fungi. However, in the marine environment, bacteria are the predominant hydrocarbon degraders (Leahy & Colwell, 1990). The rate of microbial degradation of hydrocarbons in the ocean depends on several environmental factors like the availability of nutrients and terminal electron acceptors, composition and concentration of petroleum, temperature, salinity and pressure (Leahy & Colwell, 1990). For example, the polar fraction (resins and asphaltenes) are highly resistant to biodegradation, compared to the saturated and aromatic fractions. Within the saturated fraction, n-alkanes are more susceptible to biodegradation compared to branched alkanes. Aerobic degradation of hydrocarbons has been well known and documented for a long time (Head et al., 2006 and references therein). In the aerobic oxidation of hydrocarbons, oxygen is used both as a terminal electron acceptor as well as for the initial substrate activation (Fig. 4). However, anaerobic degradation of hydrocarbons was not recognized for a long time due to its low reactivity (Widdel et al., 2010). Nevertheless, since the last two decades, several compounds are known to be oxidized under anaerobic conditions. Today it is known that anaerobic hydrocarbon degraders can oxidize hydrocarbons by using nitrate, iron(III), or sulfate as electron acceptors and also under methanogenic conditions (Widdel et al., 2010).

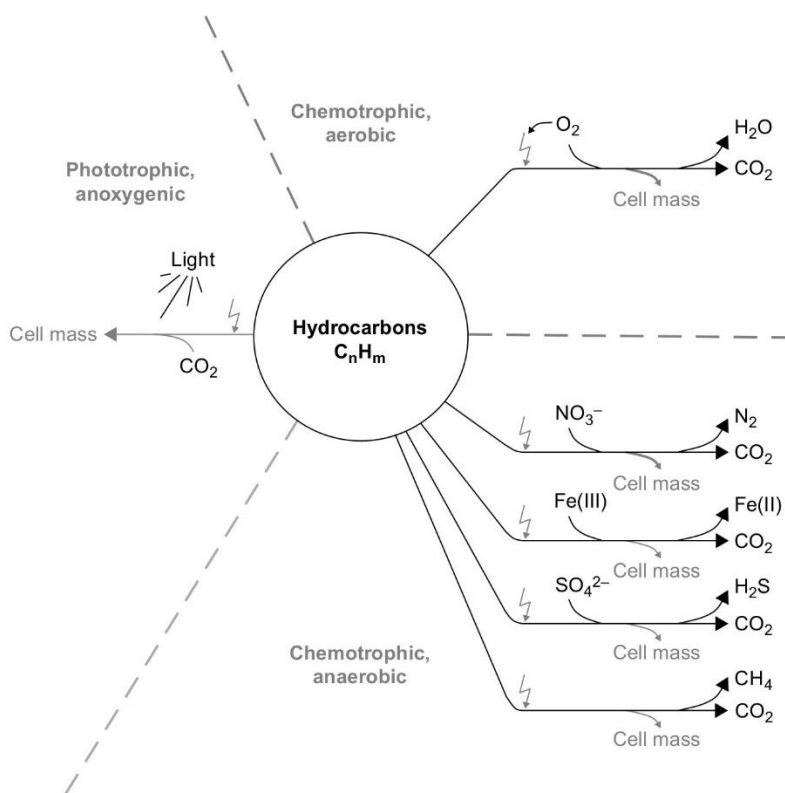

Figure 4. Different pathways of aerobic and anaerobic oxidation of hydrocarbons by microorganisms. *Source:* (Widdel & Rabus, 2001)

1.5 Biodegradation of petroleum in marine sediments

1.5.1 Organic matter degradation in marine sediments

Different redox processes are involved in the biodegradation of organic matter in marine sediments. Bacteria use oxidants (electron acceptors) to oxidize the reduced organic matter. The microbial degradation of organic matter in marine sediments is characterized by a vertical (depth dependent) sequence of oxidants (Jorgensen, 2006). The vertical sequence of the oxidants and the corresponding redox processes are based on the decreasing redox potential and energy yield of the respective metabolic processes (Fig. 5). For example, oxygen is thermodynamically the most favored electron acceptor because it has the highest free energy yield ($\Delta^\circ G = -479 \text{ kJ mol}^{-1}$) whereas, the energy yield of sulfate reduction is only a fraction of its free energy yield ($\Delta^\circ G = -77 \text{ kJ mol}^{-1}$). Microbial degradation of petroleum in marine sediments is also controlled by the natural redox

ladder of marine sediments and petroleum can be degraded under both aerobic and anaerobic conditions. However, as most of the oxygen is consumed in the upper millimeters to centimeters or decimeters of the sediment (Jorgensen, 2006 and references therein), petroleum degradation in the marine sediments would take place mainly under anaerobic conditions. Therefore, we will focus on the anaerobic degradation of petroleum in marine sediments in the following section.

1.5.2 Anaerobic degradation of petroleum in marine seep sediments

Most of the world's petroleum reserve is partly biodegraded due to the microbial alteration of hydrocarbons in subsurface reservoirs (Röling et al., 2003). In contrast to marine spills, where petroleum first reaches the marine sediment surface from above after undergoing powerful aerobic biodegradation in the oxygenated water column (Head et al., 2006), in a petroleum seep it first reaches the sediment surface from the energetically lower end of the redox cascade after moving through the anoxic and reduced subsurface regions (Fig. 5). Therefore, anaerobic degradation is the most important process in degradation of petroleum in marine sediments. In the absence of oxygen, petroleum hydrocarbons can be mediated by use of other electron acceptors through process like denitrification, iron(III) reduction, sulfate reduction and methanogenesis (Harayama et al., 1999 and references therein). While aerobic degradation of petroleum hydrocarbons has been well known for a long time already, the recognition of anaerobic degradation of hydrocarbons has started only recently since the late 1980s (Heider et al., 1998; Widdel & Rabus, 2001; Widdel et al., 2010). Due to the observation of sulfide formation in anoxic oil fields (Bastin et al., 1926) there were speculations and investigations on anaerobic degradation of hydrocarbons for a long time. Yet, no reproducible laboratory experiment could show anaerobic degradation of hydrocarbons until the 1980s (Aeckersberg et al., 1991; Widdel et al., 2006 and references therein). Today, anaerobic degradation of several alkanes, alkenes, alkynes, aromatics have been reported through isolation-culture experiments (Widdel et al., 2006 and references therein). Despite the increasing number of studies on anaerobic degradation, there is still a lack of knowledge on the anaerobic hydrocarbon degraders at the ecosystem and

molecular level (Widdel et al., 2010). As saturated alkanes form the major part of the petroleum (see section 1.1), the following section will mostly focus on the anaerobic degradation of alkanes.

Anaerobic degradation of Alkanes:

The first report of an isolate that could degrade an alkane (n-hexadecane) was reported in 1991 by (Aeckersberg et al., 1991) under sulfate reducing conditions. Until recently, most of the isolates that have been shown to have degraded hydrocarbons anaerobically had used only n-alkanes > C₆, i.e. alkanes with six or more carbon atoms (Heider et al., 1998; Wentzel et al., 2007 and references therein). Among the short chain alkanes (<C₆), considerable focus has been given on the investigation of anaerobic oxidation of methane since it is a potential greenhouse gas (Bose et al., 2013). Anaerobic oxidation of methane is the microbial process where methane is oxidized by a consortium of methanogenic archaea and sulfate reducing bacteria with sulfate as the terminal electron acceptor (Treude, 2003 and references therein). The first evidence of anaerobic methane oxidation in organic rich marine sediments came in 1974 by (Martens & Berner, 1974). Since then, considerable progress has been made in the investigation of anaerobic oxidation of methane (Knittel & Boetius, 2009 and references therein). However, compared to methane oxidation the investigation of anaerobic oxidation of non-methane alkanes (C₂ to C₅) falls behind despite being present at marine seeps in significant amounts (Bose et al., 2013; Adams et al., 2013). In 2007, for the first time, sulfate reducers capable of anaerobic degradation of short chain alkanes (propane and n-butane) were enriched and isolated from sediments of the Gulf of Mexico and Guaymas Basin (Kniemeyer et al., 2007). So far, most of the anaerobic hydrocarbon degraders of short chain alkanes that have been detected, are also only sulfate reducing bacteria (Musat, 2015 and references therein). Stoichiometric equations for anaerobic oxidation of some hydrocarbons by sulfate reduction are provided in Table 1. Under the absence of sulfate as an electron acceptor, anaerobic oxidation of alkanes can take place under methanogenic conditions (Zengler et al., 1999). For a long time, anaerobic oxidation of hydrocarbons was doubted. However, Zengler et al., (1999) showed the first

enrichment cultures that could degrade hexadecane under strictly methanogenic conditions (Eq. 1).

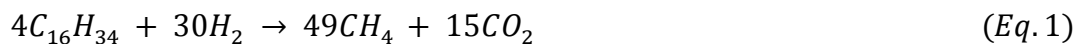

Other studies have also reported methanogenic degradation of alkanes (for example, Siddique et al., 2006; Cheng et al., 2013). In subsurface petroleum reservoirs, where exogenous electron acceptors are missing, methanogenesis is the predominant process involved in the anaerobic oxidation of hydrocarbons (Jones et al., 2008; Sherry et al., 2014 and references therein).

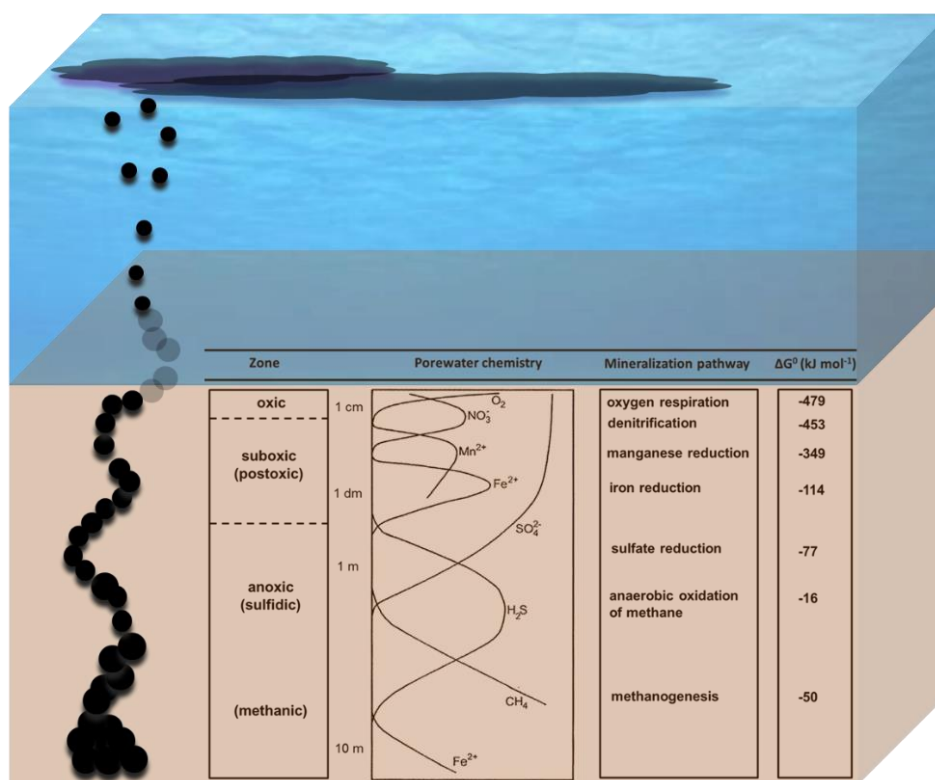

Figure 5. A schematic representation of the biogeochemical zonation (marine redox ladder) in marine sediments along with a schematic representation of petroleum seeping out at the sediment. At marine seeps, petroleum enters from the energetically lower end of the marine redox ladder. *Source:* modified from (Jørgensen & Kasten, 2006); the left column represents the main zones proposed by (Froelich et al., 1979) and the zones mentioned in brackets are from (Berner, 1981); the middle column represents porewater chemistry of some dissolved species; the right columns shows the standard free energy yields (Burdige, 2006).

Table 1. Stoichiometric equations of anaerobic oxidation of different hydrocarbons under sulfate reducing conditions. *Source:* (Widdel et al., 2009).

Hydrocarbon	Stoichiometric equation of oxidation
Methane	$\text{CH}_4 + \text{SO}_4^{2-} \rightarrow \text{HCO}_3^- + \text{HS}^- + \text{H}_2\text{O}$
Ethane	$4 \text{C}_2\text{H}_6 + 7 \text{SO}_4^{2-} \rightarrow 8 \text{HCO}_3^- + 7 \text{HS}^- + \text{H}^+ + 4 \text{H}_2\text{O}$
Propane	$2 \text{C}_3\text{H}_8 + 5 \text{SO}_4^{2-} \rightarrow 6 \text{HCO}_3^- + 5 \text{HS}^- + \text{H}^+ + 2 \text{H}_2\text{O}$
<i>n</i> -Hexane	$4 \text{C}_6\text{H}_{14} + 19 \text{SO}_4^{2-} \rightarrow 24 \text{HCO}_3^- + 19 \text{HS}^- + 5 \text{H}^+ + 4 \text{H}_2\text{O}$
Cyclohexane	$2 \text{C}_6\text{H}_{12} + 9 \text{SO}_4^{2-} \rightarrow 12 \text{HCO}_3^- + 9 \text{HS}^- + 3 \text{H}^+$
<i>n</i> -Hexadecane	$4 \text{C}_{16}\text{H}_{34} + 49 \text{SO}_4^{2-} \rightarrow 64 \text{HCO}_3^- + 49 \text{HS}^- + 15 \text{H}^+ + 4 \text{H}_2\text{O}$
Ethene	$2 \text{C}_2\text{H}_4 + 3 \text{SO}_4^{2-} \rightarrow 4 \text{HCO}_3^- + 3 \text{HS}^- + \text{H}^+$
Benzene	$4 \text{C}_6\text{H}_6 + 15 \text{SO}_4^{2-} + 12 \text{H}_2\text{O} \rightarrow 24 \text{HCO}_3^- + 15 \text{HS}^- + 9 \text{H}^+$
Toluene	$2 \text{C}_7\text{H}_8 + 9 \text{SO}_4^{2-} + 6 \text{H}_2\text{O} \rightarrow 14 \text{HCO}_3^- + 9 \text{HS}^- + 5 \text{H}^+$
<i>m</i> -Xylene	$4 \text{C}_8\text{H}_{10} + 21 \text{SO}_4^{2-} + 12 \text{H}_2\text{O} \rightarrow 32 \text{HCO}_3^- + 21 \text{HS}^- + 11 \text{H}^+$
Ethylbenzene	$4 \text{C}_8\text{H}_{10} + 21 \text{SO}_4^{2-} + 12 \text{H}_2\text{O} \rightarrow 32 \text{HCO}_3^- + 21 \text{HS}^- + 11 \text{H}^+$
Naphthalene	$\text{C}_{10}\text{H}_8 + 6 \text{SO}_4^{2-} + 6 \text{H}_2\text{O} \rightarrow 10 \text{HCO}_3^- + 6 \text{HS}^- + 4 \text{H}^+$
1-Methylnaphthalene	$4 \text{C}_{11}\text{H}_{10} + 27 \text{SO}_4^{2-} + 24 \text{H}_2\text{O} \rightarrow 44 \text{HCO}_3^- + 27 \text{HS}^- + 17 \text{H}^+$
2-Methylnaphthalene	$4 \text{C}_{11}\text{H}_{10} + 27 \text{SO}_4^{2-} + 24 \text{H}_2\text{O} \rightarrow 44 \text{HCO}_3^- + 27 \text{HS}^- + 17 \text{H}^+$
Phenanthrene	$4 \text{C}_{14}\text{H}_{10} + 33 \text{SO}_4^{2-} + 36 \text{H}_2\text{O} \rightarrow 56 \text{HCO}_3^- + 33 \text{HS}^- + 23 \text{H}^+$

References

- Adams, M.M., Hoarfrost, A.L., Bose, A., Joye, S.B. & Girguis, P.R. (2013). Anaerobic oxidation of short-chain alkanes in hydrothermal sediments: potential influences on sulfur cycling and microbial diversity. *Frontiers in Microbiology*. 4. p.pp. 1–11.
- Aeckersberg, F., Bak, F. & Widdel, F. (1991). Anaerobic oxidation of saturated hydrocarbons to CO₂ by a new type of sulfate-reducing bacterium. *Archives of Microbiology*. 156 (1). p.pp. 5–14.
- Bastin, E.S., Greer, F.E., Merritt, C.A. & Moulton, G. (1926). The presence of sulphate reducing bacteria in oil field waters. *Science (New York, NY)*. 63 (1618). p.pp. 21–24.
- Berner, R. (1981). A new geochemical classification of sedimentary environments. *Journal of Sedimentary Research*. 51 (2). p.pp. 359–365.
- Bjorlykke, K. (2010). *Petroleum geoscience: From sedimentary environments to rock physics*. Springer Science & Business Media.
- Bose, A., Rogers, D.R., Adams, M.M., Joye, S.B. & Girguis, P.R. (2013). Geomicrobiological linkages between short-chain alkane consumption and sulfate reduction rates in seep sediments. *Frontiers in Microbiology*. 4 (386). p.pp. 1–13.
- Burdige, D. (2006). *Geochemistry of marine sediments*. In: Princeton: Princeton University Press.
- Cheng, L., Rui, J., Li, Q., Zhang, H. & Lu, Y. (2013). Enrichment and dynamics of novel syntrophs in a methanogenic hexadecane-degrading culture from a Chinese oilfield. *FEMS microbiology ecology*. 83 (3). p.pp. 757–66.
- Das, N. & Chandran, P. (2010). Microbial degradation of petroleum hydrocarbon contaminants: an overview. *Biotechnology research international*. 2011.

- Fingas, M. (2010). *Oil spill science and technology*. Gulf professional publishing.
- Froelich, P.N., Klinkhammer, G.P., Bender, M.L., Luedtke, N. a., Heath, G.R., Cullen, D., Dauphin, P., Hammond, D., Hartman, B. & Maynard, V. (1979). Early oxidation of organic matter in pelagic sediments of the eastern equatorial Atlantic: suboxic diagenesis. *Geochimica et Cosmochimica Acta*. 43 (7). p.pp. 1075–1090.
- Guliev, I. & Feizullayev, A. (1996). *Geochemistry of hydrocarbon seepages in Azerbaijan*.
- Guliyev, I.S., Mamedov, A. V, Feyzullayev, A.A., Huseynov, D.A., Kadirov, F.A., Aliyeva, E. & Tagiyev, M.F. (2003). *Hydrocarbon systems of the South Caspian Basin*. Nafta-Press, Baku.
- Harayama, S., Kishira, H., Kasai, Y. & Shutsubo, K. (1999). Petroleum biodegradation in marine environments. *Journal of molecular microbiology and biotechnology*. 1 (1). p.pp. 63–70.
- Head, I.M., Jones, D.M. & Röling, W.F.M. (2006). Marine microorganisms make a meal of oil. *Nature reviews. Microbiology*. 4 (3). p.pp. 173–182.
- Heider, J., Spormann, A.M., Beller, H.R. & Widdel, F. (1998). Anaerobic bacterial metabolism of hydrocarbons. *FEMS Microbiology Reviews*. 22 (5). p.pp. 459–473.
- Hornafius, J.S., Quigley, D. & Luyendyk-, B.P. (1999). The world's most spectacular marine hydrocarbon seeps (Coal Oil Point, Santa Barbara Channel, California): Quantification of emissions. *Journal of Geophysical Research: Oceans (1978–2012)*. 104 (C9). p.pp. 20703–20711.
- Hunt, M. (1995). *Petroleum geochemistry and geology*. WH Freeman and Company.
- Jones, D.M., Head, I.M., Gray, N.D., Adams, J.J., Rowan, a K., Aitken, C.M., Bennett, B., Huang, H., Brown, A., Bowler, B.F.J., Oldenburg, T., Erdmann, M. & Larter, S.R. (2008). Crude-oil biodegradation via methanogenesis in subsurface petroleum reservoirs. *Nature*. 451 (7175). p.pp. 176–180.
- Jørgensen, B. & Kasten, S. (2006). Sulfur cycling and methane oxidation. In: *Marine*

- geochemistry*. Springer Berlin Heidelberg, pp. 271–309.
- Jorgensen, B.B. (2006). Bacteria and marine biogeochemistry. In: *Marine Geochemistry*. Springer Berlin Heidelberg, pp. 169–206.
- Kniemeyer, O., Musat, F., Sievert, S.M., Knittel, K., Wilkes, H., Blumenberg, M., Michaelis, W., Classen, A., Bolm, C., Joye, S.B. & Widdel, F. (2007). Anaerobic oxidation of short-chain hydrocarbons by marine sulphate-reducing bacteria. *Nature*. 449 (7164). p.pp. 898–901.
- Knittel, K. & Boetius, A. (2009). Anaerobic Oxidation of Methane: Progress with an Unknown Process. *Annual Review of Microbiology*. 63 (1). p.pp. 311–334.
- Kvenvolden, K.A. & Cooper, C.K. (2003). Natural seepage of crude oil into the marine environment. *Geo-Marine Letters*. 23 (3-4). p.pp. 140–146.
- Laufer, K. (2012). *Microbial response to the addition of light and rich oil to natural marine sediments*. Christian-Albrechts-Universität zu Kiel.
- Leahy, J.G. & Colwell, R.R. (1990). Microbial degradation of hydrocarbons in the environment. *Microbiological reviews*. 54 (3). p.pp. 305–315.
- Leifer, I., Luyendyk, B. & Broderick, K. (2006). Tracking an oil slick from multiple natural sources, Coal Oil Point, California. *Marine and Petroleum Geology*. 23 (5). p.pp. 621–630.
- MacDonald, I. (1993). Natural oil slicks in the Gulf of Mexico visible from space. *Journal of Geophysical Research*. 98 (C9). p.pp. 16351–16364.
- Martens, C. & Berner, R. (1974). Methane production in the interstitial waters of sulfate-depleted marine sediments. *Science*. 4 (386). p.pp. 1–13.
- Meer, F. Van Der, Dijk, P. Van, Werff, H. Van Der & Yang, H. (2002). Remote sensing and petroleum seepage: a review and case study. *Terra Nova*. 14 (1). p.pp. 1 – 17.
- Musat, F. (2015). The anaerobic degradation of gaseous, nonmethane alkanes — From in

- situ processes to microorganisms. *Computational and Structural Biotechnology Journal*. 13. p.pp. 222–228.
- National Research Council, 2003 (2003). *Oil in the Sea III:: Inputs, Fates, and Effects*. National Academies Press.
- Prince, R.C., Lessard, R.R. & Clark, J.R. (2003). Bioremediation of marine oil spills. *Trends in biotechnology*. 58 (4). p.pp. 463–468.
- Röling, W.F.M., Head, I.M. & Larter, S.R. (2003). The microbiology of hydrocarbon degradation in subsurface petroleum reservoirs: Perspectives and prospects. *Research in Microbiology*. 154. p.pp. 321–328.
- Röling, W.F.M., Milner, M.G., Jones, D.M., Lee, K., Daniel, F., Swannell, R.J.P., Head, M. & Head, I.M. (2002). Robust Hydrocarbon Degradation and Dynamics of Bacterial Communities during Nutrient-Enhanced Oil Spill Bioremediation Robust Hydrocarbon Degradation and Dynamics of Bacterial Communities during Nutrient-Enhanced Oil Spill Bioremediation. *Applied and Environmental Microbiology*. 68 (11). p.pp. 5537–5548.
- Sherry, A., Grant, R.J., Aitken, C.M., Jones, D.M., Head, I.M. & Gray, N.D. (2014). Volatile hydrocarbons inhibit methanogenic crude oil degradation. *Frontiers in Microbiology*. 5. p.pp. 1–9.
- Siddique, T., Fedorak, P.M. & Foght, J.M. (2006). Biodegradation of short-chain n-alkanes in oil sands tailings under methanogenic conditions. *Environmental Science and Technology*. 40 (17). p.pp. 5459–5464.
- Solomon, E.A., Kastner, M., MacDonald, I.R. & Leifer, I. (2009). Considerable methane fluxes to the atmosphere from hydrocarbon seeps in the Gulf of Mexico. *Nature Geoscience*. 2 (8). p.pp. 561–565.
- Tissot, B.P. & Welte, D.H. (1984). *Petroleum formation and occurrence*. Springer Science & Business Media.
- Treude, T. (2003). *Anaerobic oxidation of methane in marine sediments*. University of

Bremen.

- Wentzel, a, Ellingsen, T.E., Kotlar, H.K., Zotchev, S.B. & Throne-Holst, M. (2007). Bacterial metabolism of long-chain n-alkanes. *Applied Microbiology and Biotechnology*. 76 (6). p.pp. 1209–1221.
- Widdel, F., Boetius, A. & Rabus, R. (2006). Anaerobic biodegradation of hydrocarbons including methane. In: *The prokaryotes*. Springer New York, pp. 1028–1049.
- Widdel, F., Knittel, K. & Galushko, A. (2010). Anaerobic Hydrocarbon-Degrading Microorganisms: An Overview. In: *Handbook of Hydrocarbon and Lipid Microbiology*. Springer Berlin Heidelberg, pp. 1997–2021.
- Widdel, F., Musat, F., Knittel, K. & Galushko, A. (2009). Anaerobic degradation of hydrocarbons with sulphate as electron acceptor. In: *Sulphate-Reducing Bacteria Environmental and Engineered Systems*. Cambridge University Press, pp. 265–304.
- Widdel, F. & Rabus, R. (2001). Anaerobic biodegradation of saturated and aromatic hydrocarbons. *Current Opinion in Biotechnology*. 12 (3). p.pp. 259–276.
- Widdel, F. & Rabus, R. (2001). Anaerobic degradation of saturated and aromatic hydrocarbons. *Current Opinions in Biotechnology*. 12. p.pp. 259–276.
- Zengler, K., Richnow, H.H., Rosselló-Mora, R., Michaelis, W. & Widdel, F. (1999). Methane formation from long-chain alkanes by anaerobic microorganisms. *Nature*. 401 (6750). p.pp. 266–269.

2. Objectives

The following study aims at understanding the microbial degradation of petroleum under in situ conditions of a marine seep. It will focus on the biogeochemical response of natural marine sediments to a simulated petroleum seepage. The main objectives of this study are:

- 1) Which are the major processes responsible for petroleum degradation along its natural migration pathway in marine seeps?
- 2) What is the succession of petroleum degradation along its natural migration pathway in marine seeps?
- 3) Which microorganisms are the key hydrocarbon degraders and how are different microbial communities distributed along its natural pathway in marine seeps?
- 4) How do different marine sediments with respect to their history of hydrocarbon adaptation respond to petroleum seepage?

In order to meet the above goals, a sediment-oil-flow-through (SOFT) was set up that could simulate petroleum seepage in marine different marine sediments. Upon installing the SOFT system, comprehensive monitoring of the biogeochemical parameters was conducted on sediments undergoing petroleum seepage to answer the above questions.

3. Outline of manuscripts

Chapters 4, 5 and 6 this PhD dissertation are presented in the form of scientific manuscripts for submission in scientific journals. Chapter 4 and 5 are already submitted and under review in a scientific journal. Chapter 6 is in preparation for submission to a scientific journal in March, 2016. My contribution to each manuscript as an author is described below:

Manuscript I: Evolution of biogeochemical gradients and vertical succession of hydrocarbon degradation in Caspian Sea sediments subjected to simulated petroleum seepage

Sonakshi Mishra, Marion Stagars, Peggy Wefers, Mark Schmidt, Katrin Knittel, Martin Krüger, Philip Steeb, and Tina Treude

Submitted to: Environmental Microbiology, December 2015 (under review)

This study was initiated by Tina Treude. Sonakshi Mishra designed the experiments with the input from Tina Treude and developed the Sediment-Oil-Flow-Through System with assistance from Philip Steeb. Sediment cores were collected by Sonakshi Mishra and Mark Schmidt. Sonakshi Mishra did the sediment and porewater sampling, the microsensor measurements, the porosity analyses as well as the sulfate reduction and alkalinity analyses. Set up of the oil analysis method and the analyses were done by Sonakshi Mishra and Peggy Wefers. Mark Schmidt carried out the measurement of C1 to C6 n-alkanes and isotope analyses of ¹³C-Methane. Molecular analyses were done by Marion Stagars and Katrin Knittel. Enrichment culturing was done by Martin Krüger. The manuscript was written by Sonakshi Mishra with the input of all coauthors.

Manuscript II: Microbial community response to simulated petroleum seepage in Caspian Sea sediments

Submitted to: Environmental Microbiology, December 2015 (under review)

Marion Stagars, **Sonakshi Mishra**, Tina Treude, Rudolf Amann, and Katrin Knittel

As a follow up to chapter 1, this study was initiated as a collaboration between Tina Treude from GEOMAR, Helmholtz Centre for Ocean Research, Kiel and Katrin Knittel from the Max Planck Institute of Marine Microbiology (MPI), Bremen. Microbial

community analyses and statistical analyses were done by Marion Stagars and Katrin Knittel. Experimental set up and sediment samples for the community analyses and the geochemical data for correlation and interpretation was provided by Sonakshi Mishra. The manuscript was written by Marion Stagars with the input from all the coauthors.

Manuscript III: Comparative study of microbial petroleum degradation in marine seep vs. non-seep sediments in a simulated petroleum seepage

In preparation: *Geochimica et Cosmochimica Acta*, (submission presumably in March, 2016)

Sonakshi Mishra , Marion Stagars , Peggy Wefers , Katja Laufer, Johanna Maltby, Mark Schmidt, Katrin Knittel, Ira Leifer and Tina Treude

This study was initiated by Tina Treude. Sonakshi Mishra carried out the experimental set up for the Sediment-Oil-Flow-Through System. Sediment cores were collected by Tina Treude, Johanna Maltby, and Ira Leifer. Sonakshi Mishra did the sediment and porewater sampling, the porosity analyses, the microsensor measurements and the alkalinity analyses. Sonakshi Mishra and Tina Treude did the sulfate reduction analyses. Set up of the oil analyses method and the analyses were done by Sonakshi Mishra and Peggy Wefers. Molecular analyses were done by Marion Stagars and Katrin Knittel. Sonakshi Mishra and Katja Laufer conducted the slurry experiments. Johanna Maltby provided the sulfate and methane data for the initial Eckernförde Bay core. Mark Schmidt carried out the measurement of C1 to C6 n-alkanes and ¹³C-Methane isotope analyses. The manuscript was written by Sonakshi Mishra with the input of all coauthors.

First Reviewer:

PhD

Candidate:

Prof. Dr. Klaus Wallmann
Mishra

Sonakshi

4. Manuscript I

Evolution of biogeochemical gradients and vertical succession of hydrocarbon degradation in Caspian Sea sediments subjected to simulated petroleum seepage

Sonakshi Mishra ^a, Marion Stagars ^b, Peggy Wefers ^a, Mark Schmidt ^a, Katrin Knittel ^b,
Martin Krüger ^c, Philip Steeb^a, and Tina Treude ^{a,b*}

^aGEOMAR Helmholtz Center for Ocean Research Kiel, Department of Marine Biogeochemistry, Kiel, Germany

^bMax Planck Institute for Marine Microbiology, Bremen, Germany

^cFederal Institute for Geosciences and Natural Resources, Hannover, Germany

^{b}Present address: University of California, Los Angeles, Departments of Earth, Planetary & Space Sciences and Atmospheric & Oceanic Sciences, Los Angeles, USA*

Submitted to

Environmental Microbiology, 2015

Abstract

The microbial response to simulated petroleum seepage was investigated by incubating Caspian Sea sediments in a sediment-oil-flow-through (SOFT) system. Distinct redox zones established within the sediment core during upward petroleum migration and the sediment depths of these different geochemical zones changed over time. Methanogenesis and sulfate reduction were identified as important processes involved in the anaerobic degradation of hydrocarbons. The $\delta^{13}\text{C}$ signal of produced methane decreased from -33.7‰ to -49.5‰ after 190 days of petroleum seepage indicating microbial methane production. The relevance of methanogenesis in anaerobic degradation of petroleum was further confirmed by enrichment culturing. Sulfate reduction related to petroleum seepage was indicated by enhanced activity and sulfide accumulation. Volatile hydrocarbons (C2 to C6 n-alkanes) were completely depleted within the sulfate-reducing zone and higher n-alkanes (C10 to C40) decreased step-wise towards the top of the sediment core. The SOFT system enabled for the first time quasi-in situ monitoring of the successive response of geomicrobiological processes to petroleum seepage through sediment and revealed, to our knowledge, for the first time methane production related to hydrocarbon degradation under close natural conditions.

Introduction

Petroleum comprises a complex mixture of hydrocarbons. Geothermal action on kerogen in fine-grained sedimentary rocks leads to the formation of petroleum over geological timescales. Petroleum then sometimes migrates from its source rock and accumulates, forming reservoirs, when overlaying impermeable rocks blocks its upward movement. From these reservoirs, petroleum may seep to the sediment/soil surface through faults and cracks driven by buoyancy, capillary pressure and hydrodynamic gradients (Tissot & Welte, 1984). The main groups of petroleum are saturated hydrocarbons (normal and branched alkanes), aromatic hydrocarbons, resins and asphaltenes (Tissot & Welte, 1984). The two principal processes, through which petroleum enters the marine environment are either naturally through seepage (for example, Allen et al., 1970) or via anthropogenic accidents like oil spills (Water, 2011). It is estimated that 600 metric tons of oil enter the ocean each year via natural seeps accounting for 47% of the total petroleum input to the marine environment (Kvenvolden & Cooper, 2003). Here, petroleum is subjected to weathering by physical, chemical and biological processes (Wardlaw et al., 2008) and microbial degradation is the most important degradation process involved (Das & Chandran 2011 and references therein). Unlike marine oil spills, where petroleum enters through the oxygenated water column undergoing powerful breakdown by aerobic respiration (Head et al., 2006), petroleum in natural seeps enters microbial degradation from the anoxic, energetically lower end of the redox cascade. Hence, a different succession of microbial steps is expected in seeps compared to spills. Many studies have focused on the microbial degradation of spilled oil in the oceans' water column (for example, Delvigne & Sweeney 1988; Atlas 1991; Prince et al. 2003; Jiménez et al. 2006; Prince et al. 2013), but relatively few studies investigated the microbial degradation of petroleum in hydrocarbon seeps (for example, Wenger & Isaksen 2002; Wardlaw et al. 2008; Orcutt et al. 2010). Despite the increase in the number of studies on anaerobic degradation of hydrocarbons, there is still a lack of understanding how hydrocarbon-degraders act as a community in the environment and how petroleum is successively degraded under anoxic conditions (Head et al., 2006; Widdel et al., 2010). So far, selective utilization of hydrocarbons has been classically studied in enrichment cultures and isolates (for example, Ehrenreich et al., 2000; Rockne & Chee-Sanford, 2000; Cravo-Laureau et al., 2007; Kniemeyer et al., 2007). However, the use of batch cultures is insufficient to know the fate of petroleum in a

natural ecosystem (Horowitz & Atlas, 1977). Because it is impossible to mimic all environmental determinants in the laboratory, Horowitz and Atlas suggested that the best chance to predict the fate of petroleum in a natural ecosystem is through chemostats, which maintain a constant influx and efflux of nutrients and products, respectively. There are few studies in the literature that are based on continuous flow-through systems to study petroleum hydrocarbon degradation (Bertrand et al., 1986) and oil spill scenarios (Horowitz & Atlas, 1977), but none on petroleum seepage in marine sediments. Investigations of hydrocarbon seeps often capture only snapshots of biogeochemical features (Bauer et al., 1988; Wenger & Isaksen, 2002; Wardlaw et al., 2008; Orcutt et al., 2008) and are unable to follow the evolution of processes related to petroleum seepage through natural sediment. In the present study we developed a sediment-oil-flow-through (SOFT) system, modified from the sediment-flow-through (SLOT) system (Steeb et al., 2014). While the SLOT system simulates a natural methane seep in intact sediment cores, the SOFT system simulates petroleum-seep like condition (Fig. 1). The system enables us to monitor biogeochemical changes in the sediment core during petroleum seepage over time. To our knowledge, this is the first study that uses a continuous sediment-flow-through system to investigate the response of marine surface sediment to a simulated small-scale petroleum seepage.

For our study we collected sediment cores from the Caspian Sea (Fig. 2), which is one of the oldest petroleum-producing regions in the world with enormous oil and gas reserves (Effimoff, 2000). Offshore drilling and land-based activities such as oil refineries, petrochemical plants, pipeline constructions have led to pollution and contamination of the Caspian Sea (Karpinsky, 1992; Dumont, 1995, 1998; Abilov et al., 1999). Moreover, natural hydrocarbon transport from greater depth to soil/sediment surface (e.g. by mud volcanism) is described for the South Caspian Basin (Katz et al., 2000; Akper, 2012). As the Caspian Sea is an enclosed basin, pollutants discharged into it accumulate and are partly trapped, e.g., in surface sediment. However, so far only a few studies have focused on the microbial community and crude oil degradation in sediments from the Caspian Sea (for example, Hassanshahian et al., 2012; Hassanshahian, 2014; Mahmoudi et al., 2014).

The aim of the present study was to investigate the evolution of biogeochemical gradients related to microbial petroleum degradation and the successive consumption of

hydrocarbons in Caspian Sea sediment during simulated seepage. We hypothesize that petroleum seepage through the Caspian Sea sediment will affect the vertical i) zonation of redox processes, ii) distribution of petroleum-degrading microbial communities, and iii) composition of seeping petroleum. We used the SOFT system to identify the above processes as a function of petroleum seepage. This is the Part I of the Caspian Sea SOFT experiment publication, which describes the SOFT methodology and presents detailed datasets on the successive biogeochemical response of the sediment to petroleum seepage and the alteration of the petroleum hydrocarbons. In Part II of the experiment publication (Stagars et al., this issue), a detailed microbial community analysis of the sediment and microbial distribution in response to the petroleum seepage (in the SOFT system) is presented.

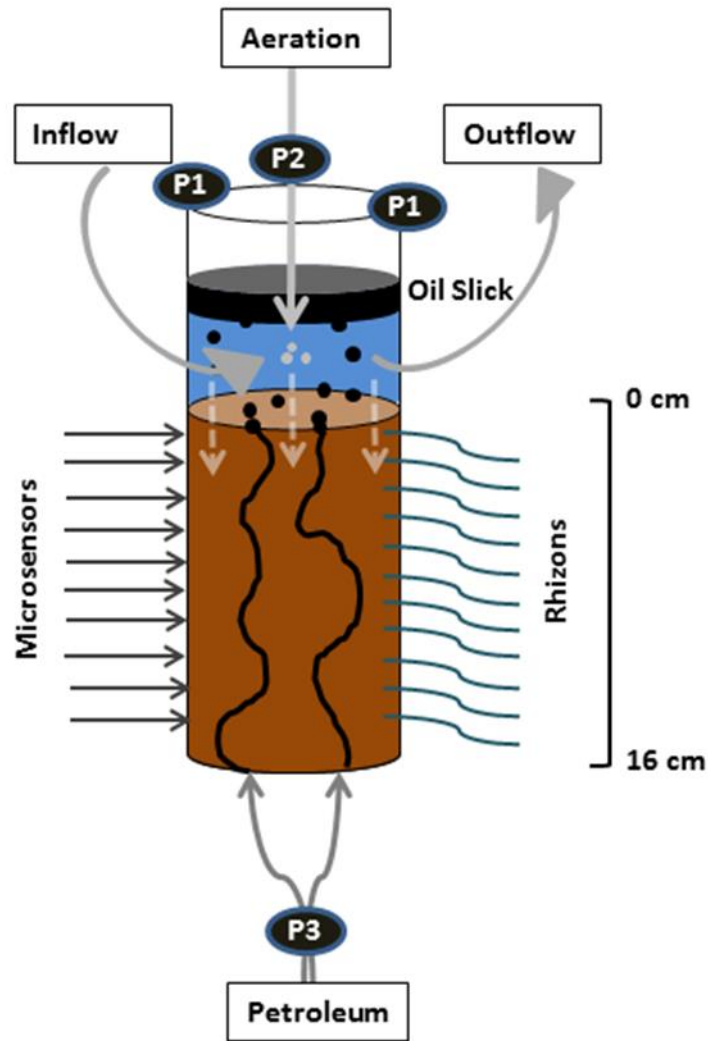

Figure 1. Schematic diagram of the SOFT system simulating a petroleum seep. Artificial seawater was ventilated through the supernatant (P1, pump rate $25\mu\text{L min}^{-1}$) and aerated with an air pump (P2). Petroleum was pumped in by pump (P3) at $3.5\mu\text{L min}^{-1}$ through two integrated channels within the bottom sealing. Vertically aligned rhizons (2.5 mm diameter) were permanently fixed for frequent extraction of porewater. Silicon-sealed holes (4 mm diameter) on the opposite side were used for microsensor measurements. From the oxic supernatant electron acceptors (O_2 , sulfate) entered the sediment by diffusion (dashed white arrows, P4).

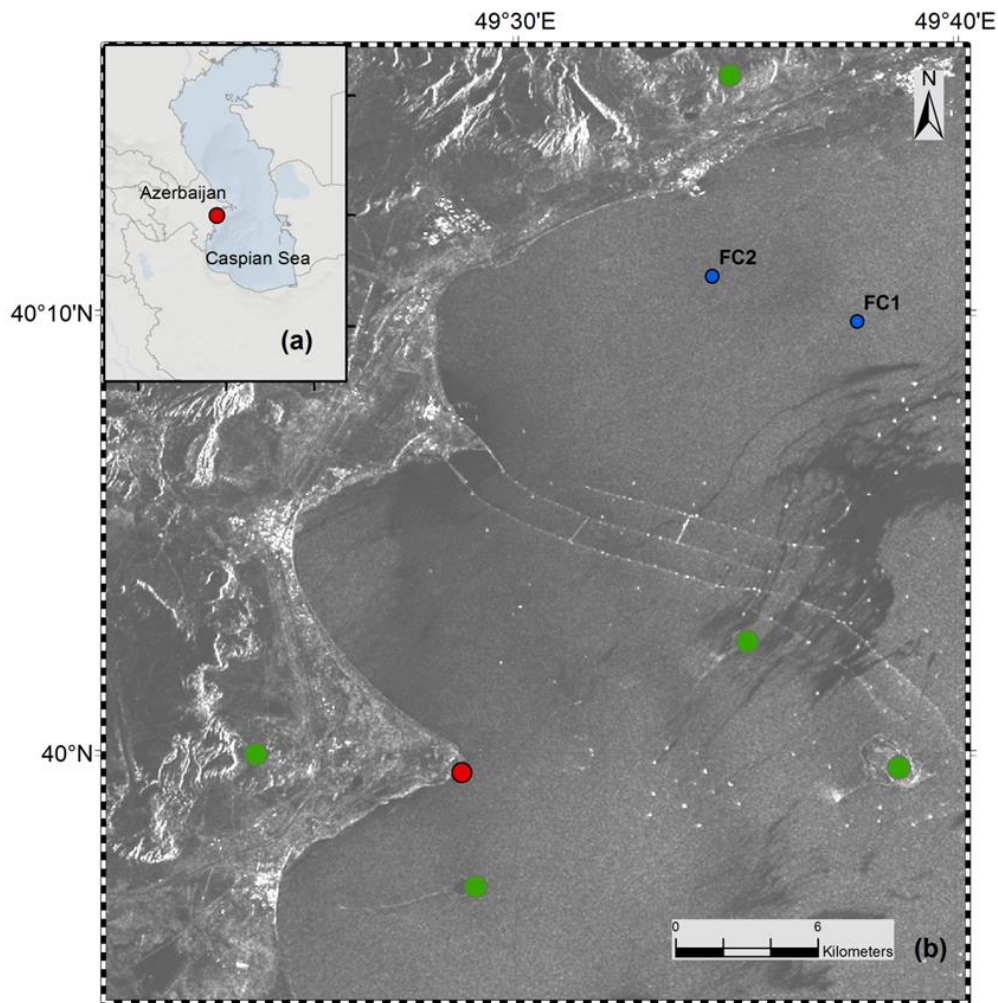

Figure 2. (a) Map of Azerbaijan and Caspian Sea (b) Geographical map showing the push core sampling area (red dot). Characteristic features like on- and offshore mud volcanos (green dots), abandoned offshore wells and infrastructures (white spots and lines in the image), and a central oil slick area (dark grey area in the image) are indicated. FC1 and FC2 are nearby sites where geochemical analyses were done by (Jost, 2014). Map was produced by using ArcGIS 10.2, and is based on a regional SAR image taken in 2004 by ENVISAT (European Space Agency, ESA).

Results and discussion

Migration of petroleum through the sediment core and changes of sediment properties

Sediment cores between 16 and 18 cm long were collected from a coastal site of the Caspian Sea at around 60 cm water depth (sampling spot ~1x1 m). The cores were sandy with a porosity of 0.4 throughout their length. They had an overall greyish/brown color and were covered by a black sulfidic surface layer (ca. 0.5 -1 cm). Sea-grass like plants were growing at the sediment surface. Determination of sulfate reduction rates showed highest activity in the surface layer (see section *Evolution of redox processes in response to petroleum seepage*). Enhanced benthic rates of sulfate reduction and sulfide production are frequently found associated with the presence of sea grass, as the protruding plants serves as a trap for organic matter (Holmer & Nielsen, 1997; Holmer et al., 2003).

One of the collected sediment cores was subjected to simulated petroleum seepage using the SOFT system. Light crude oil from the North Sea/Mittelplate (provided by DEA Deutsche Erdoel AG) was used as the petroleum source. Petroleum was introduced from the bottom of the core at intervals of two to three days at a flowrate of 3.5 μL per minute. Over time, the core turned more and more into a blackish color due to the distribution of petroleum and the extension of sulfidic conditions. Within 1-2 days after the start of the flow, oil slicks formed at the surface of the overlying seawater from oil that had passed the sediment core. Petroleum droplets visibly seeped out of the sediment close to the core liner wall. High fluid flow through sediment cores can induce channelizing effects between the wall of the core liner and the sediment core, causing some fluid to move faster than the bulk volume (Steeb et al., 2014, 2015). Upon termination and slicing of the SOFT core we observed that although most of the petroleum seemed to be evenly distributed throughout the sediment, some petroleum accumulated in vein-like structures indicating such channelizing effects (Appendix 1). The actual migration of the bulk petroleum was indicated by the difference in the vertical distribution of organic carbon (C_{org}) between the initial (replicate) and the final SOFT core (Fig. 3). Petroleum hydrocarbons represent a form of organic enrichment of marine sediments (Bauer et al., 1988). Hence, an enrichment of C_{org} in the SOFT core can be interpreted as the introduction of petroleum by seepage. While a relatively low

amount of C_{org} (0.2 to 0.5 %) was found throughout the initial core, C_{org} increased with increasing sediment depth in the SOFT core (from 1 to 11.2 %, Fig. 3), marking the movement of the petroleum in the core. In accordance with the increase in C_{org} , the C/N ratio of the sediment drastically increased with depth as compared to the initial core (from 7 to 9 in the initial core to 30 to 235 in the final core, Fig. 3). Beside the variable C/N ratio of organic precursors (terrestrial or marine) the C/N ratio of petroleum (~170) is highly enriched compared to kerogen (~40) during catagenesis (e.g. Hunt, 1979). A similar observation was made in sediment cores from an active hydrocarbon seep zone in the Coal Oil Point Field (water depth 22m, Santa Barbara Channel, California) where the C/N ratio increased with increasing oil content (LaMontagne et al., 2004). While most organic-rich sediments receive their organic matter input from the water column, seep sediments are mostly supplied from the subsurface through the upward flux of petroleum hydrocarbons (Reed & Kaplan, 1977; Bauer et al., 1988). As a result, some features are unique to petroleum seeps like the increase of organic carbon with sediment depth (Bauer et al., 1988). Sediment porosity in the present study decreased from values of about 0.4 in the initial core to a lowest value of 0.2 in the final SOFT core at its deepest layer (15 cm, Fig. 3). Over the entire SOFT core, porosity decreased from 0.4 at the surface to 0.2 at the deepest layer (Fig. 3C). The decrease in porosity in the SOFT core indicates that pore spaces in the sediment were partly filled with petroleum, which could not be removed during the freeze-drying process of the analytical procedure for porosity determination. We assume that the pore volume of the deepest layer was probably 100% saturated with petroleum due to constant supply of petroleum from below. A porosity of 0.2 would, however, indicate that probably the more volatile fractions of the petroleum were lost during the freeze-drying process. Reduction in pore space imposes mechanical constraints on habitability of bacterial cells in sediments (Rebata-Landa & Santamarina 2006 and references therein). Total cell counts by DAPI staining in the SOFT core revealed a decrease in cell numbers up to one-fourth below 6 cm depth and an increase in the upper half above 6 cm by a factor between 1.1 and 2.6 compared to the initial core (Fig. 4). It should be noted that due to lack of overlapping of a few sampling depths between the initial and SOFT core (see Fig. 4), linear interpolation was used to estimate the missing of cell numbers in adjacent depths for better comparison. The reduction in total cell number in the deeper part of the SOFT core could be the result of a decrease in available habitable pore space that was

occupied by petroleum or toxicity of petroleum itself. Consequently, such mechanical constraints could limit microbial activity in a seep system, despite the presence of a rich organic food source.

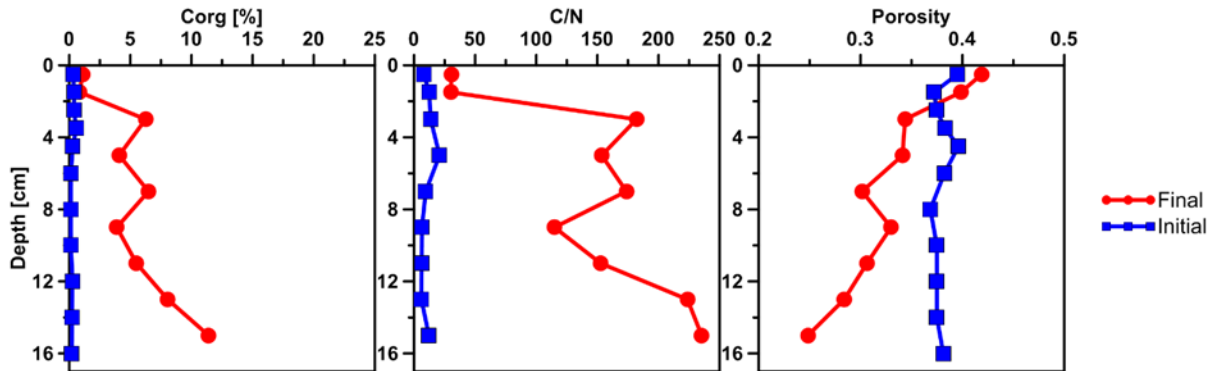

Figure 3. Vertical profiles of sediment parameters determined in the initial Caspian Sea core (blue) and the SOFT core after 190 days (red, final). Left: organic carbon (Corg %). Middle: C/N ratio, Right: Porosity.

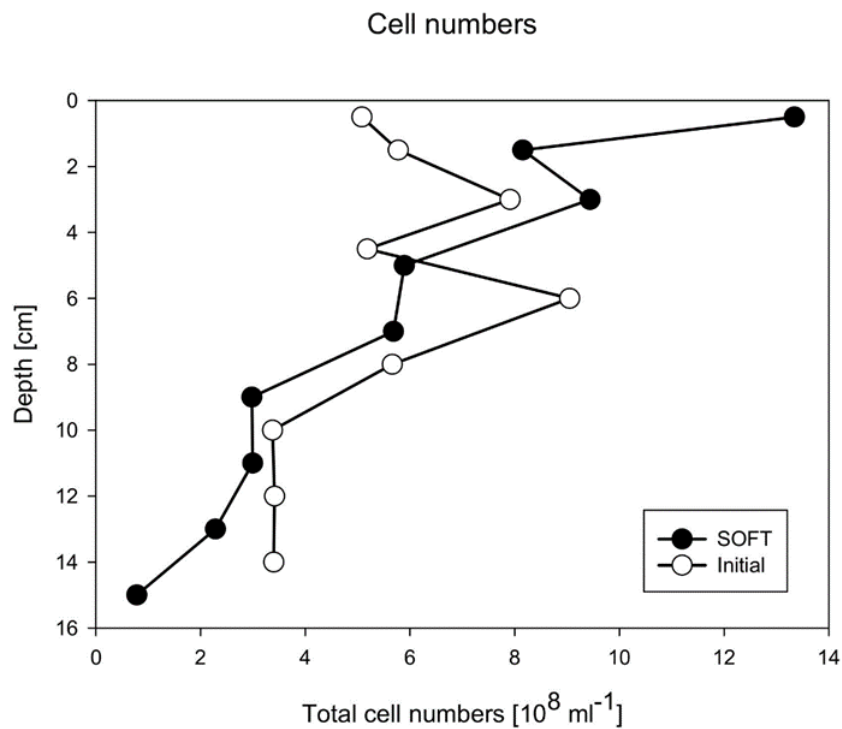

Figure 4. Total cell numbers as detected by DAPI staining in the initial core and the final SOFT core.

Evolution of redox processes in response to petroleum seepage

Concentrations of dissolved electron acceptors (like oxygen and sulfate) and corresponding reduced products (like sulfide) in the porewater of the SOFT core indicated a vertical zonation of redox processes (Fig. 5 and 6). The zonation was in line with the natural redox ladder found in marine sediments (Jorgensen, 2006): we observed the transition from oxic to anoxic conditions, and within the anoxic sediment a separation into a top sulfate reduction and a bottom methanogenic zone. The identification of a denitrification zone was not possible, as the determination of nitrate in the porewater by ion chromatography was interfered by the presence of oil. However, none of the known nitrate-reducing hydrocarbon degraders have been detected by Stagars et al. (this issue). In the following we will discuss the temporal evolution of the oxic and anoxic zone.

Oxic zone

Thermodynamically, oxygen is the most favored electron donor in marine sediments (Glud, 2008) and the penetration depth of oxygen controls the depth distribution of other redox processes (Cai & Sayles, 1996). Microprofiles of oxygen concentration were taken during the SOFT experiment (Fig. 4). We have no oxygen data from the initial condition because the sediment cores were sealed and stored for 3 months before the start of the experiment and we therefore assume that oxygen was completely consumed in the core liners. The total oxygen uptake (TOU) of sediment is a measure for organic carbon mineralization, as it sums up aerobic respiration as well as the oxidation of reduced chemical species produced during anaerobic respiration (Canfield et al., 1993; Glud, 2008). The diffusive oxygen uptake (DOU) represents the part of TOU that is dominantly mediated by microbial respiration at the seafloor and can be calculated from microsensor profiles (Glud, 2008; Boetius & Wenzhöfer, 2013). Oxygen penetration depth and the DOU for the SOFT core were calculated from the microsensor profiles according to (Glud et al., 1994). The penetration depth almost linearly decreased from ca. 3.8 mm on day 44 to only 2 mm after 190 days, i.e., the end of the experiment (Fig. 5). Simultaneously, the DOU increased from 3.8 mmol m⁻² d⁻¹ on day 44 to 8.6 mmol m⁻² d⁻¹ on day 190 (Fig. 5). Thinning of the oxygen penetration layer indicates an increase in oxygen demand most likely as a result of microbial petroleum degradation, similar to the effect organic enrichment through pelagic carbon export has on DOU and oxygen

penetration depth in sediments (Glud 1994). Likewise, sediments from cold seeps are reported to have elevated DOU rates up to two orders of magnitudes higher compared to non-seep sediments (Boetius & Wenzhöfer, 2013).

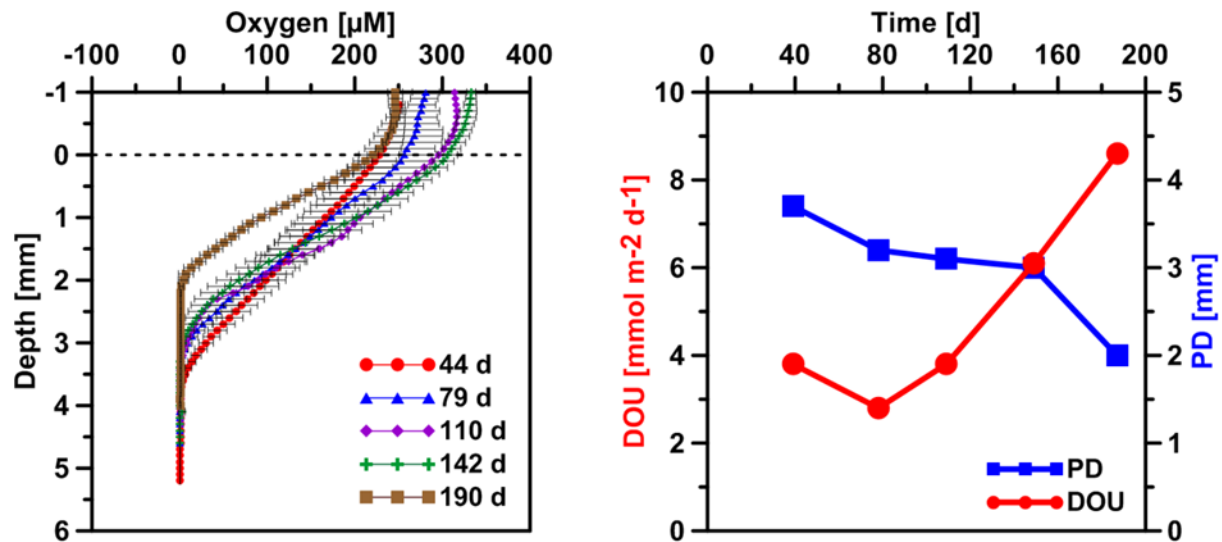

Figure 5. Left: Temporal development of sediment microprofiles of oxygen after the start of the SOFT experiment. Values are mean of three separate vertical profiles but with different horizontal positions (\pm SD, $n=3$). The dashed horizontal line represents the sediment-water interface. Right: Temporal development of the oxygen penetration depth (PD) and the diffusive oxygen uptake (DOU).

Anoxic zone

Total sulfide and sulfate concentrations steadily increased and decreased, respectively, in the sediment porewater (Fig. 6), pointing to the stimulation of sulfate-reducing bacteria (SRB). Over time, the sulfate reduction zone moved upwards, reaching its strongest development between 0 to 8 cm at the end of the incubation (190 days). At this point, sulfate penetration was limited to 8 cm (starting off at 16 cm at the beginning of the experiment). While the highest individual sulfate reduction rates were detected in both in the initial ($98.1 \text{ nmol cm}^{-3} \text{ d}^{-1}$, 0-1 cm) and the final SOFT core ($91 \text{ nmol cm}^{-3} \text{ d}^{-1}$, 2-4 cm) (Fig. 6), sulfate reduction integrated over 0-16 cm doubled from $2.8 \text{ mmol SO}_4^{2-} \text{ m}^{-2} \text{ day}^{-1}$ before (initial core) to $5.7 \text{ mmol SO}_4^{2-} \text{ m}^{-2} \text{ day}^{-1}$ after petroleum seepage (SOFT core). Marine hydrocarbon seep sediments are known to facilitate high sulfate reduction activity compared to non-seep sediments (Joye et al., 2004; Orcutt et al., 2010). An

overview of sulfate reduction rates at selected hydrocarbon seep sites from the Gulf of Mexico is provided in Table 1. Here, sulfate reduction reached some of the highest activity reported for marine sediments (244.3 mmol SO₄²⁻ m⁻² day⁻¹ (Joye et al., 2004), which was found to be coupled mainly to hydrocarbons degradation rather than to "normal" organic matter degradation or to the anaerobic oxidation of methane (Joye et al., 2004; Orcutt et al., 2010). In the present study from the Caspian Sea, enhanced sulfate reduction after petroleum seepage likewise pointed to the utilization of petroleum compounds by SRB (see also the following section). Stagers et al. (this issue) discovered a high diversity of SRB in the initial core, whose relative sequence abundance increased in the SOFT core after petroleum seepage. Cell numbers of hydrocarbon-degrading SRB like *Desulfobacula* and clade LCA2 increased in the sulfate-reducing zone of the SOFT core compared to the initial core. The distribution of the petroleum-degrading SRB and the increase in relative cell numbers of some petroleum-degrading groups together with elevated sulfate reduction activity in the SOFT core identifies sulfate reduction as an important process in the anaerobic degradation of petroleum in Caspian Sea sediments. Below the sulfate reduction zone (0-8), i.e., below the penetration of sulfate, methane production was observed in the final SOFT core indicating the presence of a methanogenic zone. Methanogenesis will be discussed in more detail in the following sections.

Table. 1. Comparison of integrated sulfate reduction rates at hydrocarbon seep sites with sediments used in this study.

Study site	Integrated depth (cm)	SRR (mmol m⁻² day⁻¹)	Reference
Caspian SOFT	0-15	5.7	Current study
Caspian Initial	0-15	2.8	Current study
Gulf of Mexico	0-10	5.6-27.9	(Orcutt et al., 2010)
Gulf of Mexico	0-10	10.1	(Orcutt et al., 2010)
Gulf of Mexico	0-10	30	(Orcutt et al., 2005)
Gulf of Mexico	0-13.5	244.3	(Joye et al., 2004)

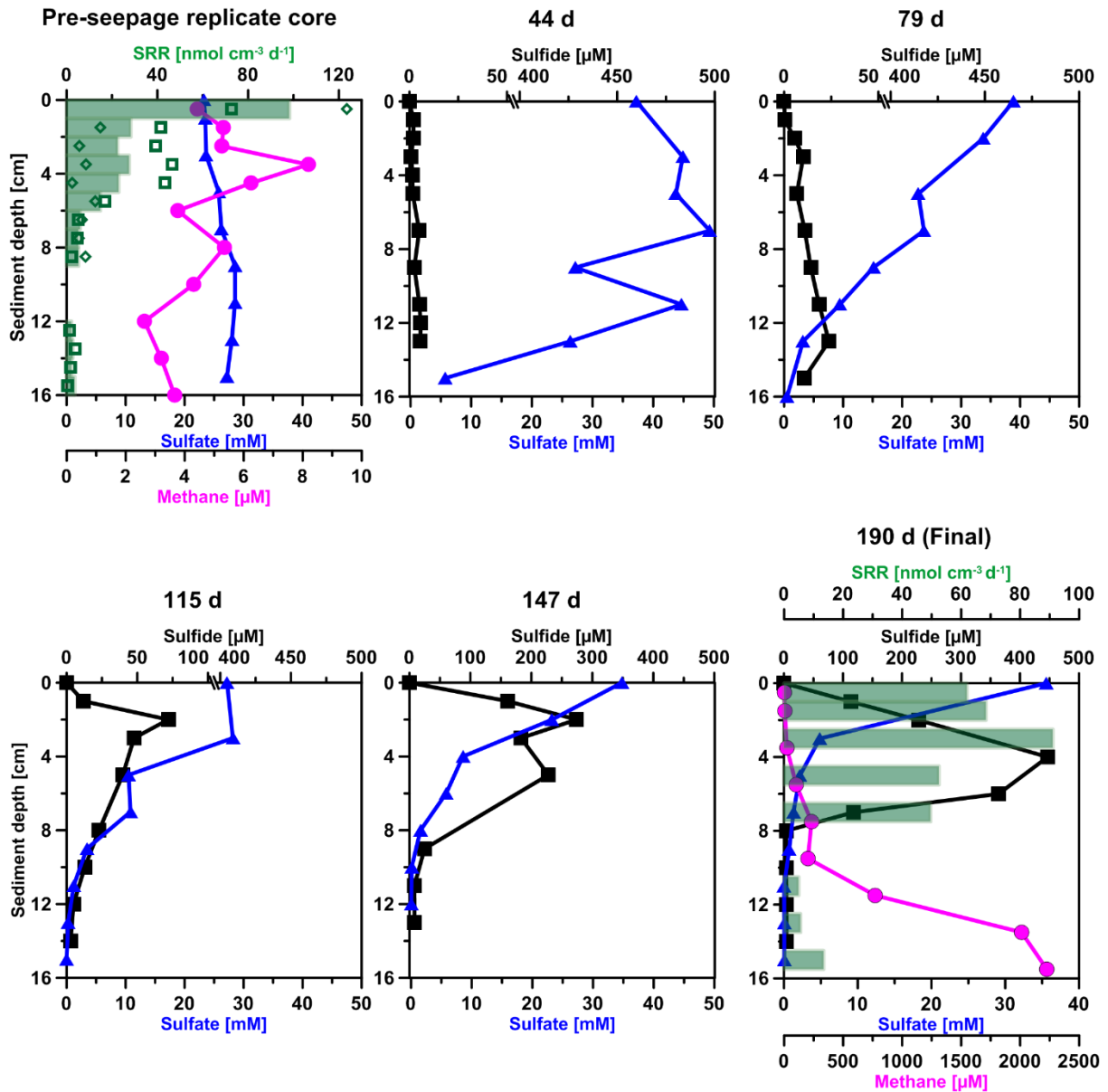

Figure 6. Temporal development of biogeochemical profiles in the Caspian Sea sediment core used in the SOFT system over the course of the experiment. Sulfate (blue line with triangles), total sulfide (black line with squares), sulfate reduction rates (SRR, green bars) and methane (pink line with circles). Sulfide data were corrected for the shift in the electronic signal of the microsensors (between 0.5 to 1.5 mV). Initial conditions were measured in a replicate core before the start of the SOFT system. SRR bars in the initial plot represent the average of two replicates, while single values of the SRR replicates are shown as empty black squares and diamonds. In the final core (190 d) only one SRR replicate is shown. The sample at depth 9 cm was lost during the radiotracer injection. Please consider the change of scale in some of the x-axes.

Vertical alteration of n-alkanes and correlation to biogeochemical processes

Petroleum consists of four main groups: the saturated and aromatic hydrocarbons and the non hydrocarbon part resins and asphaltenes (Head et al., 2006). The saturated hydrocarbons comprise normal and branched alkanes and cycloalkanes; the aromatic hydrocarbons comprise pure aromatics, cycloaromatic, and cyclic sulfur compounds; resins and asphaltenes are high molecular weight compounds comprising N, S and O atoms (Tissot & Welte, 1984). Saturated hydrocarbons and aromatics are more easily degraded by microbial activity unlike the resins and asphaltenes, which are resistant to biodegradation (Head et al., 2006). Since saturated hydrocarbons form the largest part of the biodegradable petroleum, our study focuses on the degradation of n-alkanes. The volatile fraction (headspace gas) of the n-alkanes (C1 to C6) appeared to be consumed during the upward migration of the petroleum, as it completely disappeared in the upper 4 cm of the SOFT core (Fig. 7). Since the top 8 cm of the core was the zone with the highest sulfate reduction activity (Fig. 6), we postulate that sulfate reducers were mainly responsible for the degradation of these volatile short-chain n-alkanes. The degradation of n-alkanes via sulfate reduction is supported by the increase of alkane-degrading SRB cell numbers in the SOFT core after petroleum-flow-through (Stagars et al. this issue). Anaerobic oxidation of short-chain alkanes by SRB has been reported in marine hydrocarbon seep areas of the Gulf of Mexico and the Guayamas basin (Kniemeyer et al., 2007; Kleindienst et al., 2014). The presence of alkane-degrading SRB and degradation of C1 to C6 n-alkanes in the sulfate-reducing zone (0 to 8 cm) also indicate that the short-chain alkanes were mainly degraded after they had passed through the methanogenic zone below (8 to 16 cm) (Fig. 7). Methanogenic petroleum degradation mainly utilizes long-chain n-alkanes (Zengler et al., 1999; Anderson & Lovley, 2000). When offered C6 to C10 n-alkanes (Siddique et al., 2006), methanogens preferedly degraded n-alkanes in the sequence C10>C9>C8>C7>C6. The preferential degradation of longer over shorter chain n-alkanes by methanogens might explain, why in our SOFT core the C1 to C6 n-alkane degradation was observed only within the sulfate-reducing zone (Fig. 7). The largest absolute amount of higher n-alkanes (C10 to C40) was found in the deeper sediment layers, probably as the petroleum was introduced from the bottom (Fig. 8), from where concentrations of some n-alkanes decreased along with the upward migration. The relative decrease in the concentrations

of each n-alkane was calculated by normalizing against their corresponding concentration at 15 cm depth by formula (1)

$$[n-C_{x \text{ cm}} / n-C_{15 \text{ cm}}] \times 100 \quad (1)$$

where “n-C_{x cm}” and “n-C_{15 cm}” are the concentrations of an n-alkanes at a certain depth and at 15 cm depth, respectively. A successive relative decrease in all n-alkanes towards the surface was observed (Fig. 8). For example, concentrations of lower n-alkanes like C10 and C12 n-alkanes decreased by around 100% and 70%, respectively, from 15 cm to 7 cm sediment depth. In comparison, the concentration of C14 to C26 n-alkanes decreased only by around 50%. The decrease in n-alkanes over decreasing depth indicates successive degradation but could also represent partly unfinished (non-steady) vertical migration of petroleum. To check if there was a change within the petroleum composition, contributions of individual n-alkanes to the total measured n-alkanes are shown as pie charts (Fig. 9). The contribution of lower n-alkanes (C10 to C14) to the total alkane at 1.5 cm content decreased by around 50% compared to their contribution at 15 cm (~16% at 15 cm and ~8 % at 1.5 cm) indicating preferential degradation of the lower n-alkanes during the ascent of the oil (Fig. 9). The preferential degradation of lower n-alkanes compared to higher n-alkanes in the petroleum composition confirms that successive decrease in n-alkanes with decreasing sediment depth was not just a result of uneven or unfinished migration of petroleum in the core. Vertical succession of n-alkanes was likewise found in an oil-seep core (2 m length) collected off the coast of West Africa targeting the surface expression of a fault (Wenger & Isaksen 2002). Thermogenic oil and gas (C1 to C5 iso- and n-alkanes) were found throughout the core, but were essentially unaltered in the deepest layer (2 m below seafloor), while the shallower depths (from 1m up to the seafloor) showed a progressive upward degradation. A similar trend was found in oil samples from Coal Oil Point seeps (Santa Barbara, California), where n-alkanes had been decreased by 100% in the oil seeping from the seafloor compared to the deeper reservoir oil (Wardlaw et al., 2008). The authors identified biodegradation as the main cause for the loss of n-alkanes. In the same study, it was found that physical processes like evaporation and dissolution had no significant effect on the loss of n-alkanes between the reservoir oil and the seafloor oil. Based on the observations made in the present study, i.e., the evolution of redox profiles, the increase in microbial activity, and the presence of hydrocarbon degraders (Stagars et

al., this issue), we conclude that microbial activity led to the successive degradation of n-alkanes in the Caspian Sea core during the SOFT experiment.

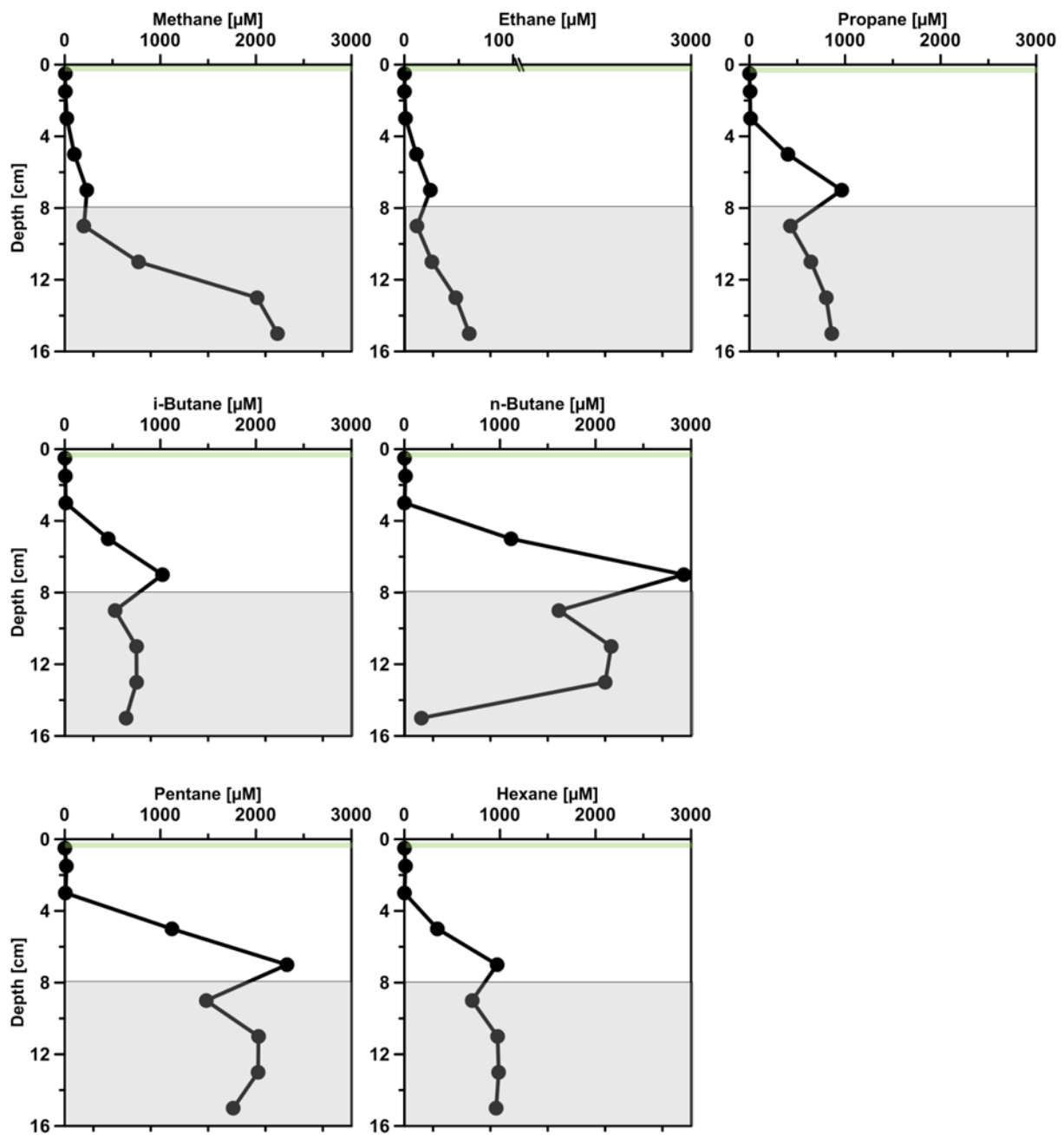

Figure 7. Vertical distribution of volatile n-alkanes (from C1 to C6: Methane, Ethane, Propane, n-Butane, i-Butane, Pentane and Hexane) over depth in the Caspian Sea core at 190 d after the SOFT experiment.). The grey shaded area represents the methanogenic zone of the core, the non-shaded area represents the sulfate reduction zone, and the green shaded area represents the oxic zone in the SOFT core at 190 d.

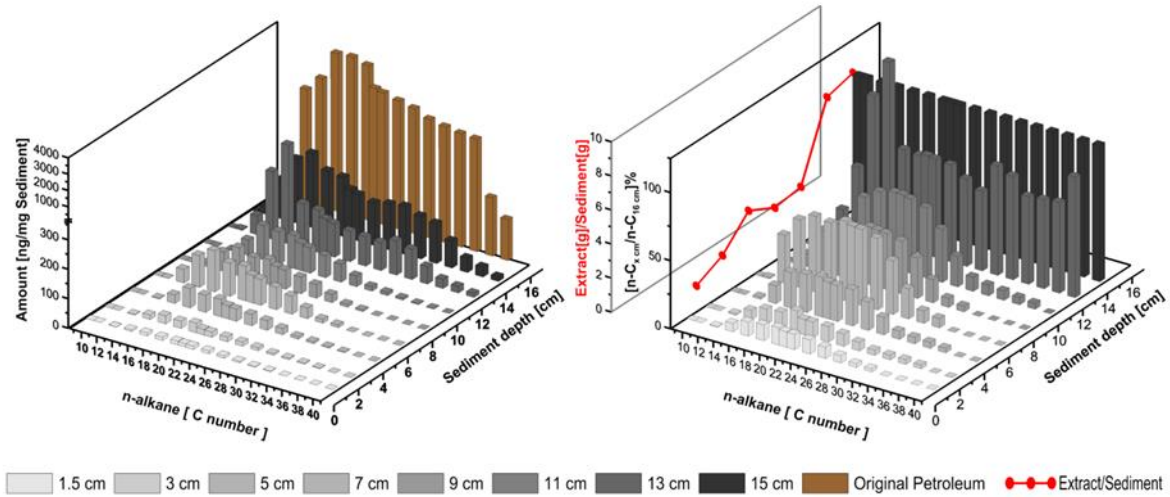

Figure 8. A) Vertical distribution of higher hydrocarbons (n-alkanes C10 to C40) in the Caspian Sea core after the SOFT experiment. Surface sediment (0-1 cm) is excluded, due to possible influence from the overlaying oil slick that settled on the sediment during slicing of the core (see text) B) Relative decrease in the concentration of n-alkanes over depth. The relative concentrations are normalized against the deepest layer (15 cm). The red line shows the ratio of the weight of petroleum extract at each depth to the respective sediment weight and represents the movement of petroleum in the SOFT core.

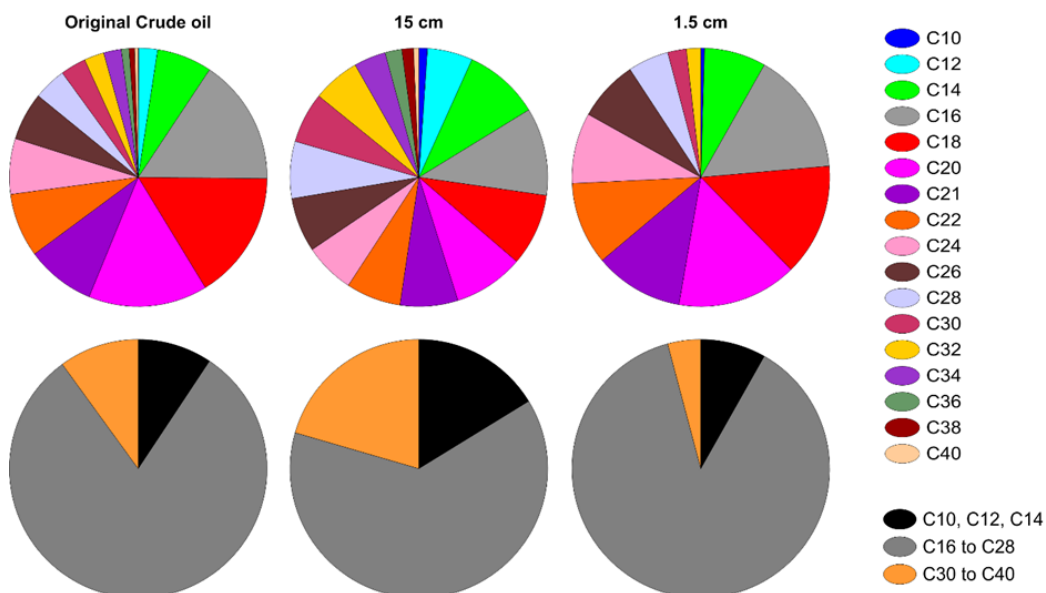

Figure 9. Percentage of individual n-alkanes with respect to total n-alkanes measured. Left: Original crude oil used for the SOFT experiment. Middle: n-alkane composition at 15 cm depth of the SOFT core (deepest layer) Right: n-alkane composition at 1.5 cm depth of the SOFT core (close to surface).

Methanogenic petroleum degradation in the SOFT sediment

After the SOFT experiment, a methanogenic zone was evident below the sulfate-reducing zone (below 8 cm) as indicated by methane concentration and carbon isotopic ratios (Fig. 10). Porewater concentrations of methane increased from around 3 μM in the initial core up to around 2300 μM in the SOFT core in the methanogenic zone. Isotope analysis revealed a decrease in the $\delta^{13}\text{C}$ signal of methane in the SOFT core (after petroleum seepage) compared to the initial core (Fig. 10). At 8 and 10 cm depth, the $\delta^{13}\text{C}$ signal of methane decreased from -33.7‰ and -36.7‰ to -49.5‰ and -43.6‰ respectively. Cell numbers of methanogenic archaea also increased after petroleum seepage in the methanogenic zone (Stagars et al, this issue) and *Methanosarcina* spp was found to be the most dominant archaeal species. The decrease in the $\delta^{13}\text{C}$ signal in the SOFT core compared to the initial core indicated a shift from a more thermogenic towards a more biogenic source of methane after the petroleum seepage (see Whiticar, 1999). The original petroleum had less than 1% methane (according to DEA Deutsche Erdoel AG). Gas chromatographic headspace analyses of original petroleum gave a concentration of 82.8 $\mu\text{mol/ml}$ petroleum (Appendix 2) and a ^{13}C signal of -40.3 ‰ for methane. Therefore, with respect to $\delta^{13}\text{C}$ signal of methane in both the initial sediment core and the petroleum, a decrease in the ^{13}C signal of methane over time indicates microbial methane production in the SOFT core. In another study in the South Caspian Sea basin, methanogenesis was postulated for sediment cores (20 to 30 cm long, FC1 and FC2 in Fig. 2; Jost, 2014) collected at a “non-seep” offshore site located nearby our sampling site. In FC-sediment cores, methane concentrations increased with depth and showed a typical biogenic signature of -65.5 ‰ indicating organic matter degradation by methanogenic archaea. Their study concluded that methanogenesis is an important process involved in the anaerobic degradation of organic matter in Caspian Sea surface sediments. In our study, the $\delta^{13}\text{C}$ methane data of the initial sediment core ranged between -33.7‰ and -36.7‰ indicating a contribution of thermogenic methane possibly from the nearby mud volcano complex (Fig. 2). After 190 days of simulated

petroleum seepage, a shift towards biogenic methane (-49.5‰ and -43.6‰; Fig. 10) was indicated in the SOFT core. It can be speculated that over longer seepage time, the $\delta^{13}\text{C}$ signal could have either been further shifted towards a pure biogenic signal or maintained a steady state of around -50 ‰ due to the constant inflow of fresh thermogenic petroleum (including thermogenic methane) and the partial microbial degradation/conversion of the petroleum to biogenic methane.

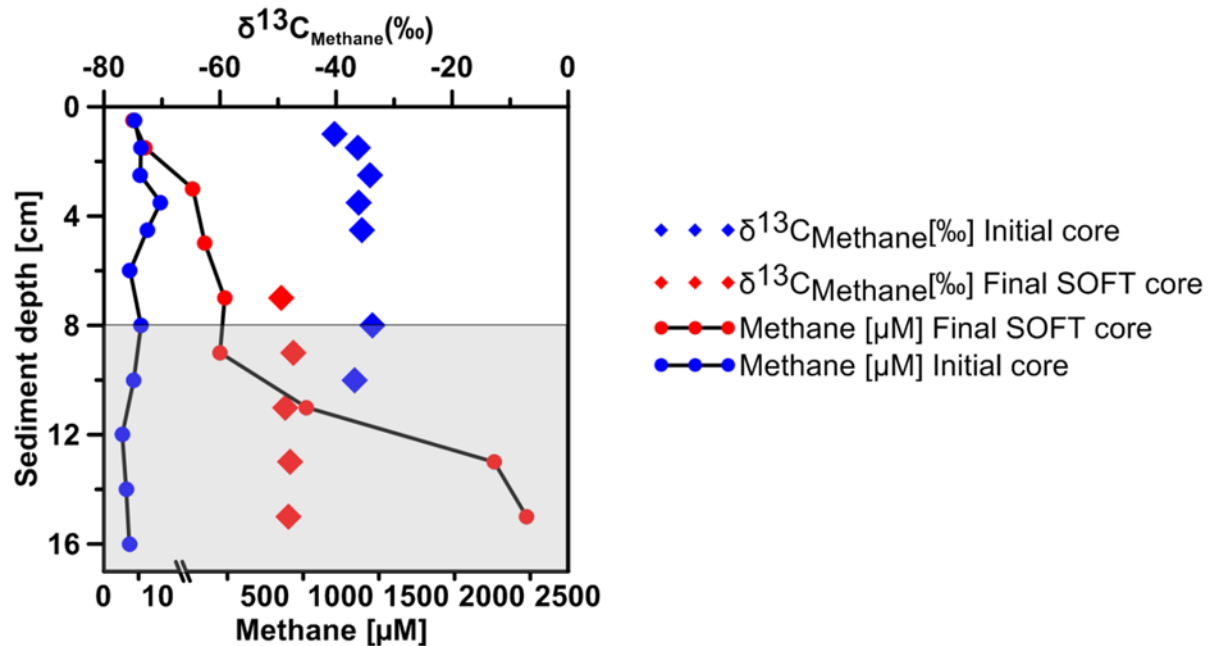

Figure 10. $\delta^{13}\text{C}$ of methane and methane concentration in two replicate Caspian Sea cores before (initial) and after the SOFT experiment (190 days, Final). The shaded area represents the methanogenic zone of the core and the non-shaded area represents the sulfate reduction zone. Some $\delta^{13}\text{C}$ values are missing for some depths because the methane concentrations were too low for analyses.

As the amount of C_{org} was rather low in the initial sediment core and increased only after petroleum addition (Fig. 3), we argue that the observed methanogenesis can be attributed to petroleum degradation. In order to test this hypothesis, sediment samples of the SOFT core from both the sulfate-reducing zone (0 to 8 cm) and the methanogenic zone (8 to 16 cm) were enriched in sulfate-free medium with selected petroleum hydrocarbons (hexadecane, methyl-naphthalene, toluene and ethylbenzene). Methane production was monitored over time and methanogenesis rates were calculated by linear regression (Fig. 11, Table 2). The highest methanogenesis rates were observed in treatments with hexadecane (16.08 and 13.8 $\text{nmol d}^{-1} \text{ml}^{-1} \text{sediment}$) and methyl-naphthalene (12.8 and 10.3 $\text{nmol d}^{-1} \text{ml}^{-1} \text{sediment}$) in both the sulfate reducing

and methanogenic zone, respectively (Table 2). The positive response to petroleum treatment and elevated methanogenesis rates compared to the controls support that the methanogenesis observed in the SOFT core was related to the biodegradation of petroleum. It should be noted that unlike in the SOFT core, methane production was observed (and highest) in the enrichment cultures from the sulfate-reducing zone, suggesting that the SRB outcompeted methanogens during the SOFT experiment (Fig. 6). Several previous laboratory studies with batch cultures demonstrated methane production when offering hexadecane or petroleum indicating methanogenic degradation of these compounds (Zengler et al., 1999; Anderson & Lovley, 2000; Jones et al., 2008; Sherry et al., 2014). The SOFT system revealed, to the best of our knowledge, for the first study methanogenic activity related to petroleum degradation under close natural conditions.

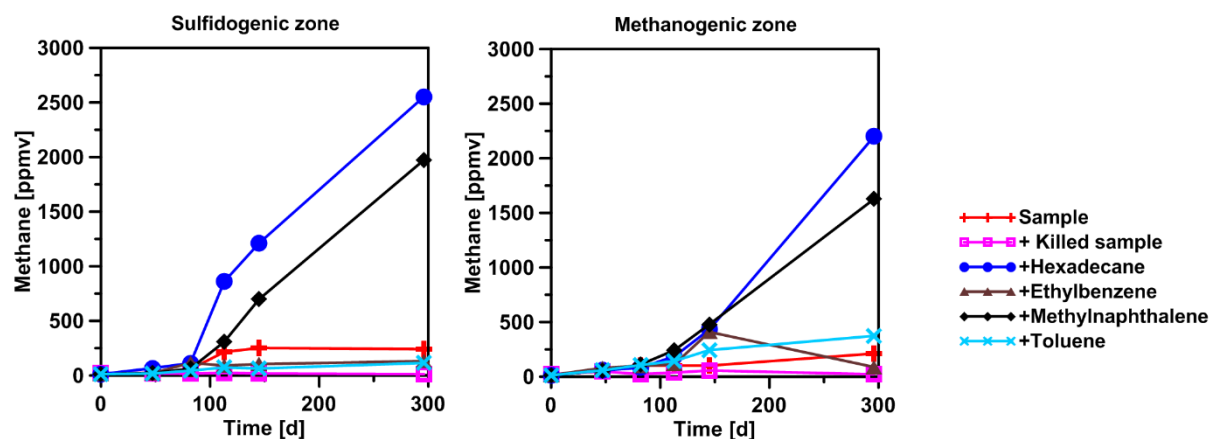

Figure 11. Methane production in enrichment cultures in sediment samples from the methanogenic and sulfate-reducing zone.

Table 2. Rates of methanogenesis in enrichment cultures with sediment samples from SOFT core.

Zone	Treatment	Methanogenesis rate (nmol d ⁻¹ ml ⁻¹ Sediment)
Sulfate reducing zone	Only sample	1.6
	Killed sample	0.0
	+ Hexadecane	16.7
	+ Ethylbenzene	0.7
	+ Methylnaphthalene	12.8

	+ Toluene	0.6
Methanogenic zone	Only sample	1.1
	Killed sample	0.0
	+ Hexadecane	13.8
	+ Ethylbenzene	0.6
	+ Methyl-naphthalene	10.3
	+ Toluene	2.3

Conclusion

The present study demonstrated the functionality of a new sediment-oil-flow-through (SOFT) system that simulates a small-scale petroleum seepage through intact sediment cores and facilitates comprehensive monitoring of biogeochemical parameters. We showed in the example of Caspian Sea sediments that microbial degradation of seeping petroleum affects the temporal and spatial distribution of redox processes and alters the composition of petroleum. After passing the sediment, petroleum was found to be depleted in short chain n-alkanes. Volatile n-alkanes were completely consumed during the ascent of the petroleum and lower chain n-alkanes (up to C14) were preferentially degraded over the higher n-alkanes. Methanogenesis and sulfate reduction were identified as important processes involved in anaerobic degradation of petroleum in the selected sediments. Carbon isotopic analyses of methane (which probably represented a mixture of ascending thermogenic and in-situ produced biogenic methane) following petroleum seepage suggest that a high methane concentration combined with $\delta^{13}\text{C}$ signals in the range of -50 ‰ in surface sediments could be an indication for underlying active seepage undergoing methanogenic petroleum degradation.

Experimental Procedures

Setup of the SOFT system

A sediment-oil-flow-through-System (SOFT System) was developed to simulate petroleum seepage in intact sediment cores by pumping petroleum from the bottom and providing diffusive supply of electron acceptors via oxic artificial seawater from above (Fig. 1). The SOFT system was modified after the sediment-flow-through (SLOT) system established by (Steeb et al., 2014), which simulates methane seepage (see Appendix 4 for a detailed comparison). An intact sediment core was collected with a gas-tight polycarbonate core liner (Appendix 2 and 4). The core liner had 3 vertical lines of 21 sampling holes each (diameter 4 mm, distance between two holes 5.8 mm). The holes were sealed with residue-free silicon (Aquasil, Probau). The top cap of the core was equipped with 3 openings (diameter ~3.5 mm) to feed through tubing (Iso-versinic, LLG; inner diameter 1 mm and outer diameter 3 mm) from an air pump, from a seawater reservoir (inflowing seawater), and to a wastewater reservoir (outflowing seawater). Aeration by air pump in the supernatant water was applied to facilitate a natural redox zonation (from oxic to anoxic) in the sediment core. Care was taken that the air flow was not too strong to avoid disturbance of the sediment surface layer. The upper end of the core liner was covered by a semi open PVC cap (Appendix 2), wrapped with permeable laboratory film (Parafilm, Pechiney Plastic Packaging), to allow gas exchange with atmosphere. The bottom part of the core was kept anoxic by sealing the end of the core liner with a rubber stopper (Appendix 2). Two metal tubes cut from biopsy needle holder (O-MAX T Knochenmark-Biospie-Set; outer diameter 3mm, inner diameter 1.9 mm) were integrated in the rubber stopper as crude-oil inlets. All tubing connections (sediment core, crude oil reservoir, seawater reservoir, collection bottle and air pump) were established with gas tight and autoclaveable Iso-versenic tubes (LLG), polypropylene tube connectors and fast couplers. Crude oil was pumped into the sediment core at $\sim 3.5 \mu\text{l min}^{-1}$ with peristaltic pumps (Medorex, TL/10E, min/max pump volume $0.1 \mu\text{L min}^{-1}/400 \mu\text{l min}^{-1}$) using Santropen tubes (Medorex; autoclaveable, highflexible, very resistant against corrosive media; inner diameter 0.5 mm, outer diameter 1.6 mm). Petroleum pumping was switched on and off at frequent intervals (two to three days of no-flow vs. two to three days of oil-flow) to imitate natural variability of petroleum migration and to offer organisms sufficient time for

degradation in their microhabitat. A layer of petroleum (oil slick) formed at the water-air interface from the petroleum that seeped out of the sediment core. The oil slick was periodically removed with sterile syringes to avoid overflow. Light and live crude oil (i.e., oil with a low viscosity/specific gravity and containing dissolved gas in solution), originating from the North Sea (Mittelplatte) was provided by Dea Deutsche Erdoel AG (sampled in February 2013). Artificial seawater was supplied to the overlaying seawater through an inlet tube with the help of the peristaltic pumps at a flow rate of 25 $\mu\text{l min}^{-1}$. Simultaneously, an outlet tube was placed at a level higher than the seawater inlet tube, which removed the overlaying seawater at 25 $\mu\text{l min}^{-1}$ to maintain a constant level of overlaying seawater. Cotton plugs were applied to the seawater reservoir to maintain the seawater sterile and oxic. The outlet tube connecting the seawater reservoir with the SOFT liner was integrated into the cotton plug. The seawater reservoir bottle, the cotton plug, and the inlet were autoclaved at 120°C for 65 minutes prior to usage. In order to keep the seawater as natural as possible, no specific nutrients or vitamins were added. Seawater was prepared by mixing 12 g of sea salts (Sigma Aldrich, product number S9883) in 1000 ml of sterile deionized water to achieve a salinity of 12 psu. Additional sulfate was added in the form of magnesium sulfate to obtain the sulfate concentration of the initial core, which was determined to be around 24 mmol L^{-1} . The entire SOFT experiment was carried out in the dark in an incubator at 16°C. The temperature was chosen because it was around the average temperature of Caspian Sea surface water in Baku in November, i.e., during our sampling campaign (<http://seatemperature.info/november/azerbaijan-water-temperature.html>).

Study site and field sampling

In November 2012, three replicate sediment push cores (30 cm long, 6 cm inner diameter) were collected from a coastal area in the Caspian Sea near Baku, Azerbaijan (Fig. 2). The initial cores used for sediment and porewater analyses were 18 cm and 16 cm long, respectively. The core selected for the SOFT experiment was 16 cm long. Additionally, two replicate mini push cores (30 cm long, 2.6 cm inner diameter) were collected for determination of sulfate reduction rates. The mini cores were 16 and 12 cm long. The sampling site was located in the South Caspian Sea basin (N 39 59.548, E 49 28.775). The Caspian Sea is the largest continental water body and the rivers Volga, Kura, and Ural are the three biggest contributors of its inflow and nutrients (Dumont,

1998). It has an area exceeding 390,000 km² with a water volume of around 78,000 km³ (Kosarev, 2005). The salinity of the Caspian Sea is around 12 psu and the relative concentrations of SO₄²⁻ (~31 mM), Ca²⁺ (8~ mM) and Mg²⁺ (~29 mM) are higher than in average seawater due to the inflowing rivers Volga and Kura (Millero & Chetirkin., 1980; concentrations from Peeters et al., 1999). The sampling site was chosen due to presence of natural hydrocarbon seepage structures like off and on shore mud volcanoes (Fig. 2). Petroleum hydrocarbons in the Caspian Sea were first identified through the presence of active oil and gas seeps that are associated with mud volcanoes (Katz et al., 2000). The water depth at the sampling site was around 60 cm. Sediment cores were collected in PVC core liners (see section *Set up of the SOFT system*) by directly walking into the water and pushing the liners into the sediment by hand. The sediment cores were sealed air-free (filled with seawater to the brim) with rubber stoppers. The cores were stored at the Geological Institute of Azerbaijan in the dark at ~10°C until they were shipped to Kiel in February 2013. Upon arrival in Kiel, the sediment cores were kept in a cold room (10°C) and their initial condition measurements were done 10 days later. After the initial measurements were done, the cores were stored at 0°C until the SOFT system (petroleum seepage) was started 2.5 months later. For the initial conditions, two replicate push cores were analyzed to study initial geochemical and molecular parameters, i.e. before the start of SOFT experiment (further details see below), as well as two replicate mini push cores for the determination of sulfate reduction rates.

Microelectrode measurements

One set of sampling holes in the SOFT liner that were sealed with silicon was used for microelectrode measurements. Dissolved total sulfide was measured with a needle H₂S microelectrode (Unisense, Denmark; H₂S-N, tip diameter 0.8 mm). It was inserted horizontally around 3 to 4 cm into the sediment core through the silicon filled liner holes (Steeb et al., 2014). The sensor was calibrated by 6 different concentrations of Na₂S standard solution (0, 100, 200, 500, 1000, 2000 μmol l⁻¹). The standards were prepared with oxygen-free citric acid-phosphate buffer, 10 % v/v TiCl and set to pH 7.5 as this value represented the relatively consistent average pH of the sediment core (data not shown). Hence, it has to be kept in mind that total sulfide data were not corrected for individual pH data points. The calibration standards were stored at 16°C (experimental temperature) overnight to obtain the same temperature as the sediment

core. Cooling packs were used to keep the sediment cores at 16°C (incubation temperature) while measurements were performed at room temperature. After penetration into the core, the sensors were allowed to adapt between 15 to 20 minutes until the signal drift reduced and a value was noted that was at least 90 % of the response signal (Steeb et al., 2014). The microsensor calibration was done prior to measurements using the calibration software offered by Unisense (SensorTrace PRO), which provided signals in millivolt and the corresponding concentration for each data point. The data were corrected for the shift in the electronic signal at the end of the measurement.

Oxygen was measured with miniaturized Clark-type glass microelectrode (Unisense, Denmark; OX-100, tip diameter 100 µm). As the overlaying seawater in the SOFT core was constantly bubbled with air and sealed with Parafilm (Pechiney Plastic Packaging, Menasha) we assumed 100% oxygen saturation. Therefore, a two point calibration was done using the overlaying water as 100% atmospheric oxygen and the lowest signal in the sediment as the zero reading (0% oxygen). Vertical profiling over 5 cm depth was done with a step size of 100 µm measuring period of 3s and waiting period of 15 s. Microsensor measurements were taken periodically (every 30 to 40 days) and were done before porewater sampling to avoid disturbances in the sediment by the porewater extraction.

Porewater sampling in SOFT

Rhizons (Rhizosphere, CSS-F, length 5 cm, diameter 2.5 mm, pore size 0.2 µm) were used to extract porewater from the initial sediment core. For the SOFT core, the rhizons were permanently fixed to one set of the three vertical sampling hole lines in the core liner for the entire duration of the experiment (for technical details see Steeb et al. 2014). Porewater was extracted with rhizons periodically (30 to 40 days) followed by geochemical analyses. Porewater extraction analyses were done at the end of the microsensor analyses (see above). Around 1.5 to 2 ml of porewater was extracted per rhizon. Porewater samples were taken in 2 cm intervals. Considering a sediment porosity of ca. 0.4 and an inner core liner diameter of 6 cm, a cross sampling of porewater with the rhizons can be avoided between two adjacent sampling depths (2 cm in our core) as long as the volume extracted does not exceed 3.6 ml (Seeberg-Elverfeldt et al., 2005). Around 0.05 to 0.1 ml of the porewater was used for immediately

measuring total alkalinity by titration. The rest of the porewater was stored in 2 ml plastic cyro-vials at -20°C, and was later used for analyzing sulfate by ion chromatography. In addition to porewater, seawater was sampled from the seawater reservoir and the overlaying seawater.

Geochemical porewater analyses

Porewater concentrations of sulfate was determined by ion-chromatography. A Metrohm ion-chromatography equipped with a conventional anion-exchange column and carbonate-bicarbonate solution as eluent was used. The IAPSO standard seawater was used for calibration. Sulfate was measured with a conductivity detector (Wallmann et al., 2006).

End of the SOFT experiment and core slicing for sediment analyses

After 190 days, the SOFT experiment was stopped. The bottom cap was removed slowly and the core liner was immediately placed on the extruder (diameter ~5.8 cm). The overlaying seawater was removed from the top with a 60 ml syringe. However, during removal of the supernatant, we observed an oil slick settling on the sediment surface. We therefore consider the 0-1 cm sediment layer to be not representative for some sediment parameters (e.g., n-alkane alteration after seepage in the SOFT incubation) because of the additional petroleum hydrocarbons that might have originated from the overlying oil slick. The sediment core was sliced vertically from top to bottom every 1 (0-3 cm) to 2 cm (3 cm until end of core). Sediment samples were then subsampled for the analyses of C1-C6 n-alkanes and their $\delta^{13}\text{C}$ -methane isotopic signature, C9-C40 n-alkanes, porosity, sulfate reduction rates, total CNS, 16S rRNA phylogenetic studies, catalysed reporter deposition fluorescence *in situ* hybridization (CARD-FISH), and enrichment culturing for methanogens and sulfate reducers.

Sediment analyses

Concentration of volatile n-alkanes (C1 to C6) and their carbon isotopic signature

Dissolved volatile hydrocarbons (C1-C6) in the sediment were determined from subsamples of sediment core sections by using a headspace technique. Two ml of sediment and 5 ml of 2.5% (w/w) NaOH solution were equilibrated in a septum-sealed 13 ml headspace glass vial at room temperature (Sommer et al., 2009). For the analyses

of volatile hydrocarbons in the original crude oil, 2 ml of the oil and 5 ml of 2.5% (w/w) NaOH solution were equilibrated in a septum-sealed 13 ml headspace glass vial at room temperature. It should be noted, however, that we cannot completely exclude losses of volatiles from the original crude oil as it was analyzed after the SOFT experiment, during which it was kept stored at room temperature in its original sealed container. Hydrocarbon (C1-C6) composition of the headspace gas was then determined with a “Thermo Trace ultra” (Thermo Scientific) gas chromatograph equipped with flame ionization detector (carrier gas: helium 5.0; capillary column: RT Alumina Bond-KCl, column length: 50 m; column diameter: 0.53 μm). Precision of $\pm 1\text{-}3\%$ was achieved in comparison to standard hydrocarbon mixtures. Stable carbon isotope ratios of (C1) were measured by using a continuous flow GC combustion - Isotope Ratio Mass Spectrometer combination. Hydrocarbons were separated in a Thermo Trace GC (carrier gas: He; packed column: ShinCarbon, 1.5 m). The subsequent conversion of methane to carbon dioxide was conducted in a Ni/Pt combustion furnace at 1150°C. The $^{13}\text{C}/^{12}\text{C}$ -ratios of the produced CO_2 were determined by a Thermo MAT253 isotope ratio mass spectrometer. All isotope ratios are reported in the δ -notation with respect to Vienna Pee Dee Belemnite (VPDB). Analytical precision of the reported isotopic composition was $\pm 0.3 \text{ ‰}$. A detection limit of 10 ppmV methane (1ml syringe injection) had been achieved by using the movable capillary device “DIPcon®” for the reference CO_2 inlet instead of the original fixed one of Thermo Scientific™ (Cordt, 2012).

Higher n-alkanes (C10 to C40)

Sub-samples from sediment core sections were collected in aluminum foil and frozen at -20°C until analyses. Prior to extraction, the sediment samples were allowed to thaw at 4°C. Samples were extracted with an Accelerated Solvent Extraction (Dionex ASE 150, Thermo Scientific) and measured in GC-MS (Shimadzu, GCMA-QP2010 with auto injector AOC-20i) for n-alkanes. Around 4g of sediment (mixed with inert diatomaceous earth) was extracted with dichloromethane and acetone (80:20) at 100°C with the ASE (Application note 338, Dionex). The extract was dried over sodium sulfate and was passed through a glass chromatographic column (Eydram, length 25 cm, inner diameter 1 cm). The chromatographic column was filled with 1 g of silica gel (Roth, 230-400 μm mesh size, preheated at 450°C for 4 hours and activated with 8% v/w with deionized water) and contained silanized glass wool at the outlet end. The column was then

washed portion wise with 20 ml of n-hexane and the resulting extract was collected and dried in a conical flask. The conical flask was then washed with 2 ml of n-hexane and this final solution was measured with GC-MS (1:10 or 1:20 dilution depending on the sample). Before the extraction process, deuterated tetracosane ($C_{24}D_{50}$) was used as an internal standard in the extraction cell. 100 μL of 2000 $\text{ng } \mu\text{L}^{-1} C_{24}D_{50}$ was added to the extraction cell to achieve an end concentration of 20 $\text{ng } \mu\text{L}^{-1} C_{24}D_{50}$ in the final extract. A solution of 20 $\text{ng } \mu\text{L}^{-1} C_{24}D_{50}$ in n-hexane was measured separately to produce a reference peak area on the chromatogram. The ratio of the two chromatogram peak areas (sample extract and reference) of the internal standard was used to calculate the recovery of individual n-alkanes in our samples. The GC-MS had a capillary column (ZB-1HT Inferno, length 30 m, thickness 0.25 μm , diameter 0.25 mm). Helium Alphagaz-1 (Air Liquide) was used as the carrier gas with a flow rate of 0.8 ml min^{-1} . The samples were measured in scan mode with the mass-to-charge ratio (m/z) range of 43 to 85. The original crude oil was extracted in the same procedure by mixing it with inert diatomaceous earth prior extraction by ASE. To get a precision of the methodology, the original crude oil was extracted 4 times (from the first step of extraction to the final measurement step). A method precision range for each n-alkane in the original crude oil is provided in Appendix 5. Instrument precision for each n-alkane determined by repeated measurements of 1 $\text{ng } \mu\text{L}^{-1}$ standard mix is provided in Appendix 5.

Sediment Porosity and total C, N, S

Porosity was determined by weighing the wet and freeze-dried weight of the sediment. Porosity was then calculated from the water content assuming a dry solid density of 2.63 g cm^{-3} . As the bulk volume of petroleum was not removed by the freeze-drying process, porosity values might appear lower than they actually were in samples that contained oil. Porosity samples were subsampled for analyses of total C, N and S and analyzed by CARLO ERBA Elemental Analyzer (NA 1500) (Steeb et al., 2014). Total organic carbon was then determined by the difference in carbon content after removing the carbonate carbon through acidification (addition of 0.25 N HCl). Measurements were done in duplicates.

Sulfate reduction rates

Six μl of the carrier-free $^{35}\text{SO}_4^{2-}$ radio tracer (dissolved in water, 200 kBq, specific activity 37 TBq mmol^{-1}) was injected into the replicate push cores in 1-cm depth intervals according to the whole-core injection method (Jørgensen, 1978). The injected push cores were incubated for 6.5 hours at 16°C. After the incubation period was over, bacterial activity was stopped by slicing the push core in 1 cm intervals and transferring each sediment layer into 50 ml plastic centrifuge tubes filled with 20 ml zinc acetate (20% w/w). Five controls were prepared by adding the tracer to killed samples. The vials were stored at -20°C until rate determination by the cold chromium distillation procedure according to (Kallmeyer et al., 2004). For the SOFT core, 3 to 4 ml sediment was taken every 2 cm vertically in 5 ml glass tubes and were immediately sealed with butyl rubber stoppers after sampling (Treude et al., 2005). The tubes were injected with 6 μl carrier-free $^{35}\text{SO}_4^{2-}$ radiotracer (dissolved in water, 200 kBq, specific activity 37 TBq mmol^{-1}) and incubated at 16°C for 12 hours. Four controls were prepared by adding tracer to killed samples. Incubation was ended in the same way as described for the initial cores.

DAPI Staining:

Sediment samples were fixed in 3% formaldehyde for three hours at 4°C, washed with 1x PBS and stored in ethanol-PBS (1:1) at -20°C. Samples were diluted, four times ultrasonicated on ice at 20% intensity, 20 cycles, 30 seconds (Bandelin Sonopuls HD200). An aliquot was filtered on a 0.22 μm pore size polycarbonate filter. Filter sections were embedded in Citifluor:Vectashield (4:1) mounting medium containing 50 $\mu\text{g ml}^{-1}$ 4',6'-diamidino-2-phyllindole (DAPI). Microscopy was done with a Nikon eclipse 50i epifluorescence microscope.

Sediment analyses: Enrichment culturing

Anaerobic incubations were set up in an anaerobic chamber to determine methanogenic rates and the potential of indigenous microorganisms to degrade selected hydrocarbons. One g of sediment was transferred into autoclaved 50-ml glass bottles containing 20 ml of sulfate-free seawater medium (Widdel and Bak, 1992). The salinity of the medium was adapted to the respective original seawater conditions (12 psu) by adding varying amounts of NaCl (Merck, CAS-No: 7647-14-5). The glass vials were sealed with sterile butyl rubber stoppers and aluminum crimp caps. All tubes were flushed with N_2 to

remove traces of H₂ from the anaerobic chamber. Zero and 20 mM sulfate were added to the methanogenic microcosms and sulfate-reducing microcosms, respectively. Cultures were amended with the single substrates *n*-hexadecane, ethylbenzene (both 0.1 % v/v), toluene or 2-methylnaphthalene (0.5 mg of each), to investigate potential methane production rates related to the biodegradation of selected hydrocarbons. Controls without any added carbon source were incubated in parallel. Replicate cultures with 2-bromoethanesulfonate (BES; 10 mM), a specific inhibitor for methanogenic microorganisms (Scholten et al., 2000) were prepared to account for possible non-microbial methane emissions from the water or sediment samples. In sulfate-reducing microcosms, sodium azide (NaN₃, 50 mM), a strong microbial toxin, was used to prepare metabolically inactive controls. All microcosms were incubated at 30°C in the dark and monthly sampled to assess methane and CO₂ in the headspace as well as sulfide formation in the medium. Methane and CO₂ production rates were calculated by linear regression of each gas increased with incubation time and expressed in μmol day⁻¹ gDW⁻¹ (dry weight) of sediment (Krüger et al., 2001). Methane and CO₂ concentrations from microcosms headspace were analyzed using a methanizer-equipped gas chromatograph with flame ionization detector (GC-FID) fitted with a 6' Hayesep D column (SRI 8610C, SRI Instruments, USA) running isothermally at 60°C, after reduction of CO₂ to methane.

Acknowledgement

We would like to the Deutsche Forschungsgemeinschaft (DFG) and DEA Deutsche Erdoel AG for funding this project. The Geological Institute of Azerbaijan is thanked for their collaboration as well as P. Feldens for his support during the field sampling. We also thank the Technical and Logistic Center GEOMAR (TLZ) for their technical support in building the SOFT system, especially D. Wehrend, A. Petersen and S. Sturm. We also thank B. Domeyer, A. Bleyer and R. Surberg for their support in geochemical analyses. We would also like to thank S. Krause for his support in radiotracer injection and S. Bold and D. Ozod-Seradj for their help during the termination of the SOFT experiment.

References

- Abilov, F., Orudjev, A. & Lange, R. (1999). Optimization of oil-containing wastewater treatment processes. *Desalination*. 124 (1). p.pp. 225–229.
- Akper, A. (2012). Mud volcanoes in the South Caspian basin: nature and estimated depth of its products. *Natural Science*. 4 (7). p.p. 445.
- Allen, A., Schlueter, R. & Mikolaj, P. (1970). Natural oil seepage at coal oil point, Santa Barbara, California. *Science*. 170 (3961). p.pp. 974–977.
- Anderson, R.T. & Lovley, D.R. (2000). Hexadecane decay by methanogenesis. *Nature*. 404 (6779). p.pp. 722–723.
- Atlas, R.M. (1991). Microbial hydrocarbon degradation-bioremediation of oil spills. *Journal of Chemical Technology & Biotechnology*. 52 (2). p.pp. 149–156.
- Bauer, J.E., Montagna, P.A., Spies, R.B., Prieto, M.C. & Hardin, D. (1988). Microbial biogeochemistry and heterotrophy in sediments of a marine hydrocarbon seep. *Limnology and Oceanography*. 33 (6). p.pp. 1493–1513.
- Bertrand, J.C., Esteves, J., Mulyono, M. & Mille, G. (1986). Use of continuous flow through systems to determine petroleum hydrocarbon evolution in superficial marine sediments. *Chemosphere*. 15 (2). p.pp. 205–210.
- Boetius, A., Ravensschlag, K., Schubert, C.J., Rickert, D., Widdel, F., Gieseke, A., Amann, R., Jørgensen, B.B., Witte, U. & Pfannkuche, O. (2000). A marine microbial consortium apparently mediating anaerobic oxidation of methane. *Nature*. 407 (6804). p.pp. 623–626.
- Boetius, A. & Wenzhöfer, F. (2013). Seafloor oxygen consumption fuelled by methane from cold seeps. *Nature Geoscience*. 6 (9). p.pp. 725–734.
- Cai, W.-J. & Sayles, F.L. (1996). Oxygen penetration depths and fluxes in marine sediments. *Marine Chemistry*. 52 (2). p.pp. 123–131.
- Canfield, D.E., Jørgensen, B.B., Fossing, H., Glud, R., Gundersen, J., Ramsing, N.B., Thamdrup, B., Hansen, J.W., Nielsen, L.P. & Hall, P.O. (1993). Pathways of organic carbon oxidation in three continental margin sediments. *Marine geology*. 113. p.pp. 27–40.
- Cordt, H. (2012). *DIPcon-Patentantrag für Methode und Apparat zur Isotopenmessung*

durch spannungsangepasstes Referenzsignal unmittelbar nach einem Probenpeak im open-split. [Online]. Available from: <http://www.irms-crtl.com>.

- Cravo-Laureau, C., Labat, C., Joulain, C., Matheron, R. & Hirschler-Réa, A. (2007). *Desulfatiferula olefinivorans* gen. nov., sp. nov., a long-chain n-alkene-degrading, sulfate-reducing bacterium. *International journal of systematic and evolutionary microbiology*. 57 (Pt 11). p.pp. 2699–702.
- Das, N. & Chandran, P. (2010). Microbial degradation of petroleum hydrocarbon contaminants: an overview. *Biotechnology research international*. 2011.
- Delvigne, G. a. L. & Sweeney, C.E. (1988). Natural dispersion of oil. *Oil and Chemical Pollution*. 4 (4). p.pp. 281–310.
- Dumont, H.J. (1995). Ecocide in the Caspian Sea. *Nature*. 377 (6551). p.pp. 673–674.
- Dumont, H.J. (1998). The Caspian Lake: History, biota, structure, and function. *Limnology and Oceanography*. 43 (1). p.pp. 44–52.
- Effimoff, I. (2000). The oil and gas resource base of the Caspian region. *Journal of Petroleum Science and Engineering*. 28 (4). p.pp. 157–159.
- Ehrenreich, P., Behrends, a, Harder, J. & Widdel, F. (2000). Anaerobic oxidation of alkanes by newly isolated denitrifying bacteria. *Archives of microbiology*. 173 (1). p.pp. 58–64.
- Glud, R.N. (2008). Oxygen dynamics of marine sediments. *Marine Biology Research*. 4 (4). p.pp. 243–289.
- Glud, R.N., Gundersen, J.K., Jorgensen, B.B., Revsbech, N.P. & Schulz, H.D. (1994). Diffusive and total oxygen uptake of deep-sea sediments in the eastern South Atlantic Ocean: in situ and laboratory measurements. *Deep Sea Research Part I: Oceanographic Research Papers*. 41 (11-12). p.pp. 1767–1788.
- Hassanshahian, M. (2014). The effects of crude oil on marine microbial communities in sediments from the Persian Gulf and the Caspian Sea: A microcosm experiment. *International journal of Advanced Biological and Biomedical Research*. 2 (1). p.pp. 1–17.
- Hassanshahian, M., Emtiazi, G. & Cappello, S. (2012). Isolation and characterization of crude-oil-degrading bacteria from the Persian Gulf and the Caspian Sea. *Marine Pollution Bulletin*. 64 (1). p.pp. 7–12.

- Head, I.M., Jones, D.M. & Röling, W.F.M. (2006). Marine microorganisms make a meal of oil. *Nature reviews. Microbiology*. 4 (3). p.pp. 173–182.
- Holmer, M., Duarte, C.M. & Marbá, N. (2003). Sulfur cycling and seagrass (*Posidonia oceanica*) status in carbonate sediments. *Biogeochemistry*. 66 (3). p.pp. 223–239.
- Holmer, M. & Nielsen, S.L. (1997). Sediment sulfur dynamics related to biomass-density patterns in *Zostera marina* (eelgrass) beds. *Marine Ecology Progress Series*. 146 (1-3). p.pp. 163–171.
- Hornafius, J. (1999). The world's most spectacular marine hydrocarbon seeps (Coal Oil Point, Santa Barbara Channel, California): Quantification of emissions. *Journal of Geophysical Research: Oceans (1978–2012)*. 104 (C9). p.pp. 20703–20711.
- Horowitz, a & Atlas, R.M. (1977). Continuous open flow-through system as a model for oil degradation in the arctic ocean. *Applied and environmental microbiology*. 33 (3). p.pp. 647–653.
- Hunt, M. (1995). *Petroleum geochemistry and geology*. WH Freeman and Company.
- Jiménez, N., Viñas, M., Sabaté, J., Bayona, J.M., Solanas, A.M. & Albaigés, J. (2006). The Prestige oil spill.2. Enhanced Biodegradation of a Heavy Fuel Oil under Field Conditions by the Use of an Oleophilic Fertilizers. *Environmental Science & Technology*. 40 (8). p.pp. 2578–2585.
- Jones, D.M., Head, I.M., Gray, N.D., Adams, J.J., Rowan, a K., Aitken, C.M., Bennett, B., Huang, H., Brown, A., Bowler, B.F.J., Oldenburg, T., Erdmann, M. & Larter, S.R. (2008). Crude-oil biodegradation via methanogenesis in subsurface petroleum reservoirs. *Nature*. 451 (7175). p.pp. 176–180.
- Jørgensen, B.B. (2006). Bacteria and marine biogeochemistry. In: *Marine Geochemistry*. Springer Berlin Heidelberg, pp. 169–206.
- Jørgensen, B.B. (1978). A comparison of methods for the quantification of bacterial sulfate reduction in coastal marine sediments. *Geomicrobiology Journal*. 1. p.pp. 11–27.
- Jost, S. (2014). *Natural hydrocarbon seepage offshore Azerbaijan – A multidisciplinary approach for seepage detection and characterization of hydrocarbon origin*. Christian-Albrechts-Universität zu Kiel.
- Joye, S.B., Boetius, A., Orcutt, B.N., Montoya, J.P., Schulz, H.N., Erickson, M.J. & Lugo, S.K.

- (2004). The anaerobic oxidation of methane and sulfate reduction in sediments from Gulf of Mexico cold seeps. *Chemical Geology*. 205 (3-4). p.pp. 219–238.
- Kallmeyer, J., Ferdelman, T.G., Weber, A., Fossing, H. & Jørgensen, B.B. (2004). A cold chromium distillation procedure for radiolabeled sulfide applied to sulfate reduction measurements. *Limnology and Oceanography-Methods*. 2 (6). p.pp. 171–180.
- Karpinsky, M.G. (1992). Aspects of the Caspian Sea benthic ecosystem. *Marine Pollution Bulletin*. 24 (8). p.pp. 384–389.
- Katz, B., Richards, D., Long, D. & Lawrence, W. (2000). A new look at the components of the petroleum system of the South Caspian Basin. *Journal of Petroleum Science and Engineering*. 28 (4). p.pp. 161–182.
- Kleindienst, S., Herbst, F.A., Stagars, M., von Netzer, F., von Bergen, M., Seifert, J., Peplies, J., Amann, R., Musat, F., Lueders, T. & Knittel, K. (2014). Diverse sulfate-reducing bacteria of the Desulfosarcina/Desulfococcus clade are the key alkane degraders at marine seeps. *The ISME journal*. 8 (10). p.pp. 1–16.
- Kniemeyer, O., Musat, F., Sievert, S.M., Knittel, K., Wilkes, H., Blumenberg, M., Michaelis, W., Classen, A., Bolm, C., Joye, S.B. & Widdel, F. (2007). Anaerobic oxidation of short-chain hydrocarbons by marine sulphate-reducing bacteria. *Nature*. 449 (7164). p.pp. 898–901.
- Kosarev, A.N. (2005). Physico-geographical conditions of the Caspian Sea. In: *The Caspian Sea Environment*. Springer Berlin Heidelberg, pp. 5–31.
- Krüger, M., Frenzel, P. & Conrad, R. (2001). Microbial processes in \bar{u} encing methane emission from rice $\text{\textcircled{R}}$ elds. *Global Change Biology*. 4 (7). p.pp. 49–63.
- Kvenvolden, K.A. & Cooper, C.K. (2003). Natural seepage of crude oil into the marine environment. *Geo-Marine Letters*. 23 (3-4). p.pp. 140–146.
- LaMontagne, M.G., Leifer, I., Bergmann, S., Van De Werfhorst, L.C. & Holden, P.A. (2004). Bacterial diversity in marine hydrocarbon seep sediments. *Environmental Microbiology*. 6 (8). p.pp. 799–808.
- Mahmoudi, N., Robeson, M.S., Castro, H.F., Fortney, J.L., Techtmann, S.M., Joyner, D.C., Paradis, C.J., Pfiffner, S.M. & Hazen, T.C. (2014). Microbial community composition and diversity in Caspian Sea sediments. *FEMS Microbiology Ecology*. 91 (1). p.pp. 1–

11.

- Millero, F.J. & Chetirkin, P. V. (1980). The density of Caspian Sea waters. *Deep Sea Research Part A. Oceanographic Research Papers*. 27 (3). p.pp. 265–271.
- Orcutt, B.N., Boetius, A., Elvert, M., Samarkin, V. & Joye, S.B. (2005). Molecular biogeochemistry of sulfate reduction, methanogenesis and the anaerobic oxidation of methane at Gulf of Mexico cold seeps. *Geochimica et Cosmochimica Acta*. 69 (17). p.pp. 4267–4281.
- Orcutt, B.N., Joye, S.B., Kleindienst, S., Knittel, K., Ramette, A., Reitz, A., Samarkin, V., Treude, T. & Boetius, A. (2010). Impact of natural oil and higher hydrocarbons on microbial diversity, distribution, and activity in Gulf of Mexico cold-seep sediments. *Deep-Sea Research Part II: Topical Studies in Oceanography*. 57 (21-23). p.pp. 2008–2021.
- Orcutt, B.N., Samarkin, V., Boetius, A. & Joye, S. (2008). On the relationship between methane production and oxidation by anaerobic methanotrophic communities from cold seeps of the Gulf of Mexico. *Environmental Microbiology*. 10 (5). p.pp. 1108–1117.
- Peeters, F., Kipfer, R., Achermann, D., Hofer, M., Aeschbach-Hertig, W., Beyerle, U., Imboden, D.M., Rozanski, K. & Fröhlich, K. (1999). Analysis of deep-water exchange in the Caspian Sea based on environmental tracers. *Deep-Sea Research Part I: Oceanographic Research Papers*. 47 (4). p.pp. 621–654.
- Prince, R.C., Lessard, R.R. & Clark, J.R. (2003). Bioremediation of marine oil spills. *Trends in biotechnology*. 58 (4). p.pp. 463–468.
- Prince, R.C., McFarlin, K.M., Butler, J.D., Febbo, E.J., Wang, F.C.Y. & Nedwed, T.J. (2013). The primary biodegradation of dispersed crude oil in the sea. *Chemosphere*. 90 (2). p.pp. 521–526.
- Rebata-Landa, V. & Santamarina, J.C. (2006). Mechanical limits to microbial activity in deep sediments. *Geochemistry, Geophysics, Geosystems*. 7 (11).
- Reed, W.E. & Kaplan, I.R. (1977). The chemistry of marine petroleum seeps. *Journal of Geochemical Exploration*. 7 (255-293).
- Rockne, K. & Chee-Sanford, J. (2000). Anaerobic naphthalene degradation by microbial pure cultures under nitrate-reducing conditions. *Applied and Environmental*

- Microbiology*. 66 (4). p.pp. 1595–1601.
- Scholten, J.C.M., Conrad, R. & Stams, A.J.M. (2000). Effect of 2-bromo-ethane sulfonate, molybdate and chloroform on acetate consumption by methanogenic and sulfate-reducing populations in freshwater sediment. *FEMS Microbiology Ecology*. 32 (1). p.pp. 35–42.
- Seeberg-Elverfeldt, J., Schluter, M., Feseker, T. & Kolling, M. (2005). Rhizon sampling of porewaters near the sediment-water interface of aquatic systems. *Limnology and Oceanography-Methods*. 3. p.pp. 361–371.
- Sherry, A., Grant, R.J., Aitken, C.M., Jones, D.M., Head, I.M. & Gray, N.D. (2014). Volatile hydrocarbons inhibit methanogenic crude oil degradation. *Frontiers in Microbiology*. 5. p.pp. 1–9.
- Siddique, T., Fedorak, P.M. & Foght, J.M. (2006). Biodegradation of short-chain n-alkanes in oil sands tailings under methanogenic conditions. *Environmental Science and Technology*. 40 (17). p.pp. 5459–5464.
- Sommer, S., Linke, P., Pfannkuche, O., Schleicher, T., Deimling, J.S. V., Reitz, A., Haeckel, M., Flögel, S. & Hensen, C. (2009). Seabed methane emissions and the habitat of frenulate tubeworms on the Captain Arutyunov mud volcano (Gulf of Cadiz). *Marine Ecology Progress Series*. 382. p.pp. 69–86.
- Steeb, P., Krause, S., Linke, P., Hensen, C., Dale, A.W., Nuzzo, M. & Treude, T. (2015). Efficiency and adaptability of the benthic methane filter at Quepos Slide cold seeps, offshore of Costa Rica. *Biogeosciences*. 12 (22). p.pp. 6687–6706.
- Steeb, P., Linke, P. & Treude, T. (2014). A sediment flow-through system to study the impact of shifting fluid and methane flow regimes on the efficiency of the benthic methane filter. *Limnology and Oceanography: Methods*. 12 (1). p.pp. 25–45.
- Tissot, B.P. & Welte, D.H. (1984). *Petroleum formation and occurrence*. Springer Science & Business Media.
- Treude, T. (2003). *Anaerobic oxidation of methane in marine sediments*. University of Bremen.
- Treude, T., Niggemann, J., Kallmeyer, J., Boetius, a, Jorgensen, B.B., Wintersteller, P. & Schubert, C.J. (2005). Anaerobic oxidation of methane and sulfate reduction along the Chilean continental margin. *Geochimica et Cosmochimica Acta*. 69 (11). p.pp.

2767–2779.

- Wallmann, K., Aloisi, G., Haeckel, M., Obzhairov, a., Pavlova, G. & Tishchenko, P. (2006). Kinetics of organic matter degradation, microbial methane generation, and gas hydrate formation in anoxic marine sediments. *Geochimica et Cosmochimica Acta*. 70 (15). p.pp. 3905–3927.
- Wardlaw, G.D., Arey, J.S., Reddy, C.M., Nelson, R.K., Ventura, G.T. & Valentine, D.L. (2008). Disentangling oil weathering at a marine seep using GCxGC: Broad metabolic specificity accompanies subsurface petroleum biodegradation. *Environmental Science and Technology*. 42 (19). p.pp. 7166–7173.
- Water, D. (2011). The gulf oil disaster and the future of offshore drilling. *Report to the President [of the USA]*.
- Wenger, L.M. & Isaksen, G.H. (2002). Control of hydrocarbon seepage intensity on level of biodegradation in sea bottom sediments. *Organic Geochemistry*. 33 (12). p.pp. 1277–1292.
- Whiticar, M.J. (1999). Carbon and hydrogen isotope systematics of bacterial formation and oxidation of methane. *Chemical Geology*. 161 (1). p.pp. 291–314.
- Widdel, F. & Bak, F. (1992). Gram-negative mesophilic sulfate-reducing bacteria. In: *The Prokaryotes*. Springer New York, pp. 3352–3378.
- Widdel, F., Knittel, K. & Galushko, A. (2010). Anaerobic Hydrocarbon-Degrading Microorganisms: An Overview. In: *Handbook of Hydrocarbon and Lipid Microbiology*. Springer Berlin Heidelberg, pp. 1997–2021.
- Zengler, K., Richnow, H.H., Rosselló-Mora, R., Michaelis, W. & Widdel, F. (1999). Methane formation from long-chain alkanes by anaerobic microorganisms. *Nature*. 401 (6750). p.pp. 266–269.

Appendix for Chapter 4

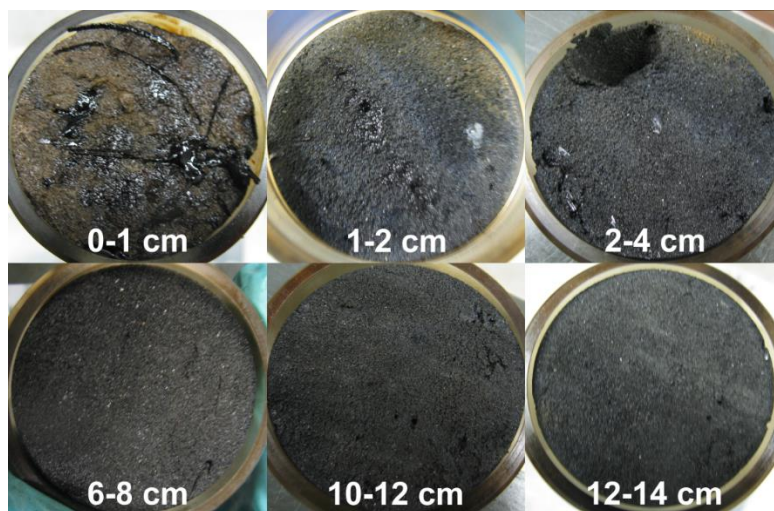

Appendix 1. Distribution of petroleum in the SOFT core during the vertical migration. The petroleum has distributed evenly throughout the sediment section but also channelized between the wall of the core liner and sediment in parts.

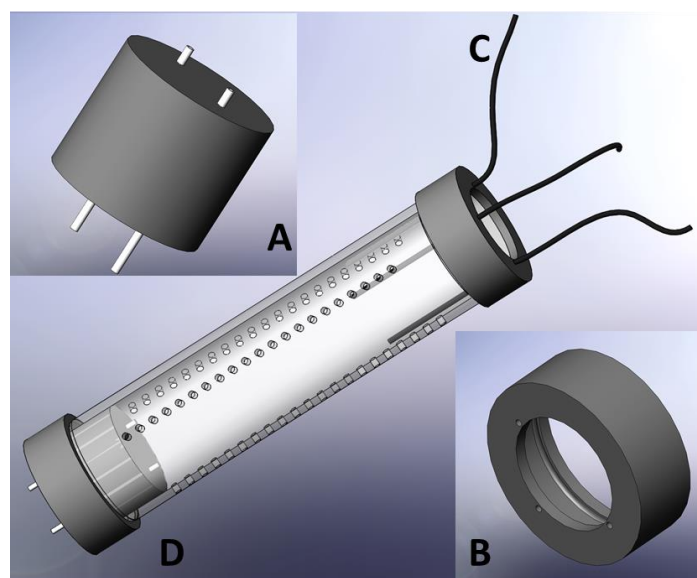

Appendix 2. Individual parts of the SOFT system. A) Rubber stopper with 2 integrated steel channels B) Upper cap with 3 small holes to guide tubing for aeration and seawater inflow/outflow C) Iso-versinic tubing D) Assembly of individual parts with the core liner.

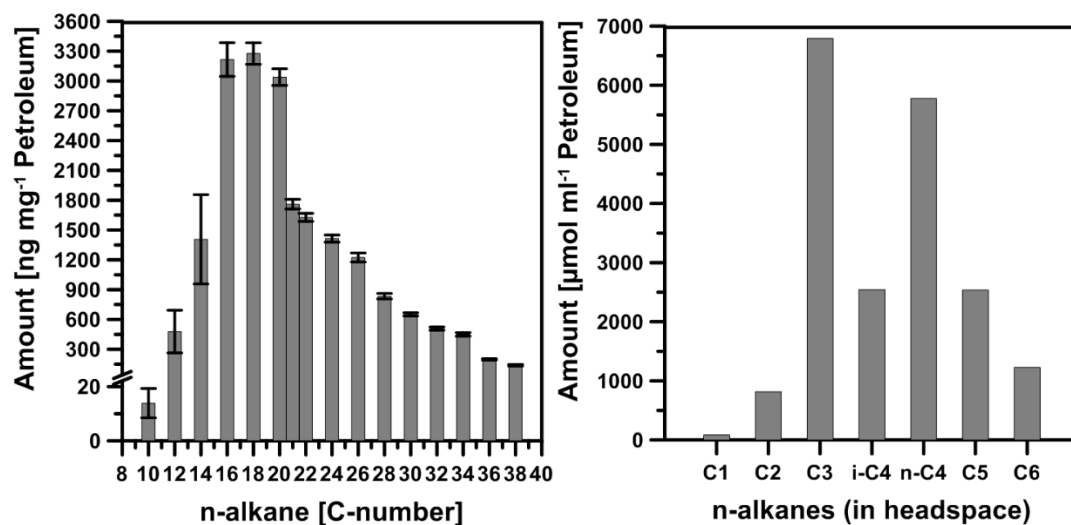

Appendix 3. Amount of n-alkanes in the original North Sea petroleum used in the SOFT system. The extraction process of petroleum was repeated five times to determine the analytical precision of individual n-alkanes. The precision is represented by the standard deviation. (Values are mean, $\pm\text{SD}$, $n = 5$)

Appendix 4. Technical specification of the original SLOT (methane seepage simulation) and the modified SOFT (oil seepage simulation) system (n.a = not applied).

Specification	SLOT (Steeb et al. 2014)	SOFT (this study)
Methane supply from below	via advection	n.a
Crude oil supply from below	n.a	via advection
Sulfate supply from top	via diffusion	
Oxygen supply from top	n.a.	via diffusion (supplied by air pump)
Seawater medium delivered from top	Anoxic sulfate-rich artificial seawater medium (Widdel & Bak, 1992), salinity adapted to the respective environment	Oxic seawater prepared from sea salt (Sigma Aldrich), salinity 13 ppt
Seepage medium delivered from bottom	Anoxic, sulfate-free artificial seawater medium (Widdel & Bak, 1992), salinity adapted to respective environment	n.a.
Sediment core liners	Polycarbonate core liners: gastight, total length 30 cm, inner diameter 6 cm, outer diameter 6.8 cm	
Sampling holes in core liners	3 vertical lines of 21 sampling holes (diameter 4 mm, distance between sampling holes 5.8 mm) sealed with residue-free silicon (Aquasil, Probau)	
Pore water sampling	Rhizons	
Peristaltic pumps	Medorex TL/10E, min/max pump volume 0.1/400 $\mu\text{L min}^{-1}$	
Peristaltic pump tubes	Santropen; autoclaveable, highflexible, very resistant; tubes inner diameter 0.5 mm, outer diameter 1.6 mm	
Connecting tubes	Iso-Versenic: autoclavable; very resistant; very low gas permeability ; inner diameter 1 mm; outer diameter 3 mm	
Bottom sealing	PVC caps	Rubber stoppers with 2 oil channels
Top sealing	PVC cap	PVC ring covered with parafilm

Appendix 5. Precision of n-alkane analyzes.

n-alkane	Standard deviation [%] n=4 (Method precision from extraction to measurement)	Standard deviation [%] n=5 (GC-MS precision for a standard mix of 1 ng/ μ L)
n-Decane (C-10)	38.9	2.2
n-Dodecane(C-12)	26.3	4.7
n-Tetradecane(C-14)	29.9	6.1
n-Hexadecane(C-16)	6.1	1.4
n-Octadecane(C-18)	3.2	1.4
n-Eicosane (C-20)	2.8	1.2
n-Heneicosane (C-21)	2.8	1.3
n-Docosane (C-22)	2.4	1.1
n-Tetracosane (C-24)	2.5	1.1
n-Hexacosane (C-26)	3.5	1.2
n-Octacosane(C-28)	3.5	1.1
n-Triacontane (C-30)	2.6	1.2
n-Dotriacontane (C-32)	3.6	1.3
n-Tetratriacontane (C-34)	4.3	1.2
n-Hexatriacontane (C-36)	4.3	1.4
n-Octatriacontane (C-38)	6.0	2.0
n-tetracontane (C-40)	n.a	3.8

5. Manuscript II.

Microbial community response to simulated petroleum seepage in Caspian Sea sediments

Marion Stagers¹, Sonakshi Mishra², Tina Treude^{2*}, Rudolf Amann¹, and Katrin Knittel^{1*}

¹Max Planck Institute for Marine Microbiology, Celsiusstr. 1, 28359 Bremen, Germany

*²GEOMAR Helmholtz Center for Ocean Research Kiel, Department of Marine
Biogeochemistry, Kiel, Germany*

**Present address: University of California, Los Angeles, Departments of Earth, Planetary &
Space Sciences and Atmospheric & Oceanic Sciences, Los Angeles, USA*

Submitted to

Environmental Microbiology, 2015

Summary

Anaerobic microbial hydrocarbon degradation is a major biogeochemical process at marine seeps. Here we studied the response of the microbial community to a petroleum seepage simulated for 190 days under close-to-in situ conditions in a sediment core from the Caspian Sea using a sediment-oil-flow-through (SOFT) system. Initial (t_0) and SOFT communities shared 43% bacterial genus-level 16S rRNA-based operational taxonomic units (OTU_{0.945}) but shared only 23% archaeal OTU_{0.945}. The community differed significantly between sediment layers. In layers of highest sulfate reduction, Deltaproteobacteria were fourfold more abundant in SOFT than in initial sediment. Based on an increase in specific CARD-FISH cell numbers, several groups of sulfate-reducing bacteria were identified who are likely responsible for the observed decrease in aliphatic hydrocarbon concentration: clade SCA1 for propane and butane degradation, clade LCA2 for mid- to long-chain alkane degradation, clade Cyhx for cycloalkanes, pentane and hexane degradation, *Desulfobacula* for toluene and benzene degradation and syntrophic methanogenic archaea of the genus *Methanosarcina* for long-chain alkane degradation. Sequencing of *masD*, a marker gene for alkane degradation encoding (1-methylalkyl) succinate synthase, revealed a low diversity in SOFT sediment with two abundant species-level OTU_{0.96} supporting that the major part of anaerobic hydrocarbon degradation is mediated by few groups of microbes.

Introduction

Crude oil mainly consists of aliphatic hydrocarbons (alkanes), naphthenes, aromatics, asphaltenes and other compounds in varying composition depending on where and how it was formed. A large and diverse number of microorganisms, including bacteria, archaea and fungi, have evolved the ability to utilize these hydrocarbons as sources of food and energy for growth under either oxic or anoxic conditions (Grossi *et al.*, 2008; Heider and Schühle, 2013).

Contaminations of an ecosystem with hydrocarbons as observed, e.g., after the *Deepwater Horizon* disaster in the Gulf of Mexico (Atlas and Hazen, 2011; Kimes *et al.*, 2013; Kimes *et al.*, 2014), have important consequences on the autochthonous microbial communities, which suffer drastic changes in structure and function. In the oxic water column the majority of oil is degraded by aerobic microbes, while oil from “natural spills” at hydrocarbon seeps is mainly degraded by anaerobic microbes living in benthic environments (Head *et al.*, 2003; Jones *et al.*, 2008). Using sulfate, nitrate, manganese or ferric iron as electron acceptors anaerobic enrichment cultures were established from marine seep sediments, oil reservoirs and petroleum polluted sites (e.g. Kniemeyer *et al.*, 2007; Weelink *et al.*, 2009; Jaekel *et al.*, 2012; Mbadinga *et al.*, 2012; Bian *et al.*, 2015) and several isolates have been obtained. Furthermore, hydrocarbon-degrading syntrophic enrichment cultures have been established under methanogenic conditions (for example, Zengler *et al.*, 1999; Chang *et al.*, 2006; Berdugo-Clavijo and Gieg, 2014; Embree *et al.*, 2014). Responsible strains can degrade only a narrow range of hydrocarbon sources and belong to the phyla Proteobacteria, Firmicutes within the domain Bacteria or to Euryarchaeota within the domain Archaea (Figure 1). A common way of alkane activation is its addition to the double bond of fumarate (fumarate addition), which is catalyzed by the glycyl radical enzyme 1-methyl alkyl succinate synthase (Mas; Grundmann *et al.*, 2008) acronym: alkylsuccinate synthase (Ass; Callaghan *et al.*, 2008). As such, genes encoding the catalytic subunits of Mas (*masD*) serve as potential biomarkers for alkane-degrading communities in anoxic hydrocarbon-impacted environments (Callaghan, 2013a, b).

The fate of oil in the marine environment is subjected to microbial activity, thus altering the oil's composition. The rate of microbial degradation depends on several environmental factors like nutrients, salinity, and availability of terminal electron

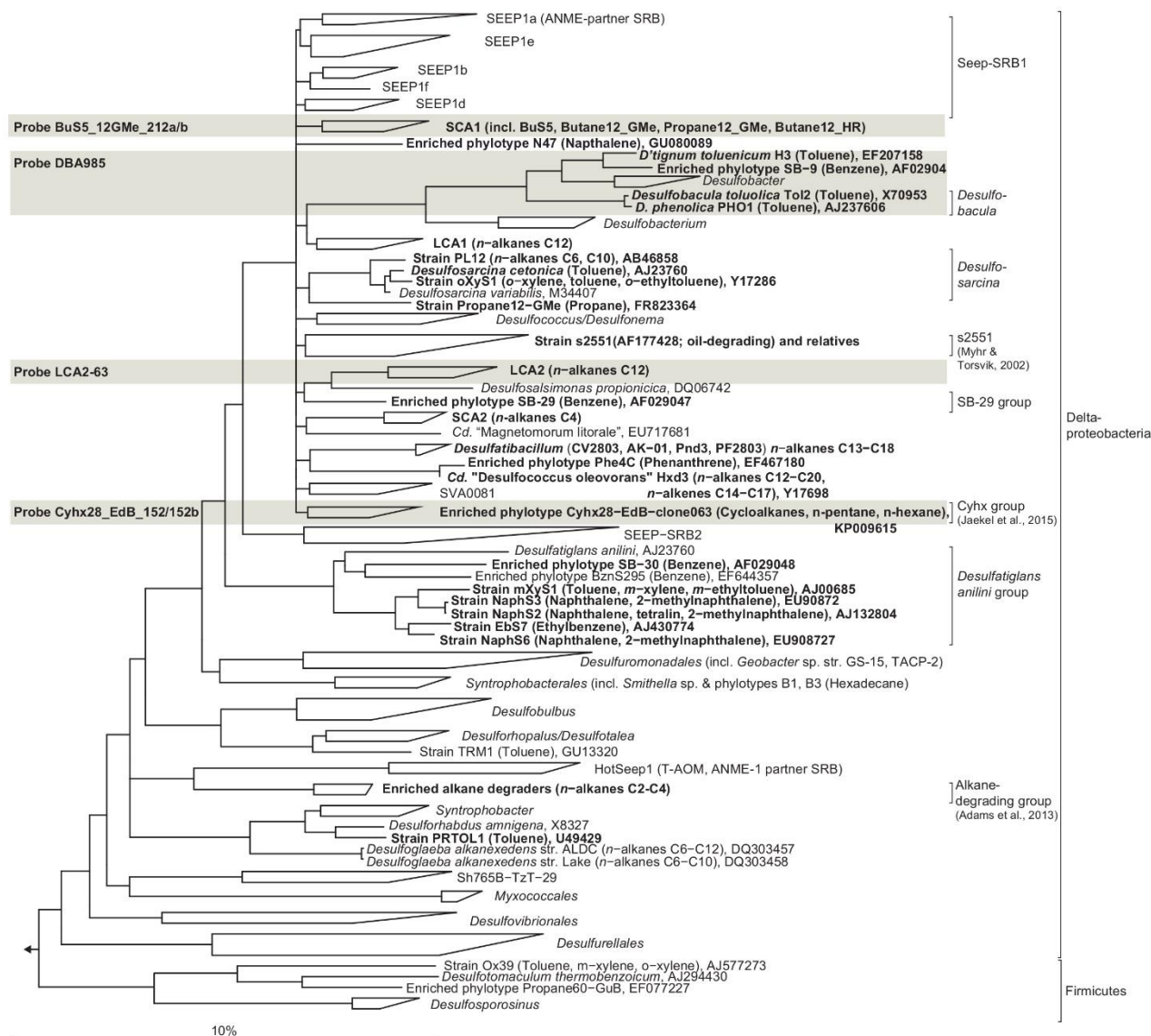

Figure 1. Phylogenetic tree showing the affiliation of 16S rRNA sequences of cultured or enriched sulfate-reducing anaerobic hydrocarbon degraders to selected reference sequences of the domain Bacteria. Substrate usage of hydrocarbon degraders is given in parentheses. Hydrocarbon degraders detected in the 16S rRNA gene sequence dataset from SOFT core sediment (based on genus-level; >94.5% sequence similarity) have been printed in boldface type. The grey boxes show coverage of probes used for CARD-FISH. For quantified clades, i.e. SCA1, Desulfobacula and relatives, LCA2, and Cyhx, an increase of cell numbers by at least 2fold were detected in the zone of sulfate reduction. The bar represents 10% estimated sequence divergence.

acceptors, composition of crude oil, temperature and pressure (Atlas, 1981; Leahy and Colwell, 1990). Only few studies investigated anaerobic hydrocarbon degradation under close-to-in situ conditions and most of these studies have focused either on one or few selected hydrocarbons (Spormann and Widdel, 2000; Widdel *et al.*, 2010; Mbadanga *et al.*, 2011). Thus, the aim of this study was to follow the response of the benthic microbial community on simulated oil seepage in a marine sediment core. In the accompanying study by Mishra *et al.* (this issue) a sediment-oil-flow-through (SOFT) system was established that simulated oil seepage-like conditions. In this SOFT system, intact sediment cores are supplied with crude oil flow from below (simulating a seep situation) and artificial seawater with electron acceptors like sulfate and oxygen from above. Sediment cores from the Caspian Sea (Western Asia) were chosen for establishing the SOFT system. The Caspian Sea is the largest enclosed basin on Earth (ca. 380.000 km², Dumont, 1998). In the past, the Caspian Sea was, as remnant of the Paratethys Sea, connected to oceans, but has become landlocked five million years ago. Thus, the Caspian Sea has unique natural conditions and rich natural resources, both biological and mineral (Kosarev, 2005). Due to the large influx of freshwater by numerous rivers that drain into the Caspian Sea, the salinity is only about one-third of that of seawater (1.3%, Millero and Chetirkin, 1980), making it a lacustrine brackish water body (Leroy *et al.*, 2007). The Caspian Sea harbors significant oil and gas reserves (Zonn, 2005), so that sediments used in this study has got some history of (nearby) hydrocarbon seepage. However, concentrations of alkanes in initial sediments were below the detection limit of <0.1 ng ml⁻¹ (Mishra *et al.*, this issue).

Here we report the microbial 16S rRNA gene diversity in Caspian Sea sediments sampled at t_0 (representing the initial conditions) and after 190 days of stimulated crude oil seepage in the SOFT core by 454 pyrosequencing. Furthermore, the anaerobic alkane-degrading community was analyzed based on MasD diversity. We hypothesize that specific taxa respond specifically to simulated crude oil seepage by an increase of their cell numbers resulting in a change of community composition. We further hypothesize that this specific cell increase is vertically structured according to sequential crude oil degradation. To address these hypotheses specific cell numbers of selected hydrocarbon-degrading taxa in SOFT core versus initial core sediments were determined by CARD-FISH, and molecular

data obtained in this study were correlated with the biogeochemical and crude oil degradation data obtained by Mishra *et al.* (this issue).

Results and discussion

Oil seepage was simulated in a sediment core from the Caspian Sea using a sediment-oil-flow-through (SOFT) system (for details see Mishra *et al.*, this issue). Crude oil was pumped at a constant rate through the core from the bottom to top, while artificial oxic seawater diffused into the sediment from the ventilated supernatant. Methanogenesis and sulfate reduction were identified as important processes in the anaerobic degradation of hydrocarbons during petroleum seepage in Caspian Sea sediments (Mishra *et al.* this issue).

Sequence dataset specification, microbial richness and evenness.

We obtained 146,181 bacterial and 393,789 archaeal raw 16S rRNA gene sequences from initial and SOFT sediments. After strict quality trimming about 40% of the raw reads were left for analysis (Table 1). In total, 2478 bacterial and 153 archaeal genus-level operational taxonomic units at 94.5% sequence identity (OTU_{0.945}) were detected in the sediment to (herein after referred to as “initial sediment”) and 2558 bacterial and 241 archaeal OTU_{0.945} in SOFT sediment. The bacterial dataset contained 4.1% absolute single sequence OTU (SSO_{abs}; OTU_{0.945} that occurred only once in the whole dataset) and 10.6% relative single sequence OTU (SSO_{rel}; OTU_{0.945} that occurred only once in at least one sample but are more frequent in other samples) and the archaeal dataset contained 7% SSO_{abs} and 19.1% SSO_{rel}. Chao 1 bacterial genus-level richness estimates based on standardized datasets were similar for initial and SOFT sediments and ranged between 396 and 532 OTU_{0.945} (Table 1). Archaeal richness estimates were one order of magnitude lower and ranged between 30 and 35 OTU_{0.945} in initial sediments and between 57 and 81 OTU_{0.945} in SOFT sediments. Coverage was >94.6% (Bacteria) and >99.6% (Archaea) for all layers in both cores and rarefaction curves nearly reaching saturation indicated sufficient sequencing effort (Figure S1). The observed bacterial richness on genus-level fits to that reported before in other studies of benthic habitats for species-level which ranged between ca. 300 OTU_{0.97} at

hydrothermal vents to ca. 6500 bacterial OTU_{0.97} at the deep-sea surface and ca. 1500 archaeal OTU_{0.97} in coastal sediments (Ruff *et al.*, 2015). With an inverse Simpson index between 4.3 and 6.6, archaeal diversity was low in initial and SOFT sediments (Table 1). Across all layers, archaeal diversity was lower than bacterial diversity. In initial sediments inverse Simpson for Bacteria ranged between 40.1 and 82.1 and was highest in the two uppermost layers. In SOFT sediments inverse Simpson ranged between 42.9 and 59.9.

Microbial community similarity between initial and SOFT sediments.

The uppermost layer of the SOFT core (0-1 cm depth) was excluded from the similarity analysis due to the influence of an accumulating oil slick above and oxygen penetration (Mishra *et al.*, this issue) into this layer.

Pairwise comparison of initial and SOFT sediments resulted in 43% shared bacterial OTU_{0.945} but only 23% shared archaeal OTU_{0.945} (Table S1). Communities were as similar to each other within the core as between identical layers of the two cores: On average, 55% bacterial and 59% archaeal OTU_{0.945} were shared within a core versus 51-56% bacterial and 59% archaeal OTU_{0.945} shared between identical layers (Table S2).

Similarity of bacterial (Figure 2A, B; 11 samples) and archaeal (Figure 2C, D; 10 samples) communities was visualized by nonmetric multidimensional scaling (NMDS). Bacterial dissimilarity (Bray-Curtis) of samples is supported by an R value of 0.49 ($p < 0.001$). Archaeal dissimilarity (Bray-Curtis) of samples is supported by an R value of 0.57 ($p < 0.001$). The bacterial and archaeal community differed significantly between different sediment layers as confirmed by analysis of similarity (ANOSIM, Figure 2A, C; Bacteria: $R = 0.46-0.73$, $p < 0.001$; Archaea: $R = 0.75$; $p < 0.001$). Between the cores, community was only significantly different for Archaea ($R = 0.73$; $p < 0.001$) but not for Bacteria ($R = 0.31$, $p = 0.05$; Figure 2B, D).

Fitting of environmental variables found significant correlations for methane ($p = 0.003$), suggesting that methane likely influenced the observed pattern of archaeal taxonomic clustering, while sulfate reduction rates ($p < 0.001$) and sulfate concentration ($p = 0.07$) likely influenced bacterial taxonomic clustering.

Bacterial taxa in initial and SOFT sediments

On phylum-level, the composition of the bacterial community was similar in initial and SOFT sediments (Figure 3A, B). Proteobacteria dominated throughout the cores accounting for 56% and 50% of bacterial 16S rRNA gene sequences in initial and SOFT sediments, respectively. Planctomycetes, Actinobacteria, and Chloroflexi (5% to 7%

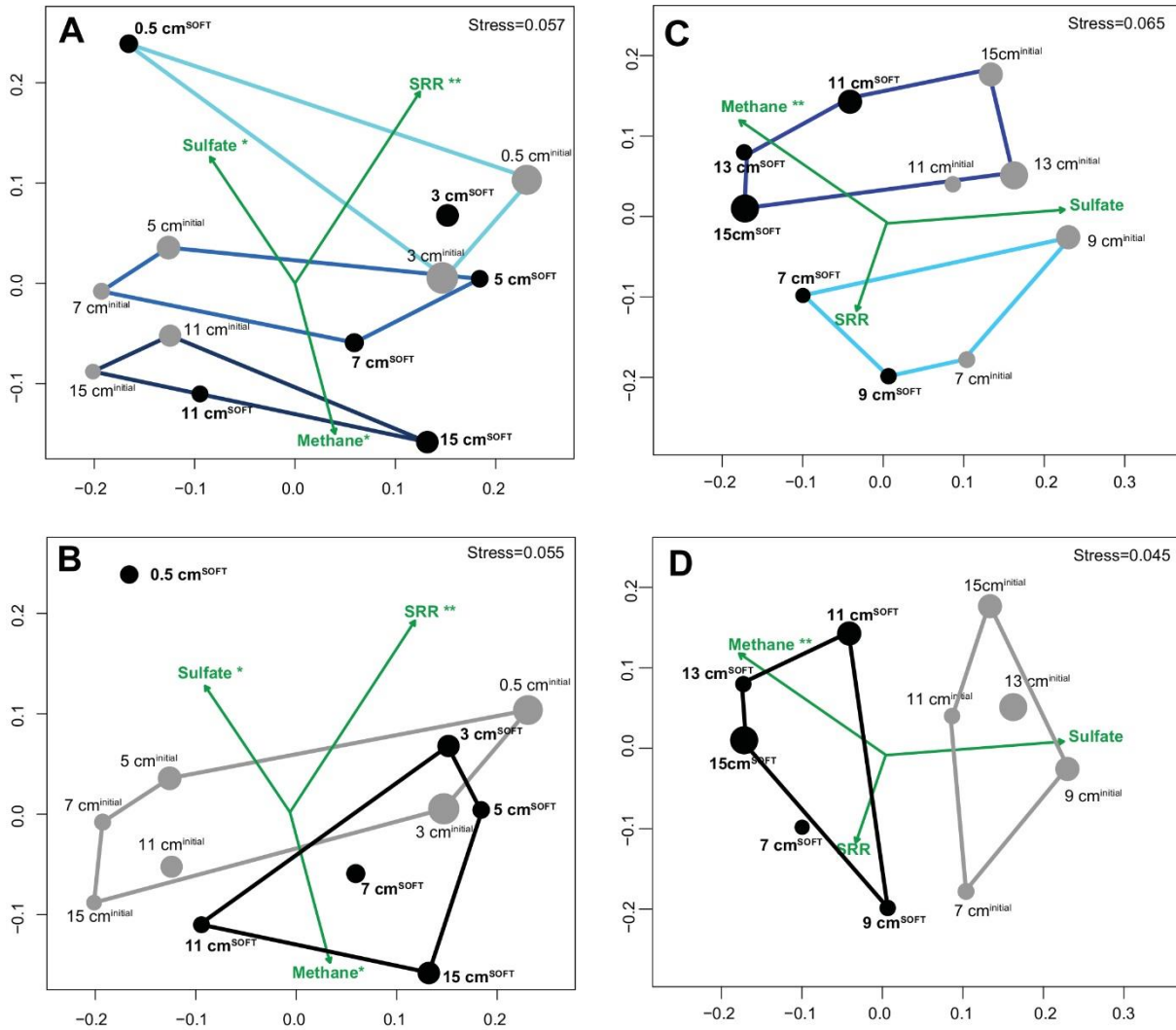

Figure 2. Similarity of bacterial (A, B) and archaeal (C, D) communities visualized by non-metric multidimensional scaling (NMDS) of Bray-Curtis dissimilarity matrices based on OTU_{0.945} relative abundance data with environmental variables fitted as vectors. Grey dots represent initial sediment subsamples and black dots represent SOFT sediment subsamples. The size of the dots reflects the evenness of the subsamples (inverse Simpson index). Defined subgroups are depicted as colored polygons. Dataset for SOFT core layer 0.5 cm depth was excluded from the analysis because this layer became oxic and was influenced by an oil slick forming on top of the core during the

experiment. Significance levels are shown after the tested parameters methane, sulfate, and sulfate reduction rates (**: $p < 0.01$; *: $p < 0.1$). SRR, sulfate reduction rates.

each) were the next sequence-abundant phyla. One-third (initial sediment) and one-half (SOFT) of the proteobacterial sequences belonged to the class Deltaproteobacteria (Figure S2A, B) while almost one-half (initial sediment) and one-third (SOFT) belonged to Gammaproteobacteria. In comparison, previous studies investigating the microbial community in natural Caspian Sea sediments reported similar taxa with Proteobacteria being most abundant (33% of reads on average), followed by Planctomycetes (14%) and Chloroflexi (12%) (Mahmoudi *et al.*, 2015).

The major part of gammaproteobacterial sequences in SOFT and initial sediment affiliated with JTB255 (29% and 30%), recently described as ubiquitous chemolithoautotrophic key players potentially involved in sulfur oxidation in marine sediments (Dyksma *et al.*, in press). A remarkable increase of Alphaproteobacteria was observed after oil-flow-through in the uppermost layer of SOFT sediments at 0.5 cm depth (initial sediments: 6%; SOFT: 12%). The alphaproteobacterial genera *Novosphingobium*, *Sphingomonas*, *Thalassospira*, and *Kordiimonas*, that were described to aerobically degrade aromatic hydrocarbons (Kim and Kwon, 2010), have been found in the SOFT dataset retrieved from 0.5 cm depth. As the top layer in the SOFT core was oxic (Mishra *et al.*, this issue) and was covered by an oil slick, the detection of sequences from known hydrocarbon degraders suggested the development of an aerobic hydrocarbon-degrading bacterial community. Sequences related to known gammaproteobacterial aerobic hydrocarbon degraders (Kleindienst *et al.*, 2015) have also been detected in this layer including *Cycloclasticus*, *Marinobacter*, *Alcanivorax*, and *Thalassolituus*. In particular, the relative abundance of sequences assigned to *Cycloclasticus* increased remarkably by a factor of 10 from 0.1% in initial sediments to 1.0% in the oxic SOFT layer. *Cycloclasticus* spp. had been described as globally relevant degraders of aromatic hydrocarbons such as naphthalene, phenanthrene, anthracene, and toluene (Dyksterhouse *et al.*, 1995). For example, they became enriched in the *Deepwater Horizon* hydrocarbon plume in the water column (Redmond and Valentine, 2012; Dubinsky *et al.*, 2013).

Deltaproteobacteria were analyzed in greater detail as most known anaerobic hydrocarbon degraders belong to this group (Figure 1). An increase of relative sequence abundance of Deltaproteobacteria was observed in the anoxic layers of the SOFT core between 2 and 8 cm depth (17-25% in initial versus 23-35% in SOFT sediment). Of these, more than one-half could be further assigned to the order Desulfobacterales accounting for a maximum of 20-22% of total bacterial sequences between 4 cm and 12 cm depth (Figure S2). Within Desulfobacterales, the uncultured Sva0081-group, which was first described in clone libraries from Svalbard sediments (Ravenschlag *et al.*, 1999) and includes sulfate-reducing endosymbionts of the gutless marine oligochaete *Olavius* sp., was the most sequence-abundant group with 2.3 to 5.7% of total sequences (Table 2). Relative abundance did not differ remarkably between initial and SOFT sediments supporting current knowledge, that members of Sva0081 are a ubiquitous and highly abundant member of SRB communities in diverse benthic habitats (Mußmann *et al.*, 2015). A second sequence-abundant group was the uncultivated SEEP1d with up to 3.4% of total bacterial sequences between 10 and 16 cm in both, initial and SOFT sediments. SEEP1d was repeatedly found at marine seep sites but no function has yet been assigned (Knittel *et al.*, 2003; Schreiber *et al.*, 2010).

Many known groups of hydrocarbon-degrading SRB were found in our dataset (Figure 1), some of which showed an increase of relative sequence abundance after oil-flow-through in the zone of highest sulfate reduction at 2-8 cm SOFT depth; other did not (Table S3). Most sequence-abundant and at the same time strongly increased were toluene-degrading *Desulfobacula* spp. with up to 8.1% of total bacterial sequences compared to 1.7% in initial sediments. Less sequence-abundant but increased in SOFT sediments were long-chain alkane-degrading SRB of LCA2 (Kleindienst *et al.*, 2014) with 0.2% vs. 1.9%, clade Cyhx (Jaekel *et al.*, 2015, 0.2% vs. 0.6%), C₂-C₄ alkane degraders (Adams *et al.*, 2013, 0.1% vs. 1.1%), alkane or aromatics-degrading *Desulfosarcina* spp. (0.6% vs. 1.5%), and s2551group (0.5% vs. 1.1%), reported as oil-degrading bacteria in an oil-reservoir model column (Myhr *et al.*, 2002). Relative sequences abundances of short-chain alkane-degrading SCA1, which includes the only isolated *n*-butane-degrading strain BuS5 (Kniemeyer *et al.*, 2007), did not increase after oil-flow-through and were constantly low with 0.3 – 0.8% of total bacterial sequences in both, initial and SOFT sediments. No remarkable change (0.2 vs 0.3%) has also been observed for *Cd. Desulfococcus oleovorans* Hxd3 group (Aeckersberg *et al.*,

1991), LCA1 (0.1%), *Desulfatiglans*-group (1.1 to 2.1%), and SB-29 (around 0.5%). Sequences related to known hydrocarbon-degraders within the Firmicutes, i.e. Propane60GuB (Kniemeyer *et al.*, 2007) and *Desulfotomaculum* sp. strain Ox39 (Morasch *et al.*, 2004), were not retrieved. However, Peptococcaceae, in particular autotrophic hydrogen-utilizing SRB of the genus *Desulfosporosinus* spp., increased at 15 cm depth in SOFT sediments (initial sediments: 1.1%; SOFT: 4.8% of total bacterial sequences).

Archaeal taxa in initial and SOFT sediments

On phylum-level, significant differences were observed between the archaeal community in SOFT and initial sediments (Figure 3C, D). In initial sediments at 7 and 9 cm depth, most sequence-abundant phylum was Thaumarchaeota (on average 30% of total archaeal sequences at 7-15 cm depth with a maximum of 64% at 7 cm), of which all currently known species are chemolithoautotrophic ammonium-oxidizers (Könneke *et al.*, 2014). Below, at 11 cm to 15 cm depth, sequences related to euryarchaeotal Marine Benthic Group D and DHVEG-1 (20% of total archaeal sequences) and Thermoplasmata CCA47 (13%), a group of uncultivated euryarchaeotal sequences isolated from an anoxic sediment of a sub-saline shallow lake (Laguna de Carrizo, Central Spain, Ferrer *et al.*, 2011), were most abundant. In the SOFT core, Thaumarchaeota had only low sequence frequencies (0.6% to 2.5%). Dominant groups were DHVEG, Thermoplasmata ASC21 (9%) a group of uncultivated Thermoplasmatales isolated from a hot spring in the Lower Culex region of the Lower Geyser Basin, Yellowstone National Park (Saw *et al.*, 2015), and Deep Sea Euryarchaeotic Group (DSEG; 7% in 14–16 cm). High relative sequence numbers of Methanosarcinales were detected at 7 cm (7% of total archaeal sequences) and at 9 cm (38%) depth in the SOFT core whereas in other layers and in initial sediments they were nearly absent. More than 99% of the Methanosarcinales sequences affiliated with the genus *Methanosarcina*. The closest relatives were *M. semesiae* and *M. lacustris*, with a 16S rRNA gene similarity of >98%. Furthermore, very few sequences (<<1% of total archaeal sequences) affiliated with other known methanogens such as *Methanobolus* and *Methanococcoides* (Methanosarcinaceae), Methanosaetaceae, Methanomicrobiaceae, Methanocellaceae, or Methermicrococcaceae were detected in SOFT sediments (Table S4). Methanotrophs of the

ANME clades (ANME-1, ANME-2, ANME-3) were only sporadically detected. In comparison, previous studies of the microbial community in Caspian Sea sediments identified Thaumarchaeota and Parvarchaeota as dominant in surface layers while Marine Benthic Group B (Lokiarchaeota) dominated the deeper layers (Mahmoudi *et al.*, 2015).

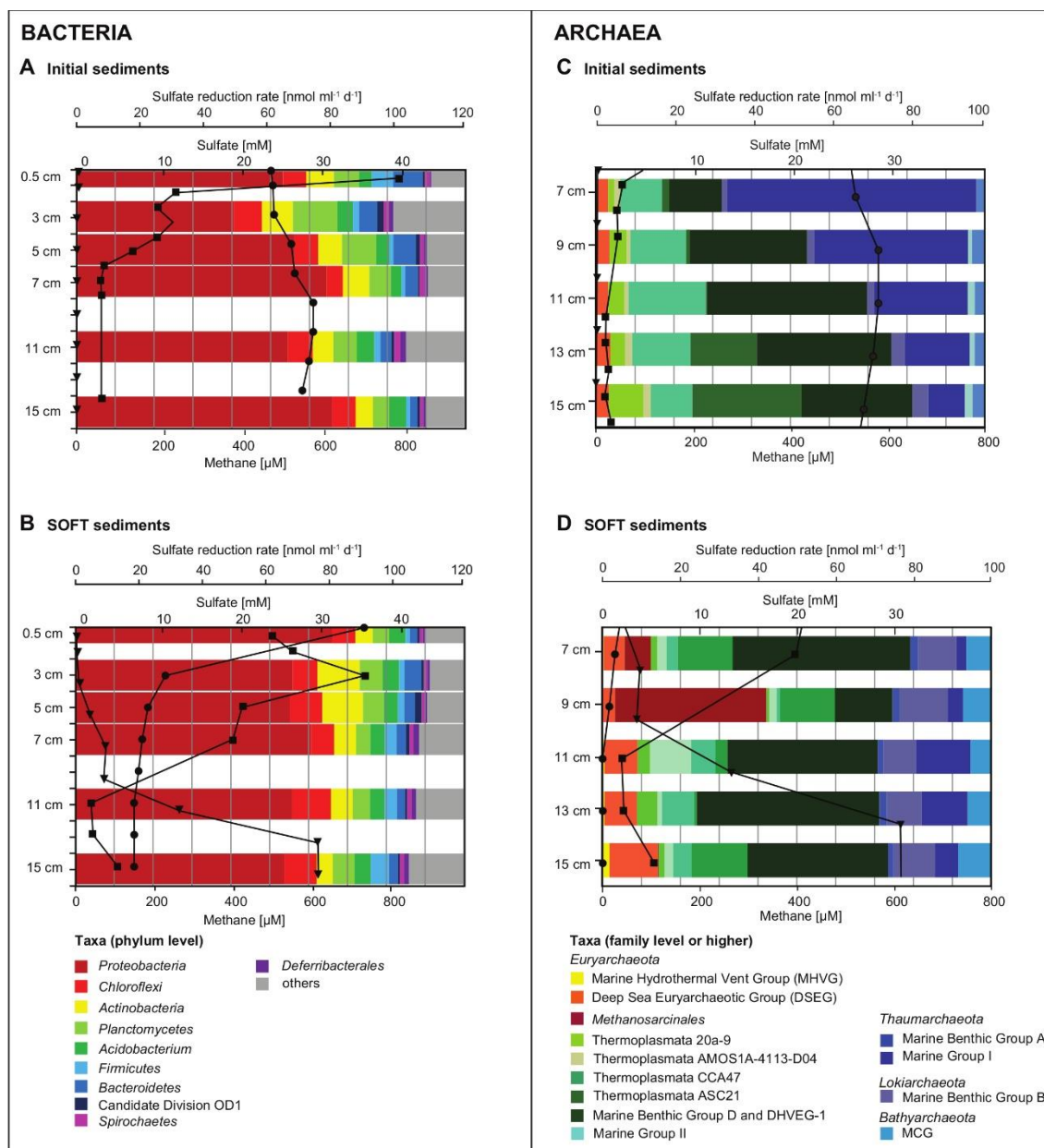

Figure 3. Microbial community composition in Caspian Sea sediments before and after simulated oil seepage. Relative abundance of (A, B) bacterial taxa (based on 454-pyrosequencing of 16S rRNA genes) and (C, D) archaeal taxa (based on IonTorrent-sequencing of 16S rRNA gene) in (A, C) initial core and (B, D) SOFT core sediments. Depth profiles of methane (triangles), sulfate (dots) and sulfate reduction rates (rectangles) were taken from Mishra *et al.* (this issue).

Response of hydrocarbon-degrading SRB to simulated crude-oil seepage.

Based on identified changes in relative sequence abundance, we selected several groups of SRB as target for CARD-FISH and cell counting (Figure 4).

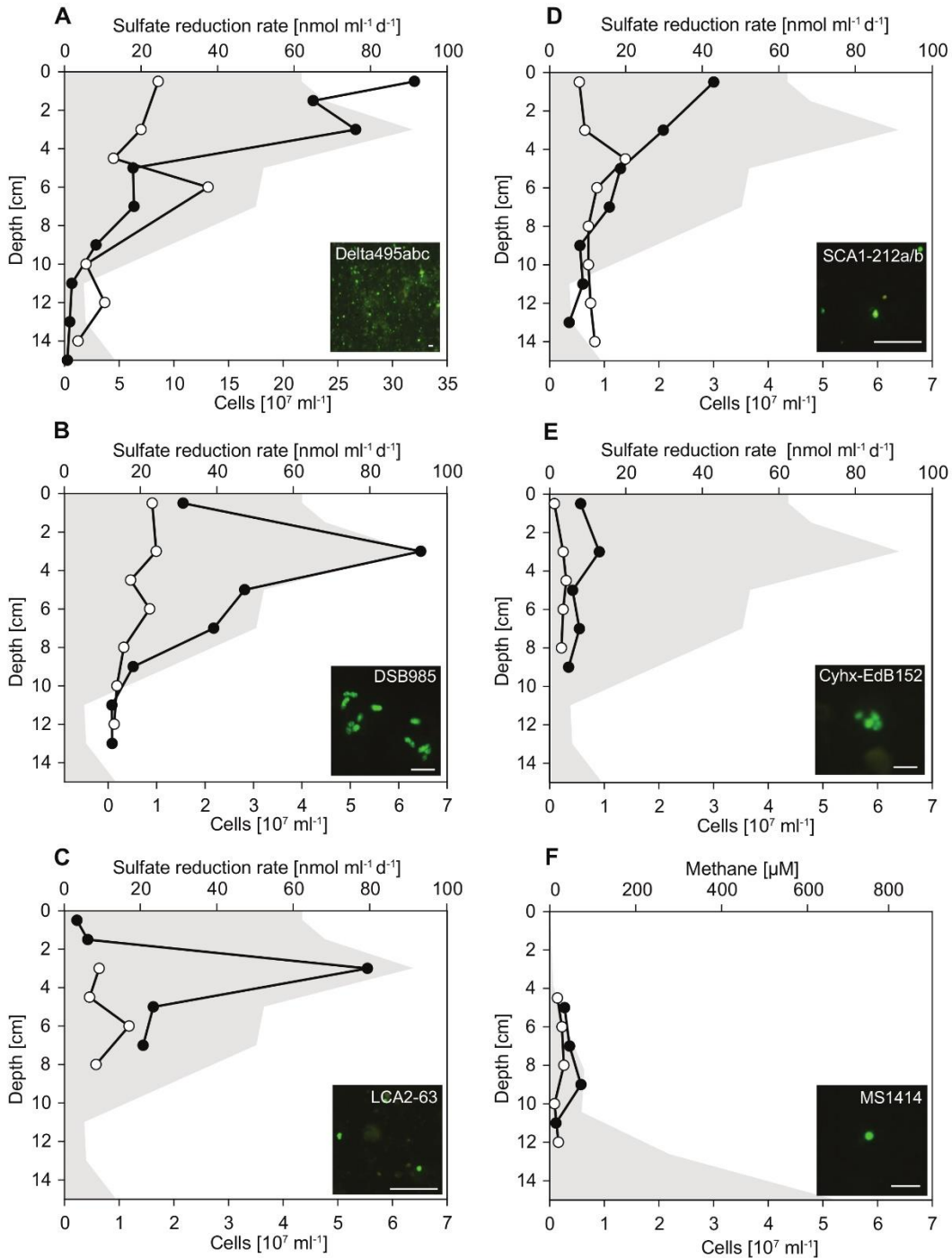

Figure 4. Cell numbers of potential hydrocarbon degraders in initial and SOFT Caspian Sea sediments. Vertical profiles showing specific cell numbers in initial (white dots) and SOFT (black

circles) core sediments as detected by CARD-FISH with (A) probe Delta495abc for Deltaproteobacteria, (B) probe DSB985 for *Desulfobacula* spp., *Desulfotignum* spp. and *Desulfobacter* spp., (C) probe LCA2-63 for clade LCA2, (D) probe SCA1-212a/b for clade SCA1, (E) probes Cyhx-EdB_152/152b for clade Cyhx, and (F) probe MS1414 for *Methanosarcina* spp., *Methanococoides* spp., *Methanolobus* spp. and *Methanohalophilus* spp. Sulfate reduction rates (A-E) and methane concentration (F) for SOFT core are shown by grey area (data taken from Mishra *et al.*, this issue). Bar = 5 μ m.

Deltaproteobacteria were most abundant between 0 and 4 cm depth (Figure 4A). In these layers, deltaproteobacterial cell numbers increased by a factor of 4 compared with numbers in initial sediment layers and accounted for up to 3.2×10^8 cells ml⁻¹ SOFT sediment (24-28% of total cells) and up to 8.6×10^7 cells ml⁻¹ initial sediment (9-17%). The peak of Deltaproteobacteria in SOFT sediment coincided with the strong decrease of sulfate concentration, highest sulfate reduction rates and the decrease of aliphatic hydrocarbon concentrations (see Mishra *et al.*, this issue) indicating a response of specific hydrocarbon-degrading Deltaproteobacteria. Major decrease of gaseous alkanes was observed above 7 cm depth (Mishra *et al.*, this issue). Mid- and long-chain alkanes (C₁₂ – C₃₀) decreased by about 50% above 14 cm depth, further 25% above 7 cm and remained relatively constant until top of the core.

Using probe DSB985, we targeted the either toluene- or benzene-degrading SRB within *Desulfobacula*, *Desulfotignum* and *Desulfobacterium*. Members of this group were found in high numbers in the SOFT core accounting for up to 6.4×10^7 cells ml⁻¹ sediment (7% of total cells, Figure 4B). Cell numbers peaked at 3 cm depth and strongly decreased below. In initial sediments, *Desulfobacula* cell numbers were almost an order of magnitude lower accounting for only 1% of total cells. Although degradation of aromatic compounds had not been followed during the experiment, we assume a standard composition of the light oil used for flow-through of about 30% aromatics, 0-10% asphaltenes, and major part being alkanes. Highest cell numbers were found within the zone of sulfate reduction thus indicating that this group is very likely the main consumer of the aromatics in the crude oil. The yet uncultivated LCA2-group was targeted by probe LCA2-63. As *Desulfobacula*, LCA2 cell numbers strongly increased in SOFT sediments at 3 cm depth by an order of magnitude compared with numbers in initial sediment to 5.5×10^7 cells ml⁻¹ sediment corresponding to 6% of total cells (Figure 4C). In initial sediments, LCA2 cell numbers accounted for 1-2% of total cells. SRB of LCA2 had been identified by stable isotope-probing as key players for

long-chain alkane-degradation at marine seeps (Kleindienst *et al.*, 2014). The incubation was done with *n*-dodecane as a representative substrate for long-chain alkanes. SRB of LCA2 are likely primary responsible for the consumption of long-chain alkanes in the 2-6 cm depth layers in SOFT core. In these layers, concentrations of C₁₂-C₂₆ alkanes dropped to about 20-25% (Mishra *et al.*, this issue).

The short-chain alkane-degrading group SCA1 was targeted by probes SCA1-212a and SCA1-212b. SCA1 cell numbers were comparably low for all initial and SOFT sediment layers except for 0-3 cm depth in which SCA1 cells were in the SOFT sediment 3-5fold higher than in initial sediments with 2-3 x 10⁷ cells ml⁻¹ sediment corresponding to 2% of total cells (Figure 4D). Isolated or enriched members of SCA, for example strain BuS5, Butane12_GMe, propane12_GMe, and Butane12_HR, use propane or butane as carbon source. Available propane and butane was completely consumed, likely by SCA1 and maybe others (for example, the C₂-C₄ alkane degrading group; Adams *et al.*, 2013), coinciding with the highest sulfate reduction activity measured (Figure 4).

Clade Cyhx was targeted by a mixtures of probe Cyhx28_EdB_152 (Jaekel *et al.*, 2015) and probe Cyhx28_EdB_152b that has been designed in this study to adapt it to our sequences. In the SOFT core zone of sulfate reduction, representatives of this group were detected by CARD-FISH in numbers of up to 0.9 x 10⁷ cells ml⁻¹ sediment (1% of total cells, Figure 4E). In initial sediments, however, members of clade Cyhx were close to detection limit of ≤0.5% of total cells in all layers. SRB of this clade were shown to grow on cyclohexane, but also able to use other cyclic alkanes as well as *n*-pentane and *n*-hexane (Jaekel *et al.*, 2015).

Methanogenic hydrocarbon degradation as response to simulated oil seepage

Methanogenesis was identified as important process in the anaerobic degradation of hydrocarbons during simulated oil seepage in Caspian Sea sediments. The δ¹³C signal of produced methane showed a decrease from -33.7‰ to -49.5‰ after 190 days of oil seepage indicating biogenic methane formation (Mishra *et al.*, this issue). Furthermore, the high methane concentrations in the deep SOFT core layers coincided with a decrease in higher hydrocarbons also supporting methanogenic hydrocarbon degradation. The mechanism driving alkane (mainly hexane) or aromatics degradation under methanogenic

condition is not elucidated yet. It supposedly requires the interaction of syntrophic bacteria, such as members of the family Syntrophaceae (*Syntrophus* spp., *Smithella* spp.) or of the order Clostridiales (*Desulfotomaculum* spp.), with methanogenic archaea (Zengler *et al.*, 1999; Siddique *et al.*, 2012). For example, *Methanosaeta* spp. and *Methanoculleus* spp. have been repeatedly detected in methanogenic hydrocarbon-degrading enrichment cultures (Siddique *et al.*, 2006; Siddique *et al.*, 2011; Cheng *et al.*, 2013). For in situ identification and quantification of methanogens in the SOFT core methanogenic zone we applied CARD-FISH using probe MS1414 targeting *Methanosarcina*, *Methanococcoides*, *Methanohalophilus* and *Methanolobus*. Cell numbers were highest with 5.7×10^6 cells ml⁻¹ (2% of total cells) at the depth of 9 cm (Figure 4F) where maximum methane increase was observed. Although hydrocarbon-degradation by *Methanosarcina* spp., which are the dominant methanogens in this study, has not yet been reported yet, and although detected *Methanosarcina* cells were not physically attached to any other cell we hypothesize a contribution to observed methanogenic hydrocarbon-degradation due to their specific increase in cell numbers in the methanogenic zone. The well-known bacterial partners such as *Syntrophus* or *Desulfotomaculum* were absent from the dataset. Only rarely, *Smithella* sequences (n=2 at 13 cm depth) were found. Syntrophic growth of *Methanosarcina* has been described for an association with *Geobacter* spp. and depends on interspecies electron transfer (Rotaru *et al.*, 2014), thus also allowing the speculation about hydrocarbon-degradation with a yet unknown bacterial partner.

Anaerobic alkane-degrading community based on masD gene diversity

To assess the microbial community activating alkanes by fumarate addition, *masD* gene libraries were constructed for SOFT core layers showing the highest sulfate reduction activity (0 – 8 cm; Mishra *et al.*, this issue). Benzylsuccinate synthases (Bss) that activate aromatic compounds are not targeted by the used primer pair. A total of 16 species-level OTU_{0.96} (based on 96% amino-acid identity, Stagars *et al.*, in press) were observed after sequencing of 717 *masD* (Table 1) from the four selected SOFT core layers. From initial sediments, *masD* could not be amplified. With inverse Simpson values of close to 1 (1.0 to 2.3), MasD-carrying community was extremely low. Library coverage was >96.8% for all

samples. The MasD-community diversity in Caspian Sea SOFT core sediments was even lower than that recently reported by Stagars *et al.* (in press) who found inverse Simpson values of 3 to 9 for 12 other hydrocarbon seep sites.

The major part of sequences (81%) fell into cluster Ic (Figure 5). They were most similar to environmental clones from oil reservoirs and crude oil polluted sediments (Bian *et al.*, 2015) or from enrichments with *n*-butane (Kleindienst *et al.*, 2014). Cluster Ic comprises *Desulfoglaeba alkanexedens* that covers the largest yet known substrate range of alkane degraders, using *n*-alkanes of chain-length C₆ to C₁₂ (Davidova and Suflita, 2005).

Another 17% of MasD sequences fell into cluster IIIa. This cluster also contains the propane- and butane-degrading strain BuS5, however, the most abundant OTU_{0.96} was only distantly related with 57% sequence identity. Most likely this is caused by substantial primer mispairing: The forward primers had 11 (7757f1-f2, 22mer) and 13 (7766f, 23mer) mismatches, respectively, to the BuS5-*masD* sequence retrieved from the genome (JGI gene ID 2513990058). None of the obtained MasD sequences were closely associated with the betaproteobacterial *Azoarcus* sp. and *Aromatoleum* sp.

Two MasD OTU_{0.96}, i.e. OTU1 and OTU2, contained 97% (571 sequences and 122 sequences) of all retrieved MasD sequences pointing to the presence of few abundant taxa, which are responsible for degradation of the major part of alkanes in Caspian Sea SOFT sediments. This supports the recent findings by Stagars *et al.* (in press) who detected a total of 420 MasD-carrying species in 12 different hydrocarbon seep environments of which only few were abundant, cosmopolitan alkane degraders but many were specialized taxa across many different environments. It also matches our findings that short-chain alkane-degrading group SCA1 and long-chain alkane-degrading group LCA2 were the only taxa identified which responded to simulated oil seepage by an increase of their cell numbers suggesting that we likely have identified the key alkane-degrading SRB in Caspian Sea sediments.

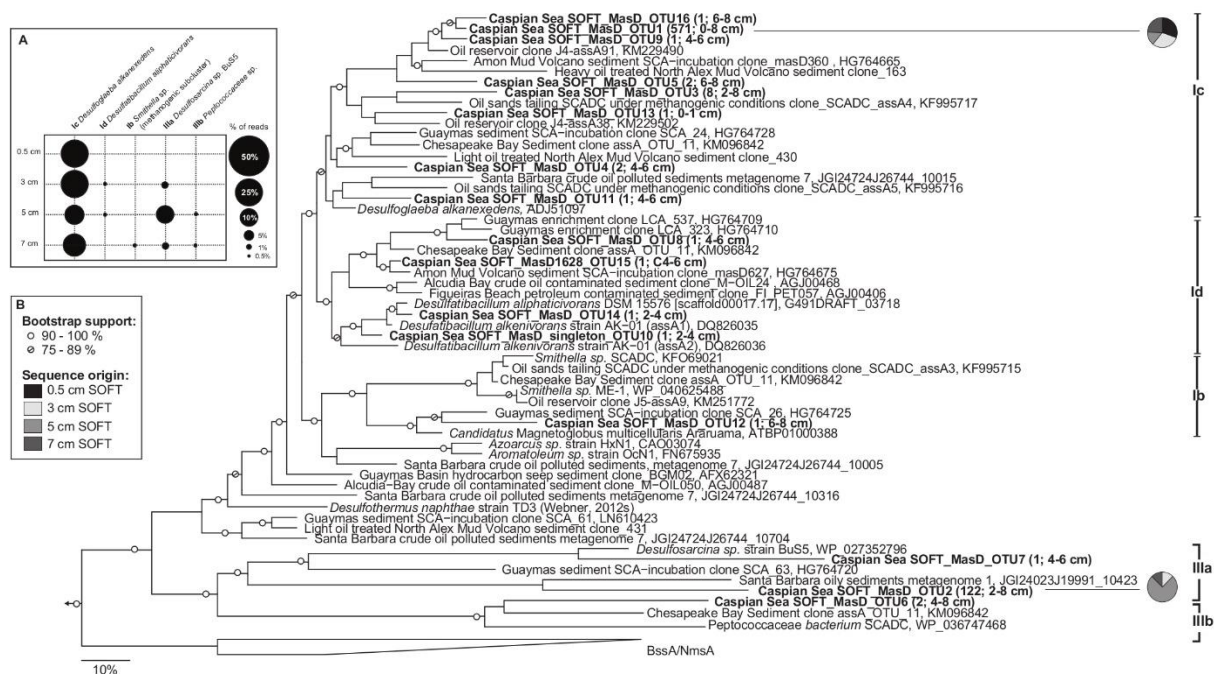

Figure 5: Phylogenetic tree showing the affiliation of retrieved SOFT core amino acid deduced MasD OTU_{0.96} (printed in bold) to selected reference sequences. The tree was calculated using the maximum likelihood algorithm (PhyML) considering 126 amino acid positions. Pyruvate formate lyase (PFL) was used as outgroup. OTU abundance and sediment depth are indicated in parenthesis. The scale bar gives 10% estimated sequence divergence.

Abbreviations: Ass = alkylsuccinate synthase, Mas = 1-methyl alkyl succinate synthase, Bss = benzylsuccinate synthase, Nms = naphthyl-methylsuccinate synthase. Panel A: MasD community structure in different sediment layers. The size of each dot indicates the percentage of identified MasD sequences within particular taxonomic groups (according to Stagars et al., *in press*). Panel B: legend for bootstrap support (1000 bootstrap replicates and blom62) and for pie charts shown next to the two most abundant OTU_{0.96}.

Conclusion

By molecular comparison of microbial communities in Caspian Sea sediments before and after controlled oil seepage, specific SRB and methanogenic archaea were identified who are likely responsible for the observed decrease in aliphatic hydrocarbon concentration. Although no aliphatic hydrocarbons could be detected in initial Caspian Sea sediment, this study demonstrates the intrinsic potential for alkane degradation in the microbial community most likely due to a history of nearby hydrocarbon seepage. This study further shows that identified SRB, such as SCA1, LCA2, *Desulfobacula*, and cycloalkane-degraders, are responsible for hydrocarbon degradation under close-to-in situ conditions. For some

groups cultivation has already been successful (BuS5, (Kniemeyer *et al.*, 2007); *Desulfobacula* (Rabus *et al.*, 1993; Heider *et al.*, 1998), and others have been enriched (clade Cyhx). For the LCA2 group isolation should be aimed for to get a deeper understanding of the ecophysiology of this clade of hydrocarbon-degrading bacteria.

Similar to aerobic hydrocarbon degradation in the water column, for example after the *Deepwater Horizon* accident, where gammaproteobacterial *Oceaniserpentilla*, *Colwellia* or *Cycloclasticus* dominated in the hydrocarbon plume (Kleindienst *et al.*, 2015), the major part of anaerobic hydrocarbon degradation is mediated by few groups of microbes specialized on the degradation of a specific hydrocarbon type: SCA1 is likely responsible for propane and butane degradation (maybe together with the C₂-C₄ short-chain alkane-degrading group described by Adams *et al.*, 2013), LCA2 is responsible for mid- to long-chain alkane degradation, clade Cyhx for cycloalkanes, pentane and hexane, *Desulfobacula* and relatives are responsible for toluene and benzene degradation and archaea of the genus *Methanosarcina* might be responsible for syntrophic methanogenic long-chain alkane degradation.

Experimental procedures

Sampling site and SOFT system

The study site Baku Bay is located in the SW Caspian Sea near Baku, Azerbaijan (N 39 59.548, E 49 28.775, Figure S3). It is one of the most polluted areas in the Caspian Sea (Zonn, 2005). Several oil fields are located in this area, causing heavy pollution by extraction of oil and gas reserves in large scales, influencing the microbial community composition (Hassanshahian *et al.*, 2010; Hassanshahian *et al.*, 2012). Sediment cores (30 cm long, 6 cm in diameter) were collected from a coastal area (water depth ~ 60 cm) in November 2012. After collection, cores were directly sealed and stored at 10°C in the dark for 3 months until one core was processed as reference for t₀ (“initial sediment”). Afterwards, all cores were stored at 0°C for further 2.5 months until the start of the SOFT system (Mishra *et al.*, this issue). Storage at 0°C slows down any kind of microbial activity and therefore, we expect no change in biogeochemistry. Sediments were mostly sandy with porosity around 0.4.

Light crude oil for the SOFT experiment was provided by Dea Deutsche Erdoel AG and originated from the North Sea, Mittelplatte (sampled in February 2013). The experiment was stopped after incubation for 190 days at 16°C. Cores were sliced in one or two centimeter thick slices. DNA was extracted from initial sediment at t_0 and from SOFT core. Experimental set up was too complicate for replication, yet we consider adjacent layers as technical replicates. More details on the sampling procedure, the SOFT system setup, as well as sulfate, methane, and sulfate reduction determination are provided in Mishra *et al.* (this issue).

DNA extraction

DNA was extracted from 1 g sediment that had been frozen immediately after sampling with the UltraClean soil kit (MoBio) according to the manufacturer's protocol for maximum yields. Following modifications were implemented: Cell lysis was performed at the beginning by adding 0.02 mg ml⁻¹ proteinase K (Merck, Darmstadt, Germany) to the sample and incubating for 50 min at 37 °C with moderate shaking. Besides that, a second round of extraction by a repetitive beat beating step was done. Therefore, the processed sediments were added to the bead-containing tubes and mixed with 60 µl of solution 1 and 200 µl of the MoBio inhibitor removal solution (IRS). The manufacturer's protocol was then followed and ended by a final elution with 50 µl EB Buffer.

Sequencing of 16S rRNA genes.

Bacterial 16S rRNA genes were amplified with the primer pair Bakt_341F (5'- CCTACGGGNGGCWGCAG- 3') / Bakt_785R (5'- GACTACHVGGGTATCTAATCC- 3') (Herlemann *et al.*, 2011). Primers were barcoded and extended with a SfiI restriction site at the 5' end for ligation with the 454-adapters. For each sample, 8 replicate PCR reactions (20 µl volume) per primer pair were carried out containing each 0.5 µM primer each, 250 µM dNTPs, 0.3 µg/µl BSA, 1 × PCR buffer, 0.25 U Taq polymerase (5Prime, Germany), 10 – 25 ng template under the following conditions: initial denaturation at 95°C for 5 min, followed by 35 cycles of denaturation (96°C, 1 min), annealing (58°C, 1 min), elongation (72°C, 2 min), and a final elongation step (72°C, 10 min). The replicate PCR reactions were pooled, 500 bp-amplicons extracted from an agarose gel (1.5% w/v) and purified using the

MinElute PCR Purification Kit (Qiagen) according to the manufacturer's recommendations. Massive parallel tag sequencing of the amplicons was carried out on a 454 Life Sciences GS FLX sequencer (Roche, Basel, Switzerland) at the Sequencing Research Center, Cologne, Germany. The raw reads were submitted to a rigorous quality control procedure using a mothur version 1.32.1 routine (Schloss *et al.*, 2009) including trimming and quality filtering of the reads.

Archaeal 16S rRNA genes were amplified with primers Arch20F (5' - TTC CGG TTG ATC CYG CCR G- 3') (Massana *et al.*, 1997) / Arch519R (5' - GGTDTTACCGCGGCKGCTG- 3') (Sørensen and Teske, 2006). Primers were barcoded with the Ion Xpress barcodes and extended for ligation with Ion A and Ion truncated P1 adapters at the 5' end. For each sample PCRs (50 µl volume) were carried out containing 0.5 µM primer each, 250 µM dNTPs, 0.3 µg/µl BSA, 1 × PCR buffer, 0.25 U Taq polymerase (5Prime, Germany), about 20 ng template under the following conditions: initial denaturation at 95°C for 5 min, followed by 30 cycles of denaturation (94°C, 1 min), annealing (58°C, 1 min), elongation (72°C, 3 min), and a final elongation step (72°C, 10 min). The reactions were separated on an E-Gel Size Selection Gel (Invitrogen) and the 500 bp-amplicon extracted following the manufacturer's protocol. Then, the PCR product was purified using the MinElute PCR Purification Kit (Qiagen) according to the manufacturer's recommendations. Sequencing of an equimolar pool of different amplicon libraries was carried out on the Ion Torrent Personal Genome Machine (PGM) system using the Ion PGM™ Sequencing 400 Kit (both Life Technologies) following the corresponding protocol (Ion 314™ Chip v2). The raw reads were submitted to a rigorous quality control procedure using BaseCaller V4.2 default parameters including trimming and quality filtering of the reads with some modifications (trim-qual-cutoff = 15; trim-qual-window-size = 20).

The bacterial and archaeal quality reads were clustered at 94.5% sequence identity and taxonomically assigned using the SILVA NGS pipeline with the ARB SILVA taxonomy database SILVA NR v119.1 (Quast *et al.*, 2013).

Raw reads were deposited at the EBI Short Read Archive (SRA) and can be accessed under the study accession number xxxxx.

MasD amplification, cloning and sequencing

The delta subunit of the 1-methyl alkyl succinate synthase gene (*masD*) was amplified using the primer pair 7757f-1,f-2 (*MasD* amino acid position 395 in strain HxN1; accession number CA003074) / 8543r (position 657 in HxN1) or primer pair 7766f (position 398 in HxN1) / 8543r (von Netzer *et al.*, 2013). For each sample, 8 replicate PCRs (20 µl volume) per primer pair were carried out containing, 1 µM primer each, 250 µM dNTPs, 0.3 µg/µl BSA, 1 × PCR buffer, 0.25 U Taq polymerase (5Prime, Germany) under the following conditions: initial denaturation at 95°C for 5 min, followed by 35 cycles of denaturation (96°C, 1 min), annealing (58°C, 1 min), elongation (72°C, 2 min), and a final elongation step (72°C, 10 min). All replicate PCR reactions per sample were pooled, precipitated with ethanol, the 800 bp-amplicons were extracted from an agarose gel (1.5% w/v) and purified using the MiniElute PCR Purification Kit (Qiagen) according to the manufacturer's recommendations. Cloning, Sanger sequencing, and sequence processing was done as described in Stagars *et al.* (in press). *MasD* amino acid sequences were clustered at 96% sequence similarity (*MasD* species-level cutoff (Stagars *et al.*, in press)).

MasD sequences reported here have been deposited in the EMBL, GenBank, and DDBJ nucleotide sequence database under accession numbers xxxxxx.

Phylogenetic analysis

The 16S rRNA-based phylogenetic tree was calculated in ARB with nearly full-length sequences (>1300 bp) by neighbor joining and maximum likelihood analysis in combination with filters which consider only 50% conserved regions of the 16S rRNA. Partial sequences were subsequently inserted into the reconstructed consensus tree by parsimony criteria, without allowing changes in the overall tree topology. For *MasD*, 831 deduced amino acid sequences were used for tree calculation using maximum likelihood (PhyML algorithm, Blossum 62 substitution model) considering 126 amino acid positions (433 to 559, strain HxN1). Only one representative sequence per OTU_{0.96} is shown in the final tree.

Diversity analysis

The subsampled sequence abundance tables were used to calculate Inverse Simpson diversity indices and Chao1 richness using mothur v1.32.1 (Schloss *et al.*, 2009). Dissimilarities (Chao, 1984; Hill *et al.*, 2003) between all samples were calculated using the Bray-Curtis dissimilarity coefficient (i.e. relative sequence abundance, Bray and Curtis, 1957). The resulting beta-diversity matrices were used for 3-dimensional non metric multidimensional scaling (NMDS) ordinations (Kruskal, 1964). Stress values below 0.2 indicate that the multidimensional dataset is well represented by the 3D ordination. To test whether the inclusion of singletons affected further statistical tests we generated NMDS ordinations with and without rare biosphere (OTU comprising <0.01% of total sequences) and compared them using Procrustes correlation analysis (Gower, 1975). Procrustes correlation was highly significant (coefficient=0.935). Furthermore, to test the effect of subsampling we generated NMDS ordinations using all obtained OTUs and OTUs after subsampling. Procrustes correlation was 0.911. Neither subsampling nor the presence of rare biosphere OTUs did affect the overall trend. Thus we decided to include all data in our analyses, to be able to identify types of microorganisms which can switch from rare to dominant modes of distribution. Taxa that were shared between initial and SOFT sediments or between layers were calculated using the Jaccard dissimilarity coefficient (i.e. presences/absence). Constrained correspondence analysis (CCA) was carried out to evaluate the combined effects of sulfate, methane, and sulfate reduction rates on the microbial community composition. The significance of these effects was assessed by analysis of similarity (ANOSIM).

Catalyzed reporter deposition fluorescence in situ hybridization (CARD-FISH)

Sediment samples have been fixed in 3% formaldehyde for three hours at 4°C, washed with 1x PBS and stored in ethanol-PBS (1:1) at -20°C. Samples were diluted, four times ultrasonicated on ice at 20% intensity, 20 cycles, 30 seconds (Bandelin Sonopuls HD200), and filtered on a 0.22 µm pore size polycarbonate filter. *In situ* hybridizations with horseradish peroxidase (HRP)-labeled probes followed by fluorescently labeled tyramide signal amplification (catalyzed reporter deposition) were carried out as described previously (Pernthaler *et al.*, 2002). Permeabilization was performed by lysozyme treatment (10 mg ml⁻¹) for 60 min at 37°C. Hybridization was done at 46 °C. Hybridized

samples were analyzed with an epifluorescence microscope (Nikon Eclipse 50i). For each probe and sample, >1000 DAPI stained cells and their corresponding FISH signals were counted. Used probes (ordered from biomers.net; Ulm, Germany) and formamide concentrations are given in Table S2.

Acknowledgements

The Geological Institute of Azerbaijan is thanked for their collaboration as well as M. Schmidt and P. Feldens for their support during the field sampling. P. Steeb is acknowledged for advising the development of the SOFT system. We would also like to thank the Technical and Logistic Center (TLZ) of GEOMAR for their technical support in building the SOFT system, especially D. Wehrend, A. Petersen and S. Sturm. We also thank B. Domeyer, A. Bleyer and R. Suberg for their support in geochemical analyses and S. Bold and D. Ozod-Seradj for helping during the termination of the SOFT experiment. We thank G. Reintjes for IonTorrent sequencing of archaeal 16S rRNA genes. K. Büttner is acknowledged for excellent technical assistance. This work was funded by the Deutsche Forschungsgemeinschaft (SPP1319) and DEA Deutsche Erdöl AG. Further support was provided by the Max Planck Society, Germany.

References

- Acosta-González, A., Rosselló-Móra, R., and Marqués, S. (2013) Characterization of the anaerobic microbial community in oil-polluted subtidal sediments: aromatic biodegradation potential after the Prestige oil spill. *Environ Microbiol* 15: 77-92.
- Adams, M.M., Hoarfrost, A.L., Bose, A., Joye, S.B., and Girguis, P.R. (2013) Anaerobic oxidation of short-chain alkanes in hydrothermal sediments: potential influences on sulfur cycling and microbial diversity. *Front Microbiol* 4: 110.
- Aeckersberg, F., Bak, F., and Widdel, F. (1991) Anaerobic oxidation of saturated-hydrocarbons to CO₂ by a new type of sulfate-reducing bacterium. *Arch Microbiol* 156: 5-14.
- Atlas, R.M. (1981) Microbial degradation of petroleum hydrocarbons: an environmental perspective. *Microbiol Rev* 45: 180-209.
- Atlas, R.M., and Hazen, T.C. (2011) Oil biodegradation and bioremediation: A tale of the two worst spills in U.S. history. *Environ Sci Technol* 45: 6709-6715.
- Berdugo-Clavijo, C., and Gieg, L.M. (2014) Conversion of crude oil to methane by a microbial consortium enriched from oil reservoir production waters. *Front Microbiol* 5: 197.
- Bian, X.-Y., Maurice Mbadinga, S., Liu, Y.-F., Yang, S.-Z., Liu, J.-F., Ye, R.-Q. *et al.* (2015) Insights into the anaerobic biodegradation pathway of *n*-alkanes in oil reservoirs by detection of signature metabolites. *Sci Rep* 5.
- Bray, J.R., and Curtis, J.T. (1957) An Ordination of the upland forest communities of Southern Wisconsin. *Ecol Monogr* 27: 325-349.
- Callaghan, A.V. (2013a) Enzymes involved in the anaerobic oxidation of *n*-alkanes: from methane to long-chain paraffins. *Front Microbiol* 4: 89.
- Callaghan, A.V. (2013b) Metabolomic investigations of anaerobic hydrocarbon-impacted environments. *Curr Opin Biotechnol* 24: 506-515.

Callaghan, A.V., Wawrik, B., Ní Chadhain, S.M., Young, L.Y., and Zylstra, G.J. (2008) Anaerobic alkane-degrading strain AK-01 contains two alkylsuccinate synthase genes. *Biochem Biophys Res Commun* 366: 142-148.

Chang, Y.T., Lee, J.F., Chao, H.P., and Liao, W.L. (2006) Bacterial community changes with N,N-dimethylformamide (DMF) additives during polycyclic aromatic hydrocarbons (PAH) biodegradation. *Environ Technol* 27: 1-14.

Chao, A. (1984) Nonparametric estimation of the number of classes in a population. *Scandinavian Journal of Statistics* 11: 265-270.

Cheng, L., Rui, J., Li, Q., Zhang, H., and Lu, Y. (2013) Enrichment and dynamics of novel syntrophs in a methanogenic hexadecane-degrading culture from a Chinese oilfield. *FEMS Microbiol Ecol* 83: 757-766.

Davidova, I.A., and Suflita, J.M. (2005) Enrichment and isolation of anaerobic hydrocarbon-degrading bacteria. *Environ Microbiol* 397: 17-34.

Dubinsky, E.A., Conrad, M.E., Chakraborty, R., Bill, M., Borglin, S.E., Hollibaugh, J.T. *et al.* (2013) Succession of hydrocarbon-degrading bacteria in the aftermath of the Deepwater Horizon oil spill in the Gulf of Mexico. *Environ Sci Technol* 47: 10860-10867.

Dumont, H.J. (1998) The Caspian lake: history, biota, structure, and function. *Limnol Oceanogr* 43: 44-52.

Dyksma, S., Bischof, K., Fuchs, B.M., Hoffmann, K., Meier, D., Meyerdierks, A. *et al.* (in press) Ubiquitous Gammaproteobacteria dominate dark carbon fixation in coastal sediments. *ISME J.*

Dyksterhouse, S.E., Gray, J.P., Herwig, R.P., Lara, J.C., and Staley, J.T. (1995) *Cycloclasticus pugetii* gen. nov, sp. nov., an aromatic hydrocarbon-degrading bacterium from marine sediments. *Int J Syst Bacteriol* 45: 116-123.

Embree, M., Nagarajan, H., Movahedi, N., Chitsaz, H., and Zengler, K. (2014) Single-cell genome and metatranscriptome sequencing reveal metabolic interactions of an alkane-degrading methanogenic community. *ISME J* 8: 757-767.

Ferrer, M., Guazzaroni, M.-E., Richter, M., García-Salamanca, A., Yarza, P., Suárez-Suárez, A. *et al.* (2011) Taxonomic and functional metagenomic profiling of the microbial community in the anoxic sediment of a sub-saline shallow lake (Laguna de Carrizo, central Spain). *Microb Ecol* 62: 824-837.

Gower, J.C. (1975) Generalized procrustes analysis. *Psychometrika* 40: 33-51.

Grossi, V., Cravo-Laureau, C., Guyoneaud, R., Ranchou-Peyruse, A., and Hirschler-Rea, A. (2008) Metabolism of n-alkanes and n-alkeries by anaerobic bacteria: A summary. *Org Geochem* 39: 1197-1203.

Grundmann, O., Behrends, A., Rabus, R., Amann, J., Halder, T., Heider, J., and Widdel, F. (2008) Genes encoding the candidate enzyme for anaerobic activation of n-alkanes in the denitrifying bacterium, strain HxN1. *Environ Microbiol* 10: 376-385.

Hassanshahian, M., Emtiazi, G., and Cappello, S. (2012) Isolation and characterization of crude-oil-degrading bacteria from the Persian Gulf and the Caspian Sea. *Mar Pollut Bull* 64: 7-12.

Hassanshahian, M., Emtiazi, G., Kermanshahi, R.K., and Cappello, S. (2010) Comparison of oil degrading microbial communities in sediments from the Persian Gulf and Caspian Sea. *Soil & Sediment Contamination* 19: 277-291.

Head, I.M., Jones, D.M., and Larter, S.R. (2003) Biological activity in the deep subsurface and the origin of heavy oil. *Nature* 426: 344-352.

Heider, J., and Schühle, K. (2013) Anaerobic biodegradation of hydrocarbons including methane. In *The Prokaryotes*. Rosenberg, E., DeLong, E.F., Lory, S., Stackebrandt, E., and Thompson, F. (eds): Springer Berlin Heidelberg, pp. 605-634.

Heider, J., Spormann, A.M., Beller, H.R., and Widdel, F. (1998) Anaerobic bacterial metabolism of hydrocarbons. *FEMS Microbiol Rev* 22: 459-473.

Herlemann, D.P.R., Labrenz, M., Jurgens, K., Bertilsson, S., Waniek, J.J., and Andersson, A.F. (2011) Transitions in bacterial communities along the 2000 km salinity gradient of the Baltic Sea. *ISME J* 5: 1571-1579.

Hill, T.C.J., Walsh, K.A., Harris, J.A., and Moffett, B.F. (2003) Using ecological diversity measures with bacterial communities. *FEMS Microbiol Ecol* 43: 1-11.

Jaekel, U., Zedelius, J., Wilkes, H., and Musat, F. (2015) Anaerobic degradation of cyclohexane by sulfate-reducing bacteria from hydrocarbon-contaminated marine sediments. *Front Microbiol* 6: 116.

Jaekel, U., Musat, N., Adam, B., Kuypers, M., Grundmann, O., and Musat, F. (2012) Anaerobic degradation of propane and butane by sulfate-reducing bacteria enriched from marine hydrocarbon cold seeps. *ISME J* 7: 885-895.

Jones, D.M., Head, I.M., Gray, N.D., Adams, J.J., Rowan, A.K., Aitken, C.M. *et al.* (2008) Crude-oil biodegradation via methanogenesis in subsurface petroleum reservoirs. *Nature* 451: 176-180.

Kim, S.-J., and Kwon, K. (2010) Marine, hydrocarbon-degrading Alphaproteobacteria. In *Handbook of Hydrocarbon and Lipid Microbiology*. Timmis, K.N., McGenity, T., van der Meer, J.R., and de Lorenzo, V. (eds): Springer Berlin Heidelberg, pp. 1707-1714.

Kimes, N.E., Callaghan, A.V., Suflita, J.M., and Morris, P.J. (2014) Microbial transformation of the Deepwater Horizon oil spill – past, present, and future perspectives. *Front Microbiol* 5: 603.

Kimes, N.E., Callaghan, A.V., Aktas, D.F., Smith, W.L., Sunner, J., Golding, B.T. *et al.* (2013) Metagenomic analysis and metabolite profiling of deep-sea sediments from the Gulf of Mexico following the Deepwater Horizon oil spill. *Front Microbiol* 4: 50.

Kleindienst, S., Grim, S., Sogin, M., Bracco, A., Crespo-Medina, M., and Joye, S.B. (2015) Diverse, rare microbial taxa responded to the *Deepwater Horizon* deep-sea hydrocarbon plume. *ISME J*.

Kleindienst, S., Herbst, F.-A., Stagars, M., von Netzer, F., von Bergen, M., Seifert, J. *et al.* (2014) Diverse sulfate-reducing bacteria of the *Desulfosarcina/Desulfococcus* clade are the key alkane degraders at marine seeps. *ISME J* 8: 2029-2044.

Kniemeyer, O., Musat, F., Sievert, S.M., Knittel, K., Wilkes, H., Blumenberg, M. *et al.* (2007) Anaerobic oxidation of short-chain hydrocarbons by marine sulphate-reducing bacteria. *Nature* 449: 898-910.

Knittel, K., Boetius, A., Lemke, A., Eilers, H., Lochte, K., Pfannkuche, O. *et al.* (2003) Activity, distribution, and diversity of sulfate reducers and other bacteria in sediments above gas hydrate (Cascadia margin, Oregon). *Geomicrobiol J* 20: 269-294.

Könneke, M., Schubert, D.M., Brown, P.C., Hügler, M., Standfest, S., Schwander, T. *et al.* (2014) Ammonia-oxidizing archaea use the most energy-efficient aerobic pathway for CO₂ fixation. *Proc Natl Acad Sci USA* 111: 8239-8244.

Kosarev, A.N. (2005) The Caspian Sea environment: physico-geographical conditions of the Caspian Sea. In *Hdb Env Chem*: Springer, pp. 5-31.

Kruskal, J.B. (1964) Nonmetric multidimensional scaling: a numerical method. *Psychometrika* 29: 115-129.

Leahy, J.G., and Colwell, R.R. (1990) Microbial degradation of hydrocarbons in the environment. *Microbiol Rev* 54: 305-315.

Leroy, S.A.G., Marret, F., Gibert, E., Chalief, F., Reyss, J.-L., and Arpe, K. (2007) River inflow and salinity changes in the Caspian Sea during the last 5500 years. *Quat Sci Rev* 26: 3359-3383.

Mahmoudi, N., Robeson, M.S., Castro, H.F., Fortney, J.L., Techtmann, S.M., Joyner, D.C. *et al.* (2015) Microbial community composition and diversity in Caspian Sea sediments. *FEMS Microbiol Ecol* 91: 1-11.

Massana, R., Murray, A.E., Preston, C.M., and DeLong, E.F. (1997) Vertical distribution and phylogenetic characterization of marine planktonic archaea in the Santa Barbara Channel. *Appl Environ Microbiol* 63: 50-56.

Mbadinga, S.M., Wang, L.-Y., Zhou, L., Liu, J.-F., Gu, J.-D., and Mu, B.-Z. (2011) Microbial communities involved in anaerobic degradation of alkanes. *Int Biodeteri & Biodegr* 65: 1-13.

Mbadinga, S.M., Li, K.P., Zhou, L., Wang, L.Y., Yang, S.Z., Liu, J.F. *et al.* (2012) Analysis of alkane-dependent methanogenic community derived from production water of a high-temperature petroleum reservoir. *Appl Microbiol Biotechnol* 96: 531-542.

Millero, F.J., and Chetirkin, P.V. (1980) The density of Caspian Sea waters. *Deep Sea Research Part A Oceanographic Research Papers* 27: 265-271.

Morasch, B., Schink, B., Tebbe, C.C., and Meckenstock, R.U. (2004) Degradation of o-xylene and m-xylene by a novel sulfate-reducer belonging to the genus *Desulfotomaculum*. *Arch Microbiol* 181: 407-417.

Mußmann, M., Dyksma, S., Probandt, D., Virant, D., Ovanesov, K., and Littmann, S. (2015) Ecology and ecogenomics of uncultured sulfate-reducing bacteria ubiquitous and abundant in marine sediments. In *EMBO Workshop on Microbial Sulfur Metabolism*. Helsingor, Denmark.

Myhr, S., Lillebo, B.L.P., Sunde, E., Beeder, J., and Torsvik, T. (2002) Inhibition of microbial H₂S production in an oil reservoir model column by nitrate injection. *Appl Microbiol Biotechnol* 58: 400-408.

Pernthaler, A., Pernthaler, J., and Amann, R. (2002) Fluorescence in situ hybridization and catalyzed reporter deposition for the identification of marine bacteria. *Appl Environ Microbiol* 68: 3094-3101.

Quast, C., Pruesse, E., Yilmaz, P., Gerken, J., Schweer, T., Yarza, P. *et al.* (2013) The SILVA ribosomal RNA gene database project: improved data processing and web-based tools. *Nucleic Acids Res* 41: D590-D596.

Rabus, R., Nordhaus, R., Ludwig, W., and Widdel, F. (1993) Complete oxidation of toluene under strictly anoxic conditions by a new sulfate-reducing bacterium. *Appl Environ Microbiol* 59: 1444-1451.

Ravenschlag, K., Sahm, K., Pernthaler, J., and Amann, R. (1999) High bacterial diversity in permanently cold marine sediments. *Appl Environ Microbiol* 65: 3982-3989.

Redmond, M.C., and Valentine, D.L. (2012) Natural gas and temperature structured a microbial community response to the Deepwater Horizon oil spill. *Proc Natl Acad Sci USA* 109: 20292-20297.

Rotaru, A.-E., Shrestha, P.M., Liu, F., Markovaite, B., Chen, S., Nevin, K.P., and Lovley, D.R. (2014) Direct interspecies electron transfer between *Geobacter metallireducens* and *Methanosarcina barkeri*. *Appl Environ Microbiol* 80: 4599-4605.

Ruff, S.E., Biddle, J.F., Teske, A.P., Knittel, K., Boetius, A., and Ramette, A. (2015) Global dispersion and local diversification of the methane seep microbiome. *Proc Natl Acad Sci USA* 112: 4015-4020.

Saw, J.H., Spang, A., Zaremba-Niedzwiedzka, K., Juzokaite, L., Dodsworth, J.A., Murugapiran, S.K. *et al.* (2015) Exploring microbial dark matter to resolve the deep archaeal ancestry of eukaryotes. *Phil Trans R Soc B* 370.

Schloss, P.D., Westcott, S.L., Ryabin, T., Hall, J.R., Hartmann, M., Hollister, E.B. *et al.* (2009) Introducing mothur: Open-source, platform-independent, community-supported software for describing and comparing microbial communities. *Appl Environ Microbiol* 75: 7537-7541.

Schreiber, L., Holler, T., Knittel, K., Meyerdierks, A., and Amann, R. (2010) Identification of the dominant sulfate-reducing bacterial partner of anaerobic methanotrophs of the ANME-2 clade. *Environ Microbiol* 12: 2327-2340.

Siddique, T., Fedorak, P.M., and Foght, J.M. (2006) Biodegradation of short-chain n-alkanes in oil sands tailings under methanogenic conditions. *Environ Sci Technol* 40: 5459-5464.

Siddique, T., Penner, T., Semple, K., and Foght, J.M. (2011) Anaerobic biodegradation of longer-chain n-alkanes coupled to methane production in oil sands tailings. *Environ Sci Technol* 45: 5892-5899.

Siddique, T., Penner, T., Klassen, J., Nesbø, C., and Foght, J.M. (2012) Microbial Communities Involved in Methane Production from Hydrocarbons in Oil Sands Tailings. *Environ Sci Technol* 46: 9802-9810.

Sørensen, K.B., and Teske, A. (2006) Stratified communities of active archaea in deep marine subsurface sediments. *Appl Environ Microbiol* 72: 4596-4603.

Spormann, A.M., and Widdel, F. (2000) Metabolism of alkylbenzenes, alkanes, and other hydrocarbons in anaerobic bacteria. *Biodegradation* 11: 85-105.

Stagars, M., Ruff, E., Amann, R., and Knittel, K. (in press) High diversity of anaerobic alkane-degrading microbial communities in marine seep sediments based on their (1-methylalkyl)succinate synthase genes. *Front Microbiol*.

von Netzer, F., Pilloni, G., Kleindienst, S., Krüger, M., Knittel, K., Gründger, F., and Lueders, T. (2013) Enhanced gene detection assays for fumarate-adding enzymes allow uncovering of anaerobic hydrocarbon degraders in terrestrial and marine systems. *Appl Environ Microbiol* 79: 543-552.

Weelink, S.A.B., Van Doesburg, W., Saia, F.T., Rijpstra, W.I.C., Röling, W.F.M., Smidt, H., and Stams, A.J.M. (2009) A strictly anaerobic betaproteobacterium *Georgfuchsia toluolica* gen. nov., sp. nov. degrades aromatic compounds with Fe(III), Mn(IV) or nitrate as an electron acceptor. *FEMS Microbiol Ecol* 70: 575-585.

Widdel, F., Knittel, K., and Galushko, A. (2010) Anaerobic hydrocarbon-degrading microorganisms: an overview. In *Handbook of Hydrocarbon and Lipid Microbiology*. Timmis, K.N., McGenity, T., van der Meer, J.R., and de Lorenzo, V. (eds): Springer Berlin Heidelberg, pp. 1997-2021.

Zengler, K., Richnow, H.H., Rosselló-Móra, R., Michaelis, W., and Widdel, F. (1999) Methane formation from long-chain alkanes by anaerobic microorganisms. *Nature* 401: 266-269.

Zonn, I.S. (2005) The Caspian Sea environment. environmental issues of the Caspian. In *Hdb Env Chem*. Kostianoy, A.G., and Kosarev, A.N. (eds): Springer Berlin Heidelberg, pp. 223-242.

Supplementary for Chapter 5

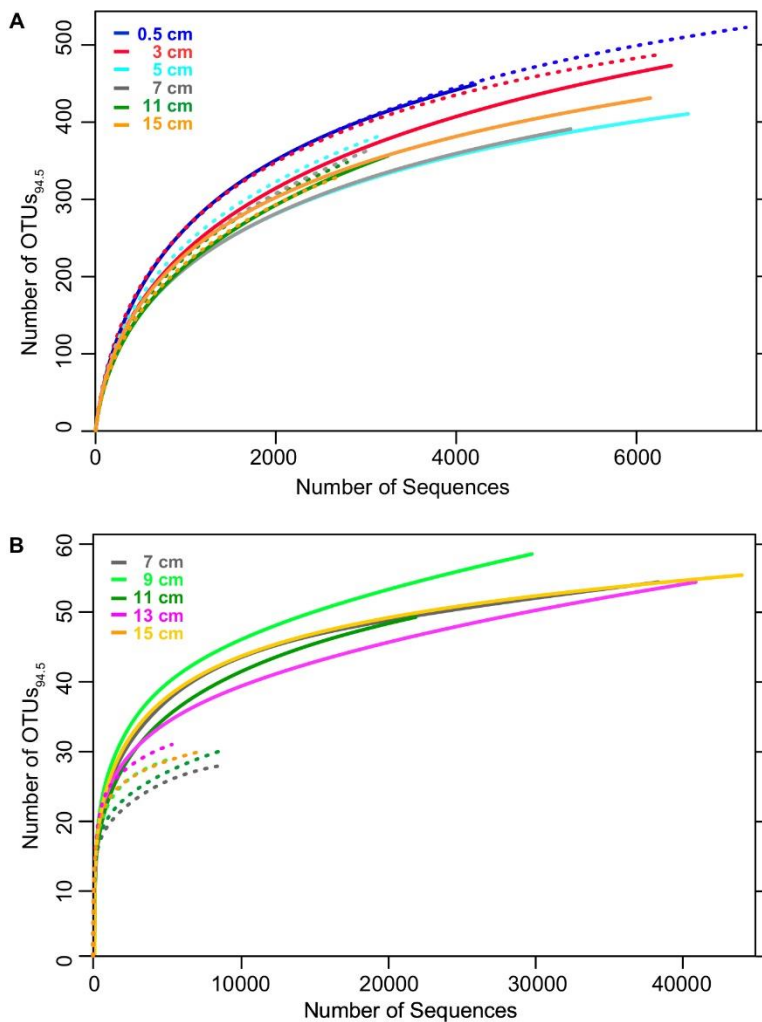

Figure S1. Rarefaction curves Rarefaction curves of A) bacterial 16S rRNA sequence and B) archaeal 16S rRNA gene sequences clustered at 94.5% identity in SOFT (solid lines) and initial (dashed lines) Caspian Sea sediment samples.

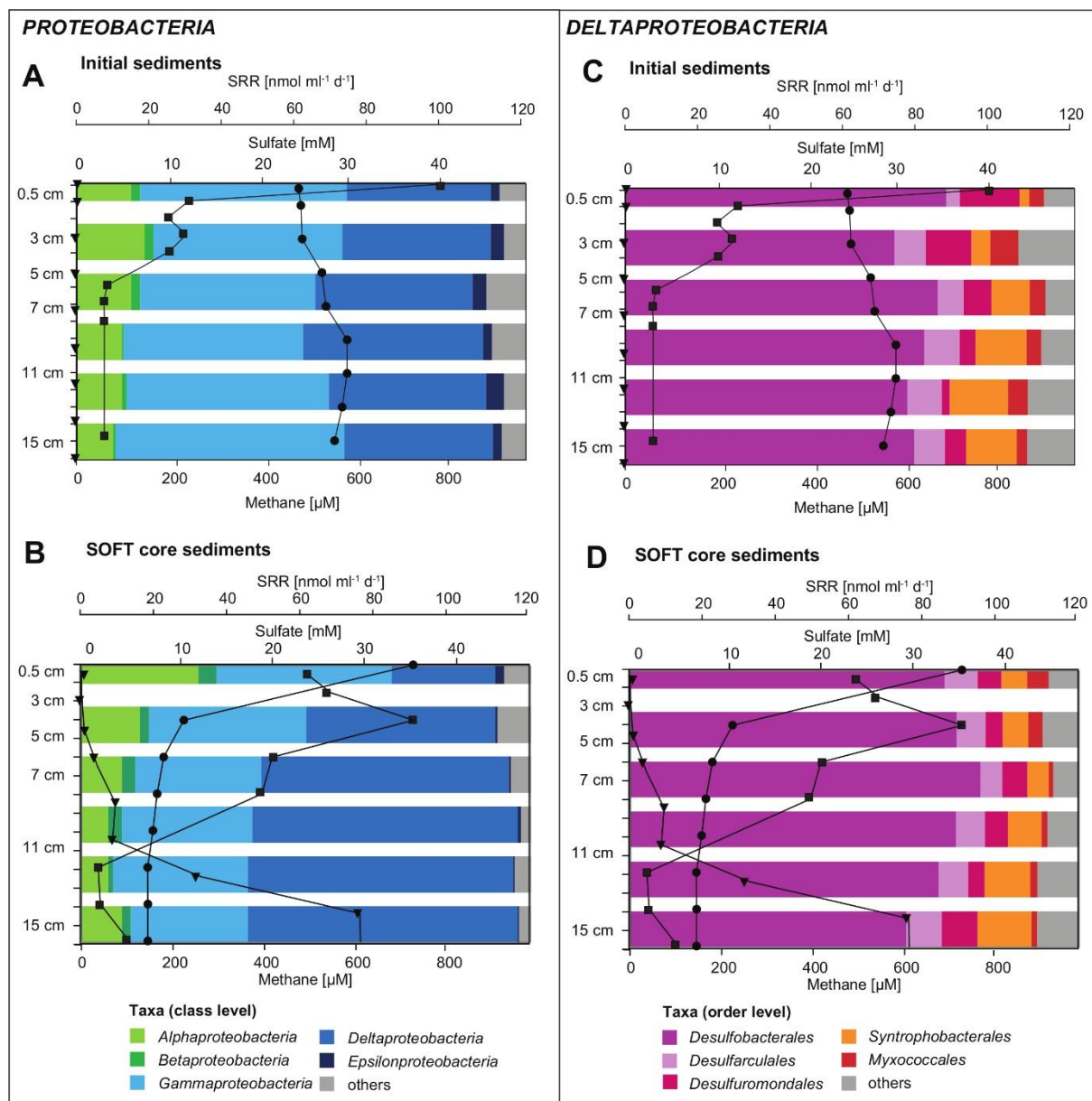

Figure S2. Community structure of (A, B) Proteobacteria and (C, D) Deltaproteobacteria in initial (A, C) and SOFT (B, D) sediments from Caspian Sea based on 16S rRNA gene sequencing. In overlay, depth profiles of methane, sulfate and sulfate reduction rate (SRR) are shown (data taken from Mishra et al., this issue).



Figure S3. Map of the Caspian Sea showing major oil fields (yellow dots) and the sampling site off-shore Baku (Azerbaijan; red asterix).

Table S1: Percentage of shared bacterial and archaeal OTU_{0.945} between groups of samples. Pairwise comparison of community similarity within groups of samples based on presence absence OTU_{0.945} of standardized data.

		<i>No. of samples</i>	<i>Max shared OTU_{0.945} (%)*</i>	<i>Mean shared OTU_{0.945} (%)*</i>	<i>Min shared OTU_{0.945} (%)*</i>
Bacteria	initial	6	97	56	32
	SOFT	5	96	54	31
	0 - 4 cm	3	75	71	70
	4 - 8 cm	4	75	63	54
	10 - 16 cm	4	75	67	57
Archaea	initial	5	83	58	39
	SOFT	5	80	60	38
	6 - 10 cm	5	79	61	41
	10 - 16 cm	5	74	65	45

Table S2: Percentage of shared bacterial and archaeal OTU_{0.945} between samples in different groups.

		<i>SOFT</i> <i>0 - 16 cm</i>	<i>initial</i> <i>4 - 8 cm</i>	<i>initial</i> <i>10 - 16 cm</i>	<i>SOFT</i> <i>0 - 4 cm</i>	<i>SOFT</i> <i>4 - 8 cm</i>	<i>SOFT</i> <i>10 - 16 cm</i>
Bacteria	initial 0 - 16 cm	43					
	initial 0 - 4 cm		36	31	56	38	42
	initial 4 - 8 cm			33	39	51	37
	initial 10 - 16 cm				33	36	61
	SOFT 0 - 4 cm					41	31
	SOFT 4 - 8 cm						35

		<i>SOFT</i> <i>6 - 16 cm</i>	<i>initial</i> <i>10 - 16 cm</i>	<i>SOFT</i> <i>6 - 10 cm</i>	<i>SOFT</i> <i>10 - 16 cm</i>
Archaea	initial 6 - 16 cm	23			
	initial 6 - 10 cm		21	59	18
	initial 10 - 16 cm			18	60
	SOFT 6 - 10 cm				19

* Pairwise comparison of community similarity within groups of samples based on presence absence OTU_{0.945} of standardized data (resampling without replacements of 2730 sequences for bacterial 16S rRNA and 3908 sequences for archaeal 16S rRNA). Values refer to maximum, mean and minimum shared OTU_{0.945} between any given pair of samples from the respective group.

Table S3. Relative abundance of 16S rRNA gene sequences retrieved from Caspian Sea initial and SOFT core sediments. Only sequences classified as *Desulfobacterales* by the SILVA NGS pipeline were considered for further detailed phylogenetic analysis using arb.

Depth [cm]	Total <i>Desulfobacterales</i>	SCA1	C2-C4 alkane degr.*	SEEP1a	SEEP1b	SEEP1d	<i>Desulfosarcina</i>	<i>Desulfococcus</i> Hxd3	LCA1	LCA2	SB-29 relatives	s2551	Cyhx ^s	<i>Desulfobacula</i>	<i>Desulfatigians</i> group	Sva0081
0-1	14.0	0.6	0.1	0.1	0.3	1.0	0.9	0.2	0.1	0.2	0.4	0.7	0.2	2.3	0.9	2.5
2-4	8.3	0.3	<0.1	0.2	0.2	0.8	0.4	0.2	0.1	0.1	0.3	0.4	0.1	0.9	0.9	2.3
4-6	12.8	0.6	0.1	0.2	0.2	1.6	0.6	0.3	0.1	0.2	0.6	0.5	0.2	0.9	1.1	4.5
6-8	15.5	0.7	<0.1	0.3	0.6	1.1	0.4	0.2	0.1	<0.1	0.2	0.4	0.1	1.7	1.8	5.4
10-12	13.1	0.6	<0.1	0.4	0.3	1.6	0.3	0.1	0.1	0.1	0.1	0.5	0.1	1.1	1.6	4.6
14-16	19.4	0.6	0.1	0.4	0.9	3.4	0.5	0.3	0.2	0.3	0.3	0.5	0.3	2.0	1.8	5.7
0-1	9.2	0.6	0.1	0.2	<0.1	1.2	1.3	0.2	<0.1	<0.1	0.3	0.5	0.5	2.4	0.9	1.8
2-4	14.0	0.5	1.1	0.2	0.2	1.2	1.3	0.2	<0.1	0.8	0.4	0.5	0.6	2.7	1.3	3.1
4-6	20.6	0.7	0.4	0.1	0.2	0.7	1.5	0.2	0.1	1.5	0.5	0.9	0.2	8.1	1.1	3.4
6-8	22.3	0.8	0.7	0.3	0.4	2.7	0.6	0.2	0.1	1.9	0.2	0.7	0.4	6.4	2.1	4.2
10-12	20.0	0.6	0.1	0.4	0.6	3.3	1.0	0.3	0.1	0.2	0.2	1.1	0.1	2.9	1.7	4.9
14-16	15.9	0.8	0.1	0.2	0.5	3.4	0.5	0.3	<0.1	0.1	0.4	0.8	0.1	1.2	2.1	3.6

Table S4. Frequencies of archaeal 16S rRNA gene sequences retrieved from initial and SOFT core sediments (6 – 16 cm depth) that are affiliated with taxonomic groups known to be involved in the methane cycle. Total number of quality-trimmed archaeal 16S rRNA tag sequences: 25968 for initial sediments and 128093 for SOFT core sediments. Taxonomy according to ARB SILVA (release 119, April 2015).

	Initial sediment	SOFT core sediment [% archaeal sequences]
ANME-2a-2b		0.015
ANME-2c		0.001
GoM-Arch87		0.001
Methermicocaceae		0.009
Methanosaetaceae	0.004	0.012
Methanocellaceae		0.002
Methanomicrobiaceae		0.702
Methanosarcinaceae		
<i>Methanlobus</i>	0.065	0.126
<i>Methanococcoides</i>	0.008	0.040
<i>Methanosarcina</i>	0.004	11.125
<i>Methanosaeta</i>	0.004	0.016
Others (ANME-3, <i>Methanohalophilus</i>)		0.020
SUM [% of all Archaea]	0.085	12.069

Table S5. Oligonucleotide probes used in this study

Probe name	Specificity	Form- amide [%]	Sequence (5' - 3')	Reference
SCA1-212a	SCA-SRB1	20	CATCCCAAAACAGTAGCT	
SCA1-212b	SCA-SRB1	20	CATCCCAAAACAGTAGCT	
h1_SCA1-197			TATWTATAGAGGCCA	
h2_SCA1-197			TATAWATAGAGGCCA	
h3_SCA1-182	Helper for SCA1-212ab		CCTTTGATCTRAAAA	Kleindienst <i>et al.</i> , 2014
h4_SCA1-182			CCTTTGATCTGAAWA	
h5_SCA1-229			GCTAATGGTAGCGRGCT	
h6_SCA1-182			CCTTTGATCTGGATA	
LCA2-63	LCA2	10	GCUAAAGCUUUCUCGUUC	
h1_LCA2-83	Helper for LCA2-83		CUUUACUCACUCUAGCAA	Kleindienst <i>et al.</i> , 2014
Cyhx28-EdB_152	Clade Cyhx	20	ACGAAGCCTTTCAGCATG	Jaekel <i>et al.</i> , 2015
Cyhx28-EdB_152_mod	Clade Cyhx	20	ACGAAGCCTTTCGGCATG	This study
DSB985	<i>Desulfobacter</i> , <i>Desulfobacula</i> , <i>Desulfospira</i> , <i>Desulfotignum</i>	20	CACAGGATGTCAAACCCAG	Manz <i>et al.</i> , 1998
Arch915	Archaea	35	GTGCTCCCCGCCAATTCTT	Stahl <i>et al.</i> , 1988
Delta495a	<i>Deltaproteobacteria</i>	30	AGTTAGCCGGTGCTTCT	Loy <i>et al.</i> , 2002
Delta495b			AGTTAGCCGGGGCTTCT	
Delta495c			AATTAGCCGGTGCTTCT	
cDelta495a	Helper for Delta495	30	AGTTAGCCGGTGCTTCT	
cDelta495b			AGTTAGCCGGGGCTTCT	
cDelta495c			AATTAGCCGGTGCTTCT	
Non338	Negative control	35	ACTCCTACGGGAGGCAGC	Wallner <i>et al.</i> , 1993
MS1414	<i>Methanosarcinales</i>	50	CTCACCATACCTACTCGGG	Crocetti <i>et al.</i> , 2006
hMS1395	Helper for MS1414		GCTTTCACGGCGGTGTG	
hMS1480			CGACTTAACCCCTTGC	

6. Manuscript III.

**Comparative study of microbial petroleum degradation in marine seep
vs. non-seep sediments in a simulated petroleum seepage**

Sonakshi Mishra ^a, Marion Stagars ^b, Peggy Wefers ^{a,c}, Katja Laufer ^d, Johanna Maltby ^a, Mark Schmidt ^a, Katrin Knittel ^b, Ira Leifer ^e and Tina Treude ^{a,b*}

^a*GEOMAR Helmholtz Center for Ocean Research Kiel, Department of Marine Biogeochemistry,
Kiel, Germany*

^b*Max Planck Institute for Marine Microbiology, Bremen, Germany*

^c*University of Rostock, Germany*

^d*Center for Applied Geoscience, University of Tuebingen, Germany*

^e*Marine Science Institute, University of California, Santa Barbara, USA*

^{b*}*Present address: University of California, Los Angeles, Departments of Earth, Planetary &
Space Sciences and Atmospheric & Oceanic Sciences, Los Angeles, USA*

In preparation for

Geochimica et Cosmochimica Acta, 2016

Abstract

The present study investigates the degradation of petroleum in sediments from the North Alex Mud Volcano in the Eastern Mediterranean, a beach in the Santa Barbara Channel near the Coal Oil Point seep field and the Eckernfoerde Bay in the South West Baltic Sea under a simulated petroleum seepage. We investigated the biogeochemical response of the different marine sediments to petroleum under quasi in situ conditions by simulating a petroleum seepage in a sediment-oil-flow-through-system (SOFT system). The highest diffusive oxygen uptake (DOU) observed in all the cores were in the range of 4 to 5 mmol m⁻² d⁻¹. Sulfate reduction was found to be the most important process in the anaerobic degradation of petroleum at all three sites. The volatile non-methane alkanes (C2 to C6) at all the three sites were almost completely depleted within the sulfate reduction zone. However, the response time for sulfate reduction activity was around three to four times longer for the sediments from the Santa Barbara Channel beach and the Eckernfoerde Bay compared to the North Alex Mud Volcano. Petroleum degradation by methanogenic archaea, most likely belonging to a rare biosphere was indicated in the otherwise oxygenated beach sediments of the Santa Barbara Channel. By comparing the results to petroleum degradation in sediment slurries, we found that there is an overestimation of the microbial response in sediment slurries compared to the SOFT system. Among all the three sites, sediments from the North Alex Mud Volcano demonstrated the fastest response to petroleum degradation by virtue of their natural adaptation to hydrocarbon seepage.

1. Introduction

Almost half of the petroleum that enter earth's ocean each year is assigned to natural hydrocarbon seeps alone (Kvenvolden & Cooper, 2003). Hydrocarbon seeps are mostly found in basin margins which have oil-producing formations and unconformities at the surface (Hunt, 1995). Petroleum seeping out of these seeps to the seawater can form oil slicks that can spread over tens of kilometers (Leifer et al., 2006). Petroleum in the marine environment undergoes physical, chemical and biological weathering (Wardlaw et al., 2008). The most important weathering process among them is microbial degradation (Das & Chandran, 2010 and references therein). Without the microbial degradation of petroleum that seeps out the ocean floor every year, our earth's ocean would be swamped with a thin layer of oil today (Head et al., 2006). Petroleum hydrocarbons like some aliphates and aromatics in the marine environment are known to be degraded by microbes under aerobic and as well as anaerobic conditions by different pathways (Leahy & Colwell, 1990; Harayama et al., 1999 and references therein). Most of the classical studies on microbial degradation of petroleum are based on selective utilization of hydrocarbons in enrichment cultures and isolates (for example, Ehrenreich et al., 2000; Cravo-Laureau et al., 2007; Kniemeyer et al., 2007). Since the use of batch cultures is insufficient to know the fate of petroleum in nature (Horowitz & Atlas, 1977), a continuous sediment-oil-flow-through system called the SOFT system was introduced, to study the biogeochemical response of sediment to simulated petroleum seepage (Mishra et al., submitted). The SOFT system maintains quasi in-situ conditions and uses intact sediment cores to study microbial degradation of petroleum during continuous petroleum seepage, thereby, providing information on the fate of petroleum under more natural conditions (Mishra et al., submitted). The current study aims to use a comparative approach and investigate the effect of petroleum seepage on the biogeochemistry of different kind of sediments with the SOFT system. The sediment cores used in this study are collected from (1) the North Alex Mud Volcano (NAMV), an active gas chimney in the Eastern Mediterranean Sea (Dupré et al., 2007), (2) a beach in the Santa Barbara Channel near the Coal Oil Point seep field, and (3) the Eckernförde Bay in the South West Baltic Sea. Due to presence of nearby seepage activity, the NAMV and the Santa Barbara cores are considered to be pre-adapted to

petroleum contaminations, whereas the Eckernfoerde Bay core is considered a reference pristine sediment.

The main objectives of this study are to i) investigate the biogeochemical changes, microbial community response and succession of petroleum degradation in different sediment types during a simulated petroleum seepage in the SOFT system ii) compare the response of petroleum pre-adapted and pristine sediment to the simulated petroleum seepage iii) compare the microbial response to the simulated petroleum seepage in the intact sediment cores of the SOFT system to sediment-petroleum slurries. We hypothesize that i) petroleum seepage simulation in the SOFT system will affect the vertical distribution of redox processes, microbial community, and petroleum composition and the petroleum will move more evenly in the sandy sediments compared to the fine grained sediments ii) sediment cores from NAMV and Santa Barbara Channel will respond faster to petroleum seepage than Eckernfoerde Bay's sediment core because of prior adaptation of the microbial community to nearby hydrocarbon seeps iii) because of better availability of nutrients under homogenized conditions, there will be an overestimation of the microbial response to petroleum in sediment-slurries compared to the SOFT system.

2. Methods

2.1 Study sites and sampling

North Alex Mud Volcano, Eastern Mediterranean

North Alex Mud Volcano (NAMV) is located at 31°58.19'N and 30°08.21'E in the Eastern Mediterranean Sea at a water depth of about 500 m (Feseker et al., 2010) (Fig 1). Situated in the western part of the Central Nile Deep Sea Fan to the north of Alexandria (Egypt), the NAMV is a deep rooted active gas chimney associated with methane and gas emissions in the Eastern Mediterranean Sea (Dupré et al., 2007; Omoregie et al., 2009; Feseker et al., 2010). The temperature at the seabed of the NAMV has been reported to be around 13.8°C (Feseker et al., 2010). In November 2008, sediment cores were collected onboard R/V Pelagia (PE298) from the center of the mud volcano using a multicorer with 8 cores (60 cm length, 10 cm diameter). Five replicate cores were used for (i) initial sulfate reduction

determination (two replicate radiotracer core liners, 30 cm length x 2.6 mm inner diameter), (ii) sediment analyses (initial methane concentration and porosity), (iii) porewater analyses (initial sulfate concentration), (iv) the SOFT experiment (one SOFT core liner, 30 cm long x 6.8 cm inner diameter), and (v) sediment slurry experiments (sediment collected in 250 ml glass bottles, sealed headspace free with butyl stopper), respectively. While samples for the determination of initial parameters were handled immediately, the core for the SOFT experiment and the sediment for slurry experiments were stored at 0°C until further handling.

Santa Barbara beach near Coal Oil Point, Santa Barbara Channel

Along the northern margin of the Santa Barbara Channel, many natural hydrocarbon seeps are found in the continental shelf that emit oil and gas. Coal Oil Point seep field is the most intense seep in this area that lies around 15 km west of the city of Santa Barbara (Hornafius et al., 1999). In May 2014, sediment was collected directly from the Bacara Resort beach in Santa Barbara near the Coal Oil Point seep (34°.25.86' N, -119°55.01'E) area using three SOFT core liners and three radiotracer core liners. Samples were collected about 10 m inshore of wave breaking, with breakers of up to 1 m in the swash zone. Water depth varied between 5 cm deep and 50 cm. Thus the samples were collected in the swash zone of the lowest tide. The swash was fairly vigorous, with continuous sediment limiting water visibility to 5 cm. The three SOFT core liners were used to collect sediment cores for (i) sediment analyses (initial porosity and methane) (ii) porewater analyses (initial sulfate concentration), and (iii) the SOFT experiment, respectively. The radiotracer cores were used for determination of initial sulfate reduction rates. All cores were stored in a cooling box at the Marine Science Institute in Santa Barbara until being shipped to Kiel in June 2014. The day after their arrival in Kiel, cores for the determination of initial parameters were handled immediately, while the SOFT core for the experiment was stored at 0°C until further handling.

Eckernfoerde Bay, Baltic Sea

The muddy sediments of Eckernfoerde Bay are associated with high organic loading and sedimentation rates (Whiticar, 2002). Phytoplankton blooms lead to pronounced hypoxia and anoxia between March and September as a result of organic matter degradation (Smetacek, 1984, 1985; Bange et al., 2010). In April 2012 and November 2013, sediment cores were collected at 28 m water depth at the Time Series Station "Boknis Eck" (BE, 54°31.15 N, 10°02.18 E), located at the entrance of Eckernfoerde Bay in the southwestern Baltic Sea. Sediment cores were collected onboard F/K Littorina using a miniaturized multicorer that holds 4 core liners (60 cm length, 10 cm diameter) for the sediment slurry experiment and the SOFT experiment, respectively. For the sediment slurry experiment, sediment cores were immediately sub sampled (sliced and homogenized) at 10°C and transferred into sterile, N₂ flushed bottles (anoxic) and sealed with butyl rubber stoppers. They were stored at 0°C until slurry preparation. For the SOFT experiment, the sediment core was brought back to the laboratory and stored at 0°C.

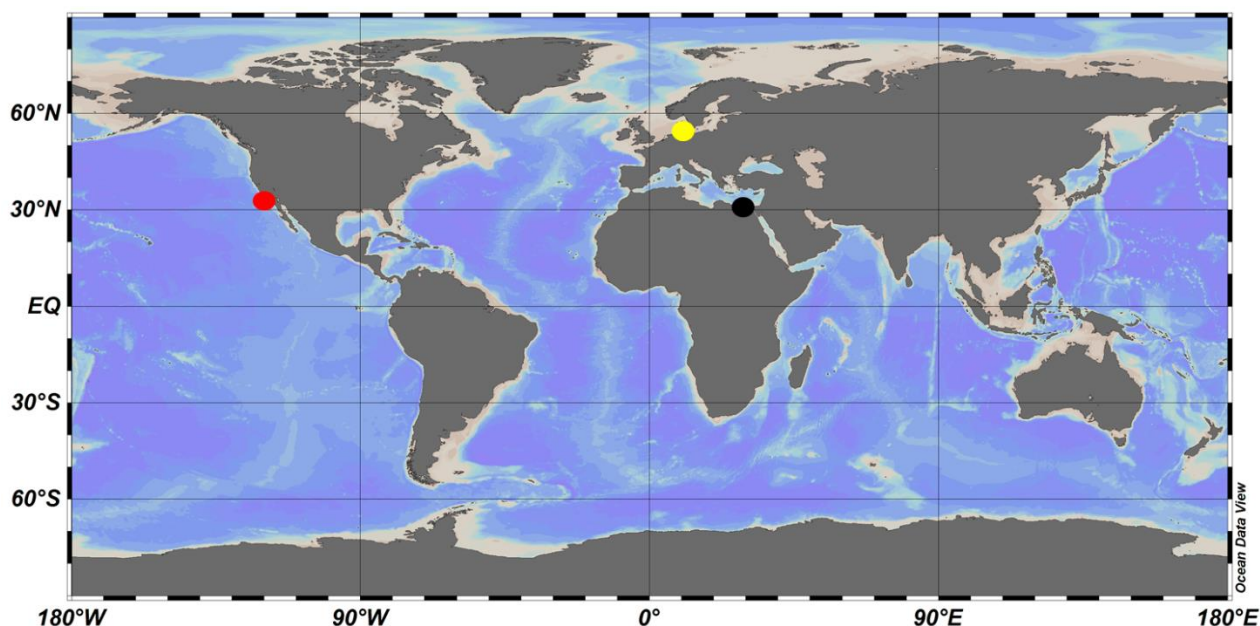

Figure 1. Study sites: North Mud Volcano in the Eastern Mediterranean (black dot), Santa Barbara Channel (red dot) and the Eckernfoerde Bay in the Baltic Sea (yellow dot).

2.2 SOFT system set up

The SOFT system is designed to simulate petroleum seepage in intact sediment cores by providing a diffusive supply of electron acceptors via artificial oxic seawater from above and pumping petroleum from the bottom of the core (detailed description is provided in Mishra et al., unpublished). Intact sediment cores are collected in gas tight polycarbonate core liners (length 30 cm, diameter 6.8 cm). The core liners have 3 vertical lines of 21 sampling holes (diameter 4 mm, distance between two holes 5.8 mm), which are sealed with residue-free silicon (Aquasil, Probau). The top cap of the core liner allows three tubing connections for i) inflowing artificial seawater ii) outflowing seawater to a wastewater reservoir ii) aeration via an air pump. The top cap of the core liner was sealed with permeable laboratory film (Parafilm, Pechiney Plastic Packaging) to allow gas exchange with the atmosphere. The bottom part of the core was kept anoxic by sealing the end of the core with a rubber stopper. Petroleum was introduced into the sediment core through two metal tubes (outer diameter 3 cm, inner diameter 1.9 mm) that were integrated into the rubber stopper through gas tight Iso-versinic tubes (LLG) via a peristaltic pump (Medorex, TL/10E, min/max pump volume $0.1 \mu\text{L min}^{-1}/400 \mu\text{l min}^{-1}$) at $3.5 \mu\text{l min}^{-1}$ at regular intervals of time. The petroleum (light and live crude oil) used in the experiment originated from the North Sea (Mittelplatte) and was provided by DEA Deutsche Erdoel AG (sampled February 2013). Artificial seawater was prepared by the respective amounts of sea salts (Sigma Aldrich, product number S9883) per liter of sterile deionized water to achieve the respective salinities (35 g, 22 g, 35 g in 1000 ml water for NAMV, Eckernfoerde Bay and Santa Barbara for salinities of 35, 22 and 35 psu, respectively). No additional vitamins were added to the seawater to keep it as natural as possible. The artificial seawater was supplied to the sediment core from the seawater reservoir via peristaltic pumps (Medorex, TL/10E, min/max pump volume $0.1 \mu\text{L min}^{-1}/400 \mu\text{l min}^{-1}$) at $25 \mu\text{l min}^{-1}$ through gas tight Iso-versinic (LLG) tubes. Sediment cores from NAMV, Santa Barbara Channel and Eckernfoerde Bay were used in the SOFT system to compare the effect of petroleum seepage on the biogeochemistry of different kind of sediments. An overview of the SOFT experimental conditions along with the different physical properties of the three sites is provided in Table 1.

Table 1. Sediment properties, location and experimental conditions for the SOFT experiment

Site	Geographical coordinates	Presence of hydrocarbon seeps	Sediment type	Permeability based on sediment type	Core length (cm)	Temp. of the SOFT experiment (°C)	Run time of the SOFT experiment (d)
NAMV	34.431041°N 119.916946°E	yes	Fine grained (clayish)	Low	~22	16	190
Santa Barbara	54.530383°N 10.046067°E	yes	Coarse grained (sandy)	High	~15	13	227
Eckernfoerde Bay	31.969333°N 30.136367°E	no	Fine grained (muddy)	Low	~20	13	395

2.3 Microsensor analyses

Microelectrode measurements were done for dissolved total sulfide and oxygen concentrations in the SOFT sediment cores according to Mishra et al., (submitted). Dissolved total sulfide (or “sulfide”) was measured with a needle H₂S microelectrode (Unisense, Denmark; H₂S-N, tip diameter 0.8 mm). The electrodes were inserted horizontally around 3 to 4 cm into the sediment core through the silicon filled liner holes and allowed to adapt between 15 to 20 minutes until the signal drift reduced and a value was noted that was at least 90 % of the response signal (Steeb et al., 2014, Mishra et al., submitted). Calibration standards consisted of 6 to 7 different concentrations of Na₂S standard solution (0, 100, 200, 500, 1000, 2000, 4000 μmol l⁻¹). The standards were prepared with oxygen-free citric acid-phosphate buffer, 10 % v/v TiCl and set to pH 7. The calibration standards were set at pH 7 as the pH value is closer to the pH values found in the sediment cores (Appendix 1). Therefore, it should be noted that the total sulfide data shown in our sediments cores are not corrected for individual pH points. The calibration

standards were stored overnight at the respective experimental temperatures to obtain the same temperature of the sediment core. The sensors were calibrated prior to measurements using the calibration software offered by Unisense (SensorTrace PRO) and at the end of the measurements, the data were corrected for any shift in the electronic signal.

Oxygen was measured with a miniaturized Clark-type glass microelectrode (Unisense, Denmark; OX-100, tip diameter 100 μm). A two point calibration was done using the overlaying water as 100% atmospheric oxygen and the lowest signal in the sediment as the zero reading (0% oxygen). Vertical microprofiles of oxygen were obtained with a step size of 100 μm measuring period of 3 s and waiting period of 15 s. The oxygen penetration depth and the diffusive oxygen uptake (DOU) was calculated from the oxygen microprofiles according to (Glud et al., 1994).

Microsensor measurements were always done before porewater sampling to avoid disturbances in the sediment by the porewater extraction.

2.4 Porewater extraction and analyses

Rhizons (Rhizosphere, CSS-F, length 5 cm, diameter 2.5 mm, pore size 0.2 μm) were used to extract porewater from the initial sediment cores of Santa Barbara and Eckernfoerde Bay. Porewater extraction in the initial NAMV core was done by using a POM (polyoxymethylen) pore-water pressing bench (KC Denmark). For the SOFT cores, the rhizons were permanently fixed to one set of the three vertical sampling hole lines in the core liner for the entire duration of the experiment (Mishra et al., submitted). 1.5 to 2 ml of porewater was extracted per rhizon at intervals of 2 cm at regular intervals of time. 0.05 to 0.1 ml of the porewater was used immediately for the determination of total alkalinity by titration. Determination of alkalinity was done by titrating 50 or 100 μl of the supernatant by 0.01 M HCl titrosol solution according to (Ivanenkov & Lyakhin, 1978) with an electric burette (876, Dosimat plus, metrohm). Methyl red and methylene blue was used as an indicator and the certified seawater standard IAPSO as the calibration standard. The rest of the porewater was stored in 2 ml plastic cyro-vials at -20 $^{\circ}\text{C}$, and was later used for

analyzing sulfate by ion chromatography (Mishra et al., submitted). Porewater extraction was always done at the end of the microsensor analyses to avoid disturbances within the sediment.

2.5 Core slicing for sediment analyses

The initial and SOFT cores (at the end of the SOFT experiment) were sliced on an extruder (diameter ~5.8 cm) every 1 to 2 cm for the analyses of C1-C6 n-alkanes and their $\delta^{13}\text{C}$ -methane isotopic signature, C10-C38 n-alkanes, porosity, sulfate reduction rates, total carbon and nitrogen (TCN), and 16S rRNA phylogenetic studies according to Mishra et al. (submitted). For slicing, the bottom cap was removed slowly and the core liner was immediately placed on the extruder. The overlaying seawater was removed from the top with a 60 ml syringe. However, complete removal of the oil was not possible leading to settling oil particles on the surface. Therefore, the 0-1 cm sediment layer would not be included in the discussion for some sediment parameter analyses (for example, n-alkane analyses) because of the additional petroleum hydrocarbons that might have been contributed by the oil slick (Mishra et al., submitted).

2.6 Concentration of volatile n-alkanes (C1 to C6) and their carbon isotopic signature

A headspace technique was used to determine the dissolved volatile hydrocarbons (C1-C6) in the sediment cores. Two ml of sediment and 5 ml of 2.5% (w/w) NaOH solution were equilibrated in a septum-sealed 13 ml headspace glass vial at room temperature (Sommer et al., 2009). "Thermo Trace ultra" (Thermo Scientific) gas chromatograph equipped with flame ionization detector (carrier gas: helium 5.0; capillary column: RT Alumina Bond-KCl, column length: 50 m; column diameter: 0.53 μm) was used to determine hydrocarbon composition (C1-C6 n-alkanes) of the headspace gas. Precision of $\pm 1-3\%$ was achieved in comparison to standard hydrocarbon mixtures. Stable carbon isotope ratios of methane (C1) were measured by using a continuous flow GC combustion - Isotope Ratio Mass Spectrometer combination (Mishra et al., submitted).

2.7 Higher n-alkanes (C10 to C38)

C10 to C38 n-alkane analyses were done according to Mishra et al., (submitted). Sediment samples collected during the slicing were wrapped in aluminum foil and stored at -20°C until analyses. For n-alkane analyses, the sediment samples were first extracted with dichloromethane and acetone (80:20) at 100°C in an Accelerated Solvent Extraction (Dionex ASE 150, Thermo Scientific) and then measured in GC-MS (Shimadzu, GCMA-QP2010 with auto injector AOC-20i) for n-alkanes according to Mishra et al., (submitted). A chromatographic column filled with 1 g of silica gel (Roth, 230-400 µm mesh size, preheated at 450°C for 4 hours and activated with 8% v/w with deionized water) with silanized glass wool at the outlet end was used to fractionate the extract before measuring in the GC-MS. The GC-MS had a capillary column (ZB-1HT Inferno, length 30 m, thickness 0.25 µm, diameter 0.25 mm). Helium Alphagaz-1 (Air Liquide) was used as the carrier gas with a flow rate of 0.8 ml min⁻¹. The samples were measured in scan mode with the mass-to-charge ratio (m/z) range of 43 to 85. Deuterated tetracosane (C₂₄D₅₀) was used as an internal standard to get the recovery of individual n-alkanes. Precision of the method for individual n-alkanes is provided in Mishra et al., (submitted).

2.8 Sediment Porosity and total C, N, S

Porosity of the samples was estimated from the difference in weight of the wet and freeze-dried sediment. It was then calculated from the water content (difference in weight of wet and freeze-dried sediment) assuming a dry solid density of 2.63 g cm⁻³. It should be noted that in samples from SOFT core, as the petroleum was not totally removed by the freeze-drying process, porosity values might appear lower than their actual values. Samples for total C, N and S were sub-sampled from the porosity samples and analyzed by CARLO ERBA Elemental Analyzer (NA 1500) (Mishra et al., submitted).

2.9 Sulfate reduction rates

Sulfate reduction rates in the initial radiotracer cores were determined by injecting 6 μl of the carrier-free $^{35}\text{SO}_4^{2-}$ radio tracer (dissolved in water, 200 kBq, specific activity 37 TBq mmol^{-1}) according to the whole-core injection method (Jørgensen, 1978). In the SOFT cores, 3 to 4 ml sediment samples were collected every 2 cm vertically in 5 ml glass tubes and sealed with butyl rubber stoppers after sampling, to which 6 μl carrier-free $^{35}\text{SO}_4^{2-}$ radiotracer (dissolved in water, 200 kBq, specific activity 37 TBq mmol^{-1}) was injected (Treude et al., 2005b). Incubation temperature was 16 °C for NAMV (initial only) and 13 °C for all other sites (initial and SLOT). Incubation times were between 8 and 24 hrs. After incubation, bacterial activity was stopped by transferring each sediment layer into 50 ml plastic centrifuge tubes filled with 20 ml zinc acetate (20% w/w). Five controls were prepared by adding the tracer to killed samples. The vials were stored at -20°C until rate determination by the cold chromium distillation procedure according to (Kallmeyer et al., 2004).

2.10 Slurry experiment

Sediment slurries (1:7; sediment:anoxic artificial seawater medium) were prepared with Eckernförde Bay sediment from 0-10 cm (collected in April 2012, see section 2.1). The slurries were prepared in 15 ml Hungate tubes and sealed with butyl rubber stopper and crimped with aluminum caps. The Hungate tubes containing the sediment were flushed with N_2/CO_2 (80:20, v/v) for 3 minutes to maintain anoxic conditions. The slurries were treated with 0.6% volume of light crude oil originating from Mittelplatte (provided by DEA Deutsche Erdoel AG). The experiment was conducted at 13°C in dark. Sediment slurries with the NAMV sediment (5 to 10 cm sediment depth, collected in November 2008, see section 2.1) were also prepared in 1:7 (sediment:anoxic artificial seawater medium). The slurries were prepared in 100 ml serum vials and sealed with butyl rubber stopper and crimped with aluminum caps. An overview of different slurry preparations is given in Table 2. One ml of the supernatant was sampled at regular intervals with a N_2 flushed syringe for sulfide and alkalinity determination. Determination of sulfide concentration in the supernatant was done after (Cord-Ruwisch, 1985). Determination of alkalinity was done by titrating 50 μl of the supernatant by 0.01 M HCl titrosol solution according to (Ivanenkov &

Lyakhin, 1978) and using the certified seawater standard IAPSO for calibration. Titration was done immediately after sampling, using a methyl red and methylene blue indicator with an electric burette (876, Dosimat plus, metrohm).

Table 2. Experimental conditions for sediment-oil slurries with sediments from the NAMV and the Eckernfoerde Bay

Sites	Temp. (°C)	Salinity (psu)	Artificial seawater medium	Vials	Dilution Sed:Medium	Total Vol. (ml)	Oil (vol.%)
Eckernfoerde Bay	13	22	Sulfate rich (Widdel & Bak, 1992)	15 ml Hungate tubes	1:7	1	0.6
NAMV	20	35	Sulfate rich (Widdel & Bak, 1992)	100 ml Serum vials	1:7	70	1

2.11 Phylogenetic studies

DNA extraction

DNA was extracted from 1 g sediment that was frozen immediately after sampling with the UltraClean soil kit (MoBio) according to manufacturer's recommendation with the following modifications: Initial cell lysis was performed by adding 0.02 mg ml⁻¹ proteinase K (Merck, Darmstadt, Germany) to the sample and incubating for 50 min at 37 °C and moderate shaking. Besides that, a second beat beating step was done. The final elution was done in 50 µl elution buffer.

Sequencing of 16S rRNA genes

Bacterial 16S rRNA genes were amplified with the primer pair Bakt_341F (5'- CCTACGGGNGGCWGCAG- 3') / Bakt_785R (5'- GACTACHVGGGTATCTAATCC- 3') (Herlemann et al., 2011). Primers were barcoded and extended with a SfiI restriction site at

the 5' end for ligation with the 454-adapters. For each sample, 8 replicate polymerase chain reactions (20 µl volume) per primer pair were carried out containing each 0.5 µM primer, 250 µM deoxynucleotides, 0.3 µg/µl bovine serum albumin, 1 × polymerase chain reaction buffer, 0.25 U Taq polymerase (5Prime, Germany), 10 – 25 ng template under the following conditions: initial denaturation at 95°C for 5 min, followed by 35 cycles of denaturation (96°C, 1 min), annealing (58°C, 1 min), elongation (72°C, 2 min), and a final elongation step (72°C, 10 min). The replicate polymerase chain reactions were pooled, 500 basepair-amplicons extracted from an agarose gel (1.5% w/v) and purified using the MinElute polymerase chain reaction Purification Kit (Qiagen) according to the manufacturer's recommendations. Parallel taq sequencing of the amplicons was carried out on a 454 Life Sciences GS FLX sequencer (Roche, Basel, Switzerland) at the Sequencing Research Center, Cologne, Germany. The raw reads were submitted to a rigorous quality control procedure using a mothur version 1.32.1 routine (Schloss & Westcott, 2009) including trimming and quality filtering of the reads. The quality reads were taxonomically assigned using the SILVA NGS pipeline with the ARB SILVA taxonomy database SILVA NR v119.1 (Quast et al., 2012).

3. Results

3.1 Evolution of sediment properties in the SOFT system

The effect of petroleum seepage on the porosity was different for all three sites. In the NAMV core, there was only a little decrease in porosity in the SOFT core (0.73 to 0.66) compared to the initial core (0.75 to 0.66) (Fig. 2). The maximum decrease in porosity was in the sandy sediment of Santa Barbara core. At 13 cm depth, porosity decreased by 40% from 0.36 in the initial core to 0.16 in the SOFT core. For the Eckernfoerde Bay site, except for a slight decrease in porosity at the shallower depths in the SOFT core compared to the initial core, the porosity did not change much between the initial and the SOFT core.

For the NAMV site, the amount of organic carbon (C_{org}) increased from around 0.9 to 1% in the initial core to a maximum of 57% at the end of the SOFT experiment (Fig. 3). The initial

values for C_{org} in the Santa Barbara and Eckernfoerde Bay cores are not available. In the SOFT cores, the C_{org} was relatively high for both, Santa Barbara and Eckernfoerde Bay sites. The C_{org} ranged between 1 and 10% in the Santa Barbara SOFT core and 4 and 10% in the Eckernfoerde SOFT core (Fig. 3). All three sites exhibited high C/N ratios (Fig. 3). The Santa Barbara SOFT core had the highest C/N ratio with a maximum value of 231 at 13 cm. The C/N ratio in the Eckernfoerde Bay and the NAMV SOFT cores were in the range of 10 and 20, and 10 and 60, respectively.

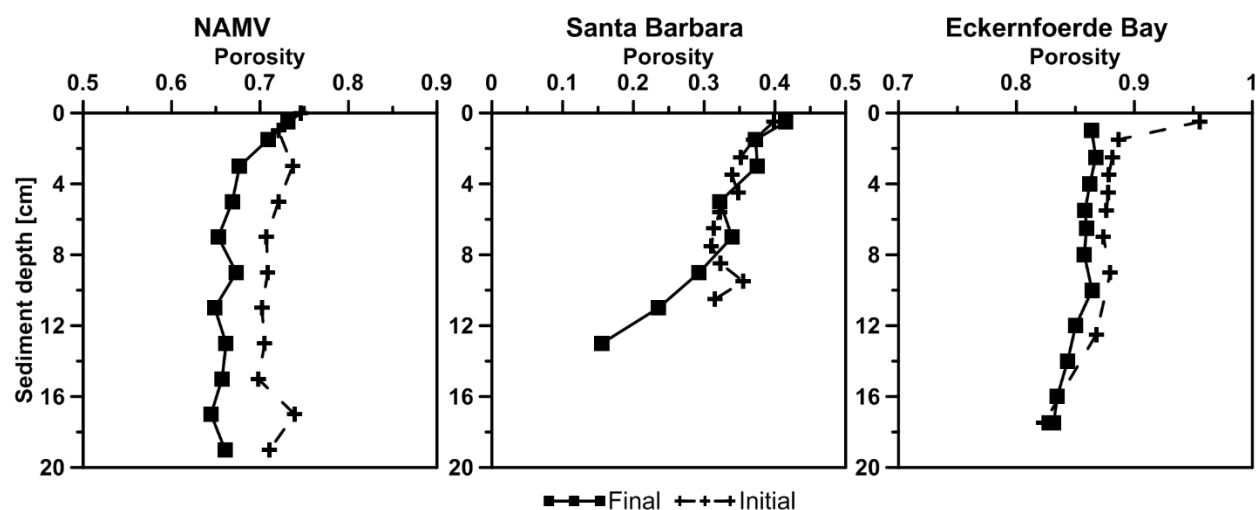

Figure 2. Porosity over depth in the initial sediment core and the final SOFT sediment cores from NAMV, Santa Barbara Channel and Eckernfoerde Bay.

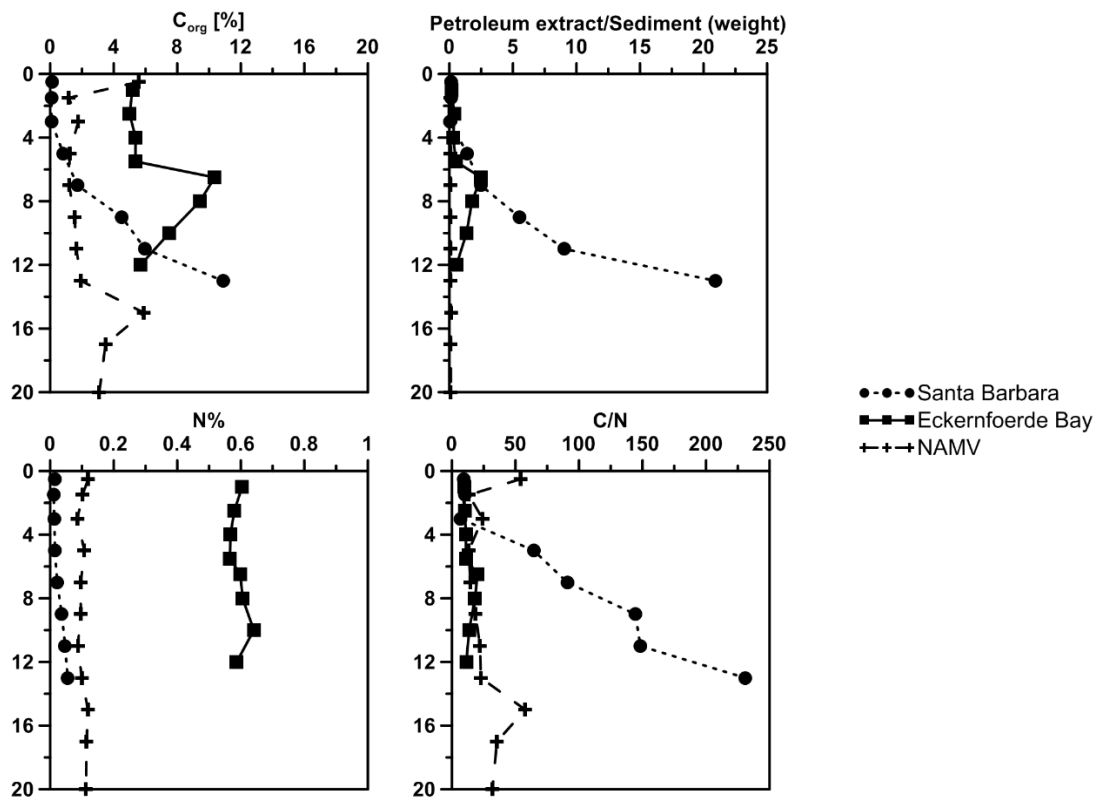

Figure 3. Organic carbon (C_{org} %), C/N ratio, total nitrogen ($N\%$) and ratio of the weight of petroleum to sediment weight per depth section (Petroleum extract/Sediment) in the SOFT cores of NAMV, Santa Barbara Channel and Eckernfoerde Bay.

3.2 Temporal and spatial development of redox zones in the SOFT system

Porewater analyses and microsensors measurements were conducted in the sediment cores to obtain the concentrations of dissolved oxygen, sulfate, sulfide, methane and alkalinity. In all the three SOFT cores, a vertical zonation of different redox processes was seen during the petroleum seepage (Fig. 4, 5, 6, 7), which was in accordance with the natural redox ladder of marine sediments (Jorgensen, 2006).

At the sediment surface, an oxic layer was found in the SOFT cores from all three sites (Fig. 4). The penetration depth of oxygen differed at the three sites. While penetration was highest in the Santa Barbara core (0.8 - 1 cm, Fig. 4), it ranged between 0.2 and 0.4 cm in the NAMV and Eckernfoerde Bay cores. Highest diffusive oxygen uptake (DOU) was between 4 to 5 $\text{mmol m}^{-2} \text{d}^{-1}$ in all three cores. However, the temporal development of

oxygen penetration depth and DOU slightly varied between the sites (Fig. 4). In the NAMV core, oxygen penetration depth and DOU showed a zig zag profile over time. In the Santa Barbara core, the DOU was high at first ($3 \text{ mmol m}^{-2} \text{ d}^{-1}$) and then decreased to $0.9 \text{ mmol m}^{-2} \text{ d}^{-1}$. In the Eckernfoerde Bay core, the penetration depth clearly decreased over time from 0.4 to 0.2 cm and the DOU increased from 1 to $4.3 \text{ mmol m}^{-2} \text{ d}^{-1}$.

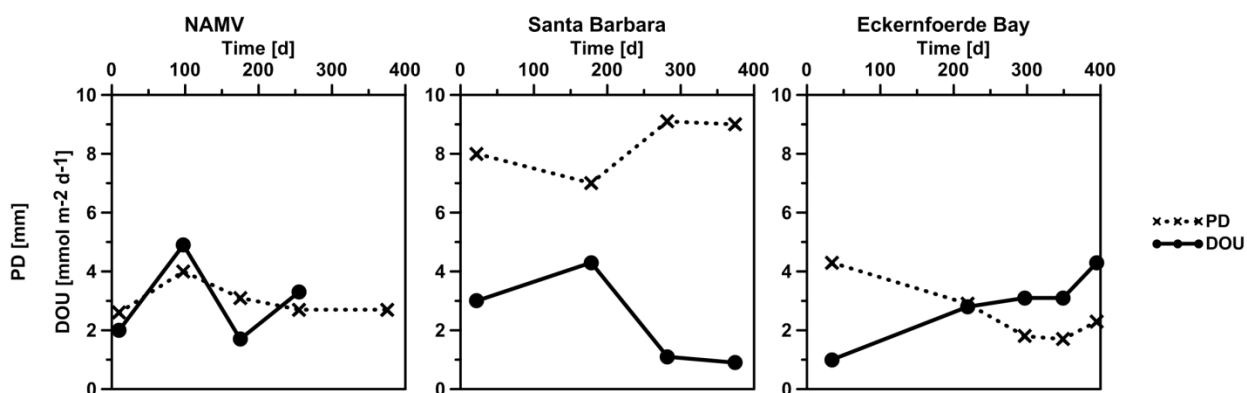

Figure 4. Temporal development of oxygen penetration depth (PD, dotted line with crosses) and diffusive oxygen uptake (DOU, solid line with circles) in the SOFT cores of North Alex, Santa Barbara Channel and Eckernfoerde Bay.

The sulfate reduction zone was found below the depletion of oxygen within the first centimeter (Fig. 5, 6, 7) at all sites. In the NAMV core, a decrease in sulfate concentrations combined with a simultaneous increase in sulfide production (up to 2000 to $4000 \mu\text{M}$) and alkalinity (up to 30 mM) indicated an active sulfate reduction zone below the oxic layer all the way up to the bottom of the core (Fig. 5). Two peaks of total sulfide production were found between 3 and 8 cm ($1080 \mu\text{M}$) and between 8 and 16 cm ($1839 \mu\text{M}$) at the end of the SOFT experiment. The highest sulfide concentration ($3904 \mu\text{M}$, 14 cm) was seen 147 days after the start of the SOFT experiment. At this time point, sulfate was completely depleted at 16 cm. Direct sulfate reduction rate measurements after the SOFT experiment are missing. In the initial core, the highest sulfate reduction activity was seen between 7 and 16 cm based on the direct rate measurements. In the Santa Barbara core, porewater sampling and microelectrode measurements were achieved only until 12 cm due to a stone present in the bottom 4 cm of the core. Sulfate concentrations decreased over depth but

were not completely depleted at 12 cm (Fig. 6). Sulfide and alkalinity increased after 129 days (Fig. 6). Compared to the initial Santa Barbara sediment core, which had around 5 μM sulfide, sulfide production increased to a maximum of 2622 μM in the SOFT core by the end of the experiment. Very high sulfate reduction rates were found in the Santa Barbara SOFT core with a maximum value of 2061.3 $\text{nmol cm}^{-3} \text{d}^{-1}$ at 3 cm. The integrated sulfate reduction rates (0-9 cm) increased from about 0.4 $\text{mmol SO}_4^{2-} \text{m}^{-2} \text{d}^{-1}$ in the initial core to 95.2 $\text{mmol SO}_4^{2-} \text{m}^{-2} \text{d}^{-1}$ in the final SOFT core. Alkalinity increased from 4 mM to about 30 mM in the lower half of the core. Based on the sulfide concentrations and the sulfate reduction rates, we assume the highest sulfate reduction activity in the Santa Barbara core to be between 0 and 8 cm. During the first 64 days of the Eckernfoerde Bay core incubation, sulfate concentration decreased from around 20 mM at the surface to around 10 mM at the bottom of the core with very small sulfide increase (Fig. 7). After 349 days, the sulfate was already decreased to about 0.4 mM at 8 cm and the sulfide profile mirrored the sulfate profile with a peak production of 1717 μM at 6 cm. The integrated sulfate reduction rates in the SOFT core (0 -18.5 cm) were 167.8 $\text{mmol SO}_4^{2-} \text{m}^{-2} \text{d}^{-1}$ at the end of the petroleum seepage. It should be noted here that due to missing data at some depths, there might be an underestimation of the sulfate reduction rates. Sulfate reduction rates (80 to 100 $\text{mmol cm}^{-3} \text{d}^{-1}$) were seen below 8 cm where sulfate concentrations were in the range of 200 to 400 μM (Fig. 7, zoomed in sulfate data). Alkalinity increased from 3 mM to about 30 mM in the lower half of the core. Based on the sulfide and alkalinity data, and the sulfate reduction rates, we assume that the highest activity of the sulfate reduction zone in the Eckernfoerde Bay core to be between 0 and 8 cm.

Below the sulfate reduction zone, a methanogenic zone was observed in the Eckernfoerde Bay and Santa Barbara core (see section 3.4).

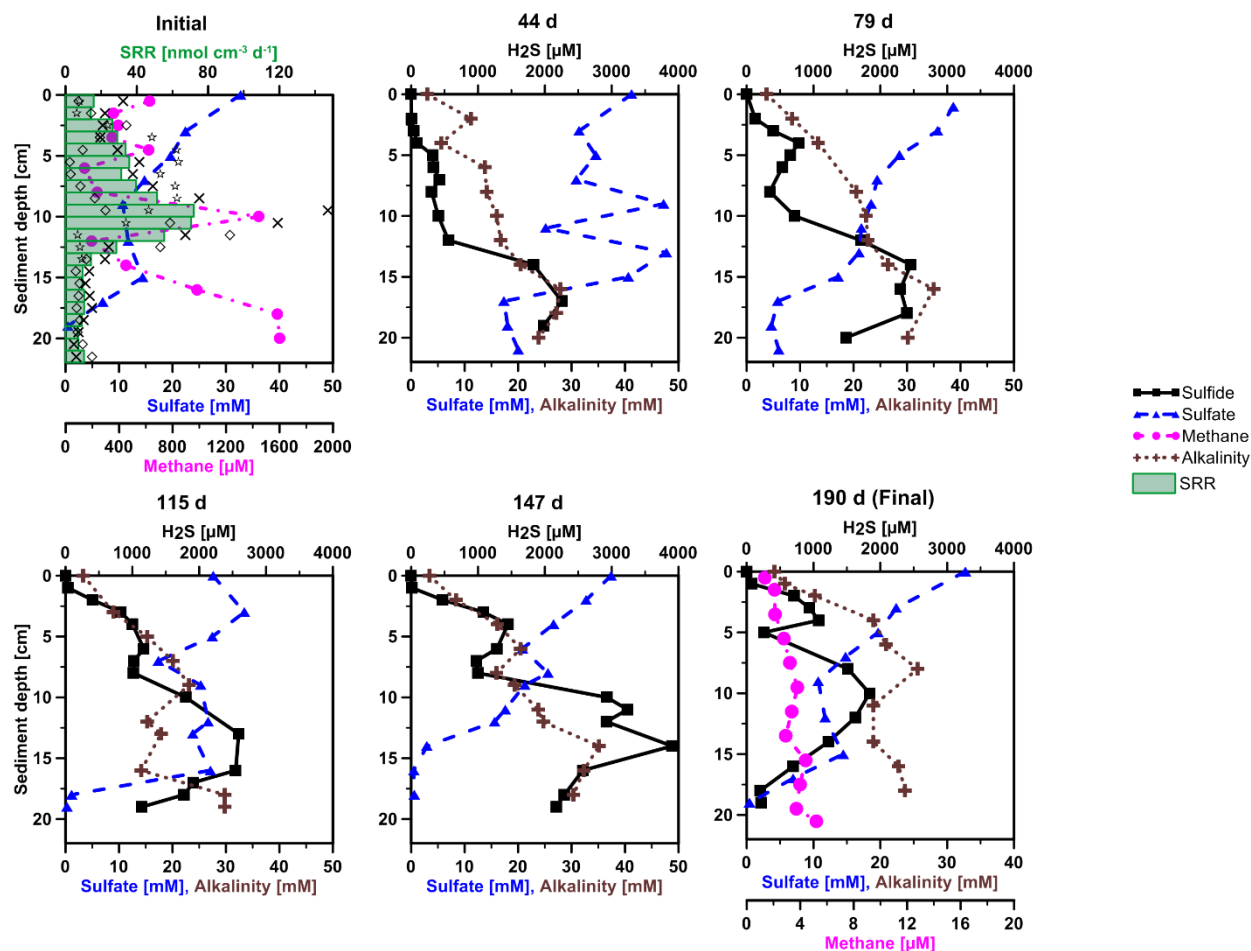

Figure 5. Temporal development of biogeochemical profiles in the NAMV sediment core used in the SOFT system over the course of the experiment. Sulfate (blue dashed line with triangles), total sulfide (black solid line with squares), total alkalinity (brown dotted line with crosses), sulfate reduction rates (SRR, green bars) and methane (pink dash dotted line with circles). Initial conditions were measured in a replicate core before the start of the SOFT system. SRR bars in the initial plot represent the average of three replicates, while single values of the SRR replicates are shown as empty black diamonds, stars and crosses. Please consider the change of scale in some of the x-axes.

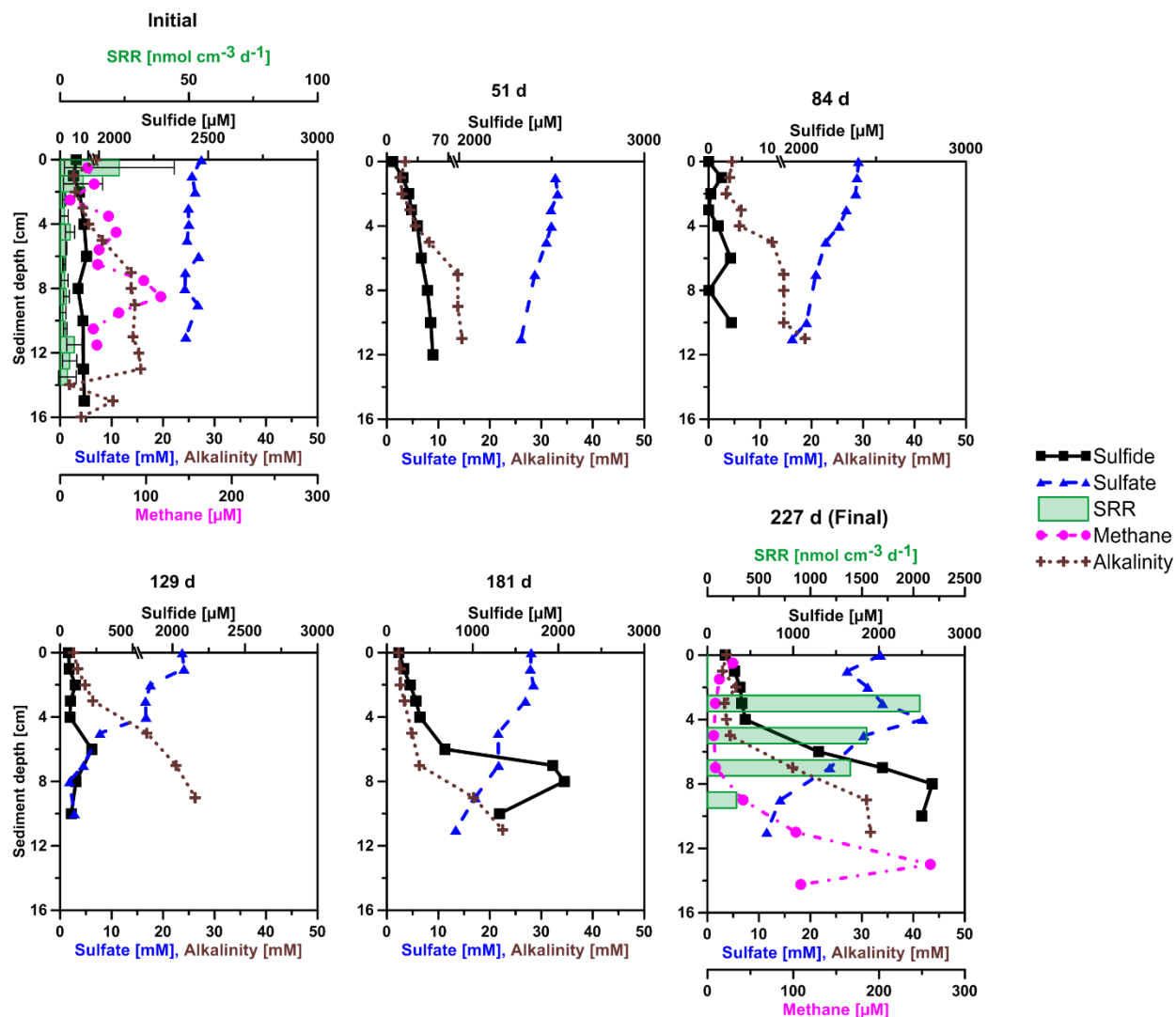

Figure 6. Temporal and spatial development of biogeochemical profiles in the Santa Barbara Channel sediment core during the SOFT experiment. Sulfate (blue dashed line with triangles), total sulfide (black solid line with squares), total alkalinity (brown dotted line with crosses), sulfate reduction rates (SRR, green bars) and methane (pink dash-dotted line with circles). Initial conditions were measured in a replicate core before the start of the SOFT system. SRR bars in the initial plot are the average of three replicates and the error bars represent the standard deviation. Please consider the change of scale in some of the x-axes.

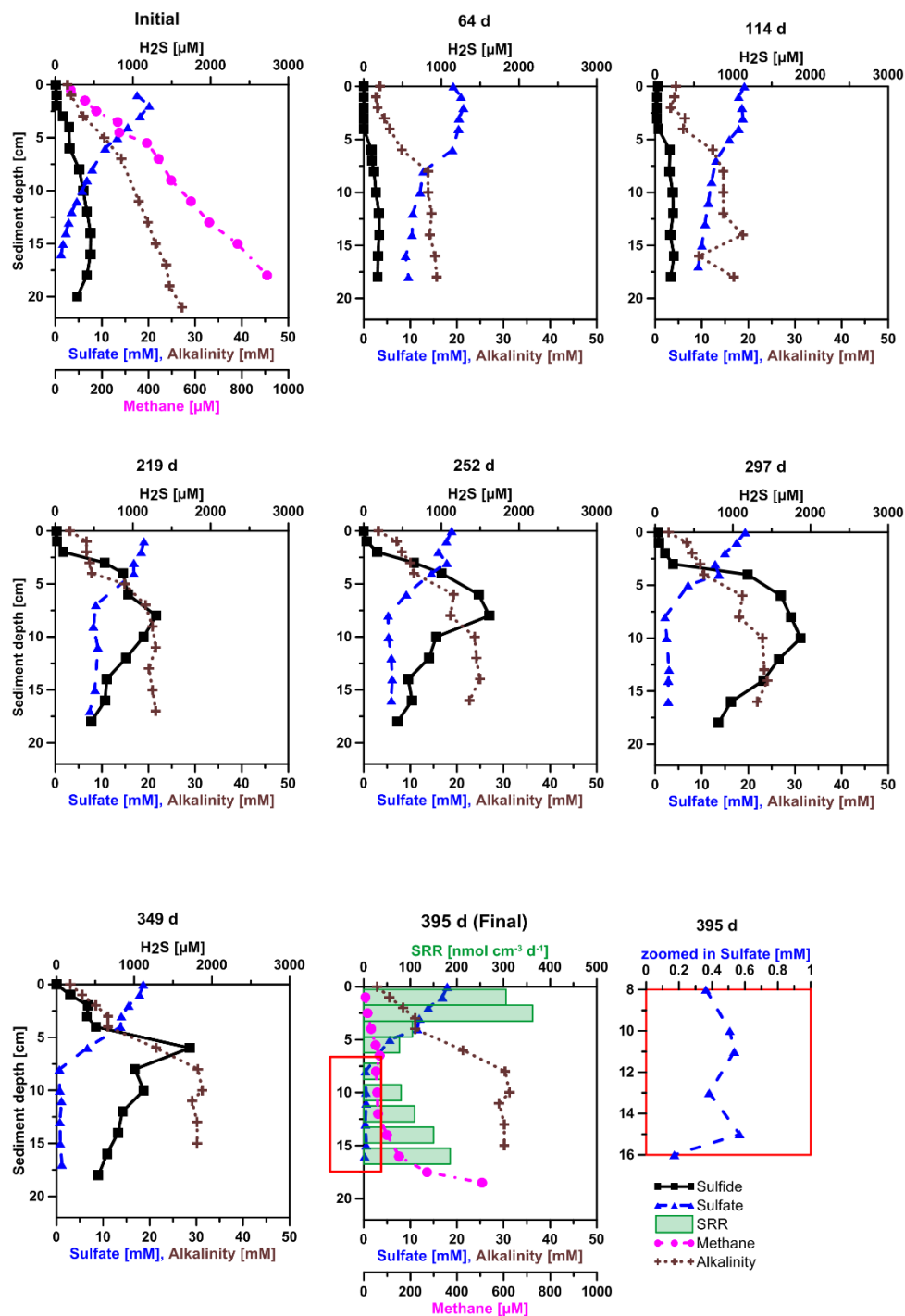

Figure 7. Temporal and spatial development of biogeochemical profiles in the Eckernfoerde Bay sediment core during the SOFT experiment. Sulfate (blue dashed line with triangles), total sulfide (black solid line with squares), total alkalinity (brown dotted line with crosses), sulfate reduction rates (SRR, green bars) and methane (pink dash-dotted line with circles). The red rectangle provides a zoomed in sulfate profile at 395 days (final measurement point). Initial conditions were measured in a replicate core before the start of the SOFT system.

3.3 Response time of sulfate reduction activity in the SOFT sediment cores and sediment slurries

The temporal development of sulfide in both the sediment-oil slurries and the SOFT cores from NAMV and Eckernfoerde Bay sediments was used to estimate the response time (Fig 8, 9). The response time was defined as the time required for the first step increase in sulfide concentration to occur. In the sediment slurries, direct observation of the sulfide data was used to estimate the response time of sulfate reducers to petroleum addition (Fig. 9). Response time of sulfate reduction in sediment slurries from Eckernfoerde Bay and NAMV were around 100 and 16 days, respectively (Fig. 9). For the SOFT cores, the sulfide concentrations were integrated over the entire length of the core for each time point. The integrated sulfide concentrations were then normalized by their respective maximum values and plotted over time (Fig. 8). The response time for the NAMV sediment core to petroleum addition was estimated to be somewhere between 0 and 44 days (Fig 8). Compared to the NAMV core, the response time was at least three times higher in both Santa Barbara and Eckernfoerde Bay sediment cores (around 130 days).

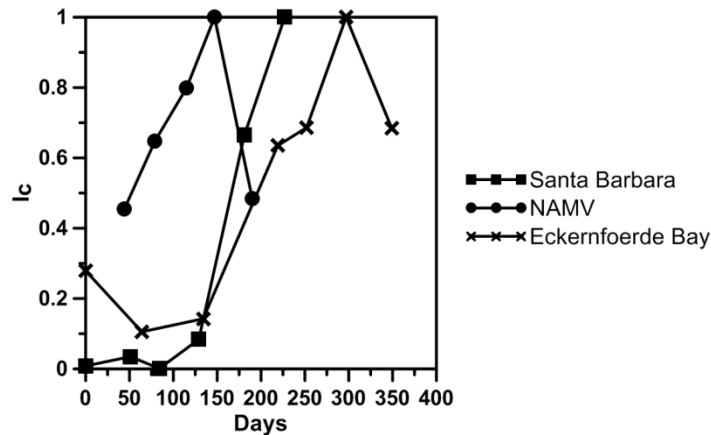

Figure 8. Response time of sulfate reduction in the SOFT cores after the start of petroleum seepage. Y-axis represents integrated sulfide concentrations (over depth) that are normalized by their respective maximum values (I_c). The x-axis represents the number of days since the start of the SOFT experiment. The appearance of first step increase in I_c indicates the response time of the individual sediment core to petroleum seepage.

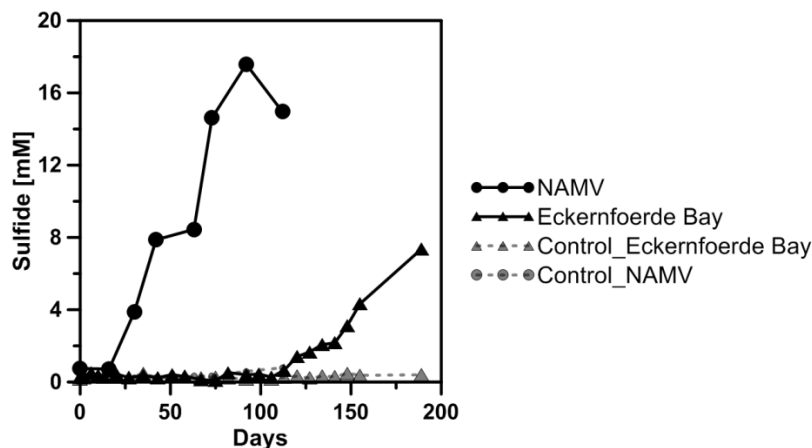

Figure 9. Temporal development of sulfide production in sediment-oil slurries from the Eckernfoerde Bay (solid line with triangles) and NAMV (solid line with circles). The sediment slurries were prepared with anoxic sulfate-reducing medium with 1:7 dilution (sediment: seawater). 0.6% and 1% v/v light crude oil from North Sea was added to the sediment slurries of Eckernfoerde Bay and NAMV, respectively. No oil was added to the control treatments (dashed lines with corresponding symbols).

3.4 Methanogenic zone in the SOFT system

Porewater concentrations of methane and its respective $\delta^{13}\text{C}$ analysis indicated a microbial methanogenic zone below the sulfate reduction zone at the Santa Barbara and Eckernfoerde Bay sites (Fig. 6, 7). Methane concentrations started to increase below 8 cm in the Santa Barbara indicating methanogenesis. Methane concentrations in the initial Santa Barbara core were in the range of 18 to 120 μM with a peak at 8.5 cm (Fig. 6, 10). In the SOFT core, methane concentrations increased over depth to a maximum of 260 μM at 13 cm. The $\delta^{13}\text{C}$ signal of methane in the initial core was in the range of -50 to -55 ‰ and decreased to 58 to -63 ‰ in the SOFT core (Fig. 10). In the Eckernfoerde Bay core, methane concentrations started to increase below 12 cm in the Eckernfoerde Bay core indicating methanogenesis. Methane concentrations in the initial Eckernfoerde Bay core increased over depth to a maximum of 907.9 μM at 18.5 cm (Fig. 7, 10). In the SOFT core, methane concentrations also increased over depth but to a maximum concentration of only 507.8 μM at 18.5 cm. The $\delta^{13}\text{C}$ signal of methane in the Eckernfoerde Bay SOFT core was in the range of -53 ‰ to -68 ‰ (Fig. 10).

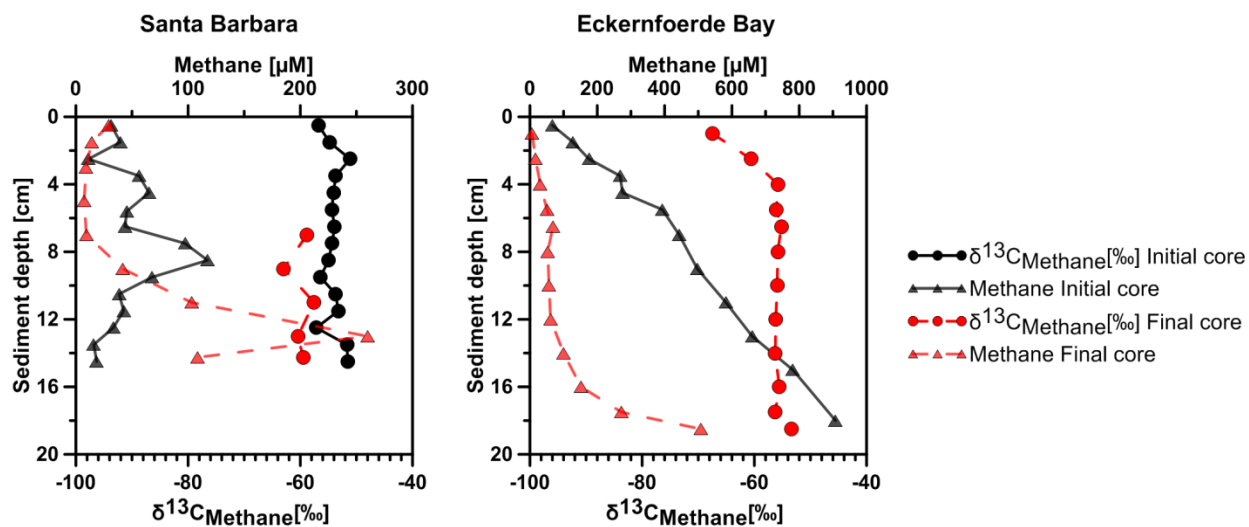

Figure 10. $\delta^{13}\text{C}$ of methane (black solid line with triangles) and methane concentration (red dashed line with circles) in the initial and final cores of Eckernfoerde Bay (A) and Santa Barbara Channel (B). Some $\delta^{13}\text{C}$ values are missing for some depths because the methane concentrations were too low for analyses. The $\delta^{13}\text{C}$ values in the initial the Eckernfoerde Bay core are missing.

3.5 16S rRNA phylogenetic study in NAMV

16S rRNA pyrosequencing revealed a high diversity of sulfate-reducing bacteria (SRB) in the NAMV sediments in both the initial and SOFT sediments. Sequences belonging to the phylum Proteobacteria were most dominant in both the initial and SOFT sediments. Within *Proteobacteria*, Deltaproteobacteria and Gammaproteobacteria were the major classes. The relative sequence abundance of Gammaproteobacteria were lower in the SOFT core compared to the initial core. For example, in the initial NAMV core the relative sequence abundance of Gammaproteobacteria was around 60% at 6 cm only about 10% in the SOFT core (Fig. 11). Nevertheless, the relative sequence abundance of gammaproteobacterial *Marinobacter* increased in the SOFT core compared to the initial core. For example, portion of *Marinobacter*-related sequences retrieved from the deepest layer (20 cm) remarkably increased from about 5% (of total Gammaproteobacteria sequences) in the initial core to about 30% in the SOFT core.

For Deltaproteobacteria, both initial and SOFT core showed a high relative sequence abundance (about 20-90% of total sequences). For 10-20 cm deep layers relative

abundance did not differ remarkably between NAMV initial and SOFT core; however, deltaproteobacterial sequences were more frequently retrieved from the upper SOFT core layers (20-30% deltaproteobacterial sequences of total sequences from initial core vs. 50-90% from SOFT core). The order Desulfobacterales comprised more than half of the total Deltaproteobacteria in both the SOFT and initial cores. *Desulfobacula*, SEEP-SRB1 and *Desulfosarcina* were among the major genera that were detected within the Desulfobacterales order (Fig. 12). The relative sequence abundance of SEEP SRB 1 were lower in the SOFT core compared to the initial core. It decreased from 32 % (within the order Desulfobacterales) at 4 cm in the initial core to 15 % in the SOFT core, whereas *Desulfobacula* spp. increased from 27 % in the initial core to 35 % in the final core (Fig. 12). At the same depth, the relative abundance of *Desulfosarcina* spp. doubled from 2 % in the initial core to 4 % in the SOFT core.

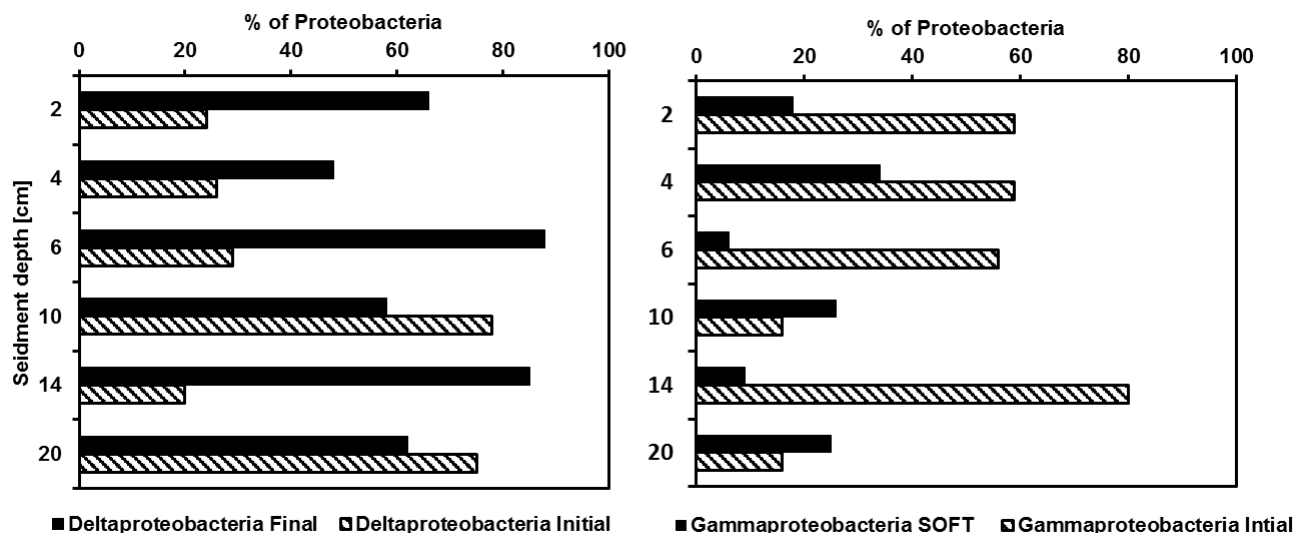

Figure 11. Relative sequence abundance of Deltaproteobacteria and Gammaproteobacteria in the initial (bars with lines) and SOFT cores (solid bars) of NAMV.

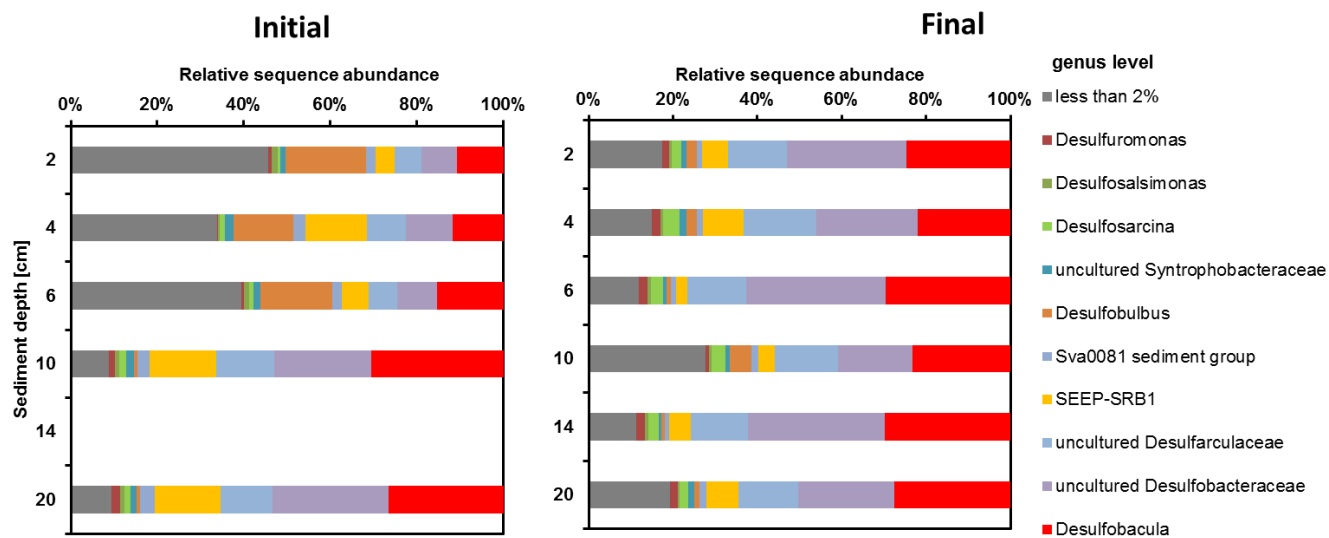

Figure 12. Relative sequence abundance within the order Desulfobacterales in the initial and SOFT cores of NAMV.

3.6 Vertical succession of n-alkane migration and degradation

Volatile short-chain n-alkanes (C1 to C6) and higher n-alkanes (C10 to C38) were measured in the sediment cores after the end of the SOFT experiment (Fig. 13, 14, 15, 16). Later, for better visualization of data, the n-alkanes will be grouped into four categories according to increasing chain length (Group 1 = C10 and C12, Group 2 = C14 and C16, Group 3 = C16 to C30, Group 4 = C32 to C38).

In the NAMV and Santa Barbara sediment cores, the volatile n-alkanes (C2 to C6) were completely degraded during the upward migration of petroleum within the top 5 cm of the sulfate reduction zone (Fig. 13). In the NAMV core, there were two peaks of high concentrations of n-alkanes. A small peak between 5 and 9 cm and another bigger peak between 11 and 17 cm. In the Eckernfoerde Bay core, the volatile n-alkanes (C2 to C6) were depleted throughout the core except for an increased peak between 5 and 10 cm. The absolute concentrations of pentane and hexane were much higher in the Santa Barbara core (~ 1000 μM) compared to the NAMV and Eckernfoerde Bay cores (~500 μM) (Fig. 13). At all three sites, the highest amounts of C10 to C38 n-alkanes were found in deeper layers (Fig. 14, 15, 16). However, in the Eckernfoerde Bay core, there was a higher peak of n-

alkane concentrations at 6.5 cm (Fig. 16). The concentrations of the n-alkanes in all the three cores progressively decreased towards the surface (Fig. 14, 15, 16). The relative decrease in the concentrations of the higher n-alkanes (C10 to C38) at a certain depth was calculated by normalizing them against their corresponding maximum concentration at a deeper layer by the formula (1)

$$[n-C_{x\text{ cm}} / n-C_{z\text{ cm}}] \times 100 \quad (1)$$

where “n-C_{x cm}” and “n-C_{z cm}” are the concentrations of n-alkanes at a certain depth and the depth with the highest amount of n-alkanes, respectively (Mishra et al., submitted). In the NAMV core, the highest amount of n-alkanes was found at 17 cm (Fig. 14). From 17 cm to 15 cm, C10 and C12 n-alkanes decreased by 90 to 100%. C14 and C16 decreased by ~40% and 15%, respectively. N-alkanes > C18 only decreased by around 10% between 17 to 15 cm. In Santa Barbara core, the maximum concentration of n-alkanes was found at 13 cm except C10 which was the highest at 14.5 cm (Fig. 15). All the n-alkanes decreased by around 50 % or more between 13 cm and 9 cm. Throughout the Eckernfoerde Bay core, very low concentrations of n-alkanes were found (Fig. 16). Two peaks of relatively high concentrations were observed at 6.5 cm and 18.5 cm (deepest layer). From 18.5 to 17.5 cm, C10 and C12 n-alkanes decreased by 100% and ~ 90%, respectively, and C14 to C38 n-alkanes decreased by around 70%. From 17.5 cm onwards there was a progressive decrease until 14 cm. However, from 12 cm onwards, there was a slight increase in concentration up to 7 cm. From 7 cm onwards there was again a successive decrease in the concentration towards the surface with almost 100% depletion of all the n-alkanes. Among the three sites, the highest absolute concentrations of n-alkanes were found in the Santa Barbara core (maximum concentrations measured about 355 ng mg⁻¹ sediment). In NAMV and Eckernfoerde Bay, the highest concentrations of n-alkanes was about 90 ng mg⁻¹ sediment.

In order to control if the relative decrease of n-alkanes was not just a function of incomplete upward migration of petroleum, the relative contribution of an individual n-alkane to the total n-alkanes was calculated. The relative contribution was calculated by dividing the concentration of an individual concentration by the sum of concentrations of

all the n-alkanes (referred as total n-alkanes from here on) at every depth. Accordingly, contribution of the individual groups (see above, Group 1, 2, 3 and 4) to the total n-alkanes was calculated (Fig. 17). In contrast to the Eckernfoerde Bay and Santa Barbara core, where the C10-C12 group reached all the way up to 5 cm until they were depleted, the C10-C12 group was already completely consumed between 17 and 15 cm in the NAMV core. The C14-C16 group also remained more or less unchanged in the Santa Barbara and the Eckernfoerde Bay core until 5 cm, from where they started depleting towards the surface. In the NAMV core, the C14-C16 group showed one peak at 17 cm from where it started decreasing upwards and then again another peak at 9 cm from where it also started decreasing towards the surface. The most persistent group in the total n-alkanes was the C18-C30 group, which dominated until the surface in all the cores. The C32-C38 group comprised the smallest part of the total n-alkanes and did not show any specific trend over depth.

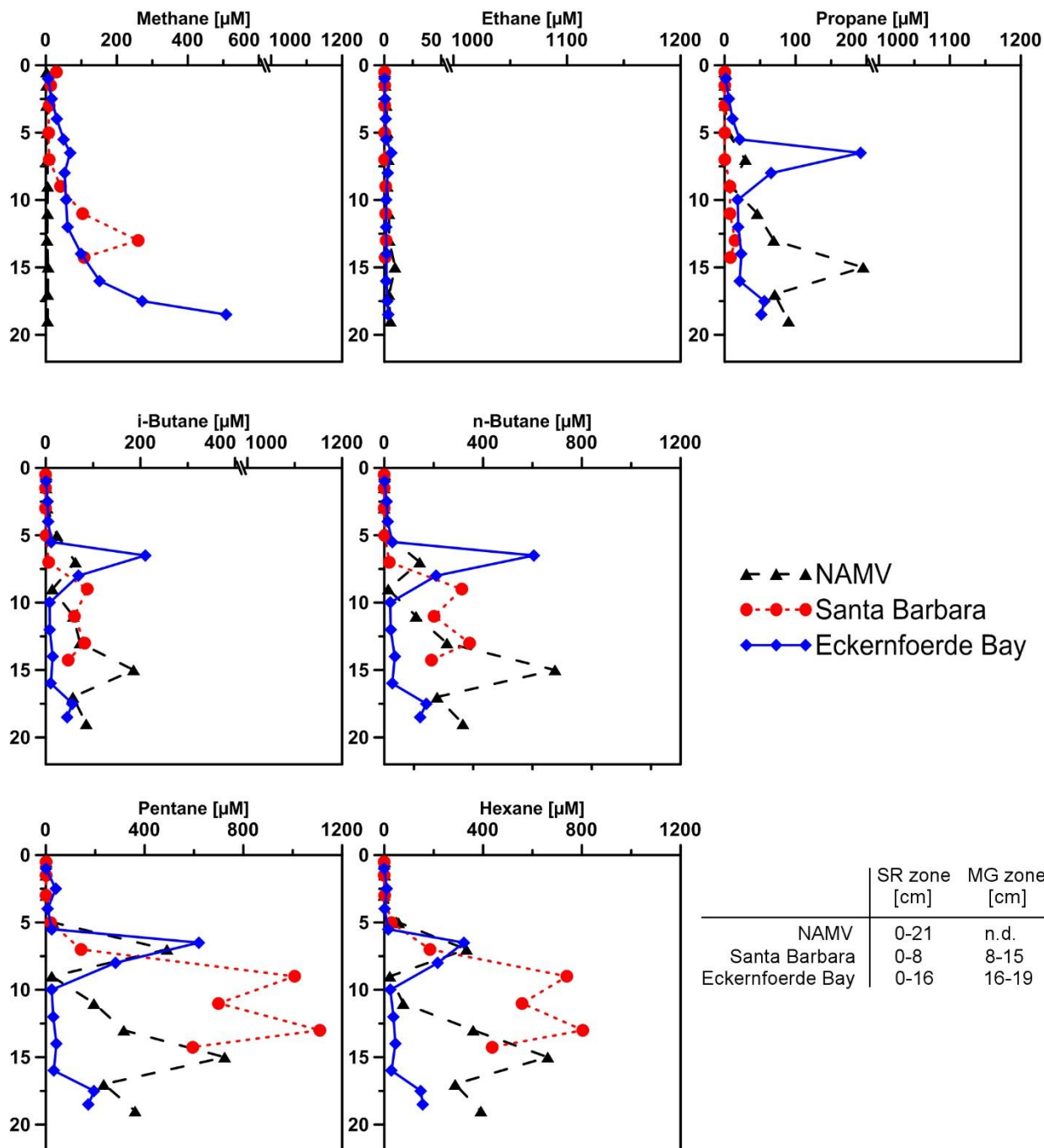

Figure 13. Vertical distribution of volatile n-alkanes (from C1 to C6: Methane, Ethane, Propane, i-Butane, n-Butane, Pentane and Hexane) over depth in the SOFT cores of NAMV (black hashed line with triangles), Santa Barbara Channel (red dotted line with circles) and Eckernfoerde Bay (blue solid line with diamonds) at the end of the SOFT experiment. The table at the right corner gives the approximate length of the sulfate reducing zone (SR zone) and the methanogenic zone (MG zone) in the SOFT cores. n.d = not detected

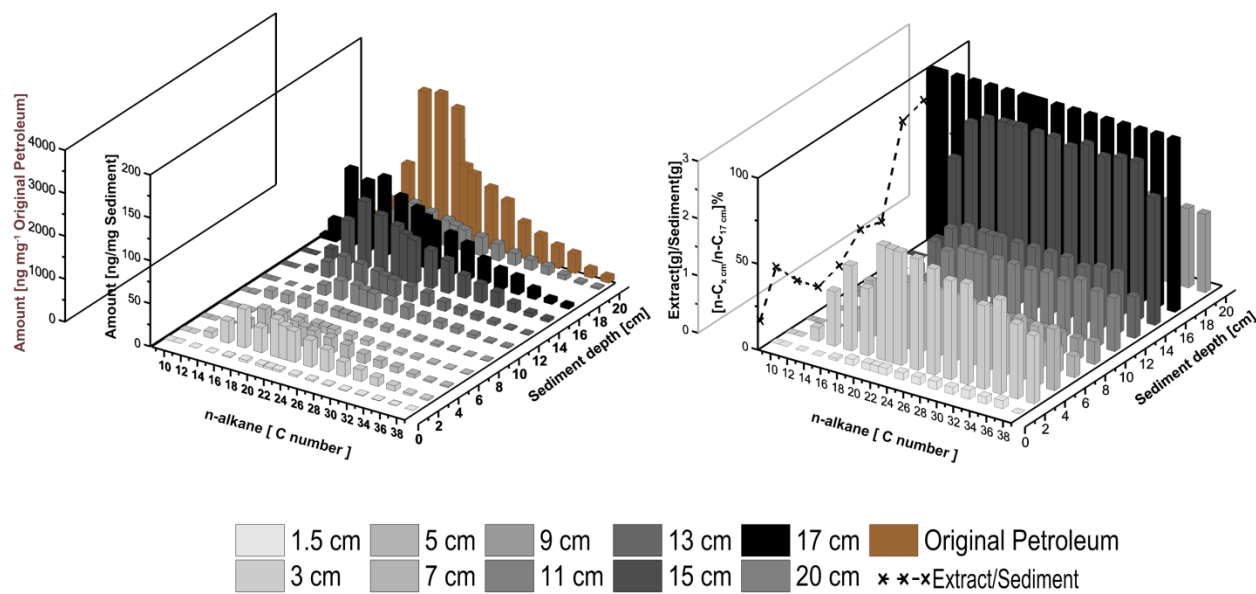

Figure 14. (Left) Vertical distribution of higher hydrocarbons (n-alkanes C10 to C38) in the NAMV core after the SOFT experiment. Surface sediment (0-1 cm) is excluded, due to possible influence from the overlaying oil slick that settled on the sediment during slicing of the core (see text). (Right) Relative decrease in the concentration of n-alkanes over depth. The relative concentrations are normalized against the deepest layer with the maximum concentration (17 cm). The dashed line with crosses shows the ratio of the weight of petroleum extract at each depth to the respective sediment weight and represents the movement of petroleum in the SOFT core.

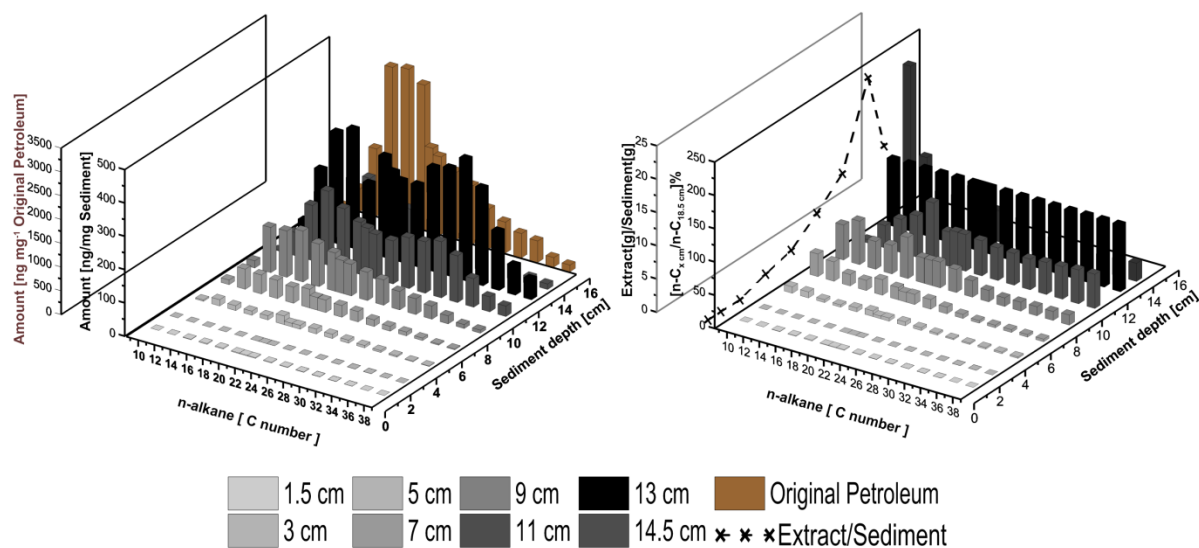

Figure 15. (Left) Vertical distribution of higher hydrocarbons (n-alkanes C10 to C38) in the Santa Barbara core after the SOFT experiment. Surface sediment (0-1 cm) is excluded, due to possible influence from the overlaying oil slick that settled on the sediment during slicing of the core (see text). (Right) Relative decrease in the concentration of n-alkanes over depth. The relative concentrations are normalized against the deepest layer with the maximum concentration (15 cm). The dashed line with crosses shows the ratio of the weight of petroleum extract at each depth to the respective sediment weight and represents the movement of petroleum in the SOFT core.

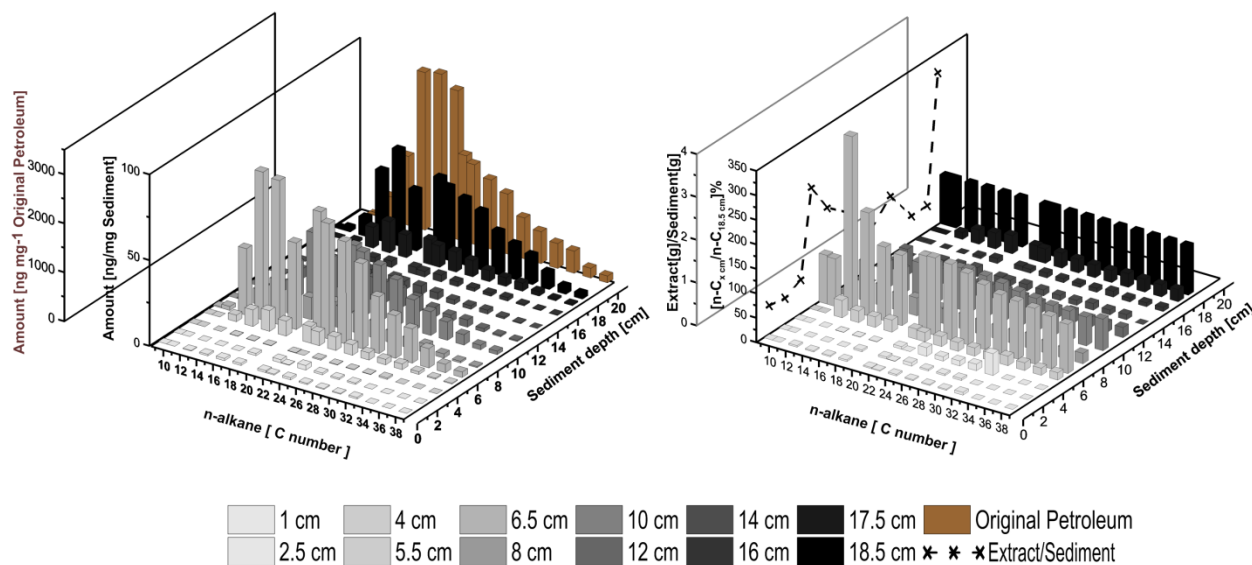

Figure 16. (Left) Vertical distribution of higher hydrocarbons (n-alkanes C10 to C38) in the Eckernförde core after the SOFT experiment. Surface sediment (0-2 cm) is excluded, due to possible influence from the overlaying oil slick that settled on the sediment during slicing of the core (see text). (Right) Relative decrease in the concentration of n-alkanes over depth. The relative concentrations are normalized against the deepest layer with the maximum concentration (18.5 cm). The dashed line with crosses shows the ratio of the weight of petroleum extract at each depth to the respective sediment weight and represents the movement of petroleum in the SOFT core.

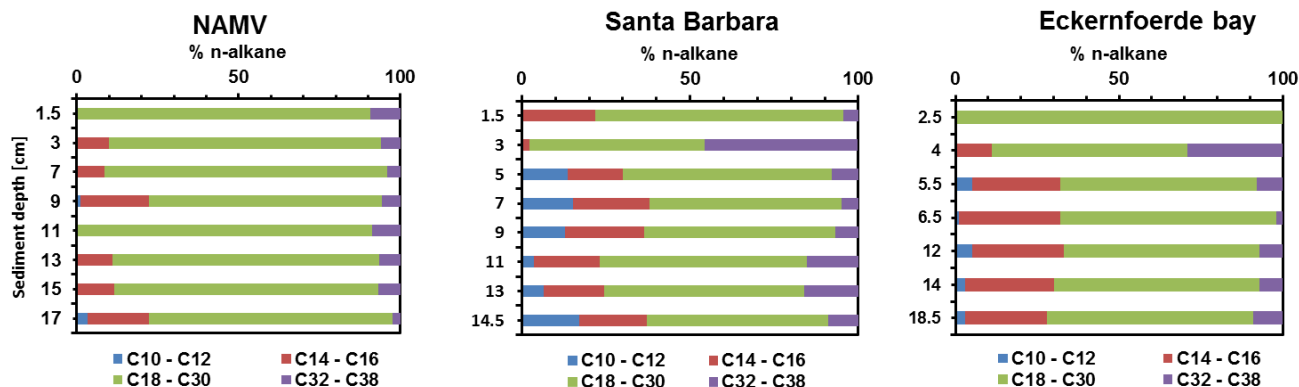

Figure 17. Relative contribution of individual n-alkanes to the total concentration of all measured n-alkanes at different depths. At every depth, the concentration of each individual n-alkane is divided by the concentration of total n-alkanes. For better visualization, the n-alkanes are grouped into four categories according to increasing C number (Group 1: C10 and C12; blue, Group 2: C14 and C16; red, Group 3: C18 – C30; green, Group 4: C32 – C38; purple).

4. Discussion

4.1 Sediment properties and migration of petroleum

Petroleum is made up of thousands of hydrocarbons. Presence of petroleum hydrocarbons leads to enrichment in organic carbon in marine sediments (Bauer et al., 1988). An upward flux of organic matter from deeper sources is a typical feature of marine seep sediments in contrast to non-seep sediments where the organic matter input is received from the water column above (Reed & Kaplan, 1977; Bauer et al., 1988). In the SOFT cores of all three sites NAMV, Santa Barbara, and Eckernfoerde Bay, the vertical profile of C_{org} aligned with the vertical profile of the petroleum extract weight (Fig. 3), indicating that the organic enrichment of the SOFT cores was a result of petroleum seepage. However, the C/N ratio in the fine grained sediments of Eckernfoerde Bay and NAMV was considerably lower than in the sandy Santa Barbara core. This difference could be due to the relatively higher organic carbon content in the Eckernfoerde Bay and NAMV sediments compared to the Santa Barbara sediment (Fig. 3) or the relatively lower amount of petroleum measured in the sediments compared to the Santa Barbara sediment (section 3.6, Fig. 14, 15, 16). Eckernfoerde Bay sediment is known to have a constant C/N ratio around 9 (by weight) as the organic carbon profiles of the sediment mostly corresponds the organic nitrogen (N) profile (Whiticar, 2002). Therefore, only a slight increase in the C/N ratio was observed as a result of petroleum addition (highest ratio being around 20 at 6.5 cm). In contrast to that, high C/N ratios up to 140 to 280 were observed in the Santa Barbara core, which was closer to the C/N ratio of petroleum (~170; Hunt, 1979). As the N content in the Santa Barbara core was very low (Fig. 3), it can be assumed that the increased organic carbon content and respective C/N ratio over depth was purely a result of petroleum addition. Increased organic carbon enrichment and C/N ratio over depth has also been observed in other studies on natural petroleum seeps from Santa Barbara and Gulf of Mexico (Bauer et al., 1988; LaMontagne et al., 2004) and Caspian sediment core in the SOFT system (Mishra et al., submitted).

In the Santa Barbara and NAMV cores, the porosity decreased over depth compared to the initial core while only a slight decrease was observed for the the Eckernfoerde Bay core.

We generally explain a decrease in porosity by the incomplete removal of petroleum (non-volatile fraction) during the freeze drying of the porosity analysis (Mishra et al, submitted). In the Santa Barbara core, the porosity at 13 cm decreased by half from 0.39 in the initial core to 0.16 in the SOFT core. Whereas in the fine-grained NAMV, the porosity only decreased by around 10 % at the deeper layers. The larger decrease in porosity in the Santa Barbara core could be due to the higher permeability of sand, which allows a fast passage of oil (Bjorlykke, 2010), combined with an already much lower pore space compared to the other sites. In Eckernfoerde Bay core, there was little change in the porosity and most of it was in the shallower depths (Fig. 2), which could be due to its fine grained sediment that does not allow the oil to permeate through the pore space that easily. A potential reason why the shallower depths in the Eckernfoerde Bay core seemed to be affected the most could be due to oil moving through polychaete burrows and accumulating somewhere further up in the sediment core (indicated by a peak in the petroleum extract between 6 and 10 cm), which might have led to decrease in the porosity mostly in the shallower depths. Movement of methane gas through burrows in the sediments of Eckernfoerde Bay has been described by Abegg & Anderson (1997) and Treude et al., (2005).

4.2 Penetration of oxic zone during petroleum seepage

Total oxygen uptake (TOU) is an indicator of benthic carbon mineralization (Canfield et al., 1993). Oxygen is the most favored electron acceptor in the benthic carbon degradation by aerobic bacteria and the reoxidation of reduced inorganic products from the anaerobic bacteria (Glud, 2008). The diffusive oxygen uptake (DOU) represents the microbial utilization of oxygen at the seafloor. In our SOFT system, a constant aeration of the overlying water in the SOFT core led to the establishment of an oxic zone in all the three sediment cores. As petroleum is the main organic carbon in our system, uptake of oxygen represents the aerobic microbial degradation of petroleum and its compounds in the SOFT cores. At the first measurement timepoint since the start of petroleum seepage, the aerobic microbial community were more active in Santa Barbara and NAMV sediments than in the Eckernfoerde Bay core i.e. the DOU in NAMV and Santa Barbara cores was 2 and 3 mmol m⁻² d⁻¹, respectively, whereas it was only 1 mmol m⁻² d⁻¹ in the Eckernfoerde Bay core (Fig. 4).

The highest DOU measured was around $4 \text{ mmol m}^{-2} \text{ d}^{-1}$ at all the three sites. While highest DOU value of $4.3 \text{ mmol m}^{-2} \text{ d}^{-1}$ was seen after around 130 days since that start of petroleum seepage in the Eckernfoerde Bay core, in the NAMV and Santa Barbara core the highest DOU was already seen within the first 90 days and 50 days, respectively. The lower DOU in the Eckernfoerde Bay core and the delayed response time (delayed increase in DOU) compared to the NAMV and Santa Barbara core might be explained by a low abundance of petroleum-degrading bacteria, as the site has no near-by petroleum seeps. It is known that degradation of petroleum in pristine sediments requires a longer lag phase than pre-adapted sediments (Committee on Oil in the Sea, 2003). The oxygen penetration depth was the highest in the Santa Barbara core at around 8 mm and around 2 cm and 4 cm in NAMV and Eckernfoerde Bay core, respectively. In natural marine environment, coarse grained sediment like sand can have oxygen penetraion depths from 5 to 25 cm, whereas in fine-grained sediments like mud and clay they are only a few millimeters deep (Bjorlykke, 2010).

4.3 Establishment of sulfate reduction zone and its response time to petroleum

Establishment of an active sulfate reduction zone was indicated in all the three cores by decreasing sulfate concentrations and increasing sulfide and alkalinity over depth and increased sulfate reduction rates (Fig 5, 6, 7). At all the three sites, petroleum seepage led to increased sulfate reduction activity indicating degradation of petroleum by sulfate-reducing bacteria (SRB). Presence of petroleum degrading SRB in the NAMV sediment core was further confirmed by phylogenetic studies (see section 4.4).

The high sulfide production and increased alkalinity in the NAMV SOFT core indicate degradation of petroleum by SRB via sulfate reduction. Although the direct measurement of sulfate reduction rates from the NAMV SOFT core are not available, we assume an increase after the petroleum seepage because of the high sulfide production and increased alkalinity. It should be noted here that before the start of the SOFT experiment, the NAMV core was stored for 5 years at $0 \text{ }^{\circ}\text{C}$ and all sulfate reduction activity would had probably stopped by the time we started the SOFT experiment. Therefore, an increased sulfate reduction activity must have been likely due to the petroleum seepage.

Integrated sulfate reduction rates in the initial Santa Barbara core were about $0.4 \text{ mmol SO}_4^{2-} \text{ m}^{-2} \text{ d}^{-1}$ (0-9 cm). These rates are lower compared to sulfate reduction rates measured in sediments from a nearby gas seep at the Brian Seep area in the Santa Barbara Channel that were in the range of 1.4 to $3.6 \text{ mmol SO}_4^{2-} \text{ m}^{-2} \text{ d}^{-1}$ (integrated over 0 to 10 cm) (Treude & Ziebis, 2010). However, upon subjection to the petroleum seepage, there was almost a 250 fold increase in the sulfate reduction rates in the Santa Barbara SOFT core compared to the initial core. The integrated sulfate reduction rates increased from $0.4 \text{ mmol SO}_4^{2-} \text{ m}^{-2} \text{ d}^{-1}$ in the initial core up to about $95.2 \text{ mmol SO}_4^{2-} \text{ m}^{-2} \text{ d}^{-1}$ in the SOFT core indicating sulfate reduction related to petroleum degradation.

Since sulfate reduction rates of the initial Eckernfoerde Bay sampling are not available, we compare with rates from another study (Bertics et al., 2013), from the identical sampling location and a corresponding sampling month (November). The integrated sulfate reduction in the Eckernfoerde Bay SOFT core were ca. 22 times higher than integrated rates measured by Bertics et al., (2013) between 0 and 18 cm ($\sim 7.5 \text{ mmol m}^{-2} \text{ d}^{-1}$), indicating increased activity of sulfate reducers due to petroleum seepage. It should be noted that we observed high sulfate reduction activity in the Eckernfoerde SOFT below 8 cm, i.e., in the methanogenic zone, where the sulfate was very low (up to $180 \text{ nmol cm}^{-3} \text{ d}^{-1}$ at 200 to $400 \text{ }\mu\text{M}$ sulfate). Sulfate reduction activity at very low sulfate concentrations in the methanogenic zone of marine sediments has been reported before (Holmkvist et al., 2011; Treude et al., 2014). In sediment cores from the Aarhus Bay in the Baltic Sea, this phenomenon was explained by the presence of a “cryptic sulfur cycle” where sulfate is formed from reoxidation of the downward diffusing sulfide by buried iron (Holmkvist et al., 2011). Presence and activity of sulfate-reducing bacteria was also confirmed in the methanogenic sediments of the Aarhus Bay (Leloup et al., 2009; Holmkvist et al., 2011). In sediment cores from the Alaskan Beaufort Sea continental margin, sulfate reduction rates in the methanogenic zone were explained by potential complex sulfur cycling consisting of sulfur oxidation and sulfur disproportionation by iron and manganese (Treude et al., 2014). However, in our SOFT core, the sulfate reduction activity was one to two orders of magnitude higher compared to the previous studies despite a similar range of sulfate concentrations. We therefore, speculate that the reason for such high activity were rather

experimental procedures, which might have caused slight intrusion of sulfate-rich porewater. Five days before the cores were sliced for sulfate reduction rate incubations and different analyses, porewater was extracted from the rhizons, which likely caused the drawdown of seawater from the supernatant and hence a smoothing of the sulfate profile. Furthermore, right before slicing the SOFT core, the rhizons that were permanently fixed to the cores had to be removed, which could have led to additional mixing of sulfate-rich porewater from the top to the deeper layers which could have triggered the high sulfate reduction activity. Addition of sulfate and some carbon sources like lactate and acetate, could also stimulate high sulfate reduction activity (a 10 to 40 fold increase in sulfate reduction rates) in sediments of the otherwise sulfate-limited methanogenic zone of the Aarhus Bay (Holmkvist et al., 2011).

Because of the different hydrocarbon seepage history of the three different sites, we expected a difference in the response time of microbial activity (sulfate reduction). We assumed sediments that were subjected to nearby hydrocarbon seeps have a shorter response time to petroleum seepage than the pristine sediment. In this study, sediment cores from NAMV and Santa Barbara are considered to be pre-adapted to hydrocarbon because of the nearby hydrocarbon seeps, whereas the sediment core from Eckernfoerde Bay was considered to be pristine without any prior subjection to natural or anthropogenic petroleum hydrocarbons. Based on the temporal development of sulfide production, the NAMV core had the shortest response time to petroleum addition, i.e., it had the shortest lag phase of sulfate reduction activity (Fig. 8). The onset of sulfate reduction activity must have taken place between 0 and 44 days (Fig. 8). The response time of sulfate reduction activity in the Eckernfoerde Bay core was around 130 days. Unexpectedly, the response time of sulfate reduction activity in the Santa Barbara core was much longer (also around 130 days as in the Eckernfoerde Bay sediment) although it was assumed to be a pre-adapted site due to the presence of nearby petroleum seepage (Hornafius et al., 1999).

The response times of sulfate reducers to petroleum seepage in the SOFT cores were further compared to those of sediment-oil slurries. In the Eckernfoerde sediment slurries, the response time for sulfate reduction was around 100 days, whereas in the SOFT core it

was around 130 day (Fig 8 and 9). In the NAMV sediment slurries, the response time was between 0 and 16 days, whereas in the SOFT core it was between 0 and 44 days (Fig 8 and 9). A direct estimate cannot be made between the NAMV slurries and SOFT core, because intermediate data between 0 and 44 days are missing for the SOFT core and the exact time of the first appearance of the sulfide peak cannot be interpolated. However, the comparison between the response times in the sediment slurries and the SOFT core from Eckernfoerde Bay throws light on the comparability of results obtained in a batch culture compared to a quasi-in situ condition while investigating petroleum degradation in marine sediments. The SOFT system is designed to maintain most of the natural physical and biogeochemical conditions in the sediment including heterogeneity and microniches (Mishra et al., submitted). Whereas in the sediment-oil slurries, conditions were homogenized and diluted. It is known that homogenization of sediments enhances degradation rates by reducing the distance between the microbial cells and their substrate (Harms & Bosma, 1997). Harms and Bosma (1997) presented the comparative results from studies of Zehnder and coworkers (Bachmann et al., 1988; Doelman et al., 1990; Huntjens et al., 1988; Rijnaarts & Bachmann, 1990) on bioremediation of soil contaminated with α -hexachlorocyclohexane (α -HCH) that showed that degradation is highly enhanced in homogenized sediment slurries compared to in situ degradation but is limited by desorption (Bachmann et al., 1988; Huntjens et al., 1988; Doelman et al., 1990; Rijnaarts & Bachmann, 1990; Harms & Bosma, 1997). To the best of our knowledge, the current study is the first study that provides a comparison between degradation of petroleum by sulfate-reducing bacteria in a natural (intact) sediment core and a homogenized sediment slurry under comparable conditions. Compared to their respective sediment-oil slurries, the response time of sulfate reduction in the Eckernfoerde Bay SOFT cores were around 30% longer.

4.4 Petroleum degrading sulfate reducers in North Alex sediments

Many known groups of hydrocarbon degraders belonging to the Deltaproteobacteria class were identified in both the initial and SOFT core of NAMV. Within the Desulfobacterales order, toluene degrading *Desulfobacula* spp. sequences (Rabus, 1993) were relatively

abundant in both the initial and SOFT core without much change before or after the petroleum seepage but the relative sequence abundance of SEEP-SRB1 cluster decreased in the SOFT core compared to the initial core. SEEP-SRB1a of the SEEP-SRB1 cluster is known to be a consortium partner of ANME-1 and ANME-2 involved in anaerobic methane oxidation (Knittel et al., 2003; Niemann et al., 2005). ANME-2 has been reported as one of the dominant methanotroph group in the NAMV seep sediments (Omeregic et al., 2009). If the SEEP SRB sequences detected in our SOFT core belonged to SEEP-SRB1a, a potential explanation for their relatively higher abundance of sequences in the initial core could be that they were present in consortium with the ANME-2. However, after the NAMV sediment core was dominated by an oil system (the SOFT core did not have a methanogenic zone and the petroleum used had < 1% methane), the relative sequence abundance of SEEP-SRB1 could have decreased in the sediment core due to the lack of methane supply and consequently, the absence of anaerobic oxidation of methane. While less abundant (~2%) in the initial core, the relative sequence abundance of *Desulfosarcina* spp. increased in the SOFT core (to ~6%). *Desulfosarcina* spp. is widely associated with marine seeps and some of its isolates are reported to be involved in degradation of short chain alkanes like butane and propane (Kniemeyer et al., 2007). Next to Deltaproteobacteria, the most abundant sequences belonged to the class Gammaproteobacteria in the initial sediment core. Gammaproteobacteria related to iron oxidation, sulfide oxidation and methane oxidation have been reported in microbial mats above a brine seep in the nearby Chefren mud volcano of the Eastern Mediterranean basin (Omeregic et al., 2008). Within Gammaproteobacteria class, an increase in the relative sequence abundance of *Marinobacter* spp. was seen in the SOFT core compared to the initial core. *Marinobacter* spp. is a moderately halophilic bacteria that is associated with aliphatic and aromatic hydrocarbon degradation (Duran, 2010), which might explain its increase in abundance of *Marinobacter* spp. in the the SOFT core. The increase in the relative sequence abundance of various hydrocarbon degrading bacteria after the SOFT experiment along with the observed sulfate reduction activity supports that the microbial community of NAMV sediments is capable of petroleum degradation during its seepage.

4.5 Establishment of methanogenic zone below sulfate reduction zone

In anoxic marine sediments, below the sulfate reduction zone where the sulfate is completely depleted, where CO₂ is the only electron acceptor available, degradation of organic matter is done by methanogenic archaea (methanogens) resulting in the formation of methane (Jorgensen, 2006). In the sulfate-reducing zone, sulfate reducers outcompete methanogens due to their better affinity for the mutual competitive substrates like H₂ and acetate, therefore, methanogens are mostly restricted to the methanogenic zone where sulfate is depleted (Oremland & Polcin, 1982). However, in the presence of non-competitive substrates like methyl amines, methanogens can also use those compounds and coexist with the sulfate reducers (Oremland & Polcin, 1982). Although methanogenic degradation of easily degradable organic compounds was known for a while, the possibility of methanogenic degradation of petroleum hydrocarbons was not recognized until recently (Zengler et al., 1999). So far, several laboratory batch cultures have been able to demonstrate degradation of petroleum hydrocarbons under methanogenic conditions (for example, Zengler et al., 1999; Jones et al., 2008; Jiménez et al., 2012). Methanogenic petroleum degradation was also seen in sediment cores from the Caspian Sea under natural conditions in a previous SOFT experiment (Mishra et al., submitted).

SOFT cores from Eckernförde Bay and Santa Barbara revealed a methanogenic zone below the penetration of sulfate. The methanogenesis observed in the SOFT core could be potentially related to the degradation of petroleum. In the NAMV core, a methanogenic zone probably did not establish, as sulfate was present through the entire length of the core (Fig. 5). The methanogenic potential of the organic-rich Eckernförde Bay sediment is well known (Martens et al., 1999; Whiticar, 2002; Treude et al., 2005a; Krüger et al., 2005), resulting in methane build-up and gas ebullition. The methane produced is of biogenic origin with $\delta^{13}\text{C}$ of methane in the range between -60‰ and -70‰ (Martens et al., 1999a; Whiticar, 2002). In the initial Eckernförde Bay core, high methane concentrations were found throughout the entire length of the sediment core (also when sulfate was still present) with concentrations as high as 907 μM (Fig 7). Concurrence of methanogenic and

sulfate reduction activity was found in the top 20 cm of Eckerfoerde Bay sediments, which was most likely fuelled by non-competitive substrates like methanol and methyl amines (Maltby, 2015). However, in the SOFT core, although low concentrations of methane (around 60 μM) were present until 10 to 12 cm, the first steep increase in methane concentration started only where the sulfate was nearly exhausted. This indicates that sulfate reducers outcompeted the methanogens in the use of petroleum and there was no non-competitive substrates available for the methanogens. The lower methane concentrations in the SOFT core ($\sim 507 \mu\text{M}$) compared to the initial core ($\sim 907 \mu\text{M}$) further indicates that the methanogens in the Eckernfoerde Bay sediment could be less efficient in using petroleum as a carbon source when compared to normal organic matter. The $\delta^{13}\text{C}$ signal of methane in the Eckernfoerde Bay SOFT core was in the range of -53 ‰ to -68 ‰ indicating biogenic origin (Whiticar, 1999), which might be linked to biodegradation of petroleum. In the Santa Barbara core, methane concentrations increased from a maximum of 117 μM at 8.5 cm in the initial sediment core to 260 μM at 13 cm in the SOFT core. We assume that the methane in the initial core could be due to the presence of methane seeps around the area (Treude & Ziebis, 2010). However, by the time the cores were sampled (see section 2.1), some of the methane might have been consumed due to anaerobic oxidation of methane. In the initial core, the $\delta^{13}\text{C}$ signal of methane was around -51‰ to -56‰ throughout the core, which is similar to values obtained from a nearby gas vent (-41‰ to -55 ‰, Treude & Ziebis, 2010). In the SOFT core, along with increasing concentrations of methane, a slight decrease in the $\delta^{13}\text{C}$ signal of methane was seen, indicating microbial methane formation (Fig. 10). Since the initial organic carbon content was very low in the Santa Barbara core (Fig. 3), it is very likely that the methanogenesis observed in the SOFT system might be linked to the degradation of the seeping petroleum. As the cores were collected from a highly aerated shallow beach area, it is unlikely that there would have been an abundant methanogenic community present in the cores already. We rather suggest that the methanogenic community, which established after the petroleum seepage and the generation of an reduced environment, was recruited from a rare biosphere (Sogin et al., 2006).

4.6 Vertical succession of hydrocarbons

Volatile n-alkanes of the petroleum (C1 to C6) were completely consumed in the upper 4 to 6 cm of the sediment core at all the three sites (Fig 13). As the top 6 cm of the sediment cores was a part of the sulfate reduction zone in all the cores, we postulate that volatile n-alkanes were degraded by sulfate reducers. Elevated sulfate reduction activity after petroleum seepage and depletion of short chain volatile n-alkanes together indicate that petroleum in the SOFT was degraded by sulfate-reducing bacteria. Anaerobic degradation of short-chain n-alkanes have only recently been reported in sediments from marine seeps (Kniemeyer et al., 2007; Kleindienst et al., 2014). A high diversity of sulfate-reducing bacteria have been found in NAMV sediments in this study, which further supports the degradation of n-alkanes by sulfate reduction. In a sediment core from the Caspian Sea that was incubated in the SOFT system, a similar trend of depletion of volatile n-alkanes in the upper 4 cm of the sulfate reduction zone was observed (Mishra et al., submitted). The two peaks of n-alkanes in the Eckernfoerde Bay and the NAMV core between 6 to 10 cm could be due to pockets of oil trapped within the sediment during migration. The pockets of trapped oil is further indicated by a peak in the C_{org} profile between 6 and 10 cm in the Eckernfoerde Bay core. Since, the sediment sections were not homogenized while slicing the SOFT core, the natural heterogeneity should be kept in mind (in this case, a lateral heterogeneity within a section). And the lateral variability at each depth within a sediment section would be higher in less permeable sediments than sediments with high permeability due to easier flow of fluid, which would then favor a more even spread of oil as is seen in the Eckernfoerde Bay and the NAMV cores. The higher n-alkanes (C10 to C38) exhibited a progressive decrease towards the surface (Fig 14,15,16). From the deepest layer to the surface layer, 90 to 100% depletion was detected. Similar trends of vertical succession in petroleum degradation were observed in a sediment core from an oil seep off the coast of West Africa (Wenger & Isaksen, 2002), oil samples from a Coal Oil Point seep (Wardlaw et al., 2008), and a sediment core from the Caspian Sea used in the SOFT system (Mishra et al., submitted). Their studies and the present study report microbial degradation

as the most important process in altering the composition of the petroleum during its ascent from the reservoir to the sediment surface. Comparison of the relative contribution of individual n-alkanes to the concentration of total n-alkanes at each depth indicated a preferential degradation of shorter chain n-alkanes (Fig. 17) during the vertical ascent of the total n-alkanes. A preferential degradation of shorter n-alkanes (upto C14) was also found in the previous SOFT experiment with a sediment core from the Caspian Sea (Mishra et al., submitted). However, the vertical distribution of the degradation pattern varied among the sediment cores of the current study (Fig. 16). For example, the C10 to C12 part of the total n-alkanes was completely depleted already within the ascent from 17 cm to 15 cm in the NAMV SOFT core. On the contrary, the C10-C12 group of the total n-alkanes remained more or less unchanged during the ascent in the Santa Barbara core and Eckernfoerde Bay core until about 5 cm. Similarly, the C14-C16 group only started to decrease after 6 to 7 cm in the the Santa Barbara core and Eckernfoerde Bay cores whereas a decreasing trend was seen already after 17 cm in the NAMV core. The different degradation patterns in the SOFT cores could be explained with the difference in the activity of sulfate reduction and their response times. The NAMV core had the highest activity (shortest response time and highest sulfide concentration) and the sulfate reduction zone present throughtout the core. This omnipresence of sulfate reduction might explain the rapid utilization of the lower chain n-alkanes already in the bottom part of the core. In the Santa Barbara and Eckernfoerde core, the highest sulfate reduction activity was found further up in the cores (Fig 6 and 7) and therefore, the shorter chain alkanes were probably degraded only after reaching the active sulfate reduction zone in these cores. The C18-C30 part of the petroleum during the vertical ascent was the most persistent group of the petroleum indicating their least preference by sulfate-reducing bacteria. It is well known that the susceptibility to degradation is dependent on the length of the chain of the n-alkanes, i.e. shorter chains are more suscpetible than longer chain n-alkanes (Wang et al., 1998). This is indicated in the present study where the microbial degradtion of C10 to C16 n-alkanes is preferred over their higher counterparts.

5. Conclusion

The biogeochemical response of sediment cores from North Alex Mud Volcano, Santa Barbara Channel and Eckernfoerde Bay to simulated petroleum seepage was investigated in the SOFT system under close in situ conditions and the following conclusions were drawn.

1. Our first hypothesis that petroleum seepage will affect the vertical distribution of redox processes, microbial community, and petroleum composition was confirmed by the successive change in petroleum composition over depth along with the temporal and spatial development of redox processes and microbial communities. We conclude that sulfate reduction is the most important anaerobic process that alters the composition of petroleum during its seepage in different kind of marine sediments. Short chain non-methane alkanes (ethane, propane, iso-butane, n-butane and pentane) were completely depleted in upper few centimeters of the sulfate-reducing zone.
2. Our second hypothesis that sediment cores from Santa Barbara and NAMV respond faster to petroleum addition than the Eckernfoerde Bay core because of pre-adaptation to nearby seepage could not be confirmed. Although NAMV indeed exhibited the fastest and highest activity in petroleum degradation, the lag phase of the Santa Barbara core was unexpectedly long. The response time of sulfate reduction for both, the Eckernfoerde Bay and Santa Barbara, was about 6 times longer (~130 days) than NAMV (~20 days). Another cause of this delay could be that the anaerobic community is not well established at beach sediments, which are constantly exposed to oxygen and tidal action and therefore, the response time of the sulfate reducers is longer, despite the sediment being pre-adapted to the presence of hydrocarbon seeps. Nevertheless, it is noteworthy that in case of a potential petroleum contamination at a beach, it might take much longer than expected for the microbes to be able to degrade the hydrocarbons.

3. Our third hypothesis about the overestimation of microbial response in sediment slurries compared to intact sediment cores was confirmed. The response time of sulfate reduction activity during degradation of petroleum in sediment slurries was around 30 % faster compared to the SOFT system. Therefore, while studying bioremediation of petroleum-contaminated sediments in slurry based experiments, an overestimation of the effective time should be considered. By using the SOFT system, we could provide a more realistic response time of the petroleum degrading sulfate reducers compared to sediment slurries. In investigating bioremediation in sediments, we suggest the use of experimental set ups that can facilitate more of the natural heterogeneity of the samples in order to get more realistic results.
4. The present study shows that even in oxygenated beach sediments, methanogenesis linked to petroleum degradation could take place by methanogenic archaea from a rare biosphere. Once their environment turns anoxic and reduced under petroleum contamination, methanogens from the rare biosphere might establish and get involved in the anaerobic degradation of petroleum.

Acknowledgements

We would like to thank the Deutsche Forschungsgemeinschaft (DFG) and DEA Deutsche Erdoel AG for funding this project. This work was a part of the SPP1319 project (DFG Priority Program) and the MICROBIOIL project (DEA Deutsche Erdoel AG and GEOMAR collaboration). We thank the Technical and Logistic Center GEOMAR (TLZ) for their technical support in building and maintaining the SOFT system. We also thank B. Domeyer, A. Bleyer and R. Surberg for their support in geochemical analyses. Philip Steeb is thanked for his support during the experiment. We would also like to thank S. Krause for his support in radiotracer injection and S. Bold and D. Ozod-Seradj for their help during the termination of the SOFT experiment.

References

- Abegg, F. & Anderson, A.L. (1997). The acoustic turbid layer in muddy sediments of Eckernförde Bay, Western Baltic: Methane concentration, saturation and bubble characteristics. *Marine Geology*. 137 (1-2). p.pp. 137–147.
- Bachmann, A., De Bruin, W., Jumelet, J.C., Rijnaarts, H.H. & Zehnder, A.. (1988). Aerobic biomineralization of alpha-hexachlorocyclohexane in contaminated soil. *Applied and Environmental Microbiology*. 54 (2). p.pp. 548–554.
- Bange, H.W., Bergmann, K., Hansen, H.P., Kock, A., Koppe, R., Malien, F. & Ostrau, C. (2010). Dissolved methane during hypoxic events at the Boknis Eck Time Series Station (Eckernförde Bay, SW Baltic Sea). *Biogeosciences Discussions*. 6 (6). p.pp. 11463–11477.
- Bauer, J.E., Montagna, P.A., Spies, R.B., Prieto, M.C. & Hardin, D. (1988). Microbial biogeochemistry and heterotrophy in sediments of a marine hydrocarbon seep. *Limnology and Oceanography*. 33 (6). p.pp. 1493–1513.
- Bertics, V.J., Löscher, C.R., Salonen, I., Dale, A.W., Gier, J., Schmitz, R.A. & Treude, T. (2013). Occurrence of benthic microbial nitrogen fixation coupled to sulfate reduction in the seasonally hypoxic Eckernförde Bay, Baltic Sea. *Biogeosciences*. 10 (3). p.pp. 1243–1258.
- Bjorlykke, K. (2010). *Petroleum geoscience: From sedimentary environments to rock physics*. Springer Science & Business Media.
- Canfield, D.E., Jorgensen, B.B., Fossing, H., Glud, R., Gundersen, J., Ramsing, N.B., Thamdrup, B., Hansen, J.W., Nielsen, L.P. & Hall, P.O. (1993). Pathways of organic carbon oxidation in three continental margin sediments. *Marine geology*. 113. p.pp. 27–40.

- Cord-Ruwisch, R. (1985). A quick method for the determination of dissolved and precipitated sulfides in cultures of sulfate-reducing bacteria. *Journal of Microbiological Methods*. 4 (1). p.pp. 33–36.
- Cravo-Laureau, C., Labat, C., Joulian, C., Matheron, R. & Hirschler-Réa, A. (2007). Desulfatiferula olefinivorans gen. nov., sp. nov., a long-chain n-alkene-degrading, sulfate-reducing bacterium. *International journal of systematic and evolutionary microbiology*. 57 (Pt 11). p.pp. 2699–702.
- Das, N. & Chandran, P. (2010). Microbial degradation of petroleum hydrocarbon contaminants: an overview. *Biotechnology research international*. 2011.
- Doelman, P., Haanstra, L., Loonen, H. & Vos, A. (1990). Decomposition of α - and β -hexachlorocyclohexane in soil under field conditions in a temperate climate. *Soil Biology and Biochemistry*. 22 (5). p.pp. 629–634.
- Dupré, S., Woodside, J., Foucher, J.P., de Lange, G., Mascle, J., Boetius, A., Mastalerz, V., Stadnitskaia, A., Ondréas, H., Huguen, C., Harmégnies, F., Gontharet, S., Loncke, L., Deville, E., Niemann, H., Omoregie, E., Olu-Le Roy, K., Fiala-Medioni, A., Dähmann, A., Caprais, J.C., Prinzhofer, A., Sibuet, M., Pierre, C. & Damsté, J.S. (2007). Seafloor geological studies above active gas chimneys off Egypt (Central Nile Deep Sea Fan). *Deep-Sea Research Part I: Oceanographic Research Papers*. 54 (7). p.pp. 1146–1172.
- Duran, R. (2010). Marinobacter. In: *Handbook of Hydrocarbon and Lipid Microbiology*. Springer Berlin Heidelberg, pp. 1725–1735.
- Ehrenreich, P., Behrends, a, Harder, J. & Widdel, F. (2000). Anaerobic oxidation of alkanes by newly isolated denitrifying bacteria. *Archives of microbiology*. 173 (1). p.pp. 58–64.
- Feseker, T., Brown, K.R., Blanchet, C., Scholz, F., Nuzzo, M., Reitz, A., Schmidt, M. & Hensen, C. (2010). Active mud volcanoes on the upper slope of the western Nile deep-sea fan—first results from the P362/2 cruise of R/V Poseidon. *Geo-Marine Letters*. 30 (3-4). p.pp. 169–186.
- Glud, R.N. (2008). Oxygen dynamics of marine sediments. *Marine Biology Research*. 4 (4). p.pp. 243–289.

- Glud, R.N., Gundersen, J.K., Jørgensen, B.B., Revsbech, N.P. & Schulz, H.D. (1994). Diffusive and total oxygen uptake of deep-sea sediments in the eastern South Atlantic Ocean: in situ and laboratory measurements. *Deep Sea Research Part I: Oceanographic Research Papers*. 41 (11-12). p.pp. 1767–1788.
- Harayama, S., Kishira, H., Kasai, Y. & Shutsubo, K. (1999). Petroleum biodegradation in marine environments. *Journal of molecular microbiology and biotechnology*. 1 (1). p.pp. 63–70.
- Harms, H. & Bosma, T.N.P. (1997). Mass transfer limitation of microbial growth and pollutant degradation. *Journal of Industrial Microbiology and Biotechnology*. 18 (2-3). p.pp. 97–105.
- Head, I.M., Jones, D.M. & Röling, W.F.M. (2006). Marine microorganisms make a meal of oil. *Nature reviews. Microbiology*. 4 (3). p.pp. 173–182.
- Herlemann, D., Labrenz, M. & Jürgens, K. (2011). Transitions in bacterial communities along the 2000 km salinity gradient of the Baltic Sea. *The ISME journal*. 5 (10). p.pp. 1571–1579.
- Holmkvist, L., Ferdelman, T.G. & Jørgensen, B.B. (2011). A cryptic sulfur cycle driven by iron in the methane zone of marine sediment (Aarhus Bay, Denmark). *Geochimica et Cosmochimica Acta*. 75 (12). p.pp. 3581–3599.
- Hornafius, J.S., Quigley, D. & Luyendyk, B.P. (1999). The world's most spectacular marine hydrocarbon seeps (Coal Oil Point, Santa Barbara Channel, California): Quantification of emissions. *Journal of Geophysical Research: Oceans (1978–2012)*. 104 (C9). p.pp. 20703–20711.
- Horowitz, a & Atlas, R.M. (1977). Continuous open flow-through system as a model for oil degradation in the arctic ocean. *Applied and environmental microbiology*. 33 (3). p.pp. 647–653.
- Hunt, M. (1995). *Petroleum geochemistry and geology*. WH Freeman and Company.
- Huntjens, J.M., Brouwer, W., Grobber, K., Jansma, O., Scheffer, F. & Zehnder, A.J. (1988). Biodegradation of alpha-hexachlorocyclohexane by a bacterium isolated from polluted

- soil. *Contaminated Soil'88*. p.pp. 733–799.
- Ivanenkov, V. & Lyakhin, Y. (1978). Determination of total alkalinity in seawater. *Methods of Hydrochemical Investigations in the Ocean*. p.pp. 110–114.
- Jiménez, N., Morris, B.E.L., Cai, M., Gründger, F., Yao, J., Richnow, H.H. & Krüger, M. (2012). Evidence for in situ methanogenic oil degradation in the Dagang oil field. *Organic Geochemistry*. 52. p.pp. 44–54.
- Jones, D.M., Head, I.M., Gray, N.D., Adams, J.J., Rowan, a K., Aitken, C.M., Bennett, B., Huang, H., Brown, A., Bowler, B.F.J., Oldenburg, T., Erdmann, M. & Larter, S.R. (2008). Crude-oil biodegradation via methanogenesis in subsurface petroleum reservoirs. *Nature*. 451 (7175). p.pp. 176–180.
- Jorgensen, B.B. (2006). Bacteria and marine biogeochemistry. In: *Marine Geochemistry*. Springer Berlin Heidelberg, pp. 169–206.
- Jørgensen, B.B. (1978). A comparison of methods for the quantification of bacterial sulfate reduction in coastal marine sediments. *Geomicrobiology Journal*. 1. p.pp. 11–27.
- Kallmeyer, J., Ferdelman, T.G., Weber, A., Fossing, H. & Jørgensen, B.B. (2004). A cold chromium distillation procedure for radiolabeled sulfide applied to sulfate reduction measurements. *Limnology and Oceanography-Methods*. 2 (6). p.pp. 171–180.
- Kleindienst, S., Herbst, F.A., Stagars, M., von Netzer, F., von Bergen, M., Seifert, J., Peplies, J., Amann, R., Musat, F., Lueders, T. & Knittel, K. (2014). Diverse sulfate-reducing bacteria of the Desulfosarcina/Desulfococcus clade are the key alkane degraders at marine seeps. *The ISME journal*. 8 (10). p.pp. 1–16.
- Kniemeyer, O., Musat, F., Sievert, S.M., Knittel, K., Wilkes, H., Blumenberg, M., Michaelis, W., Classen, A., Bolm, C., Joye, S.B. & Widdel, F. (2007). Anaerobic oxidation of short-chain hydrocarbons by marine sulphate-reducing bacteria. *Nature*. 449 (7164). p.pp. 898–901.
- Knittel, K., Boetius, A., Lemke, A., Eilers, H., Lochte, K., Pfannkuche, O., Linke, P. & Amann, R. (2003). Activity, Distribution, and Diversity of Sulfate Reducers and Other Bacteria in Sediments above Gas Hydrate (Cascadia Margin, Oregon). *Geomicrobiology Journal*. 20

(4). p.pp. 269–294.

- Krüger, M., Treude, T., Wolters, H., Nauhaus, K. & Boetius, A. (2005). Microbial methane turnover in different marine habitats. *Palaeogeography, Palaeoclimatology, Palaeoecology*. 227 (1-3). p.pp. 6–17.
- Kvenvolden, K.A. & Cooper, C.K. (2003). Natural seepage of crude oil into the marine environment. *Geo-Marine Letters*. 23 (3-4). p.pp. 140–146.
- LaMontagne, M.G., Leifer, I., Bergmann, S., Van De Werfhorst, L.C. & Holden, P.A. (2004). Bacterial diversity in marine hydrocarbon seep sediments. *Environmental Microbiology*. 6 (8). p.pp. 799–808.
- Leahy, J.G. & Colwell, R.R. (1990). Microbial degradation of hydrocarbons in the environment. *Microbiological reviews*. 54 (3). p.pp. 305–315.
- Leifer, I., Luyendyk, B. & Broderick, K. (2006). Tracking an oil slick from multiple natural sources, Coal Oil Point, California. *Marine and Petroleum Geology*. 23 (5). p.pp. 621–630.
- Leloup, J., Fossing, H., Kohls, K., Holmkvist, L., Borowski, C. & Jørgensen, B.B. (2009). Sulfate-reducing bacteria in marine sediment (Aarhus Bay, Denmark): Abundance and diversity related to geochemical zonation. *Environmental Microbiology*. 11 (5). p.pp. 1278–1291.
- Maltby, J. (2015). *Production of greenhouse gases in organic-rich sediments*. Christian Albrechts Universität zu Kiel.
- Martens, C., Albert, D. & Alperin, M. (1999). Stable isotope tracing of anaerobic methane oxidation in the gassy sediments of Eckernförde Bay, German Baltic Sea. *American Journal of Science*. 299 (7-9). p.pp. 589–610.
- Mishra, S., Stagars, M., Wefers, P., Schmidt, P., Knittel, K., Krüger, M. & Treude, T. (2015). Evolution of biogeochemical gradients and vertical succession of hydrocarbon degradation in Caspian Sea sediments subjected to simulated petroleum seepage. *Environmental Microbiology*. submitted.
- Niemann, H., Elvert, M., Hovland, M., Orcutt, B., Judd, A., Suck, I., Gutt, J., Joye, S., Damm, E.,

- Finster, K. & Boetius, A. (2005). Methane emission and consumption at a North Sea gas seep (Tommeliten area). *Biogeosciences*. 2. p.pp. 335–351.
- Omoregie, E.O., Mastalerz, V., de Lange, G., Straub, K.L., Kappler, A., Roy, H., Stadnitskaia, A., Foucher, J.-P. & Boetius, A. (2008). Biogeochemistry and Community Composition of Iron- and Sulfur-Precipitating Microbial Mats at the Chefren Mud Volcano (Nile Deep Sea Fan, Eastern Mediterranean). *Applied and Environmental Microbiology*. 74 (10). p.pp. 3198–3215.
- Omoregie, E.O., Niemann, H., Mastalerz, V., de Lange, G.J., Stadnitskaia, A., Mascle, J., Foucher, J.P. & Boetius, A. (2009). Microbial methane oxidation and sulfate reduction at cold seeps of the deep Eastern Mediterranean Sea. *Marine Geology*. 261 (1-4). p.pp. 114–127.
- Oremland, R.S. & Polcin, S. (1982). Methanogenesis and sulfate reduction: competitive and noncompetitive substrates in estuarine sediments. *Applied and environmental microbiology*. 44 (6). p.pp. 1270–1276.
- Quast, C., Pruesse, E. & Yilmaz, P. (2012). The SILVA ribosomal RNA gene database project: improved data processing and web-based tools. *Nucleic acids research*. p.gks. p.p. 1219.
- Rabus, R. (1993). Complete oxidation of toluene under strictly anoxic conditions by a new sulfate-reducing bacterium. *Applied and Environmental Microbiology*. 59 (5). p.pp. 1444–1451.
- Reed, W.E. & Kaplan, I.R. (1977). The chemistry of marine petroleum seeps. *Journal of Geochemical Exploration*. 7 (255-293).
- Rijnaarts, H. & Bachmann, A. (1990). Effect of desorption and intraparticle mass transfer on the aerobic biomineralization of alpha-hexachlorocyclohexane in a contaminated calcareous soil. *Environmental Science and Technology*. 24 (9). p.pp. 1349–1354.
- Schloss, P. & Westcott, S. (2009). Introducing mothur: open-source, platform-independent, community-supported software for describing and comparing microbial communities. *Applied and environmental microbiology*. 75 (23). p.pp. 7537–7541.
- Smetacek, V. (1984). Seasonal stages characterizing the annual cycle of an inshore pelagic

- system. *Rapports et Proces-Verbaux des Reunions Conseil International pour l'Exploration de la Mer*. 183. p.pp. 126–135.
- Smetacek, V. (1985). The annual cycle of Kiel Bight plankton: a long-term analysis. *Estuaries*. 8 (2). p.pp. 145–157.
- Sogin, M.L., Morrison, H.G., Huber, J. a., Welch, D.M., Huse, S.M., Neal, P.R., Arrieta, J.M. & Herndl, G.J. (2006). Microbial diversity in the deep sea and the underexplored 'rare biosphere'. *Proceedings of the National Academy of Sciences*. 103 (32). p.pp. 12115–12120.
- Sommer, S., Linke, P., Pfannkuche, O., Schleicher, T., Deimling, J.S. V., Reitz, A., Haeckel, M., Flögel, S. & Hensen, C. (2009). Seabed methane emissions and the habitat of frenulate tubeworms on the Captain Arutyunov mud volcano (Gulf of Cadiz). *Marine Ecology Progress Series*. 382. p.pp. 69–86.
- Steeb, P., Linke, P. & Treude, T. (2014). A sediment flow-through system to study the impact of shifting fluid and methane flow regimes on the efficiency of the benthic methane filter. *Limnology and Oceanography: Methods*. 12 (1). p.pp. 25–45.
- Treude, T., Krause, S., Maltby, J., Dale, A.W., Coffin, R. & Hamdan, L.J. (2014). Sulfate reduction and methane oxidation activity below the sulfate-methane transition zone in Alaskan Beaufort Sea continental margin sediments: Implications for deep sulfur cycling. *Geochimica et Cosmochimica Acta*. 144. p.pp. 217–237.
- Treude, T., Krüger, M., Boetius, A. & Jørgensen, B.B. (2005a). Environmental control on anaerobic oxidation of methane in the gassy sediments of Eckernförde Bay (German Baltic). *Limnology and Oceanography*. 50 (6). p.pp. 1771–1786.
- Treude, T., Niggemann, J., Kallmeyer, J., Boetius, a, Jorgensen, B.B., Wintersteller, P. & Schubert, C.J. (2005b). Anaerobic oxidation of methane and sulfate reduction along the Chilean continental margin. *Geochimica et Cosmochimica Acta*. 69 (11). p.pp. 2767–2779.
- Treude, T. & Ziebis, W. (2010). Methane oxidation in permeable sediments at hydrocarbon seeps in the Santa Barbara Channel, California. *Biogeosciences*. 7 (10). p.pp. 3095–

3108.

- Wang, Z., Fingas, M., Blenkinsopp, S., Sergy, G., Landriault, M., Sigouin, L., Foght, J., Semple, K. & Westlake, D.W.S. (1998). Comparison of oil composition changes due to biodegradation and physical weathering in different oils. *Journal of Chromatography A*. 809 (1-2). p.pp. 89–107.
- Wardlaw, G.D., Arey, J.S., Reddy, C.M., Nelson, R.K., Ventura, G.T. & Valentine, D.L. (2008). Disentangling oil weathering at a marine seep using GCxGC: Broad metabolic specificity accompanies subsurface petroleum biodegradation. *Environmental Science and Technology*. 42 (19). p.pp. 7166–7173.
- Wenger, L.M. & Isaksen, G.H. (2002). Control of hydrocarbon seepage intensity on level of biodegradation in sea bottom sediments. *Organic Geochemistry*. 33 (02). p.pp. 1277–1292.
- Whiticar, M.J. (1999). Carbon and hydrogen isotope systematics of bacterial formation and oxidation of methane. *Chemical Geology*. 161 (1). p.pp. 291–314.
- Whiticar, M.J. (2002). Diagenetic relationships of methanogenesis, nutrients, acoustic turbidity, pockmarks and freshwater seepages in Eckernfoerde Bay. *Marine Geology*. 182 (1-2). p.pp. 29–53.
- Widdel, F. & Bak, F. (1992). Gram-negative mesophilic sulfate-reducing bacteria. In: *The Prokaryotes*. Springer New York, pp. 3352–3378.
- Zengler, K., Richnow, H.H., Rosselló-Mora, R., Michaelis, W. & Widdel, F. (1999). Methane formation from long-chain alkanes by anaerobic microorganisms. *Nature*. 401 (6750). p.pp. 266–269.

Appendix for Chapter 6

Appendix 1. pH in SOFT cores at their respective first measurement point since the start of the SSOFT experiment.

NAMV		Santa Barbara		Eckernfoerde Bay	
Depth [cm]	pH	Depth [cm]	pH	Depth [cm]	pH
0	8.0	0	7.5	0	6.9
1	7.3	1	7.2	1	6.4
2	7.1	2	7.3	2	6.9
3	7.2	3	7.2	4	7.2
4	6.9	4	7.5	6	7.7
5	6.8	6	7.3	8	8.0
7	6.9	8	7.3	10	8.1
9	6.9	10	7.4	12	8.2
11	7.0			14	7.9
13	7.0			16	8.0
15	7.1			18	7.9
17	7.2				
19	7.2				

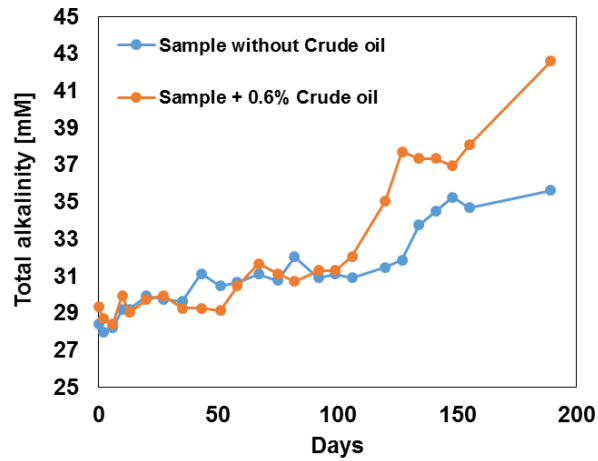

Appendix 2. Temporal development of total alkalinity in sediment-oil slurries from Eckernfoerde Bay. The sediment slurries were prepared with sulfate-reducing medium (dilution 1:7, sediment: seawater). 0.6% light crude oil from North Sea was added to the sediment slurries of Eckernfoerde. Control treatments were without any addition of crude oil.

7. Final Summary and Conclusion

Preface

This dissertation focuses on the geochemical and microbial dynamics of marine sediments that are subjected to petroleum seepage. New insights are provided into the biogeochemical response of different marine sediments to petroleum seepage and the fate of petroleum at marine seeps.

The study was conducted on:

1. Sandy sediments from a beach at the Caspian Sea, the largest enclosed basin on earth, known for its hydrocarbon reserves.
2. Fine grained sediments from the North Alex Mud Volcano, an active gas chimney associated with methane and gas emissions in the Eastern Mediterranean.
3. Sandy sediments from a beach at the Santa Barbara Channel; near the Coal Oil Point seep field (intense seep area)
4. Fine grained gassy and organic rich sediments from Eckernfoerde Bay in the Baltic Sea

The following sections will provide a brief summary and discussion of the work with their respective conclusions, and an outlook for future research at the end.

1. The SOFT system vs. sediment slurries, a better way to predict in situ processes?

Petroleum seeps are naturally occurring steady state chemostats that can act as excellent laboratories for investigating petroleum degradation in the marine environment (Hornafius, 1999; Wardlaw et al., 2008). Since most laboratory based studies on hydrocarbon degradation are done classically by the use of sediment slurries, the natural effect of a seep with respect to its flow, sediment heterogeneity and microniches, redox gradients etc. is not considered. Therefore, in this study, a continuous sediment-oil-flow-through (SOFT) system was designed that could use intact sediment cores to save the

natural heterogeneity and simultaneously maintain other environmental parameters close to in situ conditions. The system was used to comprehensively study the degradation of petroleum during its seepage in different marine sediments under quasi in situ conditions of a seep.

We hypothesized that the use of the SOFT system would provide a better understanding of the in situ petroleum degradation in marine sediments compared to the traditional use of sediment slurries. The hypothesis was confirmed by comparing the results from the SOFT system to results from sediment slurries where an overestimation of the microbial response to petroleum was seen (Chapter 6, section 3.3; Fig. 8 and 9). In sediment-oil slurries prepared with sediments from the Eckernfoerde Bay and sulfate rich anoxic artificial seawater medium, the onset of sulfate reduction activity (indicated by sulfide production) was seen after about 100 days. However, in the SOFT system, where an intact sediment core from the same location was used under similar environmental conditions (for example, temperature and type of crude oil), sulfate reduction activity was seen after about 130 days. Therefore, compared to the SOFT core, there was an overestimation of the microbial response in the sediment slurries. Furthermore, the SOFT system enabled not only the temporal monitoring of sulfate reduction activity but also the spatial monitoring of the sulfate reducing zone (distribution over depth) in the sediments in response to petroleum seepage. For example, the highest sulfate reduction in the Eckernfoerde Bay SOFT core was seen after 297 days between 5 and 12 cm. In contrast to the SOFT system, the effect of the vertical redox ladder of the marine sediments could not be included in the homogenized sediment slurries.

In conclusion, the present study suggests that the use of the SOFT system has an advantage over the use of sediment slurries in investigating in situ hydrocarbon degradation because several geochemical factors for example, the vertical redox cascade, the natural penetration of electron acceptors from the overlaying seawater into the sediment, and the sediment heterogeneity can be included in it in contrast to the sediment slurries.

2. Which are the major processes responsible for petroleum degradation along its natural migration pathway in marine seeps?

In seep sediments, the organic matter flux is from below, unlike non seep sites where the organic matter deposition takes place from above, through the overlaying water column. Some features like increasing organic carbon content and C/N ratios over depth are typical to marine seeps. As the deep marine sediments are largely anoxic, it should be expected that the anaerobic degradation of petroleum would be the most important process at marine seeps. However, the focus on the investigation of anaerobic degradation of petroleum is a relatively recent field (Widdel et al., 2010). Despite the increasing number of studies, there is still a gap in the knowledge of in situ degradation.

A vertical zonation of different redox processes was observed in the sediment cores undergoing petroleum seepage that was in line with the natural redox ladder of marine sediments. Sulfate reduction and methanogenesis were identified to be two major anaerobic processes involved in the in situ degradation of petroleum in marine sediments (see Table 1 for details). Distinct methanogenic zone, sulfate reducing zone and oxic zones were found during ongoing petroleum seepage in the sediment cores. Sulfate reduction rates increased after the onset of petroleum seepage at all sites, indicating the use of petroleum hydrocarbons by sulfate reducing bacteria (SRB) (see table 1 for details). This was further supported by the observed decrease in the concentrations of hydrocarbons, and the detection of sulfate reducing bacteria in the sediments (to be discussed in the following sections). Sulfate reduction was identified to be the most important process at all sites as most of the alkanes were degraded within this zone even before reaching the energetically more favorable oxic zone. In sediments from the Caspian Sea, the Santa Barbara Channel, and the Eckernfoerde Bay, a methanogenic zone was detected below the

sulfate reducing zone. The $\delta^{13}\text{C}$ signal of methane revealed biogenic methane formation at the three sites. For the Caspian Sea sediments, the biogenic methane formation could be linked to degradation of petroleum hydrocarbons through enrichment culturing of sediments from the methanogenic zone with substrates like hexadecane, methylnaphthalene, ethylbenzene and toluene as substrates. The highest rates of methanogenesis were found for hexadecane and methylnaphthalene (13.8 and 10.8 $\text{nmol}^{-1} \text{ml}^{-1}\text{d}^{-1}$ sediment, respectively). However, enrichment culturing with the sediments from the sulfate reducing zone also exhibited comparable rates of methanogenesis (16.7 and 12.8 $\text{nmol}^{-1} \text{ml}^{-1}\text{d}^{-1}$ sediment, respectively) which was not in line with the observation in the SOFT core. In the SOFT core, no methanogenesis was detected in the sulfate reducing core, indicating that in nature sulfate reducers outcompete the methanogens in the utilization of petroleum hydrocarbons as substrates.

In conclusion, we suggest that sulfate reduction is very likely the most important process in the degradation of petroleum at marine hydrocarbon seeps. Within the anoxic zone, sulfate reduction dominates over methanogenesis in the anaerobic oxidation of petroleum compounds, and most of the compounds get largely depleted within this zone even before they reach the energetically favorable oxic zone at the sediment surface.

Table 1. Overview of the sulfate reducing (SR) zone, sulfate reduction rates (SRR), methanogenic (MG) zone and methane production of all sites in the SOFT system. n.d = not detected, n.a = not available

Site	Length of SOFT core [cm]	Estimated zone with highest SR activity [cm]	Estimated MG zone [cm]	Initial Integrated SRR [mmol SO ₄ ²⁻ m ⁻² d ⁻¹]	Final Integrated SRR [mmol SO ₄ ²⁻ m ⁻² d ⁻¹]	Highest methane production in the MG zone [μM]
Caspian Sea	16	0-8	8-16	2.8 (0-16 cm)	5.7 (0-16 cm)	2226.0
NAMV	21	0-21	n.d	n.a	n.a	n.d
Santa Barbara	15	0-8	8-15	0.4 (0-9 cm)	95.2 (0-9 cm)	259.8
Eckernfoerde Bay	19	0-8 (highest) 8-16	16-19	~ 7.5 (0-18 cm; from Bertics et al., 2013)	167.8 (0-18.5 cm)	507.8

3. What is the succession of petroleum degradation along its natural migration pathway in marine seeps?

In general, we observed a step-wise progressive decrease in the amount of n-alkanes from the bottom of the core towards the sediment surface at all sites in the SOFT experiment (Chapter 4, Fig. 8; Chapter 6, Fig. 14, 15 and 16). In some cases there were peaks of n-alkane amounts in the middle of the cores, which could be attributed to pockets of trapped oil in some parts of the sediment layers as the sediments were not homogenized before sampling for oil analyses. However, at all sites the amount of n-alkanes tended to decrease towards the surface indicating degradation of petroleum during its vertical ascent. Furthermore, by comparing the contribution of the individual n-alkane amount to sum total amount of all n-alkanes, we observed a preferential degradation of lower chain n-alkanes (among C10 to C14 compared to C16 to C30 alkanes) during the upward migration of petroleum (Chapter 4, Fig. 9; Chapter 6, Fig. 17).

Increased sulfate reduction activity (previous section) and detection of alkane degrading sulfate reducers (next section) suggested that anaerobic microbial degradation of petroleum was responsible for the observed decrease in n-alkane amounts. The mid- to long chain n-alkanes (C10 to C40) started to decrease already within the bottom few centimeters of the core (i.e. within both the methanogenic and sulfate reducing zones). Therefore, we attribute their degradation to both sulfate reduction and methanogenesis. However, the short chain alkanes (ethane, propane, isobutane, n-butane, pentane and hexane) were mainly degraded in the upper few centimeters of the sediment cores (i.e. only within the sulfate reducing zone). The short chain volatile alkanes were almost completely depleted until petroleum reached the sediment surface. So far, anaerobic oxidation of isobutane has not been shown in any pure or enrichment culture, neither as a single substrate nor combined with other alkanes and is generally considered to be resistant to biodegradation (Kniemeyer et al., 2007; Jaekel et al., 2013; Musat, 2015). To the best of our knowledge, the present study provides the first laboratory based evidence for potential anaerobic degradation of isobutane by sulfate reduction activity during petroleum seepage. Detection of some known short chain alkane degrading bacterial sequences in the Caspian

Sea sediments (next section) further confirmed their degradation by sulfate reduction activity.

Based on the successive degradation of different n-alkanes over decreasing sediment depth, we conclude that mid- to long chain alkanes get degraded within both the methanogenic zone and sulfate reducing zone during the vertical ascent of petroleum. The short chain alkanes most likely escape the methanogenic zone undegraded until they get depleted within the sulfate reducing zone (Chapter 4, Fig. 7; Chapter 6, Fig. 8).

4. How are different microbial communities distributed along the natural pathway of petroleum in marine seeps?

In Chapter 5, the microbial (bacterial and archaeal) response to petroleum seepage was analyzed in detail in the Caspian Sea sediments to i) check if the microbial community composition changed after exposure to petroleum seepage, and to identify the potential hydrocarbon degraders, and ii) check if the microbial communities were vertically distributed in line with the observed zonation of redox processes and the successive degradation of the petroleum hydrocarbons.

Many known groups of sulfate reducing bacteria (SRB) involved in hydrocarbon degradation were detected, some of whose relative sequence abundance increased in the final core (after petroleum seepage) compared to the initial core (before petroleum seepage). Based on the increase in their specific CARD-FISH cell numbers, clade SCA1 for propane and butane degradation, clade LCA2 for mid- to long-chain alkane degradation, clade Cyhx for cycloalkanes, pentane, and hexane degradation, *Desulfobacula* for toluene and benzene degradation were identified as some of the key SRB that are likely to be involved in petroleum degradation in sediments of the Caspian Sea (Chapter 5, Fig. 4). Detection of these hydrocarbon degrading SRB supported the observed alkane degradation (previous section) in the sulfate reducing zone. The archaeal community significantly differed in the final core compared to the initial core. Sequences related to the genus

Methanosarcina were nearly absent in the initial core whereas in the SOFT core they constituted up to almost 38% of the total archaeal sequences in the methanogenic zone (correspondent with the increased methane production after petroleum seepage). Hydrocarbon degradation by *Methanosarcina* spp. has not been reported yet. However, since there was a specific increase in their cell numbers after petroleum seepage and their usual syntrophic partners like *Syntrophus* or *Desulfotomaculum* were absent, we speculate the involvement of a yet unknown bacterial partner of *Methanosarcina* spp. in the syntrophic hydrocarbon degradation.

Analysis of similarity in the Caspian Sea sediments revealed that the microbial communities (bacterial and archaeal) were significantly different from each other in different sediment layers supporting our hypothesis of a vertical distribution of the microbial communities over sediment depth during the upward migration of petroleum. This vertical distribution was also in line with the previously described geochemical zonation of different redox processes and the sequential alkane degradation in different sediment depths within the SOFT core. Furthermore, compared to the initial sediment core, the diversity of SRB decreased in the SOFT core indicating that degradation of petroleum is mediated by few specialized microbial communities under in situ conditions.

Therefore, we conclude that i) during the natural migration of petroleum, different hydrocarbon degrading microbial communities are established along the path of the migration and significant differences can occur between different sediment layers in the path of the petroleum migration and ii) exposure to petroleum can significantly change the microbial community composition of the original sediment.

5. How do different marine sediments respond to petroleum seepage?

The vertical zonation of different redox processes and the pattern of successive degradation in petroleum towards the surface was mostly similar at all sites. However, the

response time for sulfate reduction activity to the onset of petroleum seepage was different for different sediments based on their hydrocarbon history (Chapter 6, Fig. 8). The response time was defined as the time required for the first steep increase in sulfide concentration to occur in the SOFT cores. The sulfide concentrations were integrated over the entire length of the core for each time point. The integrated sulfide concentrations were then normalized by their respective maximum values and plotted over time (Fig. 1).

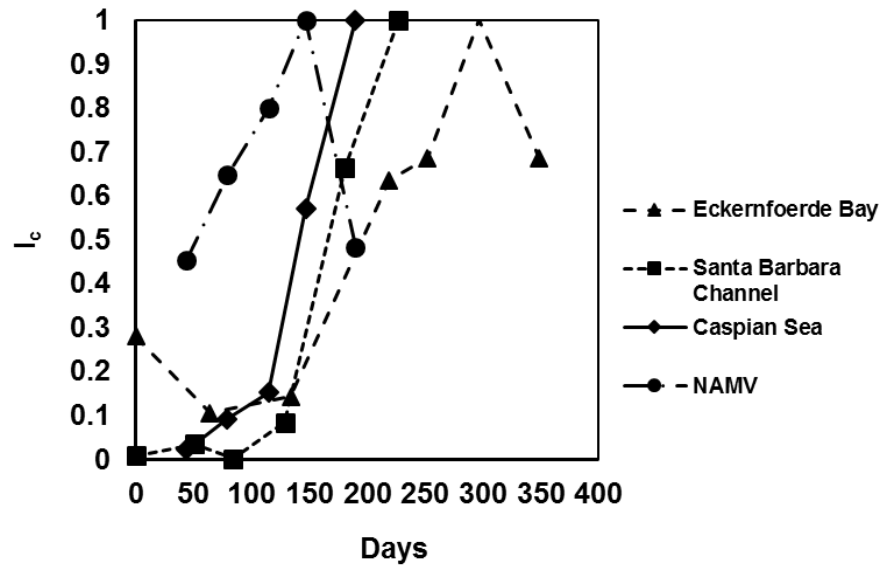

Figure 1. Response time of sulfate reduction in the SOFT cores after the start of petroleum seepage. Y-axis represents integrated sulfide concentrations (over depth) that are normalized by their respective maximum values (I_c). The x-axis represents the number of days since the start of the SOFT experiment. The appearance of first steep increase indicates the response time of the individual sediment core to petroleum seepage.

The sediments in NAMV were collected directly from a seep. Therefore, the microbial community of the NAMV sediment core was considered to have been the most adapted to hydrocarbons. The Caspian sediments were collected from a beach without a direct active seepage but were considered to be hydrocarbon adapted due to the prevalent petroleum contamination from nearby seeps and oil extraction activities. The Santa Barbara sediments cores were collected from a beach without a direct seepage but were considered to be preadapted to hydrocarbons due to the presence of nearby seepage activity. The

Eckernfoerde Bay sediments were considered to be pristine without any prior adaptation to hydrocarbon seepage. According to the estimated response times, the NAMV responded the fastest to petroleum seepage (~44 days) followed by the Caspian Sea (~115 days) and then the Santa Barbara (~130 days) and Eckernfoerde Bay sediments (~130 days) (Fig. 1).

Based on the faster response of pre-adapted sediments, we conclude that the microbial communities in naturally occurring hydrocarbon seeps or hydrocarbon contaminated regions respond faster to petroleum treatment compared to the microbial communities from non-adapted sediments. Although the Santa Barbara beach sediments were also considered to be pre-adapted, their relatively long response time (similar to Eckernfoerde Bay) suggests that the anaerobic microbial community might not have been well established in the initial sediments due to constant exposure to oxygen and tidal actions.

Outlook

Quantification of in situ rates:

The SOFT system provided evidence for degradation of petroleum under sulfate reducing and methanogenic conditions in an almost natural setting. However, since the hydrocarbons were sampled only twice, once during the initial sampling and once during the final sampling, the turnover rates of different alkanes could not be calculated. The system and the sampling techniques could be modified to provide a time series of hydrocarbon analyses, so that turnover rates of individual alkanes, as well as the rate of methanogenesis could be estimated for close in situ conditions of petroleum seepage.

Anaerobic oxidation of methane (AOM) in the presence of petroleum

The SOFT system could be modified to simulate a methane seep in the presence of petroleum to predict the extent of AOM in seeps that feature both methane and higher hydrocarbons. In the modified SOFT system, both methane and petroleum could be supplied from the bottom of the core, and sub samples could be used to measure both the AOM and sulfate reduction rates to see how they are coupled in a methane rich petroleum seep. The results obtained could then be used to study global methane emissions from seeps that feature both methane and petroleum.

References

- Bertics, V.J., Löscher, C.R., Salonen, I., Dale, A.W., Gier, J., Schmitz, R.A. & Treude, T. (2013). Occurrence of benthic microbial nitrogen fixation coupled to sulfate reduction in the seasonally hypoxic Eckernförde Bay, Baltic Sea. *Biogeosciences*. 10 (3). p.pp. 1243–1258
- Jaekel, U., Musat, N., Adam, B., Kuypers, M., Grundmann, O. and Musat, F. (2013). Anaerobic degradation of propane and butane by sulfate-reducing bacteria enriched from marine hydrocarbon cold seeps. *The ISME journal*, 7(5), pp.885-895.
- Kniemeyer, O., Musat, F., Sievert, S.M., Knittel, K., Wilkes, H., Blumenberg, M., Michaelis, W., Classen, A., Bolm, C., Joye, S.B. and Widdel, F.(2007). Anaerobic oxidation of short-chain hydrocarbons by marine sulphate-reducing bacteria. *Nature*, 449(7164), pp.898-901.
- Musat, F. (2015) The anaerobic degradation of gaseous, nonmethane alkanes —From in situ processes to microorganisms. *Computational and structural biotechnology journal*, 13, pp.222-228.
- Widdel, F., Knittel, K. and Galushko, A., (2010). Anaerobic hydrocarbon-degrading microorganisms: an overview. In *Handbook of hydrocarbon and lipid microbiology* (pp. 1997-2021). Springer Berlin Heidelberg.

Acknowledgements

First of all, a big thanks to Tina Treude for taking me as her PhD student, trusting me with this project and being a great supervisor. She always encouraged me to grow independently as a scientist and yet backed me up every time I could not figure things out on my own. And I can proudly say that I am one of those few lucky PhD students in this world for who the PhD comic (dated 29.01.2016) does not apply! I bet even from a different continent, my professor replied faster to my queries than most others would have done even while sharing the same building.

I want to thank Mark Schmidt and Katrin Knittel for being in my PhD committee and providing me guidance and assistance in this research project. I would like to thank Marion Stagars for a successful collaboration and her contribution to this thesis.

I want to thank all the members of Tina's working group; Marion Liebetrau, Gabreile Schlüssler, Peggy Wefers, Stefan Krause, Philip Steeb, Jessica Gier, Johanna Maltby and Skadi Lange for being so friendly and helpful. Having a warm atmosphere at work helped me miss home a little bit less in the cold and rainy Kiel.

I want to thank Peggy for being a wonderful team member of this PhD project. In this long roller coaster trip from trying to set up our *Miss Fancy Nancy GC-MS* for the oil analyses until shutting her down again at the end of the project, I could not have imagined a better team partner than Peggy.

A big thanks to my sunshine: Jessi, Johanna and Skadi. Sharing the PhD boat with them made life much easier and fun. Luckily, our occasional frustrating moments (default setting of pursuing a PhD) often alternated, so there was always at least one sane mind to listen to the rants of the one that was going crazy. Thanks to Jessi and Skadi for proof reading my chapters even on a short notice.

Thanks to Dirk Wehrend and Asmus Petersen for building the parts for the SOFT system and everyone else in GEOMAR who helped in carrying out this project.

I would like to thank my family and friends for their moral support throughout the PhD journey.

A huge thanks to Torsten Auerswald for being my pillar of strength; for the useful scientific discussions, emergency IT service, bearing me in the worst of my times, and a long list of many more things without which this PhD trip would have been much harder.

And a very, very special thanks to my parents, Sudha and Rabi Sankar Mishra, for having always morally supported and encouraged me in everything I wanted to do. Without their support, it would have never been possible to come this far in the first place.

