

Aciclovir resistance phenotype of
clinical isolates proven by targeted mutagenesis of
recombinant herpes simplex and varicella zoster
viruses

Dissertation
zur Erlangung des Doktorgrades
der Mathematisch-Naturwissenschaftlichen Fakultät
der Christian-Albrechts-Universität zu Kiel

vorgelegt von
Anne-Kathrin Brunnemann
aus Gotha

Kiel, Mai 2016

Erster Gutachter: Prof. Dr. med. Helmut Fickenscher

Zweiter Gutachter: Prof. Dr. rer. nat. Eric Beitz

Tag der mündlichen Prüfung: 08. Juli 2016

Zum Druck genehmigt: 08. Juli 2016

gez. Professor Dr. Wolfgang J. Duschl, Dekan

Abstract

The members of the human pathogenic α -herpesviruses herpes simplex virus (HSV) type 1 and 2 as well as varicella zoster virus (VZV) establish persistent infections of sensory ganglia and cause recurrent vesicular rashes. Especially immunocompromised patients suffer often from severe infections and need prolonged antiviral therapy at high dosage resulting in the emergence of resistance that is associated with sequence alterations of the affected viral enzymes. The nucleoside analog aciclovir (ACV) is the first line drug in such cases. Extended therapy often results in multiple amino-acid exchanges in the ACV-converting viral thymidine kinase (TK) of HSV. This multiplicity of polymorphisms and the difficulty of isolating clinical VZV hamper the precise assignment of the responsible nucleotide mutation to its resistance phenotype.

Here, the impact on ACV resistance of clinically relevant amino-acid mutations in the viral TK was assessed by the generation of virus recombinants that harbor one single TK mutation in an otherwise wild-type background. For this purpose, the genomes of HSV-1, HSV-2, and VZV which were cloned as bacterial artificial chromosome (BAC) were used for traceless sequence modifications by *en passant* mutagenesis in bacteria. First, a fluorescence reporter gene was inserted into a suitable genome position to monitor viral replication and to facilitate subsequent susceptibility testing. Based on the fluorescence-labeled and the basic BACs, the native TK-encoding genes were deleted and substituted with genes that harbored one single desired mutation. After virus reconstitution in permissive eukaryotic cells, the fluorescent virus strains exhibited replication capacities similar to their non-fluorescent counterparts and to the recombinant parental virus with wild-type configuration. Intact TK expression was demonstrated by detection of TK-specific transcripts and proteins. Furthermore, the correlation between the relative fluorescence intensity and the viral load was shown. Using the fluorescent virus strains, the antiviral action of ACV was examined by measuring the relative fluorescence. The impact of single amino-acid exchanges on ACV resistance was determined by calculating the 50% effective concentrations and by quantifying the viral loads in presence or absence of ACV.

Thus, each selected amino-acid mutation with so far ambiguous significance was precisely attributed to a natural or to a resistance-associated polymorphism for each virus recombinant generated. This forms the basis for improved molecular resistance diagnostics and for an improved guidance of antiviral therapy.

Zusammenfassung

Die Vertreter der humanpathogenen α -Herpesviren Herpes-Simplex-Virus (HSV) 1 und 2 sowie das Varicella-Zoster-Virus (VZV) etablieren persistente Infektionen sensorischer Ganglien und verursachen wiederkehrende, vesikuläre Exantheme. Besonders immungeschwächte Patienten leiden oft unter schwerwiegenden Infektionen und benötigen eine hochdosierte und andauernde antivirale Therapie, die zur Entstehung von Resistenzen führt, die mit Sequenzveränderungen der betroffenen viralen Enzyme einhergehen. Das Nukleosid-Analogon Aciclovir (ACV) ist das Mittel der ersten Wahl bei solchen Fällen. Die andauernde Behandlung führt oft zu mehrfachen Aminosäure-Austauschen in der ACV-umsetzenden viralen Thymidinkinase (TK) von HSV. Diese Mehrzahl von Polymorphismen und die Schwierigkeit, VZV aus klinischen Proben zu isolieren, erschweren die eindeutige Zuordnung der verantwortlichen Nukleotid-Mutationen zu ihrem Resistenz-Phänotyp.

Hier wurde die Auswirkung der klinisch relevanten Aminosäure-Mutationen in der viralen TK auf ACV-Resistenz beurteilt, indem rekombinante Virusstämme hergestellt wurden, die eine einzige TK-Mutation in einem ansonsten Wildtyp-Hintergrund aufweisen. Zu diesem Zweck wurden die als bakterielles artifizielles Chromosom (BAC) klonierten Genome von HSV-1, HSV-2 und VZV für die spurlose Sequenzmodifikation durch die *en passant* Mutagenese in Bakterien verwendet. Zuerst wurde ein Fluoreszenz-Reporter-Gen in eine geeignete Genomposition eingebracht, so dass die Virusreplikation beobachtet und die folgende Empfindlichkeits-Testung erleichtert wurde. Ausgehend von den Fluoreszenz-markierten und den originalen BACs wurden die ursprünglichen TK-kodierenden Gene entfernt und gegen Gene ausgetauscht, welche eine einzige gewünschte Mutation enthielten. Nach der Virus-Rekonstitution in permissiven, eukaryonten Zellen zeigten die Fluoreszenz-markierten Virusstämme ein ähnliches Replikationsvermögen wie ihr nicht-fluoreszierendes Gegenstück und wie das rekombinante Ausgangsvirus mit Wildtyp-Konfiguration. Die intakte TK-Expression wurde durch den Nachweis spezifischer Transkripte und Proteine aufgezeigt. Zudem wurde die Korrelation der relativen Fluoreszenzintensität mit der Viruslast festgestellt. Mit Hilfe der Fluoreszenz-markierten Virusstämme wurde die antivirale Wirkung von ACV durch eine relative Fluoreszenzmessung ermittelt. Die Auswirkung einzelner Aminosäure-Austausche auf die ACV-Resistenz wurde durch die Berechnung der zu 50% effektiven Konzentration und durch die Quantifizierung der Viruslast in Anwesenheit und Abwesenheit von ACV bestimmt.

Somit konnte jede ausgewählte Aminosäure-Mutation mit bisher unklarer Bedeutung eindeutig einem natürlichen oder einem Resistenz-assoziierten Polymorphismus für jede hergestellte Virusrekombinante zugeordnet werden. Dies bildet die Basis für eine verbesserte molekulare Diagnostik und für eine verbesserte Führung der antiviralen Therapie.

TABLE OF CONTENTS

ABSTRACT	2
ZUSAMMENFASSUNG	3
TABLE OF CONTENTS	4
ABBREVIATIONS	7
1 INTRODUCTION	9
1.1 Human pathogenic α-herpesviruses	9
1.1.1 Diseases caused by herpes simplex viruses	10
1.1.2 Diseases caused by varicella zoster virus	11
1.1.3 Prevalence and mortality	12
1.2 Prevention, prophylaxis, and treatment of α-herpesvirus infections	13
1.2.1 Antiviral treatment by vaccination	14
1.2.2 Present antiviral chemotherapeutics and their mechanisms of action	15
1.2.3 Development of resistance against antiherpetic drugs	17
1.2.4 Development of novel antiherpetic drugs	18
1.2.5 Conventional and unconventional susceptibility testing	19
1.3 Recombination techniques and herpesvirus genome manipulation	20
1.3.1 Organization of α -herpesvirus genomes and the appropriate viral BACs	21
1.3.2 Site-directed mutagenesis of BACs by two-step <i>en passant</i> mutagenesis	23
1.4 Project objectives	24
2 MATERIALS AND METHODS	26
2.1 Materials	26
2.1.1 Technical devices	26
2.1.2 Chemicals and biological reagents	27
2.1.3 Stock solutions, buffers, and media	29
2.1.4 Plasmids, BACs, bacteria, viruses, and cell lines	30
2.1.5 Software programs and databases	30

2.2 Generation of recombinant herpesvirus variants	31
2.2.1 Cloning of plasmid-based transfer vectors	31
2.2.1.1 Polymerase chain reaction with Phusion™ polymerase	31
2.2.1.2 Agarose gel electrophoresis and extraction of DNA fragments	33
2.2.1.3 DNA cloning and transformation into competent <i>E. coli</i>	33
2.2.1.4 Small-scale extraction of plasmid DNA	34
2.2.1.5 Site-directed mutagenesis	34
2.2.1.6 DNA sequencing	36
2.2.2 Modification of BAC-based viral genomes	36
2.2.2.1 PCR with HotStarTaq® polymerase	37
2.2.2.2 Transformation into <i>E. coli</i> and first homologous recombination step	37
2.2.2.3 Second Red-mediated recombination step	38
2.2.2.4 Fragment analysis	38
2.2.2.5 Application of <i>en passant</i> mutagenesis	38
2.2.2.6 Large-scale preparation of BAC-DNA	40
2.3 Cultivation of recombinant virus strains in permissive cell lines	40
2.3.1 Transfection of permissive eukaryotic cells and virus reconstitution	40
2.3.2 Culture of HSV on permissive Vero cells	41
2.3.2.1 Titration of cell-free virus	41
2.3.2.2 One-step replication kinetics of HSV-1	41
2.3.2.3 Multi-step replication kinetics of HSV-2	42
2.3.3 VZV culture on permissive Melanoma cells	42
2.3.3.1 Titration of cell-associated viruses	42
2.3.3.2 Multi-step replication kinetics of VZV	43
2.4 Gene expression analysis	43
2.4.1 Reverse-transcription polymerase-chain reaction	43
2.4.2 Protein expression analysis	44
2.4.2.1 Antibodies	44
2.4.2.2 Immunoblotting	45
2.4.4.3 Indirect immunofluorescence assay	45
2.5 Susceptibility testing on infected cells	46
2.5.1 CPE inhibition assay of HSV	46
2.5.2 Plaque reduction assay of VZV	47
2.5.3 Quantitative polymerase-chain reaction	47

3 RESULTS	49
3.1 Generation and verification of manipulated HSV and VZV BACs _____	49
3.2 Suitability of the recombinant mutant viruses _____	59
3.3 Susceptibility testing of recombinant virus strains _____	67
4 DISCUSSION	73
4.1 Traceless modification of herpesvirus genomes by <i>en passant</i> mutagenesis _____	73
4.2 Suitable recombinant virus strains with expression of <i>tk</i> gene variants _____	75
4.3 Unambiguous assignment of single amino-acid exchanges from clinical samples to the resistance phenotype _____	77
4.3.1 HVS-1 TK polymorphisms and resistance mutations	77
4.3.2 HVS-2 TK polymorphisms and resistance mutations	80
4.3.3 VZV TK polymorphisms and resistance mutations	83
4.4 Advantages and disadvantages of diagnostic methods for susceptibility testing _____	84
5 REFERENCES	87
ACKNOWLEDGEMENTS	101

ABBREVIATIONS

ACV	aciclovir
AIDS	acquired immunodeficiency syndrome
ATP	adenosine triphosphate
BAC	bacterial artificial chromosome
bp	base pairs
BVDU	brivudine
CCD	coupled charge device
cDNA	complementary DNA
CDV	cidofovir
CPE	cytopathic effect
DMSO	dimethylsulfoxide
DNA	deoxyribonucleic acid
dNTP	deoxynucleoside triphosphate
ds	double strand
<i>E. coli</i>	<i>Escherichia coli</i>
EDTA	ethylene diamine tetraacetic acid
EF-1 α	elongation factor 1 alpha
EGFP	enhanced green fluorescent protein
F-plasmid	fertility plasmid
FBS	fetal bovine serum
FCV	famciclovir
Flp	flippase; Flp- <i>FRT</i> system
FOS	foscarnet
<i>FRT</i>	Flp recognition target
GAPDH	glyceraldehyde 3-phosphate dehydrogenase
HCMV	human cytomegalovirus
HIV	human immunodeficiency virus
HRP	horse radish peroxidase
HSCT	hematopoietic stem cell transplantation
HSV	herpes simplex virus
IRL/S	internal repeat of the UL or US region
kb	kilo base
LB	lysogeny broth
MEM	minimum essential medium
mRFP	monomeric red-fluorescent protein

nt	nucleotide
OD	optical density
ORF	open reading frame
PAGE	polyacrylamide gel electrophoresis
PBS	phosphate buffered saline
PCR	polymerase chain reaction
PCV	penciclovir
PFU	plaque forming unit
PHN	postherpetic neuralgia
<i>pol</i>	polymerase gene
PP _i	pyrophosphate
PRA	plaque reduction assay
RFLP	restriction fragment length polymorphism
RFU	relative fluorescence unit
RNA	ribonucleic acid
RT	reverse transcriptase
SD	standard deviation
SDS	sodium dodecyl sulfate
SNP	single nucleotide polymorphism
TBE	tris/borate/EDTA buffer
TEM	transmission electron micrograph
TEMED	tetramethylenediamine
TK	thymidine kinase protein
<i>tk</i>	thymidine kinase gene
TRL/S	terminal repeat of the UL or US region
U	unit
UL	unique long region
US	unique short region
UV	ultraviolet
VACV	valaciclovir
VZV	varicella zoster virus

1 INTRODUCTION

1.1 Human pathogenic α -herpesviruses

The large family of the *Herpesviridae* comprises eight human pathogenic viruses belonging to the α -, β -, and γ -*Herpesvirinae*. The α -*Herpesvirinae* subfamily comprises the genera *Simplexvirus* with the species herpes simplex virus (HSV) type 1 and 2 and *Varicellovirus* with the varicella zoster virus (VZV) as unique human representative (Pellett et al., 2011). The infectious particles consist of a double-stranded (ds) linear DNA genome that is associated with a protein core. The DNA and the core are enclosed into a capsid consisting of 162 capsomers forming an icosahedron. The tegument, a proteinaceous layer, covers the capsid and is surrounded by the lipid envelope that incorporates virus-encoded glycoproteins (Fig. 1.1) (Cohen et al., 2007; Roizman et al., 2007).

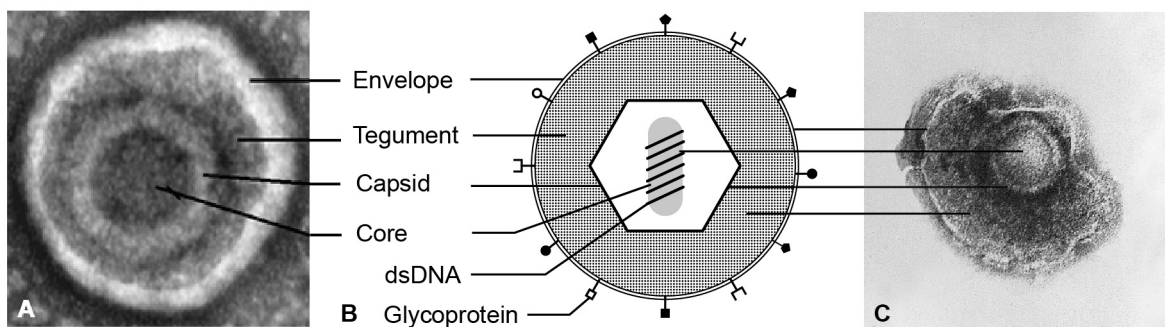

Fig. 1.1: Structure of the α -herpesvirus virion. **A** Transmission electron micrograph (TEM) of an HSV-1 virion (figure panel from Roizman et al., 2007) with indicated envelope, tegument, capsid, and core, which are also assigned to a scheme (**B**) of the virus particle with the double-stranded (ds) DNA and the glycoproteins. **C** TEM picture with component assignment of a varicella zoster virion (from Public Health Image Library, PHIL; www.phil.cdc.gov, ID#1878).

These viruses cause infectious diseases which become evident as rash with blisters. References about genital skin lesions similar to those caused by HSV-2 date back as far as 1,500 BC. Later in time, these observations were characterized by the Greek term $\epsilon\rho\pi\eta\varsigma$ that describe the creeping or crawling spread of the rash which had already been recognized as recurring. Now we know that α -herpesviruses are capable to remain latent throughout life in sensory ganglia after primary infection and can be reactivated by certain stimuli (Oakley et al., 1997; Roizman et al., 2007; Stevens and Cook, 1971). The periodical occurrence of clinical symptoms (reactivation) allows the transmission within the population by the contact to contagious vesicle content. These viruses can also productively infect epithelial cells of mucous membranes and skin but they differ in their clinical course (Whitley and Gnann, 1993).

1.1.1 Diseases caused by herpes simplex viruses

Primary infection with HSV-1 mostly occurs during infancy and childhood and can remain asymptomatic or result for instance in ulcerative and vesicular labial lesions or gingivostomatitis (Fig. 1.2) (Corey and Spear, 1986; Rustigian et al., 1966). Reactivated infection is most frequently associated with lesions at the lip border (herpes labialis) or of the oropharyngeal mucosa and accompanied by symptoms such as pain, tingling, or itching. Triggers for reactivation are immunosuppression, exposure to UV light, or stress (Miller et al., 1998; Norval, 2006; Taylor et al., 1994). Rarely, HSV-1 can cause non-oral lesions such as on fingers (herpetic whitlow), at sites of skin abrasion (herpes gladiatorum), or on the eyelids (herpes blepharitis) (Fatahzadeh and Schwartz, 2007). While these diseases are rather mild with rapid healing within ten days (Lynch, 2000), other HSV-1 infections are more serious and devastating. A herpetic keratitis can also lead to corneal blindness (Sudesh and Laibson, 1999); herpes simplex encephalitis can result in necrosis and hemorrhage of the temporal lobe and may even lead to death (Singh et al., 2016). Recently, the contribution of HSV-1 infection to Alzheimer disease was discussed (Ball et al., 2013; McNamara and Murray, 2016). Traditionally, infections caused by HSV-1 were assumed to be restricted to body regions above the waist whereas infection with HSV-2 were thought to happen below the waist.

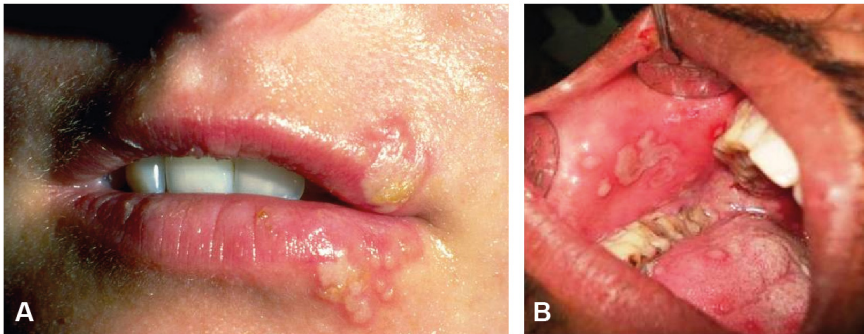

Fig. 1.2: Clinical manifestation of **A** herpes labialis (from Hartmann et al., 2010) and **B** herpetic gingivostomatitis (from Mohan et al., 2013).

In contrast to HSV-1, the primary infection with HSV-2 (herpes genitalis) is most frequently acquired upon onset of sexual activity and is one of the most common sexually transmitted diseases (Corey, 1990). Unless an asymptomatic course of infection occurs, lesions appear normally on the vulva involving the cervix and vagina in women and on the glans penis or the penile shaft in men (Fig. 1.3). Recurrent infections as genital ulcer disease are often accompanied with a shorter time course and fewer lesions of the genital vesicular rash (Corey et al., 1983). The major risk of primary HSV-2 infection for the child exists during birth.

Such neonates may develop severe septicemia-like disseminated disease (herpes neonatorum), which is often combined with acute encephalitis, pneumonia, rash, blindness, and even death at high frequency (Stephenson-Famy and Gardella, 2014). Concerning the adolescent population, one adverse effect of acute HSV-2 infection is a threefold higher risk of human immunodeficiency virus type 1 (HIV-1) acquisition and up to 50% of HIV infections are acquired by individuals with preceding genital herpes (Freeman et al., 2006; Wald and Link, 2002).

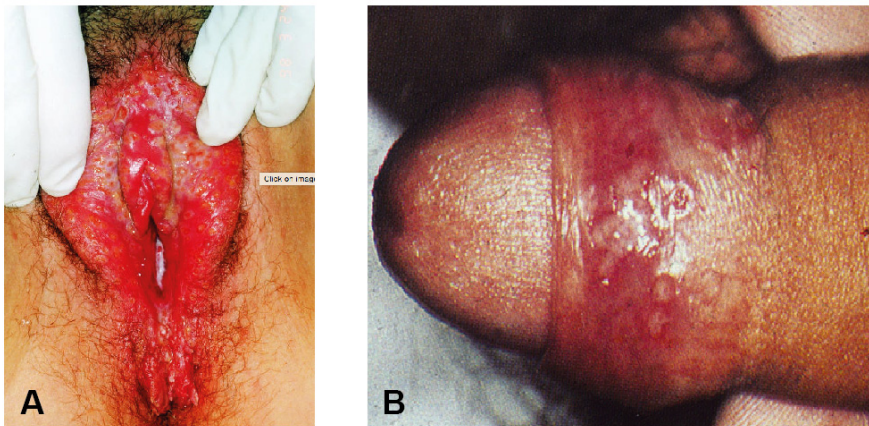

Fig. 1.3: Clinical manifestation of A genital herpes of a female (from Drake et al., 2000) or B genital herpes of a man (from Fatahzadeh and Schwartz, 2007).

1.1.2 Diseases caused by varicella zoster virus

The third human pathogenic α -herpesvirus is the varicella zoster virus (VZV), which is less closely related to HSV-1 and HSV-2 than the latter to each other according to their genome sequence (Baines and Pellett, 2007). Unlike HSV, VZV is mainly transmitted by infectious aerosols via the mucous membranes (Arvin et al., 1996). Transmission by contagious content from vesicles is also possible. Primary infection usually occurs during childhood and causes a disseminated rash known as chickenpox or varicella (Fig. 1.4A). The disease is self-limiting for children and immunocompetent patients. Infections during early pregnancy can lead to the congenital varicella syndrome involving limb deformation or damage of the brain or the eye (Michie et al., 1992). Perinatal VZV infections have a high rate of lethal complications. VZV remains latent in the trigeminal ganglia or the sensory ganglia of the spinal cord (dorsal root ganglia) and is usually reactivated with increasing age or with immunosuppression (Weinberg et al., 2010). The reactivated form of disease is known as shingles or herpes zoster and appears as cutaneous lesions that are restricted to dermatomes (Fig. 1.4B), which are innervated by the affected sensory ganglia. The most common complication of herpes zoster is the postherpetic neuralgia (PHN), a persisting

neuropathic pain that is associated with hypersensitivity of the affected skin area to touch and temperature. The chronic pain syndrome can persist for long periods even if the rash has healed (Quinlivan et al., 2011).



Fig. 1.4: Clinical manifestations of A chickenpox on the thorax of a child (from Wutzler et al., 2008) and of **B** herpes zoster on the thorax of an adult (from Massengill and Kittredge, 2014).

1.1.3 Prevalence and mortality

Herpes simplex virus infections are common, lifelong, and ubiquitous. The primary infection with HSV-1 and HSV-2 often occurs asymptotically and the prevalence is determined by presence of IgG antibodies (Ohana et al., 2000). Overall, approximately 60% to 95% of people are seropositive for one or both of the viruses (Brady and Bernstein, 2004). The serostatus converts with increasing age, sexual activity and differs between genders and ethnic groups. In the United States, the seroprevalence for HSV-1 had been estimated 53.9% and 15.7% for HSV-2 between 2005 and 2010 (Bradley et al., 2014; Schulte et al., 2014). A closer look at eight European countries revealed large differences in seropositivity for HSV-1 ranging from 52% in Finland to 84% in Bulgaria and from 4% in England to 24% in Bulgaria for HSV-2 (Pebody et al., 2004). Due to the increased risk for HIV acquisition upon acute HSV-2 infection, the incidence of HSV-2 received more attention especially for developing countries. For example, parts of sub-Saharan Africa have prevalence rates up to 80% (Paz-Bailey et al., 2007). On the other hand, HSV-1 contributes to an increasing incidence of genital herpes in industrialized countries depending on changes in sexual behavior (Bernstein et al., 2013; Gilbert et al., 2011). Mortality by HSV infections is particularly caused by herpes simplex encephalitis with rates up to 19% even if patients received antiviral treatment (Gnann et al., 2015). A very high case-fatality-rate of 26% was reported for HSV-2 infected neonates (Lopez-Medina et al., 2015).

The incidence of VZV infection depends mainly on the climate but also on the social environment and age. VZV is a highly contagious agent. Acquisition usually occurs during

childhood with at least four million episodes that arose annually in the United States prior to vaccine introduction in 1995. This value represented an incidence of approximately 90% among children younger than 15 years with 145 varicella-related deaths per year (Kanra et al., 2002; Nguyen et al., 2005; Wharton, 1996). By the age of 50 at latest, the seroprevalence was at 99% or higher (Fairley and Miller, 1996; Kilgore et al., 2003). After the implementation of the vaccine program, varicella incidence in infants declined almost by 90% between 1995 and 2008 (Chaves et al., 2011). Moreover, the mortality rate declined by 66% with the greatest reduction among children between one and four years of age (Nguyen et al., 2005). The calculation of the incidence rate for herpes zoster is more problematic, since the burden of herpes zoster increases with age and results from reactivation of the virus from latency. Nevertheless, approximately 10% to 30% of the population are estimated to develop herpes zoster during their lifetime with an increasing incidence to 50% of the 85-years-old population (Brisson et al., 2001). The mortality rate of zoster patients with herpes zoster as main cause of deaths was obtained from the death certificates in the US from 1979 to 2007 and estimated to be 0.19 to 0.51 per 1 million citizens (Mahamud et al., 2012).

1.2 Prevention, prophylaxis, and treatment of α -herpesvirus infections

Viruses are intracellular parasites whose replication depends on the host cell metabolism. Prior to the current molecular insights in cell biology, antivirals were thought to interfere not only with virus but rather with host-cell replication. In the late 1950s, the first antiviral agent was synthesized and used for herpes keratitis treatment (Prusoff, 1963). The discovery of aciclovir (ACV) in 1977 was a major milestone in antiviral chemotherapy development since it was much more active and selective than its predecessors (Crumpacker et al., 1979; Elion et al., 1999). Since then, ACV had been the drug of choice to treat HSV infections since there is still no licensed vaccine available. In contrast, in 1974 a live-attenuated varicella vaccine was developed leading to a significant decrease in the incidence of varicella disease (Takahashi et al., 1974). A special challenge concerns immunocompromised persons (such as patients with hematologic malignancies or the acquired immune deficiency syndrome, AIDS) or immunosuppressed patients (such as transplant recipients) who are at increased risk to develop severe and persistent HSV or VZV reactivations even with fatal course (Herget et al., 2005; Saylor et al., 2015). Live vaccines must not be used in these patients and, moreover, they mostly suffer from prolonged and disseminated disease with poor therapy response (Brady and Bernstein, 2004; Steward et al., 1995). Especially long-term therapy promotes the selection for drug-resistant HSV and VZV variants.

1.2.1 Antiviral treatment by vaccination

Despite the great progress in antiviral therapy over the past thirty years, a licensed anti-HSV vaccine is currently still not available. A vaccination program would mainly target the prevention of primary infection as well as of the reactivations. Furthermore, the vaccine development aims at decreased asymptomatic virus shedding. For example, asymptomatic HSV-2 transmission has a considerable impact on causing neonatal herpes during birth (Kimberlin et al., 2001) or on increasing the risk of HIV transmission (Freeman et al., 2006). In fact, treatment with nucleoside antivirals does not reduce the risk of transmission (Brown et al., 2003; Celum et al., 2010; Watts et al., 2003). Moreover, the initiation of antiviral therapy is often delayed and can lead to viral resistance. One approach includes the administration of subunit vaccines comprising recombinant glycoprotein extracts such as gD and gB which are capable of inducing neutralizing antibodies to HSV-1 and HSV-2 upon primary and recurrent infections in vaccinated animals (Berman et al., 1988; Stanberry et al., 1987). Additionally, the choice of appropriate adjuvants plays a crucial role in protection and maximizing the immune response. For example, a recombinant truncated gD₂ vaccine in combination with alum and 3-O-deacylated monophosphoryl lipid A showed promising results in reducing the occurrence and preventing transmission of genital herpes disease in women (Belshe et al., 2012; Stanberry et al., 2002). However, there was no benefit in preventing HSV-2 acquisition and no reduction of viral shedding.

Another approach is based on the administration of live-attenuated HSV vaccines. In contrast to subunit vaccines, all virus antigens are presented and able to elicit both the humoral and cell-mediated immune responses. However, HSV has evolved efficient mechanisms to escape from the host immune response and is capable to latently infect sensory ganglia (Whitley and Roizman, 2001). Most of the developed live-attenuated vaccines comprise recombinant gene-deletion mutants such as the multiple deletion mutant (γ_1 34.5, UL55, UL56, and US10-12) of HSV-2 that remains genetically stable and attenuates neurovirulence (Prichard et al., 2005). Another candidate is the replication-defective HSV-2 vaccine dl5-29-41L (Δ UL5/UL29/UL41) that expresses an equal pattern of gene products as the wild-type virus with an improved immunogenic potency (Hoshino et al., 2008). However, many vaccines did not pass phase I studies because of lack of efficacy in clinical trials. One substantial reason may be the lack of a viremia phase in the pathogenesis of HSV infection.

The development of a live-attenuated vaccine for varicella in the early 1970s was highly successful (Takahashi et al., 1974). The VZV strain was obtained from a clinical isolate of a three-year old boy named 'Oka' and attenuated by serially passaging on different cell lines. The introduction of the vaccine Varivax[®] (Merck & Co. Inc., NJ, USA) in the USA in 1995

resulted in a significant decrease in the incidence, morbidity, and mortality caused by the disease (Seward et al., 2002; Vazquez and Shapiro, 2005). The vaccine exhibits an excellent safety profile and is highly protective against varicella with a rate of breakthrough cases below 5% of the vaccinees (Gershon et al., 1988; Goulleret et al., 2010; Weibel et al., 1984). The attenuated vaccine strain can be distinguished from the parental strain by multiple nucleotide (nt) polymorphisms across the genome but it is unknown so far, which specific mutations contribute to attenuation. Furthermore, a zoster vaccine (Zostavax[®], Merck & Co. Inc.) was licensed for herpes zoster and PHN prevention. The vaccination resulted in a decline in herpes zoster incidence by approximately 50% and a reduced incidence of PHN by about 60% (Oxman et al., 2005).

1.2.2 Present antiviral chemotherapeutics and their mechanisms of action

Regardless of the availability of vaccines for VZV, antiviral agents are necessary for the treatment of both HSV and VZV infections. The most frequently prescribed antiviral agent against HSV and VZV infection is ACV based on its high efficiency, the remarkable activity, and the favourable safety profile. ACV is a guanosine (G) analog that passes easily the cell membrane and remains inactive until activation by the viral thymidine kinase (TK) (Naesens and De Clercq, 2001) (Fig. 1.5).

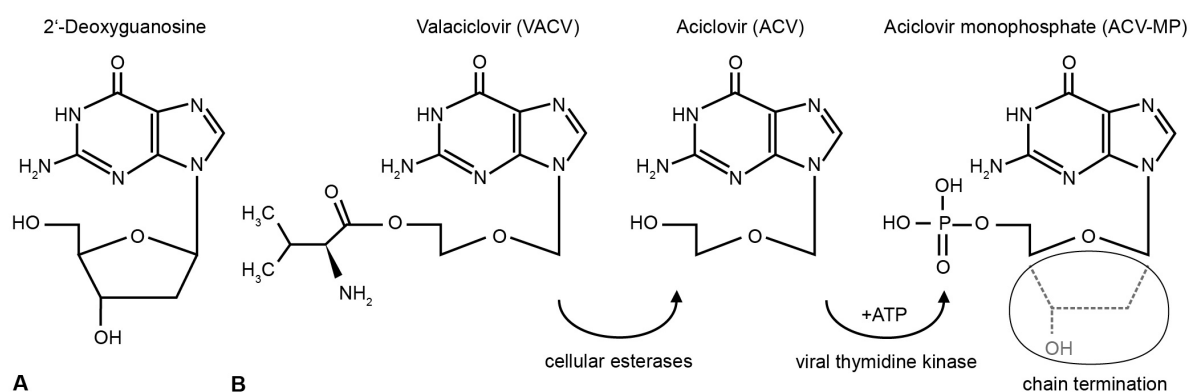

Fig. 1.5: Structural formulae of the natural nucleoside 2'-deoxyguanosine (**A**) and the prodrug valaciclovir (VACV) (**B**) that is converted to aciclovir (ACV) by cellular esterases after it has been passing the cell membrane. ACV is then activated by phosphorylation to its monophosphate form (ACV-MP) by the viral thymidine kinase. The lack of the second hydroxyl group on the acyclic sugarlike molecule leads to chain termination during viral DNA replication.

Even though ACV is a purine analog, it is converted to its monophosphate form since the viral TK exhibits a broader substrate specificity to phosphorylate nucleoside analogs other than the host-cell TK (Naesens and De Clercq, 2001). Additionally, the ability of ACV-conversion by the viral TK (HSV) is approximately one million-fold higher as compared to

cellular kinases. The antiviral effect is therefore mainly observed in infected cells while uninfected cells remain protected from the inhibitory effects. The charged ACV monophosphate molecule is then unable to pass the cell membrane and is converted to its di- and triphosphates by cellular kinases. The consequence is a 40 to 100 times higher ACV triphosphate concentration in HSV-infected cells than in uninfected cells. Besides the competitive inhibition of dGTP incorporation, the further integration during viral DNA replication leads to DNA-chain termination due to the missing second hydroxyl group on the acyclic sugar-like molecule (Elion, 1982).

In addition to ACV, other purine analogs such as penciclovir (PCV) and ganciclovir (GCV) were developed for the treatment of herpesvirus infections, whereas the latter is mainly used for human cytomegalovirus (HCMV) treatment. Due to the poor oral bioavailability of ACV (~20%) and PCV (<10%), there was the need for the introduction of ester prodrug forms that are converted in enterocytes by cellular esterases into the active form (valaciclovir, VACV to ACV (Fig. 1.5) and famciclovir, FCV to PCV) with an increased availability of 55% (VACV) and 77% (FCV) (Jarvest et al., 1998). PCV does not lack the second hydroxyl group and therefore does not act as DNA chain terminator but retards further nt incorporation. One further nucleoside analog mimicking deoxythymidine is brivudin ((E)-5-(2-bromovinyl)-2'-deoxyuridine, BVDU) that has been approved for HSV-1 eye infection and herpes zoster therapy. Brivudin does not act as a chain terminator but reduces the integrity and functioning of the viral DNA during replication (Mustafa et al., 2009).

Due to the fact that ACV, VACV, and FCV have become the gold standards for HSV and VZV disease management, resistance-associated mutations are established in the thymidine kinase (*tk*) gene as a result of long-term treatment in immunocompromised patients. Alternative drugs such as cidofovir (CDV) or foscarnet (FOS) that affect the viral polymerase were approved for the handling of virus infections independently of the TK activity. Cidofovir is an acyclic nt analog of deoxycytidine and therefore circumvents the phosphorylation by the viral TK. The drug acts as a competitive inhibitor of the viral DNA polymerase while FOS directly inhibits the viral polymerase. The latter is a pyrophosphate (PP_i) analog and binds to the site that is naturally occupied by PP_i which is a side product of the DNA polymerization. The release of PP_i during DNA synthesis is prevented and the catalytic cycle is blocked (Chrisp and Clissold, 1991). Therefore, TK-deficient HSV and VZV isolates that are resistant to ACV and related drugs remain susceptible to CDV and FOS. Thus, cross-resistance is highly unlikely due to the different modes of action (Safrin et al., 1990).

1.2.3 Development of resistance against antiherpetic drugs

While the prevalence of ACV resistance does not exceed 1% (Bacon et al., 2003; Frobert et al., 2014) in immunocompetent hosts, the emergence of ACV-resistant viruses increased enormously in immunocompromised individuals (Korovina et al., 2010). Together with an increment of the number of virus isolates with reduced susceptibility to ACV in children (Wang et al., 2011), these isolates have a substantial clinical importance. Antiviral resistance is a major concern in these patients with a reported frequency between 2% to 10% (Burrel et al., 2013; Danve-Szatanek et al., 2004). In allogeneic hematopoietic stem cell transplantation (HSCT) recipients, the prevalence rate even reaches 30% (Morfin et al., 2004; Morfin and Thouvenot, 2003; van der Beek et al., 2013b). Especially prolonged and intensive antiviral treatment as well as heavy immunosuppression promote the selection of resistant isolates that exhibit mutations in the *tk* gene with a probability of 95% (Bestman-Smith et al., 2001; Morfin and Thouvenot, 2003). The mammalian TK enzyme is a part of the thymidine salvage pathway and catalyzes the transfer of the γ -phosphate from ATP to the 5'-hydroxyl group of deoxythymidine to form deoxythymidine monophosphate. Compared to the host-cell TK, the viral kinases exhibit broader substrate specificity with a wide range of nucleosides and analogs to be phosphorylated (Wild et al., 1997). HSV-1 and HSV-2 TK share about 79% sequence identity, while the TK amino-acid sequence of VZV is more divergent with 29% identity only (Suzutani et al., 1993). The viral TK is a homodimer with 376 amino-acid residues (HSV-1, accession no. X14112) or 341 residues (VZV strain Dumas, accession no. X04370) per subunit and possesses six conserved regions (sites 1 to 6) as shown in Fig. 1.6.

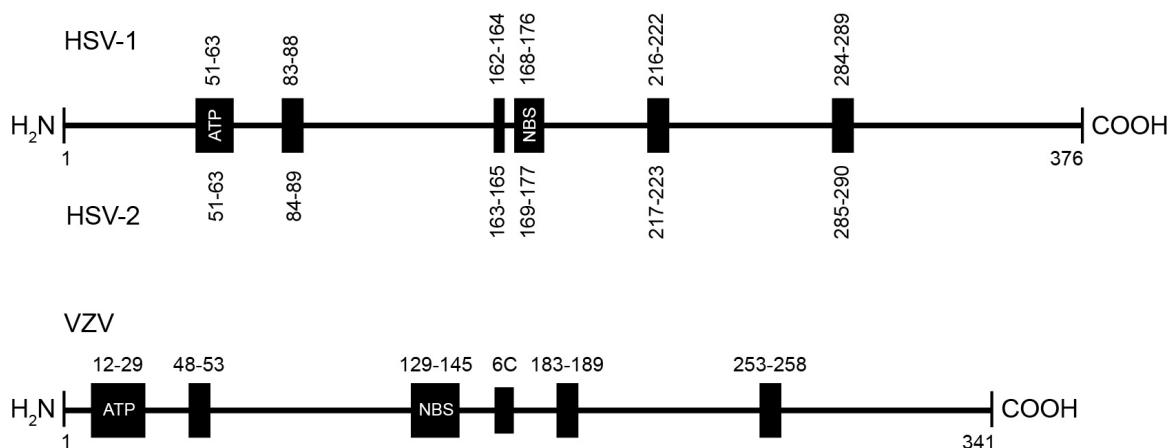

Fig. 1.6: Schematic arrangement of the TK protein. The active regions involving the ATP-binding site (ATP) and the nucleotide-binding site (NBS) as well as the other conserved regions are shown by black boxes with their respective amino acid positions.

The kinases are encoded by the *UL23* gene (HSV) or the open reading frame (ORF) *ORF36* (VZV). The most important sequence domains are the ATP/ADP-binding site (residues 51-63 for HSV-1 and residues 12-29 for VZV, respectively) and the nucleoside/NMP-binding site (residues 168-176 for HSV-1 and residues 129-145 for VZV) (Balasubramaniam et al., 1990). Various studies reported the occurrence of mutations within these conserved domains under clinical or experimental conditions (Andrei et al., 2012; Burrel et al., 2013; Piret and Boivin, 2014; Sauerbrei et al., 2011a). Moreover, numerous non-synonymous polymorphisms have been shown to confer resistance despite their location outside of the conserved regions (Sauerbrei et al., 2011a, 2016). Nevertheless, it is still difficult to investigate the impact of single nucleotide polymorphisms (SNPs) on TK activity. Reliable predictions can only be made up if these mutations are located within the active domains of the conserved regions or if insertions or deletions lead to frameshift errors resulting in non-functional truncated enzymes. Additions or deletions in homopolymer nt stretches of G's and cytidines (C) are the most frequent consequence of such described frameshift mutations (Gaudreau et al., 1998; Sasadeusz et al., 1997). Concerning HSV-1 and HSV-2, the high gene variability hampers the validation of especially SNPs, while the clarification of novel mutations in the VZV TK is limited by the difficulty to isolate clinical strains in cell culture (Sauerbrei et al., 2011b). Furthermore, a higher average of protein-coding variations in the TK was found for HSV-1 than for VZV. This was explained with the higher GC content all over the *tk* gene (68% vs. 46%) and in short sequence repeats (84% vs. 47%) (Andrei et al., 2012). The VZV *tk* gene is more conserved since only a few nt polymorphisms had been described.

Although less frequently observed in clinical isolates, mutations in the viral polymerase (*pol*) gene can occur due to its function as target for ACV by competitive inhibition (Bleymehl et al., 2011; Hwang et al., 1997; Sauerbrei et al., 2011a; Schmidt et al., 2015; Schmit and Boivin, 1999). The *pol* gene consists of seven conserved regions (I to VII) and a δ -region C, which is shared by polymerases related to eukaryotic polymerases δ (Larder et al., 1987; Zhang et al., 1991). Thus, *pol* mutations form an additional reason for antiviral resistance.

1.2.4 Development of novel antiherpetic drugs

The hitherto described antiviral agents are predominantly nucleoside analogs that are activated by the viral TK and/or finally target the viral polymerase. Due to the fact that resistance is closely related to alterations in the corresponding genes, the need for drugs with different mechanisms of action arises in order to circumvent antiviral resistance mechanisms. A further essential step prior to viral DNA replication is the opening of the DNA

strand that is carried out by a heterotrimeric protein complex comprising the virus-encoded helicase, the primase, and an accessory cofactor protein. BAY 57-1293 or pritelevir is one promising compound that inhibits the helicase/primase-complex; it was developed by the *Aicuris* laboratory in Germany and exhibited an approximately 200-fold greater potency against HSV than ACV in cell culture (Kleymann, 2002; Wald et al., 2014). Since BAY 57-1293 efficiently inhibits HSV-1 and HSV-2 replication but not that of other herpesviruses, a novel derivate called ASP2151 (or amenamevir) was developed to inhibit the helicase-primase complex of VZV as well (Chono et al., 2010). The genes encoding the HSV helicase subunit (UL5), primase subunit (UL52), and cofactor subunit (UL8) are conserved among the herpesvirus family and share homology to ORF55, ORF6, and ORF52 of VZV, respectively. Although clinical isolates are commonly sensitive to pretilivir, resistance mutations were obtained in cell culture predominantly in the UL5 gene (Field and Biswas, 2011). However, helicase/primase inhibitors offer a substantially alternative therapy for immunocompromised patients with ACV resistance.

1.2.5 Conventional and unconventional susceptibility testing

The gold standard for antiviral resistance testing of HSV-1 and HSV-2 is the plaque reduction assay (PRA). This method is approved by the *Clinical & Laboratory Standards Institute* for phenotypic susceptibility testing of HSV isolates to antiviral drugs. Test-affecting variables were well defined allowing a convenient validation by the ease of HSV cultivation (Swierkosz et al., 2004). The aim of the approach is to determine the concentration of an antiviral agent that reduces the plaque numbers by 50% (EC₅₀, half maximal effective concentration) in cell culture. For this purpose, the number of cytopathic effects (CPE) is counted after negative staining of the remaining cell monolayer with crystal violet (Burrel et al., 2013; Saijo et al., 2002; Thi et al., 2006) or other dyes (Palù et al., 1992; Shimada et al., 2007). Nevertheless, cultivation from patient's specimen often failed especially in the case of VZV due to its slow replication features (Sauerbrei et al., 2011b). Furthermore, the method is labor-intensive and time-consuming and, thus, the results are rarely available in time to influence the therapeutic strategy. The PRA results can be affected by substrain selection that can occur during propagation of heterogeneous virus populations and the readout is manual and subjective as well.

Several protocols have been developed to optimize susceptibility testing. Special transformed cell lines have been used which express β -galactosidase (*lacZ* gene) from *Escherichia coli* (*E. coli*) driven by an HSV-1 early promoter. Plaques were visualized by histochemical staining with a chromogenic substrate (Stránská et al., 2004a; Tebas et al.,

1995). Virus stock preparation and titration was circumvented by the direct use of clinical specimen and the susceptibility to antiviral drugs was defined by the determination of the optical density (OD) that correlates with the viral load of infected cells. Other susceptibility testing methods calculate the EC_{50} value indirectly by photospectrometrical assessment of the cell viability. These assays based on chemiluminescence detection (Tardif et al., 2014) or on the colorimetric 3-(4,5-dimethylthiazol-2-yl)-2,5-diphenyltetrazolium bromide (MTT) assay where the tetrazolium dye MTT is reduced to its insoluble formazan form (Bae et al., 2006; Monavari et al., 2014; Sauerbrei et al., 2011a; Sudo et al., 1994; Takeuchi et al., 1991). Another way to improve the readout quality was the detection of viral proteins by enzyme-linked immunosorbent assay (ELISA) under a specific concentration of an antiviral (Agut et al., 1990; André et al., 1988; Safrin et al., 1996) or the detection of viral DNA by either DNA hybridization (Swierkosz et al., 1987) or by real-time polymerase-chain reaction (PCR). Initially, the quantification of viral DNA load by real-time PCR was performed from culture supernatants (Stránská et al., 2002). Later on, this application was improved by quantification of intracellular virus load from cell lysates (Thi et al., 2006) and by further internal 'spike' controls as well as endogenous housekeeping gene controls (van der Beek et al., 2013a). Even flow cytometric analysis was used to determine the EC_{50} . Taken together, there have been many attempts to improve and optimize the way of susceptibility testing but special equipment, uncommon reagents (special cell lines), or exceptional practice knowledge is necessary. The variety of applications improved the speed and objectivity of EC_{50} validation but the accurate evaluation of SNP that might be attributed to resistance cannot be assessed by this way since HSV-1 and HSV-2 exhibit multiple nt polymorphisms in the TK or the virus isolation from clinical specimen remains unreliable.

1.3 Recombination techniques and herpesvirus genome manipulation

The advent of recombination-mediated genetic engineering (recombineering) technologies did not facilitate vaccine development alone but rather enabled the functional study of viral genes and replication properties. The further use of the bacterial artificial chromosome (BAC) technology paved the way for herpesvirus genome accessibility to genetic tools that were so far used in bacteria. To date, BACs are undoubtedly the system of choice for herpesvirus studies and especially applications such as recombination in genetically modified *E. coli* are efficient, time-saving, and easy to control (Adler et al., 2003; Brune et al., 2000; Warden et al., 2010; Wussow et al., 2011). The full-length ds DNA genomes of herpesviruses in particular are suitable to be cloned as BAC since BACs are stable enough to carry the entire large genomes, which range in size from 125 to 240 kb (Wagner et al., 2002). Until now, the

genomes of all human herpesviruses except HHV-7 (Tab. 1.1) and many animal herpesviruses were cloned as BAC. Regulatory elements on the bacterial fertility-factor-based vector (F-plasmid) ensure the maintenance of one copy per bacterial cell. This facilitates the targeted alterations and prevents intermolecular recombination events (Messerle et al., 1997; Shizuya et al., 1992; Smith and Enquist, 1999). A further advantage is the fast reconstitution and production of infectious virus by BAC transfection in permissive eukaryotic cells.

Tab. 1.1: Human herpesvirus genomes that have been cloned as BAC in E. coli. The references show a selection of representative studies.

Formal name	Diminutive	Genome size (kb)	References
Herpes simplex virus 1	HSV-1/HHV-1	152	Saeki et al., 1998 Horsburgh et al., 1999 Gierasch et al., 2006
Herpes simplex virus 2	HSV-2/HHV-2	155	Meseda et al., 2004
Varicella zoster virus	VZV/HHV-3	125	Nagaike et al., 2004 Zhang et al., 2007 Wussow et al., 2009
Epstein-Barr virus	EBV/HHV-4	172	Delecluse et al., 1998
Human cytomegalovirus	HCMV/HHV-5	229	Borst et al., 1999 Hahn et al., 2002 Sinzger et al., 2008
Human herpesvirus 6	HHV-6	159	Borenstein & Frenkel, 2009
Kaposi's sarcoma-associated virus	KSHV/HHV-8	137	Delecluse et al., 2001 Zhou et al., 2002

1.3.1 Organization of α -herpesvirus genomes and the appropriate viral BACs

The organization of both the HSV and the VZV genomes is rather similar with two unique regions termed unique long (UL) and unique short (US) (Davison and Scott, 1986; McGeoch et al., 1988). The unique regions are flanked by repeat regions that differ in size and are designated as terminal (TR) and internal repeats (IR). The general configuration is termed TRL-UL-IRL-IRS-US-TRS while the orientation of both unique segments can be arranged in both orientations (Fig. 1.7). These segment inversions result from internal recombination events of the repeat regions. The distribution of the four HSV isomers is nearly equimolar (Hayward et al., 1975) while 95% of the genomic VZV isomers appear in forward orientation of the UL (Davison, 1984) presumably due to its rather short flanking repeat. The protein-coding genes are named with the location-associated prefix and numbered consecutively

from UL1 to UL56 and US1 to US12 for HSV or only by the sequence of ORF1 to ORF71 for VZV, respectively. The HSV genomes exhibit a few genes with missing homology to VZV and the other way around (Baines and Pellett, 2007). The most highly conserved genes among the three viruses are involved in DNA replication and metabolism (Szpara et al., 2014). Overall, the HSV genomes comprise almost 155 kb and the VZV genome approximately 125 kb in size.

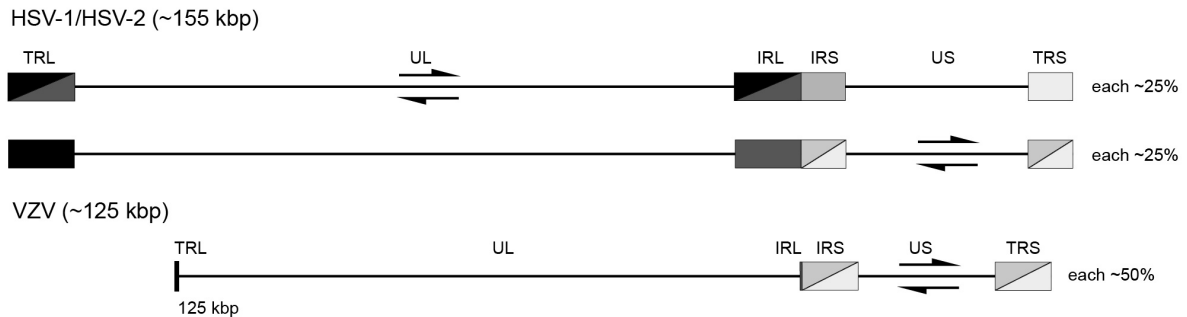

Fig. 1.7: Arrangement sketch of the linear HSV and VZV genomes. The unique long and short segments (UL and US) are flanked by terminal and internal repeat regions (TRL, IRL, IRS, and TRS). The general configuration is termed TRL-UL-IRL-IRS-US-TRS while in virions both unique segments of HSV can appear in both orientations with an equal distribution of approximately 25%. VZV virion DNA shows a fixed UL orientation and exhibits both US orientations at equal distribution.

Advanced methods for the generation of HSV and VZV mutants have been enabled by the cloning of full-length genomes in *E. coli*. A vector moiety of approximately 10 kb has to be inserted into the virus genome for the construction of viral BACs. Essential elements on the BAC vector are an F-plasmid-derived origin of replication (*oriS*), genes for partition control (*sopA-C*) and replication-rate control (*repE*), and a bacterial antibiotic selection marker (e.g., chloramphenicol) to select for BAC-containing bacteria. The BAC vector used in this study is pBeloBAC11 (Shizuya et al., 1992). The vector was inserted between *UL22* and *UL23* for the HSV BACs (Nygårdas et al., 2013; Nagel, personal communication). The vector fragment is flanked by two *loxP* sites and comprises the gene for the eukaryotic Cre recombinase for subsequent vector excision after BAC transfection in eukaryotic cells (Nagel et al., 2008; Smith and Enquist, 2000; Yu et al., 2002). The only remaining foreign sequence is one *loxP* site of 34 bp. The VZV BAC was constructed by vector transposition into the terminal repeats of the L and S component leading to autonomous excision probably by recombination events or genome packaging into capsids (Wussow et al., 2009). As a result, foreign sequences are not left behind after three to five passages of the reconstituted virus. Vector excision prevents the unnecessary increase of the viral genome size and, thus, the possibly associated attenuation of viral growth (Adler et al., 2000; Smith and Enquist, 2000).

1.3.2 Site-directed mutagenesis of BACs by two-step *en passant* mutagenesis

Viral BAC construction provides a basis for the efficient functional analysis of viral genes realized by the commonly used site-directed mutagenesis. For instance, the Red recombinases-mediated recombination system allows the manipulation of circular DNA by linear DNA fragments (Court et al., 2002). Typically, the tools for recombination events are genetically modified *E. coli* (e.g., DH10B-derived strains) comprising a defective and temperature-sensitive λ phage that is integrated in the bacterial genome. The λ phage encodes for the indispensable genes *exo*, *bet*, and *gam* (Red genes) which are located in the *pL* operon and both repress the bacterial nuclease RecBCD and conduct homologous recombination by ds break repair (Court et al., 2002). The expression of these genes is induced by a shift from 32°C growing temperature to 42°C since the λ *pL* promoter is tightly regulated by a temperature-sensitive repressor. Thereby, homologous recombination is enabled to take place between relatively short regions of about 40 bp (Lee et al., 2001; Tischer et al., 2006).

One application of the *exo-bet-gam* system (Red system) is the *en passant* mutagenesis for 'markerless' DNA manipulation (Tischer et al., 2006, 2010) that is depicted in Fig. 1.8. This mutagenesis procedure uses the bacterial strain GS1783 that additionally encodes an L-(+)-arabinose-inducible *I-sceI* gene. The recognition site of the intron-derived endonuclease I-SceI comprises 18 bp and guarantees a highly specific cleavage leading to a DNA ds break required for Red-mediated recombination. This recognition site together with a positive selection marker that confers, e.g., kanamycin resistance (*aphA1*) are amplified in a PCR with special *en passant* oligonucleotides that harbor an internal sequence duplication of 25 bp and an external 50 bp region with homology to the target sequence. After recombination-mediated insertion of the *I-sceI-aphA1* cassette into the target locus, the selection marker is removed by a subsequent Red-recombination event due to the sequence duplication. The second recombination step is induced by addition of arabinose and a temperature-shift to 42°C. Therefore, *en passant* mutagenesis is convenient for the generation of point mutations and nt substitutions as well as sequence deletions and small sequence insertions without leaving any foreign sequences such as *loxP* sites behind. A transfer plasmid can be used by indirect application of this mutagenesis procedure for large sequence insertions (e.g., fluorescence marker) (Tischer et al., 2006).

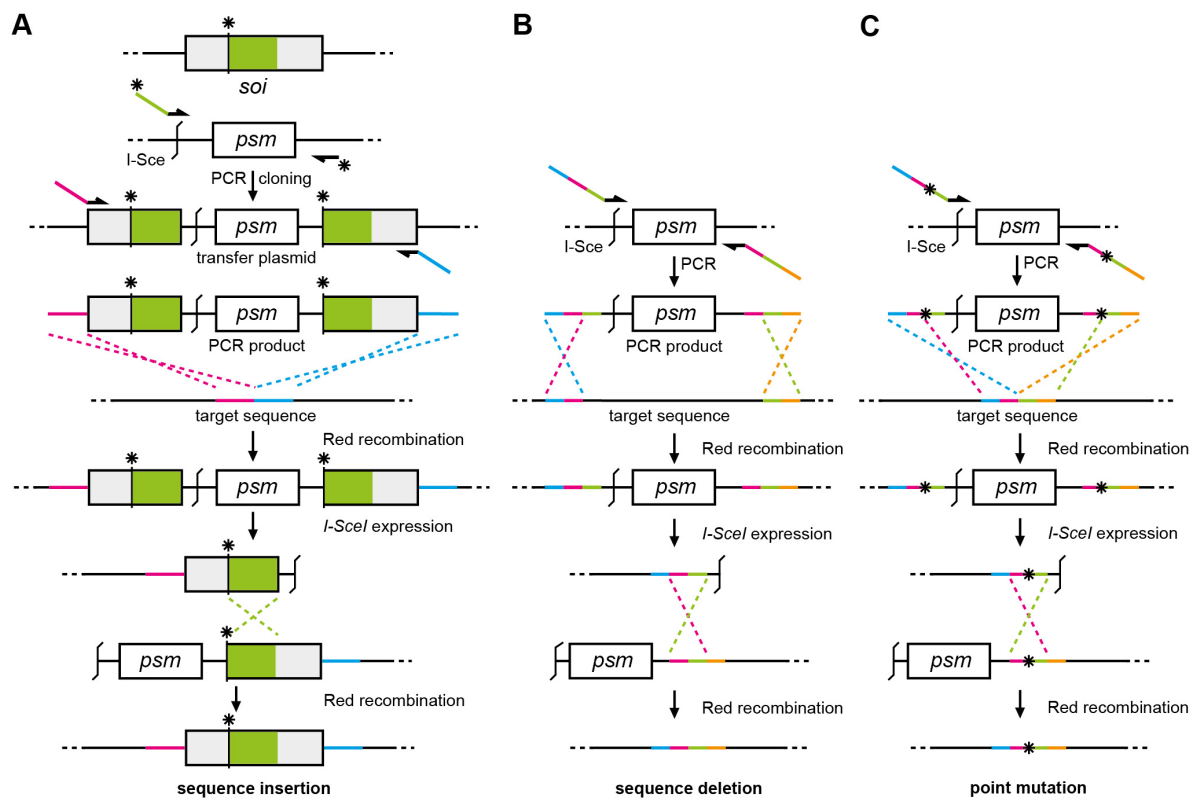

Figure 1.8: Schematic illustration of the *en passant* mutagenesis procedure adapted from Tischer et al., 2006. **A** Insertion of a long sequence of interest (*soi*) using a transfer construct. First, a positive selection marker (*psm*) together with an I-SceI cleavage site and a sequence duplication (green) is ligated into a unique restriction site (asterisk) inside the *soi*. The transfer plasmid is amplified by PCR and integrated into the target sequence by a first Red-mediated recombination. Induction of I-SceI expression leads to a ds break and enables the second recombination step resulting in *soi* insertion. **B** Generation of a sequence deletion by an I-SceI-*psm* PCR product that is amplified using oligonucleotides with 50 bp homology (blue/red and green/orange) adjacent to the target sequence. After the first Red recombination and I-SceI-*psm* integration the *psm* is released by a second Red recombination of the sequence duplication (red/green) leading to the deletion of the target sequence. **C** Generation of a point mutation by an I-SceI-*psm* PCR product that contains the desired mutations inside the sequence duplication (asterisk between red/green). After the first Red recombination into the target locus, the *psm* is released in a second Red recombination leaving the point mutation behind.

1.4 Project objectives

The increasing number of immunocompromised patients and the associated emergence of α -herpesvirus resistance to antiherpetic drugs need more support in molecular diagnostics for optimized therapy guidance. Especially, the high heterogeneity of the HSV *tk* gene and the failure to isolate replicating VZV from clinical samples hamper the unambiguous functional definition of SNPs or the combination of selected ones.

Herpesvirus genes can be genetically modified by site-directed mutagenesis and virus strains with the entire genome can be reconstituted from bacteria in permissive eukaryotic cells and can be cultivated for functional testing. Besides the gene manipulation, the genomes can be modified to express fluorescent proteins facilitating the monitoring of infection.

Therefore, the first objective of the study was to introduce a fluorescence reporter gene into a suitable position of the HSV and VZV genomes. Based on the original and the fluorescence-tagged bacterial artificial chromosomes, the native thymidine kinase gene should be replaced by a mutated gene harboring one single mutation observed from patient's materials. The second objective was to examine the various virus strains for replication capacity and unrestricted gene expression. The integrity of the virus strains was an essential condition for the last objective. The virus strains should be tested against the antiviral ACV and the contribution of amino-acid mutations to resistance should be ascertained. Thus, specific selected polymorphisms should be assigned to the resistance phenotype in order to allow rapid molecular diagnostics of resistant α -herpesviruses directly from clinical samples.

2 MATERIALS AND METHODS

2.1 Materials

2.1.1 Technical devices

Tab. 2.1: Technical devices

Type	Model	Manufacturer/Distributor
Agarose gel electrophoresis chambers	Hand-made	Virological Institute, University Medical Center, Erlangen, Germany
	41-1325	Peqlab Biotechnology, Erlangen, Germany
	41-2325	Peqlab Biotechnology, Erlangen, Germany
Analytical scale	EG4200-2NM	Kern & Sohn GmbH, Balingen, Germany
Bacteria incubator	BD 53 (32°C)	Binder, Tuttlingen, Germany
	37°C	Memmert, Schwabach, Germany
Binocular	Leica MZ 125	Leica, Wetzlar, Germany
Blotting apparatus	Trans-Blot [®] SD	Bio-Rad, Munich, Germany
CCD dark box	LAS-3000	Fujifilm, Düsseldorf, Germany
Cell culture incubator	Hera cell 240	Heraeus, Hannover, Germany
Centrifuges	Heraeus Fresco 17	Thermo Scientific, Waltham, MA, USA
	Multifuge 4 KR	Heraeus, Hannover, Germany
	5804 R	Eppendorf, Hamburg, Germany
Electroporation system	GenePulser Xcell [™]	Bio-Rad, Munich, Germany
Fluorescence microscope	IX81	Olympus, Tokyo, Japan
Light microscope	Leica DMIL	Leica, Wetzlar, Germany
Light table	Smart light 5000	Just Normlicht, Weilheim, Germany
Magnetic stirrer	REO	IKA [®] , Staufen, Germany
	Big Squid	IKA [®] , Staufen, Germany
Microbiological incubator	Multitron	Infors, Bottmingen, Switzerland
Microplate reader	Safire ²	Tecan, Männedorf, Switzerland
PAGE apparatus	Mighty Small II	Amersham Biosciences, Freiburg, Germany
PCR machine/Thermocycler	T3	Biometra, Goettingen, Germany
	T3000	Biometra, Goettingen, Germany
	MyCycler [™]	Bio-Rad, Munich, Germany
pH meter	SevenEasy	Mettler Toledo, Schwerzenbach, Switzerland
Photometer	BioPhotometer	Eppendorf, Hamburg, Germany
Power supplies	EPS 301	Amersham Biosciences, Freiburg, Germany
	300 V	VWR, Darmstadt, Germany
Quantitative PCR instrument	7500 Real Time PCR System	Applied Biosystems, Darmstadt, Germany
Shakers	Rotamax 120	Heidolph, Schwabach, Germany
	SRT9 roller mixer	Bibby Scientific, Stone, UK
Spectrophotometer	NanoDrop 2000	Peqlab Biotechnology, Erlangen, Germany
Sterile benches	Hera safe KS12	Heraeus Instruments, Osterode, Germany

continued on next page

Type	Model	Manufacturer/Distributor
Thermo incubator	Thermomixer compact	Eppendorf, Hamburg, Germany
UV transilluminator	UV-System	Intas [®] , Göttingen, Germany
Vortex	Vortex-Genie [®] 2 Genius 3	Scientific Industries Inc., New York, NYC, USA IKA [®] , Staufen, Germany
Water bath	WNB14 Grant GLS400	Memmert GmbH, Schwabach, Germany Keison, Chelmsford, UK

2.1.2 Chemicals and biological reagents

Tab. 2.2: Chemicals and biological reagents

Chemical or biological reagent	Manufacturer/Distributor
2-Mercaptoethanol	Merck KGaA, Darmstadt, Germany
2-Propanol	Carl Roth GmbH, Karlsruhe, Germany
Acetic acid	Carl Roth GmbH, Karlsruhe, Germany
Aciclovir	Ratiopharm, Ulm, Germany
Agar	BD, Franklin Lakes, NJ, USA
Agarose	Invitrogen™, Karlsruhe, Germany
Ammonium persulfate	Sigma-Aldrich, Munich, Germany
Ampicillin	Sigma-Aldrich, Munich, Germany
Antibodies	see Tab. 2.18 and 2.19
Aqua ad iniectabilia Ampuwa [®]	Fresenius Kabi, Sèvres, France
Benzonase	Merck KGaA, Darmstadt, Germany
BigDye [®] v3.1	Thermo Scientific, Waltham, MA, USA
Bromophenol blue sodium salt	Sigma-Aldrich, Munich, Germany
Cell counting kit-8 (WST-8)	Dojindo, Kumamoto, Japan
Chloramphenicol	Carl Roth GmbH, Karlsruhe, Germany
CloneJET PCR Cloning Kit	Thermo Scientific, Waltham, MA, USA
Crystal violet	Carl Roth GmbH, Karlsruhe, Germany
Dimethylsulfoxide (DMSO)	Biomol GmbH, Hamburg, Germany
DNase-, RNase-, and Protease-free Water	5 PRIME GmbH, Hamburg, Germany
DNeasy [®] Blood & Tissue Kit	Qiagen, Hilden, Germany
dNTP-Mix	Thermo Scientific, Waltham, MA, USA
Dulbecco's phosphate buffered saline (PBS, 1x)	Biochrom, Berlin, Germany
Dulbecco's minimal essential medium (DMEM)	
- liquid medium without L-glutamine	Biochrom, Berlin, Germany
- liquid medium without phenol red	Biochrom, Berlin, Germany
EDTA sodium salt (ethylene diamine tetraacetic acid)	Carl Roth GmbH, Karlsruhe, Germany
Ethanol (absolute)	Merck KGaA, Darmstadt, Germany
Ethidiumbromide (1%)	Carl Roth GmbH, Karlsruhe, Germany

continued on next page

Chemical or biological reagent	Manufacturer/Distributor
FastAP thermosensitive alkaline phosphatase	Thermo Scientific, Waltham, MA, USA
Fetal Bovine Serum (FBS)	PAA Laboratories GmbH, Pasching, Austria
GENEART [®] Site-Directed Mutagenesis System	Invitrogen™, Karlsruhe, Germany
GeneRuler™ DNA Ladder Mix	Thermo Scientific, Waltham, MA, USA
Glycerol	GERBU Biotechnik GmbH, Geiberg, Germany
Glycine	Merck KGaA, Darmstadt, Germany
HotStarTaq [®] DNA Polymerase	Qiagen, Hilden, Germany
Hydrochloric acid (37%)	Carl Roth GmbH, Karlsruhe, Germany
Isopropanol	Carl Roth GmbH, Karlsruhe, Germany
Kanamycin	Carl Roth GmbH, Karlsruhe, Germany
L(+)-Arabinose	Carl Roth GmbH, Karlsruhe, Germany
L-Glutamine (200 mM)	Biochrom, Berlin, Germany
Lipofectamine [®] 2000	Invitrogen™, Karlsruhe, Germany
Methanol	Merck KGaA, Darmstadt, Germany
Milk powder	Carl Roth GmbH, Karlsruhe, Germany
NucleoSpin [®] Gel and PCR Clean-up	Macherey-Nagel, Dueren, Germany
Opti-MEM [®]	Thermo Scientific, Waltham, MA, USA
PageRuler™ Plus Prestained Protein	Thermo Scientific, Waltham, MA, USA
Paraformaldehyde	Sigma-Aldrich, Munich, Germany
Penicillin/Streptomycin-Mix (10.000 U/ml)	Biochrom, Berlin, Germany
Phusion™ High Fidelity DNA Polymerase	Thermo Scientific, Waltham, MA, USA
Plasmid Maxi Kit	Qiagen, Hilden, Germany
Potassium acetate	Carl Roth GmbH, Karlsruhe, Germany
Potassium chloride	Carl Roth GmbH, Karlsruhe, Germany
di-Potassiumhydrogenphosphate anhydrous	Carl Roth GmbH, Karlsruhe, Germany
Proteinase K	Roche Diagnostics, Mannheim, Germany
Restriction enzymes (and appropriate buffers)	Thermo Scientific, Waltham, MA, USA
RT ² First Strand Kit	Qiagen, Hilden, Germany
Qiamp [®] DNA Mini Kit	Qiagen, Hilden, Germany
QuantiTect [®] Probe PCR Kit	Qiagen, Hilden, Germany
RNase A	Thermo Scientific, Waltham, MA, USA
RNase-Free DNase Set	Qiagen, Hilden, Germany
RNeasy [®] Mini Kit	Qiagen, Hilden, Germany
Rotiphorese [®] Gel 30 (37,5:1)	Carl Roth GmbH, Karlsruhe, Germany
Saponine	Sigma-Aldrich, Munich, Germany
SDS pellets (sodium dodecyl sulfate)	Carl Roth GmbH, Karlsruhe, Germany
Sodium acetate	Carl Roth GmbH, Karlsruhe, Germany
Sodium chloride	J.T. Baker, Deventer, Holland
di-Sodiumhydrogenphosphate dihydrate	Carl Roth GmbH, Karlsruhe, Germany

continued on next page

Chemical or biological reagent	Manufacturer/Distributor
Sodium hydroxide	J.T. Baker, Deventer, Holland
SuperSignal™ Chemiluminescent Substrates	
- SuperSignal™ West Femto	Thermo Scientific, Waltham, MA, USA
- SuperSignal™ West Pico	Thermo Scientific, Waltham, MA, USA
T4 DNA Ligase	Thermo Scientific, Waltham, MA, USA
Taq DNA Polymerase	Thermo Scientific, Waltham, MA, USA
TEMED (Tetramethylethylenediamine)	Sigma-Aldrich, Munich, Germany
Tris	Carl Roth GmbH, Karlsruhe, Germany
Tris-HCl	Carl Roth GmbH, Karlsruhe, Germany
Triton X-100	Sigma-Aldrich, Munich, Germany
Trypsin/EDTA solution (10x)	Biochrom, Berlin, Germany
Tween® 20	Sigma-Aldrich, Munich, Germany
VECTASHIELD® Mounting Medium	Vector Laboratories, Burlingame, CA, USA

2.1.3 Stock solutions, buffers, and media

Tab. 2.3: Stock solutions, buffers, and media

Solution	Composition
Ampicillin stock solution (1000x)	100 mg/ml in distilled H ₂ O
Blocking buffer for	
- Immunofluorescence analysis	10% (v/v) FBS in PBS
- Immunoblot analysis	5% (w/v) milk powder, 0.05% (v/v) Tween® 20 in PBS
Cell culture medium	10% (v/v) FBS, 2 mM L-glutamine, 100 U/ml penicillin, 100 µg/ml streptomycin in DMEM
Chloramphenicol stock solution (1000x)	30 mg/ml in ethanol
Crystal violet solution	0.1% (w/v) in 20% methanol in distilled H ₂ O
DNA loading buffer (6x)	50% (v/v) glycerol, 0.25% (w/v) bromophenol blue sodium salt, 0.05 mM EDTA in distilled H ₂ O
Kanamycin stock solution (1000x)	30 mg/ml in distilled H ₂ O
Laemmli buffer (5x)	312 mM Tris-HCl (pH 6.8), 10% (w/v) SDS, 50% (v/v) glycerin, 25% (v/v) β-mercaptoethanol, 0.02% (w/v) bromophenol blue
LB agar for plates	15 g/l agarose in LB-medium
LB medium (<i>Lysogeny broth</i>)	10 g/l tryptone, 10 g/l yeast extract, 5 g/l NaCl, pH 7
Paraformaldehyde (4%)	4% (w/v) paraformaldehyde in PBS, pH 7.4
PBS (1x) Phosphate buffered saline	137 mM NaCl, 2.7 mM KCl, 100 mM Na ₂ HPO ₄ , 20 mM KH ₂ PO ₄ , pH 7.2-7.4
Protein running buffer	25 mM Tris, 192 mM glycine, 0.1% (w/v) SDS
Small-scale DNA preparation buffers	
- Solution I	10 mM EDTA, pH 8; 25 mM Tris-HCl, pH 8; 500 U RNase A
- Solution II	0.2 M NaOH, 1% (v/v) SDS
- Solution III	3 M potassium acetate pH 5.5
TBE (1x)	89 mM Tris, 89 mM boracic acid, 2 mM EDTA, pH 8
Transfer buffer (1x)	25 mM Tris, 192 mM glycine, 10% (v/v) methanol

2.1.4 Plasmids, BACs, bacteria, viruses, and cell lines

Tab. 2.4: Plasmids, BACs, bacteria, viruses, and cell lines

Name/ species	Description/ features	Reference/Manufacturer
Plasmids		
pJET1.2 blunt	Blunt and sticky end cloning, MCS, Amp ^R	ThermoScientific
pCeu2	MCS: I-CeuI – PmlI – XhoI – NaeI – XbaI – PmlI – I-CeuI, Amp ^R	Tischer et al., 2007
pEPkan-S	Kanamycin-resistance gene flanked by two I-SceI restriction sites, Amp ^R	Tischer et al., 2006
pEP-mRFP-in	mRFP gene flanked by a CMV promoter and SV40 poly(A), integrated kanamycin-resistance cassette, Amp ^R /Kan ^R	Tischer et al., 2006
pORFepEGFP-in	EGFP gene flanked by a HTLV/EF-1 α promoter and SV40 poly(A), integrated kanamycin-resistance cassette, Amp ^R /Kan ^R	in-house generated
BACs		
pHSV1(17 ⁺)Lox	HSV-1 strain 17 ⁺ cloned in pBeloBAC11, the vector sequence is flanked by two <i>loxP</i> sites and involve the gene for Cre recombinase driven by an eukaryotic promoter, Cam ^R	Nygårdas et al., 2013
pHSV2(MS)Lox	HSV-2 strain MS cloned in pBeloBAC11, the vector sequence is flanked by two <i>loxP</i> sites and involve the gene for Cre recombinase driven by an eukaryotic promoter, Cam ^R	Nagel, HPI, Hamburg (unpublished)
pHJOpac	VZV strain HJO cloned in pBeloBAC11, the vector sequence is located between the genomic termini (TRS-TRL), Cam ^R	Wussow et al., 2009
Bacteria		
DH5 α TM	F- ϕ 80/ <i>lacZ</i> Δ M15 Δ (<i>lacZ</i> Y Δ - <i>argF</i>)U169 <i>recA1 endA1 hsdR17</i> (rK-, mK+) <i>phoA supE44 thi-1 gyrA96 relA1 tonA</i> (confers resistance to phage T1)	Invitrogen TM
GS1783	DH10B [<i>lac</i> B57 (<i>cro-bioA</i>) \leftrightarrow <i>araC-P</i> _{BAD} - <i>I-SceI</i>]	Tischer et al., 2006
Viruses		
HSV-1 Mi	ACV-sensitive isolate	Sauerbrei et al., 2010b
HSV-2 MS	ACV-sensitive isolate	Sauerbrei et al., 2010b
Cell lines		
Vero, CCL-81 TM	Epithelia kidney cells from <i>Cercopithecus aethiops</i>	ATCC [®]
MeWo, HTB-65 TM	Malignant melanoma cells from Homo sapiens	ATCC [®]

2.1.5 Software programs and databases

Tab. 2.5: Software programs and databases

Program/Database	Applications
Vector NTI [®] Advance 11	Virtual cloning, DNA sequence analysis, virtual digest
Olympus Xcellence pro	Acquisition of fluorescence images
GraphPad Prism 6	EC ₅₀ calculations
Microsoft Excel	Graphs, calculations
Adobe Photoshop	Figure clipping
Adobe Illustrator	Illustrations, figure editing

2.2 Generation of recombinant herpesvirus variants

The generation of α -herpesvirus strains exhibiting alterations in the *tk* or *pol* gene with or without a fluorescence reporter gene was enabled by the BAC-cloned entire genomes of HSV-1, HSV-2, and VZV (see 2.1.4). Using the *en passant* mutagenesis procedure, first a fluorescence marker was inserted in an appropriate genomic position. Subsequently, the native *tk* gene was deleted to avoid unspecific recombination events during mutagenesis. Simultaneously, transfer vectors were constructed with an altered *tk* gene variant and a resistance-cassette for use in *en passant* mutagenesis. The altered *tk* genes were introduced using the transfer vectors while a few VZV gene mutations were introduced directly by the mutagenesis procedure. In a next step, permissive cells were transfected with BAC DNA by lipofection. Then, the BAC vector was either released by Cre-Lox recombination (HSV) or by internal recombination events (VZV).

2.2.1 Cloning of plasmid-based transfer vectors

Both, the *tk* gene fragments and the kanamycin-resistance cassette, were amplified using specific PCR oligonucleotides (see 2.8) that were fitted with restriction enzyme recognition sites at the 5'-terminus. The PCR fragments were purified by agarose gel extraction and then digested and purified again. Subsequently, the fragment was ligated either into a commercial vector or into the cleaved plasmid *pCeu2* and transformed in *E. coli* strain DH5 α . Correct clones were identified by sequencing. A kanamycin-resistance cassette was amplified and inserted in the same way for use in *en passant* mutagenesis. Finally, single nt substitutions or deletions were introduced by site-directed mutagenesis.

2.2.1.1 Polymerase chain reaction with Phusion™ polymerase

Tk gene fragments, kanamycin-resistance and fluorescence cassettes were amplified with Phusion™ High-Fidelity DNA polymerase to guarantee a low error rate. The oligonucleotides were purchased from biomers.net GmbH (Ulm, Germany). Individual oligonucleotide sequences are listed in Tab. 2.8 and Tab. 2.16.

Tab. 2.6: PCR reaction mix for Phusion™ polymerase

Component	Amount
DNA template	30-50 ng
5x Phusion GC buffer	10 μ l
10 mM dNTPs	1 μ l
Oligonucleotide mix (50 μ M each)	1 μ l
DMSO	1.5 μ l
Polymerase	0.5 μ l (1 U)
distilled H ₂ O	ad 50 μ l

Tab. 2.7: PCR program for Phusion™ polymerase

Step	Temperature	Time	Cycles
Initial denaturation	98°C	30 s	1
Denaturation	98°C	10 s	
Annealing	60-65°C	30 s	30
Extension	72°C	25 s/kb	
Final elongation	72°C	10 min	1
Storage	4°C	∞	1

Tab. 2.8: Specific oligonucleotides for cloning; underlined sequences indicate the used restriction enzyme recognition site; (respective restriction enzyme)

Final transfer plasmid/ used vector	Insert	Primer orientation	Amplification oligonucleotide pair sequence 5' – 3'
HSV-1:			
<i>pCeu2</i> -UL23(kan ^r)/ <i>pCeu2</i>	<i>tk</i> gene	Forward	ATCC <u>GTC GAC</u> CTC GAC GGT ATC G (Sall)
		Reverse	AAT <u>CCT AGG</u> CCC AGG TCC ACT TCG CAT A (XmaI)
	kan ^r cassette	Forward	ATCT <u>AGA TCT</u> GCG GCA CGC TGT TGA CGC TGT TAA GCG GGT CGC TGC AGG GTC GCT CGG TAT AGG GAT AAC AGG GTA AT (BglII)
		Reverse	ATCT <u>AGA TCT</u> GCC AGT GTT ACA ACC AAT TAA CC (BglII)
HSV-2:			
pJET-UL23(kan ^r)/ pJET1.2 blunt	<i>tk</i> gene	Forward	TGC TGC TGT GTC CTG CTT ATC
		Reverse	ATT GGC GAA TTC GAA CAC G
	kan ^r cassette	Forward	ATAT <u>GGA TCC</u> CCG CGG GCT CCG GAG GCC CCC TGG CGA TGG CTA GGA CGG GAC GCC GCG CGT AGG GAT AAC AGG GTA ATC GAT TT (BamHI)
		Reverse	ATAC <u>GGA TCC</u> GCC AGT GTT ACA ACC AAT TAA CC (BamHI)

continued on next page

Final transfer plasmid/ used vector	Insert	Primer orientation	Amplification oligonucleotide pair sequence 5' – 3'
VZV:			
<i>pCeu2</i> -ORF36(<i>kan^r</i>)/ <i>pCeu2</i>	<i>tk</i> gene	Forward	ATA <u>GTC GAC</u> TTC AAA CGA CAT TGA TAT GCG (<i>Sall</i>)
		Reverse	AAT <u>CCTAGG</u> AAA CTA GCG CAA ACA TAG TCG C (<i>Xma</i> JI)
	<i>kan^r</i> cassette	Forward	ATA <u>GAA TTC</u> GAC TAG CGG ACA TAT TTG AAG TTC <u>CGT CCC</u> AGA AGA TAA CCT AAG ACG CGT AGG GAT AAC AGG GTA ATC GAT TT (<i>Eco</i> RI)
		Reverse	ATA <u>GAATTC</u> GCC AGT GTT ACA ACC AAT TAA CC (<i>Eco</i> RI)

2.2.1.2 Agarose gel electrophoresis and extraction of DNA fragments

Agarose gel electrophoresis was performed to determine the size and the amount of DNA fragments. Samples were mixed with 6x loading buffer and DNA fragments were separated in a 1% agarose gel in TBE buffer at 120 V and 400 mA for 30 to 60 min. Intercalating ethidium bromide was added in a ratio of 1:30,000 to visualize DNA fragments by UV illumination. The fragment size and the amount of DNA were estimated using the GeneRuler™ DNA ladder mix (Thermo Scientific) as size marker.

When required, PCR fragments or linearized vectors were purified using the NucleoSpin® Gel and PCR Clean-up kit (Macherey-Nagel) according to the manufacturer's instructions. A new agarose gel electrophoresis of a portion of the eluted DNA provided information about the purity and quantity of the sample.

2.2.1.3 DNA cloning and transformation into competent *E. coli*

PCR products and plasmids were digested with the appropriate enzymes for at least three hours at 37°C. Usually, the digest of 1-2 µg template DNA was performed with 10 U of the respective enzyme and buffer in a 20 µl reaction mix. The restriction enzymes were purchased from Thermo Scientific (Waltham, MA, USA). In the case of a plasmid digestion with a single enzyme, the linearized vector was dephosphorylated at 37°C by adding 0.5 µl (0.025 U) FastAP alkaline phosphatase (Thermo Scientific) for the last one hour to prevent vector religation. The purified DNA fragments were ligated in a ratio of 3:1 insert over vector (50 ng) at 16°C for at least two hours using 5 U of T4 DNA ligase (Thermo Scientific). Subsequently, up to 150 ng were used for the transformation into chemically competent bacteria *E. coli* strain DH5α (Invitrogen™) following the manufacturer's instructions. After selection on antibiotics-containing agar plates, the clones were screened by PCR and

sequencing (see 2.2.1.6). Simple colony screening was performed in a colony-check PCR with *Taq* DNA polymerase (Thermo Scientific) while single colonies served as template.

Tab. 2.9: PCR reaction mix for *Taq* DNA polymerase

Component	Amount
Template	bacteria colony or 20 ng DNA
10x (NH ₄) ₂ SO ₄ buffer	2.5 µl
10 mM dNTPs	0.3 µl
Oligonucleotide mix (50 µM each)	0.6 µl
MgCl ₂	2 µl
Polymerase	0.1 µl (1 U)
distilled H ₂ O	ad 25 µl

Tab. 2.10: PCR program for *Taq* DNA polymerase

Step	Temperature	Time	Cycles
Initial denaturation	95°C	60 s	1
Denaturation	95°C	10 s	
Annealing	55°C	30 s	30
Extension	72°C	60 s/kb	
Final elongation	72°C	10 min	1
Storage	4°C	∞	1

2.2.1.4 Small-scale extraction of plasmid DNA

Low amounts of plasmid DNA were extracted from single colonies by alkaline lysis (Birnboim and Doly, 1979) for initial analysis. Bacteria cultures of 5 ml were grown overnight at 37°C (DH5α) or 32°C (GS1783) and pelleted at 3,400 x g for 10 min. The bacteria pellet was dissolved in 300 µl solution I, then mixed with 300 µl solution II, and incubated for 5 min at room temperature. The lysate was acidified with 300 µl solution III and kept on ice for further 20 min. After a centrifugation step at 17,000 x g for 15 min, the plasmid DNA was precipitated in 0.7 volume of isopropanol and centrifuged again at 17,000 x g for 45 min. The pellet was washed in 70% ethanol, dried, and resolved in DNase-free water (5 PRIME GmbH).

2.2.1.5 Site-directed mutagenesis

Nucleotide mutations including substitutions, insertions, and deletions were introduced using the GeneArt® Site-Directed Mutagenesis System kit (Invitrogen™) according to the manufacturer's instructions. The concept is based on the initial methylation of the plasmid

template. The complementary oligonucleotides generate a homologous region of approximately 30 bp at the ends of the PCR fragment that contains the mutation. Finally, the plasmid is generated by a recombination reaction of the fragment termini. The specific chromatography-purified oligonucleotides (biomers.net GmbH) of approximately 30 nt are listed in Tab. 2.11. Single colonies were verified by sequence analysis (see 2.2.1.6).

Tab. 2.11: Specific oligonucleotides for site-directed mutagenesis. Only the forward primer is listed, since the reverse primer is 100% complementary according to the manufacturer's recommendations. The mutation site is displayed in bold; aa, amino acids; Δ (deletion); ins (insertion).

Virus strain	Sequence 5' - 3'	Mutation (nt)	Mutation (aa)
HSV-1	AAG CCA CGG AAG TCC ACC TGG AGC AGA AAA T	G122A	R41H
	GTC CCC ACG GGA TGG CGA AAA CCA CCA CCA C	G182C	G61A
	TCT ACG TAC CCG AGC TGA TGA CTT ACT GGC G	C251T	P84L
	ACA CCA CAC AAC ACC ACC TCG ACC AGG GTG A	G317A	R106H
	CGG CCG GGG ACG CGG TGG TGG TAA TGA CAA G	C353T	A118V
	GTG ACC GAC GCC GTT GTG GCT CCT CAT ATC G	C415G	L139V
	TCG ACC GCC TGG CCA CAC GCC AGC GCC CCG G	A656C	K219T
	TGC CGA GCC CCA GAG AAA CGC GGG CCC ACG A	C828A	S276R
	GGG CCC CCG AGT TGC GGG CCC CCA ACG GCG A	T893G	L298R
	CTG CTG CAA CTT ACC CCC GGG ATG GTC CAG A	T1033C	S345P
	CTT ACC TCC GGG ATG ATC CAG ACC CAC GTC A	G1042A	V348I
HSV-2	GCG GGC CTA CCG ACG CCC GCG CGG CGT CCC G	G74C	G25A
	GCC AGG GGG CCT CCG AAG CCC GCG GGG ATC C	G116A	G39E
	ACG CTG CTG CGG GTT AAT ATA GAC GGA CCC C	T157A	Y53N
	AGA TAA CAA TGA GCA TGC CTT ATG CGG CGA C	C392T	T131M
	CAA TGA GCA CGC CTT TTG CGG CGA CGG ACG C	A398T	Y133F
	GGG GGG AGG CTG TGG ACC CGC AAG CCC CGC C	G449A	G150D
	CAA GCC CCG CCC CCG ACC CTC ACC CTT GTT T	G469A	A157T
	ACC GCC TGG CCA GAC ACC AAC GCC CGG GCG A	G662A	R221H
	CTC GCC AAC ACG GTG TGG TAC CTG CAG CGC G	C742T	R248W
	GTC GAG ACG CCC TGT GGC GCC TCA CCG CCG G	T1025G	L342W
VZV	GGA ACA CAA ACT CGC CGT ATT AAT GGA GAC GTT TCG C	C217A	L73I
	ATA AGG AGC CGT ATA AAA TTG TTA TCC GAC CGA CAC CCA A	Δ 376-377	A163stop
	AAC AAC TGG CAC GCG GGC AGG AAC ACA CTG TCA TTT T	T673A	W225R
	TAC CTG GGA TTG AAG ACA TGT TAT TCG CCG TGC TTA A	C767T	T256M
	TTA GAA CAG ACA CCC TAG CAT GCG GCA CAA G	C907T	Q303stop
	ACT TCC GGA GCT TTG CGG GAG AGT TTG GAA ATA TTC T	ins G840	N334stop

2.2.1.6 DNA sequencing

DNA samples were sequenced in the *Institute for Clinical Molecular Biology* of the Christian-Albrechts University of Kiel. The resulting data were analyzed using the Vector NTI® Advance 11 software (Life technologies).

Table 2.12: PCR reaction mix for sequencing

Component	Amount
DNA template	20-50 ng linear DNA fragments 300 ng plasmid DNA
5x BigDye buffer	1 μ l
Oligonucleotide (50 μ M each)	0.1 μ l
BigDye v3.1	1 μ l
distilled H ₂ O	ad 10 μ l

Table 2.13: PCR program for sequencing

Step	Temperature	Time	Cycles
Initial denaturation	96°C	1 min	1
Denaturation	96°C	10 s	
Annealing	50°C	5 s	24
Extension	60°C	4 min	
Storage	4°C	∞	1

2.2.2 Modification of BAC-based viral genomes

Alterations of the used BAC-cloned genomes of the α -herpesviruses were performed by *en passant* mutagenesis. For sequence deletion or insertion, a resistance gene-containing PCR product was generated. Special oligonucleotides were used that harbor overhangs of at least 50 bp at the 5'-terminus with homology to the target locus. The amplicon was purified by agarose-gel extraction and transformed into electro- and recombination-competent *E. coli* strains GS1783 carrying the appropriate BAC. In a second Red-mediated recombination step, the resistance marker was released. All intermediate and final BACs were tested by restriction fragment length polymorphism (RFLP) analysis and by sequencing of the transition regions. After large-scale DNA preparation, permissive cells were transfected with the BAC DNA. Reconstitution of recombinant virus strains occurred within one to five days.

2.2.2.1 PCR with HotStarTaq[®] polymerase

DNA fragments were amplified using the HotStarTaq[®] DNA polymerase (Qiagen) to prevent oligonucleotide dimer formation. The gel-purified oligonucleotides were ordered from biomers.net GmbH. Individual oligonucleotide sequences are listed in Tab. 2.16.

Tab. 2.14: PCR reaction mix for HotStarTaq[®] polymerase

Component	Amount
DNA template	30-50 ng
10x PCR buffer	5 μ l
10 mM dNTPs	1 μ l
Oligonucleotide mix (50 μ M each)	2 μ l
Polymerase	1 μ l (1 U)
distilled H ₂ O	ad 50 μ l

Table 2.15: PCR program for HotStarTaq polymerase

Step	Temperature	Time	Cycles
Activation	94°C	15 min	1
Denaturation	94°C	40 s	
Annealing	55°C	30 s	30
Extension	72°C	60 s/kb	
Final elongation	72°C	10 min	1
Storage	4°C	∞	1

2.2.2.2 Transformation into *E. coli* and first homologous recombination step

The purified PCR product (see 2.2.1.2) was transformed into the BAC-containing recombination-competent *E. coli* strain GS1783 in order to prepare for the *en passant* mutagenesis procedure. To generate electrocompetent bacteria, an LB-medium liquid culture was grown overnight with 30 μ g/ml chloramphenicol at 32°C. The next day, the culture was diluted in a ratio of 1:20 in liquid LB medium with the appropriate antibiotic and grown until an OD600 of 0.5-0.7 was reached. For the induction of Red-recombinase expression, the culture was transferred to a 42°C water-bath shaker for 15 min before it was cooled down by shaking on ice for further 20 min. The bacteria were pelleted and washed three times in 10% ice-cold glycerol at 4.500 x g and 0°C for 5 min. The cells were resuspended in 1/100 (10% glycerol) of the initial culture volume and frozen down in a mixture of dry ice and ethanol. Portions were stored at -80°C. When needed, samples were thawed on ice and 50-100 ng of the purified PCR product were added. The electroporation was performed with a Gene Pulser

Xcell™ (Bio Rad) under the conditions of 1.5 kV per mm, 25 μ F, and 200 Ω . Immediately, 1 ml antibiotic-free LB medium was added and the bacteria were shaken for two hours at 32°C. The transformation reaction was transferred to agar plates with the appropriate antibiotics and incubated for two days at 32°C.

2.2.2.3 Second Red-mediated recombination step

After screening for suitable single colonies, a candidate clone was cultured overnight in liquid LB medium with both 30 μ g/ml kanamycin and 30 μ g/ml chloramphenicol. The following day, 100 μ l were transferred to 2 ml LB medium with chloramphenicol and shaken for three hours at 32°C. First, the addition of 1% arabinose in 2 ml LB medium for 60 min resulted in I-SceI induction and in a subsequent ds break of the BAC DNA. The additional shift to a 42°C water-bath shaker induced Red-recombinases expression and the immediate recombination reaction of the sequence duplication. The bacteria were shaken for further four hours at 32°C before several dilutions of the culture were plated on chloramphenicol/arabinose-containing agar plates, which were incubated for two days at 32°C.

2.2.2.4 Fragment analysis

All BAC intermediates and final constructs were examined by RFLP analysis. Usually, 1 μ g of BAC DNA was digested with an appropriate restriction enzyme and the optimal buffer in a total volume of 20 μ l at 37°C overnight. The digest reaction was mixed with 6x loading dye and transferred to a 0.6% agarose gel to allow sufficient separation of the large DNA fragments. The electrophoresis was performed overnight at 50 V and 400 mA.

2.2.2.5 Application of *en passant* mutagenesis

En passant mutagenesis was first used for fluorescence-marker insertion in all used BAC-cloned α -herpesvirus genomes. The fluorescence gene, combined with a promoter and a terminator sequence, was inserted in an appropriate genome position using a ready-to-use expression vector (Tischer et al., 2006). Based on the fluorescence-tagged strains, a *tk* gene deletion mutant was generated. Moreover, the majority of the mutations were inserted indirectly by the mutagenesis procedure using the generated transfer construct. Only the large deletion of the VZV *tk* gene resulting in amino-acid deletion Δ 7-74 was generated directly by appropriate oligonucleotides. Furthermore, two *pol*-gene mutations of VZV were inserted directly by specific *en passant* oligonucleotides. All oligonucleotides which were used in an *en passant*-related manner are listed in Tab. 2.16.

Tab. 2.16: Specific en passant oligonucleotides or oligonucleotides used in an en passant-specific manner. polymerase (Po)

Strain	Target	Primer orientation	Sequence 5' – 3'	
HSV-1	<i>tk</i> gene deletion	Forward	ATA ACT TCG TAT AGC ATA CAT TAT ACG AAG TTA TCT AGC AGA TCC GTG TTA GAT CTG CGG CAC GCT GTT GAC GCT TAG GGA TAA CAG GGT AAT CGA TTT	
		Reverse	GCG ACC CTG CAG CGA CCC GCT TAA CAG CGT CAA CAG CGT GCC GCA GAT CTA ACA CGG ATC TGC TAG ATA ACT TCG GCC AGT GTT ACA ACC AAT TAA CC	
	EGFP insertion	Forward	AAG AGC CGT AAC CCA ACC AAA CCA GGC GTG GTG TGA GTT TGT GGA CCC AAG CTC CGG TGC CCG TCA GTG GG	
		Reverse	AAT AAA AGT ATC ACG GTC CAT ACT GGC CTG TCG CGT TGT CTC TGA GGG CTA TTA ACA TTT AAA TGG ATC TAC	
	<i>tk-kan^r</i> insertion	Forward	ATA AGC TGG GGA TCT TGA AGT TCC	
		Reverse	ATA TTA AGG TGA CGC GTG TGG CC	
	HSV-2	<i>tk</i> gene deletion	Forward	TCC GAG CTC ATC GCT AAT AAC TTC GTA TAA TGT ATG CTA TAC GAA GTT ATA CCC GCT TCT ACA AGG CGT TCG CCC TAG GGA TAA CAG GGT AAT CGA TTT
			Reverse	GTG GCG TTG AAC TCC CGC ACC TCT CGG GCG AAC GCC TTG TAG AAG CGG GTA TAA CTT CGT ATA GCA TAC ATT ATA GCC AGT GTT ACA ACC AAT TAA CC
		EGFP insertion	Forward	AAG AGT GAG AAC CAA CCA AAA CAG ACG CGG TGT GAG TTT GTG GGT TAT AGG CTC CGG TGC CCG TCA GTG GG
Reverse			AAG TTG CGT TAA CAC ACA TGC TGG TTC GTC GCG TGG TAT TTA CCG GGT TCA TTA ACA TTT AAA TGG ATC TAC	
<i>tk-kan^r</i> insertion		Forward	TCC GAG CTC ATC GCT AAT AAC TTC GTA TAA TGT ATG CTA TAC GAA GTT ATC TAA ACT CCC CCC ACC TCG CGG G	
		Reverse	GTG GCG TTG AAC TCC CGC ACC TCT CGG GCG AAC GCC TTG TAG AAG CGG GTA TGG CTT CTC ACG CCG GCC AAC AG	
VZV		<i>tk</i> gene deletion	Forward	ATC GTA AAA ACG AGT GTG GCA ACG TTG TCC CAA ACG AAA ACA CTT GGC CCT ACG TAT GTA CCA GTA AAA AGA TGA TAG GGA TAA CAG GGT AAT CGA TTT
			Reverse	GTA CAC GCG AGT ATG ACA ATG TGT ATC ATC TTT TTA CTG GTA CAT ACG TAG GGC CAA GTG TTT TCG TTT GGG ACA GCC AGT GTT ACA ACC AAT TAA CC
		mRFP insertion	Forward	CTA AAC ACT GTA TTA ACA AAA TAT TGG AAT TAA AAC ACA CAT AAG AGC GAT AGT TAT TAA TAG TAA TCA ATT ACG
	Reverse		ACG ATT TAT AAC ATG TAT ATA CGA GCA AAA TAA AAC AAT GAA CCA TTA AGA ATG CTT TAT TTG TGA AAT TTG TG	
	<i>tk kan^r</i> insertion	Forward	ATC GTA AAA ACG AGT GTG GC	
		Reverse	GTA CAC GCG AGT ATG ACA ATG	
	Δ7-74	Forward	GAT AAC CTA AGA CGC GTT TGT CTA CAA TAA ACA TGT CAA CGG ATA AAA CCG GAG ACG TTT CGC CTG AAG ACG CAC TAG GGA TAA CAG GGT AAT CGA TTT	
		Reverse	CTC TGA AAA TGA GCC GTG AGG CGT TGT GCG TCT TCA GGC GAA ACG TCT CCG GTT TTA TCC GTT GAC ATG TTT ATT GCC AGT GTT ACA ACC AAT TAA CC	

continued on next page

Strain	Target	Primer orientation	Sequence 5' – 3'
VZV	T237K (Pol)	Forward	AAT ACA CCC TGT AAA ACG CAC ATG GCT GTG TAT CGT AGT AAT AAA CAT CTT TGC GCT CAA TAA CCT CAA CGC GAA ATA GGG ATA ACA GGG TAA TCG ATT T
		Reverse	GTT TAA AAG CGC ATC TCC AGA AAG CTT TCG CGT TGA GGT TAT TGA GCG CAA AGA TGT TTA TTA CTA CGA TAC ACA GGC CAG TGT TAC AAC CAA TTA ACC
	A955T (Pol)	Forward	CCC AGA CGG CAT GGC CCG TCT ATT CCA TTC AGC AAT GGA AAC ACA CGA CGT CTC CGC CGC AGC ACG CGA GAC GGT GTA GGG ATA ACA GGG TAA TCG ATT T
		Reverse	TTG TAG AAC TGT TGT TAT ATG ACG ACA CCG TCT CGC GTG CTG CGG CGG AGA CGT CGT GTG TTT CCA TTG CTG AAT GGC CAG TGT TAC AAC CAA TTA ACC

2.2.2.6 Large-scale preparation of BAC-DNA

The generated BACs were extracted by the QIAGEN Plasmid Maxi Kit (Qiagen) according to the manufacturer's instructions. The kit combines alkaline lysis with anion-exchange chromatography to obtain highly pure and concentrated DNA for transfection.

2.3 Cultivation of recombinant virus strains in permissive cell lines

For *in vitro* infection with HSV, permissive kidney cells derived from African green monkey (Vero cells, ATCC[®]-CCL-81[™]) were cultivated in cell culture medium at 37°C, 5% CO₂, and 90% humidity. The adherent cell line was split after trypsin treatment at a ratio of 1:5 twice a week. The VZV cultivation was performed on permissive and adherent human melanoma cells (MeWo cells, ATCC[®]-HTB-65[™]) which were cultivated in cell culture medium under the same conditions as mentioned above and were split at a ratio of 1:4 once a week after trypsin treatment. For infection experiments, detached cells were counted using a Neubauer counting chamber.

2.3.1 Transfection of permissive eukaryotic cells and virus reconstitution

Permissive cells were seeded in 6-well plates one day prior to transfection to obtain 80-90% confluence. Per well, 2-6 µg of highly pure BAC DNA (see 2.2.2.6) was mixed with Lipofectamine[®] 2000 (Invitrogen[™]) and Opti-MEM[®] (Thermo Scientific) following the manufacturer's recommendations. The culture medium was aspirated and replaced by serum-free DMEM medium. The DNA-lipid complex was added to one 6-well and incubated for four hours in the case of HSV DNA and overnight for VZV DNA, respectively, before the transfection medium was replaced by cell-culture medium. HSV-1 reconstitution occurred

within one day post transfection whereas CPEs of HSV-2 arose after two to three days. Reconstitution of VZV strains occurred after four days or one further split.

2.3.2 Culture of HSV on permissive Vero cells

HSV was cultivated on Vero cells. Cells were infected with a supernatant inoculum one day after seeding. Altered cell morphology was visible one (HSV-1) or two (HSV-2) days post infection whereas plaque formation was observed after two or three days of incubation, respectively. For the generation of high titer stocks, confluent Vero cells from a 175 cm² tissue culture flask were infected with multiplicities of infection (MOI) of approximately 0.1 to 1.0. It took approximately two days for HSV-1 and three days for HSV-2 until the entire cell monolayer was infected. The supernatant was removed and the cells were treated in three freeze-thaw cycles at -80°C. The cell debris was combined again with the supernatant and pelleted at 1,500 x g for 10 min before stocks from the supernatant were stored at -80°C.

2.3.2.1 Titration of cell-free virus

Virus titers were determined by limiting dilution. One day prior to titration, 24-well plates were prepared with 1x10⁵ Vero cells per well. Four series of ten-fold dilutions (10⁻¹ to 10⁻⁸) were set up and a volume of 250 µl of each dilution was added to the cell monolayer after the medium was removed. Virus absorption occurred during an incubation time of two hours under mild shaking. Subsequently, the inoculum was aspirated, the cells were washed with PBS, and overlaid with 0.3% agar/growth-media mixture. After two days of incubation, the cells were fixed with 4% paraformaldehyde for one hour. The paraformaldehyde/agar overlay was discarded and the monolayer was stained with crystal-violet solution for one hour. The virus titer was calculated by counting the plaques on a light table. Plaques of fluorescent HSV strains were directly counted under the fluorescence microscope IX80 (Olympus).

2.3.2.2 One-step replication kinetics of HSV-1

HSV-1 replication was described by growth curves showing the virus yield as a function of time. For this purpose, a 6-well plate was prepared with 5x10⁵ Vero cells per well and incubated overnight. Prior to infection, the medium was exchanged and the plate was precooled for 30 min on ice. The virus dilution was set up as a triplicate in a volume of 500 µl with the appropriate very high MOI of 5. The medium was removed and the inoculum was added to the cells. The plate was then incubated on ice on an orbital shaker. After two hours, the inoculum was removed, the cells were washed twice with PBS and 2 ml of culture medium were added to each well. The plates were incubated at 37°C and, at 4, 6, 9, 12, 15,

18, 24, and 48 hours post infection, 50 μ l of the supernatant were frozen in liquid nitrogen and stored at -80°C prior to titration. Viral titers were plotted as the mean and standard deviation (SD) from triplicates in plaque-forming units (PFU) per ml against the time.

2.3.2.3 Multi-step replication kinetics of HSV-2

The replication progress of HSV-2 was determined by multi-step growth kinetics. Three 6-well plates were prepared per virus strain with 5×10^5 Vero cells per well to obtain triplicates. On the next day, the virus dilution was set up and a volume of 1 ml with a very low MOI of 0.001 was added to each well. The plates were incubated for one hour on an orbital shaker until the inoculum was removed. The cells were washed with PBS and 1 ml of prewarmed culture medium was added to each well. The plates were incubated at 37°C and, at 12, 24, 36, 48, 60, and 72 hours post infection, the infected cells were scraped into the medium. The sample was frozen in liquid nitrogen and stored at -80°C . Prior to titration, the cell debris was pelleted at $4,500 \times g$ for 5 min. The amount of virus yield was displayed as a mean and SD from triplicates in PFU/ml.

2.3.3 VZV culture on permissive Melanoma cells

VZV is cell-associated in cell culture and therefore has to be propagated by co-cultivation of uninfected with infected cells. In this study, permissive MeWo cells were used in a 1:3 split ratio and mixed with different dilutions of infected cells that were harvested from a culture with 70-90% plaque formation. High-titered stocks were generated after four days of incubation from a 75 cm^2 tissue culture flask that exhibited 90% CPE. The infected cells were washed twice with PBS and detached with trypsin. Cell-culture medium was added and the cells were pelleted for 10 min at $260 \times g$. The cell pellet was resuspended in 10 ml ice cold FBS and cooled down for 20 min on ice before DMSO was added to a final concentration of 9%. Cell portions of 1 ml were preserved by slow freezing in an isopropanol freezing container and stored at -80°C .

2.3.3.1 Titration of cell-associated viruses

The amount of PFU/ml was determined by titration of VZV-infected MeWo cells on uninfected cells. The stock was thawed quickly and diluted in ten-fold series (10^{-1} to 10^{-5}) in quadruplicates. A volume of 100 μ l was added to the cells that were seeded to 2×10^5 per well the previous day. After three days of incubation, cells were fixed with 2% PFA and plaques were counted after either indirect immunofluorescence staining (see 2.4.4) or directly if

fluorescence mutants were tested. The imaging was performed on an inverse fluorescence microscope IX80 (Olympus, Tokyo, Japan).

2.3.3.2 Multi-step replication kinetics of VZV

VZV is highly cell-associated in cell culture and replicates rather slow allowing multi-step growth kinetics. For that purpose, a 6-well plate per VZV strain was prepared with 1×10^6 MeWo cells per well. On the next day, the cells of each well were infected with approximately 100 PFU. On days one to five post infection, the cells of one well each were harvested and frozen (see 2.3.3). The samples were then titrated as described in 2.3.3.1. Replication curves were illustrated as a function of time from calculated mean values and SD of virus yields obtained from three independent experiments.

2.4 Gene expression analysis

Modifications of the *tk* gene or alterations of the genome by recombination techniques can result in transcription failure. Viral *tk* is dispensable in cell culture and inactivation or deletion does not hamper viral replication. Expression failure would pass unnoticed and pretend a resistance phenotype. Thus, the verification of *tk* gene expression is absolutely required.

2.4.1 Reverse-transcription polymerase-chain reaction

Gene transcription was examined by reverse-transcription polymerase-chain reaction (RT-PCR) from isolated RNA of whole-cell lysates. Vero and MeWo cells were seeded to 5×10^5 per well in a 6-well plate and incubated overnight. The next day, Vero cells were infected with an MOI of 0.1 (HSV) whereas MeWo cells were infected with 200 PFU (VZV). Infected cells were treated one (HSV-1), two (HSV-2), or three (VZV) days post infection, respectively, using the RNeasy Mini Kit (Qiagen) according to the manufacturer's instructions. Additionally, the spin column was treated with RNase-free DNase I (Qiagen). The RNA concentration was determined spectrophotometrically with a NanoDrop™ (Peqlab) device and the samples were stored at -80°C . The RNA was then used for cDNA synthesis using the RT² First Strand kit (Qiagen). The cDNA was either stored at -20°C or subsequently used as template in a PCR to prove the presence of both, the *tk* gene-related transcript and the transcript of the housekeeping gene glyceraldehyde-3-phosphate dehydrogenase (GAPDH). Pure RNA samples were also used as template to exclude false-positive signals resulting from genomic DNA contamination. All oligonucleotides used for RT-PCR are listed in Tab. 2.17. The PCR was performed with *Taq* DNA polymerase (Thermo Scientific) (see Tab. 2.9 and 2.10).

Tab. 2.17: Oligonucleotides used for reverse transcriptase polymerase chain reaction

Transcript	Sequence 5' – 3'	Predicted amplicon size (bp)
HSV-1 <i>tk</i>	GCG ATT GGT CGT AAT CCA G	271
	GCC AAT ACG GTG CGG TAT C	
HSV-2 <i>tk</i>	CAG TAA GTC ATC GGC TCG G	230
	TTC GGT CAG GCT GCT CGT G	
VZV <i>tk</i>	GTG GGA GAT ATG TCC CCA G	255
	AAA TGA CAG TGT GTT CCG GC	
GAPDH	GCA GGG GGG AGC CAA AAG GG	566
	TGC CAG CCC CAG CGT CAA AG	

2.4.2 Protein expression analysis

Protein expression was shown by both immunoblot analysis and indirect immunofluorescence staining using commercially available primary antibodies. Thereby, immunoblotting provides information about the molecular size of the protein of interest whereas immunostaining with fluorescence-labeled antibodies gives insights into its localization.

2.4.2.1 Antibodies

All primary antibodies used for immunoblot analysis and indirect immunofluorescence staining of Vero and MeWo cells are listed in Tab. 2.18 and secondary antibodies in Tab. 2.19.

Tab. 2.18: Primary antibodies

Antibody	Species	Dilution	Manufacturer
anti-HSV-1/2 TK	goat	1:200	Santa Cruz Biotechnology, Inc., Dallas, TX, USA
anti-VZV TK	goat	1:200	Santa Cruz Biotechnology, Inc., Dallas, TX, USA
anti-HSV-1/2 gD	mouse	1:500	Santa Cruz Biotechnology, Inc., Dallas, TX, USA
anti-VZV gI	mouse	1:500	Merck KGaA, Darmstadt, Germany
anti- β -actin	rabbit	1:1000	Cell Signaling Technology, Frankfurt, Germany

Tab. 2.19: Secondary antibodies

Antibody	Species	Dilution	Manufacturer
anti-mouse Alexa488	goat	1:1000	Molecular Probes, Eugene, OR, USA
anti-goat Alexa 568	donkey	1:1000	Molecular Probes, Eugene, OR, USA
anti-mouse HRP	goat	1:8000	Jackson ImmunoResearch, Suffolk, UK
anti-goat HRP	donkey	1:8000	Jackson ImmunoResearch, Suffolk, UK
anti-rabbit HRP	goat	1:8000	Jackson ImmunoResearch, Suffolk, UK

2.4.2.2 Immunoblotting

The immunoblot technique was performed to detect the TK protein from lysates of infected cells. Vero and MeWo cells were seeded to 5×10^5 cells per well in a 6-well plate. The cells of one well were infected with an MOI of 0.1 of HSV or with 300 PFU of VZV. After one to three days post infection, cells were washed with PBS, scraped in 1 ml PBS, pelleted at $2,000 \times g$ for 5 min, and lysed in 1x Laemmli sample buffer supplemented with 5 U/ μ l Benzonase[®] (Merck Millipore). Immediately before use, the samples were boiled at 95°C for 10 min. Sodium dodecyl sulfate polyacrylamide gel electrophoresis (SDS-PAGE) was used to separate proteins by their molecular weight. The concentration of acrylamide was chosen depending on the size of the protein of interest. The samples were separated in a 10-12% SDS-PAGE at 120 V and 400 mA using a PAGE apparatus (Bio-Rad Laboratories) and the protein size was estimated in comparison to the bands of the PageRuler™ Plus prestained protein ladder (Thermo Scientific™). The compositions of a 10% separating gel and a 5% stacking gel are shown as examples in Tab. 2.20. The proteins were transferred from the gel to polyvinylidene difluoride (PVDF, Merck Millipore) membranes by semi-dry blotting at 20 V and 400 mA for 30 min using a Trans-Blot semi-dry transfer cell (Bio-Rad) according to the manufacturer's recommendations. Afterwards, the membranes were treated with blocking buffer for one hour at room temperature or overnight at 4°C. The membranes were incubated with the primary antibody (dilution see tab. 2.18) in blocking buffer for one hour, rinsed several times with PBS for 30 min and incubated with the horse-radish peroxidase (HRP)-conjugated secondary antibody (dilution see Tab. 2.19) in blocking buffer for one further hour. The membranes were rinsed several times and proteins were detected using the SuperSignal[®] West Pico/Femto chemiluminescent substrate kit (Thermo Scientific) applying a CCD camera (LAS 3000, Fuji, Tokyo, Japan).

Tab. 2.20: Composition examples of the components of a polyacrylamide gel

Gels	Composition
10% resolving gel (10 ml)	4 ml H ₂ O, 3.3 ml acrylamide mix (30%), 2.5 ml Tris (1.5 M, pH 8.8), 0.1 ml SDS (10%), 0.1 ml ammonium persulfate (10%), 0.004 ml TEMED
5 % stacking gel (5 ml)	3.4 ml H ₂ O, 0.83 ml acrylamide mix (30%), 0.63 ml Tris (1.0 M, pH 6.8), 0.05 ml SDS (10%), 0.05 ml ammonium persulfate (10%), 0.005 ml TEMED

2.4.4.3 Indirect immunofluorescence assay

Indirect immunofluorescence staining was used to visualize the viral TK with fluorescence-labeled antibodies in fixed cells of infected cultures. For this purpose, sterile cover slips were put in each well of a 12-well plate. Vero and MeWo cells were seeded to approximately 2×10^5

cells per well and infected on the following day with an MOI of 0.0001 (HSV) or with 20 PFU (VZV), respectively. After one to three days of incubation, the medium was aspirated and the cells were fixed with 2% PFA for 30 min and permeabilized with 0.2% Triton X-100 or 1% saponine in PBS. The cover slips were first treated with blocking buffer for one hour at room temperature to block unspecific binding sites and then incubated with the primary antibody (dilution see Tab. 2.18) in blocking buffer for one further hour or overnight. After several wash steps with PBS, the cover slips were incubated with the secondary antibody (dilution see Tab. 2.19) for one hour and washed again. The cover slips were collected and placed upside down on microscope slides in a droplet of Vectashield[®] mounting medium (Vector Laboratories). Stained plaques were imaged at the inverse fluorescence microscope IX80 (Olympus).

2.5 Susceptibility testing on infected cells

Herpesvirus susceptibility testing was performed by the established plaque-reduction assay that constitutes the gold standard to examine the effect of antiviral agents on viral replication. In this assay, cells are infected with a constant viral inoculum in presence of serial drug dilutions. The half maximal effective concentration (EC_{50}) of ACV was determined either by counting plaques, by assessing cell viability due to dye metabolization, or by measuring the relative fluorescence unit (RFU).

2.5.1 CPE inhibition assay of HSV

Since the spread of HSV is efficient and its replication proceeds fast, the PRA method by counting plaques is awkward to handle. In this thesis, the EC_{50} value was calculated by determining the cell viability of the remaining living cells if non-fluorescent virus strains were tested. Fluorescent HSV strains were directly checked by measuring the RFU. For this purpose, 5×10^4 Vero cells per well were seeded in a 96-well plate in cell-culture medium without phenol red and infected with an MOI of 0.01 on the next day. ACV was applied six-fold in a final half-log dilution ranging from 0.275 to 35.2 μ M. One well row served as mock control and another row served as virus control in absence of ACV. Non-fluorescent virus infections were incubated for three days before 10 μ l of WST-8 ([2-(2-methoxy-4-nitrophenyl)-3-(4-nitrophenyl)-5-(2,4-disulfophenyl)-2H-tetrazolium, monosodium salt]; Dojindo Molecular Technologies) were added to each well. One external well with medium/WST-8 only served as blank control. The plate was incubated for two hours at 37°C and both the absorbance at 450 nm and a reference wavelength of 650 nm were measured using a Tecan safire² microplate reader (Tecan Group AG). Cells infected with fluorescent virus strains were incubated

for 24 (HSV-1) or 48 (HSV-2) hours and the plate was analyzed by measuring the fluorescence at the excitation wavelength of 510 nm. Experiments were performed three-fold and the EC₅₀ value was computed from dose-response curves by non-linear regression analysis using the GraphPad Prism 6 software and presented as the arithmetic mean and the SD. HSV1-GFP and HSV2-GFP served as sensitive reference strains and recombinant TK-mutated HSV strains were considered ACV-resistant if the mean EC₅₀ values were calculated as at least five times the mean EC₅₀ plus SD of the sensitive reference strains.

2.5.2 Plaque reduction assay of VZV

Compared to HSV, replication of VZV proceeds much slower and infection occurs strictly in cell-associated way in cultured cells. For that reason, drug susceptibility testing and EC₅₀ value calculation was performed by counting plaques. MeWo cells were seeded to 5x10⁴ cells per well in a 48-well plate. On the next day, the cells were infected with approximately 20 to 40 PFU of fluorescent VZV strains to enable accurate counting. ACV was added five-fold in half-log dilution steps ranging from 0.275 to 35.2 μM. Four wells served as mock control while four further wells served as virus control without ACV treatment. The cells were incubated for three days until plaques were counted under the fluorescence microscope IX80 (Olympus). Susceptibility testing to ACV was performed twice. The percentages of antiviral activity were calculated and the EC₅₀ value was computed from dose-response curves by non-linear regression analysis using the GraphPad Prism 6 software and presented as the arithmetic mean and the SD. The recombinant fluorescent strain HJO-RFP served as sensitive reference. VZV mutants were considered ACV resistant if the mean EC₅₀s were computed as at least four times the EC₅₀ plus SD of the susceptible reference strains.

2.5.3 Quantitative polymerase-chain reaction

The monitoring of DNA amplification during a PCR allows the quantitation of DNA fragments from a sample. In this approach, the viral genome load from lysates of infected cells which were treated with ACV- or mock-treated was determined. Twelve-well plates were seeded with 2x10⁵ cells per well (Vero for HSV and MeWo for VZV) and infected with similar numbers of PFU. HSV-1 was added with an MOI of 0.01 and cells were incubated for 24 hours. An MOI of 0.01 was used for HSV-2 and cells were incubated for 48 hours. MeWo cells were infected with approximately 100 PFU of VZV strains and incubated for three days. The recombinant herpesvirus strains with wild-type configuration were treated with increasing ACV concentrations ranging from 0.275 to 35.2 μM whereas the TK-modified strains were incubated in absence or presence of 35.2 μM ACV. After the indicated incubation time, the

supernatant was aspirated and infected cells were collected after trypsin treatment and centrifugation at 4.500 x g for 5 min. Total DNA was extracted using the DNeasy Blood & Tissue Kit (Qiagen) according to the manufacturer's instructions. The samples were additionally treated with RNase A (Qiagen) to avoid inhibitory effects on quantitative PCR (qPCR). The viral genomes were quantified from 3.3% of the eluted volume using oligonucleotides and a TaqMan probe targeting UL30 of HSV and ORF38 of VZV (Hawrami and Breuer, 1999; Kessler et al., 2000). The oligonucleotides and probes are listed in Tab. 2.23. Additionally, BAC DNA of pHSV1-GFP, pHSV2-GFP, and pHJO-RFP were prepared by large-scale extraction (see 2.2.2.6) and quantified spectrophotometrically. The amount of copies per μl was calculated by the formula $(x \text{ g}/\mu\text{l DNA} / (\text{BAC-length (bp)} \times 660)) \times 6,022 \times 10^{23}$. A BAC-DNA concentration of $2 \times 10^{11}/\mu\text{l}$ was adjusted and serial ten-fold dilutions ranging from 2×10^1 to 2×10^{10} were prepared to generate standard curves. The PCR was performed with the QuantiTect Probe Kit (Qiagen) on a 7500 real-time PCR system (Applied Biotechnologies) according to the manufacturer's recommendations.

Tab. 2.21: PCR reaction mix for quantitative PCR

Component	Amount
2x QuantiTect Probe PCR Master	25 μl
Oligonucleotide mix (20 μM each)	2 μl
Probe (10 μM)	1 μl
DNA sample, BAC-DNA or water	5 μl
DNase, RNase and protease free water	17 μl

Tab. 2.22: PCR program for quantitative PCR

Step	Temperature	Time	Cycles
PCR activation	95°C	15 min	1
Denaturation	94°C	15 s	45
Annealing and extension	60°C	60 s	

Table 2.23: Oligonucleotides and probes used for quantitative PCR (qPCR)

Strain	Orientation	Sequence 5' – 3'
HSV	Forward	CAT CAC CGA CCC GGA GAG GGA C
	Reverse	GGG CCA GGC GCT TGT TGG TGT A
	Probe	(6FAM)-CCG CCG AAC TGA GCA GAC ACC CGC GC-(TQ2)
VZV	Forward	AAG TTC CCC CCG TTC GC
	Reverse	TGG ACT TGA AGA TGA ACT TAA TGA AGC
	Probe	(6FAM)-CCG CAA CAA CTG CAG TAT ATA TCG TCT CA-(TQ2)

3 RESULTS

3.1 Generation and verification of manipulated HSV and VZV BACs

Susceptibility testing of virus strains was so far limited to isolates that were obtained from patient specimen. Two major problems appeared in this context: HSV-1 and HSV-2 isolates from the content of vesicular rash often exhibit various polymorphisms in the *tk* gene which complicates the definition of a SNP in its contribution to resistance. In contrast, only a few or merely one single SNP usually arise in the *tk* gene of VZV but cultivation of isolates from patient samples often fails. Therefore, the correlation of SNP-associated amino-acid exchanges to the phenotype was determined by exclusion criteria or by speculations based on the location within or outside conserved domains.

With the development of BAC-cloned genomes of herpesviruses and the progress in recombination techniques it became possible to generate replication-competent virus strains with desired modifications such as gene deletions, marker insertions, or nt mutations. The HSV BACs used in this study are originated from the HSV-1 strain 17⁺ (GenBank accession number NC_001806) (Saeki et al., 1998) and HSV-2 strain MS (ATCC[®] VR540[™]) (Meseda et al., 2004). In continuing studies, the BAC vector moiety was inserted in the *tk* gene locus (Horsburgh et al., 1999). The *tk* gene was later restored (Nygårdas et al., 2013; Dr. Nagel, Heinrich Pette Institute, Hamburg) resulting in the *loxP*-flanked location of the BAC vector between *UL22* and *UL23*. The VZV BAC used in this study was initially generated by cosmid complementation from a set of genome segments originated from the strain HJO (GenBank accession number AJ871403) (Schmidt et al., 2003). The BAC vector was first located in the unique region short and was later transposed between the genomic termini (TRS-TRL) to enable vector self-excision by internal homologous recombination events or by packaging of the viral genome into the capsids (Wussow et al., 2009).

First, the original BACs were used for fluorescence-marker insertions (Fig. 3.1 and 3.5). The HSV genomes were tagged with the gene for enhanced green fluorescent protein (EGFP) (Tsien, 1998) under the control of a hybrid promoter of the human T-lymphotropic virus (HTLV) and of the elongation factor EF-1 α gene (Kim et al., 1990) and terminated by a simian virus 40 (SV40)-derived polyadenylate (poly(A)) signal. The ready-to-use vector pORFepEGFP-in, harboring a kanamycin-resistance gene (*aphA1*) and a sequence duplication, was used as PCR template. The EGFP-kanamycin cassette was amplified using extended oligonucleotides (Tab. 2.16) with 50 bp overhangs at the 5'-terminus and homology to the insertion site sequence. The pHSV1(17⁺)Lox- and pHSV2(MS)Lox-containing recombination-competent bacteria of *E. coli* strain GS1783 were transformed with the appropriate

PCR product. Marker integration occurred in a first recombination step at the considered location between *UL55* and *UL56*. Subsequently, the integrated resistance cassette was removed in a second recombination step due to an induced ds break at the I-SceI recognition site and homologous recombination of the sequence duplication. The EGFP integration site was reported before to allow stable transgene expression (Nygårdas et al., 2013; Snijder et al., 2012).

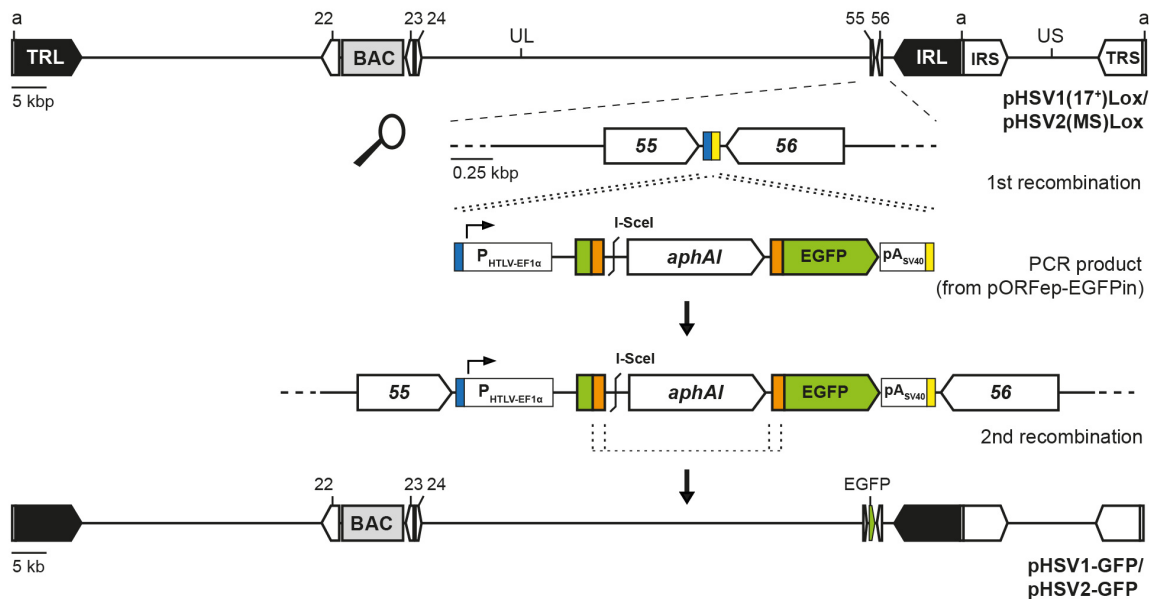

Fig. 3.1: Scheme for fluorescence-marker insertion into the HSV BACs with wild-type configuration by *en passant* mutagenesis. The gene for the enhanced green fluorescent protein (EGFP, green), driven by an HTLV-EF1 α promoter and terminated by a SV40 poly(A) signal, was inserted into the intergenic region between *UL55* and *UL56* of the BACs pHSV1(17⁺)Lox and pHSV2(MS)Lox. A PCR product was generated with oligonucleotides harboring a 50 nt overhang (blue, yellow). The amplicon harbored the EGFP gene, a kanamycin-selection marker (*aphAI*), the I-SceI recognition site, and an internal sequence duplication of approximately 50 bp (orange). The amplicon was inserted in the target locus by a first homologous recombination event. The kanamycin-resistance cassette was excised by a second homologous recombination between the internal sequence duplication resulting in pHSV1-GFP or pHSV2-GFP, respectively.

Based on the original BACs pHSV1(17⁺)Lox and pHSV2(MS)Lox as well as on the fluorescence-tagged BACs pHSV1-GFP and pHSV2-GFP, the native *UL23* gene sequence was exchanged by a modified one. Exemplarily, the manipulation strategy for gene substitution is depicted in Fig. 3.2 for pHSV1(17⁺)Lox. The gene exchange for pHSV2(MS)Lox was performed analogously (not shown). In the first step, the *UL23* sequence was removed by *en passant* mutagenesis using special oligonucleotides for *UL23* gene deletion (Tab. 2.16). Fig. 3.2A describes the excision procedure. The deletion site was amplified with flanking oligonucleotides and sequenced to guarantee the accurate sequence removal.

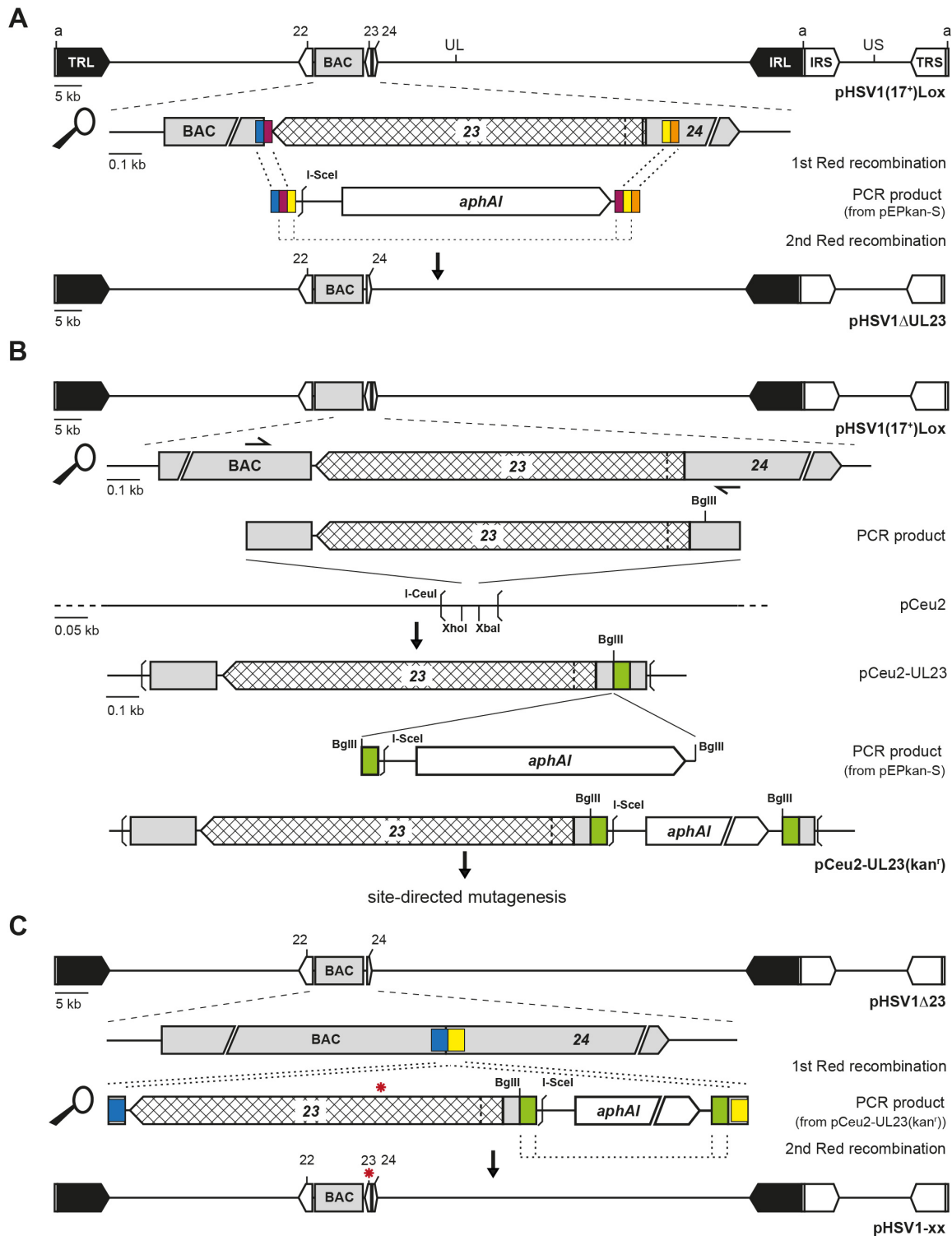

Fig. 3.2: Scheme for the generation of the *UL23* mutants by *en passant* mutagenesis. **A The BAC pHSV1-(17⁺)Lox formed the basis for the *UL23* deletion. A kanamycin-selection marker (*aphAI*) in combination with an I-SceI recognition site was amplified from pEPkan-S using oligonucleotides with overhangs homologous to the flanking regions of *UL23* (blue/red, yellow/orange). Additionally, a sequence duplication (red/yellow) was included. *UL23* was substituted by *aphAI* by the first recombination. The second recombination of the sequence duplication led to *aphAI* excision resulting in the *UL23* deletion mutant pHSV1 Δ UL23. **B** A transfer plasmid with the *UL23*-kanamycin cassette was generated by amplifying the native gene from pHSV1(17⁺)Lox, followed by cloning it into the plasmid *pCeu2*. Subsequently, the kanamycin-resistance gene, a sequence duplication of 50 bp (green), and an I-SceI recognition site were amplified from pEPkan-S and cloned into the unique BgIII site. The product *pCeu2*-*UL23*(kan^r) presented the basis vector for site-directed mutagenesis. **C** The modified *UL23* (red asterisk)/*aphAI* cassette was amplified from the transfer plasmid and integrated in the native locus on pHSV1 Δ UL23 by a first red recombination. The selection marker was removed after I-SceI induction by a second recombination.**

A multiplicity of different polymorphisms were observed in the *tk* genes of α -herpesviruses from clinical material or after adaption to antivirals in cell culture (Bleymehl et al., 2011; Bohn et al., 2011; Boivin et al., 2011; Burrel et al., 2013; Hussin et al., 2013; Piret and Boivin, 2014; Sauerbrei et al., 2011a; Schubert et al., 2014). Many mutations were classified to confer resistance due to the localization inside catalytic or conserved domains, the presence of resistance-related frameshift mutations often resulting in truncated proteins, or by measuring the enzyme activity (Brunnemann et al., 2015; Burrel et al., 2012; Sauerbrei et al., 2012). Nevertheless, there are numerous novel amino-acid exchanges with ambiguous significance due to their localization in non-conserved regions or because of missing reports about similar substitutions at the same position. In this study, selected amino-acid exchanges including novel substitutions with unknown impact were inserted into the *tk* gene in an otherwise wild-type based background (Tab. 3.1).

Tab. 3.1: Compilation of amino-acid mutations chosen for the targeted introduction into the viral TK for HSV-1, HSV-2, and VZV.

HSV-1	HSV-2	VZV
R41H	G25A	L73I
G61A	G39E	A163stop
P84L	Y53N	W225R
R106H	T131M	T256M
A118V	Y133F	Q303stop/A955T (Pol)
L139V	G150D	N334stop
K219T	A157T	Δ aa7-74
S276R	R221H	
L298R	R248W	T237K (Pol)
S345P	L342W	A955T (Pol)
V348I		

With this intention, transfer vectors were generated that were suitable for the traceless insertion of a modified *tk* gene (Fig. 3.2B). For this purpose, the respective gene region was amplified with *UL23*-flanking oligonucleotides (Tab. 2.8) using the basic BACs as template and cloned in an appropriate vector. The *S*all and *X*maI digested amplicon of HSV-1 was cloned in the plasmid *pCeu2* whereas the blunt-ended amplicon of HSV-2 was directly cloned in the commercial pJET1.2 vector. The kanamycin-resistance cassette was amplified from the pEPkan-S vector and cloned into a unique restriction enzyme recognition site (*B*glII for HSV-1 and *B*amHI for HSV-2) within (HSV-2) or immediately adjacent (HSV-1) to the *tk* gene by using oligonucleotides with the appropriate cleavage site at the 5'-terminus (Tab. 2.8).

Subsequently, nt substitutions were introduced by site-directed mutagenesis using oligonucleotides listed in Tab. 2.11. The transfer vector products were confirmed by sequencing. Based on these plasmids, the modified *tk*-kanamycin cassettes were amplified using extended oligonucleotides (Tab. 2.16) that harbor a 50 bp overhang at the 5'-terminus with homology to the flanking regions of the deletion site on the corresponding BAC. The amplicons were transformed into recombination-competent bacteria *E. coli* GS1783 containing the respective *tk*-deletion mutant BAC with or without fluorescence-tag. The modified *tk*-kanamycin cassette was accurately integrated into the native position by Red-mediated recombination. In a second recombination step, the kanamycin-resistance gene was released resulting in pHSV1-xx, pHSV1-xx-GFP, pHSV2-xx, and pHSV2-xx-GFP, while the "xx" defines one respective amino-acid exchange.

The integrity of the final BAC constructs was examined by RFLP and sequence analysis. Fig. 3.3 and 3.4 demonstrate the confirmation of the performed manipulation steps by RFLP analysis for the HSV-1 BACs and the HSV-2 BACs, respectively. First, the integration of the EGFP gene cassette was analyzed with Bsp1407I and Eco105I (Fig. 3.3A) or with EcoRI and Eco105I (Fig. 3.4A). The white arrows indicate additional bands for pHSV1-GFP and pHSV2-GFP that are predicted if EGFP is inserted into this locus. Subsequent deletion of the original *UL23* sequence became apparent by a band decline of approximately 1 kb correlating with the fragment size of the gene. The following insertion of the modified *UL23* gene from transfer plasmids restored the genome position and resulted in a band increase by an equal fragment size for the HSV TK variants. Similar results were obtained for the initial *UL23* gene deletion and the following gene insertion of the original BACs pHSV1(17⁺)Lox and pHSV2-(MS)Lox. RFLP analysis for these series was conducted with Bsp1407I and Eco105I for the HSV-1 mutants (Fig. 3.3B) or with Eco105I and PdmI for the HSV-2 mutants (Fig. 3.4B), respectively. Subsequent gene deletions and insertions are indicated with black arrows. Furthermore, the final BACs were confirmed by sequence analysis of the concerning region.

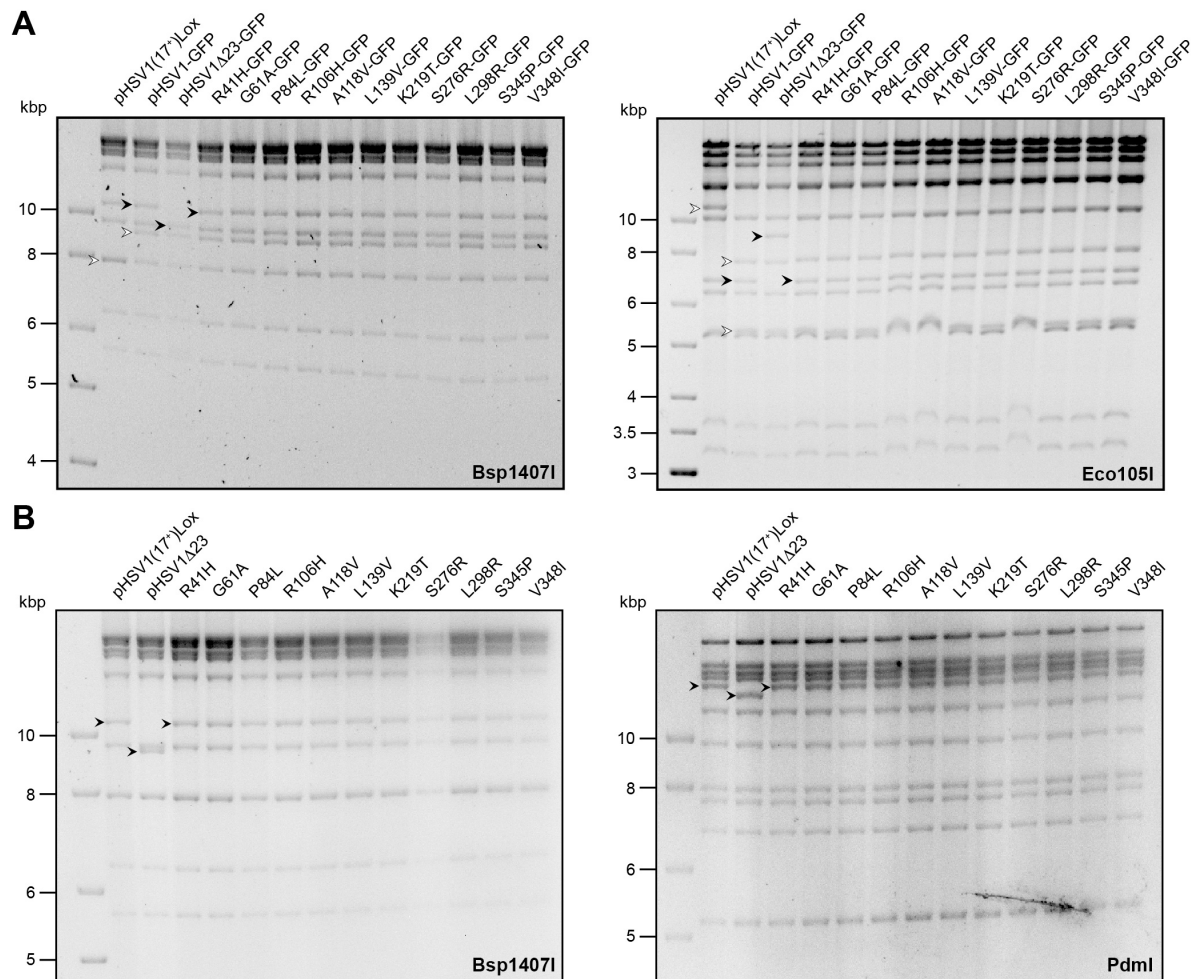

Fig. 3.3: Restriction fragment length polymorphism (RFLP) analysis of HSV-1 BAC mutants. **A** RFLP analysis of EGFP-tagged HSV-1 BACs with Bsp1407I (left) and Eco105I (right). The EGFP cassette was inserted into pHSV1(17⁺)Lox resulting in pHSV1-GFP (white arrows). Thereafter, the pHSV1Δ23-GFP was obtained by *UL23* gene deletion following insertion of the modified *UL23* gene (black arrows). **B** The basic BAC pHSV1(17⁺)Lox, the deletion mutant pHSV1Δ23 as well as each *tk*-mutated BAC-variant were treated with the restriction enzymes Bsp1407I (left) and PdmI (right). The indicated black arrows show the initial deletion of the native *UL23* gene and the subsequent insertion of the modified *UL23* gene.

Similar to the described procedure but in contrast to the HSV strains, the gene for the monomeric red fluorescent protein (mRFP) (Campbell et al., 2002) was integrated into the BAC-cloned VZV genome of HJO to obtain pHJO-RFP (Fig. 3.5). The mRFP gene was obtained by the ready-to-use vector pEP-mRFP-in (Tischer et al., 2006) and is regulated by the HCMV-derived enhancer/promoter. The mRFP/kanamycin-cassette was amplified using the extended oligonucleotides listed in Tab. 2.16 and inserted by homologous recombination between the poly(A)-sites of the reverse orientated ORFs 17 and 18 to avoid interference or disruption of cis-acting elements. The kanamycin cassette was excised in a second recombination step resulting in pHJO-RFP.

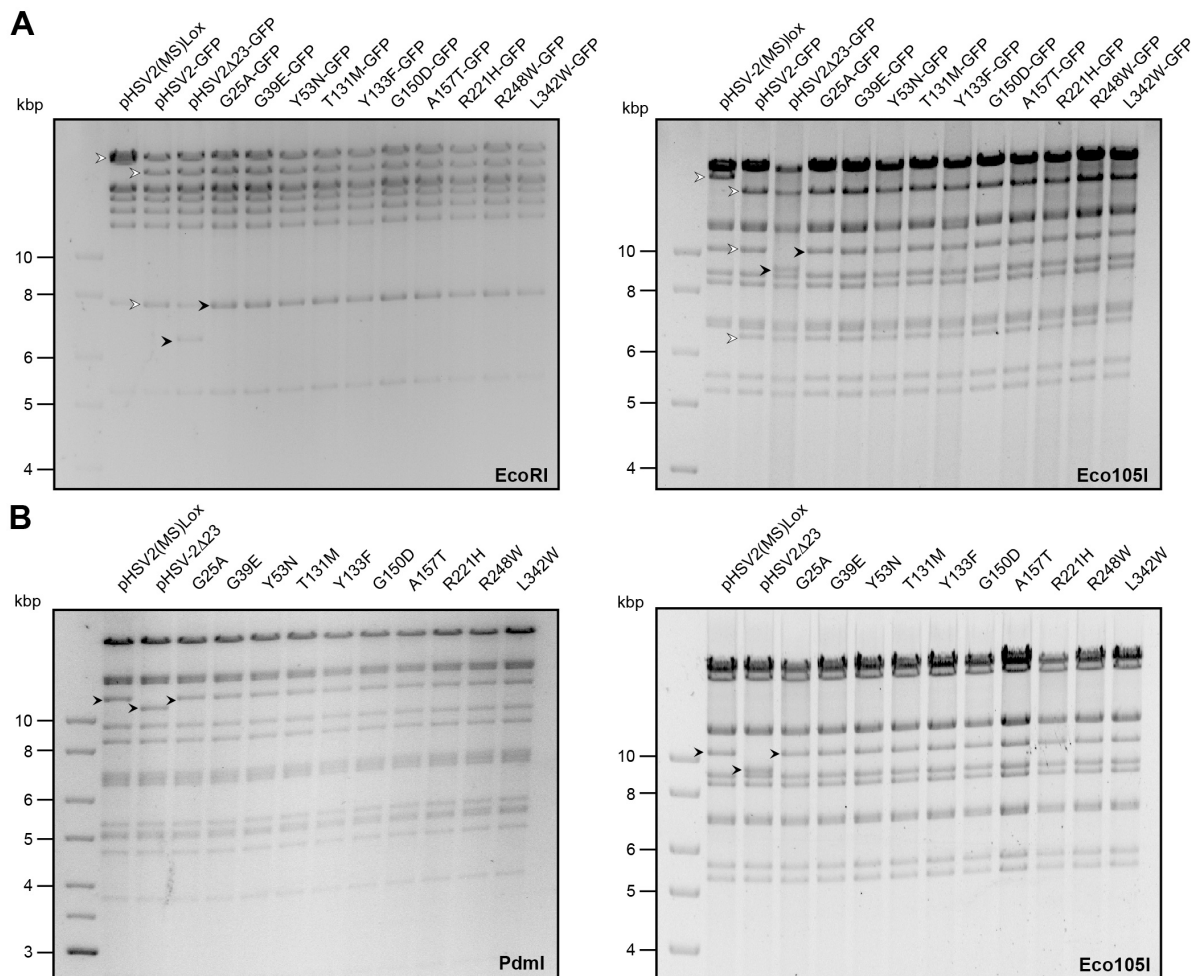

Fig. 3.4: RFLP analysis of the generated HSV-2 BAC mutants. **A** The integration of the EGFP gene was verified by EcoRI (left) and Eco105I (right) digestion. The EGFP cassette was first inserted in the basic BAC pHSV2-(MS)Lox resulting in pHSV2-GFP (white arrows). Then, the native *UL23* gene was deleted (pHSV2Δ23-GFP) and replaced by the modified gene variants (black arrows). **B** The *UL23* gene substitution of the untagged BAC was verified by PdmI (left) and Eco105I (right) digestion. First, the *UL23* gene was deleted from the original BAC pHSV2(MS)Lox resulting in pHSV2ΔUL23. The modified gene was then inserted in its native locus. The associated band shifts of gene deletion and insertion are indicated with black arrows.

Based on the original and the fluorescence-tagged VZV BACs (pHJOpac and pHJO-RFP), the TK-encoding gene *ORF36* was substituted with a similar strategy as explained for the HSV BACs. Fig. 3.6 describes the sequence exchange for the original BAC pHJOpac. In the first step, the *ORF36* sequence was deleted by *en passant* mutagenesis using special oligonucleotides (Tab. 2.16) with 5'-overhangs homologous to the flanking region of the target sequence (Fig. 3.6A). The deletion site of the resulting BAC pHJOΔ36 was amplified with flanking oligonucleotides and confirmed by sequencing.

Simultaneously, transfer vectors with modified *ORF36*-gene sequences were generated (Fig. 3.6B). The sequence was amplified from pHJOpac with *ORF36*-flanking oligonucleotides (Tab. 2.8). The Sall/XmaI-digested amplicon was cloned into the *pCeu2* vector that was linearized by XhoI and XbaI digestion. A kanamycin-resistance cassette was generated

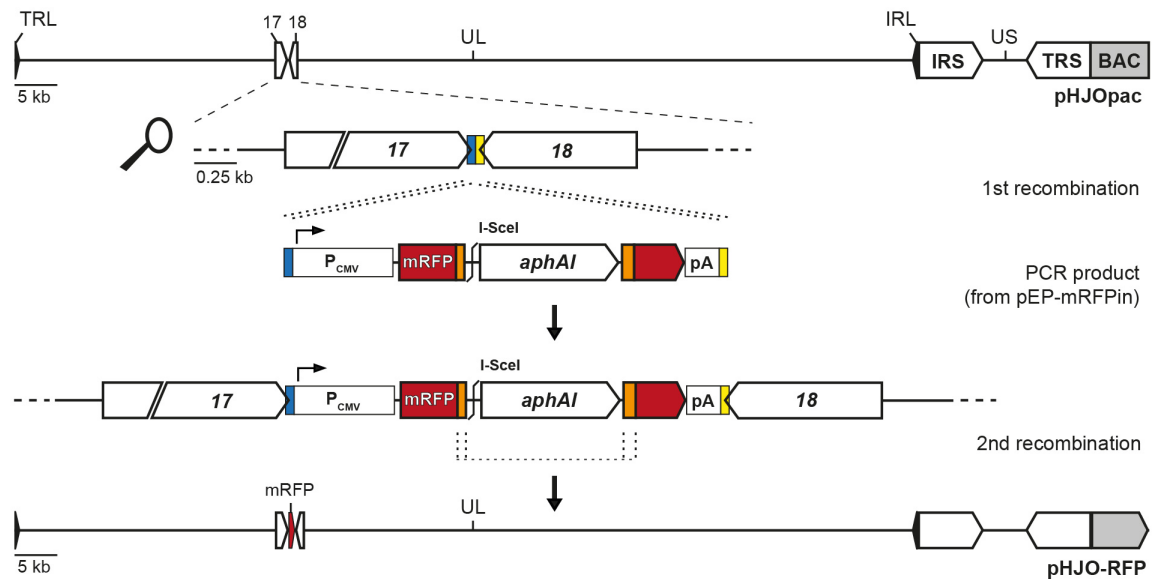

Fig. 3.5: Scheme of *en passant* mutagenesis for fluorescence-marker insertion into the VZV BAC with wild-type configuration. The cassette for mRFP (red), the CMV promoter (P_{CMV}), and the SV40 poly(A) signal (pA) was inserted between the reverse orientated ORF 17 and 18 of the BAC pHJOpac. The I-SceI/*aphAI*- and mRFP-containing PCR product was integrated in the target locus by a first recombination event between the homologous ends (blue, yellow). The selection marker was removed upon a second recombination between the internal sequence duplication (orange) resulting in pHJO-RFP.

in a PCR from pEPkan-S using oligonucleotides containing a 5'-terminal EcoRI restriction site. The PCR product was cloned into the unique EcoRI site adjacent to the *ORF36* gene before nt mutations were generated by site-directed mutagenesis using oligonucleotides listed in Tab. 2.11. The different transfer plasmids were analyzed by sequencing and then used in a PCR to generate the several *ORF36*/kanamycin-cassettes that were transformed into competent *E. coli* harboring the pHJO Δ 36 or pHJO Δ 36-RFP BAC deletion mutants. Using the oligonucleotides (Tab. 2.16) with 5'-end extension, the *ORF36*/kanamycin cassette was integrated into the native position by homologous recombination. The kanamycin resistance gene was then released in a subsequent recombination step resulting in pHJO-xx and pHJO-xx-RFP, whereby "xx" defines the respective amino-acid substitution. Three of the selected mutations that were found both in the VZV TK (Δ 7-74) and in the viral polymerase (T237K and A955T) were introduced directly by *en passant* mutagenesis. The *ORF36* Δ 7-74 mutation results from the large deletion of nt 19-223. Such deletions cannot be introduced by site-directed mutagenesis with a transfer plasmid. The other two substitutions T237K and A955T were found in the viral *pol* gene for which the generation of an appropriate transfer vector would have been too laborious and time-consuming. Subsequent susceptibility testing of the A955T Pol variant revealed no changes in the susceptibility to ACV. For that reason, the Q303stop was additionally inserted into the viral TK as it was observed in patient material (Sauerbrei et al. 2011b).

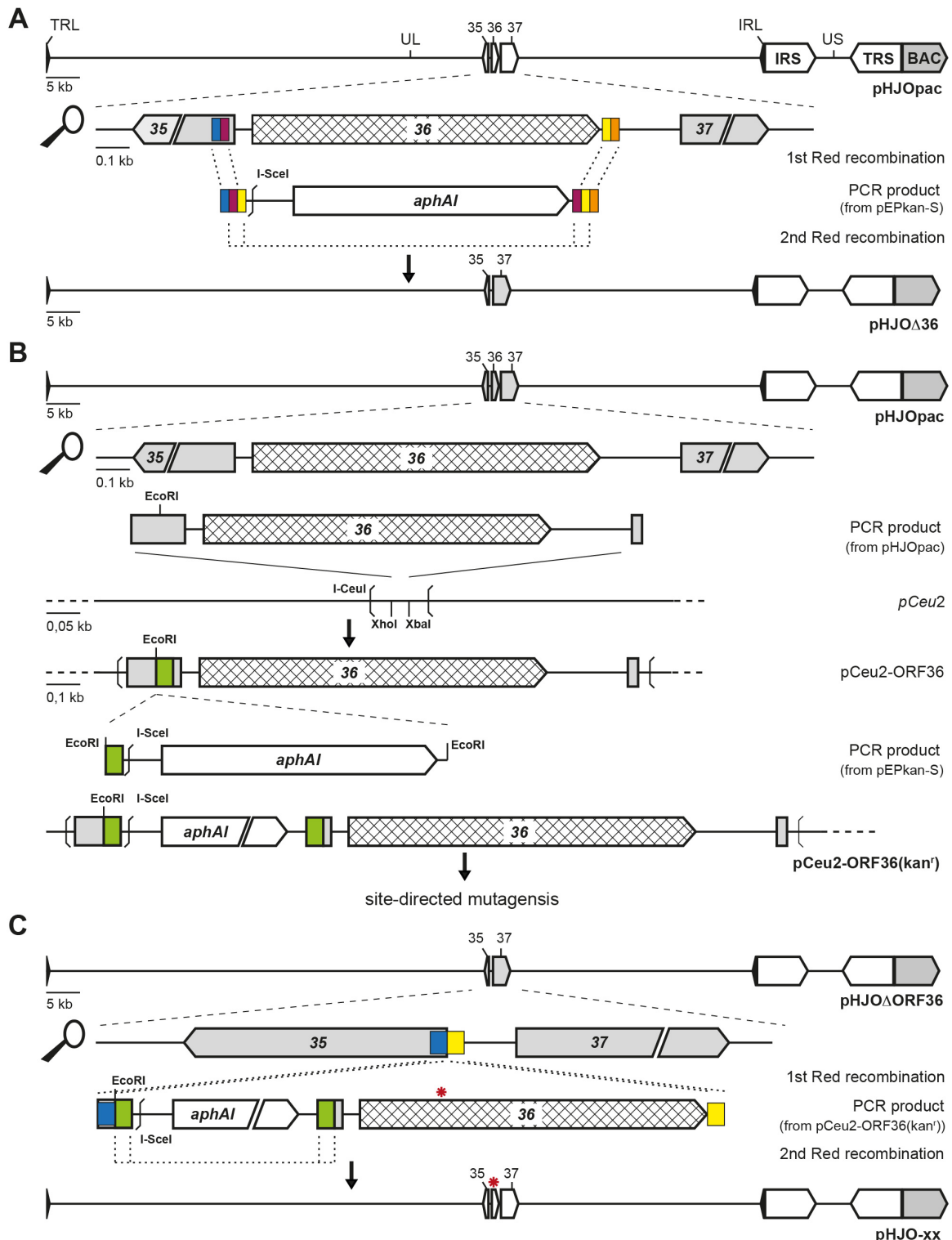

Fig. 3.6: Scheme for the construction of the VZV *ORF36* mutants by *en passant* mutagenesis. **A** The BAC clone pHJOpac served as basis for the generation of the *ORF36* deletion mutant. The flanking regions of *ORF36* (blue/red, yellow/orange) were chosen for the design of the large oligonucleotides. A PCR product was amplified from pEPkan-S and contained a sequence duplication (red/yellow), a kanamycin resistance cassette (*aphAI*), and an I-SceI recognition site. Following the first recombination, *ORF36* was substituted by *aphAI* that was finally released in the second recombination resulting in the *ORF36* deletion mutant pHJO Δ 36. **B** For the generation of the transfer vector, *ORF36* and flanking regions of approximately 250 bp were amplified from pHJOpac. The amplicon was cloned into the XhoI and XbaI sites of the plasmid *pCeu2*. Thereafter, *aphAI*, an I-SceI site, and a 50 bp duplication (green) was cloned into the unique EcoRI site. The product *pCeu2-ORF36(kan^r)* was used as basis vector for site-directed mutagenesis. **C** Generation of the *ORF36* mutants. First, the mutated *ORF36* (red asterisk)/*aphAI* cassette was amplified from the transfer vector and the PCR product was introduced into the deletion site of the *ORF36* deletion mutant pHJO Δ 36. Thereafter, *aphAI* was released after I-SceI expression.

The integrity of the intermediate and final VZV BAC variants was analyzed by RFLP with Bsp1407I or Eco32I (Fig. 3.7). Predicted additional bands (Bsp1407I) or a fragment increase (Eco32I) by approximately 2 kb of pHJO-RFP confirmed the integration of the mRFP-fluorescence marker as indicated with white arrows (Fig. 3.7A). The subsequent *ORF36* sequence deletion in pHJO Δ 36 and pHJO Δ 36-RFP resulted in a band decline of 1 kb according to the gene size. The gene locus was restored after integration of the modified sequence by the transfer constructs resulting in an appropriate fragment size increase. Sequence replacement in the non-tagged BAC pHJOpac revealed similar results (Fig. 3.7B). Furthermore, the intended structure of the affected gene locus was confirmed by sequencing.

The generation of replication-competent viruses was performed by lipofection of highly pure BAC DNA from one verified clone. Virus reconstitution and plaque formation occurred within a few days and the virus strains were propagated to passages six to ten on Vero cells (HSV) or MeWo cells (VZV) to ensure vector self-excision or the release of the vector backbone by internal recombination events (Nagel et al., 2008; Smith and Enquist, 2000; Wussow et al., 2009; Yu et al., 2002). After stock preparation, viral DNA was extracted from the supernatant (HSV) or from infected cells (VZV). The *tk* gene was amplified with flanking primers and sequenced to confirm the presence of the desired mutation and to guarantee the absence of additional unwanted polymorphisms.

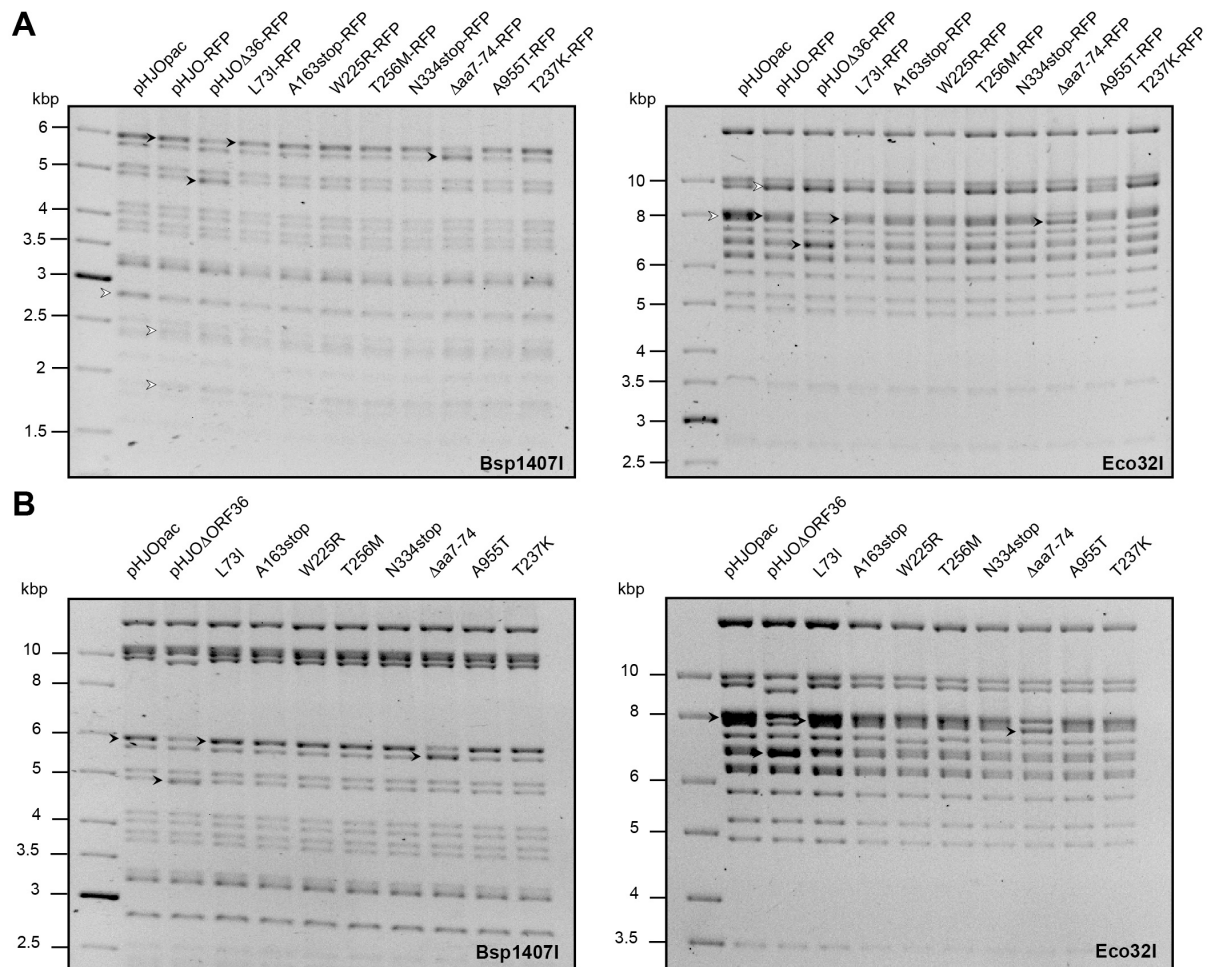

Fig. 3.7: RFLP analysis of the generated VZV BAC variants. **A** The mRFP-cassette integration and subsequent *ORF36* substitution was examined by Bsp14071 (left) and Eco321 (right) digestion. First, mRFP insertion into pHJOpac resulted in pHJO-RFP (white arrows) and *ORF36* sequence deletion in pHJOΔ36-RFP. Following *ORF36* sequence insertion (black arrows) led to several *tk* gene variants. **B** The exchange of the native against the modified *ORF36* was examined by Bsp14071 (left) and Eco321 (right) digestion. The wild-type based BAC pHJOpac was used for *ORF36* sequence deletion resulting in pHJOΔORF36 and following insertion of the *tk* gene variants. Changes in fragment sizes are indicated by black arrows.

3.2 Suitability of the recombinant mutant viruses

After reconstitution of virus progeny and verification of the integrity of the modified *tk* genes, replication kinetics were performed to demonstrate comparable properties. Genome manipulations including sequence insertions or deletions can result in declined progeny yields leading to falsified outcomes in the following approaches. For that reason, a specific number of cells were infected with a constant viral inoculum and virus progeny was harvested at defined time points depending on the replication capacity. For example, HSV-1 replicates noticeably faster than VZV. Therefore, sampling in shorter frequencies is needed. Samples were taken in triplicates and the PFU number was calculated after titration. The virus titers were plotted as a function of time.

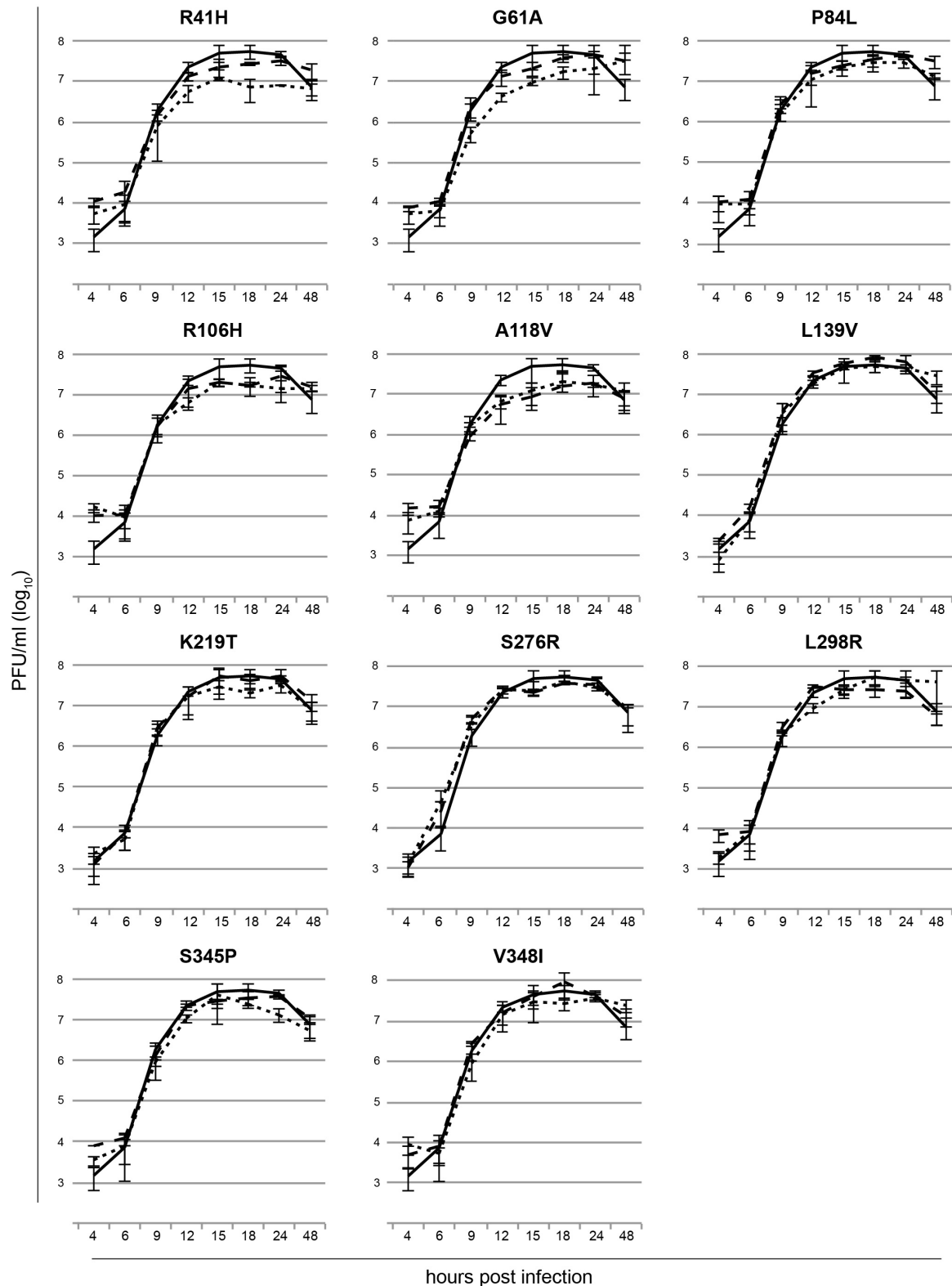

Fig. 3.8: One-step replication kinetics of HSV-1 recombinants. Vero cells were infected with an MOI of 5 and the supernatant was taken at several time points to show the viral replication rate as function of time. The TK-mutated strains R41H, G61A, P84L, R106H, A118V, L139V, K219T, S276R, L298R, S345P, and V348I (dotted lines) were compared with their EGFP-labeled counterpart (dashed lines) and the recombinant wild-type based HSV1(17⁺)Lox (solid line). The data were plotted as a mean and SD of triplicates.

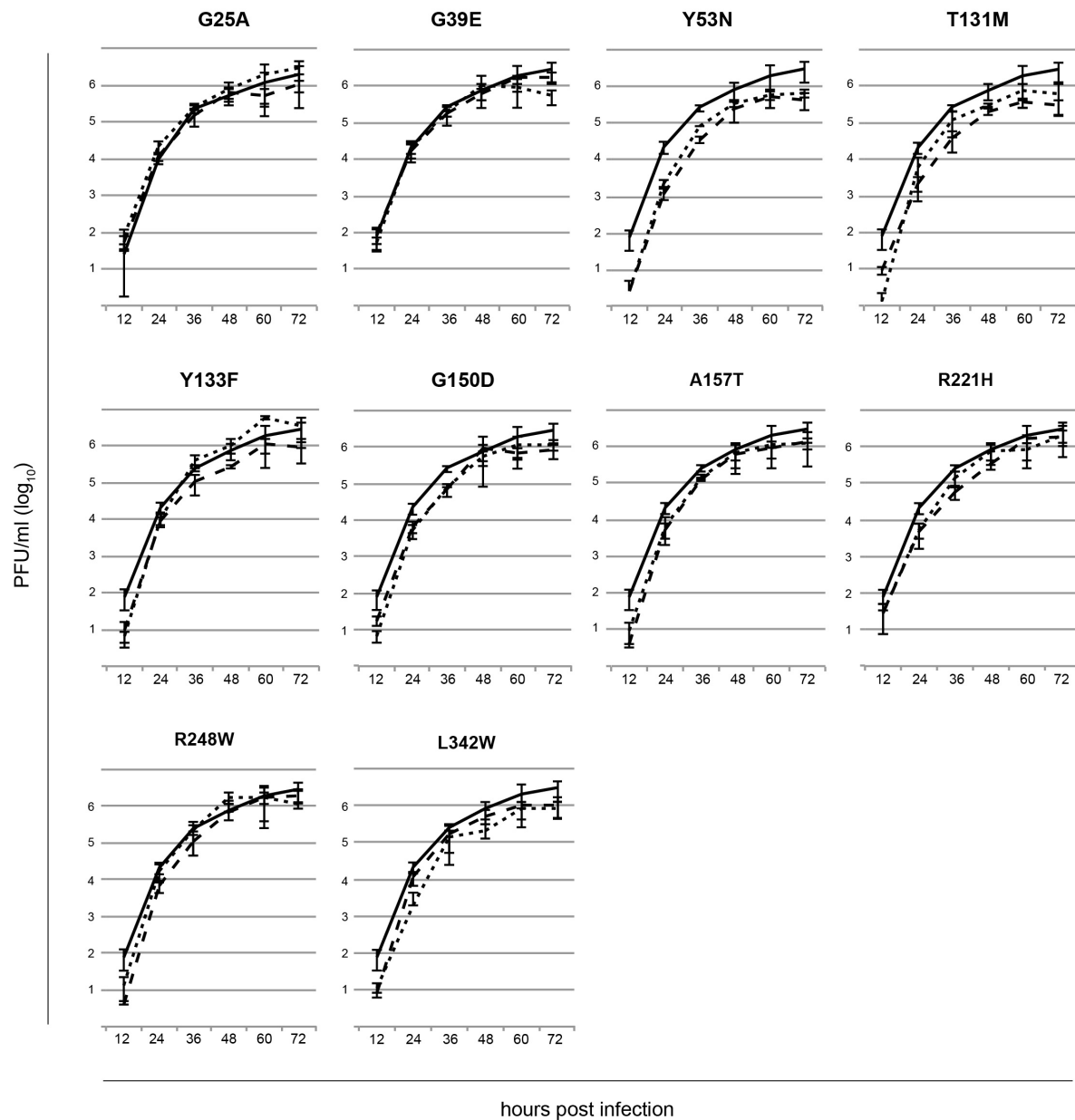

Fig. 3.9: Multi-step replication kinetics of recombinant HSV-2 strains. Vero cells were infected with an MOI of 0.001 and harvested with the supernatant at several time points. The TK-mutated strains G25A, G39E, Y53N, T131M, Y133F, G150D, A157T, R221H, R248W, and L342W (dotted lines) were compared with their EGFP-tagged counterpart (dashed lines) and the recombinant wild-type based HSV2(MS)Lox (solid line). The data were plotted as a mean and SD of triplicates.

Basically, a mutated virus strain was compared with its fluorescent counterpart and with the recombinant wild-type based original strain. Significant differences between the compared strains were not detected for the HSV recombinants (Fig. 3.8 and 3.9). Concerning VZV, divergent starting inocula were obtained due to cell-associated infection, even though 100 PFU were intended to achieve. Finally, the replication curves were normalized to 10 PFU inoculum to enable better comparative analysis. Also the VZV mutants exhibited comparable replication features (Fig. 3.10).

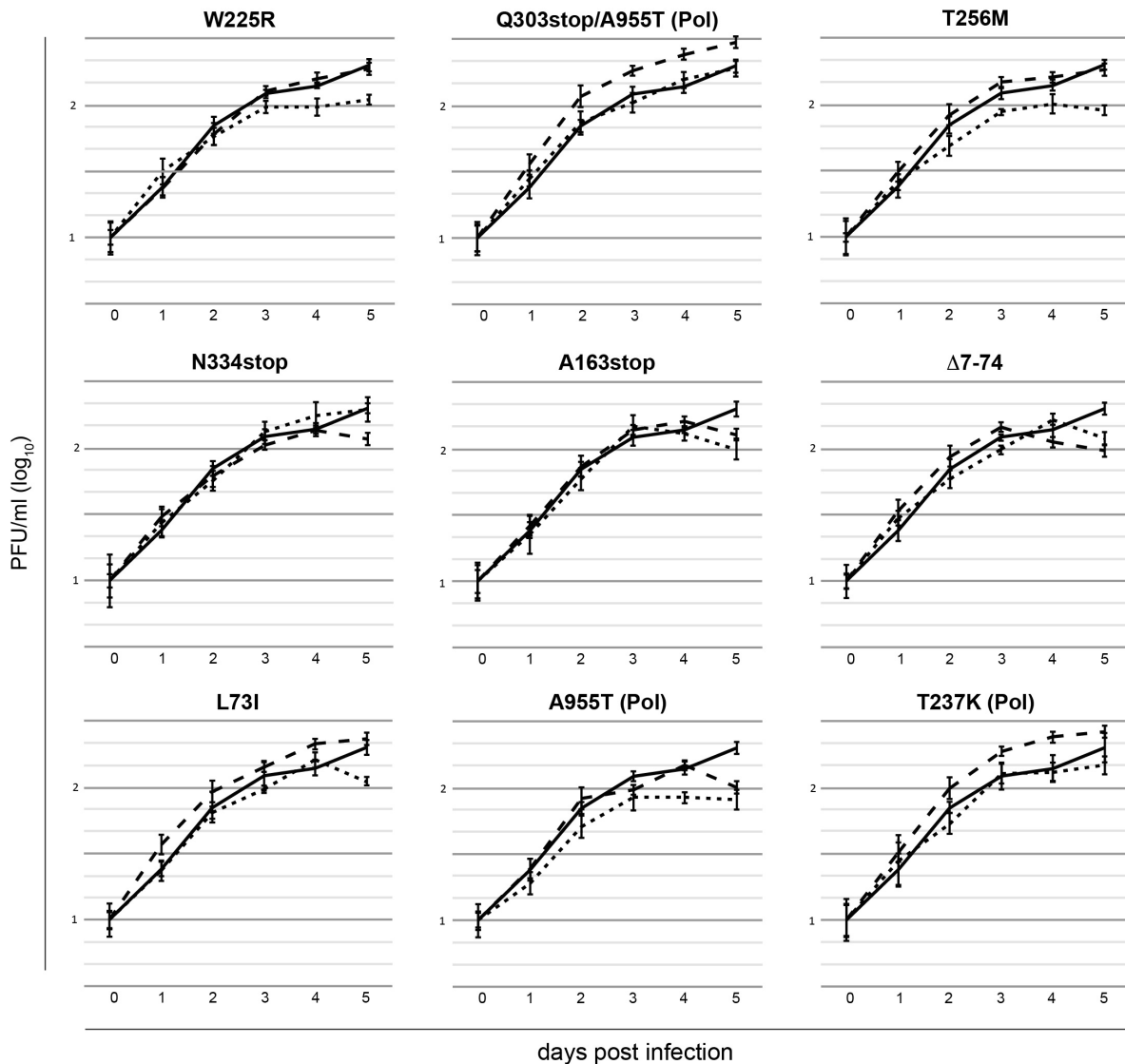

Fig. 3.10: Multi-step replication kinetics of VZV recombinants. The multi-step replication kinetics of the recombinant VZV TK mutants resulting in W225R, Q303stop/A955T(Pol), T256M, N334stop, A163stop, Δ 7-74, and L73I and the Pol mutants resulting in A955T and T237K (dotted lines) in comparison to the respective mRFP-labeled counterpart (dashed lines) and the recombinant wild-type based HJOpac (solid line) are demonstrated as virus titers against time. The data are plotted as the mean and SD of the results determined with four samples from three independent experiments.

Tk gene transcription was examined as the next step of virus-strain confirmation. Cells were infected with similar PFU and RNA was prepared after one to three days of cultivation from whole-cell lysates. After DNase I treatment, the RNA samples were used for cDNA synthesis by reverse transcription. DNA copies of *tk* transcripts were shown by a following PCR with *tk*-specific internal oligonucleotides (Tab. 2.17). In addition, exon-specific transcripts for the housekeeping gene GAPDH were detected as internal control. Moreover, the PCR was also performed with samples without reverse transcriptase treatment to exclude false-positive results from DNA-contaminated samples. Bands of the predicted size indicated *tk* gene transcription for all reconstituted viruses (Fig. 3.11; Tab. 2.17).

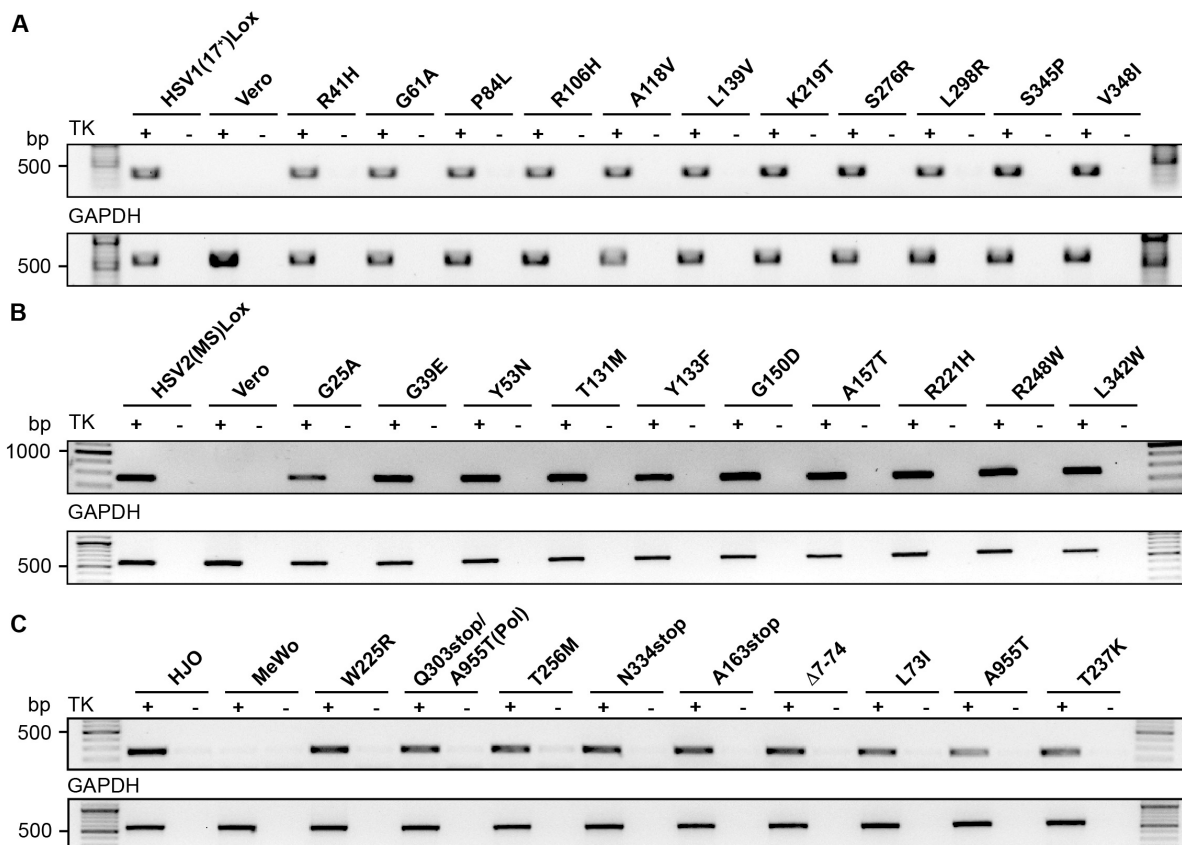

Fig. 3.11: *Tk* gene transcription confirmed by RT-PCR. Vero cells were infected with HSV, and MeWo cells were infected with VZV. After two days of incubation, total RNA from whole-cell lysates was prepared and reverse transcribed. The cDNA of each HSV-1 (A), HSV-2 (B), and VZV (C) strain was used in a PCR with *tk*-specific oligonucleotides. GAPDH transcripts with exon-specific oligonucleotides served as internal control. The PCR was performed from samples treated with (+) or without (-) reverse transcriptase to exclude false-positive signals from DNA-contamination.

Finally, TK protein expression was examined either by immunoblot analysis (Fig. 3.12) or by immunofluorescence microscopy (Fig. 3.13 and 3.14). For immunoblotting, a defined cell number was infected with constant PFU and the cell lysates were generated after one to three days of incubation. The proteins of equal lysate volumes were separated by SDS-PAGE. Besides TK protein detection, the presence of viral glycoproteins (gD for HSV and gI for VZV) and β -actin was demonstrated for viral loading control and cellular control, respectively. The TK protein was detected in all cases of infected cells at approximately 45 kDa (HSV) and 40 kDa (VZV) comparably to the positive control of recombinant wild-type based viruses. Exceptionally, the TK was not detected for some VZV strains (Fig. 3.12C). These strains exhibited a nt substitution resulting in a premature stop of translation (A163stop, Q303stop/A955T, and N334stop). The truncated proteins lack the C-terminus, where the anti-TK antibody is supposed to bind to. The TK-protein of VZV strain Δ 7-74 was detected at 27 kDa correlating with the respective sequence deletion of 67 amino-acid residues. As expected, the viral loading control and the cellular control exhibited positive signals.

Glycoprotein D was detected between 50-90 kDa (Fig. 3.12A and B; middle panel) and gI between 70-100 kDa (Fig. 3.12C; middle panel), which could result from different glycosylation forms. The ubiquitous cellular protein β -actin was detected in all cell lysates at 45 kDa (Fig. 3.12A, B, and C; lower panel).

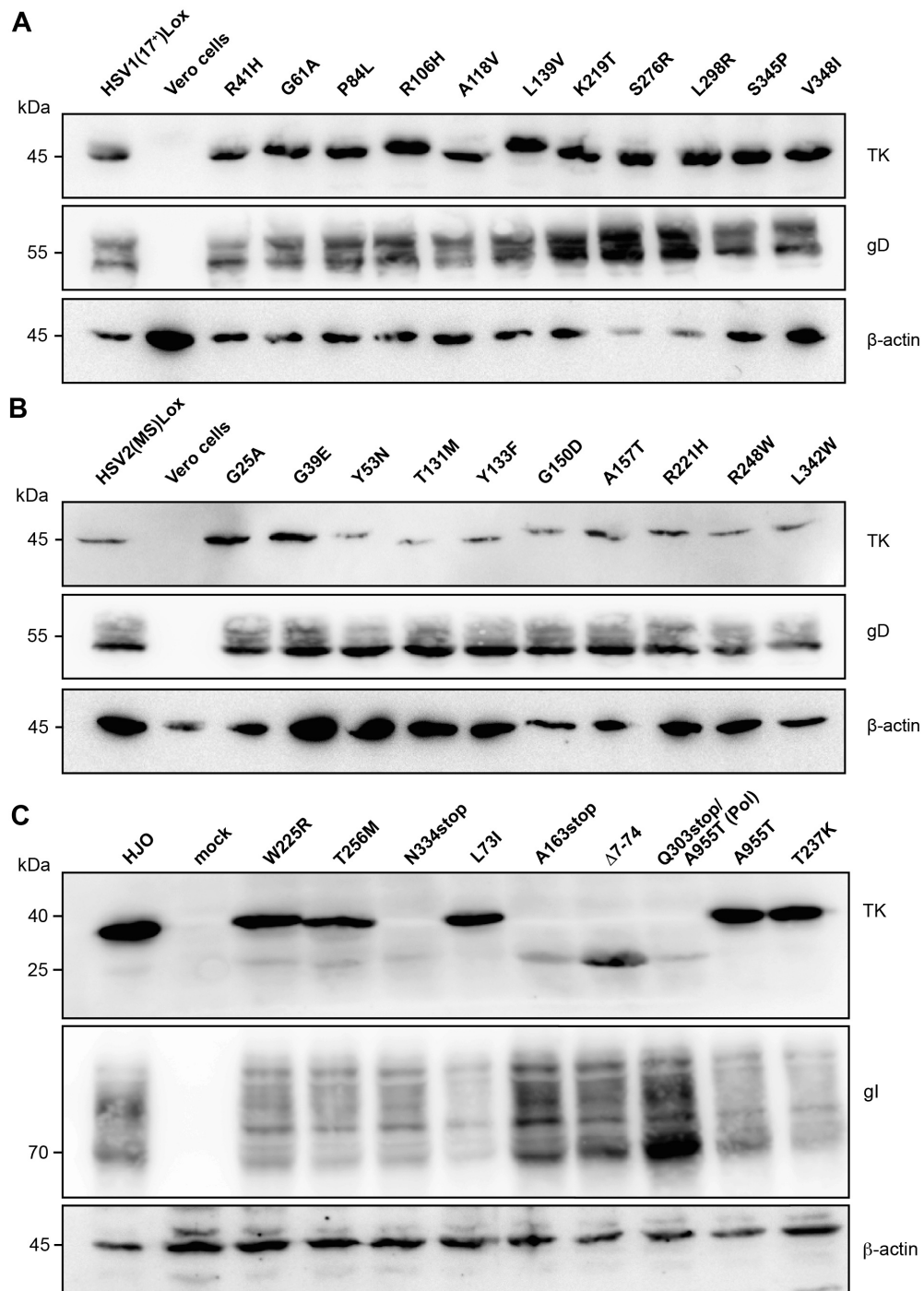

Fig. 3.12: TK protein expression examined by immunoblot analysis. Vero cells were infected with HSV and MeWo cells were infected with VZV or mock-infected. After two days of incubation, cells were lysed and proteins were separated by SDS-PAGE. The TK proteins of HSV-1 strains (**A**) and HSV-2 strains (**B**) were detected with an HSV-specific polyclonal anti-TK antibody. Detection of gD served as viral control. The TK protein of VZV (**C**) was detected by a VZV-specific polyclonal anti-TK antibody while detection of gI served as viral control. For all infected and mock-infected cells, the detection of the ubiquitous β -actin served as cellular loading control.

For immunofluorescence microscopy, cells were seeded on cover slips and infected with few PFU to obtain single plaques. Fluorescent virus strains were used to visualize infected cells and the TK protein was detected using fluorescent-labeled secondary antibodies, which are directed to the TK-specific polyclonal antibodies. All TK variants could be detected (Fig. 3.13 and 3.14), however, at a lower intensity for the truncated proteins of the VZV mutants A163stop, Q303stop/A955T, and N334stop (Fig. 3.13). Recombinant wild-type strains were treated with the secondary antibody alone to exclude unspecific binding and staining (data not shown).

Thus, all the generated virus mutants showed similar replication properties and TK expression in comparison to wild-type viruses and are suitable for the drug susceptibility testing in order to define the contribution of defined *tk* sequence alterations to resistance.

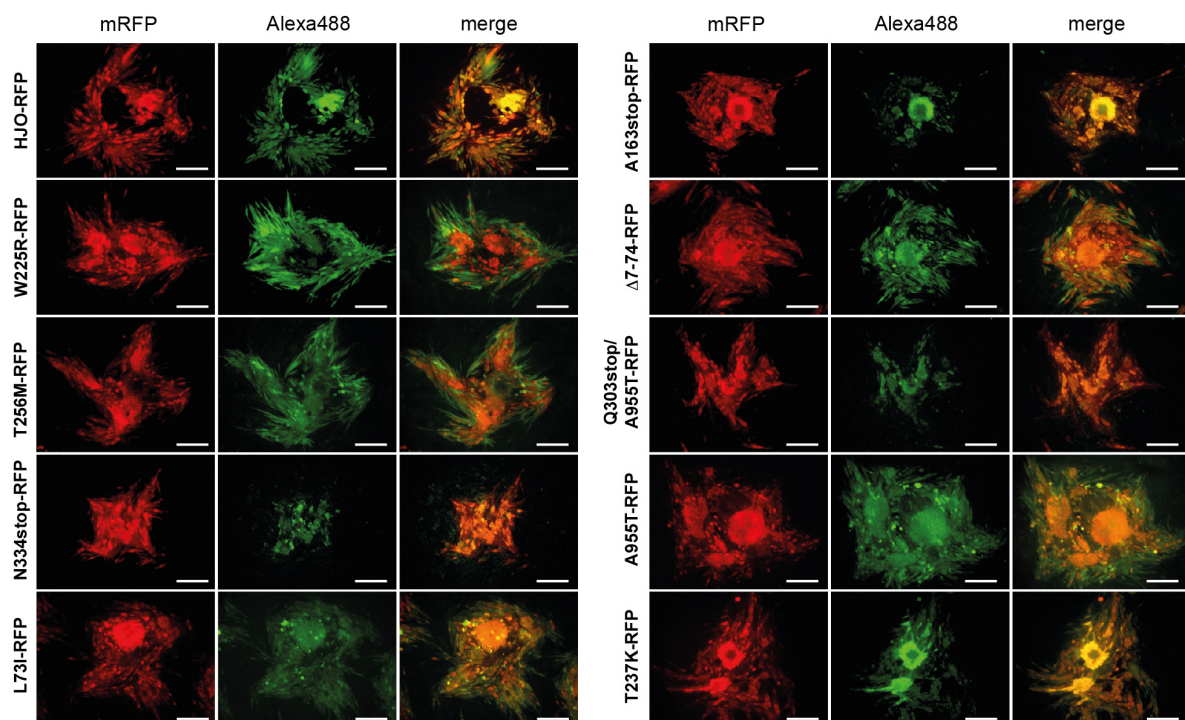

Fig. 3.13: TK protein expression revealed by immunostaining of recombinant VZV strains. MeWo cells were infected with mRFP-tagged VZV strains (red, left panel). Plaques were counterstained with an Alexa488-conjugated antibody that is directed to the TK-specific primary antibody (green, middle panel). The right panel displays a merged image of both emission channels. Bar = 100 μ M.

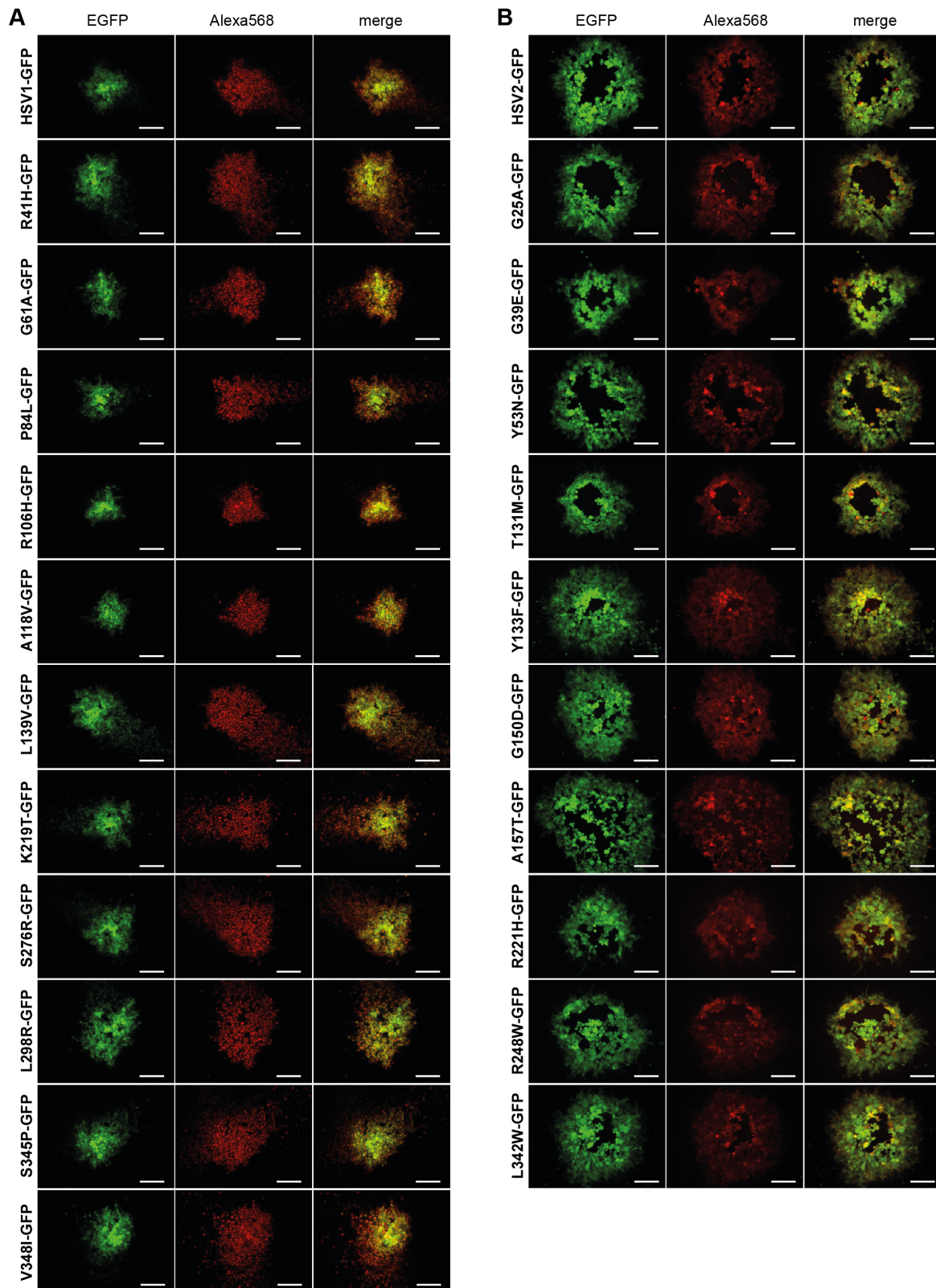

Fig. 3.14: Thymidine kinase (TK) protein expression was confirmed by immunofluorescence microscopy of recombinant HSV strains. Vero cells were infected with EGFP-tagged HSV-1 (A) and HSV-2 (B) strains (green, left panel) and stained with an Alexa-568-conjugated antibody directed against a HSV TK-specific polyclonal antibody (red, middle panel). The right panel displays the merged images. Bar = 100 μ M

3.3 Susceptibility testing of recombinant virus strains

Due to comparable replication capacities and the confirmation of *tk* gene expression, the different fluorescent HSV and VZV strains were considered to be suitable for susceptibility testing by CPE inhibition or PRA. Prior to susceptibility testing, different MOIs of the strains HSV1-GFP and HSV2-GFP were assayed in absence of ACV to determine the correlation between the RFU value and the infectious particle number (Fig. 3.15). The RFU values obtained from both strains increased linearly with increasing MOIs over the range of 0.0001 to 0.1 (HSV1-GFP) or 0.001 to 1 (HSV2-GFP) after one or two days post infection, respectively. Thus, the RFU value at the MOI of 0.01 was used for EC₅₀ calculation.

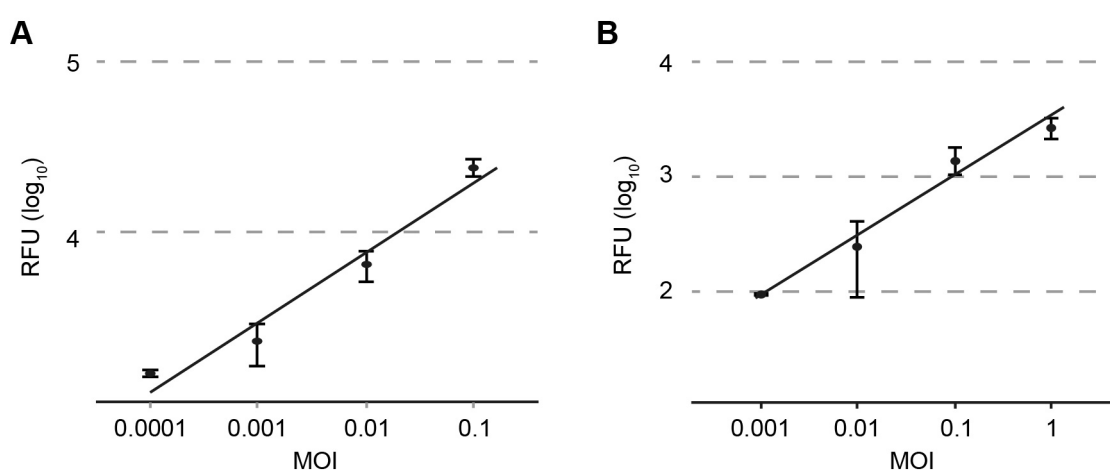

Fig. 3.15: Correlation of virus loads to relative fluorescence units (RFU) of reporter-labeled HSV strains. A constant number of Vero cells were infected with different MOIs of the fluorescence-tagged recombinant virus strains HSV1-GFP (A) and HSV2-GFP (B) and the RFU was measured one or two days post infection, respectively. The data are plotted as the mean and SD of twelve samples from one representative experiment.

For HSV and VZV, the susceptibility testing was performed by different methods depending on the viral replication rate of the strains. Since HSV replicates relatively fast, single plaque formation for accurate counting is difficult to obtain especially without agar overlay. Due to this aspect, the susceptibility of the HSV-1 and HSV-2 strains against ACV was determined in a CPE inhibition assay. Equal quantities of Vero cells were infected with an MOI of 0.01 of fluorescent virus strains. ACV was applied in concentrations ranging from 0.275 to 35.2 μ M and the RFU was measured one (HSV-1) or two (HSV-2) days post infection by a microplate reader. Since it was shown, that the fluorescence intensity correlates with the viral load, the EC₅₀ value was calculated directly by the RFU means. After four days post infection, viral replication was indirectly analyzed by assessing the metabolic activity of the remaining living cells to confirm and strengthen the obtained EC₅₀ values by RFU measurements. Furthermore, the comparison to the non-fluorescent reference strains was

easily possible by this method. The cell viability was determined by the colorimetric WST-8 assay and EC_{50} values were calculated by dose-response curves.

HSV-1 strains with the amino-acid substitutions R41H, R106H, A118V, L139V, K219T, S276R, L298R, S345P, and V348I showed a sensitive phenotype with EC_{50} values ranging from 0.72 ± 0.38 to 2.21 ± 0.94 μM ACV similar to the recombinant sensitive reference strain HSV1-GFP that exhibited an EC_{50} value of 1.30 ± 0.47 μM ACV. In contrast, the amino-acid substitutions G61A and P84L caused resistance against ACV with EC_{50} values beyond the cutoff value (6.97 μM) greater than 35.2 μM (G61A) or 21.90 ± 12.15 μM (P84L). Comparable results were obtained when the EC_{50} values were calculated from measurements of the cell viability (Tab. 3.2).

The following amino-acid substitution in the TK of HSV-2 G25A, G39E, T131M, Y133F, G150D, A157T, R248W, and L342W maintained susceptibility against ACV with EC_{50} s ranging from 3.16 ± 0.17 to 6.70 ± 0.71 μM ACV comparable to the recombinant sensitive reference strain HSV2-GFP with an EC_{50} value of 5.30 ± 1.41 μM ACV. Both substitutions Y53N and R221H, on the other hand, conferred resistance against ACV with EC_{50} s above 35.2 μM exceeding the cutoff value of 27.91 μM ACV. EC_{50} values calculated from cell viability measurements with WST-8 were comparable with those obtained from RFU measurements (Tab. 3.2).

The susceptibility to ACV of manipulated VZV strains was tested classically in a PRA by counting red-fluorescent plaques. The viral load was adjusted to approximately 20 to 30 PFU per well to allow accurate counting. VZV propagation is strictly cell-associated in cell culture and plaque formation is associated with one infectious unit (*i.e.* PFU). The recombinant mRFP-labeled ACV sensitive strain pHJO-RFP was used as reference. The TK mutations A163stop, W225R, T256M, Q303stop, N334stop, and $\Delta 7-74$ were classified to cause resistance against ACV since the virus strains were able to replicate at high ACV concentrations (35.2 μM) and the EC_{50} s above 35.2 μM exceeded the cutoff value (26.25 μM ACV). The amino-acid substitution L73I in the viral TK and both substitutions T237K and A955T in the viral polymerase left a sensitive phenotype with EC_{50} values ranging from 5.72 ± 0.44 to 7.92 ± 0.44 μM in presence of ACV similar to the EC_{50} of the reference strain (6.23 ± 1.33 μM ACV). The calculated EC_{50} s are listed in Tab. 3.2.

Tab. 3.2: ACV resistance of the targeted recombinant α -herpesvirus variants. Mean effective concentrations at 50% (EC_{50}) values plus/minus SD of ACV on the basis of triplicates. The EC_{50} values for resistance to ACV were determined as at least five times (HSV) or four times (VZV) the mean value plus SD of the susceptible recombinant reference strains HSV1-GFP, HSV2-GFP, and HJO-RFP (*italic*). Values related to resistance are in bold. *SD calculation not possible.

Amino acid substitution	Mean EC_{50} in $\mu M \pm SD$		Amino acid substitution	Mean EC_{50} in $\mu M \pm SD$		Mean EC_{50} in $\mu M \pm SD$
	by RFU	by cell viability		HSV-2	by RFU	
HSV-1						by counting
R41H	1.56±0.30	0.76±0.91	G25A	6.70±0.71	4.07±1.30	7.92±0.44
G61A	> 35.2*	> 35.2*	G39E	4.55±0.07	3.10±0.20	> 35.2*
P84L	21.90±12.15	> 35.2*	Y53N	> 35.2*	> 35.2*	> 35.2*
R106H	0.90±0.22	0.85±0.12	T131M	2.92±1.10	2.67±1.60	> 35.2*
A118V	1.10±0.30	0.75±0.13	Y133F	3.81±0.49	4.08±2.40	> 35.2*
L139V	0.72±0.38	1.60±0.72	G150D	4.97±0.27	5.32±0.97	> 35.2*
K219T	1.36±0.81	0.60±0.53	A157T	3.16±0.17	2.60±1.90	> 35.2*
S276R	1.06±0.81	0.66±0.41	R221H	> 35.2*	> 35.2*	7.04±1.11
L298R	2.21±0.94	2.71±0.91	R248W	4.64±1.30	3.72±0.27	5.72±0.44
S345P	1.50±0.68	1.16±0.62	L342W	5.43±1.20	2.05±0.45	
S345P	1.67±0.92	0.92±0.86				
<i>HSV1-GFP</i>	1.30±0.47	1.22±0.25	<i>HSV2-GFP</i>	5.30±1.41	2.45±1.26	6.23±1.33
<i>HSV-1 Mi</i>		0.82±0.41	<i>HSV-2 MS</i>		3.42±0.84	

The assessment of specific amino-acid mutations in their contribution to a resistance phenotype was confirmed by qPCR. This approach allows the quantitation of viral genome copies in presence or absence of ACV. A constant number of Vero or MeWo cells were infected with either an MOI of 0.01 for the HSV strains or with 100 PFU of VZV and an equal volume from DNA lysates was used for qPCR. The recombinant wild-type based strains HSV1-GFP, HSV2-GFP, and HJO-RFP were cultivated under ACV concentrations ranging from 0 to 35.2 μM ACV whereas the TK-modified strains were tested only in absence or in presence of 35.2 μM ACV. The results of the sensitive reference strains demonstrated a decreasing replicative capacity with increasing ACV concentrations (Fig. 3.16A, 3.16B, and 3.17A).

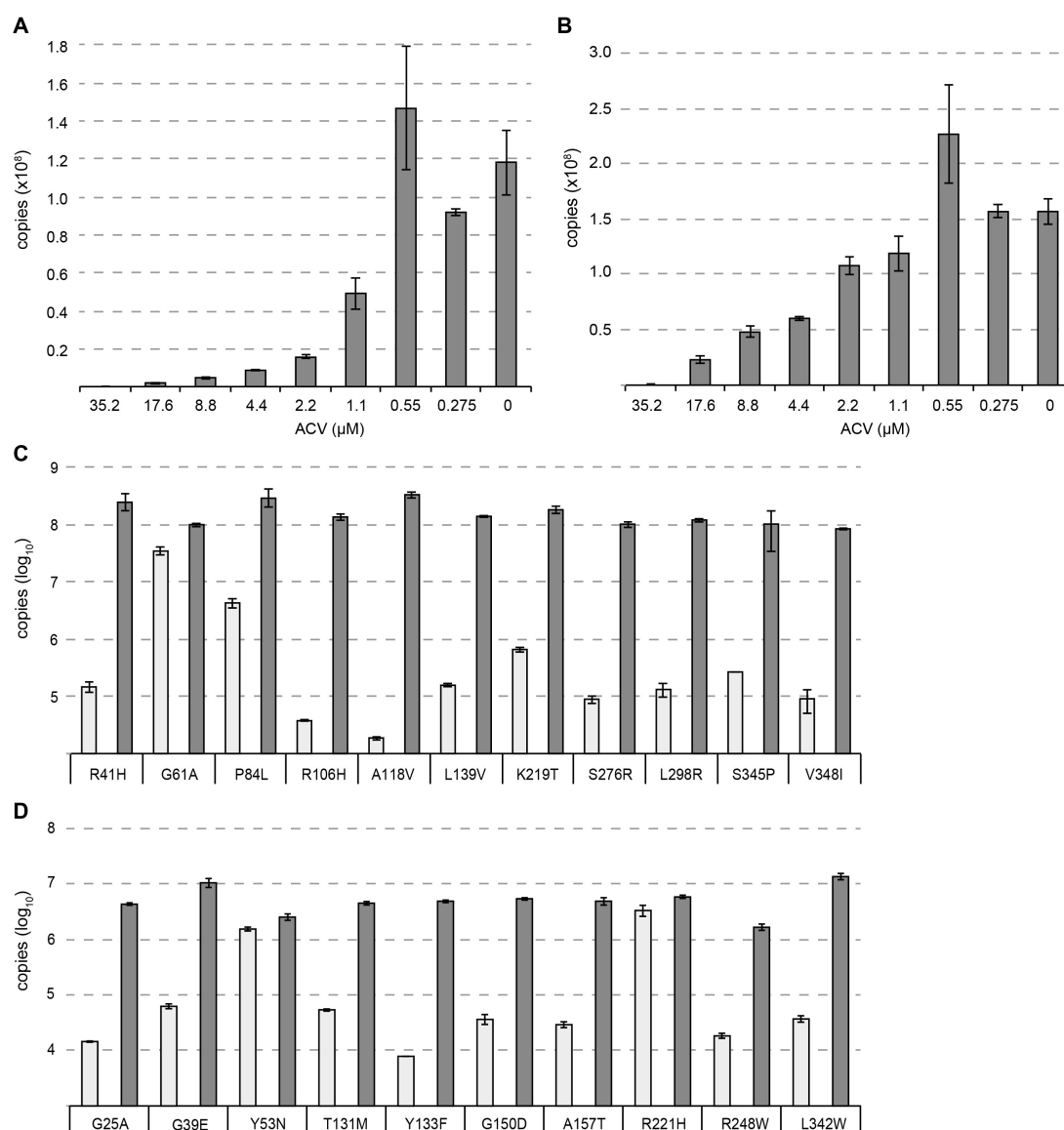

Fig. 3.16: Determination of HSV genome copy numbers by qPCR under various ACV concentrations. Vero cells were infected with an MOI of 0.01 and a volume of 3.3% of eluted DNA from whole-cell lysates was used for qPCR. The recombinant HSV1-GFP strain (A) and HSV2-GFP strain (B) were tested against ACV concentrations from 35.2 to 0 μM . HSV1-GFP and HSV2-GFP were graded as sensitive reference strains. The TK-modified HSV-1 (C) and HSV-2 (D) variants were tested both with 35.2 μM ACV (light grey bars) and in absence of ACV (dark grey bars). Data are plotted as the mean and SD of three measurements from one representative experiment.

The ACV-susceptible HSV-1 strains with the single amino-acid substitutions R41H, R106H, A118V, L139V, K219T, S276R, L298R, S345P, and V348I exhibited low copy numbers ranging from 1.8×10^4 to 6.5×10^5 in presence of $35.2 \mu\text{M}$ ACV (Fig. 3.16C) comparable to the amount of 2.5×10^5 copies for the sensitive reference strain HSV1-GFP (Fig. 3.16A). The load of HSV1-GFP genomes increased with decreasing ACV concentrations to 1.2×10^8 copies in absence of ACV. Similar values at this concentration ($\approx 1 \times 10^8$ copies) were obtained for the sensitive strains as well as for the two resistant strains with the amino-acid substitutions G61A and P84L. However, both strains exhibited a distinctly increased replication at $35.2 \mu\text{M}$ ACV with 3.4×10^7 copies for G61A and 4.2×10^6 copies for P84L, respectively.

Genomes of HSV2-GFP were detectable at $35.2 \mu\text{M}$ with an amount of approximately 1.2×10^4 copies and steadily increasing amounts up to 1.5×10^6 copies in ACV absence exceeding the previous one by two log steps (Fig. 3.16B). The sensitive-considered strains with the amino-acid substitutions G25A, G39E, T131M, Y133F, G150D, A157T, R248W, and L342W exhibited genome copies ranging from 7.8×10^3 (Y133F) to 6.2×10^4 (G39E) at high ACV concentrations ($35.2 \mu\text{M}$) similar to the corresponding value of the sensitive reference. The genome copy numbers of the two resistant-classified strains with the amino-acid substitutions Y53N and R221H was equal in presence of high ACV concentrations and in ACV absence with approximately 1×10^6 and 1×10^7 . This is consistent with the virus loads of the sensitive strains in absence of ACV (2.2×10^6 to 8.2×10^7 copies) (Fig. 3.16D).

The sensitive VZV strain L73I as well as both polymerase-mutated strains with the amino-acid substitutions T237K and A955T were tested against ACV concentrations ranging from 35.2 to $0 \mu\text{M}$ and compared to the recombinant wild-type based HJO-RFP (Fig. 3.17A). The virus load of each strain was similar to the reference strain at each ACV concentration. Virus loads at $35.2 \mu\text{M}$ ranged from 2.9×10^4 (L73I) to 1.5×10^5 (HJOpac) copies while distinct higher amounts were detectable in absence of ACV with values ranging from 5.3×10^7 (L73I) to 1.2×10^8 (A955T). In contrast, the resistance-associated strains with the amino-acid mutations A163stop, W225R, T256M, Q303stop, N334stop, and $\Delta 7-74$ exhibited similar genome copy numbers in presence and in absence of ACV ranging from 7.6×10^6 to 4.9×10^7 (Fig. 3.17B).

Taken together, individual sequence alterations of the *tk* genes of HSV-1, HSV-2, and VZV were successfully tested for their contribution to antiviral resistance and precisely attributed to a natural or to a resistance-associated polymorphism in order to improve decisions in antiviral therapy.

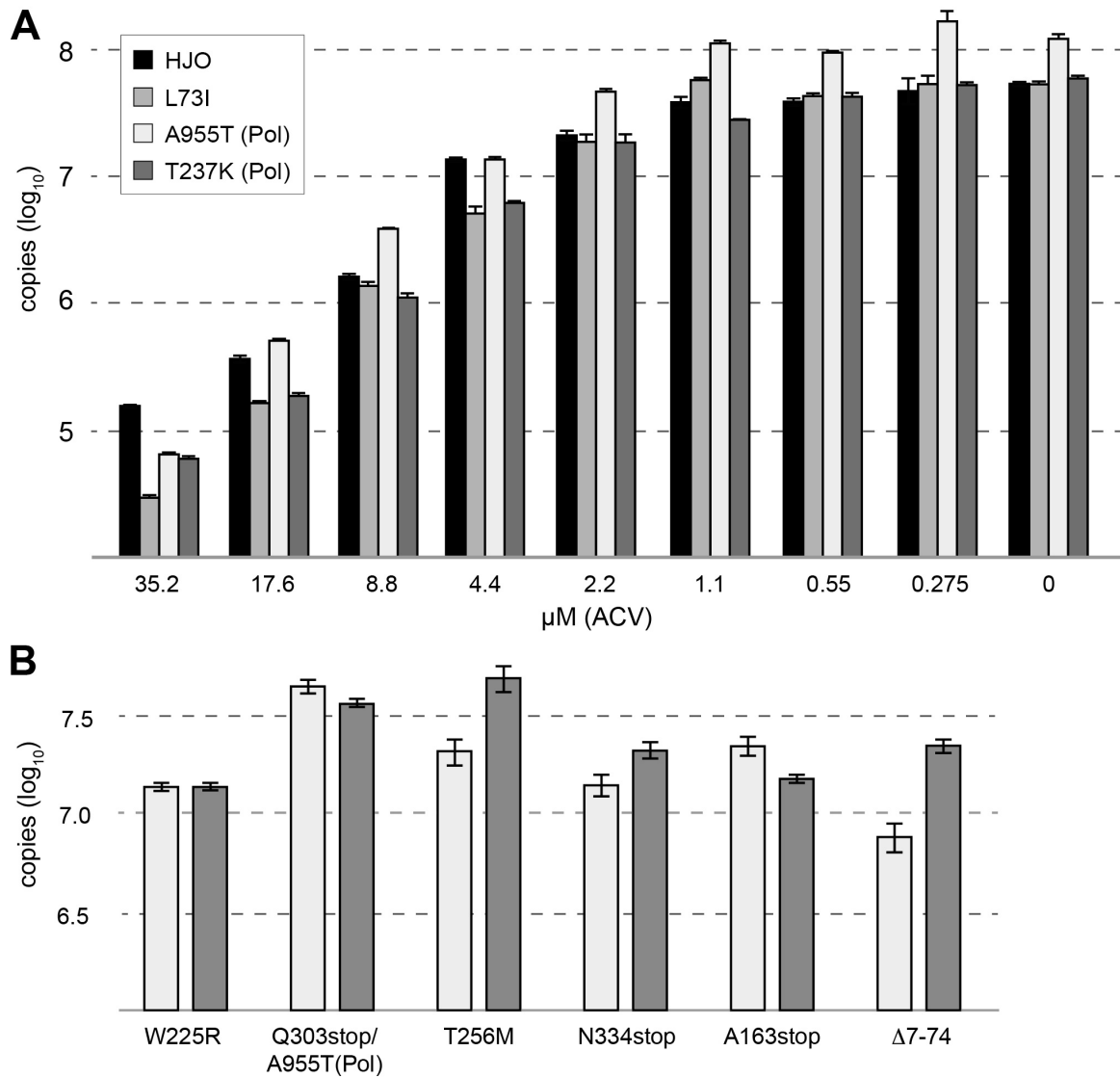

Fig. 3.17: Quantitation of VZV genomes by qPCR. A constant number of MeWo cells were infected with similar PFU per strain and qPCR was performed with a volume of 3.3% from eluted DNA extracted from cell lysates. **A** The virus strains HJO-RFP, L73I, A955T, and T237K were tested using ACV concentrations ranging from 35.2 to 0 μM and classified as sensitive. **B** The resistant strains were tested using 35.2 μM ACV (light grey bars) or none (dark grey bars).

4 DISCUSSION

In this study, several recombinant virus strains belonging to the subfamily of human-pathogenic α -*Herpesvirinae* were generated with clinically relevant mutations in the *tk* and *pol* genes. Genetic modification was enabled by BAC-cloned virus genomes and advanced recombination techniques in prokaryotic and eukaryotic cells. The additional insertion of an autonomously expressed fluorescence reporter gene substantially facilitated the susceptibility testing against ACV. Using this strategy, all selected mutations were unambiguously attributed to the ACV sensitive or the resistant phenotype.

4.1 Traceless modification of herpesvirus genomes by *en passant* mutagenesis

In many previous attempts, the contribution of unknown polymorphisms to the ACV resistance phenotype was examined. Most commonly, the genotype of the affected genes from clinical isolates resistant to an antiviral drug has been determined. Usually, an accumulation of multiple polymorphisms has been observed in the *tk* or *pol* gene. While some mutations can be classified to contribute resistance, numerous amino-acid changes could not be assigned without doubt (Burrel et al., 2013; Sauerbrei et al., 2010a). For that reason, resistance mutations were induced in several studies by cultivating wild-type strains under increasing concentrations of an antiviral agent of choice (Andrei et al., 2005; Saijo et al., 2002; Suzutani et al., 2003). Nevertheless, the method of choice is the targeted introduction of single mutations with ambiguous significance found in clinical isolates. Until recently, the recombination methods for the targeted mutagenesis of herpesvirus genomes remained difficult and inconvenient, for instance due to the inefficient virus reconstitution after cosmid cotransfections or due to genetic instability of the progeny (Sergerie and Boivin, 2006).

Another popular strategy is the *in vitro* or *in vivo* production of recombinant proteins by an expression vector following enzymatic analysis (Bestman-Smith et al., 2001; Brunnemann et al., 2015; Frobert et al., 2005; Liu and Summers, 1988; Sauerbrei et al., 2013; Suzutani et al., 2000). Usually, the *tk* gene is cloned into a plasmid vector and modified by site-directed mutagenesis. Disadvantages are the need for radioactively labeled nucleosides or the use of bromodeoxyuridine as substrate instead of a certain antiviral to determine the TK activity. The definition of enzyme activity values that define a sensitive or resistance phenotype remains problematic. However, susceptibility testing of antivirals with recombinant TK proteins was successful in the TK-negative *Leishmania tarentolae* (Bestman-Smith et al., 2001). Such

approaches via the direct measurement of TK enzymatic activity are limited to TK itself and cannot include amino-acid changes in other genes and the interplay of different enzymes in developing resistance. The most authentic system represents the generation of replication-competent virus strains, which express the whole protein spectrum and pass through the entire infection and replication cycle.

Bacterial artificial chromosomes (BAC) with full-length wild-type herpesvirus genomes form a reliable tool to generate replication-competent recombinant virus strains with specific resistance mutations that can be used for phenotypic testing. The 'recombineering' technology was so far used to generate genomic insertions or deletions as well as for the sequential introduction of one or several point mutations. Recent studies used the BAC-cloned genome of HCMV to substitute the native *UL97* gene with a modified variant (Fischer et al., 2013; Martin et al., 2006). For instance, the *UL97* gene was transferred in combination with a kanamycin-cassette flanked by flippase (Flp) recombinase recognition target (*FRT*) sequences and with a cotransfected recombinase expression plasmid (Martin et al., 2006). Moreover, scar sequences (*FRT* sites) in close proximity of the gene of interest were left behind (Chou, 2010). In this thesis, the BACs used for HSV manipulation carry the vector pBeloBAC11 only a few bp downstream the *tk* gene. The vector is flanked by two *loxP* sites and provides the eukaryotic Cre expression cassette by itself. The transfection of permissive eukaryotic cells results in vector self-excision (Nagel et al., 2008; Nygårdas et al., 2013; Smith and Enquist, 2000) and, therefore, the reconstituted virus strains exhibit the short scar sequence of 34 bp. The localization downstream of the gene does obviously not impair the gene expression by disruption of potentially regulatory sequences. The VZV BAC in contrast, is self-repairing after only a few passage cycles due to the terminal genomic vector localization and its excision by internal recombination events or genome packaging (Wussow et al., 2009).

The *en passant* mutagenesis procedure was the method of choice for the generation of virus mutants in this thesis (Tischer et al., 2006) and was used for sequence insertions, sequence deletions, and nt substitutions. The advantage over all is the fast and reliable BAC manipulation without leaving any scar sequences behind. The first step of the modification strategy was the integration of a reporter gene to facilitate the monitoring of the infection status and to simplify the following CPE inhibition assay and the PRA. For both HSV genomes, the intergenic region of *UL55* and *UL56* was chosen that promised stable transgene expression (Nygårdas et al., 2013; Snijder et al., 2012). The reporter gene used for the current study was the expression cassette for EGFP that is stably and autonomously expressed due to the HTLV/EF-1 α hybrid promoter (Guo et al., 1996; Kim et al., 1990). The autonomous expression is advantageous in contrast to the monitoring of fluorescence-tagged

virus proteins which are regulated in replication phase-specific way. VZV was labeled by integrating the mRFP expression cassette between ORFs 17 and 18, which are reverse orientated with adjoining termination regions. Stable mRFP expression confirmed the suitability of the chosen integration site.

In this study, transfer constructs were generated which are appropriate for the introduction of many different nt polymorphisms for susceptibility testing. In addition, this strategy allows the introduction of different mutations in close proximity. Generally, the use of transfer constructs reduces the number of extended and expensive oligonucleotides but requires the site-directed mutagenesis procedure as an additional step. Prior to the use of a *tk* gene transfer construct, the native gene needs to be deleted from the BACs to guarantee the targeted sequence integration. *Tk* gene deletion and subsequent integration by the transfer plasmid were successfully achieved by *en passant* mutagenesis (Fig. 3.2 and 3.5). The use of a transfer construct was also previously reported (Chou, 2010) but a short scar sequence adjacent to the gene of interest was left behind.

Three of nine mutations with ambiguous significance that needed to be tested for VZV were directly inserted by the *en passant* mutagenesis procedure. The $\Delta 7-74$ mutation of the TK comprises the deletion of 204 nt which cannot be achieved by site-directed mutagenesis. Two additional nt needed be substituted individually in the *pol* gene of VZV. Both substitutions resulting in A955T and T237K were inserted directly by extended oligonucleotides since the construction of transfer plasmids for the *pol* gene is much more complicated due to the size of the gene. The same direct approach was successfully used to insert several mutations into the BAC-cloned HCMV genome alone or in combination (Drouot et al., 2013; Fischer et al., 2013). In general, this direct strategy is very fast and needs only few validation.

All the generated BACs were successfully confirmed by RFLP and sequence analysis. Virus paques were established after transfection into permissive Vero or MeWo cells upon virus reconstitution. The virus strains were cultivated over several passages to enable autonomous vector excision.

4.2 Suitable recombinant virus strains with expression of *tk* gene variants

Insertion of large foreign sequences can hamper virus replication. Therefore, short reporter genes were introduced to avoid packaging limitations. The EGFP cassette is 1.7 kb and the mRFP cassette is approximately 1.5 kb in size. This results in a genome size increase of 1.1% for HSV and 1.2% for VZV, respectively. Nevertheless, replication kinetics

were performed to confirm the applicability of these fluorescent virus strains. Impaired viral growth could falsify the outcomes of the susceptibility assays in comparison to fully replication-competent strains. The replication of each HSV and VZV recombinant was compared with its fluorescent counterpart and with the recombinant BAC-based wild-type virus. The HSV strains G61A and A118V (HSV-1) as well as Y53N and T131M (HSV-2) showed minor deviations most likely due to different starting inocula. Generally, the single mean values were located in similar levels; therefore, a normalization of these values did not seem necessary. Taken together, significant differences were not obtained for the HSV replication capacity. In contrast, VZV replication curves were normalized to the starting inoculum of ten PFU per ml since the inoculum doses showed a considerable divergence. The adjustment of a defined inoculum remains so far difficult since VZV is strictly cell-associated in culture. The results of the normalized curves indicated similar replication capacities of the VZV strains analyzed.

Furthermore, *tk* gene expression was examined. The viral TK is dispensable for replication in cell culture (Cremer et al., 1978; Darby et al., 1981; Halpern and Smiley, 1984; Zhang et al., 2010) and the replication capacity of TK-defective mutants is undistinguishable from the native wild-type strains. Moreover, a TK-deficient strain would pretend the resistant phenotype in presence of ACV. *Tk* gene transcription was shown for all HSV and VZV variants by RT-PCR. Positive signals for GAPDH and negative results for samples without reverse transcriptase treatment confirmed the integrity of cDNA synthesis from mRNA.

Furthermore, TK protein expression was confirmed by immunoblot analysis. The TK protein was detected at approximately 45 kDa for each HSV variant. The HSV-2 TK signals were less intensive than for HSV-1 probably due to the fact that the antibody was raised against an N-terminal peptide of HSV-1 TK (sc-28037, Santa Cruz Biotechnology, Inc.). Nevertheless, this antibody is also recommended for TK detection of HSV-2. VZV TK was not detected in the truncated variants with the amino-acid substitutions N334stop, A163stop, and Q303stop/A955T(Pol) since this antibody is raised against a C-terminal peptide (sc-17554, Santa Cruz Biotechnology, Inc.). The internally truncated variant Δ 7-74 exhibited a lower mass of approximately 25 kDa. The viral glycoproteins gD and gI were shown as viral load controls and detected at divergent masses due to variable glycosylation. The ubiquitous structure protein β -actin was detected for each sample as cellular control. Additionally, the TK proteins of each HSV and VZV variant were verified by immunofluorescence, even for the C-terminally truncated VZV mutants N334stop, A163stop, and Q303stop/A955T(Pol) although less intense. This antibody seems to be preferably useful for the native protein structure.

4.3 Unambiguous assignment of single amino-acid exchanges from clinical samples to the resistance phenotype

The different human pathogenic α -herpesviruses share consistent biological properties and are closely related on DNA sequence level (Minson et al., 2000). However, even within defined virus strains, pronounced unambiguous sequence variability was described (Buchman et al., 1980; Zell et al., 2011). Traditionally, genetic characterization was achieved by RFLP analysis (Chaney et al., 1983; Hayward et al., 1975; LaRussa et al., 1992; Quinlivan et al., 2002). Genotyping was improved by sequencing and both the *tk* and the *pol* genes were confirmed to be conserved among α -herpesviruses, however, with species- and strain-specific sequence divergence (Burrel et al., 2010).

Nevertheless, antiviral treatment by nucleoside analogs especially affects the respective *tk* gene products. In particular, a variety of gene polymorphisms were observed in virus isolates obtained from immunocompromised patients receiving prolonged and intensive antiviral therapy (Chibo et al., 2002; Danve-Szatanek et al., 2004; Frobert et al., 2014; Hill et al., 1991; Morfin et al., 2004; Sauerbrei et al., 2011a/b). Usually, the sequence alterations correlated with resistance against the administered antiviral drug. The most frequent alterations occurred in the *tk* gene (95%). ACV resistance can also result from TK-negative mutants with lost enzyme activity, from TK-low-producer mutants with reduced enzyme activity, or from *tk*-altered strains with reduced substrate specificity (Chibo et al., 2004; Gaudreau et al., 1998; Pottage and Kessler, 1995). The resistance is often caused by single-base insertions or deletions in G or C homopolymer stretches considered as 'hot spots' and resulting in frameshift mutations or premature stop codons leading to truncated proteins (Bestman-Smith et al., 2001; Boivin et al., 1994; Burrell et al., 2010; Gaudreau et al., 1998; Hill et al., 1991; Morfin et al., 2000; Piret and Boivin, 2014; Sasadeusz et al., 1997; Sauerbrei et al., 2011a; Talarico et al., 1993). Moreover, a variety of SNPs was observed particularly in conserved domains but also in non-conserved regions (Burrel et al. 2013; Burrel et al. 2010; Chibo et al., 2004; Sauerbrei et al., 2011a/b, 2016). The multiplicity of mutations hampers the unambiguous evaluation of SNPs for their contribution to the resistance phenotype. Some polymorphisms and amino-acid substitutions also appear in ACV-susceptible isolates and, thus, can be excluded from the resistance association.

4.3.1 HVS-1 TK polymorphisms and resistance mutations

Presumable natural polymorphisms in the HSV-1 TK were observed in several clinical isolates both resistant and susceptible to ACV with the following three examples: R41H (Bestman-Smith et al., 2001; Burrel et al., 2010; Chibo et al., 2004; Duan et al., 2009;

Sauerbrei et al., 2010a; van Velzen et al., 2013), S345P (Bohn et al., 2011; van der Beek et al., 2013a; van Velzen et al., 2013), and V348I (Chibo et al. 2004; Duan et al., 2009; Sauerbrei et al., 2012; Stránská et al., 2004b). In this study, these single amino-acid exchanges were introduced into the HSV-1 TK and tested in a CPE inhibition assay against ACV as well as by qPCR in presence or absence of ACV. The calculated EC_{50} s were similar to the EC_{50} of the susceptible HSV1(17⁺)Lox-derived reference HSV1-GFP. Furthermore, qPCR results demonstrated viral genome copy numbers comparable to HSV1-GFP at 35.2 μ M ACV indicating full susceptibility to ACV. The results are consistent with previous observations, although an R41H-containing mutant had been shown to be unable to phosphorylate ACV (van Velzen et al., 2013) and R41H had been described as a frequent substitution observed in resistant viruses (Schulte et al., 2010). However, genotyping of the *tk* sequence revealed a variety of other polymorphisms and R41H was only indirectly assessed relevant for resistance by excluding other amino-acid substitutions from a possible contribution to resistance (Schulte et al., 2010). In contrast, other authors concluded that the N-terminal 45 residues of the HSV-1 TK are not required for the catalytic activity of the enzyme (Halpern and Smiley, 1984). The overwhelming majority of natural polymorphisms are predominantly found outside active or conserved regions (Frobert et al., 2008; Sauerbrei et al., 2016).

The following substitutions R106H, A118V, L139, L298R (Sauerbrei et al., 2011a, 2012; Schmidt et al., 2015), and S276R (Bohn et al., 2011) with ambiguous significance that had been observed only in one isolate each, were chosen for the individual introduction into the HSV-1 TK. All these substitutions are located in non-conserved regions but were observed in isolates obtained from persistent infections of immunosuppressed patients (bone marrow, heart, and lung transplant recipients). The R106H substitution was found in combination with commonly occurring substitutions as well as with the deletion of three cytidines at the position 460-463, which most likely confer resistance. The substitutions A118V, L139V, and L298R could not clearly be attributed to a certain phenotype since A118V and L139V were found in combination with G200D and T287M, respectively, both located in conserved or active regions. The L298R substitution was observed in combination with commonly occurring substitutions in a non-viable HSV-1 strain with clinical resistance. Unfortunately, the corresponding *pol* gene could not be sequenced and the significance of L298R remained uncertain. Last, the novel S276R substitution could also not be attributed to a certain phenotype but the exchanges S276N and S276G (Chibo et al., 2004; Schmidt et al., 2015) at the same position were observed in presence of mutations known to confer resistance. All generated recombinant strains with the single mutations tested against ACV exhibited EC_{50}

values similar to the susceptible reference strain. Furthermore, the results of the qPCR displayed viral loads comparable to the susceptible reference at high ACV concentrations indicating that these mutations are natural polymorphism without conferring resistance.

Three additional amino-acid substitutions were inserted into the HSV-1 TK that had been observed in conserved or active regions of the enzyme. The K219T exchange was observed in one strain only and can be attributed to the conserved site 5 from residue 216 to 222 (Bohn et al., 2011). However, the corresponding isolate was tested sensitive against ACV. The obtained EC_{50} was similar to the susceptible reference while the qPCR results revealed slightly increased genome copy numbers as compared to the wild-type in presence of 35.2 μ M ACV. Other amino-acid substitutions in close proximity such as R216C (Gaudreau et al., 1998) or R220H (Duan et al., 2009) were reported to cause low TK activity levels in [14 C] thymidine or ACV conversion, respectively. Another single substitution P84L is located in the conserved site 2 comprising residues 83 to 88. This substitution was observed in the *tk* gene of an isolate from a cardiac transplant recipient (Sauerbrei et al., 2010a). The respective recombinant TK-modified strain exhibited an EC_{50} value exceeding the cutoff concentration that was calculated as five times the mean value of the HSV-1 control strain. The qPCR results confirmed this observation with a virus load exceeding the amount of wild-type genomes by more than one log step at a high ACV concentration. Furthermore, the P84L mutation was assessed in a TK functionality assay (Malartre et al., 2012) and the exchange of proline to serine at the same position (P84S) was observed in an ACV-resistant strain with low activities in ACV monophosphorylation (Saijo et al., 2002). Finally, the G61A substitution was found in one isolate only (Sauerbrei et al., 2010a). Surprisingly, this substitution was tested sensitive against several antivirals even though it is located in the ATP-binding site (residues 51 to 63) of the HSV-1 TK. In contrast, Liu and Summers (1988) reported that the exchange of glycine to valine at the same position (G61V) resulted in a loss of enzyme activity. In agreement with these data, the EC_{50} value of the mutated HSV-1 strain was approximately 35.2 μ M and qPCR revealed similar replication properties in presence and absence of ACV. The G61A mutation can therefore be clearly classified to confer resistance. An overview of the various substitution positions is depicted in Fig. 4.1.

The *Consulting Laboratory for HSV and VZV* (Konsiliarlabor) of Jena University Hospital tested the susceptibility of all mentioned HSV-1 TK variants in comparison to the reference strain against the antiviral drugs ACV, PCV, and BVDU (Brunnemann et al., submitted). A modified CPE inhibition assay was used to determine the cell viability with the tetrazolium salt WST-8. EC_{50} calculation was performed by linear regression analysis. These tests confirmed, that the single amino-acid substitutions R41H, R106H, A118V, L139V, K219T,

S276R, L298R, S345P, and V348I retained the sensitive phenotype against ACV and the other nucleoside analogs whereas G61A and P84L induced cross-resistance to PCV and BVDU.

The cross-resistance of ACV, PCV, and BVDU is likely due to the identical process to activate the antivirals but exceptions were observed in clinical practice when isolates were resistant against ACV but susceptible to PCV (Chiou et al., 1995). Moreover, different susceptibility profiles against ACV, PCV, BVDU, and GCV were examined after selecting a wild-type strain under BVDU in cell culture (Andrei et al., 2005). Non-synonymous alterations in the viral TK were correlated with certain degrees of resistance implying drug-specific TK mutations.

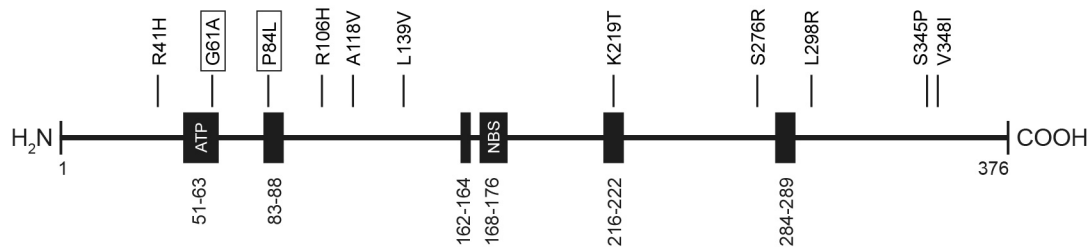

Fig. 4.1: Location of the individually introduced amino-acid substitutions in the TK of HSV-1. Conserved regions are shown by black boxes and the respective position at the protein sequence including the ATP-binding site (ATP) and the nucleotide-binding site (NBS). Amino-acid substitution conferring ACV resistance are shown in boxes.

4.3.2 HVS-2 TK polymorphisms and resistance mutations

HSV-2 isolates appear to be less variable with roughly 1.25% nt variability between the most distantly related isolates in comparison to HSV-1 with 2.3% variability (Burrell et al., 2010; Sakaoka et al., 1987a/b). Moreover, the average nt substitution frequency in the *UL23* gene was four-fold higher for HSV-1 compared with HSV-2 (Burrell et al., 2010; Chiba et al., 1998). An explanation for this observation remains difficult since a higher variability is commonly correlated with a higher GC content but HSV-2 exhibits a slightly more GC-rich genome exceeding the one of HSV-1 by 2.1% (Dolan et al., 1998). Even the *UL23* gene of HSV-2 has a higher GC-content with 68.8% compared to 64.8% of HSV-1, referring to the GenBank reference strain HG52 (HSV-2, GenBank no. NC_001798) and strain 17 (HSV-1, GenBank no. NC_001806) (Szpara et al., 2014). To date, most studies concern HSV-1 TK polymorphisms whereas amino-acid substitutions of HSV-2 TK have not been investigated extensively (Bohn et al., 2011; Burrell et al., 2013; Chibo et al., 2004). Most of the described resistance-associated mutations in HSV-2 TK are premature translation stops as a result

from insertions or deletions within homopolymer stretches of G's and C's (Bestman-Smith et al., 2001; Burrel et al., 2013; Gaudreau et al., 1998).

Only little information about SNP is provided by recent studies. The most frequent substitution G39E was observed in approximately 80% of isolates examined genotypically and partially tested sensitive to ACV (Bohn-Wippert et al., 2015; Burrel et al., 2010). This substitution is located outside of the conserved regions and does not lead to resistance against ACV with an EC_{50} situated below the cutoff. An exchange of a native glutamic acid residue with a glycine (E39G) was described at the same position and this was interpreted as a natural polymorphism or even an intrastrain variability (Bestman-Smith et al., 2001; Chibo et al., 2004). Other novel observed single amino-acid polymorphisms such as G150D, A157T, R428W, and L342W were tested to be susceptible against ACV and this was confirmed in this study. All of these amino-acid substitutions are located in non-conserved regions. Two additional so far undefined mutations T131M and Y133F, both located outside of conserved or active domains, were assessed in their contribution to resistance. T131M retained the susceptible phenotype. This substitution was observed in combination with the G39E exchange and several, as natural polymorphism defined substitutions in the viral *pol* gene (Bohn-Wippert et al., 2015; Müller et al., 2013). On the other hand, an amino-acid exchange at the same position of threonine with proline (T131P) was tested resistant to ACV and even resistant to GCV in the *Leishmania tarentolae* model (Bestman-Smith et al., 2001; Gaudreau et al. 1998). The Y133F substitution, albeit located in a non-conserved region, was defined to confer resistance against ACV (Sauerbrei et al., 2010b). However, the isolate with the Y133F substitution also exhibited the so far novel mutation Q34H in the viral *pol* gene. Here, the single TK substitution was shown to retain a susceptible phenotype against ACV suggesting that resistance of the isolate can be attributed to the *pol* mutation. All described HSV-2 TK substitutions up to here showed virus loads comparable to the susceptible reference strain at high ACV concentrations of 35.2 μ M confirming that these mutations are not associated with resistance.

Genotypic analysis of isolates obtained from patients with clinical resistance reveal sometimes an accumulation of different novel single amino-acid exchanges what hamper the unambiguous interpretation of each individual one. For example, one strain was isolated from a patient with recurrent herpes genitalis that exhibited the so far unknown substitutions G25A, Y53N, and R221H (Sauerbrei et al., 2010a). All three substitutions were individually introduced into the HSV2(MS)Lox BAC and viral strains were tested against ACV after reconstitution. Both substitutions Y53N and R221H conferred resistance to ACV with EC_{50} s exceeding the cutoff value. The Y53N substitution is located in the ATP-binding site (residues

51 to 63) and R221H in the conserved site 5 (residues 217 to 223). The results were confirmed by qPCR since the virus loads were similar in presence or absence of ACV (35.2 μM). According to these observations, substitutions in the close proximity (R220T, R220C, and R220K) were attributed to the resistance phenotype (Burrel et al., 2013; Chibo et al., 2004). In contrast, the G25A substitution, which is situated in a non-conserved region, retains susceptibility to ACV with an EC_{50} value similar to the reference strain. Taken together, *en passant* mutagenesis allowed to assess the three novel substitutions apart from each other leading to the unambiguous classification in contributing resistance or retaining susceptibility against ACV. The locations of the selected substitutions of HSV-2 TK are depicted in Fig. 4.2.

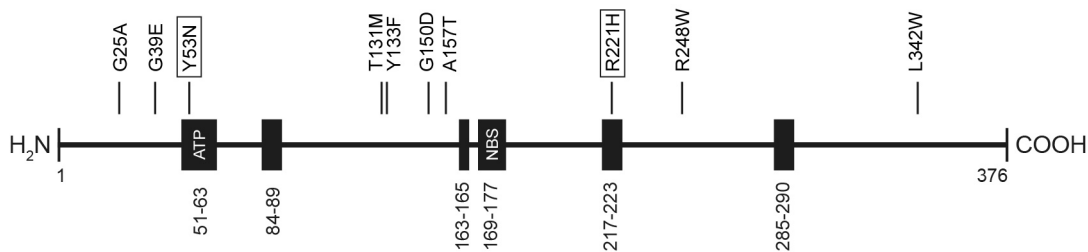

Fig. 4.2: Position of the selected amino-acid substitutions in the TK of HSV-2. Conserved regions are shown by black boxes and the respective position at the protein sequence including the ATP-binding site (ATP) and the nucleotide-binding site (NBS). Amino-acid substitution contributing resistance to ACV are framed in boxes.

Additional sequencing of the viral *pol* gene from HSV2(MS)Lox revealed the following amino-acid polymorphisms: A9T, P15S, and a deletion of glycine and aspartic acid at the position 680 and 681, that were described as natural polymorphisms (Bohn et al., 2011; Burrel et al., 2010; Chibo et al. 2004). Furthermore, the substitutions R318H and S514N were observed which had not been reported in the literature before but are located in non-conserved regions of the viral polymerase. Since the recombinant reference strain HSV2(MS)Lox revealed a susceptible phenotype against ACV, the contribution of the mentioned polymorphisms to resistance were considered irrelevant. Nevertheless, the results of the susceptibility assays of all HSV-2 TK variants have to be taken with caution, since the contribution or the synergistic effects to a resistance phenotype of additional polymorphisms remains unclear. Further studies absolutely require the study of individual *tk* and/or *pol* polymorphisms or mutations on a defined wild-type *pol* gene background in order to allow straight decisions on their role for resistance.

4.3.3 VZV TK polymorphisms and resistance mutations

In contrast to the HSV genomes, the VZV sequence variability differs less with 0.2% of protein-coding variation presumably due to the overall lower GC-content of 46% compared to HSV with 68% (Andrei et al., 2012; Szpara et al., 2014). According to these observations, amino-acid variations in the TK-coding *UL23*-homolog *ORF36* are rare (0.39%) and only a few known natural polymorphisms such as S179N or S288L are reported (Andrei et al., 2012; Morfin et al., 1999; Sauerbrei et al., 2011b). The assessment of SNP is therefore not hampered by a high diversity within the *tk* gene but rather by the difficulty to cultivate virus isolates from patient's specimen with success rates between 20% and 43% (Beards et al., 1998; Dlugosch et al., 1991). Obvious reasons for this failure are the strict cell-association of the virus in culture and the restricted choice of cell lines that can be used. Furthermore, the instability and the slow replication feature of the virus lead to a prolonged incubation times to obtain CPEs (Sauerbrei et al., 2011b). The ability to modify the VZV genome using BAC mutagenesis and to obtain replication-competent virus strains after reconstitution overcome this difficulty. By this way, a selection of the single amino-acid changes L73I, A163stop, W225R, T256M, N334stop, and Δ 7-74 was made and the corresponding nt alterations were introduced into the viral *tk* gene. The mutations were predominately observed in isolates obtained from immunosuppressed individuals suffering from persistent herpes zoster (Sauerbrei et al., 2011b). Conventional PRA was performed by counting red-fluorescent virus plaques at different ACV concentrations. All but one (L73I) amino-acid exchanges were confirmed to confer resistance against ACV.

Additional susceptibility assays were performed by the *Consulting Laboratory for HSV and VZV* of Jena University Hospital and confirmed the ACV phenotype and also showed cross-resistance against PCV and BVDU (Brunnemann et al., 2015) except for the L73I substitution that is localized in a non-conserved region. Interestingly, the W225R mutation was associated with resistance although it is localized outside of active or conserved domains. The amino-acid exchange T256M is located in a conserved protein domain and was once reported to confer resistance (Bleymehl et al., 2011). Two other nt substitutions resulted in C-terminally truncated proteins (A163stop and N334stop). The C-terminus of HSV-1 is required to maintain the TK activity (Saijo et al., 2002) probably due to its involvement in subunit dimerization (Brown et al., 1995), suggesting a similar impact of the C-terminus of the VZV TK. Another strain was observed with a large deletion (Δ 7-74) near the N-terminus involving both the ATP-binding site as well as the conserved site 2 obviously provoking resistance against nucleoside analogs. The positions of the targeted amino-acid mutations are depicted in Fig. 4.3.

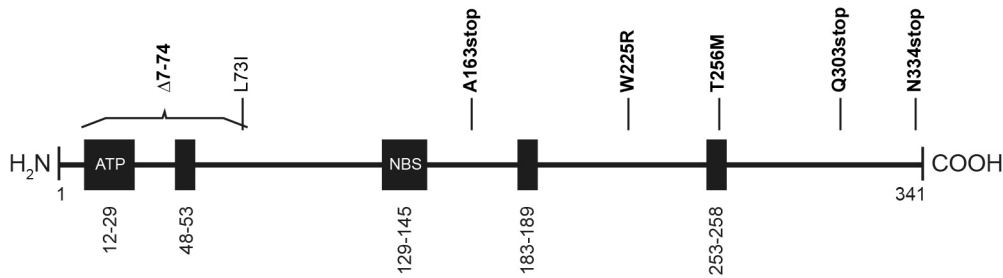

Fig. 4.3: Location of the selected amino-acid substitutions in the TK of VZV. Conserved regions are shown by black boxes and the respective position at the protein sequence including the ATP-binding site (ATP) and the nucleotide-binding site (NBS). Amino-acid substitution contributing resistance to ACV are in bold.

Two viral strains were identified with a novel individual substitution in the viral *pol* gene. Both substitutions T237K and A955T were directly and separately introduced into the *ORF28* gene using *en passant* mutagenesis. Susceptibility testing against ACV revealed no conversion from a sensitive to a resistant phenotype. Additionally, both strains were tested against PCV, BVDU, FOS, and CDV by the *Consulting Laboratory for HSV and VZV* of Jena University Hospital (Brunnemann et al., 2015) revealing susceptibility against all antivirals and, therefore, these exchanges are natural polymorphisms. Under clinical conditions, the A955T substitution was originally observed in combination with the Q303stop mutation in the viral TK. The latter was additionally introduced into the A955T mutant strain and also tested against the mentioned antivirals resulting in a broad cross-resistance against ACV, PCV, and BVDU. The Q303stop mutation was already described to potentially cause resistance against ACV (Fillet et al., 1998; Saint-Léger et al., 2001). Here, these results could be confirmed by the targeted introduction of individual missense mutations in a selected open reading frame.

4.4 Advantages and disadvantages of diagnostic methods for susceptibility testing

Susceptibility testing of several antiviral agents is usually performed with clinical isolates from patients with acute infections. Albeit TK activity is dispensable for viral replication in culture, TK-deficient strains are unable to reactivate from latent infections as it was shown in sensory ganglia of mice (Coen et al., 1989; Jacobson et al., 1993). The reactivation of the virus reflects the increased potential of genetic reversion and often a heterogenic mixture of viral subpopulations is obtained after isolation what complicates the selection of the resistance-associated strains. Furthermore, the isolation from clinical materials can result in selecting strains that are best adapted to cell culture whereas those with substantial alterations may remain unnoticed. In this study, a pure virus culture is obtained by transfection of DNA from a single molecular clone. After virus reconstitution, the resulting

strains were then tested by CPE inhibition assay or PRA and the effective concentration at 50% (EC_{50}) was calculated. However, this value obtained from individual defined cell culture settings is dependent on the design of the assay, for example the MOI, the tested range of drug concentrations, the choice of the marker for defining viral replication, or the readout time (Agut et al., 2009). All these experimental variabilities call for an international standardization for susceptibility testing and determination of EC_{50} values. The quantitation of virus DNA in infected cells, therefore, provides more reliable results for estimating the antiviral activity, since the administered drugs are direct inhibitors of the viral DNA synthesis. Real-time PCR represents a highly sensitive, accurate, and useful approach for diagnostics with shorter infection times in culture and reliable and precise results (Brunnemann et al., 2015; Stránská et al., 2002; Thi et al., 2006).

The implementation of *en passant* mutagenesis for the targeted introduction of single nt mutations or sequence deletions guaranteed the unambiguous identification of changes in the phenotypic profile by susceptibility testing of replication-competent virus strains *in vitro* against certain antiviral drugs. So far, since its introduction in the late 1980s, ACV or its derivatives remain the first-line drugs for prophylaxis and treatment of HSV infections, since there is no vaccine available until now. Especially the prolonged antiviral therapy of immunocompromised patients is of high concern with an increasing prevalence of resistance from 3.8% (between 2002-2006) to 15.7% (between 2007-2011) and even 14.3% to 46.5% (at the indicated time periods) for HSCT recipients (Frobert et al., 2014). Furthermore, HSCT recipients are more afflicted than solid organ transplant recipients (Burrel et al., 2013; Danve-Szatanek et al., 2004). New chemotherapy regimens, the increasing number of cancer patients, and improved protocols with longer and deeper immunosuppression, might be the reasons for rising numbers of patients who suffer from reactivating, persistent infections. The consequence of the preferred administration of ACV and other nucleoside analogs is viral resistance resulting from mutations in the *UL23/ORF36* gene reported in 95% of cases (reviewed in Piret and Boivin, 2011, 2014; Sauerbrei et al., 2016). The unambiguous identification of resistance-conferring mutations is hampered either by the high heterogeneity of the HSV *tk* gene or by the difficulty to isolate VZV strains for susceptibility testing in cell culture (reviewed in Piret and Boivin, 2011, 2014; Sauerbrei et al., 2011b). Moreover, HSV isolation from blood specimen or cerebrospinal fluid is problematic (Safrin et al., 1994). Some specific amino-acid residues in functional sites were identified to be essential to maintain the structural integrity of the TK (Kusmann-Gerber et al., 1998). The ATP-binding site is affected in 9.7% of cases followed by the conserved site 5 (residues 216 to 223) with 8.3% (Sauerbrei et al., 2016). Although most of the resistance-related mutations are situated in

active or conserved domains of the protein (Piret and Boivin, 2014), a considerable dimension of amino-acid polymorphisms is located outside these regions. Many of these exchanges could be identified as natural polymorphisms but the presence in these regions does not rule out their role in ACV resistance and there remains the possibility of a contribution to the generation of resistance in presence of other mutations. Furthermore, the interpretation of single amino-acid exchanges becomes a problem when mutations are found in the viral *tk* as well as in the viral *pol* gene. *En passant* mutagenesis overcomes these problems by enabling the insertion of desired mutations elsewhere in the viral genome what was additionally performed for the viral *pol* gene of VZV in this study.

The successful combination of genetic assays, recombinant virus production, and improved susceptibility testing provides useful and reliable means to characterize ambiguous mutations alone or in combination in every gene of interest against a desired antiherpetic drug. This strategy allows the clear distinction between resistance mutations and natural polymorphisms. A long-term goal for this study is the establishment of a robust and comprehensive database for both, resistance mutations and natural polymorphisms, for a given antiherpetic drug (Chevillotte et al., 2010; Sauerbrei et al., 2016). Such databases facilitate the surveillance of emerging mutations and the management of the antiviral therapy in immunocompromised patients.

5 REFERENCES

- Adler H, Messerle M, Wagner M, Koszinowski UH (2000) Cloning and mutagenesis of the murine gammaherpesvirus 68 genome as an infectious bacterial artificial chromosome. *J Virol* **74**:6964–6974.
- Adler H, Messerle M, Koszinowski UH (2003) Cloning of herpesviral genomes as bacterial artificial chromosomes. *Rev Med Virol* **13**:111-121.
- Agut H, Aubin JT, Ingrand D, Blanc S, Clayton AL, Chantler SM, Huraux JM (1990) Simplified test for detecting the resistance of herpes simplex virus to acyclovir. *J Med Virol* **31**:209-214.
- Agut H, Boutolleau D, Deback C, Bonnafous P, Gautheret-Dejean A (2009) Testing the susceptibility of human herpesviruses to antivirals. *Future Microbiol* **4**:1111-1123.
- André PM, Narbonne CH, Donnio PY, Ruffault A, Fauconnier B (1988) Evaluation of herpes simplex virus susceptibility to acyclovir using an enzyme-linked immunosorbent assay. *Ann Inst Pasteur Virol* **139**:185-195.
- Andrei G, Balzarini J, Fiten P, De Clercq E, Opdenakker G, Snoeck R (2005) Characterization of herpes simplex virus type 1 thymidine kinase mutants selected under a single round of high-dose brivudin. *J Virol* **79**:5863-5869.
- Andrei G, Topalis D, Fiten P, McGuigan C, Balzarini J, Opdenakker G, Snoeck R (2012) In vitro-selected drug-resistant varicella-zoster virus mutants in the thymidine kinase and DNA polymerase genes yield novel phenotype-genotype associations and highlight differences between antiherpesvirus drugs. *J Virol* **86**:2641-2652.
- Arvin AM (1996) Varicella-zoster virus. *Clin Microbiol Rev* **9**:361-381.
- Bacon TH, Levin MJ, Leary JJ, Sarisky RT, Sutton D (2003) Herpes simplex virus resistance to acyclovir and penciclovir after two decades of antiviral therapy. *Clin Microbiol Rev* **16**:114-128.
- Bae PK, Kim JH, Kim HS, Chung IK, Paik SG, Lee CK (2006) Intracellular uptake of thymidine and antiherpetic drugs for thymidine kinase-deficient mutants of herpes simplex virus type 1. *Antiviral Res* **70**:93-104.
- Baines JD, Pellett PE (2007) Genetic comparison of human alphaherpesvirus genomes. In: Arvin AM, Campadelli-Fiume G, Mocarski E, Moore P, Roizman B, Whitley R, Yamanishi K, editors. *Human Herpesviruses*. First edition; Cambridge University Press, Cambridge, England.
- Balasubramaniam NK, Veerisetty V, Gentry GA (1990) Herpesviral deoxythymidine kinases contain a site analogous to the phosphoryl-binding arginine-rich region of porcine adenylate kinase; comparison of secondary structure predictions and conservation. *J Gen Virol* **71**:2979-2987.
- Ball MJ, Lukiw WJ, Kammerman EM, Hill JM (2013) Intracerebral propagation of Alzheimer's disease: strengthening evidence of a herpes simplex virus etiology. *Alzheimers Dement* **9**:169-175.
- Beards G, Graham C, Pillay D (1998) Investigation of vesicular rashes for HSV and VZV by PCR. *J Med Virol* **54**:155-157.
- Belshe RB, Leone PA, Bernstein DI, Wald A, Levin MJ, Stapleton JT, Gorfinkel I, Morrow RL, Ewell MG, Stokes-Riner A, Dubin G, Heineman TC, Schulte JM, Deal CD; Herpevac Trial for Women (2012) Efficacy results of a trial of a herpes simplex vaccine. *N Engl J Med* **366**:34-43.
- Berman PW, Vogt PE, Gregory T, Lasky LA, Kern ER (1988) Efficacy of recombinant glycoprotein D subunit vaccines on the development of primary, recurrent, and latent genital infections with herpes simplex virus type 2 in guinea pigs. *J Infect Dis* **157**:897-902.
- Bernstein DI, Bellamy AR, Hook EW, Levin MJ, Wald A, Ewell MG, Wolff PA, Deal CD, Heineman TC, Dubin G, Belshe RB (2013) Epidemiology, clinical presentation, and antibody response to primary infection with herpes simplex virus type 1 and type 2 in young women. *Clin Infect Dis* **56**:344-351.

-
- Bestman-Smith J, Schmit I, Papadopoulou B, Boivin G (2001) Highly reliable heterologous system for evaluating resistance of clinical herpes simplex virus isolates to nucleoside analogues. *J Virol* **75**:3105-3110.
- Birnboim HC, Doly J (1979) A rapid alkaline extraction procedure for screening recombinant plasmid DNA. *Nucleic Acids Res* **7**:1513-1523.
- Bleymehl K, Cinatl J, Schmidt-Chanasit J (2011) Phenotypic and genetic characterization of varicella-zoster virus mutants resistant to acyclovir, brivudine and/or foscarnet. *Med Microbiol Immunol* **200**:193-202.
- Bohn K, Zell R, Schacke M, Wutzler P, Sauerbrei A (2011) Gene polymorphism of thymidine kinase and DNA polymerase in clinical strains of herpes simplex virus. *Antivir Ther* **16**:989-997.
- Bohn-Wippert K, Schmidt S, Runtze A, Zell R, Sauerbrei A (2015) Resistance testing of clinical herpes simplex virus type 2 isolates collected over 4 decades. *Int J Med Microbiol* **305**:644-651.
- Boivin G, Edelman CK, Pedneault L, Talarico CL, Biron KK, Balfour HH Jr (1994) Phenotypic and genotypic characterization of acyclovir-resistant varicella-zoster viruses isolated from persons with AIDS. *J Infect Dis* **170**:68-75.
- Borenstein R, Frenkel N (2009) Cloning human herpes virus 6A genome into bacterial artificial chromosomes and study of DNA replication intermediates. *Proc Natl Acad Sci USA* **106**:19138-19143.
- Borst EM, Hahn G, Koszinowski UH, Messerle M (1999) Cloning of the human cytomegalovirus (HCMV) genome as an infectious bacterial artificial chromosome in *Escherichia coli*: a new approach for construction of HCMV mutants. *J Virol* **73**:8320-8329.
- Bradley H, Markowitz LE, Gibson T, McQuillan GM (2014) Seroprevalence of herpes simplex virus types 1 and 2--United States, 1999-2010. *J Infect Dis* **209**:325-333.
- Brady RC, Bernstein DI (2004) Treatment of herpes simplex virus infections. *Antiviral Res* **61**:73-81.
- Brisson M, Edmunds WJ, Law B, Gay NJ, Walld R, Brownell M, Roos LL, De Serres G (2001) Epidemiology of varicella zoster virus infection in Canada and the United Kingdom. *Epidemiol Infect* **127**:305-314.
- Brown DG, Visse R, Sandhu G, Davies A, Rizkallah PJ, Melitz C, Summers WC, Sanderson MR (1995) Crystal structures of the thymidine kinase from herpes simplex virus type-1 in complex with deoxythymidine and ganciclovir. *Nat Struct Biol* **2**: 876-881.
- Brown ZA, Wald A, Morrow RA, Selke S, Zeh J, Corey L (2003) Effect of serologic status and cesarean delivery on transmission rates of herpes simplex virus from mother to infant. *JAMA* **289**:203-209.
- Brune W, Messerle M, Koszinowski UH (2000) Forward with BACs: new tools for herpesvirus genomics. *Trends Genet* **16**:254-259.
- Brunnemann AK, Bohn-Wippert K, Zell R, Henke A, Walther M, Braum O, Maschkowitz G, Fickenscher H, Sauerbrei A, Krumbholz A (2015) Drug resistance of clinical varicella-zoster virus strains confirmed by recombinant thymidine kinase expression and by targeted resistance mutagenesis of a cloned wild-type isolate. *Antimicrob Agents Chemother* **59**:2726-2734.
- Buchman TG, Simpson T, Nosal C, Roizman B, Nahmias AJ (1980) The structure of herpes simplex virus DNA and its application to molecular epidemiology. *Ann NY Acad Sci* **354**:279-290.
- Burrel S, Aime C, Hermet L, Ait-Arkoub Z, Agut H, Boutolleau D (2013) Surveillance of herpes simplex virus resistance to antivirals: a 4-year survey. *Antiviral Res* **100**:365-372.
- Burrel S, Deback C, Agut H, Boutolleau D (2010) Genotypic characterization of UL23 thymidine kinase and UL30 DNA polymerase of clinical isolates of herpes simplex virus: natural polymorphism and mutations associated with resistance to antivirals. *Antimicrob Agents Chemother* **54**:4833-4842.
-

- Campbell RE, Tour O, Palmer AE, Steinbach PA, Baird GS, Zacharias DA, Tsien RY (2002) A monomeric red fluorescent protein. Proc Natl Acad Sci USA **99**:7877-7882.
- Celum C, Wald A, Lingappa JR, Magaret AS, Wang RS, Mugo N, Mujugira A, Baeten JM, Mullins JI, Hughes JP, Bukusi EA, Cohen CR, Katabira E, Ronald A, Kiarie J, Farquhar C, Stewart GJ, Makhema J, Essex M, Were E, Fife KH, de Bruyn G, Gray GE, McIntyre JA, Manongi R, Kapiga S, Coetzee D, Allen S, Inambao M, Kayitenkore K, Karita E, Kanweka W, Delany S, Rees H, Vwalika B, Stevens W, Campbell MS, Thomas KK, Coombs RW, Morrow R, Whittington WL, McElrath MJ, Barnes L, Ridzon R, Corey L; Partners in Prevention HSV/HIV Transmission Study Team (2010) Acyclovir and transmission of HIV-1 from persons infected with HIV-1 and HSV-2. N Engl J Med **362**:427-439.
- Chaney SM, Warren KG, Kettlys J, Zbitnue A, Subak-Sharpe JH (1983) A comparative analysis of restriction enzyme digests of the DNA of herpes simplex virus isolated from genital and facial lesions. J Gen Virol **64**:357-371.
- Chaves SS, Lopez AS, Watson TL, Civen R, Watson B, Mascola L, Seward JF (2011) Varicella in infants after implementation of the US varicella vaccination program. Pediatrics **128**:1071-1077.
- Chevillotte M, Ersing I, Mertens T, von Einem J (2010) Differentiation between polymorphisms and resistance-associated mutations in human cytomegalovirus DNA polymerase. Antimicrob Agents Chemother **54**:5004-5011.
- Chiba A, Suzutani T, Saijo M, Koyano S, Azuma M (1998) Analysis of nucleotide sequence variations in herpes simplex virus types 1 and 2, and varicella-zoster virus. Acta Virol **42**:401-407.
- Chibo D, Druce J, Sasadeusz J, Birch C (2004) Molecular analysis of clinical isolates of acyclovir resistant herpes simplex virus. Antiviral Res **61**:83-91.
- Chibo D, Mijch A, Doherty R, Birch C (2002) Novel mutations in the thymidine kinase and DNA polymerase genes of acyclovir and foscarnet resistant herpes simplex viruses infecting an immunocompromised patient. J Clin Virol **25**:165-170.
- Chiou HC, Kumura K, Hu A, Kerns KM, Coen DM (1995) Penciclovir-resistance mutations in the herpes simplex virus DNA polymerase gene. Antiviral Chem. Chemother **6**: 281–288.
- Chono K, Katsumata K, Kontani T, Kobayashi M, Sudo K, Yokota T, Konno K, Shimizu Y, Suzuki H (2010) ASP2151, a novel helicase-primase inhibitor, possesses antiviral activity against varicella-zoster virus and herpes simplex virus types 1 and 2. J Antimicrob Chemother **65**:1733-1741.
- Chou S (2010) Recombinant phenotyping of cytomegalovirus UL97 kinase sequence variants for ganciclovir resistance. Antimicrob Agents Chemother **54**:2371-8.
- Chrisp P, Clissold SP (1991) Foscarnet. A review of its antiviral activity, pharmacokinetic properties and therapeutic use in immunocompromised patients with cytomegalovirus retinitis. Drugs **41**:104-129.
- Coen DM, Kosz-Vnenchak M, Jacobson JG, Leib DA, Bogard CL, Schaffer PA, Tyler KL, Knipe DM (1989) Thymidine kinase-negative herpes simplex virus mutants establish latency in mouse trigeminal ganglia but do not reactivate. Proc Natl Acad Sci USA **86**:4736-4740.
- Cohen JI, Straus SE, Arvin AM (2007). Varicella-Zoster Virus Replication, Pathogenesis, and Management. In: Knipe DM, Howley PM, editors. *Fields Virology*. Fifth edition; Lippincott Williams & Wilki, Philadelphia, PA, USA.
- Corey L (1990). Genital herpes. In: Homes KK, Mardh PA, Sparling FP, Wiesner PJ, Cates WC, Lemon SM, editors. *Sexually transmitted diseases*. Second edition; McGraw Hill, New York, USA.
- Corey L, Adamsm HG, Brown ZA, Holmes KK (1983) Genital herpes simplex virus infections: clinical manifestations, course, and complications. Ann Intern Med **98**:958-972.
- Corey L, Spear PG (1986) Infections with herpes simplex viruses. N Engl J Med **314**:686-691.

-
- Court DL, Sawitzke JA, Thomason LC (2002) Genetic engineering using homologous recombination. *Annu Rev Genet* **36**:361-388.
- Cremer KJ, Summers WP, Summers WC (1978) The thymidine kinase gene of herpes simplex virus type 1: cell-free protein synthesis and substrate specificity studies. *IARC Sci Publ* **24**:337-345.
- Crumpacker CS, Schnipper LE, Zaia JA, Levin MJ (1979) Growth inhibition by acycloguanosine of herpesviruses isolated from human infections. *Antimicrob Agents Chemother* **15**:642-645.
- Danve-Szatanek C, Aymard M, Thouvenot D, Morfin F, Agius G, Bertin I, Billaudel S, Chanzy B, Coste-Burel M, Finkielsztejn L, Fleury H, Hadou T, Henquell C, Lafeuille H, Lafon ME, Le Faou A, Legrand MC, Maille L, Mengelle C, Morand P, Morinet F, Nicand E, Omar S, Picard B, Pozzetto B, Puel J, Raoult D, Scieux C, Segondy M, Seigneurin JM, Teyssou R, Zandotti C (2004) Surveillance network for herpes simplex virus resistance to antiviral drugs: 3-year follow-up. *J Clin Microbiol* **42**:242-249.
- Darby G, Field HJ, Salisbury SA (1981) Altered substrate specificity of herpes simplex virus thymidine kinase confers acyclovir-resistance. *Nature* **289**:81-83.
- Davison AJ (1984) Structure of the genome termini of varicella-zoster virus. *J Gen Virol* **65**:1969-1977.
- Davison AJ, Scott JE (1986) The complete DNA sequence of varicella-zoster virus. *J Gen Virol* **67**:1759-1816.
- Delecluse HJ, Hilsendegen T, Pich D, Zeidler R, Hammerschmidt W (1998) Propagation and recovery of intact, infectious Epstein-Barr virus from prokaryotic to human cells. *Proc Natl Acad Sci USA* **95**:8245-8250.
- Delecluse HJ, Kost M, Feederle R, Wilson L, Hammerschmidt W (2001) Spontaneous activation of the lytic cycle in cells infected with a recombinant Kaposi's sarcoma-associated virus. *J Virol* **75**:2921-2928.
- Dlugosch D, Eis-Hübinger AM, Kleim JP, Kaiser R, Bierhoff E, Schneeweis KE (1991) Diagnosis of acute and latent varicella-zoster virus infections using the polymerase chain reaction. *J Med Virol* **35**:136-141.
- Dolan A, Jamieson FE, Cunningham C, Barnett BC, McGeoch DJ (1998) The genome sequence of herpes simplex virus type 2. *J Virol* **72**:2010-2021.
- Drake S, Taylor S, Brown D, Pillay D (2000) Improving the care of patients with genital herpes. *BMJ* **321**:619-623.
- Drouot E, Piret J, Boivin G (2013) Novel method based on "en passant" mutagenesis coupled with a gaussia luciferase reporter assay for studying the combined effects of human cytomegalovirus mutations. *J Clin Microbiol* **51**:3216-3224.
- Duan R, de Vries RD, van Dun JM, van Loenen FB, Osterhaus AD, Remeijer L, Verjans GM (2009) Acyclovir susceptibility and genetic characteristics of sequential herpes simplex virus type 1 corneal isolates from patients with recurrent herpetic keratitis. *J Infect Dis* **200**:1402-1414.
- Elion GB, (1982) Mechanism of action and selectivity of acyclovir. *Am J Med* **73**:7-13.
- Elion GB, Furman PA, Fyfe JA, de Miranda P, Beauchamp L, Schaeffer HJ (1999) The selectivity of action of an antiherpetic agent, 9-(2-hydroxyethoxymethyl) guanine. Reproduced from Proc Natl Acad Sci USA 74, 5716-5720 (1977). *Rev Med Virol* **9**:147-52.
- Fairley CK, Miller E (1996) Varicella-zoster virus epidemiology--a changing scene? *J Infect Dis* **174** Suppl 3:314-319.
- Fatahzadeh M, Schwartz RA (2007) Human herpes simplex virus infections: epidemiology, pathogenesis, symptomatology, diagnosis, and management. *J Am Acad Dermatol* **57**: 737-763.
- Field HJ, Biswas S (2011) Antiviral drug resistance and helicase-primase inhibitors of herpes simplex virus. *Drug Resist Updat* **14**:45-51.
-

- Fillet AM, Dumont B, Caumes E, Visse B, Agut H, Bricaire F, Huraux JM (1998) Acyclovir-resistant varicella-zoster virus: phenotypic and genetic characterization. *J Med Virol* **55**:250-254.
- Fischer L, Laib Sampaio K, Jahn G, Hamprecht K, Göhring K (2013) Generation and characterization of a GCV resistant HCMV UL97-mutation and a drug sensitive UL54-mutation. *Antiviral Res* **100**:575-577.
- Freeman EE, Weiss HA, Glynn JR, Cross PL, Whitworth JA, Hayes RJ (2006) Herpes simplex virus 2 infection increases HIV acquisition in men and women: systematic review and meta-analysis of longitudinal studies. *AIDS* **20**: 73-83.
- Frobert E, Burrel S, Ducastelle-Lepretre S, Billaud G, Ader F, Casalegno JS, Nave V, Boutolleau D, Michallet M, Lina B, Morfin F (2014) Resistance of herpes simplex viruses to acyclovir: an update from a ten-year survey in France. *Antiviral Res* **111**:36-41.
- Frobert E, Cortay JC, Ooka T, Najjoulah F, Thouvenot D, Lina B, Morfin F (2008) Genotypic detection of acyclovir-resistant HSV-1: characterization of 67 ACV-sensitive and 14 ACV-resistant viruses. *Antiviral Res* **79**:28-36.
- Frobert E, Ooka T, Cortay JC, Lina B, Thouvenot D, Morfin F (2005) Herpes simplex virus thymidine kinase mutations associated with resistance to acyclovir: a site-directed mutagenesis study. *Antimicrob Agents Chemother* **49**:1055-1059.
- Gaudreau A, Hill E, Balfour HH Jr, Erice A, Boivin G (1998) Phenotypic and genotypic characterization of acyclovir-resistant herpes simplex viruses from immunocompromised patients. *J Infect Dis* **178**:297-303.
- Gershon AA, Steinberg SP, LaRussa P, Ferrara A, Hammerschlag M, Gelb L (1988) Immunization of healthy adults with live attenuated varicella vaccine. *J Infect Dis* **158**:132-137.
- Gierasch WW, Zimmerman DL, Ward SL, Vanheyningen TK, Romine JD, Leib DA (2006) Construction and characterization of bacterial artificial chromosomes containing HSV-1 strains 17 and KOS. *J Virol Methods* **135**:197-206.
- Gilbert M, Li X, Petric M, Kraiden M, Isaac-Renton JL, Ogilvie G, Rekart ML (2011) Using centralized laboratory data to monitor trends in herpes simplex virus type 1 and 2 infection in British Columbia and the changing etiology of genital herpes. *Can J Public Health* **102**:225-229.
- Gnann JW, Sköldenberg B, Hart J, Aurelius E, Schliamser S, Studahl M, Eriksson BM, Hanley D, Aoki F, Jackson AC, Griffiths P, Miedzinski L, Hanfelt-Goade D, Hinthorn D, Ahlm C, Aksamit A, Cruz-Flores S, Dale I, Cloud G, Jester P, Whitley RJ; National Institute of Allergy and Infectious Diseases Collaborative Antiviral Study Group (2015) Herpes simplex encephalitis: lack of clinical benefit of long-term valacyclovir therapy. *Clin Infect Dis* **61**:683-691.
- Goulleret N, Mauvisseau E, Essevoz-Roulet M, Quinlivan M, Breuer J (2010) Safety profile of live varicella virus vaccine (Oka/Merck): five-year results of the European Varicella Zoster Virus Identification Program (EU VZVIP). *Vaccine* **28**:5878-5882.
- Guo ZS, Wang LH, Eisensmith RC, Woo SL (1996) Evaluation of promoter strength for hepatic gene expression in vivo following adenovirus-mediated gene transfer. *Gene Ther* **3**:802-810.
- Hahn G, Khan H, Baldanti F, Koszinowski UH, Revello MG, Gerna G (2002) The human cytomegalovirus ribonucleotide reductase homolog UL45 is dispensable for growth in endothelial cells, as determined by a BAC-cloned clinical isolate of human cytomegalovirus with preserved wild-type characteristics. *J Virol* **76**:9551-9555.
- Halpern ME, Smiley JR (1984) Effects of deletions on expression of the herpes simplex virus thymidine kinase gene from the intact viral genome: the amino terminus of the enzyme is dispensable for catalytic activity. *J Virol* **50**:733-738.
- Hartmann B, Czock D, Keller F (2010) Drug therapy in patients with chronic renal failure. *Dtsch Arztebl Int* **107**:647-55.

- Hawrami K, Breuer J (1999) Development of a fluorogenic polymerase chain reaction assay (TaqMan) for the detection and quantitation of varicella zoster virus. *J Virol Methods* **79**:33-40.
- Hayward AR, Irwin MR, Kyriakides TC, Chan CY, Chan IS, Wang WW, Annunziato PW, Silber JL; Shingles Prevention Study Group (2005) A vaccine to prevent herpes zoster and postherpetic neuralgia in older adults. *N Engl J Med* **352**:2271-2284.
- Hayward GS, Frenkel N, Roizman B (1975) Anatomy of herpes simplex virus DNA: strain differences and heterogeneity in the locations of restriction endonuclease cleavage sites. *Proc Natl Acad Sci USA* **72**:1768-1772.
- Hayward GS, Jacob RJ, Wadsworth SC, Roizman B (1975) Anatomy of herpes simplex virus DNA: evidence for four populations of molecules that differ in the relative orientations of their long and short components. *Proc Natl Acad Sci USA* **72**:4243-4247.
- Herget GW, Riede UN, Schmitt-Gräff A, Lübbert M, Neumann-Haefelin D, Köhler G (2005) Generalized herpes simplex virus infection in an immunocompromised patient--report of a case and review of the literature. *Pathol Res Pract* **201**:123-129.
- Hill EL, Hunter GA, Ellis MN (1991) In vitro and in vivo characterization of herpes simplex virus clinical isolates recovered from patients infected with human immunodeficiency virus. *Antimicrob Agents Chemother* **35**:2322-8.
- Horsburgh BC, Hubinette MM, Qiang D, MacDonald ML, Tufaro F (1999) Allele replacement: an application that permits rapid manipulation of herpes simplex virus type 1 genomes. *Gene Ther* **6**(5):922-30.
- Hoshino Y, Pesnicak L, Dowdell KC, Lacayo J, Dudek T, Knipe DM, Straus SE, Cohen JI (2008) Comparison of immunogenicity and protective efficacy of genital herpes vaccine candidates herpes simplex virus 2 dl5-29 and dl5-29-41L in mice and guinea pigs. *Vaccine* **26**:4034-4040.
- Hussin A, Md Nor NS, Ibrahim N (2013) Phenotypic and genotypic characterization of induced acyclovir-resistant clinical isolates of herpes simplex virus type 1. *Antiviral Res* **100**:306-313.
- Hwang YT, Liu BY, Coen DM, Hwang CB (1997) Effects of mutations in the Exo III motif of the herpes simplex virus DNA polymerase gene on enzyme activities, viral replication, and replication fidelity. *J Virol* **71**:7791-7798.
- Jacobson JG, Ruffner KL, Kosz-Vnenchak M, Hwang CB, Wobbe KK, Knipe DM, Coen DM (1993) Herpes simplex virus thymidine kinase and specific stages of latency in murine trigeminal ganglia. *J Virol* **67**:6903-6908.
- Jarvest RL, Sutton D, Vere Hodge RA (1998) Famciclovir. Discovery and development of a novel antiherpesvirus agent. *Pharm Biotechnol* **11**:313-343.
- Kanra G, Tezcan S, Badur S; Turkish National Study Team (2002) Varicella seroprevalence in a random sample of the Turkish population. *Vaccine* **20**:1425-1428.
- Kessler HH, Mühlbauer G, Rinner B, Stelzl E, Berger A, Dörr HW, Santner B, Marth E, Rabenau H, (2000) Detection of herpes simplex virus DNA by real-time PCR. *J Clin Microbiol* **38**:2638-2642.
- Kilgore PE, Kruszon-Moran D, Seward JF, Jumaan A, Van Loon FP, Forghani B, McQuillan GM, Wharton M, Fehrs LJ, Cossen CK, Hadler SC (2003) Varicella in Americans from NHANES III: implications for control through routine immunization. *J Med Virol* **70** Suppl 1:S111-8.
- Kim DW, Uetsuki T, Kaziro Y, Yamaguchi N, Sugano S (1990) Use of the human elongation factor 1 alpha promoter as a versatile and efficient expression system. *Gene* **91**:217-223.
- Kimberlin DW, Lin CY, Jacobs RF, Powell DA, Corey L, Gruber WC, Rathore M, Bradley JS, Diaz PS, Kumar M, Arvin AM, Gutierrez K, Shelton M, Weiner LB, Sleasman JW, de Sierra TM, Weller S, Soong SJ, Kiell J, Lakeman FD, Whitley RJ; National Institute of Allergy and Infectious Diseases Collaborative Antiviral Study Group (2001) Safety and efficacy of high-dose intravenous acyclovir in the management of neonatal herpes simplex virus infections. *Pediatrics* **108**(2):230-238.

- Kleymann G, Fischer R, Betz UA, Hendrix M, Bender W, Schneider U, Handke G, Eckenberg P, Hewlett G, Pevzner V, Baumeister J, Weber O, Henninger K, Keldenich J, Jensen A, Kolb J, Bach U, Popp A, Mäben J, Frappa I, Haebich D, Lockhoff O, Rübsamen-Waigmann H (2002) New helicase-primase inhibitors as drug candidates for the treatment of herpes simplex disease. *Nat Med* **8**:392-398.
- Korovina AN, Gus'kova AA, Skoblov M, Andronova VL, Galegov GA, Kochetkov SN, Kukhanova MK, Skoblov IS (2010) Analysis of mutations in DNA polymerase and thymidine kinase genes of herpes simplex virus clinical isolates resistant to antiherpetic drugs. *Mol Biol (Mosk)* **44**:488-496.
- Kussmann-Gerber S, Kuonen O, Folkers G, Pilger BD, Scapozza L (1998) Drug resistance of herpes simplex virus type 1--structural considerations at the molecular level of the thymidine kinase. *Eur J Biochem* **255**:472-481.
- Larder BA, Kemp SD, Darby G (1987) Related functional domains in virus DNA polymerases. *EMBO J* **6**:169-175.
- LaRussa P, Lungu O, Hardy I, Gershon A, Steinberg SP, Silverstein S (1992) Restriction fragment length polymorphism of polymerase chain reaction products from vaccine and wild-type varicella-zoster virus isolates. *J Virol* **66**:1016-1020.
- Lee EC, Yu D, Martinez de Velasco J, Tessarollo L, Swing DA, Court DL, Jenkins NA, Copeland NG (2001) A highly efficient Escherichia coli-based chromosome engineering system adapted for recombinogenic targeting and subcloning of BAC DNA. *Genomics* **73**:56-65.
- Liu QY, Summers WC (1988) Site-directed mutagenesis of a nucleotide-binding domain in HSV-1 thymidine kinase: effects on catalytic activity. *Virology* **63**:638-642.
- Lopez-Medina E, Cantey JB, Sánchez PJ (2015) The mortality of neonatal herpes simplex virus infection. *J Pediatr* **166**:1529-1532.
- Lynch, DP (2000). Oral viral infections. *Clin Dermatol* **18**(5):619-628.
- Mahamud A, Marin M, Nickell SP, Shoemaker T, Zhang JX, Bialek SR (2012) Herpes zoster-related deaths in the United States: validity of death certificates and mortality rates, 1979-2007. *Clin Infect Dis* **55**(7):960-966.
- Malartre N, Bouliou R, Falah N, Cortay JC, Lina B, Morfin F, Frobert E (2012) Effects of mutations on herpes simplex virus 1 thymidine kinase functionality: an in vitro assay based on detection of monophosphate forms of acyclovir and thymidine using HPLC/DAD. *Antiviral Res* **95**(3):224-228.
- Martin M, Gilbert C, Covington E, Boivin G (2006) Characterization of human cytomegalovirus (HCMV) UL97 mutations found in a valganciclovir/oral ganciclovir prophylactic trial by use of a bacterial artificial chromosome containing the HCMV genome. *J Infect Dis* **194**(5):579-583.
- Massengill JS, Kittredge JL (2014) Practical considerations in the pharmacological treatment of postherpetic neuralgia for the primary care provider. *J Pain Res* **7**:125-132.
- McGeoch DJ, Dalrymple MA, Davison AJ, Dolan A, Frame MC, McNab D, Perry LJ, Scott JE, Taylor P (1988) The complete DNA sequence of the long unique region in the genome of herpes simplex virus type 1. *J Gen Virol* **69**:1531-1574.
- McNamara J, Murray TA (2016) Connections between herpes simplex virus type 1 and Alzheimer's disease pathogenesis. *Curr Alzheimer Res* [Epub ahead of print]
- Meseda CA, Schmeisser F, Pedersen R, Woerner A, Weir JP (2004) DNA immunization with a herpes simplex virus 2 bacterial artificial chromosome. *Virology* **318**:420-428.
- Messerle M, Crnkovic I, Hammerschmidt W, Ziegler H, Koszinowski UH (1997) Cloning and mutagenesis of a herpesvirus genome as an infectious bacterial artificial chromosome. *Proc Natl Acad Sci USA* **94**:14759-14763.

- Michie CA, Acolet D, Charlton R, Stevens JP, Happerfield LC, Bobrow LG, Kangro H, Gau G, Modi N (1992) Varicella-zoster contracted in the second trimester of pregnancy. *Pediatr Infect Dis J* **11**:1050-1053.
- Miller CS, Danaher RJ, Jacob RJ (1998) Molecular aspects of herpes simplex virus I latency, reactivation, and recurrence. *Crit Rev Oral Biol Med* **9**:541-562.
- Minson AC, Davison A, Eberle R, Desrosiers RC, Fleckenstein B, McGeoch DJ, Pellett PE, Roizman B, Studdert MJ (2000) Family Herpesviridae. In: Van Regenmortel MHV, Fauquet CM, Bishop DHL, Carstens EB, Estes MK, Lemon SM, Maniloff J, Mayo MA, McGeoch DJ, Pringle CR, Wickner RB, editors. *Virus Taxonomy: Classification and Nomenclature of Viruses*. Seventh Report of the International Committee on Taxonomy of Viruses. Academic Press, Cambridge, MA, USA.
- Mohan RP, Verma S, Singh U, Agarwal N (2013) Acute primary herpetic gingivostomatitis. *BMJ Case Rep*
- Monavari SH, Mirzaei Parsa MJ, Bolouri B, Ebrahimi SA, Ataei-Pirkooh A (2014) The inhibitory effect of Acyclovir loaded nano-niosomes against herpes simplex virus type-1 in cell culture. *Med J Islam Repub Iran* **17**;28:99.
- Morfin F, Bilger K, Boucher A, Thiebaut A, Najjoulah F, Bleyzac N, Raus N, Bosshard S, Aymard M, Michallet M, Thouvenot D (2004) HSV excretion after bone marrow transplantation: a 4-year survey. *J Clin Virol* **30**:341-5.
- Morfin F, Souillet G, Bilger K, Ooka T, Aymard M, Thouvenot D (2000) Genetic characterization of thymidine kinase from acyclovir-resistant and -susceptible herpes simplex virus type 1 isolated from bone marrow transplant recipients. *J Infect Dis* **182**:290-293.
- Morfin F, Thouvenot D (2003) Herpes simplex virus resistance to antiviral drugs. *J Clin Virol* **26**:29-37.
- Morfin F, Thouvenot D, De Turenne-Tessier M, Lina B, Aymard M, Ooka T (1999) Phenotypic and genetic characterization of thymidine kinase from clinical strains of varicella-zoster virus resistant to acyclovir. *Antimicrob Agents Chemother* **43**:2412-2416.
- Müller EE, Magooa MP, Lewis DA (2013) Genetic characterization of herpes simplex virus type 2 UL23 thymidine kinase in Johannesburg, South Africa. *J Antivir Antiretrovir* **5**:080-084.
- Mustafa MB, Arduino PG, Porter SR (2009) Varicella zoster virus: review of its management. *J Oral Pathol Med* **38**:673-688.
- Naesens L, De Clercq E (2001) Recent developments in herpesvirus therapy. *Herpes* **8**:12-16.
- Nagaike K, Mori Y, Gomi Y, Yoshii H, Takahashi M, Wagner M, Koszinowski U, Yamanishi K (2004) Cloning of the varicella-zoster virus genome as an infectious bacterial artificial chromosome in *Escherichia coli*. *Vaccine* **22**:4069-4074.
- Nagel CH, Döhner K, Fathollahy M, Strive T, Borst EM, Messerle M, Sodeik B (2008) Nuclear egress and envelopment of herpes simplex virus capsids analyzed with dual-color fluorescence HSV1(17⁺). *J Virol* **82**:3109-3124.
- Nguyen HQ, Jumaan AO, Seward JF (2005) Decline in mortality due to varicella after implementation of varicella vaccination in the United States. *N Engl J Med* **352**:450-458.
- Norval M (2006) The effect of ultraviolet radiation on human viral infections. *Photochem Photobiol* **82**:1495-1504.
- Nygårdas M, Paavilainen H, Mütter N, Nagel CH, Röyttä M, Sodeik B, Hukkanen V (2013) A herpes simplex virus-derived replicative vector expressing LIF limits experimental demyelinating disease and modulates autoimmunity. *PLoS One* **8**:e64200.
- Oakley C, Epstein JB, Sherlock CH (1997) Reactivation of oral herpes simplex virus: implications for clinical management of herpes simplex virus recurrence during radiotherapy. *Oral Surg Oral Med Oral Pathol Oral Radiol Endod* **84**:272-278.

- Ohana B, Lipson M, Vered N, Srugo I, Ahdut M, Morag A (2000) Novel approach for specific detection of herpes simplex virus type 1 and 2 antibodies and immunoglobulin G and M antibodies. *Clin Diagn Lab Immunol* **7**:904-908.
- Oxman MN, Levin MJ, Johnson GR, Schmader KE, Straus SE, Gelb LD, Arbeit RD, Simberkoff MS, Gershon AA, Davis LE, Weinberg A, Boardman KD, Williams HM, Zhang JH, Peduzzi PN, Beisel CE, Morrison VA, Guatelli JC, Brooks PA, Kauffman CA, Pachucki CT, Neuzil KM, Betts RF, Wright PF, Griffin MR, Brunell P, Soto NE, Marques AR, Keay SK, Goodman RP, Cotton DJ, Gnann JW Jr, Loutit J, Holodniy M, Keitel WA, Crawford GE, Yeh SS, Lobo Z, Toney JF, Greenberg RN, Keller PM, Harbecke R, Hayward AR, Irwin MR, Kyriakides TC, Chan CY, Chan IS, Wang WW, Annunziato PW, Silber JL; Shingles Prevention Study Group (2005) A vaccine to prevent herpes zoster and postherpetic neuralgia in older adults. *N Engl J Med* **352**:2271-2284.
- Palù G, Gerna G, Bevilacqua F, Marcello A (1992) A point mutation in the thymidine kinase gene is responsible for acyclovir-resistance in herpes simplex virus type 2 sequential isolates. *Virus Res* **25**:133-144.
- Paz-Bailey G, Ramaswamy M, Hawkes SJ, Geretti AM (2007) Herpes simplex virus type 2: epidemiology and management options in developing countries. *Sex Transm Infect* **83**:16-22.
- Pebody RG, Andrews N, Brown D, Gopal R, De Melker H, François G, Gatcheva N, Hellenbrand W, Jokinen S, Klavs I, Kojouharova M, Kortbeek T, Kriz B, Prosenc K, Roubalova K, Teocharov P, Thierfelder W, Valle M, Van Damme P, Vranckx R (2004) The seroepidemiology of herpes simplex virus type 1 and 2 in Europe. *Sex Transm Infect* **80**:185-191.
- Pellett PE, Davison AJ, Eberle R (2011) Herpesviridae. In: King AMQ, Adams MJ, Lefkowitz EJ, editors. *Virus Taxonomy: Classification and Nomenclature of Viruses*. Ninth Report of the International Committee in Taxonomy of Viruses; Elsevier, Amsterdam, Netherlands.
- Piret J, Boivin G (2014) Antiviral drug resistance in herpesviruses other than cytomegalovirus. *Rev Med Virol* **24**:186-218.
- Pottage JC Jr, Kessler HA (1995) Herpes simplex virus resistance to acyclovir: clinical relevance. *Infect Agents Dis* **4**:115-124.
- Prichard MN, Kaiwar R, Jackman WT, Quenelle DC, Collins DJ, Kern ER, Kemble GM, Spaete RR (2005) Evaluation of AD472, a live attenuated recombinant herpes simplex virus type 2 vaccine in guinea pigs. *Vaccine* **23**:5424-5431.
- Prusoff WH (1963) Discussion of the possible mechanisms of action of 5-iodo-2'-deoxyuridine (IDU, IUDR) and chymotrypsin in the treatment of herpes simplex keratitis. *Trans Am Acad Ophthalmol Otolaryngol* **67**:707-709.
- Quinlivan M, Hawrami K, Barrett-Muir W, Aaby P, Arvin A, Chow VT, John TJ, Matondo P, Peiris M, Poulsen A, Siqueira M, Takahashi M, Talukder Y, Yamanishi K, Leedham-Green M, Scott FT, Thomas SL, Breuer J (2002) The molecular epidemiology of varicella-zoster virus: evidence for geographic segregation. *J Infect Dis* **186**:888-894.
- Quinlivan ML, Ayres KL, Kelly PJ, Parker SP, Scott FT, Johnson RW, Maple C, Breuer J (2011) Persistence of varicella-zoster virus viraemia in patients with herpes zoster. *J Clin Virol* **50**:130-135.
- Roizman B, Knipe DM, Whitley RJ (2007) Herpes Simplex Viruses. In: Knipe DM, Howley PM, editors. *Fields Virology*. Fifth edition; Lippincott Williams & Wilki, Philadelphia, PA, USA.
- Rustigian R, Smulow JB, Tye M, Gibson WA, Shindell E (1966) Studies on latent infection of skin and oral mucosa in individuals with recurrent herpes simplex. *J Invest Dermatol* **47**:218-221.
- Saeki Y, Ichikawa T, Saeki A, Chiocca EA, Tobler K, Ackermann M, Breakefield XO, Fraefel C (1998) Herpes simplex virus type 1 DNA amplified as bacterial artificial chromosome in *Escherichia coli*: rescue of replication-competent virus progeny and packaging of amplicon vectors. *Hum Gene Ther* **9**:2787-2794.

- Safrin S, Assaykeen T, Follansbee S, Mills J (1990) Foscarnet therapy for acyclovir-resistant mucocutaneous herpes simplex virus infection in 26 AIDS patients: preliminary data. *J Infect Dis* **161**:1078-1084.
- Safrin S, Palacios E, Leahy BJ (1996) Comparative evaluation of microplate enzyme-linked immunosorbent assay versus plaque reduction assay for antiviral susceptibility testing of herpes simplex virus isolates. *Antimicrob Agents Chemother* **40**:1017-1019.
- Saijo M, Suzutani T, De Clercq E, Niikura M, Maeda A, Morikawa S, Kurane I (2002) Genotypic and phenotypic characterization of the thymidine kinase of ACV-resistant HSV-1 derived from an acyclovir-sensitive herpes simplex virus type 1 strain. *Antiviral Res* **56**:253-262.
- Saint-Léger E, Caumes E, Breton G, Douard D, Saiag P, Huraux JM, Bricaire F, Agut H, Fillet AM (2001) Clinical and virologic characterization of acyclovir-resistant varicella-zoster viruses isolated from 11 patients with acquired immunodeficiency syndrome. *Clin Infect Dis* **33**:2061-2067.
- Sakaoka H, Kawana T, Grillner L, Aomori T, Yamaguchi T, Saito H, Fujinaga K (1987a) Genome variations in herpes simplex virus type 2 strains isolated in Japan and Sweden. *J Gen Virol* **68**:2105-16.
- Sakaoka H, Saito H, Sekine K, Aomori T, Grillner L, Wadell G, Fujinaga K (1987b) Genomic comparison of herpes simplex virus type 1 isolates from Japan, Sweden and Kenya. *J Gen Virol* **68**:749-64.
- Sasadeusz JJ, Tufaro F, Safrin S, Schubert K, Hubinette MM, Cheung PK, Sacks SL (1997) Homopolymer mutational hot spots mediate herpes simplex virus resistance to acyclovir. *J Virol* **71**:3872-3878.
- Sauerbrei A, Bohn K, Heim A, Hofmann J, Weissbrich B, Schnitzler P, Hoffmann D, Zell R, Jahn G, Wutzler P, Hamprecht K (2011a) Novel resistance-associated mutations of thymidine kinase and DNA polymerase genes of herpes simplex virus type 1 and type 2. *Antivir Ther* **16**:1297-1308.
- Sauerbrei A, Bohn-Wippert K, Kaspar M, Krumbholz A, Karrasch M, Zell R (2016) Database on natural polymorphisms and resistance-related non-synonymous mutations in thymidine kinase and DNA polymerase genes of herpes simplex virus types 1 and 2. *J Antimicrob Chemother* **71**:6-16.
- Sauerbrei A, Deinhardt S, Zell R, Wutzler P (2010a) Phenotypic and genotypic characterization of acyclovir-resistant clinical isolates of herpes simplex virus. *Antiviral Res* **86**:246-252.
- Sauerbrei A, Deinhardt S, Zell R, Wutzler P (2010b) Testing of herpes simplex virus for resistance to antiviral drugs. *Virulence* **1**:555-7.
- Sauerbrei A, Liermann K, Bohn K, Henke A, Zell R, Gronowitz S, Wutzler P (2012) Significance of amino acid substitutions in the thymidine kinase gene of herpes simplex virus type 1 for resistance. *Antiviral Res* **96**:105-107.
- Sauerbrei A, Taut J, Zell R, Wutzler P (2011b) Resistance testing of clinical varicella-zoster virus strains. *Antiviral Res* **90**:242-247.
- Sauerbrei A, Vödisch S, Bohn K, Schacke M, Gronowitz S (2013) Screening of herpes simplex virus type 1 isolates for acyclovir resistance using DiviTum[®] assay. *J Virol Methods* **188**:70-72.
- Saylor D, Thakur K, Venkatesan A, (2015) Acute encephalitis in the immunocompromised individual. *Curr Opin Infect Dis* **28**:330-336.
- Schmidt M, Kress M, Heinemann S, Fickenscher H (2003) Varicella-zoster virus isolates, but not the vaccine strains OKA, induce sensitivity to alpha-1 and beta-1 adrenergic stimulation of sensory neurones in culture. *J Med Virol* **70** Suppl: 82-89.
- Schmidt S, Bohn-Wippert K, Schlattmann P, Zell R, Sauerbrei A (2015) Sequence analysis of herpes simplex virus 1 thymidine kinase and DNA polymerase genes from over 300 clinical isolates from 1973 to 2014 finds novel mutations that may be relevant for development of antiviral resistance. *Antimicrob Agents Chemother* **59**:4938-4945.

- Schmit I, Boivin G (1999) Characterization of the DNA polymerase and thymidine kinase genes of herpes simplex virus isolates from AIDS patients in whom acyclovir and foscarnet therapy sequentially failed. *J Infect Dis* **180**:487-490.
- Schubert A, Gentner E, Bohn K, Schwarz M, Mertens T, Sauerbrei A (2014) Single nucleotide polymorphisms of thymidine kinase and DNA polymerase genes in clinical herpes simplex virus type 1 isolates associated with different resistance phenotypes. *Antiviral Res* **107**:16-22.
- Schulte EC, Sauerbrei A, Hoffmann D, Zimmer C, Hemmer B, Mühlau M (2010) Acyclovir resistance in herpes simplex encephalitis. *Ann Neurol* **67**:830-833.
- Schulte JM, Bellamy AR, Hook EW, Bernstein DI, Levin MJ, Leone PA, Sokol-Anderson ML, Ewell MG, Wolff PA, Heineman TC, Belshe RB, (2014) HSV-1 and HSV-2 seroprevalence in the united states among asymptomatic women unaware of any herpes simplex virus infection (Herpevac Trial for Women). *South Med J* **107**:79-84.
- Sergerie Y, Boivin G (2006) Thymidine kinase mutations conferring acyclovir resistance in herpes simplex type 1 recombinant viruses. *Antimicrob Agents Chemother* **50**:3889-3892.
- Seward JF, Watson BM, Peterson CL, Mascola L, Pelosi JW, Zhang JX, Maupin TJ, Goldman GS, Tabony LJ, Brodovicz KG, Jumaan AO, Wharton M (2002) Varicella disease after introduction of varicella vaccine in the United States, 1995-2000. *JAMA* **287**:606-611.
- Shimada Y, Suzuki M, Shirasaki F, Saito E, Sogo K, Hasegawa M, Takehara K, Phromjai J, Chuhjo T., Shiraki K (2007) Genital herpes due to acyclovir-sensitive herpes simplex virus caused secondary and recurrent herpetic whitlows due to thymidine kinase-deficient/temperature-sensitive virus. *J Med Virol* **79**:1731-1740.
- Shizuya H, Birren B, Kim UJ, Mancino V, Slepak T, Tachiiri Y, Simon M (1992) Cloning and stable maintenance of 300-kilobase-pair fragments of human DNA in *Escherichia coli* using an F-factor-based vector. *Proc Natl Acad Sci USA* **89**:8794-8797.
- Singh TD, Fugate JE, Hocker S, Wijdicks EF, Aksamit AJ Jr, Rabinstein AA (2016) Predictors of outcome in HSV encephalitis. *J Neurol* **263**:277-289.
- Sinzger C, Hahn G, Digel M, Katona R, Sampaio KL, Messerle M, Hengel H, Koszinowski U, Brune W, Adler B (2008) Cloning and sequencing of a highly productive, endotheliotropic virus strain derived from human cytomegalovirus TB40/E. *J Gen Virol* **89**:359-368.
- Smith GA, Enquist LW (1999) Construction and transposon mutagenesis in *Escherichia coli* of a full-length infectious clone of pseudorabies virus, an alphaherpesvirus. *J Virol* **73**:6405-6414.
- Smith GA, Enquist LW (2000) A self-recombining bacterial artificial chromosome and its application for analysis of herpesvirus pathogenesis. *Proc Natl Acad Sci USA* **97**:4873-4878.
- Snijder B, Sacher R, Rämö P, Liberali P, Mench K, Wolfrum N, Burleigh L, Scott CC, Verheije MH, Mercer J, Moese S, Heger T, Theusner K, Jurgeit A, Lamparter D, Balistreri G, Schelhaas M, De Haan CA, Marjomäki V, Hyypiä T, Rottier PJ, Sodeik B, Marsh M, Gruenberg J, Amara A, Greber U, Helenius A, Pelkmans L (2012) Single-cell analysis of population context advances RNAi screening at multiple levels. *Mol Syst Biol* **24**;8:579.
- Stanberry LR, Bernstein DI, Burke RL, Pacht C, Myers MG (1987) Vaccination with recombinant herpes simplex virus glycoproteins: protection against initial and recurrent genital herpes. *J Infect Dis* **155**:914-920.
- Stanberry LR, Spruance SL, Cunningham AL, Bernstein DI, Mindel A, Sacks S, Tyring S, Aoki FY, Slaoui M, Denis M, Vandepapeliere P, Dubin G; GlaxoSmithKline Herpes Vaccine Efficacy Study Group (2002) Glycoprotein-D-adjuvant vaccine to prevent genital herpes. *N Engl J Med* **347**:1652-1661.
- Stephenson-Famy A, Gardella C (2014) Herpes simplex virus infection during pregnancy. *Obstet Gynecol Clin North Am* **41**:601-614.

- Stevens JG, Cook ML (1971) Latent herpes simplex virus in spinal ganglia of mice. *Science* **173**:843-845.
- Stewart JA, Reef SE, Pellett PE, Corey L, Whitley RJ (1995) Herpesvirus infections in persons infected with human immunodeficiency virus. *Clin Infect Dis* **21** Suppl1:S114-20.
- Stránská R, Schuurman R, Scholl DR, Jollick JA, Shaw CJ, Loef C, Polman M, van Loon AM (2004a) ELVIRA HSV, a yield reduction assay for rapid herpes simplex virus susceptibility testing. *Antimicrob Agents Chemother* **48**:2331-2333.
- Stránská R, van Loon AM, Polman M, Beersma MF, Bredius RG, Lankester AC, Meijer E, Schuurman R (2004b) Genotypic and phenotypic characterization of acyclovir-resistant herpes simplex viruses isolated from haematopoietic stem cell transplant recipients. *Antivir Ther* **9**:565-575.
- Stránská R, van Loon AM, Polman M, Schuurman R (2002) Application of real-time PCR for determination of antiviral drug susceptibility of herpes simplex virus. *Antimicrob Agents Chemother* **46**:2943-2947.
- Sudesh S, Laibson PR (1999) The impact of the herpetic eye disease studies on the management of herpes simplex virus ocular infections. *Curr Opin Ophthalmol* **10**:230-233.
- Sudo K, Konno K, Yokota T, Shigeta S (1994) A sensitive assay system screening antiviral compounds against herpes simplex virus type 1 and type 2. *J Virol Methods* **49**:169-178.
- Suzutani T, Davies LC, Honess RW (1993) Kinetic studies of the predicted substrate-binding site of varicella-zoster virus thymidine kinase. *J Gen Virol* **74**:1011-1016.
- Suzutani T, Ishioka K, De Clercq E, Ishibashi K, Kaneko H, Kira T, Hashimoto K, Ogasawara M, Ohtani K, Wakamiya N, Saijo M (2003) Differential mutation patterns in thymidine kinase and DNA polymerase genes of herpes simplex virus type 1 clones passaged in the presence of acyclovir or penciclovir. *Antimicrob Agents Chemother* **47**:1707-1713.
- Suzutani T, Saijo M, Nagamine M, Ogasawara M, Azuma M (2000) Rapid phenotypic characterization method for herpes simplex virus and varicella-zoster virus thymidine kinases to screen for acyclovir-resistant viral infection. *J Clin Microbiol* **38**:1839-1844.
- Swierkosz EM, Hodinka RL, Moore BM, Sacks S, Scholl DR, Wright DK, (2004) Antiviral susceptibility testing: Herpes simplex virus by plaque reduction assay; approved standard. Clinical and Laboratory Standard Institute (CLSI); M33-A Vol. 24 No.7, ISBN 1-56238-522-4.
- Swierkosz EM, Scholl DR, Brown JL, Jollick JD, Gleaves CA (1987) Improved DNA hybridization method for detection of acyclovir-resistant herpes simplex virus. *Antimicrob Agents Chemother* **31**:1465-1469.
- Szpara ML, Gatherer D, Ochoa A, Greenbaum B, Dolan A, Bowden RJ, Enquist LW, Legendre M, Davison AJ (2014) Evolution and diversity in human herpes simplex virus genomes. *J Virol* **88**:1209-1227.
- Takahashi M, Otsuka T, Okuno Y, Asano Y, Yazaki T (1974) Live vaccine used to prevent the spread of varicella in children in hospital. *Lancet* **2**:1288-1290.
- Takeuchi H, Baba M, Shigeta S (1991) An application of tetrazolium (MTT) colorimetric assay for the screening of anti-herpes simplex virus compounds. *J Virol Methods* **33**:61-71.
- Talarico CL, Phelps WC, Biron KK (1993) Analysis of the thymidine kinase genes from acyclovir-resistant mutants of varicella-zoster virus isolated from patients with AIDS. *J Virol* **67**:1024-1033.
- Tardif KD, Jorgensen S, Langer J, Prichard M, Schlaberg R (2014) Simultaneous titration and phenotypic antiviral drug susceptibility testing for herpes simplex virus 1 and 2. *J Clin Virol* **61**:382-386.
- Taylor JR, Schmieder GJ, Shimizu T, Tie C, Streilein JW (1994) Interrelationship between ultraviolet light and recurrent herpes simplex infections in man. *J Dermatol Sci* **8**:224-232.

- Tebas P, Stabell EC, Olivo PD (1995) Antiviral susceptibility testing with a cell line which expresses beta-galactosidase after infection with herpes simplex virus. Antimicrob Agents Chemother **39**:1287-1291.
- Thi TN, Deback C, Malet I, Bonnafous P, Ait-Arkoub Z, Agut H (2006) Rapid determination of antiviral drug susceptibility of herpes simplex virus types 1 and 2 by real-time PCR. Antiviral Res **69**:152-157.
- Tischer BK, Kaufer BB, Sommer M, Wussow F, Arvin AM, Osterrieder N (2007) A self-excisable infectious bacterial artificial chromosome clone of varicella-zoster virus allows analysis of the essential tegument protein encoded by ORF9. J Virol **81**:13200-13208
- Tischer BK, Smith GA, Osterrieder N (2010) En passant mutagenesis: a two step markerless red recombination system. Methods Mol Biol **634**:421-430.
- Tischer BK, von Einem J, Kaufer B, Osterrieder N (2006) Two-step red-mediated recombination for versatile high-efficiency markerless DNA manipulation in Escherichia coli. Biotechniques **40**:191-197.
- Tsien RY (1998) The green fluorescent protein. Annu Rev Biochem **67**:509-544.
- van der Beek MT, Claas EC, van der Blij-de Brouwer CS, Morfin F, Rusman LG, Kroes AC, Vossen AC (2013a) Rapid susceptibility testing for herpes simplex virus type 1 using real-time PCR. J Clin Virol **56**:19-24.
- van der Beek MT, Vermont CL, Bredius RG, Marijt EW, van der Blij-de Brouwer CS, Kroes AC, Claas EC, Vossen AC (2013b) Persistence and antiviral resistance of varicella zoster virus in hematological patients. Clin Infect Dis **56**:335-343.
- van Velzen M, Missotten T, van Loenen FB, Meesters RJ, Luidert TM, Baarsma GS, Osterhaus AD, Verjans GM (2013) Acyclovir-resistant herpes simplex virus type 1 in intra-ocular fluid samples of herpetic uveitis patients. J Clin Virol **57**:215-221.
- Vázquez M, Shapiro ED (2005) Varicella vaccine and infection with varicella-zoster virus. N Engl J Med **352**:439-440.
- Wagner M, Ruzsics Z, Koszinowski UH (2002) Herpesvirus genetics has come of age. Trends Microbiol **10**:318-324.
- Wald A, Corey L, Timmler B, Magaret A, Warren T, Tyring S, Johnston C, Kriesel J, Fife K, Galitz L, Stoelben S, Huang ML, Selke S, Stobernack HP, Ruebsamen-Schaeff H, Birkmann A (2014) Helicase-primase inhibitor pritelivir for HSV-2 infection. N Engl J Med **370**:201-210.
- Wald A, Link K (2002) Risk of human immunodeficiency virus infection in herpes simplex virus type 2-seropositive persons: a meta-analysis. J Infect Dis **185**:45-52.
- Wang Y, Wang Q, Zhu Q, Zhou R, Liu J, Peng T (2011) Identification and characterization of acyclovir-resistant clinical HSV-1 isolates from children. J Clin Virol **52**:107-112.
- Warden C, Tang Q, Zhu H, (2011) Herpesvirus BACs: past, present, and future. J Biomed Biotechnol **2011**:124595.
- Watts DH, Brown ZA, Money D, Selke S, Huang ML, Sacks SL, Corey L (2003) A double-blind, randomized, placebo-controlled trial of acyclovir in late pregnancy for the reduction of herpes simplex virus shedding and cesarean delivery. Am J Obstet Gynecol **188**:836-843.
- Weibel RE, Neff BJ, Kuter BJ, Guess HA, Rothenberger CA, Fitzgerald AJ, Connor KA, McLean AA, Hilleman MR, Buynak EB, Scolnick EM (1984) Live attenuated varicella virus vaccine. Efficacy trial in healthy children. N Engl J Med **310**:1409-1415.
- Weinberg A, Levin MJ (2010) VZV T cell-mediated immunity. Curr Top Microbiol Immunol **342**:341-357.

-
- Wharton M (1996) The epidemiology of varicella-zoster virus infections. *Infect Dis Clin North Am* **10**:571-581.
- Whitley RJ, Gnann JW (1993) The epidemiology and clinical manifestations of herpes simplex virus infections. In: Roizman B, Whitley RJ, Lopez C, editors. *The Human Herpesviruses*. Lippincott-Raven. Philadelphia, PA, USA.
- Whitley RJ, Roizman B (2001) Herpes simplex virus infections. *Lancet* **357**:1513-1518.
- Wild K, Bohner T, Folkers G, Schulz GE (1997) The structure of thymidine kinase from herpes simplex virus type 1 in complex with substrates and a substrate analogue. *Protein Sci* **6**:2097-2106.
- Wussow F, Fickenscher H, Tischer BK (2009) Red-mediated transposition and final release of the mini-F vector of a cloned infectious herpesvirus genome. *PLoS One* **4**:e8178.
- Wussow F, Spieckermann T, Brunneemann AK, Hüske L, Toptan T, Fickenscher H (2011) Bacterial genetics of large mammalian DNA viruses: bacterial artificial chromosomes as a prerequisite for efficiently studying viral DNA replication and functions. In: Seligmann H, editor. *DNA replication-Current advances*. InTech, Rijeka, Croatia.
- Wutzler P, Knuff M, Liese J (2008) Varicella: efficacy of two-dose vaccination in childhood. *Dtsch Arztebl Int* **105**:567-572.
- Yu D, Smith GA, Enquist LW, Shenk T (2002) Construction of a self-excisable bacterial artificial chromosome containing the human cytomegalovirus genome and mutagenesis of the diploid TRL/IRL13 gene. *J Virol* **76**:2316-2328.
- Zell R, Taudien S, Pfaff F, Wutzler P, Platzner M, Sauerbrei A (2012) Sequencing of 21 varicella-zoster virus genomes reveals two novel genotypes and evidence of recombination. *J Virol* **86**:1608-1622.
- Zhang J, Chung DW, Tan CK, Downey KM, Davie EW, So AG (1991) Primary structure of the catalytic subunit of calf thymus DNA polymerase delta: sequence similarities with other DNA polymerases. *Biochemistry* **30**:11742-11750.
- Zhang Z, Rowe J, Wang W, Sommer M, Arvin A, Moffat J, Zhu H (2007) Genetic analysis of varicella-zoster virus ORF0 to ORF4 by use of a novel luciferase bacterial artificial chromosome system. *J Virol* **81**:9024-9033.
- Zhang Z, Selariu A, Warden C, Huang G, Huang Y, Zaccheus O, Cheng T, Xia N, Zhu H (2010) Genome-wide mutagenesis reveals that ORF7 is a novel VZV skin-tropic factor. *PLoS Pathog* **6**:e1000971.
- Zhou FC, Zhang YJ, Deng JH, Wang XP, Pan HY, Hettler E, Gao SJ (2002) Efficient infection by a recombinant Kaposi's sarcoma-associated herpesvirus cloned in a bacterial artificial chromosome: application for genetic analysis. *J Virol* **76**:6185-6196.

Acknowledgements

First, I would like to thank Prof. Dr. Helmut Fickenscher for supervising my PhD study. Thank you for giving me the opportunity to work on this demanding research topic and for supporting me in acquiring new skills on the fields of cell culture, diagnostic research, and microscopy. You encouraged me never to give up in desperate situations.

Special thanks go to PD Dr. Andi Krumbholz for his great support in the project management. Thank you that your door was always open for questions, advice, and discussion.

A number of people contributed to making this study possible by kindly providing data or reagents: I would like to express my gratitude to Prof. Dr. Andreas Sauerbrei from the University of Jena for providing clinical data on relevant mutations and for adding further data on antiviral susceptibility performed by the *Consulting Laboratory for HSV and VZV* (Konsiliarlabor). Further, I would like to thank Prof. Dr. Beate Sodeik from the Hannover Medical School (Hannover, Germany) for the HSV1(17⁺)Lox BAC, and Dr. Claus-Henning Nagel from the Heinrich-Pette Institute (Hamburg, Germany) for the HSV2(MS)Lox BAC.

Dearly I want to thank Bianca Großheim, Andrea Hölzgen, and Petra Krüger for excellent technical assistance.

To all past and present members of the lab: thank you for being such great colleagues! It has always been an enjoyable teamwork, a great atmosphere, and a lot of fun working with you.

Last but not least and more than anything else I would like to thank my family and friends, without whom I could not have done this. Thanks for always being there when I need you!

Publications and Presentations

Publications

Brunnemann AK, Liermann K, Deinhardt-Emmer S, Maschkowitz G, Pohlmann A, Sodeik B, Fickenscher H, Sauerbrei A, Krumbholz A (2016) Recombinant herpes simplex virus type 1 strains with targeted mutations relevant for aciclovir susceptibility. *submitted*

Brunnemann AK, Bohn-Wippert K, Zell R, Henke A, Walther M, Braum O, Maschkowitz G, Fickenscher H, Sauerbrei A, Krumbholz A (2015) Drug resistance of clinical varicella-zoster virus strains confirmed by recombinant thymidine kinase expression and by targeted resistance mutagenesis of a cloned wild-type isolate. *Antimicrob Agents Chemother* **59**:2726-2734.

Wussow F, Spieckermann T, Brunnemann AK, Hüske L, Toptan T, Fickenscher H (2011) Bacterial genetics of large mammalian DNA viruses: bacterial artificial chromosomes as a prerequisite for efficiently studying viral DNA replication and functions. In: Seligmann H, editor. *DNA replication-Current advances*. InTech, Rijeka, Croatia.

Presentations

Brunnemann AK, Bohn K, Mader J, Fickenscher H, Sauerbrei A, Krumbholz A (2016) Evaluation of single nucleotide polymorphisms of herpes simplex virus type 1 found in the thymidine kinase gene of clinical isolates associated with resistance. *Poster presentation*, Meeting of the Society of Virology, Münster, Germany

Brunnemann AK, Bohn K, Zell R, Walther M, Fickenscher H, Sauerbrei A, Krumbholz A, (2014) Resistance-associated mutations from clinical varicella-zoster virus sequences as the cause of drug resistance proven by targeted recombinants of a cloned clinical wild type isolate. *Oral presentation*, Meeting of the Society of Virology, Alpbach, Germany

Brunnemann AK, Späth M, Petersen N, Fickenscher H (2012) Chimeric wild-type/vaccine varicella-zoster virus recombinants. *Poster presentation*, Meeting of the Society of Virology, Essen, Germany

Brunnemann AK, Wussow F, Krater T, Toptan T, Fickenscher H (2010) Substitution of a large repeated allelic gene of varicella-zoster virus by Red recombination. *Oral presentation*, Mini Herpes Virus Workshop, Berlin, Germany

Brunnemann AK, Wussow F, Krater T, Toptan T, Fickenscher H (2010) Substitution of a large repeated allelic gene of varicella-zoster virus by red recombination. *Poster presentation*, European Congress of Virology, Cernobbio, Mailand

Erklärung

Hiermit erkläre ich, dass die Abhandlung der vorliegenden Dissertation, abgesehen von der Beratung durch meine Betreuer PD Dr. Andi Krumbholz und Prof. Dr. Helmut Fickenscher, nach Inhalt und Form die eigene Arbeit ist. Teile dieser Arbeit wurden bereits veröffentlicht oder zur Publikation eingereicht. Zudem entstand die vorliegende Arbeit unter Einhaltung der Regeln guter wissenschaftlicher Praxis der Deutschen Forschungsgemeinschaft. Des Weiteren erkläre ich, dass ich noch keinen Promotionsversuch unternommen habe.

Kiel, den 04.05.2016

Anne-Kathrin Brunnemann

Lebenslauf

Persönliche Daten:

Vor- und Zunahme: Anne-Kathrin Elisabeth Brunnemann
Geburtstag: 19.10.1984
Geburtsort: Gotha

Akademische Ausbildung

2009-2016 Promotion am Institut für Infektionsmedizin der Christian-Albrechts-Universität zu Kiel
Thema: Aciclovir resistance phenotype of clinical isolates proven by targeted mutagenesis of recombinant herpes simplex and varicella zoster viruses

2008-2009 Diplomarbeit am Institut für Infektionsmedizin der Christian-Albrechts-Universität zu Kiel
Thema: Gezielte herpesvirale Inter-Stamm-Rekombination durch *En-passant*-Mutagenese

2004-2009 Hochschulstudium an der Christian-Albrechts-Universität zu Kiel
Studiengang: Biologie; Hauptfach: Zellbiologie

Schulische Ausbildung:

1999-2004 Gymnasium Waren Müritz
1995-1999 Gymnasium Röbel (Müritz)
1991-1995 Grundschule Röbel (Müritz)

Praktika

08/2011-09/2011 Seminar: Tierschutz und Versuchstiere in der Forschung
08/2007-09/2007 Forschungspraktikum am Forschungszentrum Borstel (Leibniz-Institut)