

Aus dem Institut für Tierzucht und Tierhaltung
der Agrar- und Ernährungswissenschaftlichen Fakultät
der Christian-Albrechts-Universität zu Kiel

ACCUMULATING SUBSTANCES AND THEIR EFFECTS ON PIKEPERCH (*Sander lucioperca*) IN RECIRCULATING AQUACULTURE SYSTEMS

Dissertation
zur Erlangung des Doktorgrades
der Agrar- und Ernährungswissenschaftlichen Fakultät
der Christian-Albrechts-Universität zu Kiel

vorgelegt von

M.Sc.

Kathrin Steinberg

geboren in Thedinghausen

Kiel, 2018

Dekan:	Prof. Dr. Dr. Christian Henning
Erster Berichterstatter:	Prof. Dr. Carsten Schulz
Zweiter Berichterstatter:	Prof. Dr. Ulfert Focken
Tag der mündlichen Prüfung:	04. Juli 2018

Die vorliegende Dissertation wurde mit dankenswerter finanzieller Unterstützung des Bundesministeriums für Bildung und Forschung (BMBF) im Rahmen des Vorhabens „Bioökonomie International: NutriPerc – Ernährungsansprüche und alternative Rohstoffe für eine nachhaltige Aquakultur der Familie Percidae“ angefertigt.

Gedruckt mit Genehmigung der Agrar- und Ernährungswissenschaftlichen Fakultät der
Christian-Albrechts-Universität zu Kiel

Kuku, kuku ika, kuku wehiwehi,
Takina ko koe nā, te iho o ika,
Te iho o Tangaroa –
Uara ki uta rā, uara ki tai rā.

(Māori prayer to the god of the sea)

Hold tight, hold the fish, hold tight with fearsome power,
You are led along, the essence of the fish,
The essence of Tangaroa –
Desired on the land, desired on the sea

Table of Contents

GENERAL INTRODUCTION	1
CHAPTER 1	11
THE EFFECT OF CARBON DIOXIDE ON GROWTH AND ENERGY METABOLISM IN PIKEPERCH (<i>Sander lucioperca</i>)	
CHAPTER 2	31
ELEVATED NITRATE LEVELS AFFECT THE ENERGY METABOLISM OF PIKEPERCH (<i>Sander lucioperca</i>) IN RAS	
CHAPTER 3	57
CUMULATIVE FEED BURDEN HAS VARIOUS EFFECTS ON PIKEPERCH (<i>Sander lucioperca</i>) METABOLISM AND ON WATER QUALITY PARAMETERS	
GENERAL DISCUSSION	87
SUMMARY	107
ZUSAMMENFASSUNG	111
APPENDIX	117
ACKNOWLEDGEMENTS	131
CURRICULUM VITAE	132

List of Tables

Table 1-1	Average water chemistry parameters (mean \pm SD) in each of the three CO ₂ treatment groups. Provided are averages of repeated measurements in the outflow of three replicates.	18
Table 1-2	Comparison of growth and condition variables of pikeperch reared for 58 days under three different dissolved CO ₂ conditions.	19
Table 1-3	Body composition [% of original substance] and gross energy contents of whole pikeperch reared under three different dissolved CO ₂ conditions: low, medium and high.	20
Table 1-4	Energy budgets of pikeperch reared under three different dissolved CO ₂ conditions after four weeks of treatment.	21
Table 2-1	Average water quality parameters in the RARS on the last five days of each nitrate concentration period.	39
Table 2-2	Metabolic body weight, feed intake, oxygen consumption and SDA of pikeperch reared under four different NO ₃ -N levels.	40
Table 2-3	Energy budgets of pikeperch reared at four different NO ₃ -N levels fed three different feeding levels.	41
Table 2-4	Parameters of the linear regression equations (n = 9) with R ² = 0.989.	46
Table 3-1	Water quality parameters in the RAS on the last day of the experiment. Values for pH, T and O ₂ represent the average concentration over the whole experimental period.	64

LIST OF TABLES

Table 3-2	Mean (\pm SD) dissolved metal and nutrient concentrations in the three treatments on the last day of the experiment.	68
Table 3-3	Mean values (\pm SD) of fish growth and health parameters.	69
Table 3-4	Fish growth parameters as mean (\pm SD) during phase 1 (accumulation) of the experiment.	71
Table 3-5	Fish growth parameters as mean (\pm SD) during the steady state phase (phase 2).	71
Table 3-6	Range of water quality parameters corresponding to the CFB threshold value of $1953 \pm 613 \text{ mg L}^{-1}$ (identified via segmented linear regression).	73
Table GD-1	Comparison of identified threshold values for carbon dioxide (CO_2) and nitrate-nitrogen ($\text{NO}_3\text{-N}$) in single factor experiments (<i>Chapter 1</i> and <i>2</i>) and the CFB experiment (<i>Chapter 3</i>).	100

List of Figures

Figure 1-1	Average individual end (wet) weight of pikeperch after 58 feeding days reared under three different dissolved CO ₂ conditions.	19
Figure 1-2	Ammonia quotient (AQ) measurements on week 4 of pikeperch reared under three different hypercapnia conditions as a function of the mean carbon dioxide concentration.	22
Figure 2-1	Percentage of retained energy (RE) of gross energy intake of pikeperch at four different NO ₃ -N levels. Capital letters indicate significant differences between nitrate levels within feeding levels (FL 1.25: A, B, C; FL 2.00: K, L, M; FL 2.75: R, S, T) ($p < 0.05$).	42
Figure 2-2	Metabolic TAN (total ammonia-nitrogen) production rate of pikeperch at four NO ₃ -N levels in fed and fasting conditions as average of all feeding levels (n = 9) Capital letters indicate significant differences between peaks of metabolic TAN production rate in fed conditions ($p < 0.05$).	43
Figure 2-3	Ammonia Quotient (AQ) during fed and fasting conditions at four different nitrate treatments. Capital letters indicate significant differences between feeding levels. Lower case letters indicate significant differences between fed and fasting conditions within feeding level ($p < 0.05$).	44
Figure 2-4	Energy retention per metabolic weight (RE) of pikeperch at four different nitrate levels based on different digestible energy intake (DEI). Each data point represents one respirometer tank.	45

LIST OF FIGURES

Figure 3-1	Nitrate-nitrogen concentration (mean \pm SD, n = 4) over the course of the experiment.	66
Figure 3-2	Weekly NO ₂ -N concentrations in the different CFB treatments (low, medium and high). Different symbols represent different tanks.	67
Figure 3-3	Segmented linear regression of individual SGRs upon the average CFB in the corresponding experimental period. Dashed lines indicate the 90% confidence belt. The box indicates the 90% confidence block of the break-point.	72
Figure A-1	Overview of the recirculating aquaculture respirometer system (RARS).	117

GENERAL INTRODUCTION

Recirculating Aquaculture Systems – future and current constraints

The Food and Agriculture Organisation of the United Nations states that more than 50% of fish for human consumption derives from aquaculture (FAO, 2016). Growing awareness of the environmental safety and impact of aquaculture is caused by waste discharges (Ackefors and Enell, 1990), escapees of fish from sea cages to the environment (Jensen et al., 2010) or the use of chemicals (Read and Fernandes, 2003). Increasing environmental regulations have increased the need to develop closed aquaculture systems (Martins et al., 2010). Recirculating aquaculture systems (RAS) have gained interest over the past decades due to the potentially low water consumption and reduced environmental impacts (Dalsgaard et al., 2013; Pedersen et al., 2012; Timmons and Ebeling, 2007). The systems are categorised as intensive aquaculture systems and the main advantage are the low water exchange rates and the increased degree of control over the environment (Badiola et al., 2012; Bregnballe, 2015). Nevertheless, more research on reuse and recycling of water and waste is needed in order to develop zero-exchange RAS and comply with tightened environmental requirements (Slater et al., 2018). High investment costs and long pay-back times are one of the main constraints in the development of RAS (Badiola et al., 2012). Other constraints are based on water quality and management as detailed knowledge on different parameters is crucial in order to produce healthy fish in a cost effective way in RAS. Substances that are not treated by the system such as minerals or hormones can accumulate and directly affect the fish (Davidson et al., 2009; Martins et al., 2009b). Interactions of different water quality parameters and the effects on fish are still poorly understood and more research is needed.

Bottlenecks of rearing adult Pikeperch in RAS

Farming pikeperch (*Sander lucioperca*) in RAS is a relatively new industry, while rearing pikeperch in extensive pond systems has been done in Europe for decades (Dalsgaard et al., 2013). Hitherto only few commercial RAS farms exist and detailed knowledge on

optimal water quality parameters is still scarce (Bregnballe, 2015). Personal communication with pikeperch farmers in Europe illustrated the major issues of pikeperch farming, one of which is an apparent growth retardation in adult life stages. The exact reasons for this remain unknown. However, research on other species indicate that the sensitivity of a species in respect to different water quality parameters change with size and age thus causing changes in growth rates (Atwood et al., 2001; Martins et al., 2009a; Palachek and Tomasso, 1984). Fish growth is generally known to be plastic and subject to feed availability as well as environmental factors (Weatherley, 1990). A clear effect for temperature on fish metabolism has been confirmed (National Research Council, 2011) and research on juvenile turbot (*Psetta maxima*) showed an effect of different salinities on the metabolism (Dietz et al., 2013). Impacts of other environmental factors are therefore not unlikely to cause the growth retardation in pikeperch. Detailed research on the effects of different water quality parameters is needed in order to adequately address size specific impacts on pikeperch and to develop profitable RAS producing healthy fish.

Single factor approach and multifactorial approach

Growth of fish generally depends on energy supply and energy spent on maintenance or lost as faecal or excretory products (Jobling, 1994). Maintenance requirements are species specific and dependant on the surrounding environment. Fish are poikilothermic animals and thus directly influenced by their surrounding environment (Hoar et al., 1979). It is widely accepted that other environmental parameters, apart from temperature, also influence fish metabolism. Studies have mainly focused on individual effects e.g. salinity (Dietz et al., 2013), carbon dioxide (CO₂) (Good et al., 2018; Santos et al., 2013; Stiller et al., 2015), nitrate (Schram et al., 2013; Torno et al., 2018; van Bussel et al., 2012), nitrite (Das et al., 2004; Wuertz et al., 2013) or ammonia (Foss et al., 2004; Schram et al., 2013). Few studies have examined multifactorial effects of environmental parameters either through simple combination of two or more parameters (Overton et al., 2008; Thorarensen et al., 2018), fractional factorial design (Baekelandt et al., 2018; Gardeur et al., 2007; Trabelsi et al., 2011) or by applying different feed loads or water exchange rates (Davidson et al., 2011; Martins et al., 2009b; Pedersen et al., 2012). Results of these studies have shown that the

thresholds of water quality parameters can be significantly reduced or increased once other water quality parameters change as well. Effects can be caused by reduced uptake of hazardous concentrations e.g. reported by Wuertz et al. (2013) for reduced nitrite toxicity with increasing salinity as well as by increased toxicity e.g. of ammonia with increasing pH due to the transformation to un-ionized ammonia (Colt, 2006).

Results of single factor experiments can be used as a first approach to narrow down expected threshold concentrations and to identify the nature of the relationship between the parameter and the fish. Additional multifactorial approaches should be conducted in order to assess the potential effects in commercial situations or 'real-world' scenarios.

Evaluation of Environmental Factors

Detailed insights on the effects of different environmental factors on fish can be gained from physiological studies. Parameters evaluated in this thesis (carbon dioxide (CO₂) (*Chapter 1*) and nitrate-nitrogen (NO₃-N) (*Chapter 2*)) using the single factor approach are known to have a direct effect on metabolism by affecting oxygen consumption rates through respiratory acidosis (CO₂) or methaemoglobinemia (NO₃-N) (Timmons and Ebeling, 2007). Online measurement of oxygen consumption can thus provide more detailed insights on the effects of these environmental factors on the fish than simple growth trials. Respirometry generally provides a non-invasive measurement of physiology and is considered more suitable for short term physiological studies (Lauff and Wood, 1996; Stiller et al., 2013). Respiratory studies are generally used to compile energy budgets by evaluating metabolic energy losses through measurement of oxygen consumption (Gnaiger, 1983). The instantaneous approach, which was developed by Lauff and Wood (1996), can be used to determine the degree of protein, lipid or carbohydrate utilisation for energy metabolism through respirometry with accompanying measurements of CO₂ production and nitrogen excretion (Gnaiger, 1983; Lauff and Wood, 1996). The traditional approach to determine fuel usage is referred to as the compositional method or comparative slaughter method and is based on the measurement of changes in proximate body composition between different groups of fish over a certain amount of time (Kieffer et al., 1998; Lupatsch et al., 2003). Growth studies, accompanied with whole body

composition analysis, are practicable for long term experiments especially when imitating commercial conditions (*Chapter 3*) and provided additional results for the evaluation of the effects of CO₂ (*Chapter 1*). Understandably it is preposterous to analyse the body composition of the exact same fish at the start and end of the experimental period whereas the respirometry is based on the same group of fish thus reducing possible errors (Lauff and Wood, 1996). Nevertheless, growth rates, feed intake and feed conversion are the most important parameters for commercial aquaculture facilities and recording, if applicable, should not be neglected.

The Aim of this Thesis

The identification of the most favourable combination of environmental parameters for grow-out of healthy pikeperch in RAS is the fundamental tool to develop sustainable and economically viable pikeperch aquaculture. The first aim of this study was to compile energy budgets for adult pikeperch and identify the maintenance requirements as well as the efficiency of energy utilisation above maintenance using group respirometry. The acquired baseline data provided a more detailed insight on the energy metabolism of pikeperch. Comparisons between the energy metabolism of pikeperch in 'clean' water with single factor experiments followed by a multifactorial approach enabled a holistic picture of pikeperch in RAS. The advantage of this novel approach is the generation of commercially applicable results based on the findings of the previous experiments. Results conducted during the single factor experiments enabled a more differentiated examination of the multifactorial experiment. The research was conducted based on the hypothesis that the energy metabolism of pikeperch is directly influenced by environmental parameters expecting that interactions between influences subsist. Furthermore, we hypothesized that the sensitivity towards these factors changes with size and age and thus cause growth retardation in adult pikeperch. This dissertation will provide new insights on the metabolism of adult pikeperch and explicitly investigate how the environment affects the fish.

The following research questions will be addressed in this work:

- *Do increased levels of CO₂ have an effect on feed intake of pikeperch and how does this reflect in the energy budget?*

The aim of the first experiment (*Chapter 1*) was to establish basic energy budgets and evaluate the effect of three common levels of CO₂ (5 mg L⁻¹, 15 mg L⁻¹ and 30 mg L⁻¹) in RAS on pikeperch. The research was conducted in a recirculating aquaculture respirometer system (RARS), specifically designed for group respirometry over a longer time period (Stiller et al., 2013). This approach enabled a detailed evaluation of energy budgets, voluntary feed intake and growth at the same time. Besides growth and oxygen consumption, ammonia excretion and body composition as well as kidney and gill histology were investigated.

- *What is the average maintenance requirement and energy utilisation efficiency of pikeperch and how are they affected by elevated nitrate levels?*

In order to determine the maintenance requirement and energy utilisation efficiency of adult pikeperch, the second experiment (*Chapter 2*) was designed as a restricted ration experiment with three feeding levels in parallel triplicates in a RARS. Pikeperch were subsequently exposed to four different nitrate-nitrogen concentrations (5 mg L⁻¹, 30 mg L⁻¹, 120 mg L⁻¹ and 240 mg L⁻¹) and the experiment was concluded with an additional period of the lowest nitrate-nitrogen concentrations in order to exclude habituation effects.

- *How do increased levels of cumulative feed burden affect water quality and growth and health parameters of pikeperch in RAS?*
- *How do the results from a multifactorial study align with the single factor experiments?*

The third part of this work (*Chapter 3*) focused on a multifactorial approach in order to align the results from the single factor experiments with 'real world' conditions. Changes in water quality were achieved via cumulative feed burden (CFB). The CFB is expressed as mg L⁻¹ and quantifies input into the system (feed) over time in relation to water exchange and can be used as a measure of production intensity (Colt et al., 2006; Weaver et al., 2016). The experiment was conducted as a growth trial in twelve identical, separate RAS with three different CFB levels. Main focuses of this experiment were growth and health of fish and changes in body composition. Detailed analysis of water quality parameters provided further insights in the effects of high recirculation rates on water quality deterioration.

References

- Ackefors, H., Enell, M., 1990. Discharge of Nutrients from Swedish Fish Farming to Adjacent Sea Areas. *Ambio*. doi:10.2307/4313650
- Atwood, H.L., Fontenot, Q.C., Tomasso, J.R., Isely, J.J., 2001. Toxicity of Nitrite to Nile Tilapia: Effect of Fish Size and Environmental Chloride. *N. Am. J. Aquac.* 63, 49–51. doi:10.1577/1548-8454(2001)063<0049:TONTNT>2.0.CO;2
- Badiola, M., Mendiola, D., Bostock, J., 2012. Recirculating Aquaculture Systems (RAS) analysis: Main issues on management and future challenges. *Aquac. Eng.* 51, 26–35. doi:10.1016/j.aquaeng.2012.07.004
- Baekelandt, S., Redivo, B., Mandiki, S.N.M., Bournonville, T., Houndji, A., Bernard, B., El Kertaoui, N., Schmitz, M., Fontaine, P., Gardeur, J.N., Ledoré, Y., Kestemont, P., 2018. Multifactorial analyses revealed optimal aquaculture modalities improving husbandry fitness without clear effect on stress and immune status of pikeperch *Sander lucioperca*. *Gen. Comp. Endocrinol.* 258, 194–204. doi:10.1016/j.ygcen.2017.08.010
- Bregnballe, J., 2015. A Guide to Recirculation Aquaculture, FAO and EUROFISH. doi:92-5-105177-1
- Colt, J., 2006. Water quality requirements for reuse systems. *Aquac. Eng.* 34, 143–156. doi:10.1016/j.aquaeng.2005.08.011
- Colt, J., Lamoureux, J., Patterson, R., Rogers, G., 2006. Reporting standards for biofilter performance studies. *Aquac. Eng.* 34, 377–388. doi:10.1016/j.aquaeng.2005.09.002
- Dalsgaard, J., Lund, I., Thorarinsdottir, R., Drengstig, A., Arvonen, K., Pedersen, P.B., 2013. Farming different species in RAS in Nordic countries: Current status and future perspectives. *Aquac. Eng.* 53, 2–13. doi:10.1016/j.aquaeng.2012.11.008
- Das, P.C., Ayyappan, S., Jena, J.K., Das, B.K., 2004. Nitrite toxicity in *Cirrhinus mrigala* (Ham.): Acute toxicity and sub-lethal effect on selected haematological parameters. *Aquaculture* 235, 633–644. doi:10.1016/j.aquaculture.2004.01.020
- Davidson, J., Good, C., Welsh, C., Brazil, B., Summerfelt, S., 2009. Heavy metal and waste metabolite accumulation and their potential effect on rainbow trout performance in a replicated water reuse system operated at low or high system flushing rates. *Aquac. Eng.* 41, 136–145. doi:10.1016/j.aquaeng.2009.04.001
- Davidson, J., Good, C., Welsh, C., Summerfelt, S., 2011. The effects of ozone and water exchange rates on water quality and rainbow trout *Oncorhynchus mykiss* performance in replicated water recirculating systems. *Aquac. Eng.* 44, 80–96. doi:10.1016/j.aquaeng.2011.04.001
- Dietz, C., Stiller, K.T., Griese, M., Schulz, C., Susenbeth, A., 2013. Influence of salinity on

- energy metabolism in juvenile turbot, *Psetta maxima* (L.). *Aquac. Nutr.* 19, 135–150. doi:10.1111/anu.12034
- FAO, 2016. The State of World Fisheries and Aquaculture 2016. Contributing to food security and nutrition for all. Rome. doi:10.5860/CHOICE.50-5350
- Foss, A., Siikavuopio, S.I., Sæther, B.S., Evensen, T.H., 2004. Effect of chronic ammonia exposure on growth in juvenile Atlantic cod. *Aquaculture* 237, 179–189. doi:10.1016/j.aquaculture.2004.03.013
- Gardeur, J.N., Mathis, N., Kobilinsky, A., Brun-Bellut, J., 2007. Simultaneous effects of nutritional and environmental factors on growth and flesh quality of *Perca fluviatilis* using a fractional factorial design study. *Aquaculture* 273, 50–63. doi:10.1016/j.aquaculture.2007.09.024
- Gnaiger, E., 1983. Calculation of Energetic and Biochemical Equivalents of Respiratory Oxygen Consumption, in: *Polarographic Oxygen Sensors*. pp. 337–345.
- Good, C., Davidson, J., Terjesen, B.F., Takle, H., Kolarevic, J., Bæverfjord, G., Summerfelt, S., 2018. The effects of long-term 20 mg/L carbon dioxide exposure on the health and performance of Atlantic salmon *Salmo salar* post-smolts in water recirculation aquaculture systems. *Aquac. Eng.* 81, 1–9. doi:10.1016/j.aquaeng.2018.01.003
- Hoar, W.S., Randall, D.J., J.R., B. (Eds.), 1979. *Fish Physiology - Bioenergetics and Growth, Volume X Gills Part A*. Academic Press.
- Jensen, Dempster, T., Thorstad, E.B., Uglem, I., Fredheim, A., 2010. Escapes of fishes from Norwegian sea-cage aquaculture: Causes, consequences and prevention. *Aquac. Environ. Interact.* 1, 71–83. doi:10.3354/aei00008
- Jobling, M. (Ed.), 1994. *Fish Bioenergetics*, 1st ed. Chapman & Hall Fish & Fisheries Series 13, London.
- Kieffer, J., Alsop, D., Wood, C., 1998. A respirometric analysis of fuel use during aerobic swimming at different temperatures in rainbow trout (*Oncorhynchus mykiss*). *J. Exp. Biol.* 201, 3123–3133.
- Lauff, R.F., Wood, C.H.M., 1996. Respiratory gas exchange, nitrogenous waste excretion, and fuel usage during starvation in juvenile rainbow trout, *Oncorhynchus mykiss*. *J. Comp. Physiol. B* 165, 542–551. doi:10.1007/BF00387515
- Lupatsch, I., Kissil, G.W., Sklan, D., 2003. Comparison of energy and protein efficiency among three fish species gilthead sea bream (*Sparus aurata*), European sea bass (*Dicentrarchus labrax*) and white grouper (*Epinephelus aeneus*): Energy expenditure for protein and lipid deposition. *Aquaculture* 225, 175–189. doi:10.1016/S0044-8486(03)00288-6
- Martins, C.I.M., Eding, E.H., Verdegem, M.C.J., Heinsbroek, L.T.N., Schneider, O., Blancheton, J.P., d'Orbcastel, E.R., Verreth, J.A.J., 2010. New developments in

- recirculating aquaculture systems in Europe: A perspective on environmental sustainability. *Aquac. Eng.* 43, 83–93. doi:10.1016/j.aquaeng.2010.09.002
- Martins, C.I.M., Ochola, D., Ende, S.S.W., Eding, E.H., Verreth, J.A.J., 2009a. Is growth retardation present in Nile tilapia *Oreochromis niloticus* cultured in low water exchange recirculating aquaculture systems? *Aquaculture* 298, 43–50. doi:10.1016/j.aquaculture.2009.09.030
- Martins, C.I.M., Pistrin, M.G., Ende, S.S.W., Eding, E.H., Verreth, J.A.J., 2009b. The accumulation of substances in Recirculating Aquaculture Systems (RAS) affects embryonic and larval development in common carp *Cyprinus carpio*. *Aquaculture* 291, 65–73. doi:10.1016/j.aquaculture.2009.03.001
- National Research Council, 2011. Nutrient Requirements of Fish and Shrimp. The National Academic Press., Washington, DC. doi:https://doi.org/10.17226/13039
- Overton, J.L., Bayley, M., Paulsen, H., Wang, T., 2008. Salinity tolerance of cultured Eurasian perch, *Perca fluviatilis* L.: Effects on growth and on survival as a function of temperature. *Aquaculture* 277, 282–286. doi:10.1016/j.aquaculture.2008.02.029
- Palachek, R.M., Tomasso, J.R., 1984. Nitrite toxicity to fathead minnows: Effect of fish weight. *Bull. Environ. Contam. Toxicol.* 32, 238–242. doi:10.1007/BF01607492
- Pedersen, L.-F., Suhr, K.I., Dalsgaard, J., Pedersen, P.B., Arvin, E., 2012. Effects of feed loading on nitrogen balances and fish performance in replicated recirculating aquaculture systems. *Aquaculture* 338–341, 237–245. doi:10.1016/j.aquaculture.2012.01.035
- Read, P., Fernandes, T., 2003. Management of environmental impacts of marine aquaculture in Europe. *Aquaculture* 226, 139–163. doi:10.1016/S0044-8486(03)00474-5
- Santos, G. A, Schrama, J.W., Capelle, J., Rombout, J.H.W.M., Verreth, J. A J., 2013. Effects of dissolved carbon dioxide on energy metabolism and stress responses in European seabass (*Dicentrarchus labrax*). *Aquac. Res.* 44, 1370–1382. doi:10.1111/j.1365-2109.2012.03142.x
- Schram, E., Roques, J.A.C., van Kuijk, T., Abbink, W., van de Heul, J., de Vries, P., Bierman, S., van de Vis, H., Flik, G., 2013. The impact of elevated water ammonia and nitrate concentrations on physiology, growth and feed intake of pikeperch (*Sander lucioperca*). *Aquaculture* 420–421, 95–104. doi:10.1016/j.aquaculture.2013.10.027
- Slater, M., D’Abramo, L., Engle, C.R., 2018. Aquaculture Research Priorities for the Next Decade: A Global Perspective. *J. World Aquac. Soc.* 49, 3–6. doi:10.1111/jwas.12503
- Stiller, K.T., Moran, D., Vanselow, K.H., Marxen, K., Wuertz, S., Schulz, C., 2013. A novel

- respirometer for online detection of metabolites in aquaculture research: Evaluation and first applications. *Aquac. Eng.* 55, 23–31. doi:10.1016/j.aquaeng.2013.01.004
- Stiller, K.T., Vanselow, K.H., Moran, D., Bojens, G., Voigt, W., Meyer, S., Schulz, C., 2015. The effect of carbon dioxide on growth and metabolism in juvenile turbot *Scophthalmus maximus* L. *Aquaculture* 444, 143–150. doi:10.1016/j.aquaculture.2015.04.001
- Thorarensen, H., Imsland, A.K.D., Gústavsson, A., Gunnarsson, S., Árnasond, J., Steinarsson, A., Bouwmans, J., Receveur, L., Björnsdóttir, R., 2018. Potential interactive effects of ammonia and CO₂ on growth performance and feed utilization in juvenile Atlantic cod (*Gadus morhua* L.). *Aquaculture* 484, 272–276. doi:10.1016/j.aquaculture.2017.11.040
- Timmons, M., Ebeling, J., 2007. *Recirculating Aquaculture*, NRAC Publication No. 01-007. Cayuga Aqua Ventures, Ithaca.
- Torno, J., Einwächter, V., Schroeder, J.P., Schulz, C., 2018. Nitrate has a low impact on performance parameters and health status of on-growing European sea bass (*Dicentrarchus labrax*) reared in RAS. *Aquaculture* 489, 21–27. doi:10.1016/j.aquaculture.2018.01.043
- Trabelsi, A., Gardeur, J.N., Teletchea, F., Fontaine, P., 2011. Effects of 12 factors on burbot *Lota lota* (L., 1758) weaning performances using fractional factorial design experiment. *Aquaculture* 316, 104–110. doi:10.1016/j.aquaculture.2011.03.027
- van Bussel, C.G.J., Schroeder, J.P., Wuertz, S., Schulz, C., 2012. The chronic effect of nitrate on production performance and health status of juvenile turbot (*Psetta maxima*). *Aquaculture* 326–329, 163–167. doi:10.1016/j.aquaculture.2011.11.019
- Weatherley, A., 1990. Approaches to Understanding Fish Growth. *Trans. Am. Fish. Soc.* 119, 662–672. doi:http://dx.doi.org/10.1577/1548-8659(1990)119<0662:ATUFG>2.3.CO;2
- Weaver, D., Keane, P., Francis, M., Williamson, J., True, C., 2016. Towards Zero Discharge: Denitrification and Refractory Organic Cleanup, in: 11th International Conference on Recirculating Aquaculture. Roanoke, pp. 45–46.
- Wuertz, S., Schulze, S.G.E., Eberhardt, U., Schulz, C., Schroeder, J.P., 2013. Acute and chronic nitrite toxicity in juvenile pike-perch (*Sander lucioperca*) and its compensation by chloride. *Comp. Biochem. Physiol. C. Toxicol. Pharmacol.* 157, 352–60. doi:10.1016/j.cbpc.2013.01.002

**THE EFFECT OF CARBON DIOXIDE ON
GROWTH AND ENERGY METABOLISM IN
PIKEPERCH (*Sander lucioperca*)**

**Kathrin Steinberg*^{1,2}, Jan Zimmermann^{1,2}, Kevin Torben Stiller^{1,2,3}, Stefan Meyer⁴,
Carsten Schulz^{1,2}**

¹Gesellschaft für marine Aquakultur mbH, Hafentörn 3, 25761 Büsum, Germany

²Institute of Animal Breeding and Husbandry, Marine Aquaculture, Christian-Albrechts-Universität zu Kiel, Olshausenstraße 40, 24098 Kiel, Germany

³Forschungs- und Technologiezentrum Westküste, Christian-Albrechts-Universität zu Kiel, Hafentörn 1, 25761 Büsum

⁴Landwirtschaftskammer Schleswig-Holstein, Grüner Kamp 15-17, 24768 Rendsburg, Germany

Published in *Aquaculture* 481 (2017) 162 – 168,

doi: 10.1016/j.aquaculture.2017.09.003

Abstract

Pikeperch (*Sander lucioperca*) is a popular fish for human consumption and decreasing wild catches increase the demand for aquaculture production. Limited knowledge of the species' requirements under intense recirculating aquaculture system (RAS) culture conditions has motivated this study to focus on the effect of elevated carbon dioxide (CO₂) levels on pikeperch metabolism. The trial was conducted in a recirculating aquaculture respirometer system with pikeperch (average body weight 251.9 g) and three hypercapnia regimes over 58 feeding days. Food grade CO₂ gas was gradually added to the medium (15 mg L⁻¹) and high (30 mg L⁻¹) treatments while no gas was added to the low treatment (hence 4 mg L⁻¹). Fish were fed daily for 10 minutes with a commercial diet (ALLER Metabolica). O₂, T, pH, CO₂ were measured individually for each tank and logged every two hours to calculate oxygen consumption rates of each treatment. Total Ammonia-Nitrogen (TAN) was measured monthly for individual tanks and used to calculate TAN excretion. Results showed a linear decrease of 6% in final body weight with increasing CO₂ levels between the low and the high CO₂ treatment. Feed intake was linearly decreased after four weeks of the experiment from 0.97 ± 0.07% in the low CO₂ treatment to 0.86 ± 0.03% in the high CO₂ treatment but the effect faded after eight weeks, indicating a habituation to the hypercapnia conditions. High levels of CO₂ were associated with reductions in haematocrit and metabolic oxygen consumption. The results suggest that adult pikeperch can survive carbon dioxide concentrations of up to 30 mg L⁻¹ when other water quality parameters are in acceptable levels but will be affected in metabolism already at moderate CO₂ levels of 15 mg L⁻¹.

Keywords: *carbon dioxide, hypercapnia, pikeperch, metabolism, recirculating aquaculture, growth*

Introduction

Pikeperch (*Sander lucioperca*) is a popular fish for human consumption due to its mild taste and appealing texture. Supply is currently sustained mainly by fisheries or extensive pond aquaculture in Central and Eastern Europe. Decreasing wild catches and increasing demand have raised commercial interest in intensified aquaculture production in recirculating aquaculture system (RAS) farms throughout Central Europe. Along with this trend, RAS-production of pikeperch has increasingly become the subject of research on water quality requirements, growth physiology, nutritional requirements and stress physiology (Dalsgaard et al., 2013; Hermelink et al., 2013; Müller-Belecke and Zienert, 2008; Wuertz et al., 2012).

The concentration of carbon dioxide (CO₂) in pure water is around 0.59 mg L⁻¹ under normal conditions (20°C, 1 atm) but in intensive aquaculture systems CO₂ reaches concentrations that are more than 20 to 100 times higher (Timmons and Ebeling, 2007). CO₂ as an end product of the aerobic metabolism is excreted through the gills of the fish (Randall and Daxboeck, 1984). In RAS additional CO₂ is released by nitrification and denitrification bioreactors, where the reaction of free acids and bicarbonate or the anaerobic digestion of an organic carbon source, such as molasses, methanol or fish sludge, results in a net increase of CO₂ (Summerfelt and Sharrer, 2004; Timmons and Ebeling, 2007; Yogev et al., 2017). Combined with low water exchange rates in RAS this results in concentrations above atmospheric CO₂ levels, which can reach critical thresholds affecting fish performance and welfare.

Increased levels of CO₂ in the water can impair the CO₂ excretion of the fish, thus resulting in respiratory acidosis (Timmons and Ebeling, 2007). Fish have the ability to compensate acute hypercapnia by acid base regulations in the gills but those compensations have been linked to behavioural changes (Claiborne et al., 2002; Domenici et al., 2012; Heuer and Grosell, 2014). Research on chronic hypercapnia (up to 42 mg CO₂ L⁻¹) effects on Atlantic Salmon (*Salmo salar*), turbot (*Psetta maxima*) and Arctic charr (*Salvelinus alpinus*) suggested increased FCR and prevalence of nephrocalcinosis, decreased growth rate, feed intake, condition factor and oxygen consumption. Furthermore, adverse changes in metabolism and brain function with effects already showing at CO₂ concentrations of 26 mg L⁻¹ could be observed (Domenici et al., 2012; Fivelstad, 2013; Fivelstad et al., 1998; Musa, 2013; Stiller et al.,

2015). Physiological reasons for reduced growth in response to increased CO₂ levels are poorly understood. Research suggests that freshwater fish can cope with higher CO₂ concentrations of 100-200 mg L⁻¹ on a short term basis but research on long term effects on freshwater fish is scarce (Basu, 1959). It is furthermore assumed that warm water freshwater fish are more tolerant to higher CO₂ levels than cold water freshwater or marine species (Colt, 2006).

In order to adequately address species-specific impacts of dissolved CO₂ and carbonate chemistry under intense RAS conditions, the present study focusses on the impact of three levels of dissolved CO₂ relevant to RAS on welfare, growth performance, health factors and energy metabolism of pikeperch. We attempt to evaluate protein catabolism rates in order to gain detailed insights on the energy metabolism in hypercapnia conditions (Gnaiger, 1983). The respirometer allows in-depth evaluation of ammonia excretion and oxygen consumption under intensive RAS conditions in order to receive insights in the changes of energy metabolism of pikeperch caused by long-term exposure to elevated CO₂ levels. We hypothesized that pikeperch can survive CO₂ levels of up to 30 mg L⁻¹ while common commercial CO₂ levels of 15 mg L⁻¹ already result in growth reduction due to changes in energy metabolism.

Material and methods

Fish husbandry and respirometer system

The trial was performed at the Gesellschaft für Marine Aquakultur (GMA) in Büsum, Germany and approved by the ethics commission of the Christian-Albrechts Universität zu Kiel. Pikeperch (*Sander lucioperca*) were obtained from Fischzucht Rietschen (Rietschen, Germany) and were held in a separate RAS system for one month before being transferred to the respirometer system for acclimation. The fish were accustomed to the experimental conditions in the respiratory tanks over a period of 2 weeks.

The trial was conducted in a recirculating aquaculture respirometer system (RARS) as described in detail by Stiller et al. (2013). The systems consisted of 10 tanks (volume of 250 L each), one of which contained no fish. The RARS (4 m³ total volume) had its own water treatment system consisting of a trickling biofilter, a particle filter and a sedimentation unit. Water exchange rates in the tanks were set at 300 L h⁻¹. Oxygen

(O₂) concentration (oxygen optode 4330, Serial No. 1557, Aandera data instruments, Bergen, Norway), temperature (compensation thermometer Type 201085), pH (pH_{NBS} intermediate junction electrode, Ionode IJ44, TPS Pty Ltd, Brisbane, Australia) and dissolved carbon dioxide (purpose built flow through headspace analyser, MK-2 pCO₂ / Fast Analyser (SubCtech GmbH, Kiel, Germany) with non-dispersive infrared detection, LI-840A (LI-COR Biosciences, Nebraska, United States)) were measured online every 12 min in each tank. Total ammonia-nitrogen was measured monthly in each tank, over a period of 24 hours (TAN, loop flow orthophtalaldehyde fluorometric autoanalyser, µMac, SYSTEA S.p.A., Anagni, Italy). Nitrite was measured daily using a colour indicator quick test (MColortest™, Merck KGaA, Darmstadt, Germany). Turbidity was measured daily with a turbidity meter (PCE-TUM 20, PCE GmbH, Meschede, Germany). Alkalinity and nitrate were determined weekly via titration and spectrophotometrically with a HACH-DR 2800 spectrophotometer and powder pillow quick test kit (Hach Lange GmbH, Berlin, Germany) respectively.

Ten fish with an average weight of 251.9 g (190.0 g – 308.3 g) were stocked into nine respiratory tanks. Stocking density was 10 kg m⁻³ at the start of the experiment. The RARS cannot be used for higher stocking densities as the nature of the system does not allow technical oxygen supply. Fish were fed every morning until apparent satiation, each tank for a maximum of 10 minutes, with a commercial diet (ALLER Metabolica 6mm, ALLER Aqua, Christiansfeld, Denmark, macro nutrient profile: moisture 7% crude protein 50%, crude fat 15%, ash 8%, nitrogen-free extractives 20%, energy: 21.3 g MJ kg⁻¹). Uneaten pellets were removed from the tanks, collected and the equivalent weight was subtracted from the presented feed to calculate the daily feed intake (DFI). Settled solids were removed from the tanks daily before feeding. The fish were kept at constant dim light for a total period of 58 feeding days.

CO₂ dosing

The nine fish tanks of the RARS were used to test three different hypercapnia regimes in triplicates while tank number 10 was used as a reference tank and therefore kept empty of fish. Food grade CO₂ was added to the medium and high hypercapnia level tanks using ceramic diffusers (MBD075, Point Four Systems Inc., Canada) while no CO₂ gas was added to three tanks to represent the low hypercapnia regime. Additional air diffusers were installed in the pump sum to increase the CO₂ stripping efficiency of the

system. The CO₂ dosing was gradually increased during the two weeks acclimation period up to $\approx 19000 \mu\text{atm} / 30 \text{ mg L}^{-1}$ (high) and $\approx 9500 \mu\text{atm} / 15 \text{ mg L}^{-1}$ (medium). The lowest possible CO₂ concentration was maintained at $\approx 2600 \mu\text{atm} / 4 \text{ mg L}^{-1}$ (low).

Condition factors, growth performance and body composition

Individual body wet weight (g) and length (cm) of three individuals per tank and wet fish group weight (kg) were determined at the start (day 0), middle (day 28) and the end (day 58) of the experiment. The specific growth rate (SGR [% BW day⁻¹]) for each tank was calculated as $\text{SGR} = (\ln(\text{final biomass}) - \ln(\text{initial biomass})) / (\text{number of feeding days}) \times 100$. The feed conversion ratio (FCR) was calculated using the formula $\text{FCR} = (\text{feed intake}) / (\text{weight gain})$. Daily feed intake (DFI [% BW day⁻¹]) was calculated as $\text{DFI} = \text{SGR} \times \text{FCR}$. The condition factor (cf [g cm⁻³]) was calculated using Fulton's formula as described in Ricker (1975) as $\text{cf} = (\text{fish weight} \times 100) / \text{fish length}^3$. At the start, middle and end of the experiment three fish per tank were euthanized and blood was taken from the caudal vein with a heparinised syringe to evaluate haematocrit (210 centrifuge, Hettich, Tuttlingen, Germany, 40.000g, 4 min). Furthermore, liver and spleen were removed from these fish and measured on a precision scale to the nearest 0.1 mg wet weight. Hepatosomatic index (HSI) and spleen index (SI) were calculated as $\text{HSI} = (\text{liver weight} / \text{final fish weight}) \times 100$ and $\text{SI} = (\text{spleen weight} / \text{final fish weight}) \times 100$. The eyes of the fish were checked for cataracts using a flourometric dye and gill and kidney samples were dissected for histological analyses. Histological samples were fixed in 10% phosphate buffered formalin and further processed by the veterinary clinic for histopathology Goettingen. Analysis was carried out with an Olympus CKX 41 microscope. Additionally three fish per tank were randomly selected for the analysis of the whole body composition both at the beginning and the end of the experiment. Fish were therefore freeze dried and homogenized before the analysis (dry matter, crude protein, crude fat, crude ash and gross energy) according to EU guideline (EC) 152/2009. Dry matter was determined after drying at 103°C and ash content was weighted following 4 h at 550°C. Kjeldahl method (InKjel 1225 M, WD 30; Behr, Dusseldorf, Germany) was used to determine the crude protein content and crude fat content was determined via HCl hydrolysis followed by extraction using petroleum ether with a Soxhlet extraction system (R 106 S; Behr). A bomb calorimeter (C200, IKA, Staufen, Germany) was used to determine the gross energy content.

Metabolic data

Metabolic oxygen consumption (MOCR) and total ammonia nitrogen (TAN) excretion were calculated based on the O₂ or TAN concentration in the tank divided by number of fish and the difference to the reference tank. The values were then corrected to account for the washout effect according to Stiller et al. (2013). The fish weights were normalized to a daily calculated metabolic body weight where the common metabolic weight exponent for energy of 0.8 was applied (Clarke and Johnston, 1999). The ammonia quotient (AQ) was calculated from the metabolic oxygen consumption rate of an individual fish and the metabolic TAN excretion rates to estimate the degree of protein utilisation for energy metabolism. Values of 0.27 correspond to 100% protein utilisation (Gnaiger, 1983). The AQ data were calculated based on 24 hour measurements of O₂ and TAN. Protein productive value (PPV) was calculated based on the whole body analysis as $100 \times (\text{final body protein} - \text{initial body protein}) / \text{fed protein}$ to evaluate the percentage of protein retained in the fish.

Energy budgets

Energy budgets were calculated at day 28 of the experiment. Gross energy intake (GEI) was calculated as the product of gross energy of diets and feed intake divided by the metabolic body weight. Results of a previous experiment (unpublished results, data not shown) with different feed ingredients determined the average digestible energy of the different diets at 89.1% and this value was used to calculate digestible energy intake (DEI) as the product of the digestible energy of the diet and the feed intake divided by the metabolic body weight. The energy of non-faecal N (E_N) was calculated as the energy of excreted nitrogen divided by the metabolic body weight. It was assumed that pikeperch excrete 15% of N as urea and 85% as ammonia as most teleost fish generally excrete 10-20% of N as urea (Jobling, 1994; Wright and Anderson, 2001). Energetic equivalents of 24.9 kJ g⁻¹ for ammonia-N and 23.0 kJ g⁻¹ for urea-N were used for the calculation of the energy of excreted protein (Elliott and Davison, 1975). The metabolisable energy intake (MEI) was calculated as the difference between DEI and E_N. The percentage of GEI available in form of metabolisable energy was calculated for comparative purposes as $\text{MEI} \times 100 / \text{GEI}$. The retained energy (RE) was calculated as MEI minus heat, based on the simplification that all oxygen consumed was lost as heat

with an energy equivalent of 13.6 kJ per g O₂ (Elliott and Davison, 1975). The percentage of GEI retained in the fish was calculated for comparative purposes as $RE \times 100 / GEI$.

Statistics

Statistical analysis of all data was conducted using the Software IBM SPSS 20 (SPSS, Ing., Chicago, USA). All data was tested for normal distribution (Kolmogoroff Smirnov test) and homogeneity of variance (Levene's test) followed by a one-way analysis of variance (ANOVA) and a parametric post-hoc test (Tukey HSD test) or Kruskal-Wallis Anova in case of non-normal distribution or non-homogeneity of variance. Differences were considered significant at $p \leq 0.05$. Linear regressions were applied to CO₂ and MBW specific data in order to evaluate dose respondent trends ($p \leq 0.05$).

Results

Water parameters

Water quality parameters were maintained at safe levels throughout the experiments with the exception of CO₂ as intended by treatment. Temperature was kept above 23°C to allow for high growth rate. Turbidity (1.49 ± 0.84 NTU) and nitrite were measured daily (0.17 ± 0.08 mg L⁻¹) and nitrate was measured biweekly (6.4 ± 0.7 mg L⁻¹). Results of water chemistry analysis are shown in Table 1-1. CO₂, temperature and pH were within acceptable ranges and total alkalinity was 2.72 ± 0.03 mmol kg water⁻¹. Individual measurements of alkalinity in each tank did not show any differences between treatments; therefore water samples were pooled together.

Table 1-1 Average water chemistry parameters (mean \pm SD) in each of the three CO₂ treatment groups. Provided are averages of repeated measurements in the outflow of three replicates.

		Low CO ₂	Medium CO ₂	High CO ₂
dissolved CO ₂	[μ atm]	2779 \pm 332	9319 \pm 766	18836 \pm 699
dissolved CO ₂	[mg L ⁻¹]	4.38 \pm 0.52	14.67 \pm 0.73	29.65 \pm 0.82
pH		7.19 \pm 0.09	6.68 \pm 0.07	6.38 \pm 0.07
temperature	[°C]	23.1 \pm 0.2	23.1 \pm 0.2	23.1 \pm 0.2

Values are mean \pm SD; Total alkalinity in the RAS pump sump was 2.72 ± 0.03 mmol kg water⁻¹.

Growth and Condition

There were no mortalities in the low and medium CO₂ treatment while one fish died in the high CO₂ group after four weeks. Fish in the low CO₂ treatment increased their body weight in average by 77%, fish in the medium and high CO₂ treatment grew 73% and 67% in average, respectively (Table 1-2). A significant negative linear correlation between hypercapnia regime and average individual body weight at the end of the experiment was found (Fig. 1-1).

Table 1-2 Comparison of growth and condition variables of pikeperch reared for 58 days under three different dissolved CO₂ conditions.

		Low CO ₂	Medium CO ₂	High CO ₂
start biomass	[g]	252.71 ± 0.75	251.89 ± 2.33	251.11 ± 1.35
end biomass	[g]	446.67 ± 17.22	435.24 ± 17.46	420.00 ± 7.56
weight gain	[%]	76.76 ± 7.33	72.75 ± 5.32	67.26 ± 3.29
FCR		1.04 ± 0.05	1.14 ± 0.04	1.13 ± 0.07
DFI	[% BW day ⁻¹]	0.92 ± 0.06	0.98 ± 0.12	0.88 ± 0.04
SGR	[% BW day ⁻¹]	0.89 ± 0.09	0.86 ± 0.08	0.78 ± 0.06

Values are mean ± SD, FCR: feed conversion ration; DFI: daily feed intake; SGR: specific growth rate

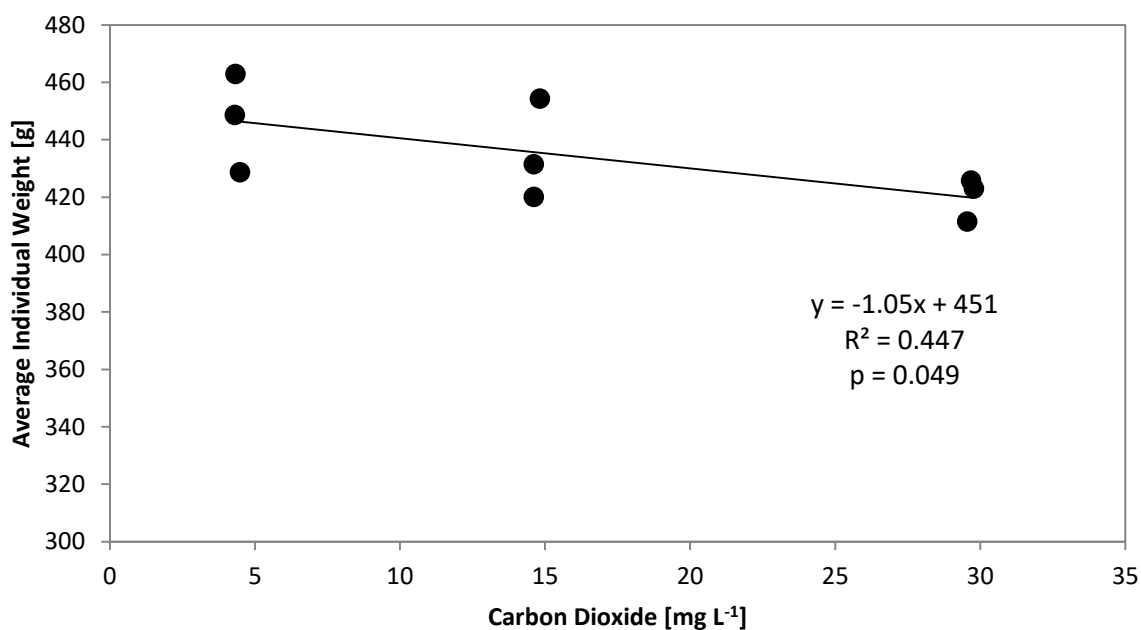

Figure 1-1 Average individual end (wet) weight of pikeperch after 58 feeding days reared under three different dissolved CO₂ conditions.

Condition factor (cf), spleen index (SI) and the hepatosomatic index (HSI) are shown in Table 1-3. Results for cf showed a slight but not significant linear decrease with increasing CO₂ level. SI and HSI did not show significant differences between the treatments. The average SI over all treatments decreased significantly from 0.084 on day 0 to an average of 0.062. The calculation of the HSI showed no significant results. Few cataracts were found in all three groups with no significant differences and histology did not show any differences in calcification of gills and kidneys. Haematocrit (Hct) showed a linearly decrease with increasing CO₂ level at the end of the experiment ($p = 0.05$). There was a linearly increase of Hct over time among all groups from an average of $29 \pm 2\%$ at the start of the experiment to $38 \pm 8\%$ at the end of the experiment (Table 1-3).

Table 1-3 Body composition [% of original substance] and gross energy contents of whole pikeperch reared under three different dissolved CO₂ conditions: low, medium and high.

		n	Low CO ₂	Medium CO ₂	High CO ₂
dry matter	[%]	3	29.1 ± 1.00	29.4 ± 1.2	29.7 ± 1.6
crude protein	[%]	3	18.2 ± 0.1	18.3 ± 0.3	18.1 ± 0.2
crude fat	[%]	3	6.6 ± 0.9	6.5 ± 1.5	7.0 ± 1.8
total KOH	[%]	3	0.00 ± 0.00	< 0.1 ± 0.0	0.1 ± 0.2
crude ash	[%]	3	4.3 ± 0.1	4.6 ± 0.2	4.5 ± 0.4
Energy	[MJ kg ⁻¹]	3	6.9 ± 0.3	7.0 ± 0.6	7.0 ± 0.7
CF		18	0.90 ± 0.12	0.93 ± 0.11	0.88 ± 0.13
HSI	[% BW]	9	0.90 ± 0.13	0.99 ± 0.28	0.93 ± 0.25
SI	[% BW]	9	0.06 ± 0.02	0.07 ± 0.03	0.05 ± 0.02
Hct	[%]	9	43 ± 6 ^a	36 ± 7 ^b	35 ± 9 ^c

Values are mean ± SD, CF = Fulton's Condition Factor; HSI = hepatosomatic index; SI = spleen index; Hct = Haematocrit. Start values (n = 1) were dry matter 28.7%, crude protein 18.8%, crude fat 4.6%, total KOH 0.00%, crude ash 5.3%, energy 6.1 MJ kg⁻¹, CF (n = 13) 0.76 ± 0.13, HSI (n = 10) 0.81 ± 0.36, SI (n = 10) 0.08 ± 0.03, Hct (n = 5) 29 ± 2 Superscript letters indicate linear correlations ($p \leq 0.05$).

Body Composition

The analysis of whole body composition showed no significant differences between the treatments. Average ash and protein content of all treatments decreased significantly while lipid and energy content increased significantly compared to the start of the experiment (Table 1-3).

Feed intake and conversion

The daily feed intake after four weeks showed a linearly decrease with increasing CO₂ level from $0.97 \pm 0.07\%$ BW in the low CO₂ treatment to $0.92 \pm 0.08\%$ and $0.86 \pm 0.03\%$ in the medium and high CO₂ treatment respectively. The effects faded after eight weeks where DFI fluctuated in all tanks and showed no clear dose dependent trend with an average of $0.93 \pm 0.08\%$. FCR was numerically lowest for the low hypercapnia regime at 1.04 but showed no linear correlations. SGR showed a decreasing trend ($p = 0.09$) with increasing CO₂ levels from $0.89 \pm 0.09\%$ in the low CO₂ treatment to $0.78 \pm 0.06\%$ in the high CO₂ treatment (Table 1-2).

Energy budgets

There was no statistically significant difference in GEI, DEI, MEI, E_N, and RE after four weeks between any of the three treatments. Heat production was reduced linearly with increasing CO₂ levels ($p = 0.046$). An average of $86.21 \pm 0.36\%$ of the GEI was available to the fish as MEI within all treatments and an average of $68.68 \pm 2.34\%$ of energy remained in the fish. There were no statistically significant differences between the CO₂ treatments. Detailed energy budgets are given in Table 1-4.

Table 1-4 Energy budgets of pikeperch reared under three different dissolved CO₂ conditions after four weeks of treatment.

		Low CO ₂	Medium CO ₂	High CO ₂	<i>p</i> -value (lin.)
GEI	[kJ kg ^{-0.8} day ⁻¹]	157.9 ± 17.2	176.0 ± 23.4	146.1 ± 3.7	n.s.
DEI	[kJ kg ^{-0.8} day ⁻¹]	140.7 ± 15.3	156.8 ± 20.9	130.2 ± 3.3	n.s.
E _N	[kJ kg ^{-0.8} day ⁻¹]	4.57 ± 0.24	5.10 ± 0.82	4.29 ± 0.88	n.s.
MEI	[kJ kg ^{-0.8} day ⁻¹]	136.1 ± 15.2	151.7 ± 20.1	125.9 ± 3.8	n.s.
heat	[kJ kg ^{-0.8} day ⁻¹]	29.14 ± 1.23	29.10 ± 1.08	25.24 ± 3.15	0.046
RE	[kJ kg ^{-0.8} day ⁻¹]	107.0 ± 15.9	122.6 ± 19.0	100.6 ± 5.3	n.s.
MEI	[% of GEI]	86.2 ± 0.2	86.2 ± 0.2	86.2 ± 0.6	n.s.
RE	[% of GEI]	67.6 ± 2.9	69.6 ± 1.6	68.9 ± 2.8	n.s.
MOCR	[mg kg ^{-0.8} h]	89.29 ± 3.78	89.14 ± 3.30	77.33 ± 9.65	0.046
PPV	[%]	32.2 ± 3.3	32.2 ± 4.4	30.2 ± 1.8	n.s.

Values are mean ± SD, each sample (n) consists of 3 tanks. GEI: gross energy intake; DEI: digestible energy intake; E_N: Energy of non-faecal nitrogen; MEI: metabolisable energy intake; heat: energy lost as heat; RE: retained energy; MOCR: metabolic oxygen consumption rate; PPV: protein productive value

Metabolic data

The oxygen consumption rate was standardized to the metabolic weight of one fish on the day of measurement to derive the standardized metabolic oxygen consumption rate (MOCR) and showed a linear dose dependent decrease ($p = 0.046$). Detailed results are shown in Table 1-4. The relative protein usage on day 28 was calculated as the ammonia quotient (AQ) based on the metabolic ammonia excretion and the metabolic oxygen consumption of an individual fish to account for growth differences. The average relative protein usage for the low CO₂ group was 61% and 64% and 62% for the medium and high group respectively. Results are given in Fig. 1-2. The protein productive value was calculated based on the protein concentration in the whole fish and the protein intake over the whole experiment. The average PPV of the low and medium CO₂ group was 32% and 30% for the high CO₂ group (Table 1-4).

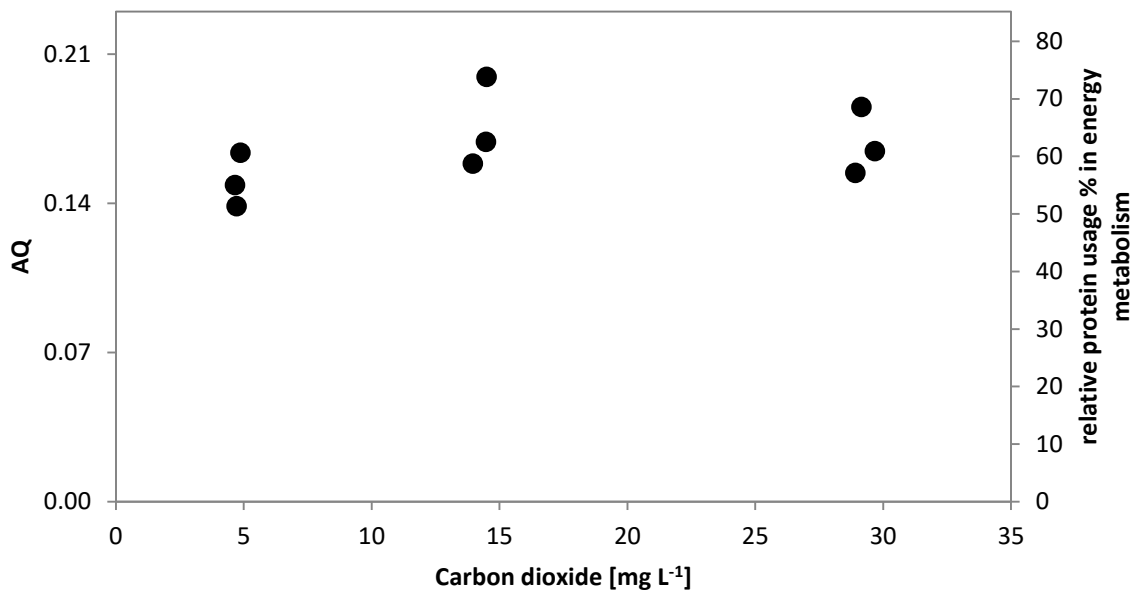

Figure 1-2 Ammonia quotient (AQ) measurements on week 4 of pikeperch reared under three different hypercapnia conditions as a function of the mean carbon dioxide concentration.

Discussion

The aim of the study was to investigate the long-term effects of elevated water CO₂ concentrations commonly found in commercial RAS on adult pikeperch. The use of the respirometer system provided the opportunity not only to compare general growth and condition parameters but also to investigate the effect on energy budget and metabolism. The constant online determination of other water parameters such as

temperature, and oxygen saturation as well as the daily measurement of nitrite made it possible to state that all other relevant water parameters were kept at a constant level thus reducing the impact factor to CO₂ and pH. Nitrate concentrations were kept well below negative effect levels throughout the experiment (Schram et al., 2013).

According to Fulton's condition factor (cf) the condition of the pikeperch in this experiment were low at the start (0.76) but increased during the course of the experiment to 0.90. Research on adult pikeperch in lakes suggest that cf can easily be above 1.20 but research on juvenile pikeperch in RAS showed similar results as this trial with conditions factors around 0.7 and 0.9 (Kangur and Kangur, 1996; Luchiari et al., 2009; Schulz et al., 2006). Trials conducted with the closely related walleye (*Sander vitreus*) of a similar size showed a cf of 1.02 for fish fed with a fishmeal based diet (Davidson et al., 2016). Results of cf and the FCR of 1.04 for the low CO₂ treatment indicate that the general water parameters, handling and stocking densities were appropriate for pikeperch in RAS where FCR is typically around 1-1.5 for larger fish (FAO, 2012). It has to be kept in mind that pikeperch in this trial could only be fed once a day due to the maintenance requirements of the RARS accompanied with feeding events. This could have had a slight effect on the cf and FCR and explain the differences with wild stocks and commercial production. The mortality rate of this study was low with only one mortality in the high CO₂ treatment after four weeks.

The objective of the study was the evaluation of CO₂ levels frequently present in commercial pikeperch farms and the effect on growth, feed intake and energy metabolism. The linearly relationship between the individual end weight and the changes in FCR over time indicate that CO₂ levels had an impact on appetite and thus influenced growth rates. This effect was more obvious after four weeks of the experiment where DFI decreased linearly with increasing CO₂ levels thus indicating a habituation effect. Several studies have found decreased feed intake or appetite and increased FCR with higher CO₂ concentrations in other species, even though the mechanisms causing the effect are not yet fully understood (Fivelstad et al., 2007; Ishimatsu et al., 2008; Musa, 2013; Santos et al., 2013; Smart et al., 1979). Research on eel suggests that high CO₂ impacts the appetite of the fish by suppressing the responses of taste nerves (Yoshii and Yotsui, 1997). Other possible explanations are that the reduction in blood oxygen carrying capacity has direct effects on digestion thus

decreasing ingestion (Stiller et al., 2015). Carbon dioxide in the water diffuses across the gill epithelium which causes a decline in the oxygen carrying capacity of the blood, thus directly impacting the oxygen consumption rate (Eddy et al., 1977; Heisler, 1984). Fish in the high CO₂ treatment had the lowest metabolic oxygen consumption rates (MOCR) which increased linearly with decreasing CO₂ concentrations. This is likely to have direct impact on feed intake and fish well-being and can be an explanation for the lower individual end weight of fish in the high CO₂ treatment.

Haematocrit levels showed a linearly decrease with increasing CO₂ levels and decreased linearly over time in all experimental groups. Similar reductions in haematocrit were also found in Atlantic salmon (Fivelstad et al., 1998). Carbon dioxide has been found to deoxygenate haemoglobin in human blood cells and shrink erythrocytes (Fivelstad et al., 2007; Zapulla, 2008). Differences in haematocrit between treatments were bigger after four weeks but converged after eight weeks, leading to the suggestion that the fish are able to compensate the effect of CO₂ on erythrocytes after several weeks.

Most research on the effects of hypercapnia on fish has been focused on growth parameters but some studies have already investigated the effects on oxygen consumption and ammonia excretion often showing a change in protein metabolism with an increased protein catabolism and a reduction in protein anabolism (Methling et al., 2013). Extensive research on *Sipunculus nudus*, an unsegmented marine worm, has shown that hypercapnia leads to changes in the use of amino acids in the metabolism and reduces the biosynthesis of protein (Langenbuch and Pörtner, 2002). Results of several studies suggest that CO₂ acidification affects energetically costly processes, such as protein biosynthesis (Langenbuch and Pörtner, 2003; Methling et al., 2013). These findings could not be verified for pikeperch in this study, although AQ was numerically lowest for the low CO₂ treatment there were no statistically significant differences thus no measurable effect of CO₂ on the protein metabolism of pikeperch. Due to technical difficulties AQ could only be calculated after four weeks of the experiment but the calculation of PPV on the last day of the experiment showed similar results. While AQ is used to calculate the relative protein usage for energy metabolism, PPV is used to calculate the percentage of protein retained in the fish, thus protein not used for energy metabolism. PPV results of the present study showed

no significant differences between the treatments. Results for energy budgets support the finding that CO₂ levels up to 30 mg L⁻¹ have a direct effect on appetite and oxygen consumption but not on other parts of metabolism of pikeperch as the same percentage of energy, an average of 68%, is retained within the fish for all three treatments. The percentages of energy retained in the fish was higher compared to trials on other species such as rainbow trout (up to 59%, depending on the diet), European seabass (45% with 7 mg L⁻¹ CO₂) or turbot (up to 62% under the highest feeding level), suggesting that pikeperch in this experiment maintained a favourable energy metabolism (Dietz et al., 2013; Santos et al., 2013; Saravanan et al., 2013). The average HSI of 0.95 ± 0.24 lies within the results that other studies found for pellet fed pikeperch, thus indicating that the fish were neither fatty nor malnourished (Akther, 2015). This assumption is further supported by the stable body composition of fish in all three experimental groups.

The results of this trial suggest that adult pikeperch can tolerate carbon dioxide concentrations of up to 30 mg L⁻¹ when other water parameters are in acceptable levels but lower levels are favourable to increase feed intake and growth rates. The increase of CO₂ in the tanks inevitably led to a decrease of pH. This change was not compensated and has therefore to be taken into account as well. A recent fractional factorial design experiment on pikeperch showed that different factors can have changing effects on the fish, depending on the combination of other factors involved (Teletchea et al., 2009). Interactions of coping mechanisms of pikeperch with CO₂ with other environmental parameters cannot be excluded. The linear correlation between CO₂ concentration and MOCR suggests that the effects of CO₂ on the metabolism of pikeperch are likely to be intensified with increasing CO₂ levels. Nevertheless, higher levels of CO₂ than those investigated in the present study would not necessarily be of practical relevance for a commercial pikeperch RAS-rearing context. This research provides new data in terms of adaptive mechanisms of pikeperch to hypercapnia conditions as well as detailed baseline data on the energy metabolism of pikeperch. Knowledge about the reasons for changes in appetite with elevated CO₂ levels is currently insufficient and should be further investigated as a reduction in appetite has a direct effect on growth, thus impacting profitability of commercial RAS pikeperch farms.

Acknowledgements

We thank the Federal Ministry of Education and Research (Project number 031A290A) for funding the project. Thanks to the staff at the GMA for assistance during the experiment and Dr. Klaus Vanselow and Gero Bojens for the technical support with the RARS. Special thanks to Dmitry Pyanov and Anna Fickler for providing their results on the digestibility of pikeperch.

References

- Akther, M., 2015. The Impact of Maturation Diet on Pikeperch Reproduction. Universiteit Gent, Ghent.
- Basu, S.P., 1959. Active Respiration of Fish in Relation of Ambient Concentrations of Oxygen and Carbon Dioxide. *J. Fish. Res. Board Canada* 16, 175–212. doi:<https://doi.org/10.1139/f59-016>
- Claiborne, J.B., Edwards, S.L., Morrison-Shetlar, A.I., 2002. Acid-Base Regulation in Fishes: Cellular and Molecular Mechanisms. *J. Exp. Zool.* 293, 302–319. doi:10.1613/jair.301
- Clarke, A., Johnston, N.M., 1999. Scaling of metabolic rate with body mass and temperature in teleost fish. *J. Anim. Ecol.* 893–905.
- Colt, J., 2006. Water quality requirements for reuse systems. *Aquac. Eng.* 34, 143–156. doi:10.1016/j.aquaeng.2005.08.011
- Dalsgaard, J., Lund, I., Thorarinsdottir, R., Drengstig, A., Arvonen, K., Pedersen, P.B., 2013. Farming different species in RAS in Nordic countries: Current status and future perspectives. *Aquac. Eng.* 53, 2–13. doi:10.1016/j.aquaeng.2012.11.008
- Davidson, J., Summerfelt, R., Barrows, F., Gottsacker, B., Good, C., Fischer, G., Summerfelt, S., 2016. Walleye *Sander vitreus* performance, water quality, and waste production in replicated recirculation aquaculture systems when feeding a low phosphorus diet without fishmeal versus a traditional fishmeal-based diet. *Aquac. Eng.* 75, 1–13. doi:10.1016/j.aquaeng.2016.09.005
- Dietz, C., Stiller, K.T., Griese, M., Schulz, C., Susenbeth, A., 2013. Influence of salinity on energy metabolism in juvenile turbot, *Psetta maxima* (L.). *Aquac. Nutr.* 19, 135–150. doi:10.1111/anu.12034
- Domenici, P., Allan, B., McCormick, I., Munday, P.L., 2012. Elevated carbon dioxide affects behavioural lateralization in a coral reef fish. *Biol. Lett.* 8, 78–81.
- Eddy, F.B., Lomholt, J.P., Weber, R.E., Johansen, K., 1977. Blood respiratory properties of rainbow trout (*Salmo gairdneri*) kept in water of high CO₂ tension. *J. Exp. Biol.* 67, 37–47.

- Elliott, J.M., Davison, W., 1975. Energy equivalents of oxygen consumption in animal energetics. *Oecologia* 19, 195–201. doi:10.1007/BF00345305
- FAO, 2012. Cultured Aquatic Species Information Programme *Sander lucioperca* [WWW Document]. Text by Zakęś, Z. Cult. Aquat. Species Inf. Programme FAO Fisheries and Aquaculture Department, Rome online, Updated 1 January 2012
- Fivelstad, S., 2013. Long-term carbon dioxide experiments with salmonids. *Aquac. Eng.* 53, 40–48. doi:10.1016/j.aquaeng.2012.11.006
- Fivelstad, S., Haavik, H., Løvik, G., Olsen, A.B., 1998. Sublethal effects and safe levels of carbon dioxide in seawater for Atlantic salmon postsmolts (*Salmo Salar* L.): ion regulation and growth. *Aquaculture* 160, 305–316.
- Fivelstad, S., Waagbø, R., Stefansson, S., Olsen, A.B., 2007. Impacts of elevated water carbon dioxide partial pressure at two temperatures on Atlantic salmon (*Salmo salar* L.) parr growth and haematology. *Aquaculture* 269, 241–249. doi:10.1016/j.aquaculture.2007.05.039
- Gnaiger, E., 1983. Calculation of Energetic and Biochemical Equivalents of Respiratory Oxygen Consumption, in: *Polarographic Oxygen Sensors*. pp. 337–345.
- Heisler, N., 1984. Acid-base regulation in fishes, in: Hoar, W.S., Randall, D.J. (Eds.), *Fish Physiology*. Volume X Gills Part A. Academic Press, New York, pp. 315–400.
- Hermelink, B., Wuertz, S., Rennert, B., Kloas, W., Schulz, C., 2013. Temperature control of pikeperch (*Sander lucioperca*) maturation in recirculating aquaculture systems—induction of puberty and course of gametogenesis. *Aquaculture* 400–401, 36–45. doi:10.1016/j.aquaculture.2013.02.026
- Heuer, R.M., Grosell, M., 2014. Physiological impacts of elevated carbon dioxide and ocean acidification on fish. *Am. J. Physiol. Regul. Integr. Comp. Physiol.* in Press. doi:10.1152/ajpregu.00064.2014
- Ishimatsu, A., Hayashi, M., Kikkawa, T., 2008. Fishes in high-CO₂, acidified oceans. *Mar. Ecol. Prog. Ser.* 373, 295–302. doi:10.3354/meps07823
- Jobling, M. (Ed.), 1994. *Fish Bioenergetics*, 1st ed. Chapman & Hall Fish & Fisheries Series 13, London.
- Kangur, A., Kangur, P., 1996. The condition, length and age distribution of pikeperch, *Stizostedion lucioperca* (L.) in Lake Peipsi. *Hydrobiologia* 338, 179–183. doi:10.1007/BF00031722
- Langenbuch, M., Pörtner, H.O., 2003. Energy budget of hepatocytes from Antarctic fish (*Pachycara brachycephalum* and *Lepidonotothen kempfi*) as a function of ambient CO₂: pH-dependent limitations of cellular protein biosynthesis? *J. Exp. Biol.* 206, 3895–3903. doi:10.1242/jeb.00620
- Langenbuch, M., Pörtner, H.O., 2002. Changes in metabolic rate and N excretion in the

- marine invertebrate *Sipunculus nudus* under conditions of environmental hypercapnia : identifying effective acid – base variables. *J. Exp. Biol.* 205, 1153–1160.
- Luchiari, A.C., De Morais Freire, F. A., Pirhonen, J., Koskela, J., 2009. Longer wavelengths of light improve the growth, intake and feed efficiency of individually reared juvenile pikeperch *Sander lucioperca* (L.). *Aquac. Res.* 40, 880–886. doi:10.1111/j.1365-2109.2008.02160.x
- Methling, C., Pedersen, P.B., Steffensen, J.F., Skov, P. V., 2013. Hypercapnia adversely affects postprandial metabolism in the European eel (*Anguilla anguilla*). *Aquaculture* 416–417, 166–172. doi:10.1016/j.aquaculture.2013.09.014
- Müller-Belecke, A., Zienert, S., 2008. Out-of-season spawning of pike perch (*Sander lucioperca* L.) without the need for hormonal treatments. *Aquac. Res.* 39, 1279–1285. doi:10.1111/j.1365-2109.2008.01991.x
- Musa, S., 2013. The Effects of Oxygen Saturation and Carbon Dioxide Concentration on the Growth and Feed Conversion of Aquaculture Fish. United Nations University.
- Randall, D.J., Daxboeck, C., 1984. Oxygen and Carbon Dioxide Transfer Across Fish Gills, in: Hoar, W.S., Randall, D.J. (Eds.), *Fish Physiology*. Volume X Gills Part A. Academic Press, Inc, pp. 263–314.
- Ricker, W.E., 1975. Computation and Interpretation of Biological Statistics of Fish Populations, *Bulletin of the Fisheries Research Board of Canada*. Department of the Environment Fisheries and Marine Service, Ottawa. doi:10.1038/108070b0
- Santos, G. A, Schrama, J.W., Capelle, J., Rombout, J.H.W.M., Verreth, J. A J., 2013. Effects of dissolved carbon dioxide on energy metabolism and stress responses in European seabass (*Dicentrarchus labrax*). *Aquac. Res.* 44, 1370–1382. doi:10.1111/j.1365-2109.2012.03142.x
- Saravanan, S., Geurden, I., Figueiredo-Silva, A.C., Kaushik, S., Verreth, J., Schrama, J.W., 2013. Voluntary feed intake in rainbow trout is regulated by diet-induced differences in oxygen use. *J. Nutr.* 143, 781–7. doi:10.3945/jn.112.173062
- Schram, E., Roques, J. A. C., van Kuijk, T., Abbink, W., van de Heul, J., de Vries, P., Bierman, S., van de Vis, H., Flik, G., 2013. The impact of elevated water ammonia and nitrate concentrations on physiology, growth and feed intake of pikeperch (*Sander lucioperca*). *Aquaculture* 420–421, 95–104. doi:10.1016/j.aquaculture.2013.10.027
- Schulz, C., Günther, S., Wirth, M., Rennert, B., 2006. Growth performance and body composition of pike perch (*Sander lucioperca*) fed varying formulated and natural diets. *Aquac. Int.* 14, 577–586. doi:10.1007/s10499-006-9056-z
- Smart, G.R., Knox, D., Harrison, J.-G., Ralph, J. A, Richards, R.H., Cowey, C.B., 1979. Nephrocalcinosis in rainbow trout *Salmo gairdneri* Richardson ; the effect of

- exposure to elevated CO₂ concentrations. *J. Fish Dis.* 2, 279–289. doi:10.1111/j.1365-2761.1979.tb00170.x
- Stiller, K.T., Moran, D., Vanselow, K.H., Marxen, K., Wuertz, S., Schulz, C., 2013. A novel respirometer for online detection of metabolites in aquaculture research: Evaluation and first applications. *Aquac. Eng.* 55, 23–31. doi:10.1016/j.aquaeng.2013.01.004
- Stiller, K.T., Vanselow, K.H., Moran, D., Bojens, G., Voigt, W., Meyer, S., Schulz, C., 2015. The effect of carbon dioxide on growth and metabolism in juvenile turbot *Scophthalmus maximus* L. *Aquaculture* 444, 143–150. doi:10.1016/j.aquaculture.2015.04.001
- Summerfelt, S.T., Sharrer, M.J., 2004. Design implication of carbon dioxide production within biofilters contained in recirculating salmonid culture systems. *Aquac. Eng.* 32, 171–182. doi:10.1016/j.aquaeng.2004.03.006
- Teletchea, F., Gardeur, J.-N., Psenicka, M., Kaspar, V., Le Dore, Y., Linhart, O., Fontaine, P., 2009. Effects of four factors on the quality of male reproductive cycle in pikeperch *Sander lucioperca*. *Aquaculture* 291, 217–223. doi:10.1016/j.aquaculture.2009.03.029
- Timmons, M., Ebeling, J., 2007. *Recirculating Aquaculture*, NRAC Publication No 01-007. Cayuga Aqua Ventures, Ithaca.
- Wright, P., Anderson, P. (Eds.), 2001. *Nitrogen Excretion*. Academic Press, San Diego, London.
- Wuertz, S., Hermelink, B., Schulz, C., 2012. *Pike Perch in Recirculating Aquaculture*. Glob. Aquac. Advocate.
- Yogev, U., Sowers, K.R., Mozes, N., Gross, A., 2017. Nitrogen and carbon balance in a novel near-zero water exchange saline recirculating aquaculture system. *Aquaculture* 467, 118–126. doi:10.1016/j.aquaculture.2016.04.029
- Yoshii, K., Yotsui, C., 1997. NH₃ and CO₂ induced suppression of taste nerve responses in clawed toads and eels. *Brain Res.* 757, 202–208.
- Zapulla, D., 2008. Environmental Stress, Erythrocyte Dysfunctions, Inflammation, and the Metabolic Syndrome: Adaptations to CO₂ Increases? *J. Cardiometabolic Syndr.* 3, 30–34.

ELEVATED NITRATE LEVELS AFFECT THE ENERGY METABOLISM OF PIKEPERCH (*Sander lucioperca*) IN RAS

Kathrin Steinberg*^{1,2}, Jan Zimmermann^{1,2}, Kevin Torben Stiller^{3,4}, Lawrence Nwanna⁵,
Stefan Meyer² and Carsten Schulz^{1,2}

¹Gesellschaft für marine Aquakultur mbH, Hafentörn 3, 25761 Büsum, Germany

²Institute of Animal Breeding and Husbandry, Marine Aquaculture, Christian-Albrechts-Universität zu Kiel, Olshausenstraße 40, 24098 Kiel, Germany

³Forschungs- und Technologiezentrum Westküste, Christian-Albrechts-Universität zu Kiel, Hafentörn 1, 25761 Büsum, Germany

⁴Department of Zoology, University of British Columbia, 6270 University Blvd., Vancouver, BC V6T 1Z4, Canada

⁵Department of Fisheries & Aquaculture Technology, Federal University of Technology, Akure, Nigeria

Published in *Aquaculture* (2018)

doi: 10.1016/j.aquaculture.2018.08.017

Abstract

The increasing demand for pikeperch (*Sander lucioperca*) from recirculating aquaculture systems (RAS) has raised the need for detailed knowledge on water quality parameters. Nitrate thresholds are of interest as nitrate accumulates in RAS and influences fish physiology. The trial was conducted in a recirculating aquaculture respirometer with pikeperch (average body weight (BW) 367 ± 1.1 g) successively reared at three different nitrate-nitrogen ($\text{NO}_3\text{-N}$) concentrations (N30: 30 mg L^{-1} , N120: 120 mg L^{-1} and N240: 240 mg L^{-1}) and compared to a control group reared at the lowest possible nitrate-nitrogen concentration (N0: 5 mg L^{-1}). Pikeperch were fed once per day with a commercial diet at three different feeding levels corresponding to 0.3% BW, 0.6% BW and 0.9% BW in triplicates for 8 days at either nitrate-nitrogen concentration before fasting for additional 3 days. Oxygen consumption and ammonia excretion were measured for 22-hours in fed and fasting pikeperch to examine the influence of nitrate on energy metabolism. Metabolisable energy, retained energy and digestible energy requirements for maintenance (DE_m) as well as the efficiency for energy utilisation (k_g) and relative protein utilisation for energy metabolism (as ammonia quotient (AQ)) were determined. Specific dynamic action (SDA) was calculated to estimate the amount of energy spend on ingestion, digestion, absorption and assimilation of feed at different nitrate levels. SDA was significantly increased in the N240 treatment. Results of DE_m showed a significant difference between N30 and N120 with DE_m of N120 being about 73% higher than DE_m of N30. The efficiency k_g was significantly decreased between N240 and both N120 and N30 by 10% and 11% respectively. Increased values in AQ in the feed depleted fish in the N240 treatment indicate that fasting pikeperch in the high nitrate treatment had to use body protein to fuel an average of $46 \pm 7\%$ of their energy metabolism. The results of this trial show that—pikeperch tolerate $\text{NO}_3\text{-N}$ concentrations of up to 240 mg L^{-1} but energy requirements are most favourable at concentrations of $30 \text{ mg L}^{-1} \text{NO}_3\text{-N}$.

Keywords: *nitrate, RAS, pikeperch, metabolism, respirometry*

Introduction

Percid fish are promising candidates for intensive aquaculture practices due to their relatively fast growth and high filet yield as well as flesh quality (Mathis et al., 2003; Zakęś et al., 2012). The increasing demand of pikeperch (*Sander lucioperca*) from recirculating aquaculture systems (RAS) has raised the need for detailed knowledge on water quality requirements for optimal growth (Dalsgaard et al., 2013; Hermelink et al., 2013; Schram et al., 2013). Relatively little is known on the life-stage specific requirements and thresholds, e.g. in respect to dissolved nitrogenous compounds as a water quality parameter of high relevance. Our current knowledge in this field is frequently based on standard toxicity tests conducted over a short period of time using various fish species (Colt, 2006; Timmons and Ebeling, 2007). This only provides an approximation considering nitrate thresholds for pikeperch under full production cycle RAS conditions.

Metabolic protein breakdown leads to the accumulation of nitrogenous end products under low water exchange rates in RAS production (Ip et al., 2001; van Rijn, 2007). Nitrogenous end products are mostly excreted as ammonia and urea via fish gills (Evans et al., 2005). In RAS, aerobic biofilters oxidize these compounds to nitrite and subsequently to nitrate (Colt et al., 2006; Pierce et al., 1993). Nitrate accumulates in RAS and achieving low concentrations imply increased costs either due to increased water exchange or by use of a denitrification unit (Austin, 1988; Müller-Belecke et al., 2013; Pierce et al., 1993). Understanding the effects of nitrate and possible interactions with pikeperch performance in RAS is crucial to reduce costs and increase productivity.

Acute and chronic adverse effects of nitrate have been reported for several fish species. Chronic effects on production performance were described at $125 \text{ mg NO}_3\text{-N L}^{-1}$ for marine fish whereas freshwater fish tolerated up to $500 \text{ mg NO}_3\text{-N L}^{-1}$ with LC 50 values exceeding $1000 \text{ mg NO}_3\text{-N L}^{-1}$ (Camargo et al., 2005; Colt, 2006; Monsees et al., 2016; Timmons and Ebeling, 2007; van Bussel et al., 2012; van Rijn, 2007). Increased nitrate concentrations were found to affect the osmoregulatory ability, cause methaemoglobinemia and have the potential to disrupt endocrine function in different freshwater fish species (Hamlin et al., 2008; Hrubec et al., 1996; Tilak et al., 2007). Nitrate levels of $60 - 100 \text{ mg NO}_3\text{-N L}^{-1}$ were assumed to

be the reason for deformities, abnormal swimming behaviour and general health problems in studies conducted on rainbow trout (*Oncorhynchus mykiss*) and common carp (*Cyprinus carpio*) in low water exchange RAS (Davidson et al., 2014, 2011; Martins et al., 2009b).

Research conducted on juvenile pikeperch (27 g initial weight) found no negative effect of nitrate levels of up to 350 mg NO₃-N L⁻¹ (Schram et al., 2013) while a similar study indicates that NO₃-N levels above 68 mg L⁻¹ (Müller-Belecke et al., 2013) result in reduced feed intake in subadult pikeperch. This supports Martins et al. (2009a) hypothesis that the sensitivity of a given species in respect to water quality parameters in RAS increases with increasing body size and age. This was empirically confirmed for Nile tilapia (*Oreochromis niloticus*) and fathead minnow (*Pimephales promelas*) (Atwood et al., 2001; Palachek and Tomasso, 1984). It is therefore crucial to evaluate water quality criteria specifically for discrete life stages.

The present study focused on the impact of four nitrate levels commonly found in RAS on adult pikeperch (from 367.2 ± 1.1 g to 448.3 ± 28.9 g body weight). The main objective was to evaluate the effect on energy metabolism efficiency and energy requirements above maintenance by using automated group respirometry. This method allows to quantify the energy budget and metabolic fuel use on a short term basis without sacrificing the fish. The study was based on measurements of routine metabolism (normal daily activity including feeding and spontaneous swimming) as this is considered to best represent the metabolism in RAS production (MacIsaac et al., 1997). We hypothesized that increased levels of nitrate have an impact on both the energy metabolism efficiency as well as the energy requirements above maintenance requirements of pikeperch.

Material and Methods

Fish

The trial was conducted at Gesellschaft für marine Aquakultur (GMA) Büsum, Germany. Pikeperch (*Sander lucioperca*) were obtained from Fischzucht Rietschen (Rietschen, Germany) and accustomed to the respirometer system for one week before the experiment. Animal husbandry was in accordance to the EU Directive 2010/63/EU for animal experiments.

Respirometer system

The recirculating aquaculture respirometry system (RARS) is described in detail by Stiller et al. (2013) and consists of 10 tanks (250 L volume each), a trickling biofilter, a particle filter and a sedimentation unit. The system is purpose built for longterm respirometry studies of groups of fish. The tanks have a separate in and outflow and are continuously supplied with freshwater at 300 L h⁻¹. They are completely closed with water entering in the middle of the tank and exiting through an overflow pipe at the top of the tank. Feeding can be maintained through the overflow pipe with an additional funnel. Each tank has a separate outflow at the bottom that can be used to collect uneaten feed and faeces. A circulation pump in the tanks ensures that water is mixed sufficiently and that all uneaten feed and faeces congregates above the separate outflow.

Oxygen concentration (oxygen optode 4330, Serial No. 1557, Aandera data instruments, Bergen, Norway), temperature (compensation thermometer Type 201085), pH (pHNBS intermediate junction electrode, Ionode IJ44, TPS Pty Ltd, Brisbane, Australia), dissolved carbon dioxide (purpose built flow through headspace analyser, MK-2 pCO₂ / Fast Analyser (SubCtech GmbH, Kiel, Germany) with non-dispersive infrared detection, LI-840A (LI-COR Biosciences, Nebraska, United States)) and total ammonia-nitrogen (TAN, loop flow orthophtalaldehyde fluorometric autoanalyser, µMac, SYSTEA S.p.A., Anagni, Italy) were measured online every 12 min in each tank over a course of 22-hours. One tank was kept empty of fish and used as a reference. In this tank, walls were cleaned manually on a daily basis to avoid any effect of biofilm build-up on oxygen consumption.

Experimental design

The experiment was designed as a restricted ration experiment with three feeding levels in parallel triplicates that were subsequently exposed to four nominal nitrate-nitrogen concentrations (N0: 0 mg L⁻¹, N30: 30 mg L⁻¹, N120: 120 mg L⁻¹, N240: 240 mg L⁻¹) over a period of 11 days each (total duration of experiment 55 days). Fish were slowly acclimatised to each nitrate-nitrogen concentration for 7 days and the 22-hour measurements were conducted on the eighth day. The measurements were repeated after three days of feed depletion in order to evaluate the effect of feed

intake on energy metabolism. The experiment was concluded with an additional period of NO nitrate concentration to assess any irreversible influence of the increased nitrate concentrations.

The tanks were stocked with 6 individuals per tank ($367.2 \text{ g} \pm 1.1 \text{ g}$ live body weight). Fish were weighed individually at the start (day 0) and end (day 56) of the experiment to assess live body weight on measurement days. Fish were fed once per day with a single portion of a commercial diet (ALLER Metabolica, 6 mm, ALLER Aqua, Christiansfeld, Denmark, macro nutrient profile (measured): moisture 7%, crude protein 50%, crude fat 15%, ash 8%, nitrogen free extractives 20%, energy $21.26 \text{ g MJ kg}^{-1}$) with three replicate tanks per feeding level. The feeding levels were calculated on basis of metabolic body weight (MBW) and corresponded to a daily feed intake (DFI) of 0.3, 0.6 and 0.9% bodyweight (1.25, 2.00 and 2.75% MBW). Faeces were removed before feeding through the separate bottom outflow and uneaten pellets were removed from the tanks and counted 20 minutes after feeding. The average weight of one dry pellet was determined prior to the start of the experiment and multiplied with the number of uneaten pellets to calculate the actual feed intake.

The experimental procedure was repeated for each subsequent period of altered nitrate concentration. Nitrate concentrations in the whole system were increased genuinely over three days by mixing sodium nitrate (NaNO_3) and potassium chloride (KCL) (Carl Roth GmbH & Co. KG, Karlsruhe, Germany) in tap water at a weight-ratio of 27:1 thus similar to the ratio found in natural seawater (Romano and Zeng, 2009, 2007). Actually realized nitrate concentrations were measured daily as nitrate-nitrogen ($\text{NO}_3\text{-N}$) with a pre-dosed photometric test (LCK 340, Hach Lange GmbH, Düsseldorf, Germany).

Energy metabolism efficiency and maintenance requirements

All measurements were normalised to an individual fish. Calculations were based on the metabolic body weight (MBW) to compensate for growth during the experiment, using the common metabolic weight exponent for energy of 0.8 (Clarke and Johnston, 1999; Lupatsch et al., 2003).

Measurements of oxygen consumption (OC) and ammonia excretion were conducted over a 22-hour period after the acclimatisation period of 7 days and calculated as difference between the concentration in the individual respirometer tanks and the

reference tank along with a correction to account for the washout effect as described in detail by Stiller et al. (2013). OC was measured as routine oxygen consumption (ROC) of fed fish and as starving oxygen consumption (SOC) after 3 days of feed depletion. Specific dynamic action (SDA) reflects the energy requirement associated with feeding and was calculated as difference between ROC and SOC. Energy budgets were calculated based on the gross energy intake (GEI) as the product of gross energy of diets and feed intake divided by the MBW. Digestible energy intake (DEI) per MBW was calculated as the product of dietary digestible energy and the feed intake divided by the MBW. The digestible energy of diet was determined on the basis of a previous experiment (unpublished results, data not shown) as 89.13% of the energy of the diet. Ammonia excretion was measured in each tank and the energy of non-faecal N (E_N) was then calculated based on the assumption that pikeperch excrete 15% of N as urea and 85% as ammonia with energy equivalents of 24.8 kJ g⁻¹ for ammonia-N and 23.0 kJ g⁻¹ for urea-N (Elliott and Davison, 1975; Jobling, 1994; Wright and Anderson, 2001). The difference between DEI and E_N was used to determine the metabolisable energy intake (MEI). Calculation of the retained energy (RE) was based on the simplification that all oxygen consumed was lost as heat with an energy equivalent of 13.6 kJ g⁻¹ O₂ consumed and calculated as MEI minus heat (Elliott and Davison, 1975). The ammonia quotient (AQ) was calculated as excreted TAN divided by consumed O₂. Calculations were conducted based on 22 h measurements of O₂ and TAN and used to estimate the degree of protein utilisation for energy metabolism. An AQ of 0.27 corresponds to 100% protein utilisation (Gnaiger, 1983). The maintenance requirements and efficiencies of energy utilisation for growth above maintenance were determined through a linear regression analysis following the linear regression equation

$$RE (kJ kg^{-0.8} day^{-1}) = k_{g(DE)} * DEI (kJ kg^{-0.8} day^{-1}) + a$$

Where the energy intake at RE = 0 is defined as the maintenance requirement of the fish. The slope represents the efficiency of energy utilisation. In order to determine the standard errors for the slope (k_g) and the y-intercept (a) the following equation was used where energy intake was taken as dependant and RE as independent variable.

$$DEI (kJ kg^{-0.8} day^{-1}) = \frac{1}{k_g(DE)} * RE (kJ kg^{-0.8} day^{-1}) + DE_m$$

The y-intercept (DE_m) equals the maintenance requirement of digestible energy. The reciprocal value of k_g describes the cost for DE (kJ) per unit of RE (kJ).

Statistics

All data was checked for normal distribution and homogeneity of variance based on graphical residual analyses. Results are presented as mean \pm SD and considered to be significant at $p < 0.05$. One-way analysis of variance (ANOVA) followed by a parametric post-hoc test (Tukey HSD test) or Kruskal-Wallis Anova were used to compare results. All-pair comparisons were conducted between feeding levels within nitrate levels ($n = 3, F = 2, 6$) and between nitrate levels within feeding levels ($n = 3, F = 3, 8$) (ROC, SOC, SDA, %RE, AQ, GEI, DEI, E_N , MEI, heat, RE). A linear mixed model based on the nitrate levels and RE as well as their interaction term was applied for analysis of the linear regressions to determine DE_m and k_g . Based on this model a pseudo R^2 was calculated and an analysis of covariance (ANCOVA) was conducted followed by multiple contrast tests. All statistical data was analysed using R-Software version 3.4.1.

Results

The results of all parameters assessed during the second NO nitrate concentration period at the end of the experiment were not significantly different from measurements conducted during the initial NO nitrate concentration period at start of the experiment. Hence, results of the second NO treatment are not presented in this section.

Water quality parameters

Water quality parameters were maintained within safe levels for pikeperch throughout the experiment with the exception of nitrate as intended by treatment. The actual results of nitrate-nitrogen measurements for the corresponding nitrate treatments are shown in Table 2-1. Temperature was kept at 23 ± 0.1 °C to ensure efficient metabolism and pH was maintained at 8.03 ± 0.12 . Average O₂ concentration over the whole experimental period was 6.9 ± 0.3 mg L⁻¹ and CO₂ concentration was 0.68 ± 0.12 mg L⁻¹ throughout the experiment.

Table 2-1 Average water quality parameters in the RARS on the last five days of each nitrate concentration period.

Treatment	NO ₃ -N [mg L ⁻¹]	NO ₂ -N [mg L ⁻¹]	TAN [ppb]
N0	4.8 ± 0.9	0.07 ± 0.06	20.6 ± 7.6
N30	31.5 ± 4.2	0.04 ± 0.01	12.8 ± 2.4
N120	134.0 ± 16.6	0.08 ± 0.06	27.3 ± 8.1
N240	245.2 ± 6.9	0.15 ± 0.02	34.0 ± 11.2

Concentration values are the arithmetic mean ± SD of n = 5 measurements.
NO₃-N: nitrate-nitrogen; NO₂-N: nitrite-nitrogen; TAN: total ammonia-nitrogen

Feed intake and oxygen consumption

Daily feed intake (DFI) and the results of oxygen consumption and the calculated MBW on measuring days are presented in Table 2-2. The fish did not show any differences in feed intake between the different nitrate levels. Both routine oxygen consumption (ROC) and starved oxygen consumption (SOC) were significantly influenced by nitrate levels and by feeding levels. The results for specific dynamic action (SDA) are shown in Table 2-2. SDA was only influenced by feeding level in the N240 treatment where SDA was also significantly higher than in all other NO₃-N treatments.

Table 2-2 Metabolic body weight, feed intake, oxygen consumption and SDA of pikeperch reared at four different NO₃-N levels.

FL	MBW [g]	Feed intake [g kg ^{-0.8} day ⁻¹]	ROC	SOC	SDA
				[mg kg ^{-0.8} h ⁻¹]	
Treatment NO					
1.25	452.3 ± 0.2	3.1 ± 0.1	61.1 ± 3.0 ^B	55.8 ± 4.0 ^C	5.6 ± 5.0 ^A
2.00	456.3 ± 3.3	4.9 ± 0.2	71.4 ± 9.5 ^{KL}	56.9 ± 1.8 ^L	14.6 ± 7.7 ^{KL}
2.75	461.3 ± 3.9	5.6 ± 0.9	74.1 ± 7.5 ^S	55.9 ± 1.8 ^T	18.2 ± 5.7 ^{RS}
Treatment N30					
1.25	458.3 ± 1.4	3.2 ± 0.0	45.6 ± 3.5 ^{Ax}	44.5 ± 3.4 ^B	3.1 ± 2.9 ^A
2.00	467.3 ± 4.9	5.1 ± 0.0	51.2 ± 4.8 ^{Kxy}	46.2 ± 3.8 ^{KL}	5.0 ± 2.4 ^K
2.75	477.7 ± 6.9	6.1 ± 0.4	58.6 ± 4.8 ^{Ry}	48.1 ± 2.7 ^S	10.5 ± 6.2 ^R
Treatment N120					
1.25	463.6 ± 2.6	3.2 ± 0.0	67.7 ± 2.3 ^B	49.2 ± 1.3 ^{BC}	18.4 ± 1.2 ^B
2.00	477.2 ± 6.3	5.0 ± 0.2	71.9 ± 11.9 ^{KL}	49.4 ± 6.2 ^{KL}	22.5 ± 5.8 ^L
2.75	493.7 ± 9.1	5.1 ± 0.5	79.2 ± 5.0 ST	53.3 ± 1.4 ST	25.8 ± 5.8 ^S
Treatment N240					
1.25	470.5 ± 4.3	3.2 ± 0.1	69.6 ± 3.2 ^{Bx}	35.3 ± 4.6 ^A	34.3 ± 1.5 ^{Cx}
2.00	490.3 ± 8.1	5.1 ± 0.2	82.5 ± 8.1 ^{Lxy}	37.9 ± 5.5 ^K	44.6 ± 4.9 ^{Mxy}
2.75	513.1 ± 12.4	5.4 ± 0.4	92.0 ± 2.8 ^{Ty}	38.9 ± 5.5 ^R	53.1 ± 5.5 ^{Ty}

Values are mean ± SD. FL: feeding level; MBW: metabolic body weight of an average fish on measuring day of ROC; feed intake: per fish on measuring day of ROC; ROC: routine oxygen consumption of fed fish; SOC: starving oxygen consumption; SDA: specific dynamic action (ROC-SOC). Capital letters indicate significant differences in oxygen consumption between nitrate levels within FL (FL 1.25: A, B, C; FL 2.00: K, L, M; FL 2.75: R, S, T). Lower case letters indicate significant differences in oxygen consumption between feeding levels within nitrate levels (x, y, z).

Energy budget

The results of the calculated energy budgets are shown in Table 2-3. There were no significant differences in energy intake between fish that were exposed to different nitrate concentrations within a feeding level. The energy of non-faecal nitrogen (E_N) was significantly increased in all feeding levels between N30 and N240 and in feeding level 2.00 and 2.75 between N240 and all other treatments. Heat production decreased significantly within N30 treatment compared to all other treatments with the exception of feeding level 2.00. There were no significant differences in retained energy (RE) between nitrate levels in the highest feeding level (2.75).

Table 2-3 Energy budgets of pikeperch at four different $\text{NO}_3\text{-N}$ levels fed three different feeding levels.

FL	GEI	DEI	E_N	MEI	heat	RE
$\text{kJ kg}^{-0.8} \text{day}^{-1}$						
Treatment NO						
1.25	65.8 ± 2.7	58.6 ± 2.4	1.8 ± 0.3 ^{AB}	56.9 ± 2.1	19.9 ± 1.0 ^B	37.0 ± 1.4 ^A
2.00	104.6 ± 4.5	93.2 ± 4.0	2.7 ± 0.5 ^K	90.5 ± 3.6	23.3 ± 3.1 ^{KL}	67.2 ± 1.3 ^K
2.75	119.7 ± 24.1	106.6 ± 21.5	3.1 ± 0.6 ^R	103.5 ± 20.9	24.2 ± 2.4 ^S	79.3 ± 18.4
Treatment N30						
1.25	67.3 ± 0.2	59.9 ± 0.2	1.1 ± 0.1 ^A	58.8 ± 0.1	14.9 ± 1.1 ^A	43.9 ± 1.1 ^B
2.00	109.0 ± 0.4	97.1 ± 0.4	2.0 ± 0.2 ^K	95.1 ± 0.3	16.7 ± 1.6 ^K	78.4 ± 1.8 ^L
2.75	130.4 ± 10.8	116.2 ± 9.6	2.6 ± 0.3 ^R	113.7 ± 9.4	19.1 ± 1.2 ^R	94.5 ± 10.0
Treatment N120						
1.25	67.8 ± 0.9	60.4 ± 0.8	1.6 ± 0.2 ^{AB}	58.8 ± 0.6	22.1 ± 0.8 ^{BC}	36.7 ± 0.9 ^A
2.00	106.2 ± 4.9	94.6 ± 4.4	2.4 ± 0.0 ^K	92.2 ± 4.4	23.5 ± 3.9 ^{KL}	68.8 ± 4.2 ^{KL}
2.75	109.4 ± 13.8	97.5 ± 12.3	2.6 ± 0.3 ^R	94.8 ± 12.0	25.8 ± 1.6 ST	69.0 ± 12.7
Treatment N240						
1.25	67.8 ± 2.0	60.4 ± 1.8	2.4 ± 0.5 ^B	58.0 ± 1.4	22.7 ± 1.0 ^C	35.3 ± 0.4 ^A
2.00	107.7 ± 4.3	96.0 ± 3.8	3.6 ± 0.3 ^L	92.4 ± 3.9	26.9 ± 2.6 ^L	65.4 ± 6.5 ^K
2.75	115.7 ± 9.6	103.1 ± 8.5	4.2 ± 0.4 ^S	98.8 ± 8.2	30.0 ± 0.9 ^T	68.8 ± 7.4

Values are mean ± SD, each sample (n = 3) consists of three tanks; FL: feeding level; GEI: gross energy intake; DEI: digestible energy intake; E_N : energy of non-faecal nitrogen; MEI: metabolisable energy intake; heat: energy lost as heat; RE: retained energy. Capital letters show significant differences between nitrate levels within feeding levels (FL 1.25: A, B, C; FL 2.00: K, L, M; FL 2.75: R, S, T) ($p < 0.05$).

Feeding level 1.25 showed a significant increase in RE in N30 compared to all other treatments and feeding level 2.00 showed a significant increase of RE in N30 compared to N240. The percentage of energy intake retained in the fish (%RE of GEI) can be seen in Fig. 2-1. The most apparent difference is the increased percentage of energy retained in fish fed 1.25% MBW in N30. Furthermore %RE is significantly higher in all feeding level of N30 compared to N120 and N240.

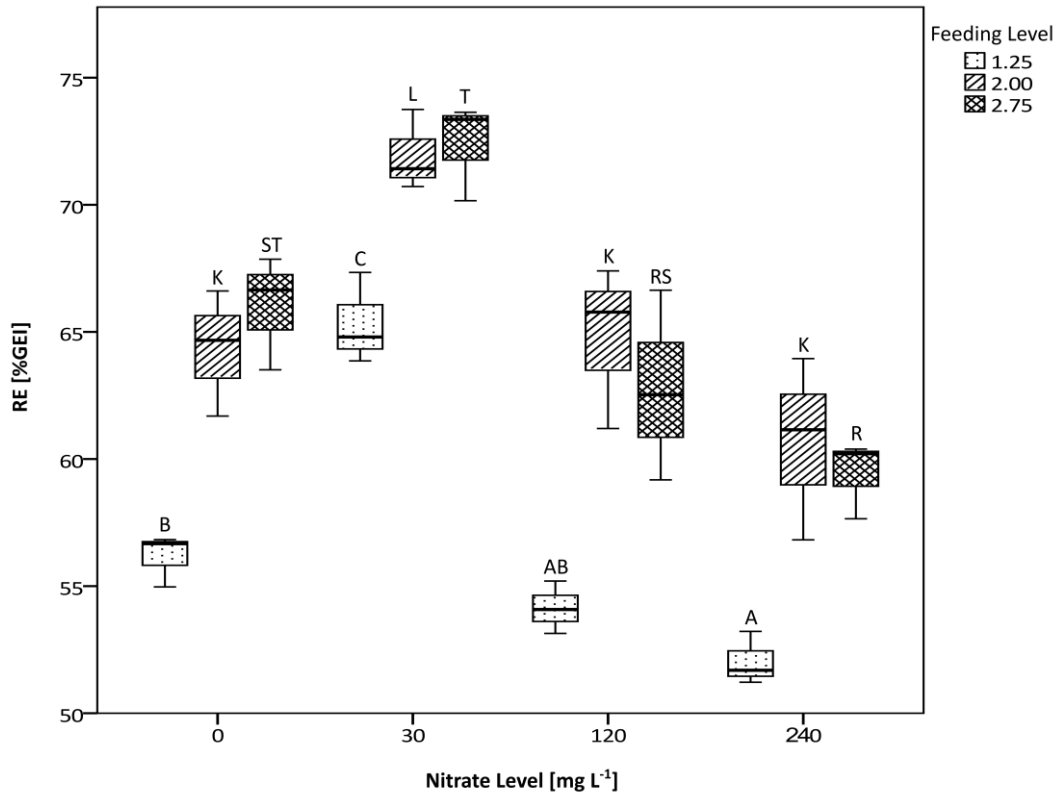

Figure 2-1 Percentage of retained energy (RE) of gross energy intake (GEI) of pikeperch at four different NO₃-N levels. The boxes represent values between the 25 and 75 percentiles and whiskers indicate 1.5 SD. Median is indicated by the solid line. Capital letters indicate significant differences between nitrate levels within feeding levels (FL 1.25: A, B, C; FL 2.00: K, L, M; FL 2.75: R, S, T) ($p < 0.05$).

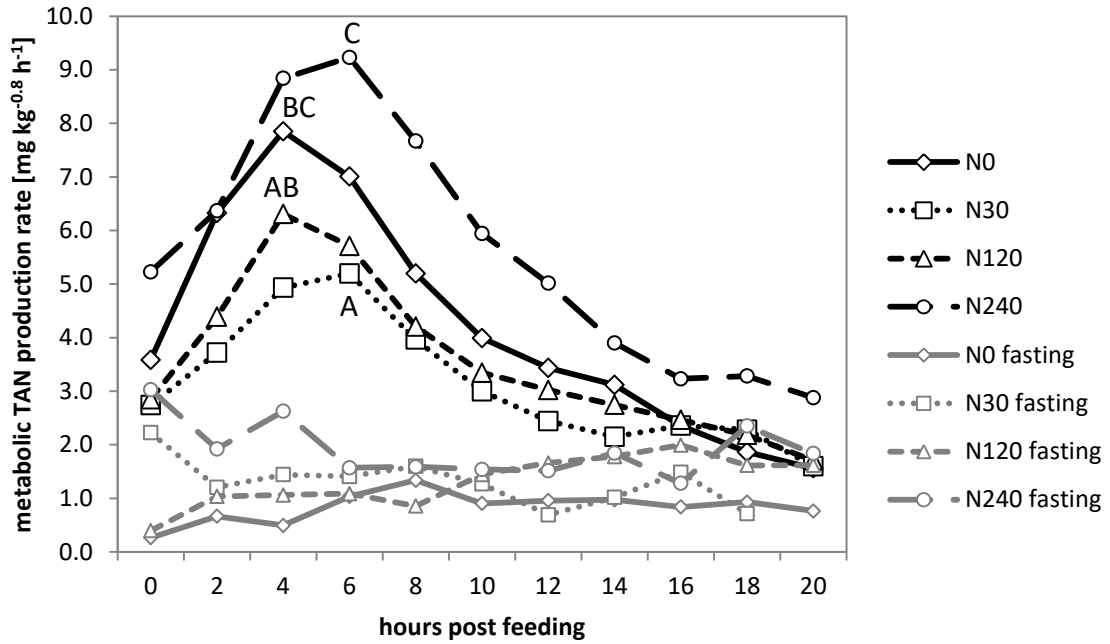

Figure 2-2 Mean metabolic TAN (total ammonia-nitrogen) production rate of pikeperch at four $\text{NO}_3\text{-N}$ levels in fed and fasting conditions as average of all feeding levels ($n=9$). Capital letters indicate significant differences between peaks of metabolic TAN production rate in fed conditions ($p < 0.05$).

The diurnal metabolic TAN excretion of fed and fasting fish is shown in Fig. 2-2 as an average of all feeding levels. Peaks of metabolic TAN excretion can be seen 4 hours (N0, N120) or 6 hours (N30, N240) past feeding and were significantly higher in N240 compared to N30 and N120 and significantly lower in N30 compared to N0.

Relative protein utilisation for energy metabolism is shown in Fig. 2-3 as AQ. The AQ in fasting conditions is significantly lower than the AQ in the corresponding fed conditions in N0, N30 and N240 with the exception of feeding level 1.25 in N30. There are no significant differences between fed and non-fed conditions within N240 and the non-fed AQs in the N240 treatment are significantly higher than in N0, N30 and N120 treatment.

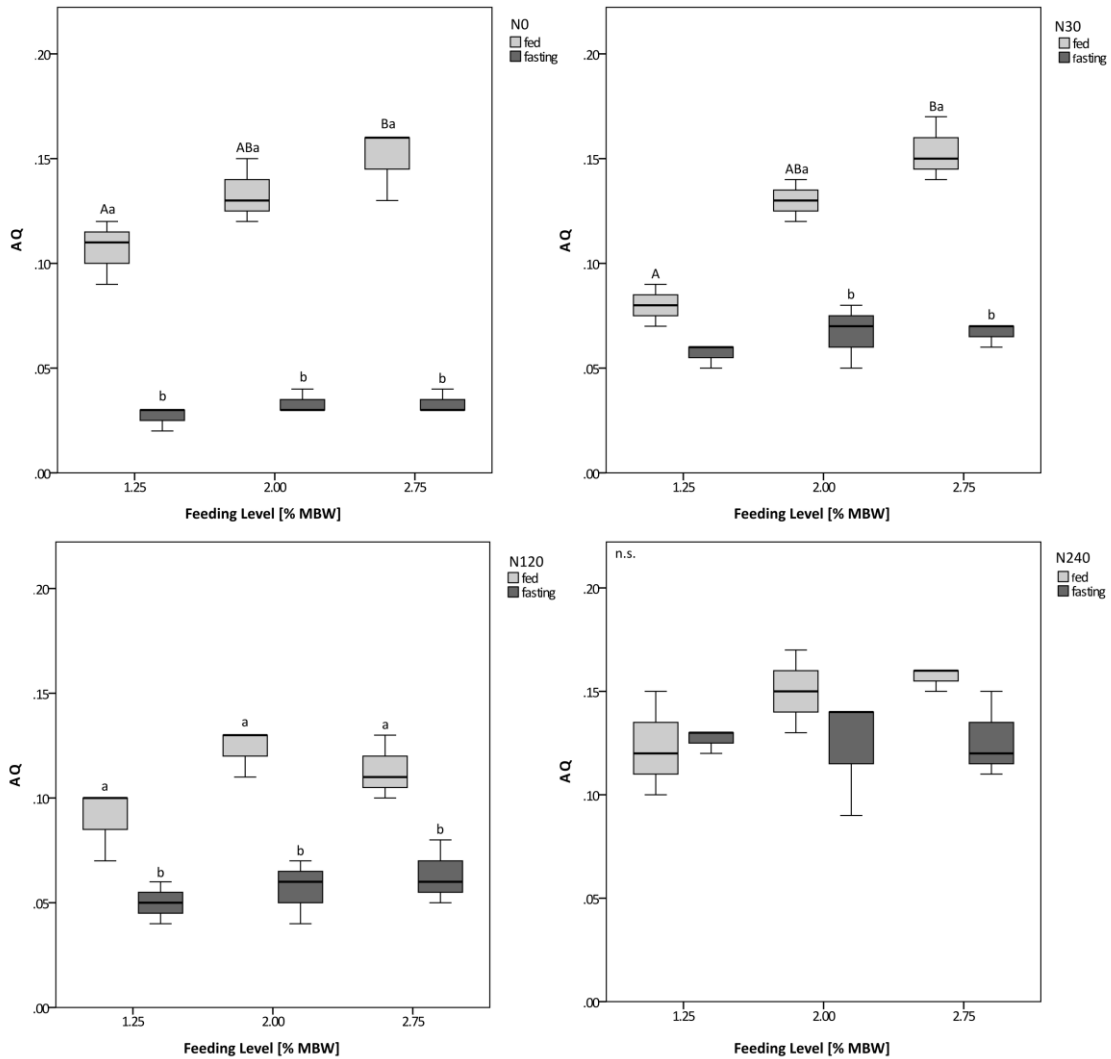

Figure 2-3 Ammonia Quotient (AQ) during fed and fasting conditions at four different nitrate treatments. The boxes represent values between the 25 and 75 percentiles and whiskers indicate 1.5 SD. Median is indicated by the solid line. Capital letters indicate significant differences between feeding levels. Lower case letters indicate significant differences between fed and fasting conditions within feeding level ($p < 0.05$).

Maintenance requirement and efficiency of energy utilisation

The following equations describe the linear relationship between RE and DEI of the different treatments (means \pm SD) ($R^2 = 0.99$, $p < 0.01$)

$$\text{N0} \quad \text{RE} = 0.86 (\pm 0.03) \times \text{DEI} - 13.28 (\pm 2.51)$$

$$\text{N30} \quad \text{RE} = 0.90 (\pm 0.03) \times \text{DEI} - 9.62 (\pm 2.44)$$

$$\text{N120} \quad \text{RE} = 0.89 (\pm 0.03) \times \text{DEI} - 17.09 (\pm 2.94)$$

$$\text{N240} \quad \text{RE} = 0.80 (\pm 0.03) \times \text{DEI} - 12.90 (\pm 2.92)$$

The relationship between RE and DEI is shown in Fig. 2-4. Results of maintenance requirement of digestible energy (DE_m), energy utilisation efficiency (k_g) and energetic costs of DE per unit RE (k_g^{-1}) are shown in Table 2-4. DE_m showed a significant difference between N30 and N120 with DE_m of N120 being about 73% higher than DE_m of N30. The efficiency of energy utilisation (k_g) is significantly decreased between N240 and both N120 and N30 by 10% and 11% respectively.

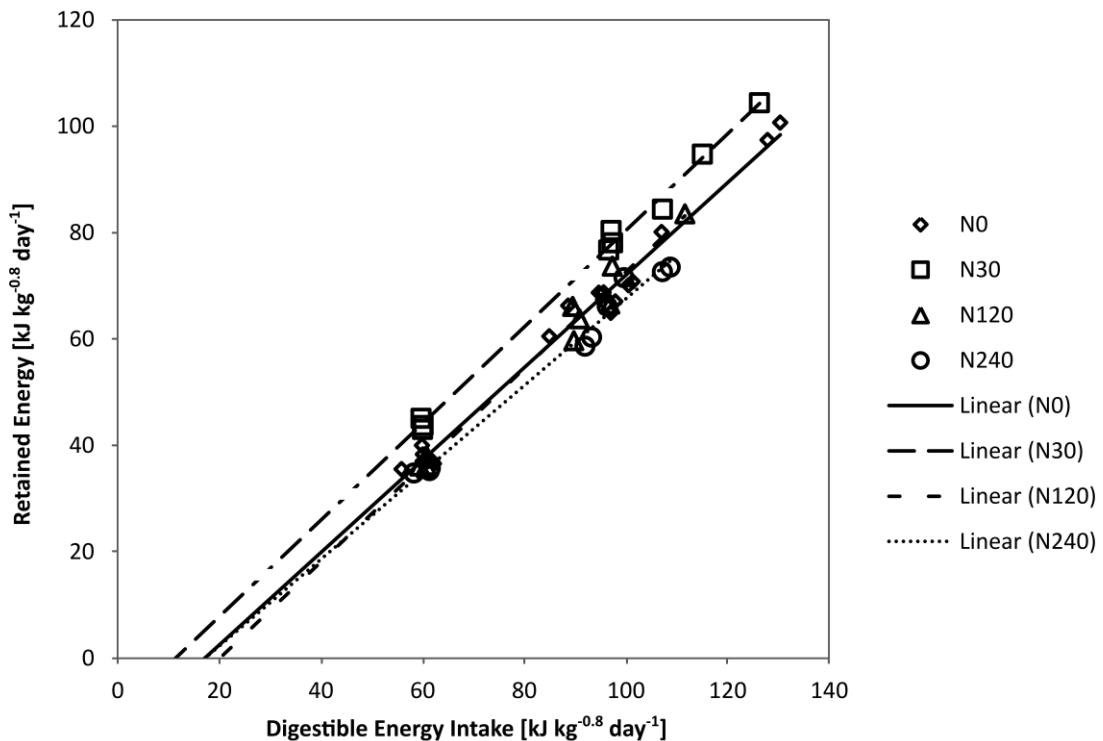

Figure 2-4 Energy retention per metabolic weight (RE) of pikeperch at four different nitrate levels based on different digestible energy intake (DEI). Each data point represents one respirometer tank. Equations are given in the text.

Table 2-4 Parameters of the linear regression equations ($n = 9$) with $R^2 = 0.989$.

Treatment	DE_m [kJ kg ^{-0.8} day ⁻¹]	k_g^{-1}	k_g
N0	16.40 ± 2.39 ^{wx}	1.14 ± 0.04 ^{wx}	0.86 ± 0.03 ^{wx}
N30	12.09 ± 2.48 ^w	1.09 ± 0.03 ^{wx}	0.90 ± 0.03 ^x
N120	20.98 ± 2.58 ^x	1.08 ± 0.04 ^w	0.89 ± 0.03 ^x
N240	17.80 ± 2.70 ^{wx}	1.21 ± 0.05 ^x	0.80 ± 0.03 ^w

Values are mean ± SD. DE_m : maintenance requirement of digestible energy; k_g^{-1} : energetic costs of DE per unit RE; k_g : efficiency of energy utilisation above maintenance. Lower case letters indicate significant differences between nitrate levels ($p < 0.05$).

Discussion

Nitrate is toxic to aquatic animals and toxicity has been found to increase with concentration and exposure time (Camargo and Ward, 1992; Davidson et al., 2014; Monsees et al., 2016). The aim of this study was to evaluate the effect of commercially applicable nitrate concentrations on adult pikeperch. The exact pathway of nitrate uptake is not known to date but the main toxic effect on aquatic animals is the formation of methaemoglobin (MetHb) from haemoglobin (Hb) resulting in a decrease of the oxygen carrying capacity of the blood (Camargo et al., 2005; Cheng and Chen, 2002; Hrubec et al., 1996; Jensen, 1995).

Pikeperch in the present study were fed three different feeding levels with a maximum of 0.9% BW. Fish in the different nitrate treatments did not show any differences in feed intake or behaviour. The design of the study is based on the assumption that digestibility did not change with neither size nor increased nitrate level. The unpublished data used to calculate the digestibility was conducted with pikeperch from the same origin in a similar size ratio with a comparable feed intake thus reducing possible size and feed intake related effects. Influences of nitrate levels on digestibility were not analysed although this could have had an effect on the energy metabolism. It is therefore likely that effects are more pronounced than identified by this study.

Frisk et al. (2013) identified the average SDA of adult pikeperch (966 ± 38 g) at 25°C to be approximately $20.6 \text{ mg kg}^{-0.8} \text{ h}^{-1}$ (approximate DFI of 1.0) which is similar to the $18.2 \pm 5.7 \text{ mg kg}^{-0.8} \text{ h}^{-1}$ calculated in this experiment at feeding level 2.75 (~0.9% BW) in the baseline nitrate concentration (N0). The specific dynamic action (SDA) expresses

the energetic costs associated with feeding and both scope and duration depends on species, ration size and temperature but is also known to be influenced by environmental factors (Jobling, 1981; Mallekh and Lagardere, 2002). In the present study, SDA at the same feeding level was nearly threefold higher in the highest nitrate concentration (N240) treatment at $53.1 \pm 5.7 \text{ mg kg}^{-0.8} \text{ h}^{-1}$. We hypothesize that the high nitrate concentration resulted in the formation of methaemoglobinemia and that this led to the elevated SDA values in the high nitrate treatment.

The significant increase of SDA across all feeding levels in the N240 treatment could therefore indicate that pikeperch had to spend more energy on ingestion, digestion, absorption and assimilation of the feed (Jobling, 1981). This increased energy expenditure would result in a reduction of growth rates in the long term.

Generally fish may be able to countervail the increased oxygen demand by raising the arterial – venous oxygen content difference or redistribute blood from the gut to the muscles (Brauner et al., 1993). The redistribution of oxygen from the gut may explain the seemingly greater length of protein digestion as seen in the elongated TAN excretion rates seen in Fig. 2-2. Prolonged SDA has been linked to reduced digestive efficiency (Tirsgaard et al., 2015). Calculated TAN excretion, based on the estimated curve formulae (cubic curve estimation, $R^2 \geq 0.65$), peaks after $6:45 \pm 0:05 \text{ h}$ in the N0 treatment while fish in the N30, N120 and N240 treatment show later peaks at $7:02 \pm 0:04 \text{ h}$, $7:10 \pm 0:06 \text{ h}$ and $7:07 \pm 0:04 \text{ h}$ respectively thus indicating an elongated digestion.

The present study found elevated AQ (relative protein usage) in fasting fish that were exposed to the highest nominal nitrate concentration (N240) compared to fasting fish exposed to any of the other lower nitrate concentrations. Fasting fish in the high nitrate treatment had to use body protein to fuel an average of $46 \pm 7\%$ of their energy metabolism. This underlines the assumption that these high nitrate levels lead to significant stress. Fish react to high nitrate concentrations with a generalized stress response (Hrubec et al., 1996). Increased levels of protein catabolism are a known reaction to different stressors (Barton and Iwama, 1991; De Smet and Blust, 2001; Wendelaar Bonga, 1997). Breakdown and mobilisation of glycogen, the principal energy reserve of animals, is enhanced during stress events as well as fasting periods, leading to a depletion of internal glycogen reserves. Proteins are then used to fuel

metabolism (Adeva-Andany et al., 2016; Diwan et al., 1979; Lucas, 1996). An increased use of body protein to fuel energy metabolism in fasting fish would result in high AQ levels as seen in this study.

The maintenance requirement (DE_m) of pikeperch with $16.40 \pm 2.39 \text{ kJ kg}^{-0.8} \text{ day}^{-1}$ in the N0 treatment was low compared to results for other species conducted via comparative slaughter method such as silver perch (*Bidyanus bidyanus*) with $36.79 \text{ kJ kg}^{-0.6} \text{ day}^{-1}$, gilthead seabream (*Sparus aurata*) with $47.89 \pm 2.94 \text{ kJ kg}^{-0.8} \text{ day}^{-1}$ or European sea bass (*Dicentrarchus labrax*) with $45.38 \pm 1.40 \text{ kJ kg}^{-0.8} \text{ day}^{-1}$ (Booth and Allan, 2003; Lupatsch et al., 2003). The energy utilisation efficiency (k_g) in the same studies was below 0.70, well below the energy efficiency found in this study in the N0 treatment of 0.86 ± 0.03 . Similar discrepancies between respirometry and comparative slaughter method have been found in juvenile turbot (*Psetta maxima*) (Dietz et al., 2013). Information on energy utilisation efficiency and energy sources can be gathered by comparative slaughter method or via respirometry. The latter is also referred to as instantaneous method as it evaluates the substrates that are actually oxidized by the metabolism at that point of time (Lauff and Wood, 1996).

Lauff and Wood (1996) compared the fuel usage of juvenile rainbow trout (*Oncorhynchus mykiss*) during starvation using both the comparative slaughter method and closed respirometry (single animal). Their results showed significant differences between the two methods with protein utilisation rates measured via respirometry being 5 fold lower than the calculated rates based on the comparative slaughter method. The main reason for the different results is due to the different bases of the calculations. The slaughter method is based on the net loss (or gain) of the fish while the respirometry indicates substrates that are actually oxidized and does not account for proteins that are converted to glucose prior oxidation for energy metabolism (Lauff and Wood, 1996). This is a possible explanation for the comparatively high efficiency of energy utilisation in this trial. Results for DE_m and k_g in the different N treatments are nevertheless comparable to each other due to the fact that all results were conducted using the same experimental set-up and the same fish. The results show a significant decrease between k_g of N30 and N240 thus indicating that although pikeperch still grow in concentrations of nitrate-nitrogen around 240 mg L^{-1} the growth

rates are not as efficient. The highest energy utilisation efficiency and lowest maintenance requirements were observed in the N30 treatment.

Similar effects are indicated by the percentage of energy intake retained in the fish. This percentage is significantly higher in N30 compared to N120 and N240, indicating a more favourable energy utilisation efficiency. The overall percentage of energy retained in the fish in all treatments (with the exception of the lowest feeding groups in all treatments) was in the same range as previous results where pikeperch were found to retain $68.68 \pm 2.34\%$ energy (Steinberg et al., 2017). This suggests that pikeperch in all treatments maintained an efficient energy metabolism.

Differences between the feeding levels furthermore indicate that fish fed low rations of feed have to spend a higher percentage of their energy intake on their energy metabolism. The deposition ratio of lipid and protein changes in restricted feeding regimes, favouring protein deposition, thus resulting in proportionally higher costs for maintenance (Bureau et al., 2002).

The positive effect of the N30 treatment on pikeperch metabolism is presumably due to the slightly increased salinity as a result of KCl and NaNO₃ dosing. The increased osmolarity of the water decreases the gradient between internal and external osmolarity thus reducing osmoregulatory stress on the fish (Eckert et al., 2002). Pikeperch is a freshwater species but also inhabits coastal waters and research suggests that brackish waters with low salinities lead to increased growth rates (FAO, 2012; Hilge and Steffens, 1996; Ložys, 2004). Additional research on the influence of increased salinities on pikeperch in RAS would be necessary in order to classify the scope of the effect of salinity in comparison to the effect of increased nitrate levels.

Previous research conducted on juvenile pikeperch found no negative effect of up to 358 mg NO₃-N L⁻¹ on growth or feed intake (Schram et al., 2013). The experiment was done for 42 days in rectangular aquaria at 24°C. Differences in the findings by Schram et al. (2013) compared to this study can be subject to the different size and age groups as well as the different experimental approach. Respirometry allows for small changes in metabolism to be detected whereas differences in growth take a longer experimental period to be detectable. Due to the lack of information on possible changes in nitrate sensitivity with size and age it is impossible to identify the exact reason for the different results in the two studies. Further research should focus on

the effect of nitrate on different sizes of pikeperch using the same experimental approach. Additional research should be focussed on the effects of increased nitrate levels on digestibility.

The results of this trial show that pikeperch tolerate $\text{NO}_3\text{-N}$ concentrations of up to 240 mg L^{-1} but energy requirements are most favourable at concentrations of 30 mg L^{-1} . Lower concentrations of $\text{NO}_3\text{-N}$ showed increased energy demands and decreased energy utilisation efficiency.

Acknowledgements

We thank the Federal Ministry of Education and Research (Project number 031A290A) for funding the project and Dr. Klaus Vanselow and Gero Bojens for the technical support with the RARS. Special thanks to Dr. Mario Hasler for his detailed statistical advice and the staff at GMA Büsum for their assistance during the experiment.

References

- Adeva-Andany, M.M., González-Lucán, M., Donapetry-García, C., Fernández-Fernández, C., Ameneiros-Rodríguez, E., 2016. Glycogen metabolism in humans. *BBA Clin.* 5, 85–100. doi:10.1016/j.bbacli.2016.02.001
- Atwood, H.L., Fontenot, Q.C., Tomasso, J.R., Isely, J.J., 2001. Toxicity of Nitrite to Nile Tilapia: Effect of Fish Size and Environmental Chloride. *N. Am. J. Aquac.* 63, 49–51. doi:10.1577/1548-8454(2001)063<0049:TONTNT>2.0.CO;2
- Austin, B., 1988. *Marine Microbiology*. Cambridge University Press, Cambridge.
- Barton, B.A., Iwama, G.K., 1991. Physiological changes in fish from stress in aquaculture with emphasis on the response and effects of corticosteroids. *Annu. Rev. Fish Dis.* 1, 3–26. doi:10.1016/0959-8030(91)90019-G
- Booth, M.A., Allan, G.L., 2003. Utilization of digestible nitrogen and energy from four agricultural ingredients by juvenile silver perch *Bidyanus bidyanus*. *Aquac. Nutr.* 9, 317–326. doi:10.1046/j.1365-2095.2003.00259.x
- Brauner, C.J., Val, A.L., Randall, D.J., 1993. The Effect of Graded Methaemoglobin Levels on the Swimming Performance of Chinook Salmon (*Oncorhynchus Tshawytscha*). *J. Exp. Biol.* 185, 121–135.
- Bureau, D.P., Kaushik, S.J., Cho, C.Y., 2002. Bioenergetics, in: Halver, J.E., Hardy, R.W. (Eds.), *Fish Nutrition*. Academic Press, pp. 2–59.

- Camargo, J.A., Alonso, A., Salamanca, A., 2005. Nitrate toxicity to aquatic animals: a review with new data for freshwater invertebrates. *Chemosphere* 58, 1255–1267. doi:10.1016/j.chemosphere.2004.10.044
- Camargo, J.A., Ward, J.V., 1992. Short-term toxicity of sodium nitrate (NaNO₃) to non-target freshwater invertebrates. *Chemosphere* 24, 23–28. doi:10.1016/0045-6535(92)90563-7
- Cheng, S.Y., Chen, J.C., 2002. Study on the oxyhemocyanin, deoxyhemocyanin, oxygen affinity and acid-base balance of *Marsupenaeus japonicus* following exposure to combined elevated nitrite and nitrate. *Aquat. Toxicol.* 61, 181–193. doi:10.1016/S0166-445X(02)00053-X
- Clarke, A., Johnston, N.M., 1999. Scaling of metabolic rate with body mass and temperature in teleost fish. *J. Anim. Ecol.* 893–905.
- Colt, J., 2006. Water quality requirements for reuse systems. *Aquac. Eng.* 34, 143–156. doi:10.1016/j.aquaeng.2005.08.011
- Colt, J., Lamoureux, J., Patterson, R., Rogers, G., 2006. Reporting standards for biofilter performance studies. *Aquac. Eng.* 34, 377–388. doi:10.1016/j.aquaeng.2005.09.002
- Dalsgaard, J., Lund, I., Thorarinsdottir, R., Drengstig, A., Arvonen, K., Pedersen, P.B., 2013. Farming different species in RAS in Nordic countries: current status and future perspectives. *Aquac. Eng.* 53, 2–13. doi:10.1016/j.aquaeng.2012.11.008
- Davidson, J., Good, C., Welsh, C., Summerfelt, S., 2011. The effects of ozone and water exchange rates on water quality and rainbow trout *Oncorhynchus mykiss* performance in replicated water recirculating systems. *Aquac. Eng.* 44, 80–96. doi:10.1016/j.aquaeng.2011.04.001
- Davidson, J., Good, C., Welsh, C., Summerfelt, S.T., 2014. Comparing the effects of high vs. low nitrate on the health, performance, and welfare of juvenile rainbow trout *Oncorhynchus mykiss* within water recirculating aquaculture systems. *Aquac. Eng.* 59, 30–40. doi:10.1016/j.aquaeng.2014.01.003
- De Smet, H., Blust, R., 2001. Stress responses and changes in protein metabolism in carp *Cyprinus carpio* during cadmium exposure. *Ecotoxicol. Environ. Saf.* 48, 255–262. doi:10.1006/eesa.2000.2011
- Dietz, C., Stiller, K.T., Griese, M., Schulz, C., Susenbeth, A., 2013. Influence of salinity on energy metabolism in juvenile turbot, *Psetta maxima* (L.). *Aquac. Nutr.* 19, 135–150. doi:10.1111/anu.12034
- Diwan, A.D., Hingorani, H.G., Naidu, N.C., 1979. Levels of blood glucose and tissue glycogen in two live fish exposed to industrial effluent. *Bull. Environ. Contam. Toxicol.* 21, 269–272. doi:10.1007/BF01685422

- Eckert, R., Burggren, W., French, K., Randall, D., 2002. Tierphysiologie, 4. Edition. ed. Georg Thieme Verlag, Stuttgart.
- Elliott, J.M., Davison, W., 1975. Energy equivalents of oxygen consumption in animal energetics. *Oecologia* 19, 195–201. doi:10.1007/BF00345305
- Evans, D.H., Piermarini, P.M., Choe, K.P., 2005. The Multifunctional Fish Gill : Dominant Site of Gas Exchange, Osmoregulation, Acid-Base Regulation, and Excretion of Nitrogenous Waste. *Physiol. Rev.* 85, 97–177. doi:10.1152/physrev.00050.2003.
- FAO, 2012. Cultured Aquatic Species Information Programme *Sander lucioperca* [WWW Document].Text by Zakęś, Z. Cult. Aquat. Species Inf. Programme FAO Fisheries and Aquaculture Department, Rome online, Updated 1 January 2012
- Frisk, M., Steffensen, J.F., Skov, P.V., 2013. The effects of temperature on specific dynamic action and ammonia excretion in pikeperch (*Sander lucioperca*). *Aquaculture* 404–405, 65–70. doi:10.1016/j.aquaculture.2013.04.005
- Gnaiger, E., 1983. Calculation of Energetic and Biochemical Equivalents of Respiratory Oxygen Consumption, in: Polarographic Oxygen Sensors. pp. 337–345.
- Hamlin, H.J., Moore, B.C., Edwards, T.M., Larkin, I.L.V., Boggs, A., High, W.J., Main, K.L., Guillette, L.J., 2008. Nitrate-induced elevations in circulating sex steroid concentrations in female Siberian sturgeon (*Acipenser baeri*) in commercial aquaculture. *Aquaculture* 281, 118–125. doi:10.1016/j.aquaculture.2008.05.030
- Hermelink, B., Wuertz, S., Rennert, B., Kloas, W., Schulz, C., 2013. Temperature control of pikeperch (*Sander lucioperca*) maturation in recirculating aquaculture systems—induction of puberty and course of gametogenesis. *Aquaculture* 400–401, 36–45. doi:10.1016/j.aquaculture.2013.02.026
- Hilge, V., Steffens, W., 1996. Aquaculture of fry and fingerling of pikeperch (*Stizostedion lucioperca* L.)—a short review. *J. Appl. Ichthyol.* 12, 167–170.
- Hrubec, T.C., Smith, S.A., Robertson, J.L., 1996. Nitrate Toxicity: A Potential Problem of Recirculating Systems, in: *Aquacult. Eng. Soc. Proc. Northeast Regional Agricultural Engineering Service Cooperative Extension*, Ithaca, NY, pp. 41–48.
- Ip, Y.K., Chew, S.F., Randall, D.J., 2001. Ammonia Toxicity, Tolerance and Excretion, in: Wright, P.A., Anderson, P.M. (Eds.), *Nitrogen Excretion*. Academic Press, pp. 109–148.
- Jensen, F.B., 1995. Uptake and effects of nitrite and nitrate in animals, in: Walsh, P.J., Wright, P.A. (Eds.), *Nitrogen Metabolism and Excretion*. CRC Press, Boca Raton, pp. 289–303.
- Jobling, M. (Ed.), 1994. *Fish Bioenergetics*, 1st ed. Chapman & Hall Fish & Fisheries Series 13, London.

- Jobling, M., 1981. The influences of feeding on the metabolic rate of fishes: a short review. *J. Fish Biol.* 18, 385–400. doi:10.1111/j.1095-8649.1981.tb03780.x
- Lauff, R.F., Wood, C.H.M., 1996. Respiratory gas exchange, nitrogenous waste excretion, and fuel usage during starvation in juvenile rainbow trout, *Oncorhynchus mykiss*. *J. Comp. Physiol. B* 165, 542–551. doi:10.1007/BF00387515
- Ložys, L., 2004. The growth of pikeperch (*Sander lucioperca* L.) and perch (*Perca fluviatilis* L.) under different water temperature and salinity conditions in the Curonian Lagoon and Lithuanian coastal waters of the Baltic Sea, in: Kautsky, H., Snoeijls, P. (Eds.), *Biology of the Baltic Sea*. Springer Netherlands, Dordrecht, pp. 105–113. doi:10.1007/978-94-017-0920-0_10
- Lucas, A., 1996. *Bioenergetics of aquatic animals*, English ed.. Taylor & Francis. doi:10.1016/S0044-8486(96)01412-3
- Lupatsch, I., Kissil, G.W., Sklan, D., 2003. Comparison of energy and protein efficiency among three fish species gilthead sea bream (*Sparus aurata*), European sea bass (*Dicentrarchus labrax*) and white grouper (*Epinephelus aeneus*): energy expenditure for protein and lipid deposition. *Aquaculture* 225, 175–189. doi:10.1016/S0044-8486(03)00288-6
- Maclsaac, P.F., Goff, G.P., Speare, D.J., 1997. Comparison of routine oxygen consumption rates of three species of pleuronectids at three temperatures. *J. Appl. Ichthyol.* 13, 171–176. doi:10.1111/j.1439-0426.1997.tb00117.x
- Mallekh, R., Lagardere, J., 2002. Effect of temperature and dissolved oxygen concentration on the metabolic rate of the turbot and the relationship between metabolic scope and feeding demand. *J. Fish Biol.* 60, 1105–1115. doi:10.1006/jfbi.2002.1918
- Martins, C.I.M., Ochola, D., Ende, S.S.W., Eding, E.H., Verreth, J.A.J., 2009a. Is growth retardation present in Nile tilapia *Oreochromis niloticus* cultured in low water exchange recirculating aquaculture systems? *Aquaculture* 298, 43–50. doi:10.1016/j.aquaculture.2009.09.030
- Martins, C.I.M., Pistrin, M.G., Ende, S.S.W., Eding, E.H., Verreth, J.A.J., 2009b. The accumulation of substances in Recirculating Aquaculture Systems (RAS) affects embryonic and larval development in common carp *Cyprinus carpio*. *Aquaculture* 291, 65–73. doi:10.1016/j.aquaculture.2009.03.001
- Mathis, N., Feidt, C., Brun-Bellut, J., 2003. Influence of protein/energy ratio on carcass quality during the growing period of Eurasian perch (*Perca fluviatilis*). *Aquaculture* 217, 453–464. doi:10.1016/S0044-8486(02)00122-9
- Monsees, H., Klatt, L., Kloas, W., Wuertz, S., 2016. Chronic exposure to nitrate significantly reduces growth and affects the health status of juvenile Nile tilapia

- (*Oreochromis niloticus* L.) in recirculating aquaculture systems. *Aquac. Res.* 1–11. doi:10.1111/are.13174
- Müller-Belecke, A., Zienert, S., Thürmer, C., Kaufhold, S., Spranger, U., 2013. The “self cleaning inherent gas denitrification-reactor” for nitrate elimination in RAS for pike perch (*Sander lucioperca*) production. *Aquac. Eng.* 57, 18–23. doi:10.1016/j.aquaeng.2013.06.001
- Palachek, R.M., Tomasso, J.R., 1984. Nitrite toxicity to fathead minnows: effect of fish weight. *Bull. Environ. Contam. Toxicol.* 32, 238–242. doi:10.1007/BF01607492
- Pierce, R.H., Weeks, J.M., Prappas, J.M., 1993. Nitrate Toxicity to Five Species of Marine Fish. *J. World Aquac. Soc.* 24, 105–107. doi:10.1111/j.1749-7345.1993.tb00156.x
- Romano, N., Zeng, C., 2009. Evaluating the newly proposed protocol of incorporated potassium in nitrate toxicity experiments at different salinities: a case study with the tiger prawn, *Penaeus monodon*, juveniles. *Aquaculture* 289, 304–309. doi:10.1016/j.aquaculture.2009.01.035
- Romano, N., Zeng, C., 2007. Effects of potassium on nitrate mediated alterations of osmoregulation in marine crabs. *Aquat. Toxicol.* 85, 202–208. doi:10.1016/j.aquatox.2007.09.004
- Schram, E., Roques, J.A.C., van Kuijk, T., Abbink, W., van de Heul, J., de Vries, P., Bierman, S., van de Vis, H., Flik, G., 2013. The impact of elevated water ammonia and nitrate concentrations on physiology, growth and feed intake of pikeperch (*Sander lucioperca*). *Aquaculture* 420–421, 95–104. doi:10.1016/j.aquaculture.2013.10.027
- Steinberg, K., Zimmermann, J., Stiller, K.T., Meyer, S., Schulz, C., 2017. The effect of carbon dioxide on growth and energy metabolism in pikeperch (*Sander lucioperca*). *Aquaculture* 481, 162–168. doi:10.1016/
- Stiller, K.T., Moran, D., Vanselow, K.H., Marxen, K., Wuertz, S., Schulz, C., 2013. A novel respirometer for online detection of metabolites in aquaculture research: evaluation and first applications. *Aquac. Eng.* 55, 23–31. doi:10.1016/j.aquaeng.2013.01.004
- Tilak, K.S., Veeraiyah, K., Milton Prema Raju, J., 2007. Effects of ammonia, nitrite and nitrate on hemoglobin content and oxygen consumption of freshwater fish, *Cyprinus carpio* (Linnaeus). *J. Environ. Biol.* 28, 45–47.
- Timmons, M., Ebeling, J., 2007. *Recirculating Aquaculture*, NRAC Publication No 01-007. Cayuga Aqua Ventures, Ithaca.
- Tirsgaard, B., Moran, D., Steffensen, J.F., 2015. Prolonged SDA and reduced digestive efficiency under elevated CO₂ may explain reduced growth in Atlantic cod (*Gadus morhua*). *Aquat. Toxicol.* 158, 171–180. doi:10.1016/j.aquatox.2014.11.009

- van Bussel, C.G.J., Schroeder, J.P., Wuertz, S., Schulz, C., 2012. The chronic effect of nitrate on production performance and health status of juvenile turbot (*Psetta maxima*). *Aquaculture* 326–329, 163–167. doi:10.1016/j.aquaculture.2011.11.019
- van Rijn, J., 2007. Denitrification, in: Timmons, M.B., Ebeling, J.M. (Eds.), *Recirculating Aquaculture*. NRAC Publication No 01-007, Cayuga Aqua Ventures, Ithaca, pp. 369–396.
- Wendelaar Bonga, S.E., 1997. The stress response in fish. *Physiol. Rev.* 77, 591–625.
- Wright, P., Anderson, P. (Eds.), 2001. *Nitrogen Excretion*. Academic Press, San Diego, London.
- Zakęś, Z., Szczepkowski, M., Jankowska, B., Kowalska, A., Demska-Zakęś, K., 2012. Slaughter yield and growth performance indexes of pikeperch (*Sander lucioperca* (L.)) selects reared in recirculating aquaculture systems at suboptimal temperatures. *Arch. Polish Fish.* 20, 281–288. doi:10.2478/v10086-012-0032-0

**CUMULATIVE FEED BURDEN HAS VARIOUS
EFFECTS ON PIKEPERCH (*Sander lucioperca*)
METABOLISM AND ON WATER QUALITY
PARAMETERS**

Kathrin Steinberg*^{1,2}, Jan Zimmermann^{1,2}, Stefan Meyer² and Carsten Schulz^{1,2}

¹Gesellschaft für Marine Aquakultur mbH, Hafentörn 3, 25761 Büsum, Germany

²Institute of Animal Breeding and Husbandry, Marine Aquaculture, Christian-Albrechts-Universität zu Kiel, Olshausenstraße 40, 24098 Kiel, Germany

Submitted on invitation for a special issue at *Aquacultural Engineering*

Abstract

This study assessed the effects of three levels of cumulative feed burden (CFB) on the metabolism of pikeperch (*Sander lucioperca*) and on water quality parameters in recirculating aquaculture systems (RAS). The experiment was conducted in twelve independent RAS stocked with pikeperch (average body weight 247.4 g). CFB levels were tested in quadruplicates as low CFB (water exchange of 1000 L per kg feed), medium CFB (water exchange of 500 L per kg feed) and high CFB (water exchange of 200 L per kg feed). The initial accumulation phase lasted 35 days and was followed by a consecutive steady state phase (21 days). Fish were fed daily at 0.9% BW with a commercial diet (ALLER Metabolica) and individual body weight was assessed after 14, 35 and 56 feeding days. Protein utilisation was significantly affected by CFB after 2 months, while the effect on growth rate and feed conversion only started to be measurable in the steady state period (after 35 days). No differences in health parameters were observed and no mortalities occurred during the experiment. As expected, the following water quality parameters correlated with CFB: NO₃-N, NO₂-N, TAN, TOC, TC and TSS over the course of the experiment. Analysis of heavy metals and trace elements showed a positive correlation between CFB and phosphorus, arsenic, copper, potassium and zinc. The study quantified the functional relationship between CFB and water quality, as well as pikeperch metabolism. Pikeperch exhibited positive growth up to CFB values of 4000 mg L⁻¹ but the threshold value for a CFB induced effect on SGR was identified at 1953 ± 613 mg L⁻¹.

Keywords: pikeperch, cumulative feed burden, RAS, water reuse, water quality

Introduction

Recirculating aquaculture systems (RAS) are defined by low water exchange rates and thus reduced environmental impacts (Timmons and Ebeling, 2007). State-of-the-art RAS allow for precise control of many water quality parameters and efficient removal of certain compounds. But the adverse effects of unintended and uncontrolled accumulation of metabolites and other substances introduced into the system on fish performance and welfare are poorly understood (Martins et al., 2009b).

Knowledge on the limits of water reuse in RAS is crucial in order to produce healthy fish in a cost effective way. Fine solids and organic compounds can have a direct impact on oxygen depletion processes in the RAS as well as biofilter efficiency and have been associated with disease outbreaks (Colt, 2006; Davidson et al., 2009; Michaud et al., 2006; Mozumder et al., 2014). Increased reuse of water has shown to cause accumulation of heavy metals and trace minerals and negatively influence morphology, physiology and behaviour (Lall, 2002; Martins et al., 2009b; van Bussel et al., 2014). Increased levels of nitrate in RAS were linked to deformities and abnormal swimming behaviour and affect energy metabolism (Davidson et al., 2014; Martins et al., 2009b; Steinberg et al., 2018). Research on the effects of different feed loadings on fish health and performance have shown growth inhibition (Deviller et al., 2005), abnormal swimming behaviour (Davidson et al., 2011) as well as reduced larval hatching and growth rates (Martins et al., 2009b).

The cumulative feed burden (CFB) is a term used to quantify mass input (feed) into the system over time in relation to water exchange (Colt et al., 2006), typically expressed as weight per volume (mg L^{-1}). It is used as a measure of production intensity and is most frequently used as a proxy for the interpretation of water quality parameters that are not treated for as such, e.g. fine solids and organic compounds, heavy metals and trace minerals, hormones or nitrate as the end product of the nitrogen cycle (Weaver et al., 2016).

Detailed knowledge on optimal water quality parameters for pikeperch (*Sander lucioperca*) in RAS production is scarce even though the demand for pikeperch from RAS has recently increased (Dalsgaard et al., 2013). Previous research on the effect of different environmental parameters on pikeperch solely focused on single water quality parameters only, neglecting interactions between parameters (Luchiari et al.,

2009; Schram et al., 2013; Steinberg et al., 2017; Tielmann et al., 2017; Zingel and Paaver, 2010).

The aim of the study was to quantify the functional relationship between three different levels of CFB and commonly measured water quality parameters and to assess their effect on growth and health parameters of adult pikeperch. From this basic functional relationship, it will be possible to draw conclusions on the necessity for further water treatment technologies, enabling a more precise water quality management in relation to fish health and performance. This holistic approach links previous research conducted on pikeperch to commercial aquaculture systems.

Material and methods

Experimental set-up

The experiment was conducted in twelve identical RAS (Kunststoff Spranger GmbH, Plauen, Germany) and the experimental set-up was divided into two phases. Phase 1, the accumulation phase (35 days) and phase 2, the steady state (21 days). CFB levels were tested in quadruplicates as low CFB (water exchange of 1000 L per kg feed), medium CFB (water exchange of 500 L per kg feed) and high CFB (water exchange of 200 L per kg feed). The water exchange rate in the high CFB treatment was increased from 100 L per kg feed to 200 L per kg feed at the beginning of the steady state phase (after 35 days) in order to not exceed the previously tested NO₃-N concentration of 240 mg L⁻¹ (Steinberg et al., 2018). CFB was calculated in mg L⁻¹ as

$$CFB = \frac{feed [mg]}{V [L]} + \frac{CFB_{(n-1)} [mg L^{-1}] \times (V [L] - R [L])}{V [L]}$$

Where V is the system volume, R is the amount of replacement water and CFB_(n-1) is the concentration of CFB on the previous day. Daily water exchange, i.e. the volume of replacement water (R), was determined by the actual feed intake of each RAS separately. Fish were hand fed with a commercial diet (ALLER Metabolica, 6mm, ALLER Aqua, Christiansfeld, Denmark, macro nutrient profile: moisture 7%, ash 8%, protein 53%, fat 15%, nitrogen-free extractives 17%, energy 21.3 MJ kg⁻¹, micro nutrients: 5 mg kg⁻¹ Cu, 12 mg kg⁻¹ Mn, 100 mg kg⁻¹ Zn, 1.2% P, 0.3% Na, 1% Ca) at 0.9% BW over

a period of four hours. Uneaten pellets were removed 15 minutes after the last administration of feed and counted to calculate the actual daily feed intake.

Every RAS consists of a rearing tank (300 L), a particle filter mat, a moving bed biofilm reactor (MBBR, Kunststoff Spranger GmbH, Plauen, Germany) and a protein skimmer (Erwin Sander, Uetze-Eltze, Germany) used for aeration of the system with technical oxygen. The flow rate through the biofilter was set to 600 L h⁻¹ and the flow rate through the aeration unit was 200 L h⁻¹. Temperature was set to 22.5 °C and kept within ± 0.5°C by a temperature controlled 500 W heater (Aqua Medic, Bissendorf, Germany). The pH was maintained at 7.2 by using sodium hydrogen carbonate (NaHCO₃). Salinity was kept at 3‰ using NaCl.

Pikeperch (*Sander lucioperca*) were obtained from Aquapri (Gamst, Denmark) and transferred to the experimental facility of the Gesellschaft für Marine Aquakultur (GMA) (Büsum, Germany) one month prior the start of the acclimatisation period of 10 days. Eighteen fish with an average weight of 247.4 ± 28.5 g were stocked in each RAS and fish were kept at constant dim light (20 lux). The experiment consisted of 56 feeding days.

Fish growth and performance

Individual body wet weight [g] and length [mm] of each fish was determined at the start (day 0) and end of the experiment (day 56). Additional weightings were conducted after 14 and after 35 days. Fish were marked individually in order to track individual growth rates. The feed conversion ratio (FCR) was calculated as $FCR = \text{feed intake} / \text{weight gain}$. The specific growth rate (SGR [% BW day⁻¹]) was calculated as $SGR = (\ln(\text{final biomass}) - \ln(\text{initial biomass})) / (\text{number of feeding days}) \times 100$. Daily feed intake (DFI [% BW day⁻¹]) was calculated as $DFI = FCR \times SGR$. Utilisation of dietary protein was calculated as PPV (protein productive value) and PER (protein efficiency ratio). PPV was calculated as $100 \times (\text{final body protein} - \text{initial body protein}) / \text{fed protein}$. PER equals the quotient of growth and protein intake. Fulton's formula was used to calculate the condition factor as $cf = (\text{fish weight} \times 100) / \text{fish length}^3$ according to Ricker (1975). At the end of the experiment, three fish per tank were freeze dried and homogenized for whole body composition analysis according to EU guidelines (EC) 152/2009 (European Commission, 2009). Additionally, liver and spleen of three fish per tank were removed to calculate

hepatosomatic index (HSI) and spleen index (SI) based on the organs wet weight. HSI and SI were calculated as liver or spleen weight / final fish weight × 100.

Water quality analysis

Temperature, oxygen (OxyGuard® Handy Polaris 2, OxyGuard® International A/S, Farum, Denmark) pH (multi 350i, WTW, Weilheim, Germany) and CO₂ (OxyGuard® CO₂ Portable, OxyGuard® International A/S, Farum, Denmark) were measured daily directly in each RAS. Small water samples were taken daily to measure turbidity (PCE-TUM 20, PCE GmbH, Meschede, Germany) and salinity (Refractometer HI 96822, HANNA Instruments, Woonsocket, USA). Weekly water samples were used to measure nitrate-nitrogen (NO₃-N), nitrite-nitrogen (NO₂-N) and total ammonia nitrogen (TAN) photometrically with pre-dosed photometric tests (Hach Lange GmbH, Düsseldorf, Germany), total carbon (TC), total organic carbon (TOC) (measured as non-purgeable organic carbon (NPOC)) and inorganic carbon (IC) by 720 °C combustion catalytic oxidation method (TOC-L_{CPH/CPN} + TNM-L Modul, Shimadzu Deutschland GmbH, Duisburg, Germany) alkalinity via titration (as CaCO₃) and total suspended solids (TSS) through filtration using 1.3 µm filtration papers. Concentration of Metals and minerals on the last day was analysed by Agrolab (AGROLAB Agrar und Umwelt GmbH, Kiel, Germany) according to DIN EN ISO 6878 (Phosphorus), DIN EN ISO 17294-2 (Arsenic, Potassium, Lead, Copper and Zinc) and DIN EN ISO 12846 (Mercury).

Statistics

All data is presented as mean \pm SD and was analysed and evaluated with the statistical software R-Studio Version 3.4.3 (2017). An appropriate statistical model was fitted to the data based on generalized least squares (Carroll and Ruppert, 1988) with CFB as the influence factor. The data were assumed to be normally distributed and to be heteroscedastic. These assumptions are based on a graphical residual analysis. Based on this model, a Pseudo R^2 was calculated (Nakagawa and Schielzeth, 2013) and multiple contrast tests according to Hasler and Hothorn (2008) were conducted. Differences were considered significant at $p < 0.05$. Linear regression analysis based on the CFB as independent factor was conducted for all water quality parameters in order to determine interaction dependencies. The correlation between the SGR and CFB was analysed using segmented least-squares linear regression. The analysis was performed using the software SegReg in order to detect the optimal break point (Oosterbaan, 1994).

Results

Controlled water quality parameters

Significant differences in CFB were anticipated and reached in the first week. Average water quality parameters for pH, T and O₂ are reported in Table 3-1 alongside the carbon and nitrogen water chemistry and concentration of suspended solids on the last day of the experiment. Temperature was maintained above 22°C, pH was maintained around 7.2 and oxygen was kept above 100%. Salinity was kept at 3 ppm by dosage of NaCl in order to reduce toxicity of occurring nitrite peaks (Wuertz et al., 2013).

Table 3-1 Water quality parameters in the RAS on the last day of the experiment. Values for pH, T and O₂ represent the average concentration over the whole experimental period.

parameter	unit	low CFB	medium CFB	high CFB
CFB	[mg L ⁻¹]	999.9 ± 0.0 ^a	1957.7 ± 29.7 ^b	4421.9 ± 17.0 ^c
pH		7.21 ± 0.13	7.19 ± 0.15	7.16 ± 0.15
T	[°C]	22.6 ± 0.2	22.6 ± 0.3	22.6 ± 0.3
O ₂	[mg L ⁻¹]	10.7 ± 0.8 ^a	10.9 ± 0.9 ^a	11.3 ± 1.0 ^b
NO ₃ -N	[mg L ⁻¹]	38.0 ± 1.3 ^a	70.4 ± 0.8 ^b	164.9 ± 4.1 ^c
NO ₂ -N	[mg L ⁻¹]	0.16 ± 0.04	0.43 ± 0.24	1.56 ± 1.4
TAN	[mg L ⁻¹]	0.45 ± 0.08	0.41 ± 0.05	0.52 ± 0.20
TOC	[mg L ⁻¹]	20.4 ± 3.4 ^a	32.5 ± 1.8 ^b	47.0 ± 7.5 ^b
TC	[mg L ⁻¹]	46.0 ± 1.6 ^a	52.0 ± 7.8 ^a	81.4 ± 13.4 ^b
IC	[mg L ⁻¹]	25.5 ± 2.2	19.5 ± 6.7	34.3 ± 8.8
TSS	[mg L ⁻¹]	11.68 ± 2.60	16.92 ± 6.96	20.95 ± 12.28
CaCO ₃	[mg L ⁻¹]	106.8 ± 20.6	89.0 ± 25.2	151.3 ± 37.0
CO ₂	[mg L ⁻¹]	12.5 ± 0.6	9.3 ± 4.3	16.5 ± 6.1

CFB: cumulative feed burden; NO₃-N: nitrate-nitrogen; NO₂-N: nitrite-nitrogen; TAN: total ammonia-nitrogen; TOC: total organic carbon; TC: total carbon; IC: inorganic carbon; TSS: total suspended solids. Superscript letters indicate significant differences between CFB levels (low, medium and high).

Carbonate chemistry

The carbon water chemistry parameters are given in Table 3-1. The concentration of total carbon did only show a slight increase in the low CFB treatment compared to the start of the experiment but was significantly increased by nearly 2-fold to $81.4 \pm 13.4 \text{ mg L}^{-1}$ in the high CFB treatment. Total organic carbon was increased in all treatments from 1.78 mg L^{-1} at the start to $20.4 \pm 3.4 \text{ mg L}^{-1}$ in the low CFB treatment and $32.5 \pm 1.8 \text{ mg L}^{-1}$ and $47.0 \pm 7.5 \text{ mg L}^{-1}$ in the medium and high CFB treatment respectively. There was a clear dose dependant relation between increasing CFB levels and increasing TOC and TC levels. The amount of inorganic carbon did not differ between treatments. The CO_2 concentration increased in all treatments compared to the start of the experiment and showed a linear correlation with different CFB levels although being subject to high fluctuations between the tanks in all treatments. Highest values were reached in the high CFB treatment with $16.5 \pm 6.1 \text{ mg L}^{-1}$. Evaluation of water hardness showed a linear increase in calcium carbonate (CaCO_3) concentration with increasing CFB levels.

Nitrogenous waste

Concentration of $\text{NO}_3\text{-N}$ was significantly different between the treatments (Table 3-1) and increased linearly with increasing CFB over the experimental period. A steady state in terms of nitrate-nitrogen concentration was reached in all treatments by week 6 (Fig. 3-1). There are no significant differences in TAN concentration on the last day of the experiment (Table 3-1) but there is a linear relationship between TAN concentration and CFB levels over the whole experimental period. Highest measured concentration of TAN was 0.8 mg L^{-1} ($0.5 \text{ }\mu\text{M NH}_3\text{-N}$) thus not exceeding the advised water NH_3 concentration of $3.4 \text{ }\mu\text{M}$ (Schram et al., 2013). Concentrations of $\text{NO}_2\text{-N}$ were higher in the high CFB treatment on the last day of the experiment (Table 3-1) and correlated linearly with the CFB levels. The course of $\text{NO}_2\text{-N}$ concentration over the whole experimental period is shown in Fig. 3-2. Each tank showed a peak in $\text{NO}_2\text{-N}$ concentration in the first week and a second peak in week 6 (low and medium) or week 7 (high). The second peaks are significantly different at $0.66 \pm 0.11 \text{ mg L}^{-1} \text{ NO}_2\text{-N}$ (low CFB treatment), $1.05 \pm 0.08 \text{ mg L}^{-1} \text{ NO}_2\text{-N}$ (medium CFB treatment) and $3.19 \pm 0.98 \text{ mg L}^{-1} \text{ NO}_2\text{-N}$ (high CFB treatment).

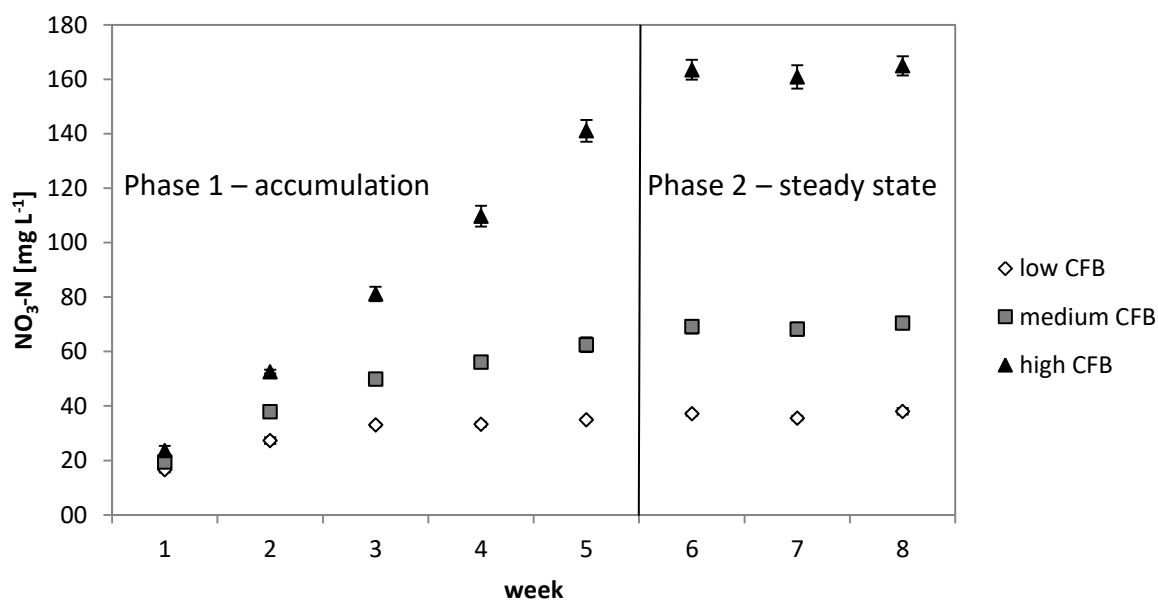

Figure 3-1 Nitrate-nitrogen concentration (mean \pm SD, $n = 4$) over the course of the experiment

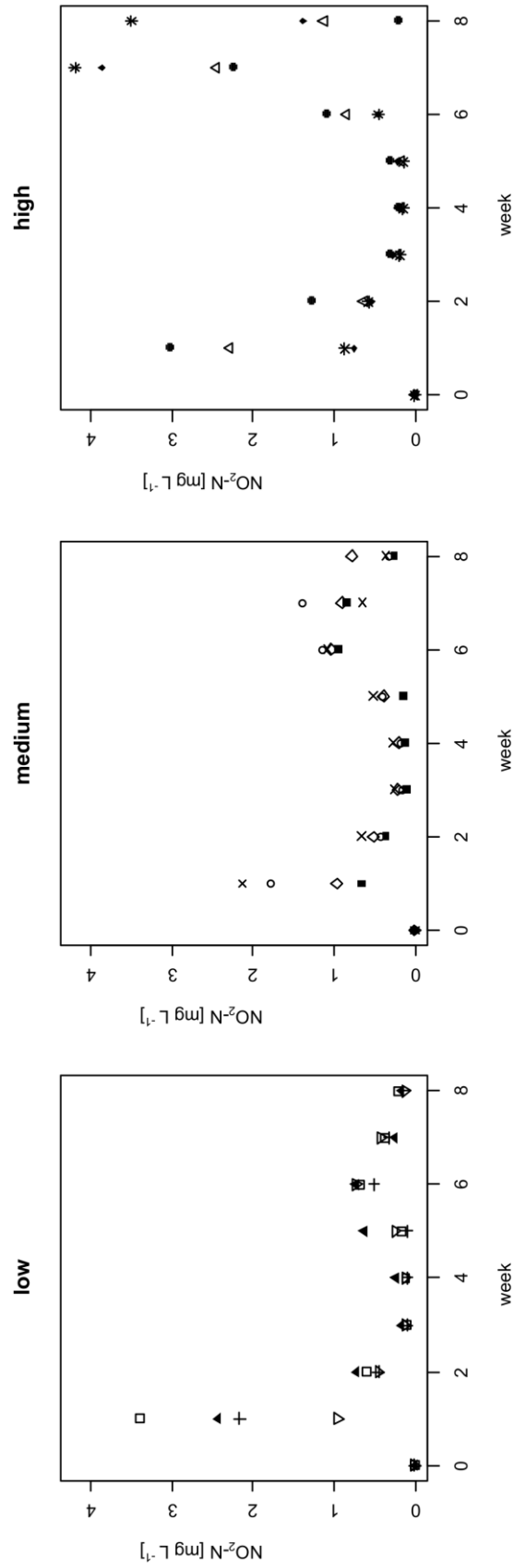

Figure 3-2 Weekly $\text{NO}_2\text{-N}$ concentrations in the different CFB treatments (low, medium and high). Different symbols represent different tanks.

Total suspended solids and minerals

The amount of total suspended solids (TSS) increased linearly in all treatments from 0.00 mg L⁻¹ at the start of the experiment to 11.68 ± 2.60 mg L⁻¹ and 16.92 ± 6.96 mg L⁻¹ in the low and medium treatment respectively (Table 3-1). The highest value was reached in the high CFB treatment at 20.95 ± 12.28 mg L⁻¹. Analysis of heavy metals and trace elements (Table 3-2) on the last day of the experiment showed a linear correlation between CFB levels and phosphorus, potassium, arsenic and copper. Concentration of lead and mercury was below detection limit in all water samples. The average zinc concentration in all tanks was 0.161 ± 0.132 mg L⁻¹ with the two highest values of 0.529 and 0.285 mg L⁻¹ in the medium CFB treatment. Concentration of heavy metals and minerals in the make-up water was according to the German drinking water ordinance with mercury, arsenic and lead below the detection limit. Phosphorus was 0.08 mg L⁻¹, copper 0.01 mg L⁻¹, potassium 1.18 mg L⁻¹ and zinc 0.665 mg L⁻¹.

Table 3-2 Mean (± SD) dissolved metal and nutrient concentrations in the three treatments on the last day of the experiment.

parameter	unit	low CFB	medium CFB	high CFB	<i>p</i> -value
PO ₄	[mg L ⁻¹]	5.1 ± 0.7 ^a	9.5 ± 0.4 ^b	16.8 ± 1.3 ^c	0.000
Arsenic	[mg L ⁻¹]	< 0.001*	0.002 ± 0.001 ^a	0.003 ± 0.001 ^b	0.000
Copper	[mg L ⁻¹]	0.014 ± 0.001	0.014 ± 0.002	0.016 ± 0.001	0.043
Lead	[mg L ⁻¹]	< 0.001*	< 0.001*	< 0.001*	
Mercury	[mg L ⁻¹]	< 0.0001*	< 0.0001*	< 0.0001*	
Potassium	[mg L ⁻¹]	22.1 ± 2.63	26.2 ± 8.8	34.0 ± 10.2	0.049
Zinc	[mg L ⁻¹]	0.096 ± 0.009	0.249 ± 0.208	0.139 ± 0.067	> 0.05

* Below detection limits

Superscript letters indicate significant differences between CFB levels (low, medium and high). *P*-values below 0.05 indicate a linear relationship between the concentration and the CFB level.

Overall Fish Performance

Growth performance and health parameters for the whole experimental period can be seen in Table 3-3. Average final biomass was significantly reduced in the medium CFB treatment at 370.9 ± 78.2 g compared to the low CFB treatment at 397.4 ± 60.7 g but not significantly different from high CFB treatment (388.8 ± 56.1 g). Fluctuations within the treatment were higher in the medium CFB treatment compared to the low and the high CFB treatment. The condition factor was significantly decreased in the medium CFB treatment (0.87 ± 0.14) compared to the low CFB treatment (0.93 ± 0.14) whereas the cf for the low and high CFB treatment was similar.

The CFB did not show a significant impact on HSI (hepatosomatic index) or SI (spleen index) in any treatment group at the end of the experiment (Table 3-3), but HSI in the high CFB treatment was significantly higher at the end of the experiment (1.33 ± 0.27) than in the initial sample group (0.86 ± 0.02) at the start of the experiment. There were no differences in the initial and the final SI in any of the CFB treatments, with an average value of 0.10 ± 0.04 . Significant effects of different CFB levels could be seen in the PPV where the average value in the low CFB treatment of 30.34 ± 0.26 was significantly higher than the average PPV in the high CFB treatment with 28.43 ± 0.86 .

Table 3-3 Mean values (\pm SD) of fish growth and health parameters.

parameter	unit	n	low CFB	medium CFB	high CFB
start weight	[g]	72	247.3 ± 26.9	247.2 ± 29.4	246.8 ± 29.7
end weight	[g]	72	397.4 ± 60.7^a	370.9 ± 78.2^b	388.8 ± 56.1^{ab}
CF		72	0.93 ± 0.14^a	0.87 ± 0.14^b	0.92 ± 0.11^{ab}
HSI	[% BW]	12	1.20 ± 0.18	1.08 ± 0.33	1.33 ± 0.27
SI	[% BW]	12	0.10 ± 0.04	0.10 ± 0.04	0.11 ± 0.04
PPV	[% BW]	4	30.34 ± 0.26^a	26.65 ± 4.94^{ab}	28.43 ± 0.86^b

CF: Fulton's condition factor, HSI: hepatosomatic index; SI: spleen index; PPV: protein productive value, start values (n = 3) were HSI: 0.86 ± 0.02 , SI: 0.10 ± 0.03 , CF (n = 216): 0.83 ± 0.10 , Superscript letters indicate significant differences between CFB levels (low, medium and high).

Growth Rate, Feed Intake and Efficiency

Specific growth rate (SGR), daily feed intake (DFI) and feed conversion ratio (FCR) for the two experimental phases can be seen in Table 3-4 (phase 1 – accumulation) and Table 3-5 (phase 2 – steady state). SGR was similar among all groups with an average of 0.82 ± 0.08 in the accumulation phase and slightly reduced SGR of 0.75 ± 0.15 in the steady state. Pikeperch in both the medium and the high CFB treatment showed a decrease in SGR towards the end of the experiment to an average of 0.62 ± 0.19 in the medium CFB treatment and 0.76 ± 0.10 in the high CFB treatment. The SGR in the low CFB treatment increased from an average of 0.84 ± 0.02 in the first experimental period to an average of 0.86 ± 0.05 for the rest of the experiment thus not showing the same decrease as the medium and high CFB treatments. The daily feed intake was set to a nominal feed intake of 0.9% bodyweight per day in all treatments. An average DFI of 0.88 ± 0.01 and 0.87 ± 0.02 could be achieved in the low and high CFB treatment with no significant difference in voluntary feed intake throughout the two experimental phases, respectively. Opposed to this, the DFI in the medium CFB treatment showed a slight decrease from 0.84 ± 0.08 in the accumulation phase to 0.81 ± 0.10 during the steady state.

Protein efficiency ratio (PER) (Table 3-4 and 3-5) was similar among all treatments in the accumulation phase with an average of 1.77 ± 0.11 . There was a significant difference in PER between the low and medium CFB treatment during the steady state where PER in the low treatment increased slightly to 1.85 ± 0.08 and PER in the medium CFB decreased significantly to 1.43 ± 0.31 .

Table 3-4 Fish growth parameters as mean (\pm SD) during phase 1 (accumulation) of the experiment.

parameter	unit	n	low CFB	medium CFB	high CFB
SGR	[% BW day ⁻¹]	4	0.84 \pm 0.02	0.78 \pm 0.15	0.84 \pm 0.03
DFI	[% BW day ⁻¹]	4	0.88 \pm 0.01	0.84 \pm 0.08	0.88 \pm 0.01
FCR		4	1.05 \pm 0.02	1.11 \pm 0.14	1.05 \pm 0.03
PER		4	1.80 \pm 0.03	1.73 \pm 0.20	1.80 \pm 0.05

SGR: specific growth rate; DFI: daily feed intake; FCR: feed conversion ratio, PER: protein efficiency ratio

Table 3-5 Fish growth parameters as mean (\pm SD) during the steady state phase (phase 2).

parameter	unit	n	low CFB	medium CFB	high CFB
SGR	[% BW day ⁻¹]	4	0.86 \pm 0.05*	0.62 \pm 0.19*	0.76 \pm 0.10
DFI	[% BW day ⁻¹]	4	0.88 \pm 0.01	0.81 \pm 0.10	0.87 \pm 0.03
FCR		4	1.03 \pm 0.04*	1.38 \pm 0.30*	1.16 \pm 0.12
PER		4	1.85 \pm 0.08 ^a	1.43 \pm 0.31 ^b	1.64 \pm 0.16 ^{ab}

SGR: specific growth rate; DFI: daily feed intake; FCR: feed conversion ratio, PER: protein efficiency ratio, superscript letters indicate significant differences between CFB levels (low, medium and high) at $p \leq 0.05$, trends ($p \leq 0.1$) are indicated by star symbols.

Segmented linear regression

Results of the segmented linear regression analysis are shown in Fig. 3-3. Analysis was conducted with $n = 216$ based on the three weighing's and the corresponding, calculated SGRs per fish as a function of the CFB. The segmented linear regression shows an increase in SGR for low CFB values with the peak at $1953 \pm 613 \text{ mg L}^{-1}$. CFB values higher than 1953 mg L^{-1} were negatively correlated with SGR. In other words, the segmented linear regression identified a functional relationship between CFB and SGR and a CFB threshold value, based on growth performance. This threshold value was used to calculate presumable thresholds for the different water quality parameters based on the linear regression analysis of the water quality parameter upon CFB over the whole experimental period (if applicable). The resulting threshold ranges for the individual parameters are shown in Table 3-6.

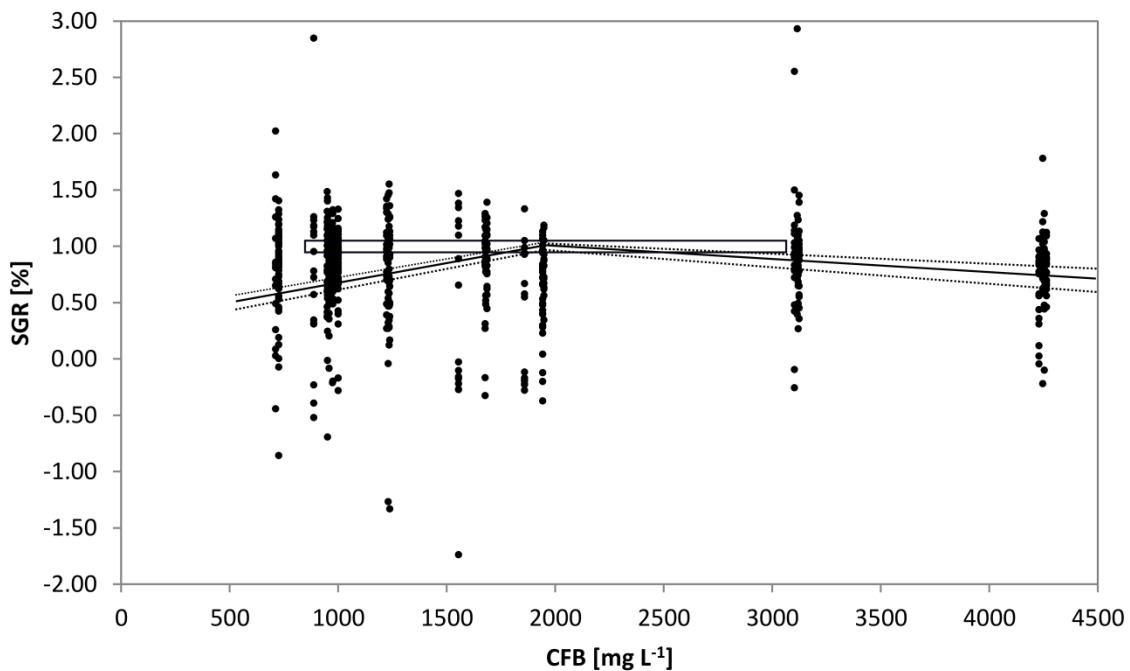

Figure 3-3 Segmented linear regression of individual SGRs upon the average CFB in the corresponding experimental period. Dashed lines indicate the 90% confidence belt. The box indicates the 90% confidence block of the break-point.

Table 3-6 Range of water quality parameters corresponding to the CFB threshold value of $1953 \pm 613 \text{ mg L}^{-1}$ (identified via segmented linear regression).

parameter	unit	threshold range
NO ₃ -N	[mg L ⁻¹]	45.2 – 94.6
NO ₂ -N	[mg L ⁻¹]	0.51 – 1.03
TAN	[mg L ⁻¹]	0.29 – 0.38
TOC	[mg L ⁻¹]	14.6 – 29.6
TC	[mg L ⁻¹]	33.6 – 51.6
IC	[mg L ⁻¹]	*
TSS	[mg L ⁻¹]	5.6 – 14.5
CO ₂	[mg L ⁻¹]	7.1 – 9.7
CaCO ₃	[mg L ⁻¹]	*

* no correlation between the water quality parameter and the CFB, thus no calculation of threshold range applicable. Threshold range was calculated based the correlation between the water quality parameter and the CFB over the whole course of the experiment.

Discussion

This experimental study has shown that the cumulative feed burden methodology is a valid approach to mimic realistic conditions of intense recirculating aquaculture systems (RAS) in a controlled laboratory environment. This approach can be used to simulate the multifactorial changes in various water quality parameters and interactions with fish performance and health. In combination with the segmented linear regression analysis, we were able to determine a sound functional relationship between the multitude of water quality parameters, approximated by CFB, and fish performance, approximated as SGR. We can therefore conclude that CFB could be used as a general proxy to quantify and compare the intensity of RAS systems.

Nitrogenous compounds

Nitrate concentration increased over the course of the experiment according to CFB levels, i.e. as a direct function of feed input into the system and water exchange. Nitrate is the final N-compound of aerobic nitrification and is therefore the main water quality parameter determining the effective water exchange rate of RAS systems.

Nitrate has been identified to have an effect on the energy maintenance of pikeperch when exceeding 120 mg L^{-1} NO₃-N in single factor experiments and it is recommended

to keep nitrate-nitrogen concentrations around 30 mg L^{-1} (Steinberg et al., 2018). The present study was able to narrow down the bandwidth of recommendable $\text{NO}_3\text{-N}$ concentration, based on the segmented linear regression analysis, to a range of less than 50 mg L^{-1} (range from 45.2 to 94.6 mg L^{-1}) instead of the aforementioned range of 90 mg L^{-1} (range from 30 to 120 mg L^{-1}). The practical added value of this information is rooted in the fact that this effective nitrate concentration range is deduced from the integrated parameter CFB and therefore taking all other potential and factual interactions with other water quality parameters into consideration.

Nitrite removal rates were affected by both CFB and time and concentration of $\text{NO}_2\text{-N}$ should presumably not exceed $0.51 - 1.03 \text{ mg L}^{-1}$. All RAS systems in this study showed a nitrite peak in the first week of the experiment. This is very well in line with the typical start-up characteristics in terms of a nitrite peak and were tackled by using biocarriers from an existing biofilter and pre-seeding the different RAS with ammonia prior to the start of the experiment (Timmons and Ebeling, 2007). A second nitrite peak was observed in week 6 or 7 in all treatment tanks with the highest nitrite peaks in the high CFB treatment being significantly higher than the peaks in the other treatments. It cannot be completely excluded that uncontrolled denitrification occurred in this experiment, potentially leading to increased nitrite formation. However, the constantly high oxygen concentrations generally hinder denitrification. It can only be speculated that after 6-7 weeks, the build-up of organic material and heterotrophic bacteria in the moving bed biofilters and RAS system in general caused these fluctuations. Heterotrophic bacteria show higher growth rates than nitrifiers thus inhibiting nitrification rates (Ebeling et al., 2006; Mozumder et al., 2014; Zhu and Chen, 2001). Nitrite concentrations were at no time high enough to potentially have a negative effect on fish health, especially because of the administration of a salinity of 3 ppm in all tanks (Wuertz et al., 2013). Nevertheless, unexpected fluctuations in nitrite-nitrogen concentration could potentially have sublethal effects on pikeperch thus highlighting the importance for routine water chemistry analysis.

Solids and organic compounds

Solids accumulate in RAS as a result of fish faeces, uneaten feed and biofilm abrasion (Colt, 2006; Timmons and Ebeling, 2007). Fine solids and organic compounds have been linked to gill irritations and disease outbreaks but effects are uncertain and

information is scarce (Colt, 2006; Zhang et al., 2011). Organic carbon concentration increased over time in all treatments and was significantly higher in the high CFB treatment. The estimated TOC threshold range of 14.6 – 29.6 mg L⁻¹ was exceeded in all CFB treatments at the end of the experiment. Organic carbon acts as an energy substrate for microorganisms and increased loads of organic carbon cause an increment in solids due to the growing bacterial biomass (Mook et al., 2012). This bacterial biomass can cause an increase in oxygen demand thus resulting in the necessity for higher oxygen supplementation (Ebeling et al., 2006). The amount of suspended solids in the CFB treatments was subject to high, tank specific, fluctuations, possibly caused by differences in swimming and dabbling behaviour of the fish and the absence of a mechanical filtration unit. Timmons and Ebeling (2007) recommend to not exceed TSS concentrations of 25 mg L⁻¹ in RAS and suggest 10 mg L⁻¹ for the safe operation of freshwater systems. The threshold concentration of suspended solids in this experiment was estimated between 5.6 – 14.5 mg L⁻¹ thus similar to the general recommendations by Timmons and Ebeling (2007). The upper limit of the recommendations of 25 mg L⁻¹ was only exceeded in one tank in the high CFB treatment but the safe levels were considerably exceeded in the high CFB treatment with mean concentrations of 20.95 ± 12.28 mg L⁻¹. The RAS did not contain a drum filter thus removal of suspended solids was lower than it would be expected in a commercial system. Research on bacteria and nutrients in RAS showed that a good mechanical filtration unit is crucial in order to control growth of heterotrophic bacteria while concentration of organic matter depends on the quantity of replacement water (Leonard et al., 2002). Lower values of heterotrophic bacteria, organic matter and suspended solids are not only positive for the nitrifying bacteria but removal also reduces potential negative effects on fish health and taste (Chaudhary et al., 2003; Pedersen et al., 2012). The manner of filtration has therefore to be considered when working with CFB levels and CFB thresholds are likely higher when drum filters or similar are used. Nevertheless, the results indicate that pikeperch are more robust against solids than previously assumed.

Carbon dioxide

Based on the segmented regression analysis the threshold range for CO₂ concentrations for adult pikeperch in RAS is estimated between 7.1 to 9.7 mg L⁻¹.

Previous research on the effect of carbon dioxide on adult pikeperch identified a linear correlation between CO₂ levels and weight gain, concluding that CO₂ concentrations should be kept below 15 mg L⁻¹ (Steinberg et al., 2017). Steinberg et al. (2017) provides a good example for an experimental RAS study evaluating the effect of a single water quality parameter (CO₂) under full control of all other main water quality parameters. As a result the study deduced a significantly higher threshold value for CO₂, which is correct only for the arbitrary scenario of all other parameters being well below realistic (in sense of industrial application) thresholds or fluctuations (plasticity of a multifactorial system). Opposed to this, the present study recommends a much lower threshold (upper limit of the recommended range: 9.7 mg L⁻¹) for CO₂ - induced adverse effects. This suggests that pikeperch had a lot more difficulties to compensate the effect of elevated CO₂ concentrations when other water quality parameters were deteriorating at the same time. Elevated levels of CO₂ have been identified to affect fish growth by influencing oxygen consumption rates but the exact physiological mechanisms are still poorly understood (Steinberg et al., 2017; Stiller et al., 2015). Nitrate is known to also affect the osmoregulatory ability and cause methemoglobinemia (Hamlin et al., 2008; Tilak et al., 2007). The concomitant exposure to CO₂ and nitrate (and other parameters) is likely to enhance the effects on physiological mechanisms. Furthermore, it is worthwhile noting that the overall width of the recommended range (2.6 mg L⁻¹ difference between lower and upper limit) is very narrow. Assuming that one or more specific physiological mechanism of maintaining homeostasis is involved, it can be speculated that this very mechanism was hampered fairly abruptly (narrow range of recommendable CO₂ concentration) and this hampering was clearly induced by the interaction with the overall deterioration of water quality. Further research is suggested to better understand the mechanisms of maintaining CO₂ homeostasis under such complex water quality conditions. These findings underline the importance of multifactorial experiments in order to predict effects in commercial aquaculture facilities as thresholds are likely to decrease when several environmental parameters decline.

Heavy Metals

Several studies have shown that an increased reuse of water provokes accumulation of heavy metals and minerals in the recirculating water as well as in the fish (Martins et

al., 2009b; van Bussel et al., 2014). The results of this trial show a clear dose dependant correlation between CFB levels and phosphorus, potassium, arsenic and copper thus showing that the CFB directly affects the water composition in terms of metals and minerals. Toxicity data for most of the aforementioned heavy metals and minerals is scarce and seldom determined for pikeperch. The concentration of copper in this experiment with $0.016 \pm 0.002 \text{ mg L}^{-1}$ in the high CFB treatment is still well below the generally held safe criterion for salmonids of 0.03 mg L^{-1} , but exceeds the no observable effect concentration for zebrafish larvae at $0.05 \mu\text{g L}^{-1}$ (Dave and Xiu, 1991; Davidson et al., 2009). Copper toxicity generally causes reduced growth and feed efficiency both of which could not be observed in the present study (Lall, 2002). It can be assumed that copper toxicity is above 0.16 mg L^{-1} for adult pikeperch. Similar conclusions can be drawn from the potassium ($34.00 \pm 10.18 \text{ mg L}^{-1}$), phosphorus ($16.8 \pm 1.3 \text{ mg L}^{-1}$) and arsenic ($0.003 \pm 0.001 \text{ mg L}^{-1}$) concentrations in the high CFB treatment. Low effluent concentrations of phosphorus are of interest to commercial fish farms due to environmental regulations. Concentration of zinc did not show a dose dependant trend. The average concentration in most tanks was below 0.1 mg L^{-1} but reached levels as high as 0.285 mg L^{-1} and 0.529 mg L^{-1} in two separate tanks of the medium CFB treatment. Concentration in the makeup water was 0.665 mg L^{-1} thus higher than in all treatment tanks. Zinc is essential for fish metabolism and uptake can be through feed or directly from the water (Canli and Atli, 2003; Wood, 2001). Zn concentration in the feed was 100 mg kg^{-1} . The increased Zn concentrations in the two tanks is likely caused by leaching from the feed as both tanks did show a lower feed intake thus resulting in more uneaten pellets in the tank. Uneaten feed was removed from the tanks after feeding but leaching starts instantly, thus negatively influencing water quality. Previous research on the effects of zinc on different fish species found 96h LC50 values for freshwater fish from 0.60 mg L^{-1} for fathead minnows (*Pimephales promelas*) (Benoit and Holcombe, 1978) up to 7.210 mg L^{-1} for rainbow trout (*Oncorhynchus mykiss*) (Sinley et al., 1974). Both tanks with increased zinc values showed reduced SGRs (0.50 and 0.71) compared to the other two tanks in the same treatment and were the main cause for the high standard deviation for all fish parameters in the medium CFB treatment. Increased zinc values could cause

decreased growth while the decreased growth could also be the reason for the higher zinc values due to the abated need for zinc uptake.

It can be hypothesized that pikeperch possess one or more physiological mechanisms to eliminate heavy metals from the metabolism or at least to counteract their effect on homeostasis. Opposed to the analogous hypothesis for recommendable CO₂ ranges in this study (see above), the multifactorial exposure to a complex water quality deterioration did not hamper the ability to handle the aforementioned heavy metals and minerals. This suggests that pikeperch are able to maintain physiological functioning of mineral metabolism and heavy metal detoxification even under otherwise stressful conditions. The underlying physiological pathways and mechanisms supporting this hypothesis are hitherto not understood. Further research on metal toxicity and mineral metabolism in pikeperch are desperately needed.

Fish performance

The results of the trial show that water quality was clearly influenced by different CFB levels thus anticipating an effect on pikeperch growth performance and health status. Pikeperch in this study showed a significant impact of CFB on protein utilisation after 2 months, while the effect on growth rate and feed conversion only started to be measurable in the steady state period (after 35 days). This is in line with findings by Steffens (1981) who stated that changes in protein utilisation take up to 2 – 3 months before the effects are evident in growth parameters. Effects on protein utilisation indicate that increasing levels of CFB lead to stress for the fish as protein catabolism is a known reaction to various stressors (Barton and Iwama, 1991; De Smet and Blust, 2001; Wendelaar Bonga, 1997). The identification of the causal agent for the increased protein catabolism is subject to speculation. Similar results in previous trials on nitrate as a single factor suggest that the increasing nitrate concentration affected the metabolism (Steinberg et al., 2018). The general condition of the pikeperch improved significantly over time in all CFB treatments as indicated by Fulton's condition factor (cf) with an average of 0.91 at the end of the experimental period. This is in line with previous studies on pikeperch or the closely related walleye (*Sander vitreus*) in RAS where cf was generally between 0.7 and 1.02 (Davidson et al., 2016; Hermelink et al., 2011; Schulz et al., 2007; Steinberg et al., 2017). Alongside the average FCR of 1.1, this illustrates that all CFB levels were generally acceptable for commercial pikeperch

production. Differences in FCR between the CFBs started to increase in the steady state phase where the FCR in both medium and high CFB showed an increase compared to the accumulation phase while it stayed constant in the low CFB treatment. Although lacking significant differences, the changes in the SGR within the different CFB treatments suggest a certain dependency on the CFB rate. High fluctuations, especially in SGR, in the medium CFB treatment are likely caused by tank specific effects such as the increased zinc concentration. The relationship between SGR and CFB clearly indicates that SGR started to decrease in the last phase of the experiment for the medium and high CFB treatment, while it stayed constant in the low CFB treatment. It might be speculated that the combination of increased CFB levels and increased duration of husbandry at these concentrations had a negative effect on SGR. Due to the fact that there are no changes in SGR for the low CFB treatment we hypothesize that the decrease is solely caused by the CFB and not by the duration of husbandry. Future research would need a longer steady state period in order to evaluate habituation effects.

The segmented regression analysis showed a clear effect of CFB on SGR with a peak at $1953 \pm 613 \text{ mg L}^{-1}$. The results indicate that both lower and higher concentrations of CFB negatively influence pikeperch metabolism. While higher CFB levels were expected to negatively influence pikeperch, especially due to increased nitrate and solids concentrations, the exact reasons for the negative influence of low CFB levels is subject to speculation. As aquatic life needs macro and micro nutrients and inorganic compounds for skeletal formation and maintaining body functions (Lall, 2002; Watanabe et al., 1997), the absence in lower CFB levels could have negatively influenced the fish. Similar effects have been identified in Nile Tilapia (*Oreochromis niloticus*) who seemed to grow better in high accumulation RAS compared to medium accumulation RAS (Martins et al., 2009a).

Conclusion

This study showed that the cumulative feed burden (CFB) has a significant impact on the water quality and fish performance in RAS. The detailed assessment of different water quality parameters during the accumulation of the CFB as well as during the steady state provides a valuable insight in the development and changes of water

chemistry in RAS. Low salinity levels should be implicated in order to reduce nitrite toxicity. Nevertheless, the differences in the protein productive value demonstrate that CFB has a direct effect on pikeperch and emphasizes the importance of collecting a variety of fish health parameters, especially in short term experiments, in order to detect initial effects. These findings are furthermore supported by the decline in SGR in the medium and high CFB treatment during the steady state period.

The segmented regression analysis showed that the CFB for adult pikeperch in RAS causes negative effects on SGR when exceeding $1953 \pm 613 \text{ mg L}^{-1}$. As a practical recommendation, this threshold value should not be exceeded in RAS. Additionally the present study was able to relate this functional relationship between CFB and fish performance back to individual water quality parameters that were hitherto only considered individually. As a consequence, this study suggests to re-evaluate the commonly referenced recommendable thresholds for nitrate and CO_2 exposure in pikeperch RAS production, because they are based on single-factorial laboratory studies and most likely underestimate the true adverse effect of these compounds under complex (realistic) RAS water quality conditions. This study could furthermore identify threshold levels for other water quality parameters (nitrite, ammonia, suspended solids, organic carbon and total carbon) under realistic RAS conditions. The minerals and heavy metals under investigation in this study, are presumably not affecting pikeperch at the occurring concentrations, even though our very limited understanding of the complex pathways and mechanisms involved in uptake, metabolism and detoxification condemns the current hypothesis to mere speculation.

While the CFB approach can be used to mimic realistic, commercial situations, it is impossible to identify the single water quality parameter affecting the fish. Identification of the main water quality parameters causing pikeperch to increase protein catabolism in high CFB levels is subject to speculation but the segmented regression analysis provides a more detailed insight on the thresholds of single water quality parameters. The identified threshold ranges of $45.2 - 69.9 \text{ mg L}^{-1} \text{ NO}_3\text{-N}$, $0.51 - 1.03 \text{ mg L}^{-1} \text{ NO}_2\text{-N}$, $7.1 - 9.7 \text{ mg L}^{-1} \text{ CO}_2$, $5.6 - 14.5 \text{ mg L}^{-1} \text{ TSS}$, $14.6 - 29.6 \text{ mg L}^{-1} \text{ TOC}$ and $33.6 - 51.6 \text{ mg L}^{-1} \text{ TC}$ should not be exceeded for adult pikeperch in RAS by means of precaution.

Acknowledgement

This research was funded by the Federal Ministry of Education and Research (Project number 031A290A). We thank the guest auditorial team for the invitation to submit a paper to this special issue. Special thanks to Dr. Mario Hasler for his detailed statistical advice and the whole team at GMA Büsum for their assistance and support during the experiment.

References

- Barton, B.A., Iwama, G.K., 1991. Physiological changes in fish from stress in aquaculture with emphasis on the response and effects of corticosteroids. *Annu. Rev. Fish Dis.* 1, 3–26. doi:10.1016/0959-8030(91)90019-G
- Benoit, D.A., Holcombe, G.W., 1978. Toxic effects of zinc on fathead minnows *Pimephales promelas* in soft water. *J. Fish Biol.* 13, 701–708. doi:10.1111/j.1095-8649.1978.tb03484.x
- Canli, M., Atli, G., 2003. The relationship between heavy metal (Cd, Cr, Cu, Fe, Pb, Zn) levels and the size of six Mediterranean fish species. *Environ. Pollut.* 121, 129–136. doi:10.1016/S0269-7491(02)00194-X
- Carroll, R.J., Ruppert, D., 1988. *Transformation and Weighting in Regression*. Chapman & Hall.
- Chaudhary, D.S., Vigneswaran, S., Ngo, H.-H., Shim, W.G., Moon, H., 2003. Biofilter in water and wastewater treatment. *Korean J. Chem. Eng.* 20, 1054–1065. doi:10.1007/BF02706936
- Colt, J., 2006. Water quality requirements for reuse systems. *Aquac. Eng.* 34, 143–156. doi:10.1016/j.aquaeng.2005.08.011
- Colt, J., Lamoureux, J., Patterson, R., Rogers, G., 2006. Reporting standards for biofilter performance studies. *Aquac. Eng.* 34, 377–388. doi:10.1016/j.aquaeng.2005.09.002
- Dalsgaard, J., Lund, I., Thorarinsdottir, R., Drengstig, A., Arvonen, K., Pedersen, P.B., 2013. Farming different species in RAS in Nordic countries: Current status and future perspectives. *Aquac. Eng.* 53, 2–13. doi:10.1016/j.aquaeng.2012.11.008
- Dave, G., Xiu, R.Q., 1991. Toxicity of mercury, copper, nickel, and cobalt to embryos and larvae of zebrafish, *Brachydanio rerio*. *Arch. Environ. Contam. Toxicol.* 21, 126–134.
- Davidson, J., Good, C., Welsh, C., Brazil, B., Summerfelt, S., 2009. Heavy metal and waste metabolite accumulation and their potential effect on rainbow trout

- performance in a replicated water reuse system operated at low or high system flushing rates. *Aquac. Eng.* 41, 136–145. doi:10.1016/j.aquaeng.2009.04.001
- Davidson, J., Good, C., Welsh, C., Summerfelt, S.T., 2014. Comparing the effects of high vs. Low nitrate on the health, performance, and welfare of juvenile rainbow trout *Oncorhynchus mykiss* within water recirculating aquaculture systems. *Aquac. Eng.* 59, 30–40. doi:10.1016/j.aquaeng.2014.01.003
- Davidson, J., Good, C., Welsh, C., Summerfelt, S.T., 2011. Abnormal swimming behavior and increased deformities in rainbow trout *Oncorhynchus mykiss* cultured in low exchange water recirculating aquaculture systems. *Aquac. Eng.* 45, 109–117. doi:10.1016/j.aquaeng.2011.08.005
- Davidson, J., Summerfelt, R., Barrows, F., Gottsacker, B., Good, C., Fischer, G., Summerfelt, S., 2016. Walleye *Sander vitreus* performance, water quality, and waste production in replicated recirculation aquaculture systems when feeding a low phosphorus diet without fishmeal versus a traditional fishmeal-based diet. *Aquac. Eng.* 75, 1–13. doi:10.1016/j.aquaeng.2016.09.005
- De Smet, H., Blust, R., 2001. Stress responses and changes in protein metabolism in carp *Cyprinus carpio* during cadmium exposure. *Ecotoxicol. Environ. Saf.* 48, 255–262. doi:10.1006/eesa.2000.2011
- Deviller, G., Palluel, O., Aliaume, C., Asanthi, H., Sanchez, W., Franco Nava, M.A., Blancheton, J.P., Casellas, C., 2005. Impact assessment of various rearing systems on fish health using multibiomarker response and metal accumulation. *Ecotoxicol. Environ. Saf.* 61, 89–97. doi:10.1016/j.ecoenv.2004.07.011
- Ebeling, J.M., Timmons, M.B., Bisogni, J.J., 2006. Engineering analysis of the stoichiometry of photoautotrophic, autotrophic, and heterotrophic removal of ammonia-nitrogen in aquaculture systems. *Aquaculture* 257, 346–358. doi:10.1016/j.aquaculture.2006.03.019
- European Commission, 2009. Commission regulation (EC) No 152/2009 of 27 January 2009 laying down the methods of sampling and analysis for the official control of feed. *Off. J. Eur. Union* 36, 1–130.
- Hamlin, H.J., Moore, B.C., Edwards, T.M., Larkin, I.L.V., Boggs, A., High, W.J., Main, K.L., Guillette, L.J., 2008. Nitrate-induced elevations in circulating sex steroid concentrations in female Siberian sturgeon (*Acipenser baeri*) in commercial aquaculture. *Aquaculture* 281, 118–125. doi:10.1016/j.aquaculture.2008.05.030
- Hasler, M., Hothorn, L.A., 2008. Multiple Contrast Tests in the Presence of Heteroscedasticity. *Biometrical J.* 50, 793–800. doi:10.1002/bimj.200710466
- Hermelink, B., Wuertz, S., Trubiroha, A., Rennert, B., Kloas, W., Schulz, C., 2011. Influence of temperature on puberty and maturation of pikeperch, *Sander lucioperca*. *Gen. Comp. Endocrinol.* 172, 282–92. doi:10.1016/j.ygcen.2011.03.013

- Lall, S.P., 2002. The Minerals, in: Halver, J.E., Hardy, R.W. (Eds.), Fish Nutrition. Academic Press, pp. 259–308.
- Leonard, N., Guiraud, J.P., Gasset, E., Cailleres, J.P., Blancheton, J.P., 2002. Bacteria and nutrients - Nitrogen and carbon - In a recirculating system for sea bass production. *Aquac. Eng.* 26, 111–127. doi:10.1016/S0144-8609(02)00008-0
- Luchiari, A.C., De Morais Freire, F.A., Pirhonen, J., Koskela, J., 2009. Longer wavelengths of light improve the growth, intake and feed efficiency of individually reared juvenile pikeperch *Sander lucioperca* (L.). *Aquac. Res.* 40, 880–886. doi:10.1111/j.1365-2109.2008.02160.x
- Martins, C.I.M., Ochola, D., Ende, S.S.W., Eding, E.H., Verreth, J.A.J., 2009a. Is growth retardation present in Nile tilapia *Oreochromis niloticus* cultured in low water exchange recirculating aquaculture systems? *Aquaculture* 298, 43–50. doi:10.1016/j.aquaculture.2009.09.030
- Martins, C.I.M., Pistrin, M.G., Ende, S.S.W., Eding, E.H., Verreth, J.A.J., 2009b. The accumulation of substances in Recirculating Aquaculture Systems (RAS) affects embryonic and larval development in common carp *Cyprinus carpio*. *Aquaculture* 291, 65–73. doi:10.1016/j.aquaculture.2009.03.001
- Michaud, L., Blancheton, J.P., Bruni, V., Piedrahita, R., 2006. Effect of particulate organic carbon on heterotrophic bacterial populations and nitrification efficiency in biological filters. *Aquac. Eng.* 34, 224–233. doi:10.1016/j.aquaeng.2005.07.005
- Mook, W.T., Chakrabarti, M.H., Aroua, M.K., Khan, G.M.A., Ali, B.S., Islam, M.S., Abu Hassan, M.A., 2012. Removal of total ammonia nitrogen (TAN), nitrate and total organic carbon (TOC) from aquaculture wastewater using electrochemical technology: A review. *Desalination* 285, 1–13. doi:10.1016/j.desal.2011.09.029
- Mozumder, M.S.I., Picioleanu, C., Van Loosdrecht, M.C.M., Volcke, E.I.P., 2014. Effect of heterotrophic growth on autotrophic nitrogen removal in a granular sludge reactor. *Environ. Technol.* 35, 1027–1037. doi:10.1080/09593330.2013.859711
- Nakagawa, S., Schielzeth, H., 2013. A General and Simple Method for Obtaining R² from Generalized linear Mixed-Effects Models, in: O’Hara, R.B. (Ed.), *Methods in Ecology and Evolution*. pp. 133–142.
- Oosterbaan, R.J., 1994. Frequency and Regression Analysis of Hydrologic Data, in: Ritzema, H.P. (Ed.), *Drainage Principles and Applications*. International Institute for Land Reclamation and Improvement (ILRI), Wageningen.
- Pedersen, L.-F., Suhr, K.I., Dalsgaard, J., Pedersen, P.B., Arvin, E., 2012. Effects of feed loading on nitrogen balances and fish performance in replicated recirculating aquaculture systems. *Aquaculture* 338–341, 237–245. doi:10.1016/j.aquaculture.2012.01.035

- Ricker, W.E., 1975. Computation and Interpretation of Biological Statistics of Fish Populations, Bulletin of the Fisheries Research Board of Canada. Department of the Environment Fisheries and Marine Service, Ottawa. doi:10.1038/108070b0
- Schram, E., Roques, J.A.C., van Kuijk, T., Abbink, W., van de Heul, J., de Vries, P., Bierman, S., van de Vis, H., Flik, G., 2013. The impact of elevated water ammonia and nitrate concentrations on physiology, growth and feed intake of pikeperch (*Sander lucioperca*). *Aquaculture* 420–421, 95–104. doi:10.1016/j.aquaculture.2013.10.027
- Schulz, C., Böhm, M., Wirth, M., Rennert, B., 2007. Effect of dietary protein on growth, feed conversion, body composition and survival of pike perch fingerlings (*Sander lucioperca*). *Aquac. Nutr.* 13, 373–380.
- Sinley, J.R., Goettl, J.P., Davies, P.H., 1974. The effects of zinc on rainbow trout (*Salmo gairdneri*) in hard and soft water. *Bull. Environ. Contam. Toxicol.* 12, 193–201.
- Steffens, W., 1981. Protein utilization by rainbow trout (*Salmo gairdneri*) and carp (*Cyprinus carpio*): A brief review. *Aquaculture* 23, 337–345. doi:10.1016/0044-8486(81)90026-0
- Steinberg, K., Zimmermann, J., Stiller, K.T., Meyer, S., Schulz, C., 2017. The effect of carbon dioxide on growth and energy metabolism in pikeperch (*Sander lucioperca*). *Aquaculture* 481, 162–168. doi:10.1016/j.aquaculture.2017.09.003
- Steinberg, K., Zimmermann, J., Stiller, K.T., Nwana, L., Meyer, S., Schulz, C., 2018. Elevated Nitrate Levels affect the Energy Metabolism of Pikeperch (*Sander lucioperca*) in RAS, *Submitted to Aquaculture*.
- Stiller, K.T., Vanselow, K.H., Moran, D., Bojens, G., Voigt, W., Meyer, S., Schulz, C., 2015. The effect of carbon dioxide on growth and metabolism in juvenile turbot *Scophthalmus maximus* L. *Aquaculture* 444, 143–150. doi:10.1016/j.aquaculture.2015.04.001
- Tielmann, M., Schulz, C., Meyer, S., 2017. The effect of light intensity on performance of larval pike-perch (*Sander lucioperca*). *Aquac. Eng.* 77, 61–71. doi:10.1016/j.aquaeng.2017.03.001
- Tilak, K.S., Veeraiah, K., Milton Prema Raju, J., 2007. Effects of ammonia, nitrite and nitrate on hemoglobin content and oxygen consumption of freshwater fish, *Cyprinus carpio* (Linnaeus). *J. Environ. Biol.* 28, 45–47.
- Timmons, M., Ebeling, J., 2007. Recirculating Aquaculture, NRAC Publication No 01-007. Cayuga Aqua Ventures, Ithaca.
- van Bussel, C.G.J., Schroeder, J.P., Mahlmann, L., Schulz, C., 2014. Aquatic accumulation of dietary metals (Fe, Zn, Cu, Co, Mn) in recirculating aquaculture systems (RAS) changes body composition but not performance and health of

- juvenile turbot (*Psetta maxima*). *Aquac. Eng.* 61, 35–42. doi:10.1016/j.aquaeng.2014.05.003
- Watanabe, T., Kiron, V., Satoh, S., 1997. Trace minerals in fish nutrition. *Aquaculture* 151, 185–207. doi:10.1016/S0044-8486(96)01503-7
- Weaver, D., Keane, P., Francis, M., Williamson, J., True, C., 2016. Towards Zero Discharge: Denitrification and Refractory Organic Cleanup, in: 11th International Conference on Recirculating Aquaculture. Roanoke, pp. 45–46.
- Wendelaar Bonga, S.E., 1997. The stress response in fish. *Physiol. Rev.* 77, 591–625.
- Wood, C.M., 2001. Toxic response of the gill, in: Schlenk, D., Benson, W.H. (Eds.), *Target Organ Toxicity*. Taylor & Francis, London, pp. 1–89.
- Wuertz, S., Schulze, S.G.E., Eberhardt, U., Schulz, C., Schroeder, J.P., 2013. Acute and chronic nitrite toxicity in juvenile pike-perch (*Sander lucioperca*) and its compensation by chloride. *Comp. Biochem. Physiol. C. Toxicol. Pharmacol.* 157, 352–60. doi:10.1016/j.cbpc.2013.01.002
- Zhang, S.Y., Li, G., Wu, H.B., Liu, X.G., Yao, Y.H., Tao, L., Liu, H., 2011. An integrated recirculating aquaculture system (RAS) for land-based fish farming: The effects on water quality and fish production. *Aquac. Eng.* 45, 93–102. doi:10.1016/j.aquaeng.2011.08.001
- Zhu, S., Chen, S., 2001. Effects of organic carbon on nitrification rate in fixed film biofilters. *Aquacult. Eng.* 25, 221–237. doi:10.1016/S0144-8609(01)00071-1
- Zingel, P., Paaver, T., 2010. Effects of turbidity on feeding of the young-of-the-year pikeperch (*Sander lucioperca*) in fishponds. *Aquac. Res.* 41, 189–197. doi:10.1111/j.1365-2109.2009.02317.x

GENERAL DISCUSSION

The aim of this thesis was to identify the optimal combination of different water quality parameters for culturing adult pikeperch (*Sander lucioperca*) in recirculating aquaculture systems (RAS). Detailed knowledge on optimal rearing conditions is crucial, in order to increase production efficiency to maintain an adequate profit margin. Adult pikeperch were reared in both small scale RAS as well as a respirometer system in order to obtain detailed information on the energy metabolism. The first two experiments (*Chapter 1* and *Chapter 2*) focused on a single factor approach and additionally provided precise baseline data on the energy metabolism of adult pikeperch. The last experiment (*Chapter 3*) concentrated on the effects of several water quality parameters on growth of pikeperch by the use of cumulative feed burden (CFB), representing a multifactorial approach under commercial scale conditions. In the following, general constraints of recirculating systems and the performance of pikeperch in RAS will be discussed and the different approaches to identify optimal rearing parameters will be compared.

Water Quality Constraints

Recirculating Aquaculture Systems are defined by their low water exchange rates and high control of environmental parameters (Bregnballe, 2015). Providing the optimal environment for the target species is the main limiting factor to the success of a commercial RAS (Timmons and Ebeling, 2007). Environmental sensitivity is species specific and subject to change throughout life stages (Brett, 1979). Results obtained for one species are therefore not necessarily transferable thus underlining the importance for detailed knowledge on species specific water quality parameters. The possibility to control the environment in RAS provides great opportunity given that detailed information on critical parameters exists. Critical parameters include temperature, oxygen concentration, pH and concentration of ammonia and nitrite, and are usually automatically controlled and adjusted by the system (Timmons and Ebeling, 2007). It is accepted that temperature has a direct impact on ingestion and metabolism and research on the optimal rearing temperature for most aquaculture species is vast (Brown et al., 1984; Frisk et al., 2012; Jobling, 1994). The same applies to oxygen concentrations, pH and concentrations of ammonia and nitrite and several

publications provide an overview of the general optimal concentrations for these parameters in RAS (e.g. Dalsgaard et al., 2013; Timmons and Ebeling, 2007). Water quality parameters that are not easily treated or adjusted by the system are paramount when designing RAS, especially in terms of recirculation rates. Increased water retention time in the system causes an accumulation of the end products of fish metabolism and bacterial activity and has a direct effect on the concentration of nitrate, nitrite, ammonia, total and organic carbon, suspended solids and carbon dioxide as well as phosphorus, arsenic, copper, potassium and zinc (*Chapter 3*). It can also have an effect on other trace elements and heavy metals as well as hormone concentrations (Davidson et al., 2009; Martins et al., 2009; Timmons and Ebeling, 2007; Weaver et al., 2016). The water can be treated for most of these parameters by means of denitrification, degassing or filtration, but construction and operation of additional treatment units has severe cost implications thus understanding the interactions of these parameters with fish performance in RAS is crucial in order to reduce costs and increase productivity.

Effect of Environmental Parameters on Fish

The aquatic environment is a complex system consisting of multiple variables potentially affecting the fish (Timmons and Ebeling, 2007). The growth of fish is always based on a combination of feed quality and ration (biotic factor) and environmental parameters and interactions (abiotic factor) (Brett, 1979). The optimal combination of environmental parameters is both species and age specific (Black, 1998). Fry (1971) defined five types of factors influencing fish in aquatic environments:

- lethal factors, which destroy an organism
- controlling factors, which govern metabolic rate by influencing the state of molecular activation (e.g. temperature)
- limiting factors, which restrict supply or removal of metabolites (e.g. oxygen, carbon dioxide)
- masking factors, which modify or prevent the effect of another factor through regulation (e.g. temperature regulation)
- directive factors, which trigger a physiological response (e.g. photoperiod induced smoltification)

The classification by distinctive action can be an advantage when discussing effects of environmental parameters on fish but it is also obvious that any environmental factor may fall into more than one of the functional categories. Controlling and limiting factors are of main interest when determining the optimal water quality parameters in RAS as they directly influence the metabolic rate.

Limiting factors analysed as single parameters in this work are carbon dioxide (CO₂) (*Chapter 1*) and nitrate-nitrogen (NO₃-N) (*Chapter 2*), both of which can potentially be lethal factors when exceeding certain thresholds (Grottum and Trygve, 1996; Hamlin, 2006). Increased levels of CO₂ in the water can impair the CO₂ excretion of the fish thus causing respiratory acidosis (Timmons and Ebeling, 2007). Respiratory acidosis causes a decrease in blood pH which is compensated by retaining bicarbonate in the kidneys (Colt, 2006). Most cellular processes are pH dependent and consequently affected by respiratory acidosis (Ishimatsu et al., 2005). Shifts in respiration and cellular processes are likely to cause changes in metabolism ultimately resulting in reduced growth rates. This study could not verify a direct effect of elevated CO₂ levels on metabolism. Instead an effect on the feed intake of pikeperch was observed (*Chapter 1*).

The uptake of nitrate is presumably passive and therefore limited, resulting in the generally low toxicity of nitrate (Camargo et al., 2005; Davidson et al., 2014). Results of chronic exposure of Nile tilapia (*Oreochromis niloticus*) to nitrate suggest that the primary reason for nitrate toxicity is the reduction to nitrite and the resulting irreversible oxidation of haemoglobin (Hb) to methaemoglobin (Monsees et al., 2016). Oxygen is no longer able to bind to the Hb with the result of reducing the oxygen carrying capacity of the blood (Camargo et al., 2005; Jensen, 1995). Increased nitrate levels consequently influence the aerobic energy metabolism of fish by reducing availability of oxygen. Additionally nitrate is known to inhibit the thyroid uptake of iodide in humans and thus impairing formation of thyroid hormones which in turn leads to decreased growth (Ward et al., 2010). Although the exact reason could not be verified, this study identified a clear effect of nitrate on metabolism of pikeperch (*Chapter 2*). A detailed understanding of the effects of environmental parameters on fish is crucial in order to further develop suitable recommendations for pikeperch in aquaculture.

Pikeperch in RAS

Research interest in aquaculture of pikeperch has increased recently and will have a positive effect on the fluctuating development of pikeperch culture in RAS. So far research has mainly focused on the improvement of larval rearing (Schaefer et al., 2017; Szkudlarek and Zakęś, 2007; Tielmann et al., 2017) or juvenile pikeperch (Dumitrescu et al., 2014; Luchiari et al., 2009; Schulz et al., 2007, 2006). But production of pikeperch in RAS incorporates the whole production cycle from larvae to juvenile to adult pikeperch. The main factors of interest for commercial aquaculture production are high and steady growth rates throughout the complete production. Hence, it is crucial to understand the growth limiting factors at all life stages. Physiological processes are limited by energy supply. Consequently an understanding of energy metabolism is necessary when studying fish physiology (Tseng and Hwang, 2008). All acquired energy (feed) is either lost as waste, used in metabolic processes or deposited as new body tissue (Jobling, 1994). For optimal growth it is essential to reduce energy losses and keep metabolic processes to a minimum. Energy budgets can help to identify the most desirable relation between retained energy or growth, and feed intake. Furthermore, constructing basic energy budgets help to determine and assess effects of environmental factors in short term experiments.

The average retained energy (energy that is available for growth) of adult pikeperch was identified to be $107.0 \pm 15.9 \text{ kJ kg}^{-0.8} \text{ day}^{-1}$ and equalled $67.6 \pm 2.9\%$ of feed energy (control group in *Chapter 1*). This value is significantly higher compared to trials on other species such as rainbow trout (*Oncorhynchus mykiss*) (59%), European seabass (*Dicentrarchus labrax*) (45%) or turbot (*Psetta maxima*) (62%) showing that pikeperch in this experiment maintained a favourable energy metabolism (Dietz et al., 2013; Santos et al., 2013; Saravanan et al., 2013). Applying different feeding levels (0.3% BW, 0.6% BW and 0.9% BW) in *Chapter 2* showed similar results for the percentage of retained energy for the two highest feeding levels and clearly indicates that low feeding levels, close to maintenance, negatively affect the proportion of retained energy and thus growth. Comparability of the results has to be evaluated carefully due to the slightly different sizes of the fish (*Chapter 1* and *3* compared to *Chapter 2*) as well as different origin (*Chapter 1* and *2* compared to *Chapter 3*). Due to the similar health parameters (HSI, SI and CF) at the start of the experiments (*Chapter 1* and *3*)

and the aforementioned similar results for retained energy (*Chapter 1 and 2*) given comparability was assumed.

The respirometry data was furthermore used to calculate the energy requirement above maintenance for digestible energy (DE_m) and the efficiency of energy utilisation (k_g) (*Chapter 2*). The DE_m of $16.40 \pm 2.39 \text{ kJ kg}^{-0.8} \text{ day}^{-1}$ was low compared to results for other species such as silver perch (*Bidyanus bidyanus*) with $36.79 \text{ kJ kg}^{-0.6} \text{ day}^{-1}$, gilthead seabream (*Sparus aurata*) with $47.89 \pm 2.94 \text{ kJ kg}^{-0.8} \text{ day}^{-1}$ or European sea bass (*Dicentrarchus labrax*) with $45.38 \pm 1.40 \text{ kJ kg}^{-0.8} \text{ day}^{-1}$ (Booth and Allan, 2003; Lupatsch et al., 2003). Additionally k_g was high (0.86 ± 0.03) compared to the same studies where the efficiency was below 0.70. While these results suggest that pikeperch are a good candidate for intensive aquaculture systems, it has to be kept in mind that the results in this study are based on the instantaneous approach whereas other studies were conducted by the use of the comparative slaughter method. Research comparing the two approaches showed significant differences in terms of protein utilisation rates (Lauff and Wood, 1996). This is mainly caused by the different bases of the calculations. The slaughter method is based on the net loss (or gain) of the fish while the respirometry indicates substrates that are actually oxidized and does not account for proteins that are converted to glucose prior oxidisation for energy metabolism (Lauff and Wood, 1996). Similarly high efficiencies of 0.86 were found for turbot using the instantaneous method (Dietz et al., 2013), while the efficiency was substantially lower (0.59 - 0.64) when determined via the comparative slaughter method (Dietz et al. 2012).

While the different approaches might explain the apparently high energy utilisation efficiency, it does not explain the low values for DE_m as a study evaluating DE_m via comparative slaughter method conducted on pikeperch from the same origin as in the respirometry trials identified even lower values for DE_m of $12.39 \text{ kJ kg}^{-0.8}$ (Hund, 2016). The similar results in terms of DE_m suggest that there is a different explanation for the low energy requirement above maintenance for pikeperch other than the different approaches. Pikeperch in both studies spend most time laying on the ground of the tanks and therefore spend only little energy on swimming. Studies on Atlantic salmon (*Salmo salar*) found a significant increase in maintenance requirement of nearly 50% with increased velocity and thus swimming (Grisdale-Helland et al., 2013).

Furthermore the metabolic rate of fish is related to both body weight and temperature (Jobling, 1994). Both this study and the study by Hund (2016) were executed with pikeperch > 250 g whereas the study on silver perch by Booth and Allan (2003) is based on juvenile fish from 3 g onwards. It is thus possible that the low maintenance requirements are due to the size of the fish. Additional studies on the effect of fish size on DE_m for pikeperch are needed in order to verify this hypothesis. Identification of the exact reason for the low DE_m and the high k_g was beyond the scope of this thesis but the results still show that pikeperch are a suitable species for production in RAS as low energy requirements are generally desirable.

The use of a respirometer (*Chapter 1 and 2*) provided the opportunity to receive detailed information on the instantaneous fuel use of pikeperch during fed and fasting conditions. Unfortunately the used respirometer does not consist of a measurement unit for inorganic carbon thus rendering it impossible to differentiate between catabolic carbohydrate and lipid use. Nevertheless, the precise measurement of nitrogen excretion and oxygen consumption could be used to estimate the degree of protein utilisation for energy metabolism according to Gnaiger (1983). Fortunately detailed information on the protein utilisation efficiency is generally the main factor of interest, as high quality protein sources account for the most cost-intensive ingredient of diets and building up body protein instead of using it for energy metabolism (protein sparing) is usually the aim of an economically viable aquaculture (De Silva et al., 1991). The results showed that fed pikeperch fuel an average of around 50% of their energy metabolism through protein breakdown. This is similar to findings on juvenile pikeperch who were found to require proportionally high amounts of dietary protein for sufficient growth (Nyina-Wamwiza et al., 2005).

Contradictory to the effect of CO_2 on turbot (Stiller et al., 2015), pikeperch did not show an increase in protein catabolism with elevated CO_2 levels. However, elevated nitrate levels showed a clear effect on protein metabolism in fasting pikeperch exposed to the highest nitrate-nitrogen concentration of approximately 240 mg L^{-1} . Pikeperch in this group had to use body protein to fuel an average of $46 \pm 7\%$ of their energy metabolism compared to $12 \pm 2\%$ in the NO treatment. Increased levels of protein catabolism are a known reaction to different stressors (Barton and Iwama, 1991; De Smet and Blust, 2001; Wendelaar Bonga, 1997). The results conducted with

the respirometer system can therefore be used as an indication that high nitrate levels cause stress in pikeperch without the need to sacrifice the fish for analysis. Nevertheless, an evaluation of blood stress parameters (e.g. cortisol, plasma chloride, glucose, lactate, or hormone levels (Wendelaar Bonga, 1997)) should be conducted in order to verify this hypothesis.

Analysis of health parameters in *Chapter 1* and *3* showed a clear increase in the hepatosomatic index (HSI) during both experiments compared to the respective start. The identified values of 0.95 ± 0.24 (*Chapter 1*) and 1.20 ± 0.27 (*Chapter 3*) are within the results that other studies found for pellet fed pikeperch, indicating that the fish were neither fatty nor malnourished (Akther, 2015). The lower HSI values at the start of each experiment (0.81 ± 0.36 and 0.86 ± 0.02 respectively) might have been caused by the reduced administration of feed during the acclimatisation period. Due to the experimental design analysis of health parameters during the nitrate exposure experiment (*Chapter 2*) was not possible.

The analysis of the effects of carbon dioxide (*Chapter 1*) and nitrate (*Chapter 2*) on pikeperch metabolism in single factor experiments showed fundamentally different effects, although both factors are classified similar as limiting factors and known to influence oxygen consumption. The aforementioned hypothesis that increased levels of CO₂ affect the energy metabolism could not be validated for pikeperch as the same percentage of energy was retained within the fish for all tested CO₂ levels. The linear correlation between final bodyweight and CO₂ concentration was rather based on a decrease in appetite with increasing levels of CO₂. Fish produce CO₂ through energy metabolism (Jobling, 1994). Reducing feed intake and thus production of CO₂ would, in a normal RAS, slowly cause a reduction of ambient CO₂ concentration and likely result in a return to higher levels of feed intake. The threshold for CO₂ was identified to be 15 mg L^{-1} but in reality the linear correlation suggests that there is no CO₂ concentration for pikeperch where no effects subsist. Thus the lower the CO₂ concentration the better for the fish. Restrictively it has to be considered that the linear correlation has only been confirmed between the lowest ($4.4 \pm 0.5 \text{ mg L}^{-1}$) and highest ($29.7 \pm 0.8 \text{ mg L}^{-1}$) administered concentrations. Low concentrations of CO₂ can cause an increase in blood pH through respiratory alkalosis as CO₂ transfer is increased (Perry and Gilmour, 2006). This condition is likewise not desirable due to the increased

energy expenditure caused by the high ventilation frequencies (Perry et al., 2009). Concentration of ambient CO₂ in RAS for pikeperch should thus not exceed 15 mg L⁻¹ while the desired CO₂ concentration is 4.4 ± 0.5 mg L⁻¹. Detailed evaluations on the effect of low concentrations of CO₂ on pikeperch are necessary in order to evaluate the cut-off point for respiratory alkalosis.

Similar conclusions were expected for the second trial on the effects of elevated nitrate levels on pikeperch, but in practice the results were completely different. Retained energy was significantly higher in the N30 (31.5 ± 4.2 mg L⁻¹ NO₃-N) treatment when fed 0.3% BW or 0.6% BW compared to the lowest possible nitrate concentration. The lack of a linear correlation between concentration of ambient nitrate and pikeperch metabolism implies that, contradictory to CO₂, an optimal concentration of NO₃-N exists and this concentration should neither be exceeded nor should NO₃-N levels fall below. Unfortunately the levels of NO₃-N chosen in the experiment make it impossible to identify the exact optimal concentration. This is presumably around 30 mg L⁻¹ NO₃-N or at least above N0 (4.8 ± 0.9 mg L⁻¹ NO₃-N) and below N120 (134.0 ± 16.6 mg L⁻¹ NO₃-N). Similar non-monotonic dose responses to elevated nitrate levels have been observed in Atlantic salmon (Freitag et al., 2015). Nitrate has been identified to act as an endocrine disrupting chemical affecting the reproductive and thyroid hormone system (Freitag et al., 2015; Hamlin et al., 2008). Moderate concentrations of nitrate may result in an up-regulation of growth hormones whereas at higher concentrations the toxicological response (methaemoglobinemia) predominates. Detailed blood analysis would have been necessary in order to identify possible changes in hormone concentration and haemoglobin levels. Furthermore, elevated nitrate levels have been identified to reduce the toxicity of nitrite due to the similar uptake routes (Kroupova et al., 2005). This indirect effect is unlikely to cause the non-monotonic dose response in this study as the highest measured concentration of NO₂-N was 0.15 ± 0.02 and thus well below the generally held safe criterion for pikeperch of up to 1.50 mg L⁻¹ NO₂-N (Dalsgaard et al., 2013). By means of precaution the resulting recommended level for nitrate is 31.5 ± 4.2 mg L⁻¹ NO₃-N. This shows that interactions between fish and a single water quality parameter alone can be extremely complex. Interactions between fish and

more than one parameter are likely more complicated and need to be evaluated in detail.

Multifactorial Approach vs. Single Factor Approach

There are several approaches to evaluate the complex interactions of fish with their environment. Conventional approaches focus on a single water quality parameter and evaluate the effects of distinct concentrations on the fish. These experimental concepts allow for a controlled evaluation of a particular impact factor. Concentrations and replicates are simple to generate, maintain and monitor and the potential effects can be solely linked to one causal agent. But performance is a result of interactions between different factors and while isolated effects are often well studied, these interactions are more relevant for 'real world' aquaculture systems (Thorarensen et al., 2018; Trabelsi et al., 2011).

Interactions of parameters can be studied by simply combining two factors of interest (e.g. Thorarensen et al., 2018), using fractional factorial design to combine potentially interacting factors (e.g. Baekelandt et al., 2018; Trabelsi et al., 2011) or by mimicking commercial recirculating systems using feed load or the cumulative feed burden (CFB) (e.g. Martins et al., 2009; Pedersen et al., 2012). The latter method was used in this study in order to evaluate the effects of multiple water quality parameters on pikeperch (*Chapter 3*). Research on the impact of rearing systems on fish health found significantly better growth in flow-through systems compared to RAS, identifying the increased CFB as a potential reason (Deviller et al., 2005). The CFB is a term used to quantify mass input (feed) into the system over time in relation to water exchange and typically expressed as weight per volume (mg L^{-1}) (Colt et al., 2006). It is used as a measure of production intensity and as a proxy for the interpretation of water quality parameters that are not treated for as such, e.g. fine solids and organic compounds, heavy metals and trace minerals, hormones or nitrate as the end product of the nitrogen cycle (Weaver et al., 2016). The CFB can generally be used to compare the intensity of different RAS but it does depend on the systems construction components. RAS with a degassing unit or a denitrification unit can possibly achieve higher CFB values without harming the fish compared to RAS without these components. The same is true about the quality and size of the filtration unit. Unfortunately the small

scale RAS used in the CFB trial (*Chapter 3*) did not consist of a mechanical filtration unit. This is one of the main limitations of the generated results in terms of comparability with commercial systems. Despite these limitations the approach has proven to be practical when imitating commercial or 'real world' systems (Pedersen et al., 2012).

This thesis focused on the effect of three different levels of CFB (*Chapter 3*) as well as two single factor experiments (*Chapter 1* and *2*). The CFB approach has several advantages as well as disadvantages over the single factor approach. The imitation of commercial systems through CFB is time consuming and results of the present study showed that the steady state phase should preferably be even longer in order to achieve significant results. Additionally the experimental set-up precluded the possibility to compile detailed energy budgets and the effects on growth cannot be linked to one parameter but only to CFB as a whole (Martins et al., 2009). On the other hand detailed acquisition of water quality parameters followed by identification of the functional relationship between CFB and each measured water quality parameter allowed for an estimation of threshold ranges for distinct parameters. Furthermore multifactorial approaches are more realistic and therefore relevant for the aquaculture sector (Baekelandt et al., 2018). Additionally, the accumulation of substances in the CFB approach was achieved biologically and thus comparable to 'real world' conditions whereas the single factor experiments were based on chemical dosage of the required substance.

Interestingly the results of the nitrate experiment (*Chapter 2*) and the CFB experiment (*Chapter 3*) show similar results. Both experiments indicate that a specific concentration of $\text{NO}_3\text{-N}$ or CFB is superior to zero. Detailed evaluation of the most preferable nitrate concentration for pikeperch in RAS indicated that this is around 30 mg L^{-1} or above 5 mg L^{-1} and below 120 mg L^{-1} .

Similar findings were achieved with the CFB approach where the most optimal CFB level was identified at $1953 \pm 613 \text{ mg L}^{-1}$. Based on the linear correlation between CFB and $\text{NO}_3\text{-N}$ this equals a concentration between 45.2 and $94.6 \text{ mg L}^{-1} \text{ NO}_3\text{-N}$. Whereas the result of the single factor experiment was a precautionary threshold of $31.5 \pm 4.2 \text{ mg L}^{-1} \text{ NO}_3\text{-N}$ or a comparatively wide range of $5 - 120 \text{ mg L}^{-1}$ the CFB approach provides more detailed results with a significantly reduced bandwidth of the

recommendable NO₃-N concentration. Additionally the concentration is deduced from the integrated parameter CFB and therefore taking potential and factual interactions with other water quality parameters into consideration.

Resulting values of the best concentration of CO₂ based on the CFB approach should be considered carefully due to the preceding single factor experiment. The optimal range of CO₂ was calculated as 7.1 – 9.7 mg L⁻¹, thus lower than the threshold value of 15 mg L⁻¹ identified in *Chapter 1*. These differences show that pikeperch had a lot more difficulties to compensate the effect of elevated CO₂ concentrations when other water quality parameters were deteriorating at the same time. Contradictory to the results from the nitrate exposure experiment, the CO₂ exposure experiment showed that there is no optimal range for CO₂ but a threshold value. The identified concentrations for CO₂ of 7.1 – 9.7 mg L⁻¹ in the CFB trial should thus not be considered an optimal range but a threshold value which is significantly lower than the previously estimated threshold value of 15 mg L⁻¹. However, the linear correlation identified in the single factor experiment clarified that CO₂ concentrations should preferably be as low as possible (within the tested range of 4.4 ± 0.5 mg L⁻¹ - 29.7 ± 0.8 mg L⁻¹ CO₂).

These discrepancies accentuate the importance of single factor experiments in order to assess the results conducted in multifactorial experiments. The threshold range given for parameters not evaluated in single factor experiments should hence only be used as an approximation. The clear relation between the corresponding environmental parameter and pikeperch performance should be evaluated in a single factor experiment. The calculated water quality thresholds for nitrite, ammonia, suspended solids and carbon concentration (*Chapter 3*) can therefore only be considered as a general reference point.

Research on the effects of increased levels of TSS as a single factor found no effects on rainbow trout, suggesting that the suspended solids are not affecting fish welfare in RAS (Becke et al., 2018). This might be transferable to pikeperch but arguably suspended solids can have varying effects due to the different origin and sizes of solids. Pikeperch generally prefer low light intensity (Luchiari et al., 2009) and increased solids load consequently reduces light intensity under water. It could therefore be possible that, similar to nitrate, an optimal TSS concentration for pikeperch exists which should not be exceeded nor should levels of TSS fall below. The

CFB approach identified this level between 5.6 to 14.5 mg L⁻¹, which is in line with the recommendations of Timmons and Ebeling (2007) who recommend to not exceed 25 mg L⁻¹ and suggest 10 mg L⁻¹ for safe operation of freshwater systems. Whereas this can also explain the existence of an optimal range for TOC and TC that is higher than zero, it is unlikely that similar effects exist for nitrite or ammonia. Research on the effect of ammonia on juvenile pikeperch showed that pikeperch can maintain low plasma NH₄⁺ concentrations until a certain threshold (Schram et al., 2013). This suggests neither a linear correlation nor an optimal range but a cut-off value until which the concentration of ammonia does not affect pikeperch. Similar correlations would be expected for nitrite with the difference that toxicity of nitrite is reduced significantly by small increases in salinity and can be affected by nitrate concentrations (Kroupova et al., 2005; Wuertz et al., 2013). The identified optimal range of 0.51 - 1.03 mg L⁻¹ NO₂-N is thus only applicable for a salinity of 3‰.

Although this means that further research on the effects of different environmental parameters on pikeperch is necessary, the gained information through this work is significant and relevant for the development of grow-out RAS for pikeperch.

Conclusion and Further Perspective

The aim of this study was to compile detailed energy budgets for adult pikeperch and subsequently identify the most favourable combination of environmental parameters for grow-out of pikeperch in RAS. This study provided new insights into the energy metabolism of pikeperch and potential interactions with environmental factors. The detailed analysis of the effect of two limiting factors (carbon dioxide and nitrate) on the metabolism of adult pikeperch demonstrated that, although categorised similar, the effects of environmental factors are different. Elevated levels of CO₂ caused a reduction in appetite but did not show a clear effect on the energy metabolism of pikeperch, whereas nitrate concentrations showed a distinct interaction with the energy metabolism.

Considering threshold levels, this study could demonstrate a linear correlation between CO₂ concentration and final body weight (caused by the decreased feed intake) within the investigated range from 4.4 ± 0.5 mg L⁻¹ to 29.7 ± 0.8 mg L⁻¹. It was

thus demonstrated that pikeperch can survive chronic CO₂ exposure to up to 30 mg L⁻¹ without serious negative effects on the metabolism or health.

Removal of excess CO₂ can be achieved via surface aerators with variable frequency control (Badiola et al., 2018). Since measurement of CO₂ is expensive and time consuming, the resulting recommendation for commercial pikeperch producers would be to closely monitor feed intake and adjust the degassing unit accordingly. An economic analysis of opposing feed costs and electricity costs for the aerators should be conducted to identify the economically most viable CO₂ concentration for a given system.

Similar analysis should be considered in terms of the necessity for denitrification. Denitrification units are expensive and, depending on the carbon source, operation can have negative effects on feed intake (Müller-Belecke et al., 2013). This study showed that pikeperch can survive concentrations of up to 240 mg L⁻¹ NO₃-N and show the most favourable energy metabolism between 45.2 and 94.6 mg L⁻¹ NO₃-N. Reducing the nitrate concentration in a commercial system below 45.2 mg L⁻¹ NO₃-N would therefore be discouraged. The need for a denitrification unit should be considered carefully as a slight decrease in CFB (increase in water exchange) can be more profitable. Altogether the use of single factor experiments combined with a multifactorial approach provided useful recommendations for commercial production of pikeperch in RAS (Table GD-1).

Inferential it can be said that pikeperch is a promising candidate for ongrowing in RAS not only due to the favourable energy metabolism but also based on its potential to cope with a high degree of recirculation. Overall sensitivity to environmental parameters is lower than expected. The complexity of interactions between different environmental parameters were beyond the scope of this thesis but the determination of an optimal level of intensification in RAS through the CFB level of 1953 ± 613 mg L⁻¹ provides a useful measure for commercial production of pikeperch in RAS. Although the exact reason for a potential growth retardation could not be identified the recommendations for CO₂ and nitrate are forward-looking for future research as well as commercial farms.

GENERAL DISCUSSION

Table GD-1 Comparison of identified threshold values for carbon dioxide (CO₂) and nitrate-nitrogen (NO₃-N) in single factor experiments (*Chapter 1* and *2*) and the CFB experiment (*Chapter 3*).

parameter	single factor approach	CFB approach	recommendation
CO ₂	linear correlation (4.4 ± 0.5 – 29.7 ± 0.8 mg L ⁻¹) threshold: 15 mg L ⁻¹	7.1 – 9.7 mg L ⁻¹	as low as possible; not below 4.4 ± 0.5 mg L ⁻¹
NO ₃ -N	optimal range 4.8 ± 0.9 – 134.0 ± 16.6	45.2 – 94.6 mg L ⁻¹	45.2 – 94.6 mg L ⁻¹

References

- Akther, M., 2015. The Impact of Maturation Diet on Pikeperch Reproduction. Universiteit Gent, Ghent.
- Badiola, M., Basurko, O.C., Piedrahita, R., Hundley, P., Mendiola, D., 2018. Energy use in Recirculating Aquaculture Systems (RAS): A review. *Aquac. Eng.* 81, 57–70. doi:10.1016/j.aquaeng.2018.03.003
- Baekelandt, S., Redivo, B., Mandiki, S.N.M., Bournonville, T., Houndji, A., Bernard, B., El Kertaoui, N., Schmitz, M., Fontaine, P., Gardeur, J.N., Ledoré, Y., Kestemont, P., 2018. Multifactorial analyses revealed optimal aquaculture modalities improving husbandry fitness without clear effect on stress and immune status of pikeperch *Sander lucioperca*. *Gen. Comp. Endocrinol.* 258, 194–204. doi:10.1016/j.ygcen.2017.08.010
- Barton, B.A., Iwama, G.K., 1991. Physiological changes in fish from stress in aquaculture with emphasis on the response and effects of corticosteroids. *Annu. Rev. Fish Dis.* 1, 3–26. doi:10.1016/0959-8030(91)90019-G
- Becke, C., Schumann, M., Steinhagen, D., Geist, J., Brinker, A., 2018. Physiological consequences of chronic exposure of rainbow trout (*Oncorhynchus mykiss*) to suspended solid load in recirculating aquaculture systems. *Aquaculture* 484, 228–241. doi:10.1016/j.aquaculture.2017.11.030
- Black, K.D., 1998. The environmental interactions associated with fish culture, in: Black, K.D., Pickering, A.D. (Eds.), *Biology of Farmed Fish*. Sheffield Academic Press, pp. 284–326.
- Booth, M.A., Allan, G.L., 2003. Utilization of digestible nitrogen and energy from four agricultural ingredients by juvenile silver perch *Bidyanus bidyanus*. *Aquac. Nutr.* 9, 317–326. doi:10.1046/j.1365-2095.2003.00259.x
- Bregnballe, J., 2015. A Guide to Recirculation Aquaculture, FAO and EUROFISH. doi:92-5-105177-1

- Brett, J.R., 1979. Environmental Factors and Growth, in: Hoar, W.S., Randall, D.J., Brett, J.R. (Eds.), Fish Physiology Volume VIII, Bioenergetics and Growth. Academic Press, Inc, pp. 599–675.
- Brown, J., Jones, A., Matty, A., 1984. Oxygen Metabolism of Farmed Turbot (*Scophthalmus maximus*) I. The Influence of Fish Size and Water Temperature on Metabolic Rate. Aquaculture 36, 273–281.
- Camargo, J.A., Alonso, A., Salamanca, A., 2005. Nitrate toxicity to aquatic animals: A review with new data for freshwater invertebrates. Chemosphere 58, 1255–1267. doi:10.1016/j.chemosphere.2004.10.044
- Colt, J., 2006. Water quality requirements for reuse systems. Aquac. Eng. 34, 143–156. doi:10.1016/j.aquaeng.2005.08.011
- Colt, J., Lamoureux, J., Patterson, R., Rogers, G., 2006. Reporting standards for biofilter performance studies. Aquac. Eng. 34, 377–388. doi:10.1016/j.aquaeng.2005.09.002
- Dalsgaard, J., Lund, I., Thorarinsdottir, R., Drengstig, A., Arvonen, K., Pedersen, P.B., 2013. Farming different species in RAS in Nordic countries: Current status and future perspectives. Aquac. Eng. 53, 2–13. doi:10.1016/j.aquaeng.2012.11.008
- Davidson, J., Good, C., Welsh, C., Brazil, B., Summerfelt, S., 2009. Heavy metal and waste metabolite accumulation and their potential effect on rainbow trout performance in a replicated water reuse system operated at low or high system flushing rates. Aquac. Eng. 41, 136–145. doi:10.1016/j.aquaeng.2009.04.001
- Davidson, J., Good, C., Welsh, C., Summerfelt, S.T., 2014. Comparing the effects of high vs. Low nitrate on the health, performance, and welfare of juvenile rainbow trout *Oncorhynchus mykiss* within water recirculating aquaculture systems. Aquac. Eng. 59, 30–40. doi:10.1016/j.aquaeng.2014.01.003
- De Silva, S.S., Gunasekera, R.M., Shim, K.F., 1991. Interactions of varying dietary protein and lipid levels in young red tilapia: Evidence of protein sparing. Aquaculture 95, 305–318. doi:10.1016/0044-8486(91)90096-P
- De Smet, H., Blust, R., 2001. Stress responses and changes in protein metabolism in carp *Cyprinus carpio* during cadmium exposure. Ecotoxicol. Environ. Saf. 48, 255–262. doi:10.1006/eesa.2000.2011
- Deviller, G., Palluel, O., Aliaume, C., Asanthi, H., Sanchez, W., Franco Nava, M.A., Blancheton, J.P., Casellas, C., 2005. Impact assessment of various rearing systems on fish health using multibiomarker response and metal accumulation. Ecotoxicol. Environ. Saf. 61, 89–97. doi:10.1016/j.ecoenv.2004.07.011
- Dietz, C., Kroeckel, S., Schulz, C., Susenbeth, A., 2012. Energy requirement for maintenance and efficiency of energy utilization for growth in juvenile turbot (*Psetta maxima*, L.): The effect of strain and replacement of dietary fish meal by

- wheat gluten. Aquaculture 358–359, 98–107.
doi:10.1016/j.aquaculture.2012.06.028
- Dietz, C., Stiller, K.T., Griese, M., Schulz, C., Susenbeth, A., 2013. Influence of salinity on energy metabolism in juvenile turbot, *Psetta maxima* (L.). *Aquac. Nutr.* 19, 135–150. doi:10.1111/anu.12034
- Dumitrescu, G., Grozea, A., Szilagyi, P., Petculescu Ciocina, L., Grozea, I., Gal, D., 2014. Natural vs. controlled rearing conditions in pikeperch (*Sander lucioperca*) fingerlings. A histological approach at the liver and intestine level. *Rom. Biotechnol. Lett.* 19, 9531–9542.
- Freitag, A.R., Thayer, L.R., Leonetti, C., Stapleton, H.M., Hamlin, H.J., 2015. Effects of elevated nitrate on endocrine function in Atlantic salmon, *Salmo salar*. *Aquaculture* 436, 8–12. doi:10.1016/j.aquaculture.2014.10.041
- Frisk, M., Skov, P.V., Steffensen, J.F., 2012. Thermal optimum for pikeperch (*Sander lucioperca*) and the use of ventilation frequency as a predictor of metabolic rate. *Aquaculture* 324–325, 151–157. doi:10.1016/j.aquaculture.2011.10.024
- Fry, F.E.J., 1971. The Effect of Environmental Factors on the Physiology of Fish, in: Hoar, W.S., Randall, D.J. (Eds.), *Fish Physiology Volume VI, Environmental Relations and Behavior*. Academic Press, Inc, pp. 1–98. doi:10.1016/S1546-5098(08)60146-6
- Gnaiger, E., 1983. Calculation of Energetic and Biochemical Equivalents of Respiratory Oxygen Consumption, in: *Polarographic Oxygen Sensors*. pp. 337–345.
- Gridale-Helland, B., Takle, H., Helland, S.J., 2013. Aerobic exercise increases the utilization efficiency of energy and protein for growth in Atlantic salmon post-smolts. *Aquaculture* 406–407, 43–51. doi:10.1016/j.aquaculture.2013.05.002
- Grottum, J.A., Trygve, S., 1996. Acute Toxicity of Carbon Dioxide on European Seabass (*Dicentrarchus labrax*): Mortality and Effects on Plasma Ions. *Comp. Biochem. Physiol.* 115, 323–327.
- Hamlin, H.J., 2006. Nitrate toxicity in Siberian sturgeon (*Acipenser baeri*). *Aquaculture* 253, 688–693. doi:10.1016/j.aquaculture.2005.08.025
- Hamlin, H.J., Moore, B.C., Edwards, T.M., Larkin, I.L.V., Boggs, A., High, W.J., Main, K.L., Guillette, L.J., 2008. Nitrate-induced elevations in circulating sex steroid concentrations in female Siberian sturgeon (*Acipenser baeri*) in commercial aquaculture. *Aquaculture* 281, 118–125. doi:10.1016/j.aquaculture.2008.05.030
- Hund, C., 2016. Maintenance Requirement for Energy and Efficiency of Energy and Protein Utilisation for pike perch (*Sander lucioperca*). Master Thesis. Institut für Tierzucht und Tierhaltung, Christian-Albrechts-Universität zu Kiel.

- Ishimatsu, A., Hayashi, M., Lee, K.S., Kikkawa, T., Kita, J., 2005. Physiological effects on fishes in a high-CO₂ world. *J. Geophys. Res. C Ocean.* 110, 1–8. doi:10.1029/2004JC002564
- Jensen, F.B., 1995. Uptake and effects of nitrite and nitrate in animals, in: Walsh, P.J., Wright, P.A. (Eds.), *Nitrogen Metabolism and Excretion*. CRC Press, Boca Raton, pp. 289–303.
- Jobling, M. (Ed.), 1994. *Fish Bioenergetics*, 1st ed. Chapman & Hall Fish & Fisheries Series 13, London.
- Kroupova, H., Machova, J., Svobodova, Z., 2005. Nitrite influence on fish: A review. *Vet. Med. (Praha)*. 50, 461–471.
- Lauff, R.F., Wood, C.H.M., 1996. Respiratory gas exchange, nitrogenous waste excretion, and fuel usage during starvation in juvenile rainbow trout, *Oncorhynchus mykiss*. *J. Comp. Physiol. B* 165, 542–551. doi:10.1007/BF00387515
- Luchiarri, A.C., De Morais Freire, F.A., Pirhonen, J., Koskela, J., 2009. Longer wavelengths of light improve the growth, intake and feed efficiency of individually reared juvenile pikeperch *Sander lucioperca* (L.). *Aquac. Res.* 40, 880–886. doi:10.1111/j.1365-2109.2008.02160.x
- Lupatsch, I., Kissil, G.W., Sklan, D., 2003. Comparison of energy and protein efficiency among three fish species gilthead sea bream (*Sparus aurata*), European sea bass (*Dicentrarchus labrax*) and white grouper (*Epinephelus aeneus*): Energy expenditure for protein and lipid deposition. *Aquaculture* 225, 175–189. doi:10.1016/S0044-8486(03)00288-6
- Martins, C.I.M., Pistrin, M.G., Ende, S.S.W., Eding, E.H., Verreth, J.A.J., 2009. The accumulation of substances in Recirculating Aquaculture Systems (RAS) affects embryonic and larval development in common carp *Cyprinus carpio*. *Aquaculture* 291, 65–73. doi:10.1016/j.aquaculture.2009.03.001
- Monsees, H., Klatt, L., Kloas, W., Wuertz, S., 2016. Chronic exposure to nitrate significantly reduces growth and affects the health status of juvenile Nile tilapia (*Oreochromis niloticus* L.) in recirculating aquaculture systems. *Aquac. Res.* 1–11. doi:10.1111/are.13174
- Müller-Belecke, A., Zienert, S., Thürmer, C., Kaufhold, S., Spranger, U., 2013. The “self cleaning inherent gas denitrification-reactor” for nitrate elimination in RAS for pike perch (*Sander lucioperca*) production. *Aquac. Eng.* 57, 18–23. doi:10.1016/j.aquaeng.2013.06.001
- Nyina-Wamwiza, L., Xu, X.L., Blanchard, G., Kestemont, P., 2005. Effect of dietary protein, lipid and carbohydrate ratio on growth, feed efficiency and body composition of pikeperch *Sander lucioperca* fingerlings. *Aquac. Res.* 36, 486–492. doi:10.1111/j.1365-2109.2005.01233.x

- Pedersen, L.-F., Suhr, K.I., Dalsgaard, J., Pedersen, P.B., Arvin, E., 2012. Effects of feed loading on nitrogen balances and fish performance in replicated recirculating aquaculture systems. *Aquaculture* 338–341, 237–245. doi:10.1016/j.aquaculture.2012.01.035
- Perry, S.F., Gilmour, K.M., 2006. Acid-base balance and CO₂ excretion in fish: Unanswered questions and emerging models. *Respir. Physiol. Neurobiol.* 154, 199–215. doi:10.1016/j.resp.2006.04.010
- Perry, S.F., Jonz, M.G., Gilmour, K.M., 2009. Oxygen Sensing and the Hypoxic Ventilatory Response, in: Richards, J.G., Farrell, A.P., Brauner, C.J. (Eds.), *Fish Physiology Volume 27, Hypoxia*. Elsevier Inc.
- Santos, G. A, Schrama, J.W., Capelle, J., Rombout, J.H.W.M., Verreth, J. A J., 2013. Effects of dissolved carbon dioxide on energy metabolism and stress responses in European seabass (*Dicentrarchus labrax*). *Aquac. Res.* 44, 1370–1382. doi:10.1111/j.1365-2109.2012.03142.x
- Saravanan, S., Geurden, I., Figueiredo-Silva, A.C., Kaushik, S., Verreth, J., Schrama, J.W., 2013. Voluntary feed intake in rainbow trout is regulated by diet-induced differences in oxygen use. *J. Nutr.* 143, 781–7. doi:10.3945/jn.112.173062
- Schaefer, F.J., Flues, S., Meyer, S., Peck, M.A., 2017. Inter- and intra-individual variability in growth and food consumption in pikeperch, *Sander lucioperca* L., larvae revealed by individual rearing. *Aquac. Res.* 48, 800–808. doi:10.1111/are.12924
- Schram, E., Roques, J.A.C., van Kuijk, T., Abbink, W., van de Heul, J., de Vries, P., Bierman, S., van de Vis, H., Flik, G., 2013. The impact of elevated water ammonia and nitrate concentrations on physiology, growth and feed intake of pikeperch (*Sander lucioperca*). *Aquaculture* 420–421, 95–104. doi:10.1016/j.aquaculture.2013.10.027
- Schulz, C., Böhm, M., Wirth, M., Rennert, B., 2007. Effect of dietary protein on growth, feed conversion, body composition and survival of pike perch fingerlings (*Sander lucioperca*). *Aquac. Nutr.* 13, 373–380.
- Schulz, C., Günther, S., Wirth, M., Rennert, B., 2006. Growth performance and body composition of pike perch (*Sander lucioperca*) fed varying formulated and natural diets. *Aquac. Int.* 14, 577–586. doi:10.1007/s10499-006-9056-z
- Stiller, K.T., Vanselow, K.H., Moran, D., Bojens, G., Voigt, W., Meyer, S., Schulz, C., 2015. The effect of carbon dioxide on growth and metabolism in juvenile turbot *Scophthalmus maximus* L. *Aquaculture* 444, 143–150. doi:10.1016/j.aquaculture.2015.04.001

- Szkudlarek, M., Zakeś, Z., 2007. Effect of stocking density on survival and growth performance of pikeperch, *Sander lucioperca* (L.), larvae under controlled conditions. *Aquac. Int.* 15, 67–81. doi:10.1007/s10499-006-9069-7
- Thorarensen, H., Imsland, A.K.D., Gústavsson, A., Gunnarsson, S., Árnason, J., Steinarsson, A., Bouwmans, J., Receveur, L., Björnsdóttir, R., 2018. Potential interactive effects of ammonia and CO₂ on growth performance and feed utilization in juvenile Atlantic cod (*Gadus morhua* L.). *Aquaculture* 484, 272–276. doi:10.1016/j.aquaculture.2017.11.040
- Tielmann, M., Schulz, C., Meyer, S., 2017. The effect of light intensity on performance of larval pike-perch (*Sander lucioperca*). *Aquac. Eng.* 77, 61–71. doi:10.1016/j.aquaeng.2017.03.001
- Timmons, M., Ebeling, J., 2007. *Recirculating Aquaculture*, NRAC Publication No 01-007. Cayuga Aqua Ventures, Ithaca.
- Trabelsi, A., Gardeur, J.N., Teletchea, F., Fontaine, P., 2011. Effects of 12 factors on burbot *Lota lota* (L., 1758) weaning performances using fractional factorial design experiment. *Aquaculture* 316, 104–110. doi:10.1016/j.aquaculture.2011.03.027
- Tseng, Y.C., Hwang, P.P., 2008. Some insights into energy metabolism for osmoregulation in fish. *Comp. Biochem. Physiol. - C Toxicol. Pharmacol.* 148, 419–429. doi:10.1016/j.cbpc.2008.04.009
- Ward, M.H., Kilfoy, B.A., Weyer, P.J., Anderson, K.E., Folsom, A.R., Cerhan, J.R., 2010. Nitrate Intake and the Risk of Thyroid Cancer and Thyroid Disease. *Epidemiology* 21, 389–395. doi:10.1097/EDE.0b013e3181d6201d.Nitrate
- Weaver, D., Keane, P., Francis, M., Williamson, J., True, C., 2016. Towards Zero Discharge: Denitrification and Refractory Organic Cleanup, in: 11th International Conference on Recirculating Aquaculture. Roanoke, pp. 45–46.
- Wendelaar Bonga, S.E., 1997. The stress response in fish. *Physiol. Rev.* 77, 591–625.
- Wuertz, S., Schulze, S.G.E., Eberhardt, U., Schulz, C., Schroeder, J.P., 2013. Acute and chronic nitrite toxicity in juvenile pike-perch (*Sander lucioperca*) and its compensation by chloride. *Comp. Biochem. Physiol. C. Toxicol. Pharmacol.* 157, 352–60. doi:10.1016/j.cbpc.2013.01.002

SUMMARY

Recirculating aquaculture systems (RAS) allow for extensive control of water quality parameters and are defined by their low water exchange rates. At the same time, low water exchange rates promote an accumulation of metabolic end products that may adversely affect the fish and the environment. Unlike most farm animals, fish are poikilothermal and need to constantly adapt to their environment. Energy metabolism and thus growth is therefore greatly influenced by ambient temperature and other environmental factors. The main focus of commercial aquaculture facilities is to influence these interactions in order to achieve the highest possible growth rates. Consequently an understanding of energy metabolism and effects of environmental parameters is necessary. The aim of this study was to identify the most favourable combination of environmental parameters for grow-out of pikeperch (*Sander lucioperca*). Environmental sensitivity is species specific and subject to change throughout life stages. Parameters valid for other species or different life stages of pikeperch can therefore only be used as an approximation and need to be validated for adult pikeperch. Energy balances were compiled within the framework of this thesis to obtain a detailed understanding of the energy metabolism of pikeperch in RAS. This means that it has been evaluated how much energy (feed) the fish consume and what this energy is spent on. The aim of commercial aquaculture is to increase the amount of energy available for growth (so-called retained energy). Commercially applicable results were obtained based on the findings of two single factor experiments (CO₂ and nitrate) followed by a third experiment using a multifactorial approach to validate the results under commercial conditions. This novel approach provided a holistic picture of pikeperch in RAS and a detailed understanding of the complex interactions between pikeperch and several water quality parameters.

The first two experiments (*Chapter 1* and *2*) were conducted in a recirculating aquaculture respirometer system. Respirometry systems are generally used to measure oxygen consumption and ammonia excretion and results are used to compile energy budgets. The resulting energy budgets provided precise baseline data on the energy metabolism of pikeperch and helped to evaluate the general suitability of pikeperch for aquaculture. Any influencing factors, such as CO₂, can now be identified faster and the impact can be assessed in more detail. The results of the first two

experiment showed that pikeperch retain more than 67% of their gross energy intake which is thus available for growth. This value is significantly higher compared to trials on other species, suggesting that pikeperch maintained a favourable energy metabolism. Energy requirement above maintenance for digestible energy (DE_m : $16.40 \pm 2.39 \text{ kJ kg}^{-0.8} \text{ day}^{-1}$) was low compared to results for other species and the efficiency of energy utilisation (k_g : 0.86 ± 0.03) was similarly high. These results show that pikeperch are a good candidate for intensive aquaculture systems.

The first trial (*Chapter 1*) focused on the effect of carbon dioxide (CO_2) as a single factor on growth, feed intake, energy metabolism and health of adult pikeperch. CO_2 accumulates in RAS as a result of fish respiration and bacterial production. Experiments on chronic exposure of other fish species to increased CO_2 concentrations have shown that CO_2 can have a significant impact on growth and health. Degassing units or aerators can be used to remove CO_2 from RAS but these systems have significant cost implications. It is therefore essential to investigate the extent to which removal of CO_2 is necessary. The experiment focused on three CO_2 concentrations commonly found in RAS (5 mg L^{-1} , 15 mg L^{-1} and 30 mg L^{-1}). Results indicated a habituation effect to the hypercapnia conditions but CO_2 concentrations from 15 mg L^{-1} have shown to affect the growth of pikeperch through negatively influencing appetite and thus feed intake. The linear correlation between final bodyweight and CO_2 concentration suggests that there is no CO_2 concentration for pikeperch where no effects subsist. A clear effect on the metabolism was not apparent. The results apply only within the investigated range (4.4 ± 0.5 to $29.7 \pm 0.8 \text{ mg L}^{-1}$). Concentrations below or above these limits have not been studied and are therefore not recommended. The results furthermore showed that pikeperch can survive CO_2 concentrations of up to 30 mg L^{-1} over an extended time period when other water quality parameters are in acceptable levels.

The following experiment (*Chapter 2*) was conducted as a restricted ration experiment with three feeding levels in parallel triplicates in order to determine the energy requirement above maintenance (DE_m) and the efficiency of energy utilisation (k_g) of adult pikeperch in different nitrate concentrations. Nitrate is the end product of the nitrogen cycle and accumulates in RAS, mainly as a result of ammonia excretion by fish. Denitrification reactors can be used to remove nitrate from the system but reactors

are expensive and labour intensive. Additionally by-products of the denitrification process have been identified to negatively influence fish health. Denitrification should thus only be implemented if proven to be economically viable. Tested nitrate levels were based on concentrations commonly found in RAS (5 mg L⁻¹ NO₃-N, 30 mg L⁻¹ NO₃-N, 120 mg L⁻¹ NO₃-N and 240 mg L⁻¹ NO₃-N). Results showed a clear effect of nitrate on metabolism of pikeperch. The lack of a linear correlation between concentration of ambient nitrate and pikeperch metabolism implies that, contradictory to CO₂, an optimal concentration of NO₃-N exists and this concentration should neither be exceeded nor should NO₃-N levels fall below. This is presumably around 30 mg L⁻¹ NO₃-N or at least above N0 (4.8 ± 0.9 mg L⁻¹ NO₃-N) and below N120 (134.0 ± 16.6 mg L⁻¹ NO₃-N). Reasons for the positive effect of moderate nitrate concentrations are pure speculation. Possible causes include the reduced toxicity of nitrite due to increased nitrate levels as well as the estrogen-like effect of nitrate and the associated positive effect on growth hormones whereas at higher concentrations the toxicological response (methaemoglobinemia) predominates. Results showed that pikeperch can survive concentrations of NO₃-N of up to 240 mg L⁻¹ but elevated nitrate levels showed a clear effect on protein metabolism in fasting fish. Pikeperch in this group had to use body protein to fuel an average of 46 ± 7% of their energy metabolism compared to 12 ± 2% in the N0 treatment. Increased levels of protein catabolism are a known reaction to different stressors but an evaluation of blood parameters should be conducted in order to verify that a stress reaction occurred. Additionally a main factor of interest in aquaculture nutrition is the use of protein for growth instead of energy metabolism. Increased levels of protein utilisation for energy metabolism are therefore not desirable and should be prevented.

In *chapter 3* a multifactorial approach was used to focus on the effects of several water quality parameters on growth of pikeperch by use of cumulative feed burden (CFB) in small scale RAS (*Chapter 3*). The CFB is a measure of intensity of water reuse and describes the relation of input (feed) into the system and the water exchange rate. It is used as a measure of production intensity and as a proxy for the interpretation of water quality parameters that accumulate in the system and are not actively removed e.g. fine solids and organic compounds, heavy metals and trace minerals, hormones or nitrate as the end product of the nitrogen cycle. Nitrate, nitrite, ammonia, suspended

SUMMARY

solids, organic carbon and total carbon correlated with CFB over the course of the experiment and analysis of heavy metals showed a positive correlation between CFB and phosphorus, arsenic, copper, potassium and zinc. The functional relationships between CFB and several water quality parameters emphasized that the utilisation of CFB to mimic commercial production is reasonable. The experiment has shown that there is a non-linear relationship between growth rate and CFB. Pikeperch exhibited growth up to CFB values of 4000 mg L⁻¹ but the best growth rate was achieved with a CFB of 1953 ± 613 mg L⁻¹. The CFB approach made it possible to narrow down the bandwidth of the recommendable NO₃-N concentration to 45.2 – 94.6 mg L⁻¹. The threshold value for CO₂ could be diminished from 15 mg L⁻¹ to 7.1 – 9.7 mg L⁻¹. Nevertheless CO₂ should be kept as low as possible as the single factor experiment has shown that even low concentrations of CO₂ have an effect on feed intake. Ambient concentration of CO₂ should not fall below the lowest tested limit of 4.4 ± 0.5 mg L⁻¹. Lower levels of CO₂ can potentially cause alkalosis and thus have a negative effect on the fish. The calculated optimal range for parameters not evaluated in single factor experiments should only be used as an approximation as the clear relation between the corresponding environmental parameter and pikeperch performance should be evaluated in a single factor experiment.

This study showed that pikeperch is a promising candidate for ongrowing in RAS due to the favourable energy metabolism under high intensity RAS conditions and the general ability to cope with challenging water quality conditions. The CFB provided an effective measure to mimic commercial conditions and the identification of an optimal level of intensification in RAS through the CFB level of 1953 ± 613 mg L⁻¹ provides a useful measure for commercial scale pikeperch production in RAS, even though an optimal range could not be defined for all environmental parameters. The use of a degassing unit in RAS for pikeperch is recommended, while the need for a denitrification unit depends on the actual nitrate concentration and may not be necessary. It has been shown that both single- and multifactorial experiments are necessary in order to adequately evaluate the influence of environmental parameters in commercial systems. Future research should therefore be based on this holistic approach.

ZUSAMMENFASSUNG

Aquakultur - Kreislaufanlagen (KLA) ermöglichen eine umfangreiche Kontrolle aller Haltungparameter und zeichnen sich besonders durch Ihren geringen Wasserverbrauch aus. Niedrige Wasseraustauschraten begünstigen jedoch gleichzeitig eine Akkumulation von Stoffwechselendprodukten, die sich negativ auf einzelne Haltungparameter auswirken können. Anders als die meisten landwirtschaftlichen Nutztiere sind Fische wechselwarm und müssen sich daher kontinuierlich an ihre Umgebung anpassen. Ihr Energiestoffwechsel, und damit ihr Wachstum, wird somit in großem Maße von ihrer Umgebung beeinflusst. Hauptaugenmerk von kommerziellen Zuchtanlagen ist es, diese Interaktionen so zu beeinflussen, dass möglichst hohe Wachstumsraten erreicht werden. Ziel dieser Arbeit war es, die optimalen Umweltbedingungen für Zander (*Sander lucioperca*) in Aquakulturanlagen herauszufinden. Die Sensibilität gegenüber Umweltparametern ist artspezifisch. Somit können Richtwerte, die für andere Arten gelten, nur als Annäherung dienen und müssen für Zander validiert werden. Bisher lag der Forschungsschwerpunkt auf der Larven- und Jungtieraufzucht, doch Erfahrungen haben gezeigt, dass diese Ergebnisse nicht uneingeschränkt übertragbar sind. Im Rahmen dieser Arbeit wurden Energiebilanzen erstellt um detaillierte Informationen über den Energiestoffwechsel von Zandern zu erhalten. Das bedeutet, es wurde evaluiert, wie viel Energie (Futter) die Zander aufnehmen und wofür sie diese Energie verbrauchen. Ziel von Aquakulturanlagen ist, dass möglichst viel Energie für Wachstum zur Verfügung steht (sogenannte retinierte Energie). Um Ergebnisse zu erhalten, die auch in kommerziellen Anlagen gelten und mögliche Interaktionen von Umweltparametern zu bestimmen, wurden zunächst zwei Versuche mit Einzelfaktoren (Kohlenstoffdioxid (CO₂) und Nitrat) durchgeführt und die Ergebnisse in einem dritten Versuch, durch einen multifaktoriellen Versuchsansatz, verifiziert. Dieser neuartige Ansatz ermöglichte, ein ganzheitliches Bild von Zandern in KLA zu erfassen und ein detailliertes Verständnis für die komplexen Interaktionen zwischen den Fischen und verschiedenen Wasserqualitätsparametern zu bekommen.

Die ersten beiden Versuche (*Kapitel 1* und *2*) wurden in einem Respirometer durchgeführt. Respirometer ermöglichen eine detaillierte Erfassung von

Sauerstoffverbrauch und Ammoniumausscheidung der Fische. Aus den Ergebnissen können dann Energiebilanzen erstellt werden. Mit Hilfe dieser Energiebilanzen ist es möglich, die generelle Eignung von Zander als Zuchtfisch für Aquakulturanlagen zu bewerten und zu vergleichen. Etwaige Einflussfaktoren, wie z.B. CO₂ können so schneller identifiziert und die Auswirkungen besser bewertet werden. Die Ergebnisse beider Versuche haben gezeigt, dass Zander eine für die Aquakultur sehr positive Energiebilanz aufweisen da sie über 67% ihrer aufgenommenen Bruttoenergie retinieren d.h. für Wachstum nutzen können. Des Weiteren wurden der Energieerhaltungsbedarf für verdauliche Energie (DE_m: 16.40 ± 2.39 kJ kg^{-0.8} day⁻¹) sowie die Effizienz der Energieverwertung für das Wachstum (k_g: 0.86 ± 0.03) bestimmt. Diese Werte treffen eine Aussage darüber, wie viel Energie die Fische mindestens zum Erhalt ihrer Körperfunktionen benötigen und wie effizient sie die aufgenommene Energie in Wachstum umsetzen. Der Energiehaushalt von Zandern in KLA erwies sich insgesamt als vergleichbar mit anderen Aquakulturspezies.

Im ersten Kapitel wurde der chronische Einfluss von Kohlenstoffdioxid (CO₂) als Einzelparameter auf Wachstum, Futteraufnahme, Energiestoffwechsel und Gesundheit von adulten Zandern untersucht. CO₂ akkumuliert sich in Kreislaufanlagen aufgrund des Stoffwechsels der Fische sowie bakterieller Produktion. Versuche an anderen Fischen haben gezeigt, dass CO₂ einen signifikanten Einfluss auf Wachstum und Gesundheit haben kann. In Kreislaufanlagen kann CO₂ mit Hilfe von technischen Lösungen entfernt werden, doch diese Systeme sind kostenintensiv. Es ist daher unumgänglich zu erforschen, zu welchem Grad eine Entfernung von CO₂ notwendig ist. Für den Versuch wurden drei in Aquakulturanlagen übliche CO₂ Konzentrationen (5 mg L⁻¹, 15 mg L⁻¹ und 30 mg L⁻¹) in einem Gruppenrespirometer getestet. Die Ergebnisse haben gezeigt, dass Konzentrationen über 15 mg L⁻¹ einen negativen Einfluss auf den Appetit und somit indirekt auf die Futteraufnahme und das Wachstum haben. Ein eindeutiger Effekt auf den Metabolismus wurde nicht ersichtlich. Der lineare Zusammenhang zwischen dem Endgewicht und der CO₂ Konzentration suggeriert, dass es keinen Grenzwert für die CO₂ Konzentration gibt, sondern der Gehalt so gering wie möglich gehalten werden sollte. Die Ergebnisse gelten allerdings nur für den untersuchten Bereich (4.4 ± 0.5 bis 29.7 ± 0.8 mg L⁻¹). Konzentrationen unter- bzw. oberhalb dieser Grenzwerte wurden nicht untersucht und werden daher

nicht empfohlen. Des Weiteren konnte gezeigt werden, dass Zander generell in der Lage sind mit CO_2 Konzentrationen von bis zu 30 mg L^{-1} über längere Zeit zurecht zu kommen, solange alle anderen Wasserqualitätsparameter in Ordnung sind.

Das zweite Kapitel beschäftigt sich mit dem Einfluss verschiedener Nitrat Konzentrationen auf den Energieerhaltungsbedarf für verdauliche Energie (DE_m) und die Effizienz der Energieverwertung für das Wachstum (k_g) von Zandern. Dieser Versuch wurde ebenfalls in einem Respirometer durchgeführt. Nitrat ist das Endprodukt der biologischen Umwandlung von Ammonium (Ausscheidung der Fische) und akkumuliert sich in Kreislaufsystemen. Denitrifikationsreaktoren können eingesetzt werden um Nitrat aus dem Haltungswasser zu entfernen, doch diese Systeme sind kosten- und arbeitsintensiv. Eine negative Beeinflussung der Fischgesundheit durch Nebenprodukte der Denitrifikation ist zudem keine Seltenheit. Daher sollte eine Denitrifikation nur dann eingesetzt werden, wenn eine Verwendung sich als wirtschaftlich sinnvoll erweist. Die untersuchten Nitratkonzentrationen orientierten sich an üblicherweise vorliegenden Konzentrationen ($5 \text{ mg L}^{-1} \text{ NO}_3\text{-N}$, $30 \text{ mg L}^{-1} \text{ NO}_3\text{-N}$, $120 \text{ mg L}^{-1} \text{ NO}_3\text{-N}$ und $240 \text{ mg L}^{-1} \text{ NO}_3\text{-N}$). Der Versuch wurde als rationierter Fütterungsversuch mit verschiedenen Fütterungsintensitäten durchgeführt und es konnte ein deutlicher Effekt von Nitrat auf den Metabolismus von Zandern identifiziert werden. Interessanterweise lag die effizienteste Energieverwertung dabei nicht bei der geringsten Konzentration sondern bei $30 \text{ mg L}^{-1} \text{ NO}_3\text{-N}$ bzw. oberhalb von N0 ($4.8 \pm 0.9 \text{ mg L}^{-1} \text{ NO}_3\text{-N}$) und unterhalb von N120 ($134.0 \pm 16.6 \text{ mg L}^{-1} \text{ NO}_3\text{-N}$). Das nichtlineare Verhältnis suggeriert, dass geringe Nitratkonzentrationen einen positiven Einfluss auf Zander haben und die toxische Wirkung erst später einsetzt. Gründe für einen positiven Effekt von Nitrat auf Zander sind allerdings, bei vorliegender Datenlage, reine Spekulation. Mögliche Ursachen sind die reduzierte Toxizität von Nitrit durch erhöhte Nitratwerte sowie die oestrogenähnliche Wirkung von Nitrat und die damit einhergehende positive Wirkung auf Wachstumshormone. Die Ergebnisse zeigen, dass Zander Nitratkonzentrationen von bis zu $240 \text{ mg L}^{-1} \text{ NO}_3\text{-N}$ überleben, wobei jedoch der Proteinstoffwechsel bei hohen Konzentrationen negativ beeinflusst wird. In dieser Gruppe haben Zander im nüchternen Zustand im Schnitt $46 \pm 7\%$ ihres Erhaltungsstoffwechsels über den Abbau von Körperproteinen gewährleistet im Vergleich zu $12 \pm 2\%$ in der Kontrollgruppe (N0). Ein erhöhter Proteinabbau

(Katabolismus) ist eine bekannte Reaktion auf verschiedenen Stressoren, doch um zu bestätigen, dass es sich um eine Stressreaktion handelt, wären detaillierte Blutanalysen notwendig. Aus Kostengründen ist es insgesamt in der Aquakultur von Interesse, dass Proteine aus der Nahrung für Wachstum und nicht für die Energiegewinnung genutzt werden und Körperprotein nicht abgebaut wird.

Das dritte Kapitel beschäftigt sich mit einem multifaktoriellen Ansatz. Über die Futterlast bzw. den *Cumulative Feed Burden* (CFB) wurden in einzelnen Kleinkreisläufen verschieden intensive kommerzielle Anlagen nachgestellt. Der CFB definiert sich als Verhältnis von Futtereintrag in das System zum Austrag (über Wasserwechsel). Auf diese Weise wird eine sich akkumulierende Futterlast in mg L^{-1} errechnet, die wiederum zum Vergleich verschiedener KLA und deren Intensität genutzt werden kann. Der CFB erlaubt somit eine Interpretation von Stoffen die sich im System anreichern, wie z.B. organische Verbindungen, Schwebstoffe, Schwermetalle und Spurenelemente, Hormone oder Nitrat als Endprodukt des Stickstoffkreislaufes. Im Rahmen des Versuches wurden detaillierte Wasserparameter aufgenommen und Wachstums- sowie Gesundheitsparameter der Fische erhoben. Es konnte gezeigt werden, dass die Konzentration von Nitrat, Nitrit, Ammonium, Schwebstoffen, organischem Kohlenstoff und Gesamt-Kohlenstoff mit dem CFB über den gesamten Versuchszeitraum korrelierte. Die Analyse von Schwermetallen und Spurenelementen am Ende des Experiments zeigte zudem eine Korrelation zwischen dem CFB und Phosphor, Arsen, Kupfer, Kalium und Zink. Die funktionalen Beziehungen zwischen dem CFB und verschiedenen Wasserqualitätsparametern verdeutlichen, dass der CFB ein gutes Mittel zur Nachahmung kommerzieller Systeme darstellt. Der Versuch hat gezeigt, dass es einen nicht-linearen Zusammenhang zwischen Wachstumsrate und CFB gibt. Das beste Wachstum konnte bei einem CFB von $1953 \pm 613 \text{ mg L}^{-1}$ erreicht werden. Die ausführlich ermittelten Zusammenhänge zwischen einzelnen Wasserparametern und dem CFB konnten zudem genutzt werden um die optimalen Haltungparameter weiter einzugrenzen. In Bezug auf den Nitratwert konnte der optimale Bereich so auf $45.2 - 94.6 \text{ mg L}^{-1} \text{ NO}_3\text{-N}$ eingegrenzt werden. Der vorher ermittelte Grenzwert von 15 mg L^{-1} für CO_2 wurde durch den multifaktoriellen Ansatz auf $7.1 - 9.7 \text{ mg L}^{-1}$ reduziert. Allerdings wurde im Einzelfaktorexperiment zwar ein Grenzwert ermittelt, es wurde aber auch gezeigt, dass schon geringe Konzentrationen

einen Einfluss auf die Futteraufnahme haben. Erstrebenswert ist damit ein möglichst geringer CO₂ Gehalt im Haltungswasser. Die getestete Untergrenze von $4.4 \pm 0.5 \text{ mg L}^{-1}$ sollte dabei nicht unterschritten werden, da über geringere Konzentrationen keine Informationen vorliegen. Niedrige CO₂ Konzentrationen können unter Umständen zu Alkalosen führen und somit ebenfalls negative Auswirkungen haben. Die errechneten optimalen Bereiche für Nitrit, Ammonium, (organischen) Kohlenstoff sowie Schwebstoffe können, aufgrund der fehlenden Einzelparameteranalyse, nur als Anhaltspunkte für eine kommerzielle Zuchtanlage dienen.

Das Ziel dieser Arbeit war es, detaillierte Energiebudgets für Zander aufzustellen sowie optimale Haltungsbedingungen zu ermitteln. Zusammenfassend kann festgestellt werden, dass Zander vielversprechende Kandidaten für die Produktion in KLA sind. Auch wenn nicht für alle Haltungsparameter ein optimaler Bereich definiert werden konnte, liefern die Ergebnisse des CFB Versuches einen guten Anhaltspunkt für eine Vielzahl an Einzelparametern. Der Einsatz einer Entgasungsstufe in Zanderanlagen wird empfohlen, während die Notwendigkeit einer Denitrifikationsstufe vom tatsächlichen Nitratwert abhängt und unter Umständen nicht notwendig ist. Des Weiteren konnte gezeigt werden, dass sowohl einzel- als auch mehrfaktorielle Versuche notwendig sind, um Aussagen über die Einflüsse von Umweltparametern, besonders in kommerziellen Systemen, tätigen zu können. Zukünftige Versuche sollten sich daher auf diesen ganzheitlichen Ansatz beziehen.

APPENDIX

Recirculating Aquaculture Respirometer System (RARS)

The respirometry system was used in *Chapter 1* and *2*.

The recirculating aquaculture respirometer system (RARS) is described in detail by Stiller et al. (2013). The layout of the system can be seen in Fig. A-1.

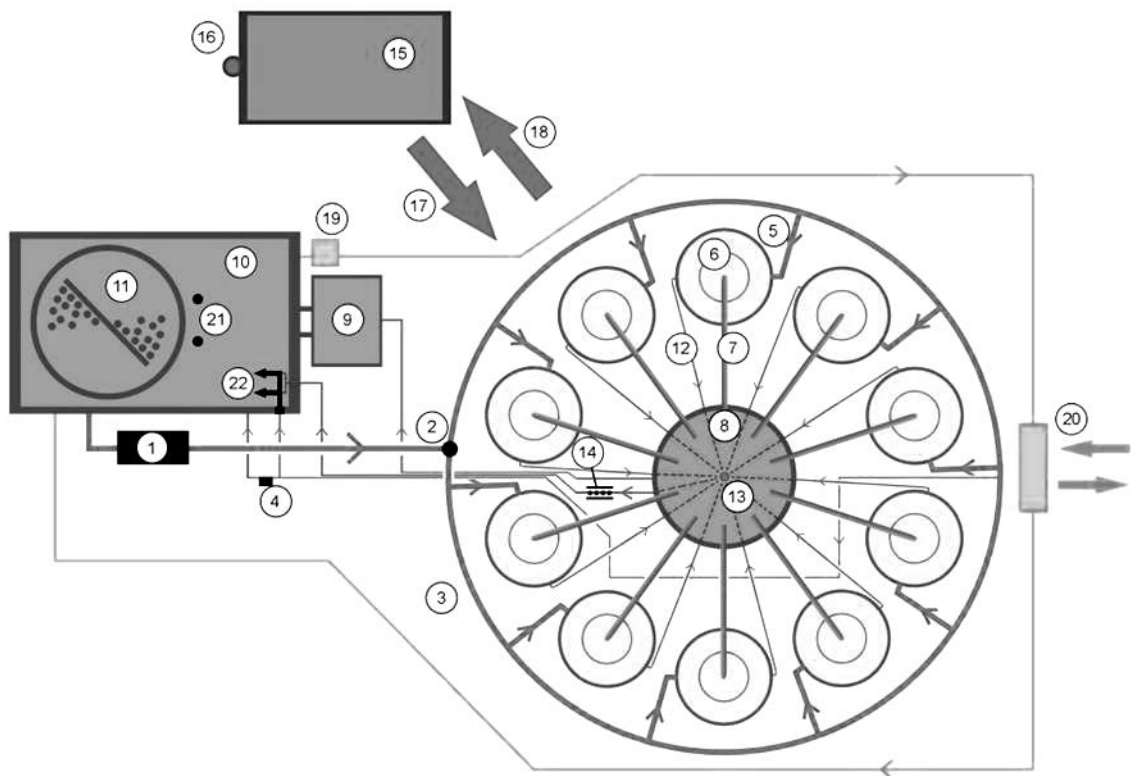

Figure A-1 Overview of the recirculating aquaculture respirometer system (RARS).

- | | |
|-------------------------------|-------------------------|
| 1. Recirculation Pump | 2. Manometer |
| 3. Water Distribution Circuit | 4. Overflow Valve |
| 5. Tank Inflow | 6. Respirometry Tank |
| 7. Tank Overflow | 8. Sedimentation Barrel |
| 9. Particle Filter | 10. Sump |
| 11. Trickling Filter | 12. Sampling Circuit |
| 13. Directional Valve | 14. Sensors |
| 15. Online Control Unit | 16. Main Power Switch |
| 17. Data Transfer | 18. Data Transfer |
| 19. Temperature Circuit Pump | 20. Heat Exchanger |
| 21. Temperature Sensors | 22. Water Jet Pumps |

The RARS consists of 10 PVC tanks with a volume of 250 L each. The tanks are made of opaque PVC at the side and back and translucent PVC at the front to observe the fish. One tank is kept empty of fish and used as a reference. In this tank, walls have to be cleaned manually on a daily basis to avoid any effect of biofilm build-up on oxygen consumption. The tanks have a separate in and outflow and are continuously supplied with freshwater at an adjustable flow rate of 150 - 300 L h⁻¹. Each tank consists of an external pump to generate a circular flow and ensure the best mixing of water. Tanks are connected to the sampling unit through a separate outflow. Opening and closing of this outflow is controlled by the control unit via pressurised valves. An additional valve at the bottom of each tank allows for settled solids to be drained manually. Water exits the tanks through an overflow valve towards the sedimentation unit. A second pipe installed at the top of the tanks allows for feeding the fish in the closed RARS.

The filtration unit consists of a sedimentation barrel, a sedimentation tank with a particle filter and a cylindrical trickling filter. Temperature is adjusted in a separate temperature circuit with a titanium plate heat exchanger with a control unit (TSC 510; Behncke GmbH, Munich, Germany). The corresponding temperature sensors are located in the sump.

Oxygen concentration (oxygen optode 4330, Serial No. 1557, Aandera data instruments, Bergen, Norway), temperature (compensation thermometer Type 201085), pH (pHNBS intermediate junction electrode, Ionode IJ44, TPS Pty Ltd, Brisbane, Australia), dissolved carbon dioxide (purpose built flow through headspace analyser, MK-2 pCO₂ / Fast Analyser (SubCtech GmbH, Kiel, Germany) with non-dispersive infrared detection, LI-840A (LI-COR Biosciences, Nebraska, United States)) and total ammonia-nitrogen (TAN, loop flow orthophtalaldehyde fluorometric autoanalyser, µMac, SYSTEVA S.p.A., Anagni, Italy) can be measured online every 12 min in each tank via the sampling circuit.

The water flow is maintained by a 1-2 bar circuit pump constantly keeping the pressure in the water distribution circuit above 1 bar to maintain freshwater supply to the tanks. Water flow from the sedimentation barrel to the pump sump is solely gravity based.

Fish Parameters

Fish were analysed for growth and whole body composition in *Chapter 1 and 3*. Energy metabolism was closely analysed in *Chapter 1 and 2*.

Whole Body Composition Analysis

Analysis of whole body composition was conducted in *Chapter 1 and 3*.

The reference sample was taken at the beginning of each experiment and is based on three randomly selected fish. The samples each consist of three fish per tank that were randomly selected, freeze dried and homogenized. Due to the heterogeneous nature of the sample proper mixing is necessary prior to taking a sub-sample. All analysis was conducted in duplicates and repeated if the standard deviation between the two replicates exceeded 0.3%. Analysis of dry matter, crude protein, crude fat, crude ash and gross energy was conducted according to EU Guidelines (EC) 152/2009 (European Commission, 2009).

Dry matter was determined after drying the sample (2 g) for 4h at 103°C and ash content was weighted following an additional 4 h at 550°C in a combustion oven. Samples were cooled to room temperature in a dehydrator prior to weighting on a precision scale. Kjeldahl method (InKjel 1225 M, WD 30; Behr, Dusseldorf, Germany) was used to determine the crude protein content of a 0.5 g sample. Crude fat content (2 g sample) was determined via HCl hydrolysis followed by extraction using petroleum ether with a Soxhlet extraction system (R 106 S; Behr). A bomb calorimeter (C200, IKA, Staufen, Germany) was used to determine the gross energy content of a 0.5 g sample.

Energy Budgets

Energy budgets were compiled in *Chapter 1 and 2*.

All measurements were normalised to an individual fish. Calculations were based on the metabolic body weight (MBW) to compensate for growth during the experiment, using the common metabolic weight exponent for energy of 0.8 (Clarke and Johnston, 1999; Lupatsch et al., 2003). All calculations are based on the energy content of the diet which was analysed with a bomb calorimeter (C200, IKA, Staufen, Germany). The digestibility of the diets was estimated as 89.1% based on unpublished results of previous experiments.

Specific dynamic action (SDA) reflects the energy requirement associated with feeding and is calculated as the difference between routine oxygen consumption (ROC) and starving oxygen consumption (SOC)

$$SDA (mg\ kg^{-0.8}h^{-1}) = ROC (mg\ kg^{-0.8}h^{-1}) - SOC (mg\ kg^{-0.8}h^{-1})$$

Gross Energy Intake (GEI) specifies the energy intake of an individual fish based on the gross energy (GE) of the diet, the feed intake (FI) and the metabolic body weight (MBW)

$$GEI (kJ\ kg^{-0.8}\ day^{-1}) = \frac{GE (kJ\ g^{-1}) \times FI (g\ day^{-1})}{MBW (kg^{-0.8})}$$

The digestible energy intake (DEI) is based on the actual digestible energy (DE) of the diet

$$DEI (kJ\ kg^{-0.8}\ day^{-1}) = \frac{DE (kJ\ g^{-1}) \times FI (g\ day^{-1})}{MBW (kg^{-0.8})}$$

The energy of non-fecal nitrogen (E_N) is calculated based on the assumption that pikeperch excrete 15% of N as urea and 85% as ammonia with energy equivalents (E_E) of 24.8 kJ g⁻¹ for ammonia-N and 23.0 kJ g⁻¹ for urea-N (Elliott and Davison, 1975; Jobling, 1994; Wright and Anderson, 2001).

$$E_N (kJ\ kg^{-0.8}\ day^{-1}) = \frac{N - loss (g\ day^{-1}) \times E_E (kJ\ g^{-1})}{MBW (kg^{-0.8})}$$

The difference between DEI and E_N equals the metabolisable energy intake (MEI) and equals the energy available to the fish

$$MEI (kJ\ kg^{-0.8}\ day^{-1}) = DEI (kJ\ kg^{-0.8}\ day^{-1}) - E_N (kJ\ kg^{-0.8}\ day^{-1})$$

Energy losses are determined indirectly via oxygen consumption (OC) with an energy equivalent of 13.6 kJ g⁻¹ O₂ (Elliott and Davison, 1975).

$$heat (kJ\ kg^{-0.8}\ day^{-1}) = OC (g\ kg^{-0.8}\ day^{-1}) \times 13.6\ kJ\ g^{-1}$$

The retained energy (RE) equals the energy retained in the fish and thus available for growth. It is calculated based on energy losses (heat) and energy available to the fish (MEI)

$$RE (kJ kg^{-0.8} day^{-1}) = MEI (kJ kg^{-0.8} day^{-1}) - heat (kJ kg^{-0.8} day^{-1})$$

Energy Metabolism Efficiency and Maintenance Requirements

Energy metabolism efficiency and maintenance requirements were calculated in *Chapter 2* based on the results of a restricted ration feeding experiment with three feeding levels based on the metabolic body weight (MBW) (1.25% MBW, 2.00% MBW and 2.75% MBW).

The maintenance requirements and efficiencies of energy utilisation for growth above maintenance were determined through a linear regression analysis following the linear regression equation

$$RE (kJ kg^{-0.8} day^{-1}) = k_{g(DE)} * DEI (kJ kg^{-0.8} day^{-1}) + a$$

The energy intake at RE = 0 is defined as the maintenance requirement of the fish. The slope represents the efficiency of energy utilisation. In order to determine the standard errors for the slope (k_g) and the y-intercept (a) the following equation was used where energy intake was taken as dependant and RE as independent variable

$$DEI (kJ kg^{-0.8} day^{-1}) = \frac{1}{k_{g(DE)}} * RE (kJ kg^{-0.8} day^{-1}) + DE_m$$

The reciprocal of the k_g value describes the cost for DE (kJ) per unit of RE (kJ).

Water Quality Analysis

Water samples in the respirometry trials (*Chapter 1 and 2*) were taken prior to feeding in the sedimentation barrel. Water samples in the CFB trial were taken in each RAS separately prior to feeding, directly in the fish tank. The sampling flasks were rinsed three times with the sampled water before the final sample was taken and analysed instantly or cooled (4°C) until analysis later on the same day. Water samples for analysis of heavy metals and trace minerals were stored at -20°C.

Carbon

Determined in *Chapter 3*.

Total carbon (TC) total organic carbon (TOC) (measured as non-purgeable organic carbon (NPOC)) and inorganic carbon (IC) were measured with a Total Organic Carbon Analyzer (Shimadzu Corp., Kyoto, Japan).

Total carbon (TC) is measured as carbon dioxide. The sample is heated to 680°C and burned in the combustion tube with an oxidation catalyst. As a result all TC components are converted to CO₂. The gas flows to a dehumidifier with a carrier gas, where it is cooled and dehydrated. The sample is then cleaned of chlorine and other halogens through a halogen scrubber before being analysed in the cell of a non-dispersive infrared gas analyser (NDIR). The analog signal of the NDIR forms a peak and the peak area is proportional to the TC concentration in the sample.

Inorganic carbon (IC) is also measured as carbon dioxide. The sample is acidified with hydrochloric acid to obtain a pH below 3. As a result all carbonates are converted to carbon dioxide. The carbon dioxide is then volatilized by sparging carbon dioxide free air or nitrogen gas through the sample.

Non-purgeable organic carbon (NPOC) is measured as TC after the IC fraction of the sample is eliminated through sparging. The result is referred to as total organic carbon (TOC). TOC can also be calculated as difference between TC and IC.

Carbon Dioxide

Determined in *Chapter 1* and *3*.

Carbon dioxide is a colourless gas and consists of a carbon atom that is covalently bound to two oxygen atoms. Solubility in water is moderate and it is present as either dissolved CO_2 , bicarbonate (HCO_3^-) or carbonate (CO_3^{2-}) depending on the pH (Mortimer and Müller, 2003; Zeebe and Wolf-Gladrow, 2001). The equilibrium has the form:

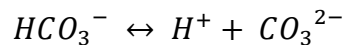
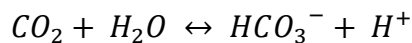

(Mortimer and Müller, 2003)

The dissolved CO_2 (in gas form) affects the fish and is the factor of interest for CO_2 measurement in aquaculture systems.

Measurement of carbon dioxide concentration in the respirometer (*Chapter 1*) was conducted with the built-in headspace analyser (SubCtech GmbH, Osdorf, Germany). Measurement of dissolved CO_2 in the headspace analyser is conducted with a non-dispersive infrared (NDIR) analyser. The unit was set to measure dissolved CO_2 but can also be used to determine bicarbonate or carbonate.

Carbon dioxide concentration was measured with the OxyGuard® CO_2 Portable Analyser in *Chapter 3*. Measurement was conducted as described in the user manual. Due to the long response time in still water (15 minutes according to the manual), a small measurement unit consisting of a 15 cm pipe and an electromagnetic pump was built in order to achieve appropriate exposure of the sensor to flowing water. The OxyGuard CO_2 only measures the dissolved CO_2 concentration in the water in mg L^{-1} (range: 0 – 50 mg L^{-1}). The analyser consists of a probe connected to a transmitter with a display. Salinity can be adjusted on the transmitter as salinity affects the amount of dissolved CO_2 for a given partial pressure of CO_2 . Temperature compensation is done automatically (range: 3°C to 35°C). The sensor in the probe is protected by a gas permeable membrane and is completely insensitive to oxygen, nitrogen, argon or any

other dissolved gas apart from CO₂. The sensor does not consume CO₂ for the measurement nor does it adjust pH. Measurement thus has no effect on the water.

Total Suspended Solids

Determined in *Chapter 3*.

Concentration of total suspended solids (TSS) was measured based on filtration of a sample through a filter, followed by drying and weighing the filter.

Sample size: 250 – 1000 mL depending on the degree of contamination

Filter size: 1.3 µm

Filters were weighted in petri dishes individually and weight was noted (accuracy 0.1 mg). The water sample was stirred carefully before filtration. A vacuum pump was used to suck a minimum of 250 mL of water sample through the filter. If filtration took less than 5 minutes, additional 250 mL of the same water sample were added. If possible, this was done until 1000 mL of water sample were filtered. The filters were dried for 24 hours at 105°C before weighting at an accuracy of 0.1 mg. The amount of TSS was calculated as final filter weight – initial filter weight x filtered volume in litres.

Heavy Metals and Minerals

Determined in *Chapter 3*.

Concentration of Metals and minerals was analysed by Agrolab (AGROLAB Agrar und Umwelt GmbH, Kiel, 112 Germany) according to DIN EN ISO 6878 (Phosphorus), DIN EN ISO 17294-2 (Arsenic, Potassium, Lead, Copper and Zinc) and DIN EN ISO 12846 (Mercury). The samples were filtered prior to analysis due to the high amount of suspended solids in the samples. Water samples for heavy metal and mineral analysis were stored at -20°C before sending to the laboratory.

Nitrate

Determined in *Chapter 1, 2 and 3*.

Measurement of concentration of nitrate-nitrogen (NO₃-N) was conducted with a pre-dosed photometric test (Hach Lange GmbH, Düsseldorf, Germany). Test principle is

described in detail in the user manual. The chemical reactions are described by Grasshoff et al. (1983).

Principle: Reaction of nitrate ions with 2,6-dimethylphenol to form 4-nitro-2,6-dimethylphenol. Concentrated phosphoric and sulfuric acid (85%) is added to the water sample before adding 2,6-dimethylphenol. The resulting 4-nitro-2,6-dimethylphenol is measured photometrically (after 15 minutes) at 318 nm.

Interferences: Increased concentrations of oxidisable organic substances can influence the colour of the reagent and thus tamper with the results. Concentrations of nitrite of more than 2.0 mg L⁻¹ can interfere with the results and should be removed by the addition of amidosulphuric acid. Reagent and sample temperature should be kept between 20°C to 24°C and pH should be between 3 – 10.

Ammonia

Determined in *Chapter 1, 2 and 3*.

Online determination of ammonia (as total-ammonia-nitrogen, TAN) in the respirometer (*Chapter 1 and 2*) was done automatically with a NH₃-N loop flow orthophthaldehyde fluorimetric autoanalyser (µMac, SYSTEVA S.p.A., Anagni, Italy). The measurement is based on a reaction of ammonia ions with orthophthaldehyde. The sample is heated to 55°C and passes through a fluorimetric cell. Measurement is conducted at 420 nm.

Ammonia concentration in *Chapter 3* was measured photometrically as ammonia - nitrogen (NH₃-N) with an Ammonia Nitrogen Test Kit (Hach Lange GmbH, Düsseldorf, Germany). The determination is based on the Salicylate method. The test principle is described in detail in the user manual and the chemical reactions are described in detail by Grasshoff et al. (1983). Ammonia and chlorine are combined to form monochloramine which reacts with salicylate to form 5-aminosalicylate. The latter is oxidized with a sodium nitroprusside catalyst. The resulting blue colour is masked by the yellow colour from the excess reagent to give a final green-coloured solution. The final solution is measured at 655 nm. Due to the colour of the reagent it is necessary to add the reagent to the blank sample as well.

Interferences: pH level should be adjusted to approximately pH 7. High levels of nitrate (> 100 mg L⁻¹ NO₃-N) and nitrite (> 12 mg L⁻¹) can interfere with the measurement.

Other possibly interfering substances are calcium ($> 1000 \text{ mg L}^{-1} \text{ CaCO}_3$), iron, magnesium ($> 6000 \text{ mg L}^{-1}$ as CaCO_3), monochloramine, phosphate ($> 100 \text{ mg L}^{-1} \text{ PO}_4\text{-P}$) sulfate ($> 300 \text{ mg L}^{-1} \text{ SO}_4$) and sulphide.

Nitrite

Determined in *Chapter 1, 2 and 3.*

Nitrite concentration was measured photometrically as nitrite – nitrogen ($\text{NO}_2\text{-N}$) with a Nitrite Nitrogen Test Kit (Hach Lange GmbH, Düsseldorf, Germany). The determination is according to Grasshoff et al. (1983). Sulphanilamide hydrochloride reacts with the nitrite ion in an acidic solution. The resulting diazonium compound is coupled with chromotropic acid resulting in a pink solution. This is then measured photometrically at 507 nm.

Interferences: High levels of nitrate ($> 100 \text{ mg L}^{-1} \text{ NO}_3\text{-N}$) can cause interference due to reduction to nitrite. The method is interfered by high chloride concentrations (seawater). Calibration needs to be conducted with the same salinity as the final samples. Increased turbidity can interfere with the photometric measurement. Additional interferences can be due to several ions causing precipitation. The prepared sample should be kept out of direct sunlight as UV changes the colour of the test.

Cumulative Feed Burden

This calculation was used in *Chapter 3*

The cumulative feed burden (CFB) is used to quantify mass input (feed) into the system over time in relation to water exchange and typically expressed as weight per volume (mg L^{-1}) (Colt et al., 2006).

The CFB can be calculated as

$$CFB = \frac{feed [mg]}{V [L]} + \frac{CFB_{(n-1)} [mg L^{-1}] \times (V [L] - R [L])}{V [L]}$$

V: Volume of the system in litres

R: volume of replacement water in litres

feed: amount of feed consumed by the fish (presented feed – uneaten pellets) in mg

$CFB_{(n-1)}$: CFB concentration on the previous day

A set CFB can be achieved either through adjustment of water exchange or feed input. In this study a set water exchange rate per treatment was defined in litres per kg feed in order to achieve different CFB levels. The water exchange rate (R) per day was calculated as

$$R [L] = R_x [L] \times feed_{(n-1)} [kg]$$

R: volume of replacement water in litres

R_x : set water exchange rate per treatment

(low CFB: $1000 \text{ L kg feed}^{-1}$, medium CFB: $500 \text{ L kg feed}^{-1}$, high CFB: $200 \text{ L kg feed}^{-1}$)

$feed_{(n-1)}$: amount of feed consumed by the fish (presented feed – uneaten pellets) in kg on the previous day

This approach allows for adjustment of water exchange rates per tank based on the actual feed burden in each tank separately.

Carbon Dioxide Dosing

Carbon dioxide was added chemically in *Chapter 1*.

The nine fish tanks of the RARS were used to test three different hypercapnia regimes in triplicates while tank number 10 was used as a reference tank and therefore kept empty of fish. Food grade CO₂ was added to the medium and high hypercapnia level tanks using ceramic diffusers (MBD075, Point Four Systems Inc., Canada) while no CO₂ gas was added to three tanks to represent the low hypercapnia regime. The diffusers were added next to the inflow of the circulation pump in the tank in order to allow for adequate mixing. The CO₂ dosing was adjusted with needle valves and controlled with a low volume flow meter. Concentration of CO₂ in the tanks was measured every two hours with the custom build headspace analyser. Dosage of CO₂ was adjusted if necessary. Additional air diffusers were installed in the pump sum to increase the CO₂ stripping efficiency of the system. The CO₂ dosing was gradually increased during the two weeks acclimation period up to $\approx 19000 \mu\text{atm} / 30 \text{ mg L}^{-1}$ (high) and $\approx 9500 \mu\text{atm} / 15 \text{ mg L}^{-1}$ (medium). The lowest possible CO₂ concentration was maintained at $\approx 2600 \mu\text{atm} / 4 \text{ mg L}^{-1}$ (low).

Nitrate Dosing

Nitrate was added chemically in *Chapter 2*.

Nitrate-nitrogen concentrations were achieved by mixing sodium nitrate (NaNO₃) and potassium chloride (KCL) (Carl Roth GmbH & Co. KG, Karlsruhe, Germany) in tap water at a weight-ratio of 27:1 thus similar to the ratio found in natural seawater (Romano and Zeng, 2009, 2007). Nitrate concentrations were measured daily and adjusted if necessary. The next higher nitrate concentration was reached gradually over three days. An additional measurement of NO (lowest possible nitrate concentration) was completed after the N240 treatment in order to assess any irreversible influence of the increased nitrate concentrations. This was achieved by a complete water exchange with pre-heated tap water.

References

Clarke, A., Johnston, N.M., 1999. Scaling of metabolic rate with body mass and temperature in teleost fish. *J. Anim. Ecol.* 893–905.

- Colt, J., Lamoureux, J., Patterson, R., Rogers, G., 2006. Reporting standards for biofilter performance studies. *Aquac. Eng.* 34, 377–388. doi:10.1016/j.aquaeng.2005.09.002
- Elliott, J.M., Davison, W., 1975. Energy equivalents of oxygen consumption in animal energetics. *Oecologia* 19, 195–201. doi:10.1007/BF00345305
- European Commission, 2009. Commission regulation (EC) No 152/2009 of 27 January 2009 laying down the methods of sampling and analysis for the official control of feed. *Off. J. Eur. Union* 36, 1–130.
- Grasshoff, K., Ehrhardt, M., Kremling, K., 1983. *Methods of Seawater Analysis*. Second, Revised and Extended Edition.
- Jobling, M. (Ed.), 1994. *Fish Bioenergetics*, 1st ed. Chapman & Hall Fish & Fisheries Series 13, London.
- Lupatsch, I., Kissil, G.W., Sklan, D., 2003. Comparison of energy and protein efficiency among three fish species gilthead sea bream (*Sparus aurata*), European sea bass (*Dicentrarchus labrax*) and white grouper (*Epinephelus aeneus*): Energy expenditure for protein and lipid deposition. *Aquaculture* 225, 175–189. doi:10.1016/S0044-8486(03)00288-6
- Mortimer, C.E., Müller, U., 2003. *Chemie - Das Basiswissen der Chemie*, 8. Edition. George Thieme Verlag, Stuttgart.
- Romano, N., Zeng, C., 2009. Evaluating the newly proposed protocol of incorporated potassium in nitrate toxicity experiments at different salinities: A case study with the tiger prawn, *Penaeus monodon*, juveniles. *Aquaculture* 289, 304–309. doi:10.1016/j.aquaculture.2009.01.035
- Romano, N., Zeng, C., 2007. Effects of potassium on nitrate mediated alterations of osmoregulation in marine crabs. *Aquat. Toxicol.* 85, 202–208. doi:10.1016/j.aquatox.2007.09.004
- Stiller, K.T., Moran, D., Vanselow, K.H., Marxen, K., Wuertz, S., Schulz, C., 2013. A novel respirometer for online detection of metabolites in aquaculture research: Evaluation and first applications. *Aquac. Eng.* 55, 23–31. doi:10.1016/j.aquaeng.2013.01.004
- Wright, P., Anderson, P. (Eds.), 2001. *Nitrogen Excretion*. Academic Press, San Diego, London.
- Zeebe, R.E., Wolf-Gladrow, D.A., 2001. *CO₂ in Seawater: Equilibrium, Kinetics, Isotopes*. Elsevier.

ACKNOWLEDGEMENTS

I am grateful for all the help and support I got during my PhD and, most of all, I am very pleased that you took your valuable time and read this thesis.

Ein ganz besonderer Dank geht an Carsten Schulz. Carsten, ich danke Dir, dass Du immer ein offenes Ohr für mich hattest und ich jede Idee mit Dir diskutieren konnte. Du hast mich immer unterstützt und mir dabei geholfen, meine oft un-eindeutigen Ergebnisse zu verstehen und vor allem zu würdigen.

Stefan, vielen Dank, dass Du mich an die GMA geholt und mir als „Doktorcousin“ in jeder Lebenslage mit Rat und Tat zur Seite gestanden hast. Du hast immer an mich geglaubt und mir vieles zugetraut und dafür bin ich Dir sehr dankbar.

Jan, ich bin unglaublich froh, dass wir gemeinsam das Projekt „NutriPerc“ gestartet haben und freue mich über die großartige Freundschaft, die daraus entstanden ist.

Ingrid Lupatsch, Mario Hasler, Klaus Vanselow, Kevin, Micha, Stéphanie, Johann, Claudi und den vielen anderen mit denen ich immer wieder meine Ergebnisse diskutieren durfte gilt ein ganz besonderer Dank. Ohne Euch wäre ich wahrscheinlich noch häufiger am Energiebudget, der Respi oder der statistischen Auswertung verzweifelt. Danke, für Eure Unterstützung!

Vielen, vielen Dank an alle GMAler für Eure Freundschaft, Eure Unterstützung und die unendlich große Hilfsbereitschaft. Gemeinsam hatten wir immer viel Spaß und haben für alle Probleme eine Lösung gefunden und darüber bin ich unendlich froh. Leider reicht der Platz nicht aus um alle zu nennen aber ein ganz besonderer Dank geht an die Spielegruppe, für die vielen lustigen Stunden, die wir gemeinsam verbracht haben. Ich weiß, dass ich mich einfach immer auf Euch verlassen kann und dafür bin ich sehr dankbar.

Mama, Papa und Nina, man sagt ja, eine Familie können man sich nicht aussuchen, aber ich hätte mir genau Euch ausgesucht. Danke, für alles.

Marc, danke, dass Du mich immer dabei unterstützt besser zu werden und weiter zu kommen. Ich weiß, dass wir gemeinsam alles schaffen können und das gibt mir unglaublich viel Kraft.

Last but not least, ein Dank an alle, die mich die letzten Jahre begleitet haben. An meine gesamte Familie für die Unterstützung, an meine Freunde „Zuhause“, allen voran Laura, dass Ihr mir dir seltenen Besuche nicht übel nehmt und immer Zeit für mich findet, an die DLRG Büsum-Wesselburen für die Abwechslung die Ihr mir bietet, an alle Volleyballer und die Unterwasserhockey-Mädels für den mentalen Ausgleich und die tollen, gemeinsamen Trainingstage und Wochenenden und ganz besonders an die großartigen Kollegen meines Vaters: Ihr seid meine Helden!

CURRICULUM VITAE

Name: Kathrin Steinberg
Geburtsdatum: 1 November 1988
Geburtsort: Thedinghausen
Nationalität: Deutsch

Studium und Schulausbildung

02.2015 – 07.2018 **Promotion in der Aquakultur**
Christian-Albrechts-Universität zu Kiel

09.2011 – 09.2012 **M.Sc. Sustainable Aquaculture**
University of Stirling, Schottland

05.2012 – 07.2012 Projektarbeit im Projekt Sustaining Ethical Aquaculture
Trade (SEAT) in Khulna, Bangladesch

09.2008 – 08.2011 **B.Sc. Maritime Technologien**
Hochschule Bremerhaven

03.2011 – 07.2011 Praxissemester bei Coastal Research & Management
(CRM), Kiel

08.2001 – 06.2008 **Allgemeine Hochschulzugangsberechtigung (Abitur)**
Cato Bontjes van Beek - Gymnasium in Achim

01.2006 – 07.2006 Karamu High School, Hastings, Neuseeland

Berufliche Tätigkeit

Seit 02.2015 **Wissenschaftliche Mitarbeiterin**
Christian-Albrechts-Universität zu Kiel / Gesellschaft für
marine Aquakultur Büsum

Seit 11.2014 **Wissenschaftliche Mitarbeiterin (Minijob)**
Kompetenznetzwerk Aquakultur (KNAQ) des Landes
Schleswig-Holstein

11.2012 – 10.2014 **Junior - Beraterin**
Deutsche Gesellschaft für internationale Zusammenarbeit
(GIZ) GmbH

06.2010 – 03.2011 **Studentische Hilfskraft**
Alfred Wegener Institute für Polar- und Meeresforschung,
Bremerhaven

Stipendien

2017 DAAD Konferenzreisestipendium

2011 – 2012 Studienstiftung des deutschen Volkes

