

Diversity of Easter Island *Actinobacteria* and their secondary metabolites

Dissertation

in fulfillment of the requirements for the degree of Doctor in Natural Sciences

of the Faculty of Mathematics and Natural Sciences

at Kiel University

Submitted by

Ignacio Sottorff-Neculhueque

Kiel, 2019

PhD Committee

- Main Supervisor: **Prof. Dr. Johannes F. Imhoff, GEOMAR Helmholtz Centre for Ocean Research Kiel**
- Co-Supervisor # 1: **Prof. Dr. Ute Hentschel Humeida, GEOMAR Helmholtz Centre for Ocean Research Kiel**
- Co-Supervisor # 2: **Prof. Dr. Frank Sönnichsen, Otto Diels Institute for Organic Chemistry, University of Kiel**

Date of the oral examination: June 12th, 2019

Contents

I.	Abstract.....	i
II.	Zusammenfassung.....	iii
III.	Abstract of the publications	v
IV.	Introduction.....	1
1.	Easter Island.....	1
1.1.	Origin	1
1.2.	Main features	3
1.3.	Easter Island colonization and human population	4
1.4.	Biodiversity.....	5
1.5.	Microbiology.....	6
1.6.	Drug discovery.....	7
2.	Actinobacteria.....	10
2.1.	General features	10
2.2.	Environment and distribution.....	14
2.3.	Easter Island Actinobacteria	15
2.4.	Applications and biotechnology.....	16
3.	Microbial natural products chemistry	20
3.1.	General overview and uses	20
3.2.	Biosynthesis	21
3.3.	Polyketides.....	22
3.4.	Peptides	23
V.	Research aims	27
VI.	Results.....	29
1.	Easter Island actinobacterial diversity	29
2.	Anthraquinones from an Easter Island sea anemone and their actinobacterial origin ...	45
3.	Chemical differences of two closely related <i>Streptomyces</i>	63
VII.	Discussion.....	81
1.	Easter Island actinobacterial diversity	81
2.	Geographical distribution of Actinobacteria.....	82
3.	Marine invertebrates, Actinobacteria and secondary metabolites.....	83
4.	16S rRNA gene sequence as an indicator for chemical novelty	85

5.	Gene transference and secondary metabolites	86
VIII.	Concluding remarks	87
1.	Easter Island actinobacterial diversity	87
2.	Antitumoral anthraquinones from an Easter Island sea anemone and their actinobacterial production.....	87
3.	Secondary metabolites comparison of two phylogenetically almost identical <i>Streptomyces griseus</i> strains originating from remote locations.....	88
4.	A final remark	88
IX.	Future directions	89
X.	References of introduction and discussion.....	91
XI.	Acknowledgments.....	103
XII.	Erklärung.....	105
XIII.	Individual scientific contributions for multiple-author work.....	107
	High diversity and novelty of Actinobacteria isolated from the coastal zone of the geographical remote young volcanic Easter Island, Chile.	107
	Antitumor anthraquinones from an Easter Island sea anemone: animal or bacterial origin?	107
	Different secondary metabolite profiles of phylogenetically almost identical <i>Streptomyces</i> <i>griseus</i> strains originating from geographically remote locations.	108
XIV.	Curriculum Vitae	109
XV.	Appendix.....	111
	Supplementary information of publication 1	111
	Supplementary information of publication 2	115
	Supplementary information of publication 3	141

List of figures and tables of introduction and discussion

Figure 1 World map showing the geographical location of Easter Island, Chile (red diamond).....	2
Figure 2 Easter Island formation process. A) Location and distribution of the shield-volcanoes Rano Kau, Terevaka and Poike in the Pacific Ocean. B) Phase one in the island formation, buildup. C) Phase two in the island formation, lateral expansion, convergence and rise. Extracted from Vezzoli et al. (2009).....	2
Figure 3 Geomorphology of Easter Island. In each corner, the extinct volcanoes are signaled as following: A) Rano Kau, B) Terevaka, and C) Poike. Figure extracted from Casanova et al. (2013).	3
Figure 4 Easter Island geographical features. 1) Anakena beach, one of two sandy coastal zone at the island 2) North coast of the island 3) South coast of the island 4) Intertidal zone at west coast of the island 5) Volcanic-derived rocky ponds 6) Intertidal zone at the east coast of the island 7) Inland flatlands at the island 8) Crater of the inactive volcano Rano Kau 9) Panoramic view of the North coast of the island, and its erosion.	4
Figure 5 Global distribution of the actinobacterial genus, <i>Salinispora</i> . Figure extracted from Jensen et al. (2015).....	8
Figure 6 To date officially accepted actinobacterial orders. The phylogenetic construction was made through the analysis of the 16S rRNA gene sequence. Figure extracted from Ludwig et al. (2012).....	11
Figure 7 Genome-based phylogenetic tree for the phylum Actinobacteria. Constructed with 97 genomes sequences. Figure extracted from Barka et al. (2016).	13
Figure 8 Actinobacterial diversity of marine sponge offshore Easter Island. Figure extracted and modified from Cumsille et al. (2017). No sediment diversity was reported.....	15
Figure 9 Fungal tolerance of rice treated with <i>Streptomyces</i> broth culture. Extracted from Araujo et al. (2017).	17
Figure 10 Biosynthetic chemical diversity of Actinobacteria. PK: polyketide, NRP: non-ribosomal peptide, RiP: ribosomal peptide, PK-NRP: hybrid of polyketide-non-ribosomal peptide.....	21
Figure 11 Types of polyketide synthases. A: Type I, B: Type II, C: Type III. Extracted from Weissman et al. (2009).	23
Figure 12 Basic non-ribosomal peptide biosynthesis mechanism. adenylation domain (A), thiolation domain (T), condensation domain (C). **Thioesterase domain (TE) not shown in the figure. Extracted from Watanabe et al. (2009).....	24

Figure 13 Biosynthesis of ribosomal peptides. Extracted and modified from Ortega et al. (2016).
..... 25

Figure 14 Connection map of Easter Island actinobacterial isolates and their closest relatives
worldwide. Closeness determined in base of the 16S rRNA gene sequence. Yellow diamond: Origin
(Easter Island). White circle: Closest actinobacterial relative. 83

I. Abstract

Easter Island is a geographically isolated location in the South Pacific Ocean, which has remained unstudied in microbiological terms. Actinobacteria are Gram-positive bacteria which are widely recognized by producing chemicals with medical applications and having a wide environmental distribution. Marine actinobacterial representatives have shown large potential for the production of biological active chemicals. Therefore, this study focuses in the isolation and characterization of the culturable actinobacterial diversity dwelling in the coastal zone of Easter Island, as well as in the chemical analysis of the secondary metabolites produced by actinobacterial representatives. To develop this project, we used a wide variety of culture media which had different nutritive conditions in order to broaden the diversity of cultured Actinobacteria. The identification and classification of the isolates was developed on the basis 16S rRNA genetic marker. For the evaluation of the chemical profiles, as well as the purification and identification of pure molecules we used techniques of analytic chemistry like chromatography, mass spectroscopy and nuclear magnetic resonance. Our results indicated that Easter Island had a large Actinobacteria diversity, since we obtained a total of 163 pure cultures, which represented 72 phylotypes distributed in 20 different genera. Phylogenetic evaluation suggested a high degree of novelty showing that 45% of the isolates may represent new taxa. The chemical evaluation of an Easter Island sea anemone and its actinobacterial symbionts showed the presence of two known antitumoral anthraquinones. Chemical experiments showed that the real producer of the anthraquinones was a previously unidentified actinobacterial strain, and not the sea anemone. In addition, the study of two *Streptomyces* strains, which were geographically distant, but phylogenetically almost identical, indicated that they had different morphological and chemical features which were strain specific. Finally, our study showed that Easter Island was a rich source of new actinobacterial taxa, as well as of known representatives. The chemically studied Actinobacterial representatives showed interesting potential for the production of antitumoral and antibiotic chemicals and the secondary metabolite comparison of phylogenetical identical, but geographical distant, Actinobacteria clarified that 16S rRNA is not a suitable genetic marker to determine chemical novelty potential.

II. Zusammenfassung

Die Osterinsel ist ein geographisch isolierter Ort im Südpazifik, der mikrobiologisch noch nicht untersucht wurde. Aktinobakterien sind Gram-positive Bakterien, von denen allgemein bekannt ist, dass sie weit verbreitet sind und zahlreiche Substanzen produzieren, die für medizinische Anwendungen interessant sind. Vertreter mariner Aktinobakterien haben ein großes Potenzial zur Produktion biologisch aktiver Substanzen gezeigt. Daher konzentriert sich diese Studie auf die Isolierung und Charakterisierung der kultivierten aktinobakteriellen Vielfalt, die sich in der Küstenzone der Osterinsel aufhält, sowie auf die chemische Analyse der sekundären Metaboliten, die von aktinobakteriellen Vertretern produziert werden. Zur Entwicklung dieses Projekts verwendeten wir eine Vielzahl von Nährböden mit unterschiedlichen Kulturbedingungen, um die Vielfalt an kultivierten Aktinobakterien zu erhöhen. Die Identifizierung und Klassifizierung der Isolate wurde auf der Grundlage des 16S rRNA-Genmarkers entwickelt. Für die Auswertung der chemischen Profile sowie die Reinigung und Identifizierung reiner Moleküle wurden Techniken der analytischen Chemie wie Chromatographie, Massenspektroskopie und Kernspinresonanz eingesetzt. Unsere Ergebnisse zeigten, dass die Osterinsel eine große Vielfalt an Aktinobakterien besitzt: die insgesamt 163 erhaltenen Reinkulturen verteilten sich auf 72 Phylotypen und 20 verschiedene Gattungen. Die phylogenetische Auswertung ergab einen hohen Grad an Neuheit. Sie zeigte, dass 45% der Isolate neue Taxa darstellen können. Die chemische Bewertung einer Seeanemone der Osterinsel und ihrer aktinobakteriellen Symbionten ergab das Vorhandensein von zwei bekannten antitumoralen Anthrachinonen. Chemische Experimente zeigten, dass der eigentliche Produzent der Anthrachinone ein Aktinobakterium war und nicht die Seeanemone. Darüber hinaus zeigte die Untersuchung von zwei *Streptomyces*-Stämmen, die aus geographisch entfernten Regionen stammten, aber phylogenetisch fast identisch waren, dass sie unterschiedliche, stammspezifische morphologische und chemische Merkmale hatten. Schließlich zeigte die vorliegende Studie, dass die Osterinsel eine reiche Quelle für neue aktinobakterielle Taxa und bekannte Vertreter war. Die chemisch untersuchten Aktinobakterien-Vertreter zeigten ein interessantes Potenzial für die Produktion von antitumoralen und antibiotischen Substanzen. Der Vergleich der Sekundärmetabolite dieser phylogenetisch nahezu identischen, aber aus geographisch weit entfernten Standorten isolierten Aktinobakterien verdeutlichte, dass 16S rRNA kein geeigneter genetischer Marker ist, um das Potenzial für chemische Neuerungen zu bestimmen.

III. Abstract of the publications

High diversity and novelty of *Actinobacteria* isolated from the coastal zone of the geographical remote young volcanic Easter Island, Chile.

Ignacio Sottorff, Jutta Wiese, and Johannes F. Imhoff:

International Microbiology, 2019

<https://doi.org/10.1007/s10123-019-00061-9>

Abstract

Easter Island is an isolated volcanic island in the Pacific Ocean. Despite the extended knowledge about its origin, flora, and fauna, little is known about the bacterial diversity inhabiting this territory. Due to its isolation, Easter Island can be considered as a suitable place to evaluate microbial diversity in a geographically isolated context, what could shed light on actinobacterial occurrence, distribution, and potential novelty. In the present study, we performed a comprehensive analysis of marine *Actinobacteria* diversity of Easter Island by studying a large number of coastal sampling sites, which were inoculated into a broad spectrum of different culture media, where most important variations in composition included carbon and nitrogen substrates, in addition to salinity. The isolates were characterized on the basis of 16S ribosomal RNA gene sequencing and phylogenetic analysis. High actinobacterial diversity was recovered with a total of 163 pure cultures of *Actinobacteria* representing 72 phylotypes and 20 genera, which were unevenly distributed in different locations of the island and sample sources. The phylogenetic evaluation indicated a high degree of novelty showing that 45% of the isolates might represent new taxa. The most abundant genera in the different samples were *Micromonospora*, *Streptomyces*, *Salinispora*, and *Dietzia*. Two aspects appear of primary importance in regard to the high degree of novelty and diversity of *Actinobacteria* found. First, the application of various culture media significantly increased the number of species and genera obtained. Second, the geographical isolation is considered to be of importance regarding the actinobacterial novelty found.

Antitumor anthraquinones from an Easter Island sea anemone: animal or bacterial origin?

Ignacio Sottorff, Sven Künzel, Jutta Wiese, Matthias Lipfert, Nils Preußke, Frank Sönnichsen, and Johannes F. Imhoff:

Marine Drugs, 2019

<https://doi.org/10.3390/md17030154>

Abstract

The presence of the anthraquinones, Lupinacidin A and Galvaquinone B which have antitumoral activities, has been identified in the sea anemone (*Gyactis sesere*) from Easter Island. So far these anthraquinones have been characterized from terrestrial and marine *Actinobacteria* only. In order to identify the anthraquinones producer, we isolated *Actinobacteria* associated with the sea anemone and obtained representatives of seven actinobacterial genera. Studies of cultures of these bacteria by HPLC, NMR, HRLCMS analyses showed that the producer of Lupinacidin A and Galvaquinone B indeed was one of the isolated *Actinobacteria*. The producer, strain, SN26_14.1, was identified as a representative of the genus *Verrucosispora*. Genome analysis supported the biosynthetic potential to the production of these compounds by this strain. This study adds *Verrucosispora* as a new genus to the anthraquinone producers, in addition to well-known species of *Streptomyces* and *Micromonospora*. By a cultivation-based approach, the responsibility of symbionts of a marine invertebrate for the production of complex natural products found within the animal's extracts could be demonstrated. This finding re-opens the debate about the producers of secondary metabolites in sea animals. Finally, it provides valuable information about the chemistry of bacteria harbored in the geographically-isolated and almost unstudied, Easter Island.

Different secondary metabolite profiles of phylogenetically almost identical *Streptomyces griseus* strains originating from geographically remote locations

Ignacio Sottorff, Jutta Wiese, Matthias Lipfert, Nils Preußke, Frank Sönnichsen and Johannes F. Imhoff:

Microorganisms, 2019

<https://doi.org/10.3390/microorganisms7060166>

Abstract

As *Streptomyces* have shown outstanding capacity for drug production, different campaigns in geographical-distant locations are currently aiming at isolating new antibiotic producers. However, many of this newly isolated *Streptomyces* strains are classified as identical to already described species. Nevertheless, as discrepancies in terms of secondary metabolites and morphology are possible, we compared two *Streptomyces* strains with identical 16S rRNA gene sequences, but geographical distant origin. Chosen were an Easter Island *Streptomyces* isolate (*Streptomyces* sp. SN25_8.1) and the next related type strain, which is *Streptomyces griseus* subsp. *griseus* DSM 40236^T isolated from Russian garden soil. Compared traits included phylogenetic relatedness based on 16S rRNA gene sequences, macro and microscopic morphology, antibiotic activity and secondary metabolite profiles. Both *Streptomyces* strains shared several common features, such as morphology and core secondary metabolite production. They revealed differences in pigmentation and in the production of accessory secondary metabolites which appear to be strain-specific. In conclusion, despite identical 16S rRNA classification *Streptomyces* strains can present different secondary metabolite profiles and may well be valuable for consideration in processes for drug discovery.

IV. Introduction

1. Easter Island

1.1. Origin

Easter Island or Rapa Nui (Polynesian name) is an isolated Chilean insular territory with an area of 163.6 km² (Casanova et al. 2013), it is located in the southern Pacific Ocean, specifically 3,515 km from continental Chile, and 9,430 km to the nearest part of Australia (**Figure 1**). Easter Island is classified as an intraoceanic volcanic island, since it is the product of the eruption and buildup of oceanic volcanoes (Vezzoli et al. 2009). Commonly, oceanic volcanoes are placed in the boundaries of tectonic plates where magma plumes flow out, accordingly, Easter Island is located in the intersection between the Nazca and Pacific plates (Vezzoli et al. 2009).

The formation and rise of Easter Island occurred as a result of submarine volcanic activity (Casanova et al. 2013), by the eruption and buildup of three different and neighboring shield-volcanoes; Rano Kau, Terevaka and Poike. The buildup and convergence of the shield-volcanoes occurred in two different phases: Phase one, buildup of the magmatic material from an eruptive fissure in the tectonic plate, which ended up in the formation of summit calderas, which continued releasing and accumulating magmatic material. This first phase took place 0.78–0.3 Ma ago (Casanova et al. 2013). Phase two, constituted the continue accumulation of volcanic material through fissure eruptions which provoked the convergence and rise of the three shield-volcanoes as one joined mass land. This process took place 0.24–0.11 Ma ago (Casanova et al. 2013, Vezzoli et al. 2009). A schematic representation of the formation process is presented in **Figure 2**.

Currently, the forming volcanoes, Rano Kau, Terevaka and Poike, are thought to be extinct, since no major volcanic activity has been recorded in the last centuries (Routledge et al. 1917), although stream cracks were reported in the Rano Kau volcano crater during the first quarter of the twenty century (University of Hawaii et al. 2019).

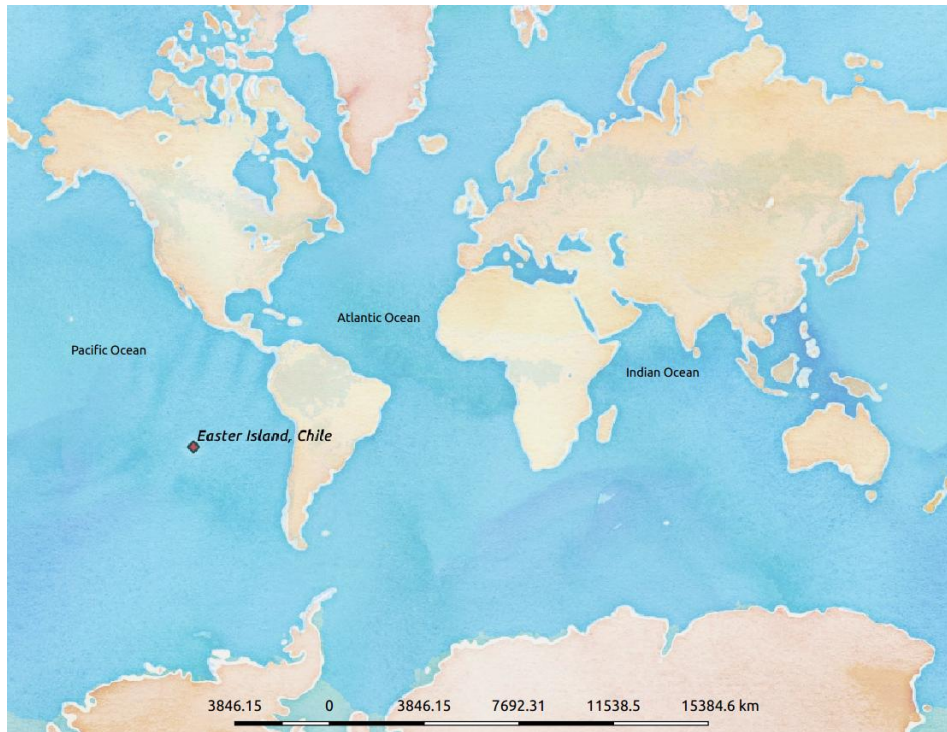

Figure 1 World map showing the geographical location of Easter Island, Chile (red diamond).

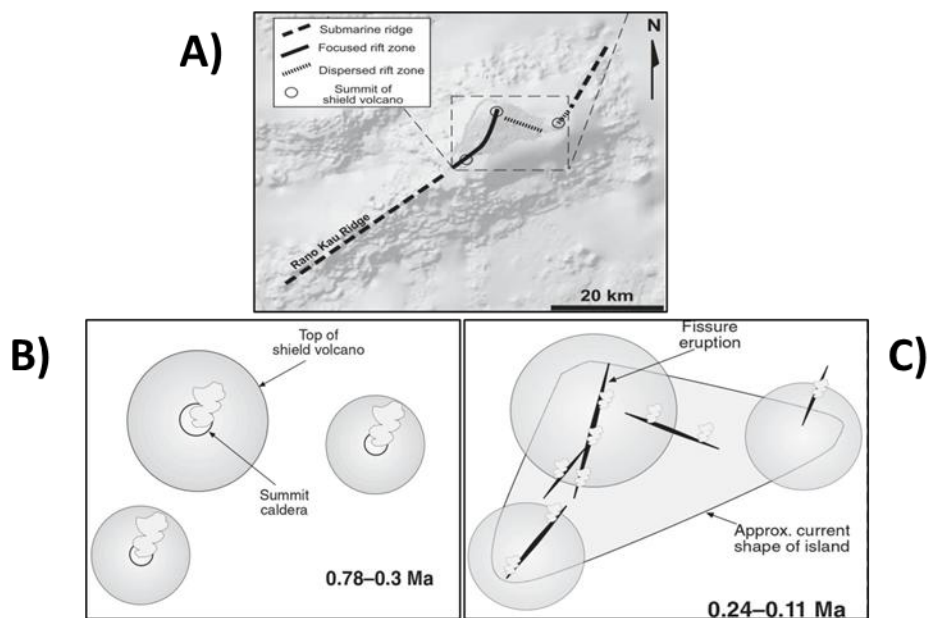

Figure 2 Easter Island formation process. A) Location and distribution of the shield-volcanoes Rano Kau, Terevaka and Poike in the Pacific Ocean. B) Phase one in the island formation, buildup. C) Phase two in the island formation, lateral expansion, convergence and rise. Extracted from Vezzoli et al. (2009).

1.2. Main features

Easter Island has a maximum ground elevation of 560 m a.s.l. The highest points in the island are characterized by extinct volcanoes, such as Poike, Rano Kau, and Terevaka, which are located in each corner of the island (Casanova et al. 2013), see **Figure 3**. The soil of the island is structured by volcanic rocks, clay soils, and lava outcrops (Casanova et al. 2013). The coastal zone of the island is formed by abundant volcanic rocks, though the Anakena-Ovahe zone differs by presenting a sandy beachfront. Some of the most common features of the island are presented in **Figure 4**.

Easter Island has a southern subtropical weather, having summer season during December to March and winter season during June to September. The range of temperatures spans from a minimal of 10°C during the winter, while the maximum temperature is of 30°C during the summer (Azizi et al. 2008). The climate at Easter Island has been reported as mostly moist, with humidity values of 70-88%. The registered annual rainfall for 2018 was 936.4 mm. The highest levels of monthly precipitation were registered in May and September for 2018 (Meteochile et al. 2019).

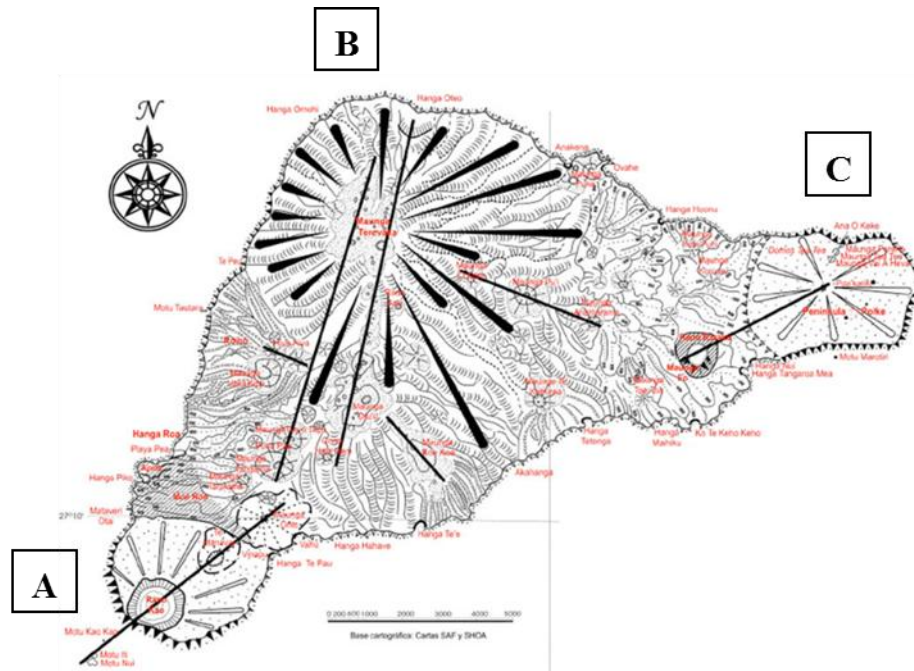

Figure 3 Geomorphology of Easter Island. In each corner, the extinct volcanoes are signaled as following: A) Rano Kau, B) Terevaka, and C) Poike. Figure extracted from Casanova et al. (2013).



Figure 4 Easter Island geographical features. 1) Anakena beach, one of two sandy coastal zone at the island 2) North coast of the island 3) South coast of the island 4) Intertidal zone at west coast of the island 5) Volcanic-derived rocky ponds 6) Intertidal zone at the east coast of the island 7) Inland flatlands at the island 8) Crater of the inactive volcano Rano Kau 9) Panoramic view of the North coast of the island, and its erosion.

1.3. Easter Island colonization and human population

The island colonization occurred by different events of dispersion through time, in which different macro and microorganisms reached this territory by physical and biological mechanisms. An example is the Chilean palm, *Jubaea chilensis*, which is endemic from continental Chile, but it has also been reported on Easter Island. It has been suggested that its arrival to Easter Island occurred by accidental drift by marine currents (Grau et al. 1996). A similar case has been proposed for the sweet potato, *Ipomoea batatas*, and its arrival to Easter Island and Polynesia, since this tuber has its origin in Central and South America (Montenegro et al. 2008).

Animal and human arrivals have been documented on Easter Island. The first human settlement has been estimated to be 1200 years A.D. (Hunt and Lipo 2006), and initiated as a

progressive spread of Polynesians from Samoa towards the East, ending up in Easter Island (Wilmshurst et al. 2011). During colonization, Polynesians relied their subsistence upon the consumption of small animals and plants, like the pacific rat (Barnes et al. 2006), the Polynesian chicken (Fitzpatrick and Callaghan 2009), and the sweet potato (Polet and Bocherens 2016) which were carried to the new destinations. After the first settlement, several European visits were documented starting in 1722 (Fischer, 2005), but the most critical episode for the people of Rapa Nui occurred in 1862 when islanders that had been taken as slaves to Peru, were returned to Easter Island after having contracted diseases (tuberculosis, smallpox, dysentery), severally decimating the population (Fischer 2005).

1.4. Biodiversity

The biodiversity of Easter Island has only been studied partially because its geographical isolation has complicated the explorations. Despite logistic issues, progress has been made in the study of the Easter Island flora and fauna. To date, the study of the Easter Island flora has reported a total of 48 species of which 11 are endemic (Dubois et al. 2013). Most of the species studied have been associated to grasses, which can be related to the fact that nearly 90 % of the island is covered by grasslands (Finot et. al 2015). Trees at Easter Island are limited to few patches, where coconut and Chilean palms, in addition of bananas and eucalyptus trees are the most abundant (Mann et al. 2008).

Studies on Easter Island fauna have faced the same logistic considerations, but advancement has been made during the last thirty years. Easter Island fauna has been described as a combined biodiversity, with origins in South America and Asia-Pacific territories, as well as having an endemic population (Escalante and Arancibia 2016). To date, marine organisms have been by far the most studied subject. The most common organisms found are marine sponges (DiSalvo et al. 1988), cnidarian (DiSalvo et al. 1988; Glynn et al. 2007), crustaceans (DiSalvo et al. 1988; Retamal 2004), mollusks (DiSalvo et al. 1988; Osorio and Cantuarias 1989; Rehder 1980), polychaetes (DiSalvo et al. 1988; Kohn and Lloyd 1973), echinoderms (DiSalvo et al. 1988; Massin 1996), fishes (Randall and Cea 2011) and bryozoan (Moyano 2001). The knowledge of the biodiversity of the island is still growing with new species being periodically reported (Ng and Boyko 2016), however to date there is not a total estimation of the fauna of Easter Island.

Contrasting with the studies in flora and fauna, only few studies have dealt with Easter Island's microbiological diversity (Cumsille et al. 2017; Miller et al. 2014; Vezina et al. 1975), despite the remarkable endemism rate found in other biological domains.

1.5. Microbiology

Ultimately, microbial importance has been unveiled due to the comprehension that microbes play a key role in their habitats and hosts. For instance, the human microbiome has been studied to determine the influence of microbes in human health. These studies have concluded that the microbiome of healthy individuals differs of that of sick ones (Huttenhower et al. 2012). Additionally, it has been shown that a stable microbiome is essential to keep individuals healthy (Huttenhower et al. 2012). Similar conclusions have been made for other organisms, such as fishes and cattle (Merrifield et al. 2014, Stewart et al. 2018). Plants are another example of beneficial interaction with microbes, since the close relationship between the root system of plants and nitrogen fixer microbes has been demonstrated to be a beneficial symbiotic relation (Mus et al. 2016).

Microbiologically, Easter Island is an interesting place to investigate due to its geographical isolation and conservation state. Easter Island can be a study case of how different the bacterial populations are in zones with little or no anthropogenic impact. Furthermore, the study of the microbes on this territory would further support a better understanding of the biogeography of microorganisms by comparing its population to other distant locations. Additionally, biogeographic information would provide more means to evaluate the hypothesis of Beijerinck: "Microbial ubiquity and environmental determinism" and Baas Becking: "Everything is everywhere, but the environment selects" (Becking et al. 1934; O'Malley et al. 2008). Finally, it is of importance to generate microbiological data from Easter Island in order to compare it with studies on the microbial diversity of Hawaii, to assess if two distant locations with similar origin (interoceanic volcanic) may harbor related microbial diversity.

1.6. Drug discovery

Currently, the increasing number of reports of multi drug resistant pathogens (Lockhart et al. 2016) has triggered the search of new molecules which can be effective in the treatment of these emerging pathogens. Furthermore, it has also been observed that tumoral cells can develop tolerance and resistance against anticancer drugs (Chisholm et al. 2015), worsening the possibilities of disease recovery. To date, there are different strategies of drug discovery, which vary in effectivity, costs and feasibility. They can mainly be classified as following: chemical based, genome based, computer based and microbiology based.

Chemical based drug discovery strategy is developed with synthetic chemistry, mainly through structure activity relationship (SAR). These studies are developed by adding, exchanging or modifying chemical groups in an already characterized chemical entities (Koehn et al. 2005). The aim of this strategy is to increase the biological activity of a chemical on a particular target or the manufacture of novel biological activity in previously not active targets (Koehn et al. 2005). Despite the great utility of this strategy, it is limited to a defined chemical scaffold and the complexity of its synthetic modification. A genome based study may be explained as the the analysis of the genetic information of a given organism to survey secondary metabolites biosynthetic genes (Kersten et al. 2011). Recently, this strategy has been enormously advanced due to the lower cost of genome sequencing and the development of platforms that score secondary metabolites gene similarity (Weber et al. 2015), enzyme identity and chemical novelty. Despite how this analysis is quite insightful in terms of information, it also faces limitations because it targets only known secondary metabolites genes, ignoring genes with unknown function but great potential. A computer-aided drug discovery approach is the computational modelling of molecules for a given target which is mainly essential proteins. Computational modeling is developed in order to build molecules which can satisfy the required chemical interactions to fit into a drug-target docking site (Kapetanovic et al. 2008). This strategy overlaps with SAR studies, but it is majorly developed *in silico* only. The main limitation of this approach is the amount of time and computer-human resource it consumes.

A microbiology based approach aims the search of microorganisms with pharmaceutical potential. The determination of the biological activity is made through the individual growth of microbial strains, their chemical extraction and subsequent biological activity testing with the desired target. This strategy requires the isolation of the bacterial strains and has been the most used approach during the last 50 years (Demain and Sanchez, 2009). The main limitation of this

approach is drug re-discovery, but this issue can be reduced through an exhaustive process of dereplication, which intends the preliminary characterization of the molecules produced by the microbial strains as early as possible in the process of discovery. Dereplication allows discerning, in an early stage, if the purification, isolation and structure elucidation of a molecule has potential for novelty.

Because the extensive exploration of continental locations and occurrences of drug re-discovery, it was proposed that unstudied environments can harbor novel microorganisms that can potentially produce unknown chemicals (Dhakal et al. 2017). Therefore, diverse investigations were made to test this hypothesis. One successful example of the exploration of unstudied environments was the ocean. To date, the exploration of marine sediments and invertebrates has produced a relevant number of novel bacteria and chemicals (Bull et al. 2007). Even, a new bacterial phylum (Fieseler et al. 2004) and genus (Jensen et al. 2015) have been documented coming from the ocean. For example, the discovery of the actinobacterial genus *Salinispora*, obtained exclusively from marine sediments was achieved as a result of the exploration of new environments. Thus far, this genus has produced three novel species, *S. arenicola*, *S. tropica* and *S. pacifica* (Jensen et al. 2015), which have shown to be distributed only in the ocean, as **Figure 5** describes. This same actinobacterial genus has yielded a quite important number of new and known chemicals (**Figure 6**), which confirms the high potential of unexplored sources, in this case the ocean, to provide novel microorganisms and chemicals.

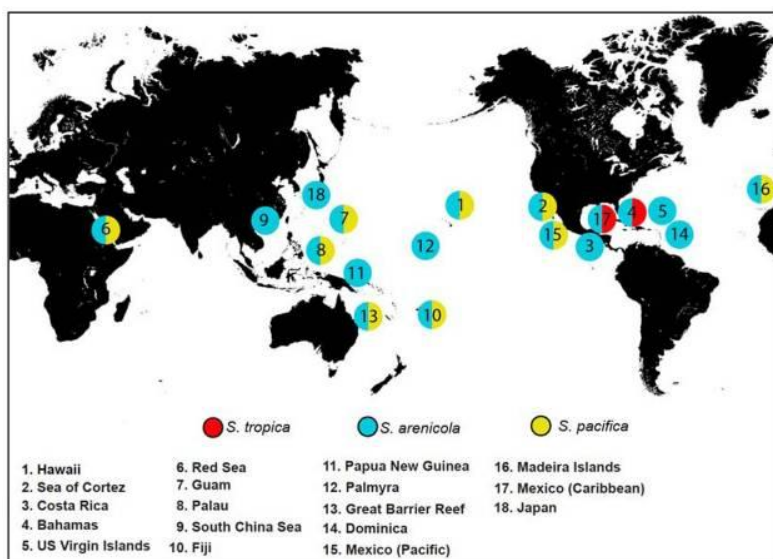

Figure 5 Global distribution of the actinobacterial genus, *Salinispora*. Figure extracted from Jensen et al. (2015).

Table 1 Chemical diversity obtained from the novel actinobacterial genus, *Salinispora*. Figure extracted from Jensen et al. (2015).

No.	Species ^a	Compound	Biosynthetic origin	Novelty	Activity (target)
1	<i>S. tropica</i>	salinosporamide A	PKS-NRPS	new	proteasome
2	<i>S. tropica</i>	sporolide A	ePKS	new	reverse transcriptase ^d
3	<i>S. tropica</i>	salinilactam	type I PKS	new	ND
4	<i>S. tropica</i>	sioxanthin	terpene	new	ND
5	<i>S. tropica</i>	antiprotealide	PKS-NRPS	new	proteasome
6	<i>S. pacifica</i>	pacificanone A	type I PKS	new	ND
7	<i>S. pacifica</i>	salinipyronone A	type I PKS	new	ND
8	<i>S. pacifica</i>	cyanosporoside A	PKSe	new	ND
9	<i>S. pacifica</i>	lomaiviticin A	type II PKS	new	cytotoxic (DNA)
10	<i>S. pacifica</i>	enterocin	type II PKS	known	antibiotic
11	<i>S. arenicola</i>	saliniketol A ^b	type I PKS	new	ornithine decarboxylase
12	<i>S. arenicola</i>	arenicolide A	type I PKS	new	ND
13	<i>S. arenicola</i>	saliniquinone	type II PKS	new	cytotoxic
14	<i>S. arenicola</i>	cyclomarin A	NRPS	known	anti-inflammatory
15	<i>S. arenicola</i>	cyclomarazine ^c	NRPS	new	ND
16	<i>S. arenicola</i>	arenimycin	NRPS	new	antibiotic
17	<i>S. arenicola</i>	arenamide A	type II PKS	new	anti-inflammatory (NFκB)
18	<i>S. arenicola</i>	staurosporines	alkaloid	known	protein kinase
19	<i>S. arenicola</i>	isopimara-8,15-dien-19-ol	terpene	new	ND
20	<i>S. arenicola</i>	rifamycin B	type I PKS	known	RNA polymerase
21	<i>S. arenicola</i>	mevinolin	PKS	known	HMG-CoA reductase
22	<i>St, Sa, and Sp</i>	desferioxamine B	NRPS	known	iron chelator
23	<i>St, Sa, and Sp</i>	lymphostin	NRPS-PKS	known	immunosuppressant

^aOriginal report of compound detection from *Salinispora* spp.

^bRifamycin synthase intermediate.

^cCyclomarin synthetase intermediate.

^dPredicted,

e = enediyne, ND = not determined.

In addition to *Salinispora*, other actinobacterial genera such as; *Streptomyces*, *Micromonospora*, *Nonomuraea* and *Verrucosipora* are commonly found in sea sediments. Only this reduced group of Actinobacteria has produced a wide variety of molecules with different biological activities like antibiotic (Socio et al. 2003), antifungal (Nair et al. 1992), and antitumoral activities (Jensen et al. 2015). The common feature of *Salinispora*, *Streptomyces*, *Micromonospora*, *Nonomuraea* and *Verrucosipora* genera is that all belong to the Actinobacteria phylum. This phylum has shown to be outstanding in the production metabolites (Hopwood, 2007; Waksman, 1967; Goodfellow & Fiedler, 2010). For instance, today most of the commonly used antibiotics have been isolated from Actinobacteria (Sun et al. 2018), demonstrating large potential for drug discovery and medical application. In addition, Actinobacteria have also shown capabilities to produce antitumoral (Fenical et al. 2009), anti-inflammatory (Braña et al. 2015) and immune-suppression molecules (Manuelli et al. 2010), presenting great relevance for human health safety.

2. Actinobacteria

2.1. General features

Actinobacteria are Gram-positive bacteria with a wide range of morphological properties, from unicellular spherical to filamentous multicellular structures known as hyphae (Trujillo 2016). Actinobacteria were first described in the nineteenth century and were named as “the ray fungi” due to their similarities to fungal hyphae (Krasil’nikov, 1938; Stackebrandt and Schumann, 2006). For instance, the actinobacterial genus, *Streptomyces*, has been well characterized by producing abundant aerial hyphae structures and spores (Gray et al. 1990), meanwhile other Actinobacteria genera do not necessarily produce hyphae, like the genus *Arthrobacter*, which has shown coccoid morphology (Jones and Keddie 2006). The phylum is composed of six different classes, *Rubrobacteria*, *Thermoleophilia*, *Coriobacteriia*, *Acidimicrobiia*, *Nitriliruptoria*, and *Actinobacteria* (Ludwig et al. 2012). Within these actinobacterial classes, 18 different orders can be found, see **Figure 6**. Currently, a total of 222 genera have been described.

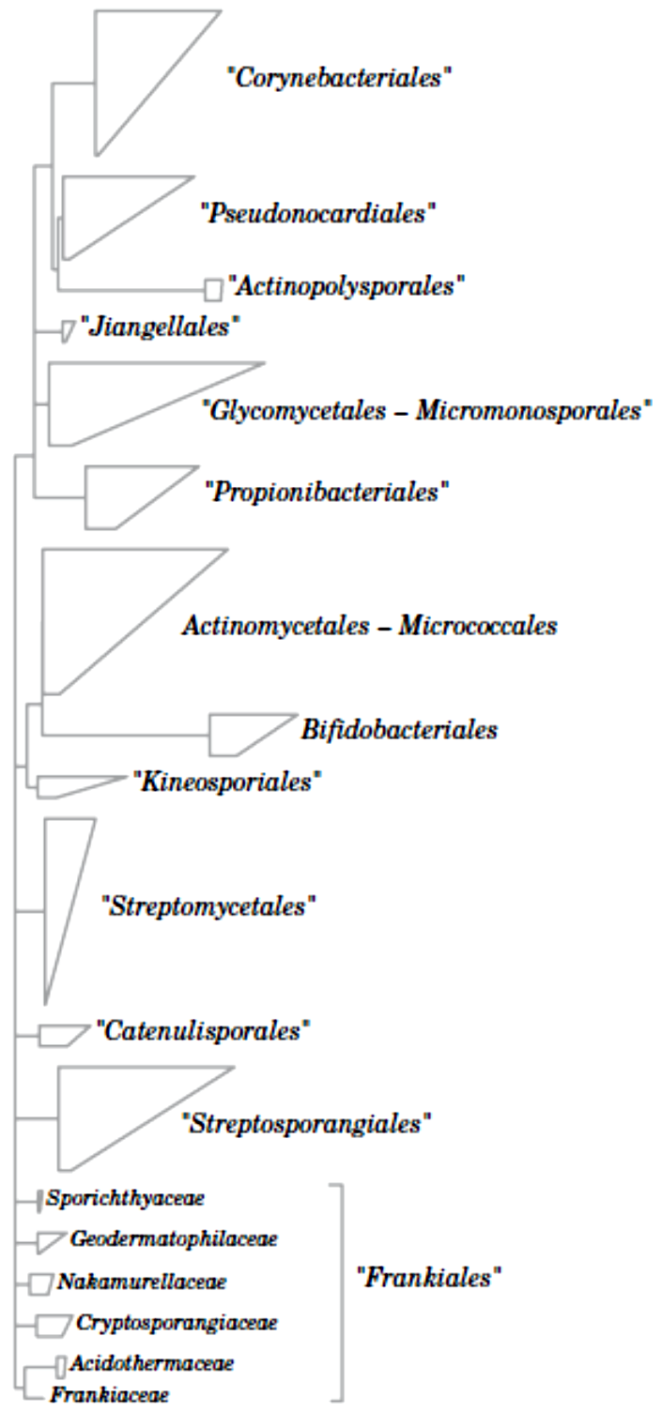

Figure 6 To date officially accepted actinobacterial orders. The phylogenetic construction was made through the analysis of the 16S rRNA gene sequence. Figure extracted from Ludwig et al. (2012).

The Actinobacteria represent one of the most diverse bacterial phylum (Ludwig et al. 2012). Actinobacteria are mostly classified based on the 16S rRNA gene sequence, which has demonstrated to be a reliable phylogenetic marker due to its high degree of conservation, its coherency and evaluation rapidness. However, nowadays in the genomic era, a higher rate of studies is establishing their research on genome-based phylogeny (Barka et al. 2016). The advantage of this new classification system lies in the larger number of genetic markers in use, which have a direct effect in the resolution of the phylogenetic trees constructed, delivering a more elegant and sensitive taxonomic classification. An example of genome-based phylogenetic classification is shown in **Figure 7**.

Another main feature of Actinobacteria is the high GC-content found in their genomes, which can range from 51% to $\geq 70\%$ (Ventura et al. 2007). The Actinobacteria genome size is also diverse, finding genomes as small as 0.75 Mb in *Acidimicrobium* strain UBA1281 (NCBI # PRJNA348753) to large genomes, like in the case of the *Streptomyces* genus, which can be larger than 7 Mb (Jiao et al. 2018). Remarkably, the genomes size in Actinobacteria varies strongly. Pathogenic Actinobacteria have shown to have reduced genomes size, in comparison with environmental species. It has been proposed that bacterial genome size and gene content are directly dictated by environmental pressures (Ventura et al. 2007). For instance, since pathogenic species need a host to survive, they do not need to keep all the metabolic pathways to survive, and may reduce their genome by releasing certain genes with non-essential biochemical pathways which can be replaced by host metabolic products (He et al. 2015). In contrast, environmental non-pathogenic Actinobacteria, which dwell in a nutritive variable niche, need to keep as much genes as possible, in order to have metabolic flexibility and assure survival, or in other words, use what is available. *Streptomyces* have a large genome size strategy by keeping a large number of genes related to various metabolic pathways in order multiple their survival options (Barbe et al. 2011).

Actinobacteria have provided immense benefits for human health, however there are also pathogenic actinobacterial representatives, such as *Mycobacterium tuberculosis*, responsible of tuberculosis, which has caused millions of deaths (Cole et al. 1998). Another pathogenic Actinobacteria is *Tropheryma whipplei* (Raoult et al. 2003), which is the cause of the Whipple's disease. This disease attacks mainly the digestive system and produces the malabsorption of nutrients, generating a wide range of symptoms, like arthritis, diarrhea, intestinal mucosa bleeding, abdominal pain and occasionally hepatitis (Fenollar et al. 2007).

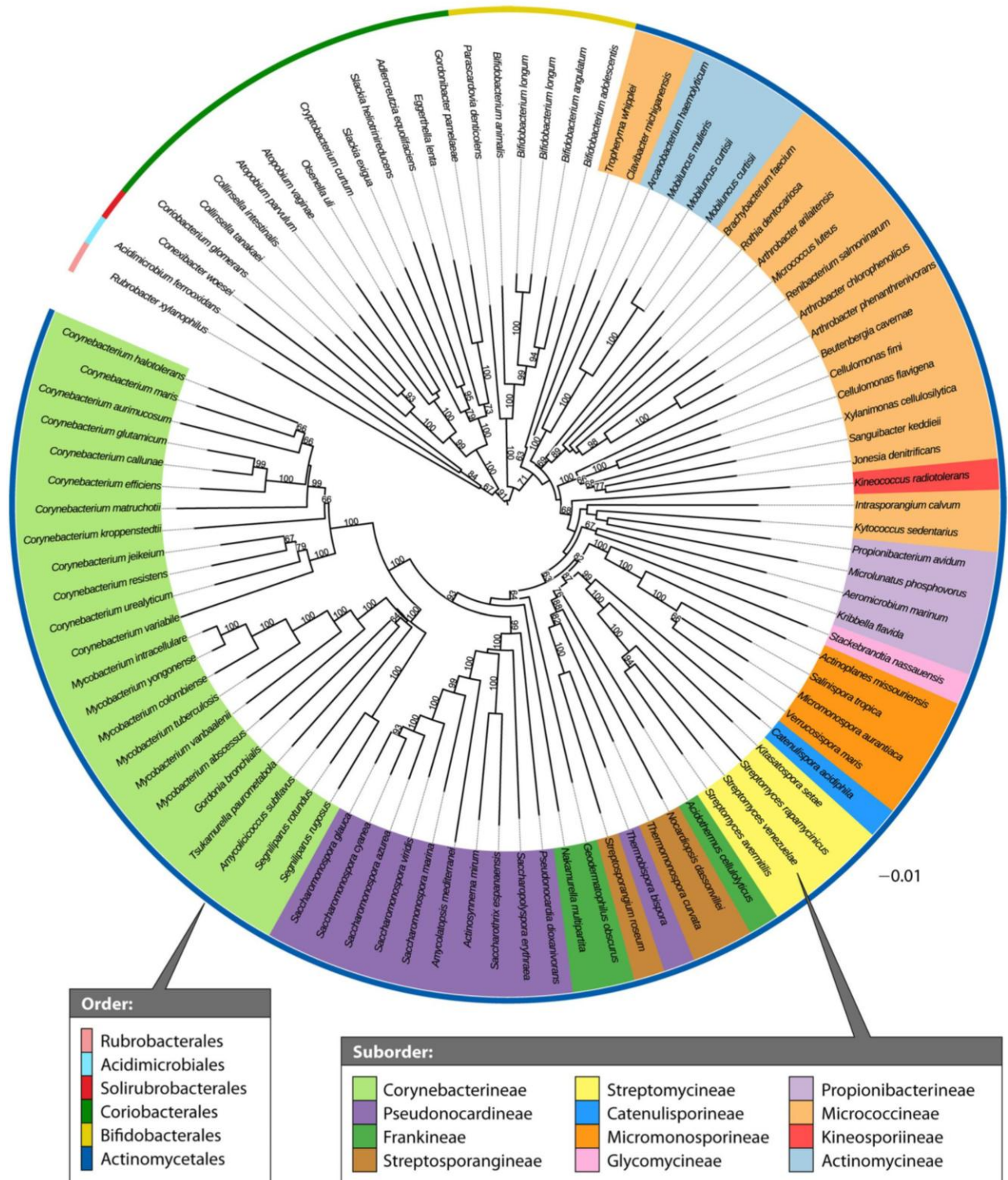

Figure 7 Genome-based phylogenetic tree for the phylum Actinobacteria. Constructed with 97 genomes sequences. Figure extracted from Barka et al. (2016).

2.2. Environment and distribution

Actinobacteria were primarily described as soil dwellers decomposing complex sugars (Waksman 1940), however they have ultimately been found in diverse habitats, such as animals (Schneemann et al. 2010a), the deep sea (Hohmann et al. 2009), volcano-derived lakes (Villalobos et al. 2018), sea sediments (Maldonado et al. 2009), plant root systems (Wang et al. 2011), and caves (Riquelme et al. 2015), among others. Actinobacteria have been isolated from quite diverse locations. For instance, many actinobacterial representatives have been isolated from the Atacama desert, Chile, which is the driest desert of the world (Neilson et al. 2012), as well as in the Antarctic territory, where the new actinobacterial genus, *Marisediminicola*, was discovered (Li et al. 2010). Consequently, Actinobacteria representatives appear to have a global distribution and ubiquitous distribution in the different ecological niches.

Additionally, Actinobacteria have been reported as symbionts in plants (Martínez-Hidalgo et al. 2014), animals (Karimi et al. 2019) and humans (Lewis et al. 2016), generating discussion about their specific function in the host organisms. A long standing example of Actinobacteria symbiosis is the interaction between *Micromonospora* and the root systems of plants. *Micromonospora* has been hypothesized to play a role in nitrogen fixation (Martínez-Hidalgo et al. 2014) and therefore is considered a key element for the plant survival. Another relevant case are marine sponges, which harbor enormous microbial diversity (Hentschel et al. 2003; Imhoff and Stöhr 2003). Actinobacteria have been shown to be an important player of the sponge microbial community (Karimi et al. 2019), however their specific function in this sea animal remains to be fully clarified, although it has been proposed that they may be involved in the sponge chemical defense mechanism (Paul et al. 2019), since sponges lack a physical defense system. Despite the understanding that Actinobacteria can be found in different environments, discussion has been going on niche specificity (Hanshew et al. 2015). In this context, of particular importance is the genus *Salinispora*, since it is said to be the first obligated marine Actinobacteria to be isolated and characterized (Maldonado et al. 2005). This discovery place the question whether or not there are niche specific Actinobacteria.

2.3. Easter Island Actinobacteria

Easter Island Actinobacteria have not been studied in depth, despite the potential they may have for pharmaceutical and industrial applications. So far, only two studies have been developed in this territory or in its surrounding. The first study developed by Vezina et al. (1975) resulted in the isolation of *Streptomyces hygroscopicus* and discovery of rapamycin, a hybrid polyketide non-ribosomal peptide that primarily was characterized as an antifungal agent. Nowadays, rapamycin (also known as Rapamune®) is widely used as an immunosuppressive drug (Sehgal et al. 1998). More recently, another investigation in the offshore of Easter Island was developed by Cumsille et al. (2017), where they studied the marine sediment and sponges samples. This investigation gave as a result the characterization of 16 different genera of Actinobacteria, being the most abundant *Micrococcus*, *Serinococcus*, *Kocuria*, *Nocardioides* and *Streptomyces*. More details are shown in **Figure 8**.

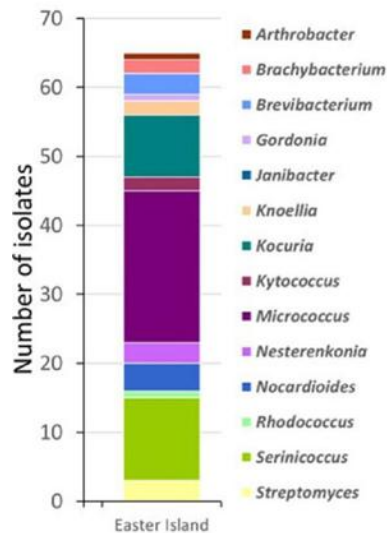

Figure 8 Actinobacterial diversity of marine sponge offshore Easter Island. Figure extracted and modified from Cumsille et al. (2017). No sediment diversity was reported.

2.4. Applications and biotechnology

Actinobacteria have shown an outstanding capacity for the production of secondary metabolites with unprecedented chemical structures (Fenical et al. 2009; Jang et al. 2013; Trischman et al. 1994), ranging from polyketides, non-ribosomal peptides, ribosomal peptides and polyketides-non-ribosomal peptide hybrids. As diverse as the chemistry found in Actinobacteria are the biological activities produced for these molecules. The most remarkable biological activities describe to-date and the producers are shown in **Table 2**.

Despite Actinobacteria immense potential for drug discovery, their biotechnological abilities are not limited to only chemical production. Thus, the advancement of molecular biology and genome sequencing technologies has allowed shedding light on many different biotechnological applications that Actinobacteria can deliver. Currently, many representatives of this phylum are being used to produce enzymes, such as proteases, amylases, xylanases and cellulases (Hamedi et al. 2017). The main function of these enzymes is to produce the hydrolysis of polymers in order to make available the individual units of the chain. A well-known example is the case of amylases, which produce the hydrolysis of starch to simpler hydrocarbons, like maltose, which can be used by wider range of organisms (McKillop et al. 1986).

Another biotechnological application of Actinobacteria is the biotransformation of chemicals. Biotransformation is the modification of the chemical structure in a molecule through a microbe catalyzed process (Pervaiz et al. 2013). This application takes advantage of the enzymatic capabilities of microbes, which can generate isomerization, oxidative and reductive reactions (Hamedi et al. 2017). The main benefit of biotransformation is the avoidance of synthetic chemistry for chemical modification, which may require several synthetic steps with highly toxic reagents and low yields, to produce the same modification than a microbe can develop in a single or few steps. An example of this process is the performed by *Rhodococcus rhodochrous* IEGM66, which produce the biotransformation of betulin, a pentacyclic lupane triterpenoid to betulona, a terpene which is a useful intermediate for the synthesis of biological active molecules. Betulin is obtained from the birch bark (*Betula spp.*) and it is biotransformed to betulona through a one-step regioselective oxidation of a secondary hydroxyl group, producing an oxo group (Grishko et al. 2013). If this chemical modification were carried out in a synthetic fashion, it would require multiple steps, as protection, oxidation and deprotection. Also, it would involve the use of high priced and eventually toxic reagents.

Bioremediation through the use of actinobacterial representatives is another application of great importance. Due to the large biodiversity and persistence of the phylum, Actinobacteria are adapted to live in conditions that other microorganisms cannot tolerate. This actinobacterial feature has been used in the recovery of contaminated soils (Alvarez et al. 2017). There have been reports of the use of Actinobacteria for the recovery of heavy metals (Alvarez et al. 2017), modification and solubilization of persistent organic chemicals (Chaudhary et al. 2011). A dual example of bioremediation of contaminated soils with cancerogenic heavy metals and organohalogenated chemicals is the case performed by *Streptomyces sp.* M7, which efficiently remedied Cr(VI) and lindane from contaminated soils (Polti et al. 2014). This finding has great potential due to the necessity of decontamination of currently or previously industrial areas in developed and developing countries. Nevertheless, the precise mechanism of intake and modification of the pollutants is not characterized yet.

Furthermore, Actinobacteria are being currently tested as a non-chemical antifungal agent in pilot agricultural farms. These studies have demonstrated that by adding *Streptomyces* spores to wheat seeds, plants will be able to tolerate infections of pathogenic fungi (*Rhizoctonia solani*, *Pythium sp.*) and will perform as good as with the addition commercial antifungal agents (Araujo et al. 2017). The relevance of this finding lies in that commercial antifungal agents have high level of toxicity and high cost for small farmers. Interestingly, similar results were obtained with rice (*Oryza sativa*) cultures. In a field trial, rice cultures were treated with broth cultures of *Streptomyces* obtained from the rice rhizosphere. These treated rice cultures were subsequently exposed to the pathogenic fungus *Rhizoctonia solani*. The result obtained (**Figure 9**) was the tolerance of the cultures when exposed to the infective agent (Araujo et al. 2017).

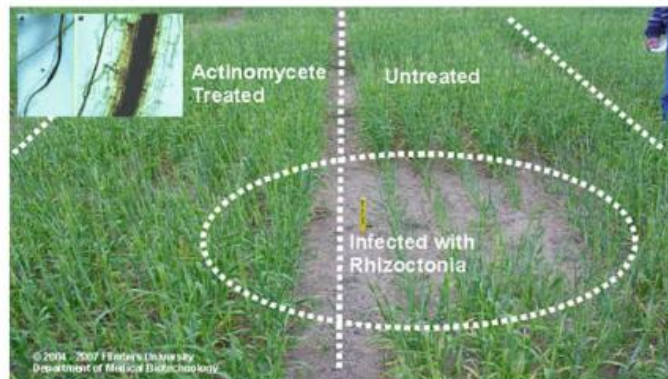

Figure 9 Fungal tolerance of rice treated with *Streptomyces* broth culture. Extracted from Araujo et al. (2017).

Biotechnological applications of Actinobacteria are more extensive than here presented (Hamedi et al. 2017). However, their most relevant ability is the production of secondary metabolite with biomedical and industrial applications. Several decades have been invested in the study and development of these features, and they have provided hundreds of molecules that we currently use in our everyday life (Imhoff et al. 2011; Miao and Davies 2010). **Table 2** presents a list of selected actinobacterial representatives, its chemical products and biological activities.

Table 2 Examples of bioactive chemicals produced by actinobacterial representatives and their biological activity. Table extracted from Barka et al. (2016).

Type of compound and producing species	Bioactive agent(s)
Antibacterial agent producers	
<i>Verrucosipora</i> spp.	Abyssomycin
<i>Streptomyces anulatus</i>	Actinomycins
<i>Streptomyces canus</i>	Amphotycin
<i>Micromonospora</i> spp.	Anthracyclin
<i>Streptomyces cattley</i>	Antibiotics and fluorometabolites
<i>Streptomyces canus</i>	Aspartocins
<i>Streptomyces avermitilis</i>	Avermectin
<i>Streptomyces venezuelae</i>	Chloramphenicol
<i>Micromonospora</i> spp.	Clostomicins
<i>Streptomyces griseus</i>	Cycloheximide
<i>Streptomyces orchidaceus</i>	Cycloserine
<i>Streptomyces roseosporus</i>	Daptomycin
<i>Saccharopolyspora erythraea</i>	Erythromycin (Ilotycin)
<i>Micromonospora purpurea</i>	Gentamicin
<i>Streptomyces hygroscopicus</i>	Hygromycin
<i>Streptomyces kanamyceticus</i>	Kanamycin
<i>Streptomyces kitasoensis</i>	Leucomycin
<i>Streptomyces lincolnensis</i>	Lincomycin
<i>Marinispora</i> spp.	Marinomycin
<i>Streptomyces fradiae</i>	Neomycins
<i>Micromonospora</i> spp.	Netamicin
<i>Streptomyces niveus</i>	Novobiocin
<i>Streptomyces antibioticus</i>	Oleandomycin
<i>Streptomyces rimosus</i>	Oxytetracycline
<i>Streptomyces</i> spp.	Pristinamycin
<i>Streptomyces lindensis</i>	Retamycin
<i>Streptomyces mediterranei</i>	Rifamycin
<i>Nocardia lurida</i>	Ristocetin
<i>Streptomyces ambofaciens</i>	Spiramycin
<i>Streptomyces virginiae</i>	Staphylomycin
<i>Streptomyces endus</i>	Stendomycin
<i>Streptomyces lydicus</i>	Streptolydigin
<i>Streptomyces griseus</i>	Streptomycin
<i>Streptomyces lavendulae</i>	Streptothricin
<i>Streptomyces aureofaciens</i>	Tetracycline
<i>Micromonospora</i> spp.	Thiocoraline
<i>Amycolatopsis orientalis</i>	Vancomycin

Table 2 (Continued) Examples of bioactive chemicals produced by actinobacterial representatives and their biological activity. Table extracted from Barka et al. (2016).

Type of compound and producing species	Bioactive agent(s)
Bioherbicide/biopesticide producers	
<i>Actinomadura</i> spp.	2,4-Dihydro-4-(β -D-ribofuranosyl)-1, 2, 4 (3H)-triazol-3-one (herbicide)
<i>Streptomyces hygrosopicus</i>	Herbimycin
<i>Streptomyces avermitilis</i>	Ivermectin (derivative of avermectin)
<i>Streptomyces prasinus</i>	Prasinons
<i>Saccharopolyspora spinosa</i>	Spinosad (neurotoxic insecticides)
Antiparasitic agent producers	
<i>Streptomyces avermitilis</i>	Avermectins
<i>Streptomyces coelicolor</i>	Prodiginine
<i>Streptomyces bottropensis</i>	Trioxacarcin
Antiviral agent producers	
<i>Streptomyces antibioticus</i>	9- β -D-Arabinofuranosyladénine
<i>Streptomyces hygrosopicus</i>	Hygromycin
<i>Streptomyces</i> spp.	Panosialins
Hypercholesterolemia agent producer	
<i>Streptomyces hygrosopicus</i>	Rapamycin
Antitumor agent producers	
<i>Micromonospora</i> spp.	Anthraquinones
<i>Nocardia asteroides</i>	Asterobactine
<i>Streptomyces</i> spp.	Borrelidine
<i>Micromonospora</i> spp.	Diazepinomicin
<i>Actinomadura</i> spp.	IB-00208
<i>Micromonospora</i> spp.	LL-E33288 complex
<i>Micromonospora</i> spp.	Lomaiviticins
<i>Micromonospora</i> spp.	Lupinacidins
<i>Thermoactinomyces</i> spp.	Mechercharmycin
<i>Marinospora</i> spp.	Marinomycin
<i>Salinispora tropica</i>	Salinosporamide
<i>Streptomyces peucetius</i>	Doxorubicin (adriamycin)
<i>Streptomyces peucetius</i>	Daunorubicin (daunomycin)
<i>Micromonospora</i> spp.	Tetrocarcin
<i>Micromonospora</i> spp.	Thiocoraline
Immunostimulatory agent producers	
<i>Nocardia rubra</i>	Rubratin
<i>Streptomyces olivoreticuli</i>	Bestatin
<i>Kitasatospora kifunense</i>	FR-900494
Immunosuppressive agent producers	
<i>Nocardia brasiliensis</i>	Brasilicardin
<i>Streptomyces filipinensis</i>	Hygromycin
<i>Streptomyces filipinensis</i>	Pentalenolactone
Therapeutic enzyme (antitumor) producers	
<i>Streptomyces</i> spp.	L-Asparaginase
<i>Streptomyces olivochromogenes</i>	L-Glutaminase

Table 2 (Continued) Examples of bioactive chemicals produced by actinobacterial representatives and their biological activity. Table extracted from Barka et al. (2016).

Type of compound and producing species	Bioactive agent(s)
Antifungal agent producers	
<i>Streptomyces anulatus</i>	Actinomycins
<i>Streptomyces nodosus</i>	Amphotericin B
<i>Streptomyces griseochromogenes</i>	Blasticidin
<i>Streptomyces griseus</i>	Candicidin
<i>Streptomyces</i> spp.	Carboxamycin
<i>Streptomyces venezuelae</i>	Chloramphenicol
<i>Streptomyces padanus</i>	Fungichromin
<i>Streptomyces galbus</i>	Galbonolides
<i>Streptomyces violaceusniger</i> YCED-9	Guanidylfungin
<i>Streptomyces venezuelae</i>	Jadomycin
<i>Streptomyces kasugaensis</i>	Kasugamycin
<i>Streptomyces</i> spp.	Kitamycin
<i>Streptomyces natalensis</i>	Natamycin
<i>Streptomyces tendae</i>	Nikkomycin
<i>Streptomyces diastatochromogenes</i>	Oligomycin
<i>Streptomyces humidus</i>	Phenylacetate
<i>Streptomyces cacaoi</i>	Polyoxin B
<i>Streptomyces canus</i>	Resistomycin
<i>Streptomyces lavendulae</i>	Streptothricin
<i>Streptomyces canus</i>	Tetracenomycin
<i>Nocardia transvalensis</i>	Transvalencin
<i>Streptomyces hygrosopicus</i>	Validamycin

3. Microbial natural products chemistry

3.1. General overview and uses

Natural Products refers to a broad variety of small molecules that are produced by organisms. Most of these chemicals are products of secondary metabolism, which means that they are important for survival but not essential (Buchanan et al. 2015). Most of the microbial secondary metabolites discovered to date have biological activities, such as antibacterial (Hohmann et al. 2009), antitumoral (Pamboukian and Facciotti 2004), immune-suppressive (Abraham 1998), antifungal (Caffrey et al. 2001) and metal chelation activity (Wang et al. 2014). The wide bioactivity of these chemicals has direct relation to their chemical diversity. Currently, there are a number of classes of microbial natural products described. The most relevant are polyketides (PK), non-ribosomal peptides (NRP), ribosomal peptides (RiP) and hybrids of non-ribosomal peptide-polyketides (PK-NRP). Examples of these molecules are shown in **Figure 10**.

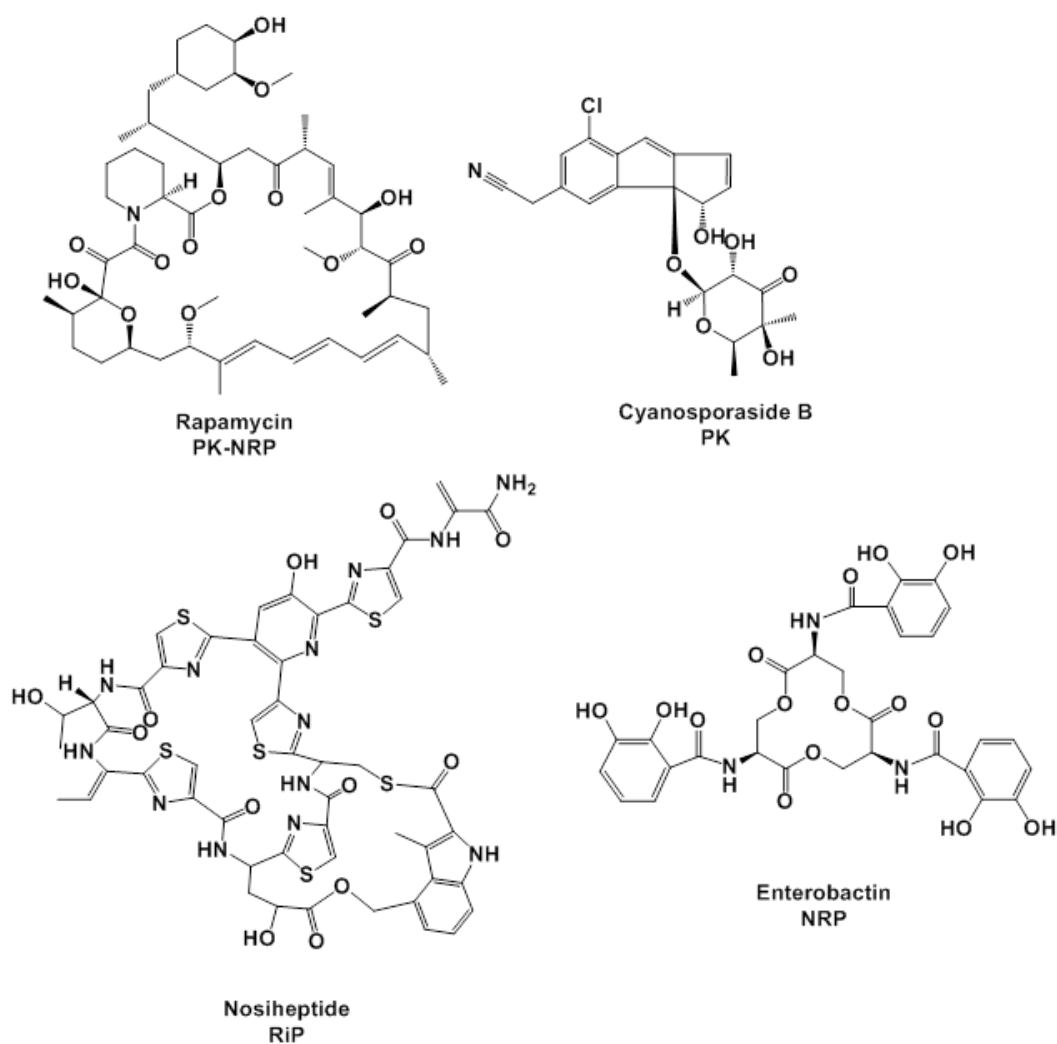

Figure 10 Biosynthetic chemical diversity of Actinobacteria. PK: polyketide, NRP: non-ribosomal peptide, RiP: ribosomal peptide, PK-NRP: hybrid of polyketide-non-ribosomal peptide.

3.2. Biosynthesis

The biosynthesis of microbial natural products occurs in different ways depending of the nature of the chemicals to be produced. The main classes can be divided in polyketides, peptides, and hybrids. The information for the biosynthesis is encoded in the microbial genes, which produce large enzymatic modules that take simple chemical units (acetate and its derivatives, aminoacids,), to produce complex and highly modified molecules which in some cases cannot be directly recognized.

3.3. Polyketides

Polyketides molecules are built on the base of acetate units (C_2), as the minimal building block. The coupling reaction between two different units is made through a Claisen condensation, which results in a poly- β -ketone chain (Rittner and Grninger 2014). The growing chain is transferred to other enzymatic modules in an assembly line fashion to produce further chemical modifications by multi-modular or iterative enzymatic processes. Polyketides have different classification depending of the enzymatic building strategy, thus there are three types: type I, type II and type III (Weissman 2009). Type I PKS are characterized by large multi-modular enzymatic complexes. Each module has at least one catalytic domain, which modifies the growing polyketide. During the assembly each module only acts once on the growing polyketide chain (**Figure 11A**). Type II PKS are known to be the minimal PKS, due to that they are composed of only three domains which are used multiple times in an iterative fashion (**Figure 11B**). Type III PKS are mainly characterized by the lack of a transporter protein, the acyl carrier protein (ACP), and their mode of action, which works iteratively (**Figure 11C**) (Weissman 2009). The catalytic domains differ depending of the chemical modification encoded in the genes. To date known catalytic domains are: acyl carrier proteins domain (**ACP**), ketosynthase domain (**KS**), thioesterase domain (**TE**), ketoreductase domains (**KR**), dehydratase domain (**DH**), enoylreductase domain (**ER**), methyl Transferases domain (**MT**), halogenases domain (**Hal**), cyclases domain (**Cyc**) and oxygenases domain (**Ox**) (Olano et al. 2010). Examples of the PKS products are 6-deoxyerythronolide B (Type I), Galvaquinone B (Type II) and Resveratrol (Type III).

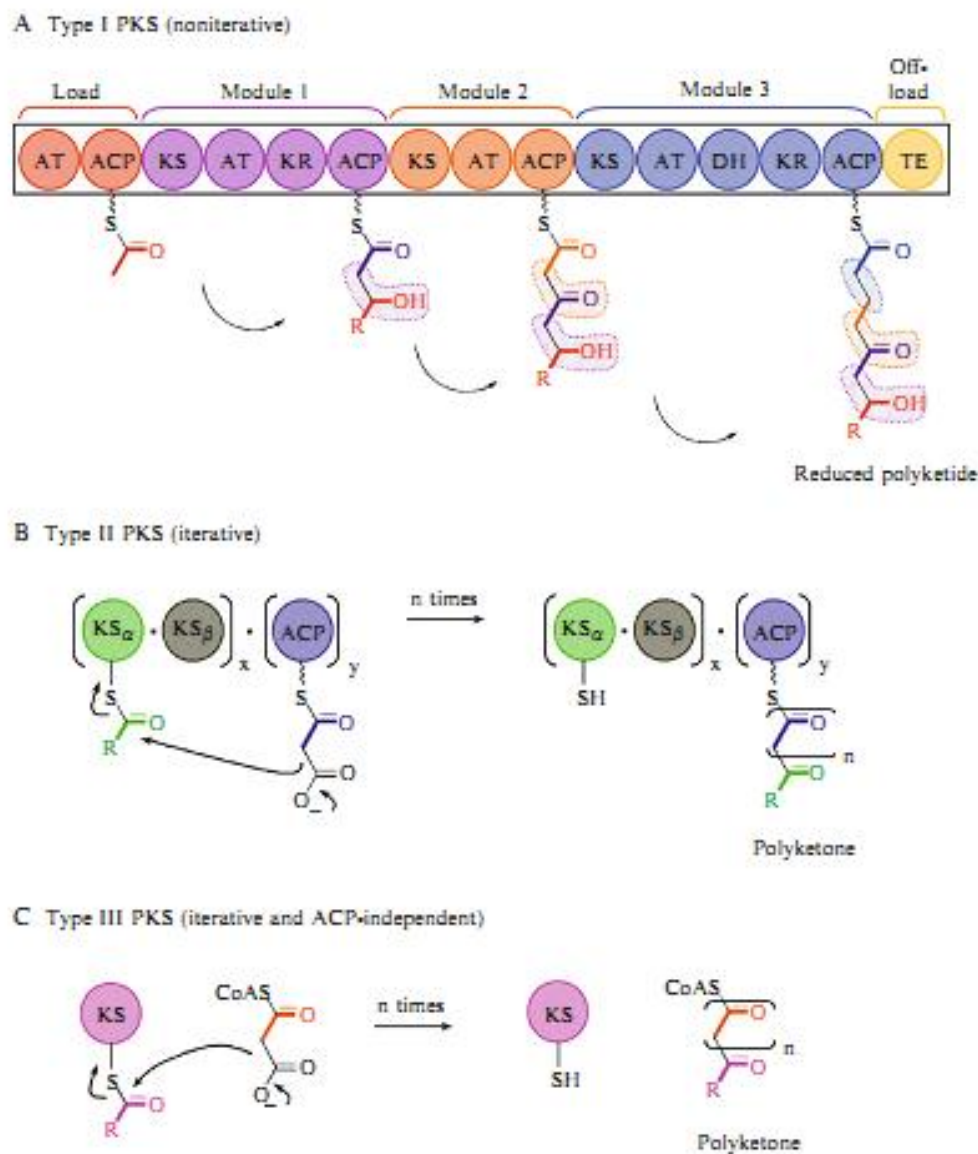

Figure 11 Types of polyketide synthases. A: Type I, B: Type II, C: Type III. Extracted from Weissman et al. (2009).

3.4. Peptides

Peptide natural products are as diverse as polyketides, their primary classification is based in the origin, which can be non-ribosomal and ribosomal synthesis. Both of these chemotype are encoded in the microbial genomes and built with simpler units, proteinogenic and non-proteinogenic aminoacids (Arnison et al. 2013; Marahiel and Essen, 2009).

Non-ribosomal peptides (NRP) are synthesized through a multi-modular system, quite similar to the one shown in the synthesis of type I polyketides, but differing in the enzymatic machinery. The condensation reaction occurs through a peptide bond formation, with a previous activation by phosphorylation (Marahiel and Essen, 2009). Subsequently, the substrate aminoacid is coupled with the peptide intermediary, extending the peptide chain (**Figure 12**). The condensation, activation, transference and chemical modification of the growing peptide chain are catalyzed by different enzymatic modules which are composed of catalytic units, such as: adenylation domain (**A**), thiolation domain (**T**), condensation domain (**C**) and thioesterase domain (**TE**). Generally, long peptide chains undergo a macrocyclization in order to improve their stability (Marahiel and Essen, 2009).

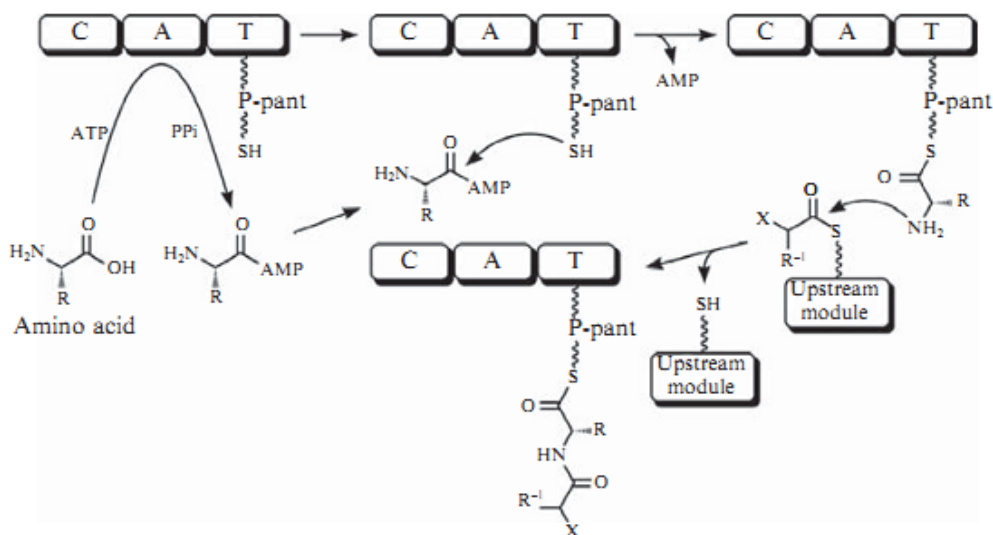

Figure 12 Basic non-ribosomal peptide biosynthesis mechanism. adenylation domain (A), thiolation domain (T), condensation domain (C). **Thioesterase domain (TE) not shown in the figure. Extracted from Watanabe et al. (2009).

Ribosomal peptides are synthesized by the ribosomes and they undergo posttranslational chemical modifications (**Figure 13**). The encoded genetic information is directly translated by the ribosomes. The translation produces a precursor peptide which is composed by the leader peptide and the core peptide. The leader peptide major function is to provide recognition sites for further modifications of the final product. The core peptide is the precursor of the final peptide product (Ortega and van der Donk, 2016).

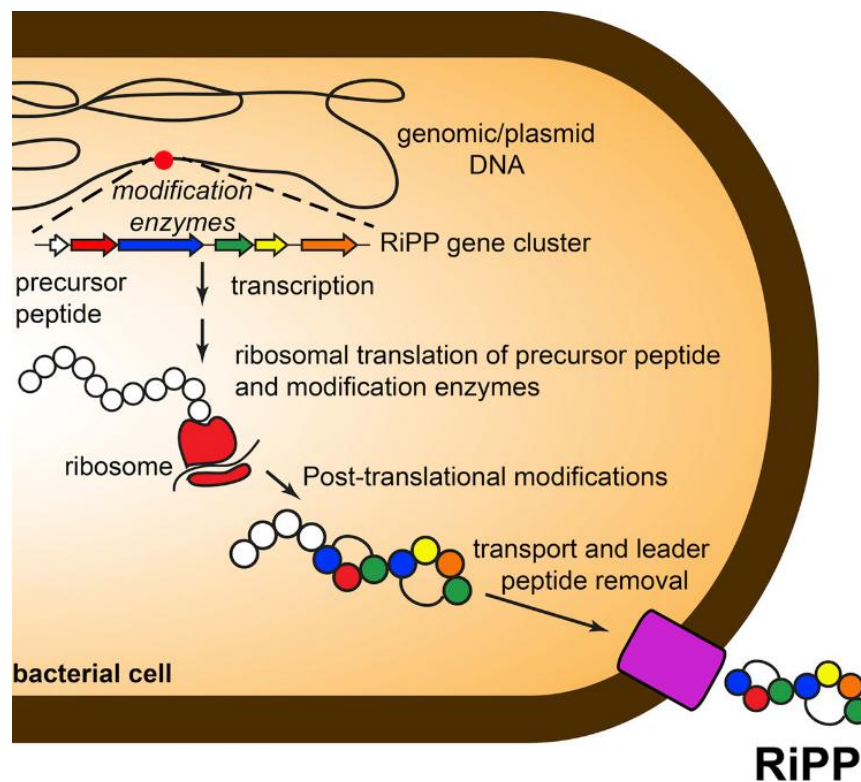

Figure 13 Biosynthesis of ribosomal peptides. Extracted and modified from Ortega et al. (2016).

There are different types of ribosomal peptides, which are: lassopeptides, thiopeptides, linaridins, cyanobactins, lanthipeptides and microcins. The main difference among these peptide is the aminoacids composition, heteroatom ring formation, sulfur bonds, disulfide bonds, and by their terminal aminoacid modifications (Bagley et al. 2005; Claesen and Bibb, 2011; Dong et al. 2019; Donia et al. 2008; Knappe et al. 2009; Knerr and van der Donk, 2012).

V. Research aims

The aim of my thesis was to study the Actinobacteria diversity dwelling in the coastal zone of Easter Island and the chemical exploration of selected actinobacterial representatives.

This thesis has three major objectives:

Characterize the culturable Actinobacteria diversity of the coastal zone of Easter Island

Multiple marine-derived samples were taken from the intertidal zone of Easter Island and cultured in seven different nutritive media. The characterization of the obtained actinobacterial representatives was made through the analysis of the 16S rRNA gene, which was also used to construct phylogenetic trees for further classification.

Investigation of the Easter Island sea anemone, *Gyactis sesere*, its actinobacterial diversity and anthraquinone content

The actinobacterial symbionts and the anthraquinone content of the sea anemone, *Gyactis sesere*, were investigated in order to clarify the producer of two known antitumoral anthraquinones, lupinacidin A and galvaquinone B. To develop this investigation chemical dereplication through HPLC, LC-MS and NMR were used. For the isolation of the symbionts, culture techniques were developed with seven different media. Symbionts characterization and anthraquinone biosynthetic potential were elucidated through gene and genome sequencing and subsequent bioinformatic analysis.

Comparison of the secondary metabolites profiles and morphological traits of two phylogenetic almost identical *Streptomyces griseus* strains originating from geographically remote locations

¹H NMR, HPLC and LC-MS were used compared the secondary metabolites production of two almost identical *Streptomyces griseus* strains, originating from geographical distant locations. Chemical data was associated with morphological, biological activity and phylogenetic evaluation to discern whether or not two *Streptomyces* strains with identical 16S rRNA gene sequence may produce a dissimilar chemical diversity with medicinal potential.

VI. Results

1. Easter Island actinobacterial diversity

High diversity and novelty of *Actinobacteria* isolated from the coastal zone of the geographical remote young volcanic Easter Island, Chile.

Ignacio Sottorff, Jutta Wiese, and Johannes F. Imhoff:

International Microbiology, 2019

<https://doi.org/10.1007/s10123-019-00061-9>



High diversity and novelty of *Actinobacteria* isolated from the coastal zone of the geographically remote young volcanic Easter Island, Chile

Ignacio Sottorff^{1,2} · Jutta Wiese¹ · Johannes F. Imhoff¹

Received: 18 July 2018 / Revised: 8 January 2019 / Accepted: 24 January 2019
© Springer Nature Switzerland AG 2019

Abstract

Easter Island is an isolated volcanic island in the Pacific Ocean. Despite the extended knowledge about its origin, flora, and fauna, little is known about the bacterial diversity inhabiting this territory. Due to its isolation, Easter Island can be considered as a suitable place to evaluate microbial diversity in a geographically isolated context, what could shed light on actinobacterial occurrence, distribution, and potential novelty. In the present study, we performed a comprehensive analysis of marine *Actinobacteria* diversity of Easter Island by studying a large number of coastal sampling sites, which were inoculated into a broad spectrum of different culture media, where most important variations in composition included carbon and nitrogen substrates, in addition to salinity. The isolates were characterized on the basis of 16S ribosomal RNA gene sequencing and phylogenetic analysis. High actinobacterial diversity was recovered with a total of 163 pure cultures of *Actinobacteria* representing 72 phylotypes and 20 genera, which were unevenly distributed in different locations of the island and sample sources. The phylogenetic evaluation indicated a high degree of novelty showing that 45% of the isolates might represent new taxa. The most abundant genera in the different samples were *Micromonospora*, *Streptomyces*, *Salinispora*, and *Dietzia*. Two aspects appear of primary importance in regard to the high degree of novelty and diversity of *Actinobacteria* found. First, the application of various culture media significantly increased the number of species and genera obtained. Second, the geographical isolation is considered to be of importance regarding the actinobacterial novelty found.

Keywords Easter Island · *Actinobacteria* · Pacific Ocean · New taxa · Polynesia

Introduction

Easter Island, or Rapa Nui (Polynesian name), is a young island of volcanic origin (0.78 Ma) (Vezzoli and Acocella 2009) located in the Pacific Ocean. It has an area of 163.6 km² and a maximum ground elevation of 560 m a.s.l. The island is mostly formed by volcanic rock, lava outcrops, and clay soils (Casanova et al. 2013). It is known worldwide for its rock statues, the Moai. After its emergence as a volcano-derived territory, Easter Island was colonized by animals and plants through migration and oceanic drift (Barnes et al. 2006; Grau 1996; Montenegro et al. 2008). The human

colonization of the territory has happened approx. 1200 years A.D. (Hunt and Lipo 2006) and was initiated as a progressive spread of the Polynesians through Pacific Ocean islands (Wilmshurst et al. 2011).

Easter Island has a privileged location for studies of biodiversity due to its geographically isolated location in the southern Pacific Ocean. Diverse marine biodiversity surveys have been developed on the island, targeting mostly macroorganisms, and have found that this territory has a high degree of endemism (Glynn et al. 2007; Kohn and Lloyd 1973; Osorio and Cantuarias 1989; Rehder 1980; Santelices and Abbott 1987). Despite the wide knowledge in the geology and zoology of the island, marine microorganisms have stayed almost untouched with the exception of a few studies targeting the island or its surroundings (Cumsille et al. 2017; Miller et al. 2014; Vezina et al. 1975).

In this context, information on Easter Island actinobacterial diversity is very limited (Cumsille et al. 2017; Vezina et al. 1975), though of particular importance due to harboring interesting biotechnological features, such as the production of

✉ Johannes F. Imhoff
jimhoff@geomar.de

¹ GEOMAR Centre for Ocean Research Kiel, Marine Microbiology, Düsternbrooker Weg 20, 24105 Kiel, Germany

² Facultad de Ciencias Naturales y Oceanográficas, Universidad de Concepción, Concepción, Chile

pharmacological chemicals (Miao and Davies 2010). A previous study on a single soil-dwelling Easter Island Gram-positive bacterium, *Streptomyces rapamycinicus* DSM 41530^T, demonstrated the potential of *Streptomyces* representatives for the discovery of pharmacologically relevant molecules (Vezina et al. 1975). The strain produced rapamycin (Sirolimus®), an immunosuppressive drug with a unique mechanism of action (Sehgal 1998). Moreover, *Actinobacteria* constitute an important part of bacteria inhabiting soils (Babalola et al. 2009), marine sediments (Pathom-aree et al. 2006), and a broad range of macroorganisms (Abdelmohsen et al. 2010; Kaltenpoth 2009). Furthermore, their distribution has shown signs of global dispersal of a diverse array of genera and species (Maldonado et al. 2005), for which a study of this bacterial phylum in a geographically isolated context would contribute to improve the understanding of the actinobacterial distribution on the globe.

The present study aims to gain knowledge on the diversity, uniqueness, and biogeography of *Actinobacteria* inhabiting the Easter Island. For this purpose, different samples that originated from the coastal zone were studied using a cultivation-based approach. Isolates were characterized through phylogenetic analysis of 16S rRNA gene sequences. The results revealed high actinobacterial diversity at the species and genus level, with dependency on the sample location and nature.

Materials and methods

Sample collection and treatment

Samples were taken from marine habitats at the coastal zone of the Easter Island by the first author (Chilean citizen), during March 2016. All sampling sites were outside of the Isla de Pascua national park (Table 1, Fig. 1) and were taken in agreement with regulations by the Chilean government. Samples were collected and stored at 0 °C 1 hour after the sampling process. The number of samples for each zone depended on the accessibility of the particular sample site. Salinity and water temperature of the island were checked by local indicators and were in agreement with those published (Moraga et al. 1999), i.e., 22 °C for sea water temperature and 35‰ of salinity.

Approx. 1 cm³ of each sample was taken, homogenized if possible, and transferred into a new sterile tube. Subsequently, 9 mL of Ringer's buffer ¼ strength (Goodfellow and Fiedler 2010) were added to produce a final solution of 1:10. Then, this solution was incubated at 56 °C for 10 min with the aim of reducing the viability of non-actinobacterial microbes. After the incubation, 1 min of vortex was applied, and 1 mL of 1:10 solution was taken and diluted with 9 mL of Ringer's buffer to obtain a 1:100 solution. This last step was repeated to obtain

10 mL of a 1:1000 solution. The inoculation of the culture media was done by adding 50 µL of the dilution into 15 cm of diameter Petri dishes containing the media and spreading the solution with a triangular glass-made cell spreader. This process was repeated with each dilution and each culture medium. All the sample dilutions were equally inoculated in the 7 media using the same conditions and incubated at 25 °C in darkness. Darkness was chosen as a filtering factor to eliminate potential microalgal contamination. After 3 weeks of incubation, the agar plates were visually checked. When growth was evident, all the grown colonies were purified by streaking on a new agar plate of the same isolation media, until an axenic culture was achieved. All actinobacterial isolates were cryo-conserved at –80 °C using the Cryobank™ Bacterial storage system (Mast Diagnostica GmbH, Germany).

Cultivation media

The design and selection of the culture media were carried out by selecting nutrient sources that have environmental availability, and that in addition can be used by actinobacterial representatives in the detriment of other bacteria, as complex and uncommon sugars, organic and inorganic nitrogen molecules, and minerals (Kopf et al. 2015). Another relevant factor was salinity, since it was used as a filter to increase the isolation of actinobacterial representatives with a degree of salt tolerance or sea adaptation (Seymour 2014). Salinity was adjusted by the use of artificially reconstituted sea salt, sodium chloride, and natural sea water. Finally, we included an artificially reconstituted oligotrophic medium, which mimics the sea water components (Muscholl-Silberhorn et al. 2008), as well as naturally occurring oligotrophic sea water media (North and Baltic Sea water) to test the importance of microelements in the isolation of marine *Actinobacteria*.

The isolation and cultivation media for the present work were performed using new generated culture media (BCM, chitin medium; BTM, trehalose medium; BSEM, Baltic Sea water medium; NSEM, North sea water medium) as well as of previously reported media with subtle modifications (SIMA1, starch-based *Salinispora* isolation medium (Patin et al. 2016); HA, humic acid medium (Hayakawa and Nonomura 1987); OLI, oligotrophic medium (Muscholl-Silberhorn et al. 2008). Medium SIMA1 (2.5 g starch, 1 g yeast extract, 0.5 g peptone, 1 L aq. deion., 25 g Tropic Marin™ salt (Wartenberg, Germany), 15 g/L agar (Patin et al. 2016)); medium BCM (3 g chitin, 0.5 g N-acetyl glucosamine, 0.2 g K₂HPO₄, 0.25 g KNO₃, 0.25 g casein, 5 mL of mineral solution, 4 mL vitamin solution, 1 L aq. deion., 15 g/L Tropic Marin™ salt (Wartenberg, Germany), 12 g/L Gellan gum, pH = 7.35); medium BTM (1 g trehalose, 0.25 g histidine, 0.25 g proline, 0.2 g MgCl₂ × 6H₂O, 4 mL vitamin solution, 12 g/L Gellan gum, 1 L aq. deion., 15 g Tropic Marin™ salt

Table 1 Easter Island samples sites, origin, and distribution. Graphical representation of the sampling sites can be seen in Fig. 1

Zone	Sample	Sample type	Latitude (N-S)	Longitude (W-E)
1	SN1	Sea grass on rocks	27° 04' 24.0" S	109° 19' 26.5" W
1	SN3	Beach sand	27° 04' 24.2" S	109° 19' 26.4" W
1	SN5	Intertidal zone small stone**	27° 04' 24.1" S	109° 19' 26.1" W
1	SN6	Marine sediment (depth 3 m)	27° 04' 22.5" S	109° 19' 26.2" W
1	SN7	Brown algae (depth 3 m)	27° 04' 24.0" S	109° 19' 25.9" W
1	SN8	Brown algae attached to a stone (depth 3 m)**	27° 04' 23.5" S	109° 19' 25.6" W
1	SN10	Holothuria nest sand (depth 3 m)	27° 04' 23.1" S	109° 19' 26.7" W
2	SN20	Intertidal zone stone**	27° 05' 36.4" S	109° 16' 49.0" W
3	SN21	Small stone (depth 10 cm)**	27° 07' 24.2" S	109° 16' 12.0" W
4	SN11	Coral (<i>Porites lobata</i>)	27° 08' 58.0" S	109° 20' 07.7" W
5	SN22	Rocky pond sediment	27° 09' 45.8" S	109° 26' 34.5" W
5	SN23	Sediment from intertidal pool	27° 09' 37.8" S	109° 26' 35.6" W
6	SN25	Marine sediment (depth 40 cm)	27° 08' 45.0" S	109° 25' 49.8" W
6	SN26	Unknown zoanthid specimen	27° 08' 45.1" S	109° 25' 50.0" W
6	SN27	Small stone (depth 10 cm)**	27° 08' 45.4" S	109° 25' 50.1" W
6	SN28	Brown algae from intertidal zone	27° 08' 44.8" S	109° 25' 49.7" W

**All the marine-derived stones were submerged and had an approx. volume of 1 cm³

(Wartenberg, Germany), pH=7.2; medium HA (0.5 g humic acid, 0.25 g Na₂HPO₄, 0.85 g KCl, 0.25 g MgSO₄ × 7H₂O, 5 × 10⁻³ g FeSO₄ × 7H₂O, 0.01 g CaCO₃, 12 g/L Gellan gum, 4 mL/L of vitamin solution (Hayakawa and Nonomura 1987), 1 L aq. deion., pH=7.2). The natural oligotrophic media used were medium BSEM (0.1 g tyrosine, 0.1 g D-galactose, 4 mL vitamin solution, 5 mL mineral solution, 1 L Baltic Sea water, 16 g/L agar, pH=7.4) and medium NSEM (0.1 g tyrosine, 0.1 g D-galactose, 4 mL vitamin solution, 5 mL mineral solution, 1 L North Sea water, 16 g/L agar, pH=7.4). The vitamin solution added to BCM, BTM, HA, BSEM, and NSEM

media contained 1 L aq. deion., 5 mg thiamine × HCl, 5 mg riboflavin, 5 mg niacin, 5 mg pyridoxine HCl, 5 mg inositol, 5 mg Ca-pantothenate, 5 mg *p*-amino benzoic acid, and 2.5 mg biotin (Hayakawa and Nonomura 1987). The mineral solution added to BCM, BSEM, and NSEM media contained 1 L aq. deion., 50 mg FeSO₄ × 7H₂O, 50 mg ZnCl₂, 50 mg CuSO₄ × 5H₂O. The artificially reconstituted oligotrophic OLI medium was prepared as reported in Muscholl-Silberhorn et al. 2008 (called HSPC medium), but without the addition of fatty acids. Briefly, it contained 10 mineral salts, with NaCl as the major salt (25 g/L), 14 trace elements,

Fig. 1 Geographical distribution of sample sites and actinobacterial richness of Easter Island, Chile (expressed as phylotype diversity). Samples originate from six different zones and include samples: SN1, SN3, SN5, SN10, SN6, SN7, SN8 from zone 1; SN20 from zone 2; SN21 from zone 3; SN11 from zone 4; SN22, SN23 from zone 5; and SN25, SN26, SN27, SN28 from zone 6. Each dot represents a sample site, and its size is directly proportional to the number of phylotypes found (as indicated on right side scale)

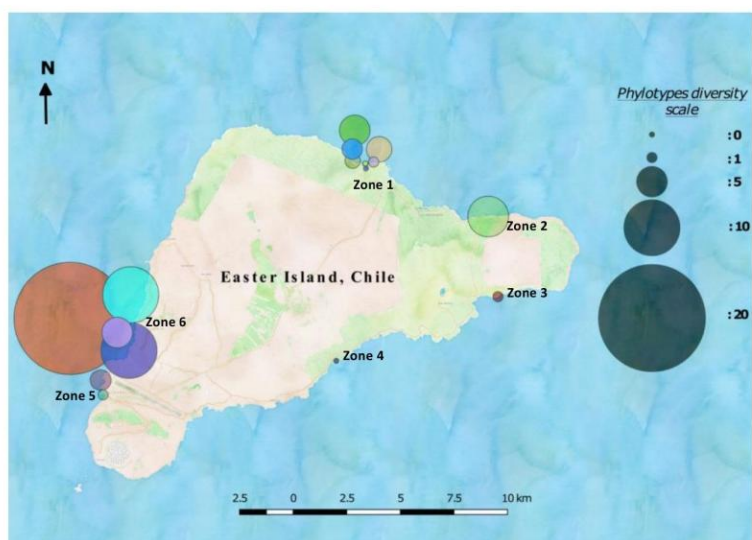

10 vitamins, 13 carbon sources, and 2 nitrogen sources. All media were supplemented with 50 mg/L of nalidixic acid and 100 mg/L of cycloheximide with the aim of avoiding the growth of Gram-negative bacteria, yeasts, and fungi (Thaker et al. 2014).

Molecular characterization

For the molecular characterization of the isolates, DNA was extracted using the DNeasy™ kit (Qiagen GmbH, Hilde, Germany) according to the manufacturer's instructions. 16S rRNA gene sequence amplification was performed using general primers for bacteria in a concentration of 10 µmol/µL, i.e., 27f and 1492r (Lane 1991), 342f and 534r (Staufenberger et al. 2008), 1387r (Ellis et al. 2003), and 1525r (Frank et al. 2008). PCR reagents were obtained from GE Healthcare illustra™ PuReTaq Ready-To-Go™ PCR Beads (GE Healthcare, Glattbrugg, Switzerland) containing DNA polymerase, MgCl₂ × 6H₂O, and dNTPs. The sequencing process was run at the Centre for Molecular Biology at Kiel University (IKMB). The 16S rRNA gene sequences were manually curated using Chromas pro software (version 1.7.6) and saved in FASTA format. The classification of the isolates on the genus level was performed by using the Ribosomal Database Project (Cole et al. 2013). BLAST was used for the alignment of the 16S rRNA gene sequences and for the phylogenetic affiliation of the isolates with the next related strain (Altschul et al. 1990). The BLAST analysis was run twice, with comparing against type strains only, and once against all available bacterial sequences in order to obtain a view of the isolate phylogenetic relationship, but only the former was considered for the phylogenetic construction and assessment. Data about the number of species for *Actinobacteria* genera was obtained from the list of prokaryotic names with standing in nomenclature (Parte 2014). The sequences of the representatives of the phylotypes were deposited in NCBI under Genbank accession number MH299425-MH299496 (Table 4).

Phylotype assignment

By using the nucleotide sequence of the 16S rRNA gene of the Easter Island isolates, affinity phylogenetic trees were constructed with the representatives of each genus in order to delineate phylotypes. A phylotype was defined on the dissimilarity of the 16S RNA gene sequence among the Easter Island isolates. In the case two or more isolates shared 100% of similarity of the 16S RNA gene sequence, they were assigned to a single phylotype, but only one strain was selected as representative for the phylogenetic evaluation, which is listed in Table 4 and Figs. 3, 4, and 5. The comparison between the numbers of total isolates and phylotypes per sample can be seen in Table 3.

Phylogenetic analysis

Phylogenetic tree calculations were performed with the 16S rRNA gene sequences of the Easter Island phylotypes and their respective closest type strains. The sequences were aligned using SILVA-SINA (Quast et al. 2013), and the alignment was saved in FASTA format. MEGA version 7.08.18 was used for gap deletion, phylogenetic model calculations, and bootstrapped phylogenetic tree construction using a maximum likelihood model (Tamura et al. 2011). The final version of phylogenetic trees was made with Figtree version 1.4.3 software to improve visualization only (Rambaut 2015).

Data analysis

Figure 1 was created through the usage of Qgis software (QGIS 2018), Fig. 2 was drawn up with RAWGraphs (Mauri et al. 2017).

Results

Sampling sites and *Actinobacteria* richness

We took various samples on the coastal shoreline around Easter Island. The different sampling sites are shown in Fig. 1, a map of the island. More details can be found in Table 1, where sample origin and geographic coordinates are presented. The actinobacterial richness varied largely on the different samples, from no actinobacterial isolates found in a few samples (SN1, SN5, and SN11), to high abundance and diversity in samples like SN25, SN26, and SN27. The recovery of *Actinobacteria* from the samples showed different success, which is detailed in Table 3. Interestingly, no isolate was obtained from a coral fragment (homogenized tissue and skeleton) of the species *Porites lobata* (sample SN11), even though corals are commonly associated with abundant microbes (Mahmoud and Kalendar 2016).

In terms of sample richness, samples SN25, SN26, and SN27 (all zone 6) had the highest number of *Actinobacteria* isolates, phylotypes, and genera. Sample SN25, representing a coastal sediment sample, revealed the highest diversity. It yielded 12 out of 20 genera found in all sites, represented by 21 phylotypes and also contained the highest number of *Micromonospora* phylotypes (7). Sample SN25 was followed in actinobacterial richness by a small stone (SN27) which exhibited 13 phylotypes distributed in 7 genera, and an unidentified zoanthid individual (SN26), which revealed 10 phylotypes belonging to 7 actinobacterial genera, as shown in Table 3. Furthermore, the samples from zone 6 (SN25, SN26, SN27, and SN28) yielded a total of 18 genera, indicating an above average *Actinobacteria* diversity for this small area whereas the regular number of isolated genera in the other

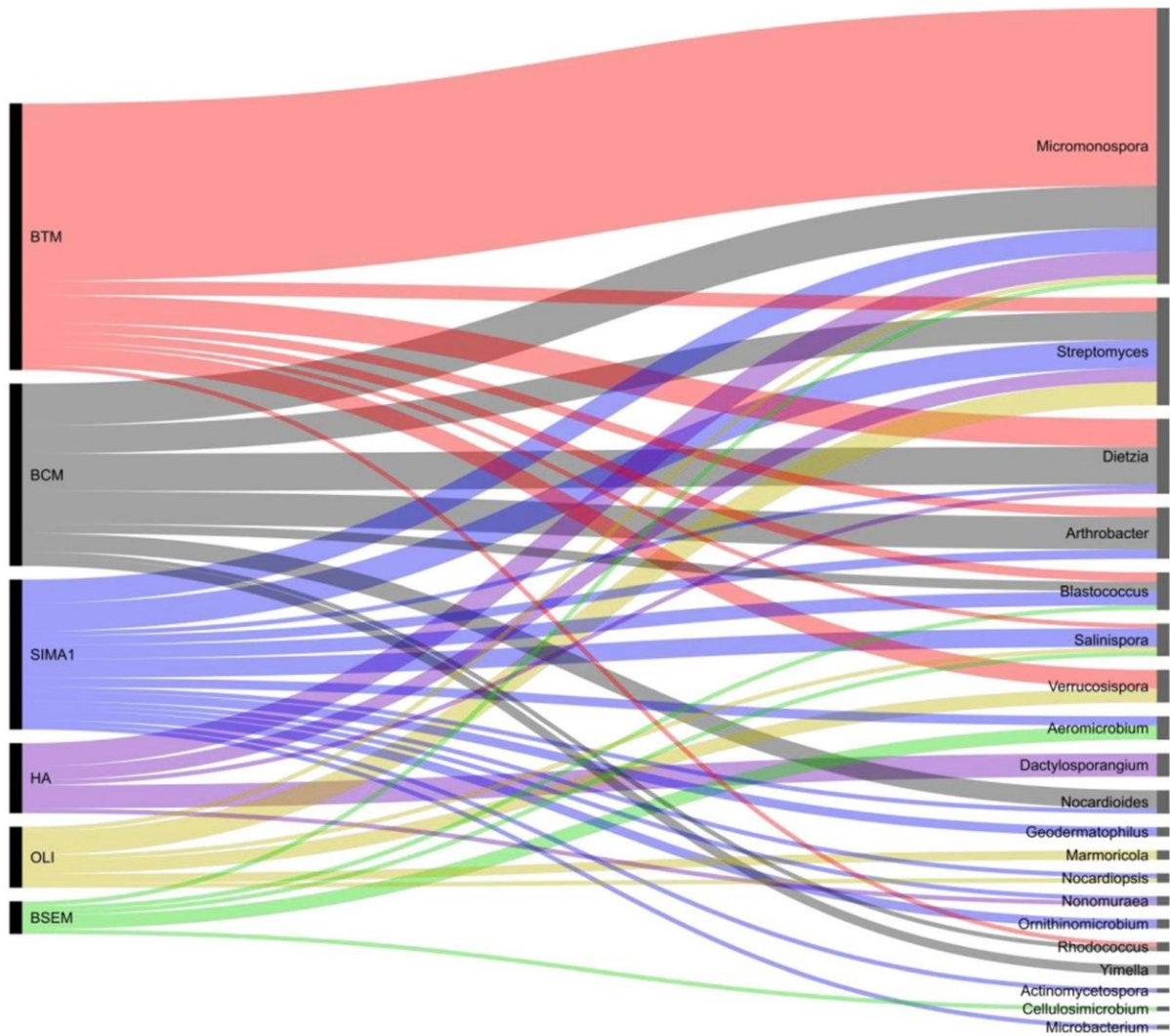

Fig. 2 Media-specific isolation of representatives of different genera of *Actinobacteria* obtained from 6 different cultivation media. The broadness of the connection is directly proportional to the number of isolates for each genus. NSEM medium is not included in the figure, because no *Actinobacteria* were isolated. Media and key components.

BTM: trehalose, amino acids, 15 g/L salinity. BCM: chitin, N-acetyl glucosamine, casein, 15 g/L salinity. SIMA1: starch, peptone, yeast extract, 25 g/L salinity. HA: humic acid, no salt added. OLI: oligotrophic media, 25 g/L salinity. BSEM: tyrosine, galactose, 15 g/L salinity. NSEM: tyrosine, galactose, 35 g/L salinity

samples varied from 1 to 4 genera. Further details, i.e., data about the number of isolates and phylotypes affiliating to the genera for each sample, are depicted in Table 3.

Impact of culture media on isolation success

In order to evaluate the specificity of culture media and to improve the recovery of the environmental diversity, 7 different culture media were used for the isolation. The isolation of representatives of different genera with the different composition of culture media was achieved, in some cases showing specificity. Each culture medium yielded different levels of

diversity, which are compared in Table 2 with regard to the number of isolates/phylotypes/genera obtained. Interestingly, it seems that our cultivation procedure and media were specific for *Actinobacteria*, as the growth of other bacterial groups was negligible, with just a few representatives of the *Firmicutes* (*Bacillus*, *Staphylococcus*, and *Aerococcus*) being isolated.

It turned out that some of the media were highly specific and, as a result, several of the genera/species/phylotypes were isolated specifically from one of the media. Only in a few cases, the same phylotypes, affiliated to *Streptomyces*, *Dietzia*, *Salinispora*, and *Micromonospora*, were isolated

Table 2 Comparison of the isolation success of each culture media in function of the number of isolates/phylotypes/genera obtained

Media	Isolates	Phylotypes	Genera
SIMA1	32	25	14
BCM	39	20	8
BTM	57	18	8
HA	15	8	5
OLI	13	8	6
BSEM	7	7	5
NSEM	0	0	0

from different media. For instance, by adding chitin (medium BCM), specifically representatives of the genus *Yimella*, could be isolated. On the other hand, the addition of starch into the culture media provided a more universal medium for *Actinobacteria* (medium SIMA1), ending up in a wider range of *Actinobacteria* genera. Besides, medium SIMA1 provided specificity for *Ornithinimicrobium*, *Geodermatophilus*, *Actinomycetospora*, and *Microbacterium*, which were solely isolated with this culture medium. Furthermore, the selection

of chitin and starch reduced the growth of non-*Actinobacteria*, due to the inability of these competitors to metabolize long-chain carbohydrates. This last factor indirectly supported the isolation of *Actinobacteria*. Moreover, the use of different nutrient sources revealed the preference of *Actinobacteria* to carbohydrate and protein derivatives (higher diversity with the media SIMA1, BTM, and BCM media). In contrast, when culture media were deprived of carbohydrates and supplemented with humic acid (medium HA), the actinobacterial diversity was significantly reduced. The optimal carbohydrate concentrations of the media used in this study were those used in SIMA1 (2.5 g/L of starch), BCM (3 g/L chitin and 0.5 g/L N-acetyl glucosamine), and BTM (trehalose 1 g/L). These media also had protein-derived nutrients (peptone, amino acids, yeast extract) in the order of 0.1–1.0 g/L.

Additionally, the use of natural (BSEM, NSEM) and synthetic (OLI) oligotrophic media showed a lower actinobacterial diversity when compared with non-oligotrophic media (SIMA1, BCM, BTM, HA). This fact is in accordance with the reduced nutrient concentrations of these media. Despite the nutritive limitation, OLI medium was the most successful oligotrophic medium, being able to recover 8 different actinobacterial phylotypes distributed in 6 genera. Medium

Table 3 *Actinobacteria* genera isolated from different samples from Easter Island, indicating the number of isolates (first number) and of phylotypes (second number) for each genus

Genus	Sample													
	SN3 Zone 1	SN6 Zone 1	SN7 Zone 1	SN8 Zone 1	SN10 Zone 1	SN20 Zone 2	SN21 Zone 3	SN22 Zone 5	SN23 Zone 5	SN25 Zone 6	SN26 Zone 6	SN27 Zone 6	SN28 Zone 6	
<i>Actinomycetospora</i>	–	–	–	–	–	–	–	–	–	1-1	–	–	–	
<i>Aeromicrobium</i>	–	–	2-1	–	–	–	–	–	–	–	–	3-1	–	
<i>Arthrobacter</i>	–	–	–	–	–	–	–	–	–	–	11-2	–	–	
<i>Blastococcus</i>	–	–	–	–	–	–	–	–	–	4-1	–	2-1	–	
<i>Cellulosimicrobium</i>	–	–	–	–	–	–	–	–	–	–	2-1	–	–	
<i>Dactylosporangium</i>	5-2	–	–	–	–	–	–	–	–	–	–	–	–	
<i>Dietzia*</i>	–	–	–	–	–	–	–	–	–	3-1	2-1	11-1	–	
<i>Geodermatophilus</i>	–	–	–	–	–	–	–	–	–	2-1	–	–	–	
<i>Marmoricola</i>	–	–	–	–	–	–	–	–	–	2-1	–	–	–	
<i>Microbacterium</i>	–	–	–	–	–	–	–	–	–	1-1	–	–	–	
<i>Micromonospora**</i>	2-2	6-3	–	1-1	4-2	6-3	–	2-2	1-1	11-7	3-3	23-4	1-1	
<i>Nocardioides</i>	–	4-1	–	–	–	–	–	–	–	1-1	–	–	–	
<i>Nocardioopsis</i>	–	–	–	–	–	2-1	–	–	–	–	–	–	–	
<i>Nonomuraea</i>	–	–	–	1-1	–	–	–	–	–	–	–	–	1-1	
<i>Ornithinimicrobium</i>	–	–	–	–	–	–	–	–	–	–	–	1-1	–	
<i>Rhodococcus</i>	–	–	–	–	–	–	–	–	–	1-1	1-1	–	–	
<i>Salinispora***</i>	–	–	–	–	1-1	1-1	1-1	1-1	–	2-1	–	1-1	–	
<i>Streptomyces****</i>	–	1-1	–	–	–	2-2	–	–	–	4-4	2-1	6-4	9-7	
<i>Verrucosipora</i>	–	–	–	–	–	–	–	–	–	–	7-1	–	–	
<i>Yimella</i>	–	–	–	–	–	–	–	–	–	2-1	–	–	–	
Total	7-4	11-5	2-1	2-2	5-3	11-7	1-1	3-3	1-1	34-21	28-10	47-13	11-9	

Samples SN1, SN5, and SN11 did not reveal any actinobacterial isolate

*Samples SN25 and SN27 shared the same phylotype

**All the samples but SN22 shared phylotypes

***Only 1 phylotype in all the samples

****Two phylotypes were repeated in samples SN25 and SN28

BSEM yielded the isolation of 7 phylotypes distributed in 5 genera, while medium NSEM did not produce any actinobacterial isolates. OLI medium contained carbohydrates, but the concentration levels were low in comparison with those found in SIMA1, BCM, and BTM. OLI medium mimics an ocean oligotrophic situation with carbon source concentrations in the order of 0.0013 g/L in average, quite low when compared with other media (SIMA1, BCM, and BTM).

We recovered a number of isolates which are closely related or identified as specific marine taxa by using media with an intermediate high salinity (2.5%). Among these were *Salinispora arenicola*, *Nonomuraea maritima*, *Micromonospora sediminicola*, *Blastococcus aggregatus*, and *Streptomyces nanshensis*. However, a combination of high salinity (3.5%) and low availability of nutrients seemed to be detrimental for the isolation of *Actinobacteria*, as medium NSEM showed. Our data also revealed that several *Actinobacteria* previously described from soil samples were obtained from our marine samples. Finally, Table 2 and Fig. 2 show culture media yield and specificity.

Actinobacteria diversity

Using different culture media, we obtained 163 bacterial isolates from the Easter Island, which belong to 20 different genera and represent 72 different phylotypes. The number of isolates and phylotypes of the genera is shown in Table 3.

The 5 most abundant genera dwelling in the studied area were *Micromonospora* (60 isolates), *Streptomyces* (24 isolates), *Dietzia* (16 isolates), *Arthrobacter* (11 isolates), and *Salinispora* (7 isolates). Based on 16S rRNA gene sequences, the highest number of phylotypes was found in the genus *Micromonospora* (29). Representatives of *Micromonospora* were isolated from 11 out of 16 samples, and the number of phylotypes which can be regarded as the number of species isolated from Easter Island represents 34.5% of all species of this genus described so far (29 out of 84). This suggests that Easter Island is a hotspot for *Micromonospora* species.

Another abundant genus was *Streptomyces* with 17 phylotypes affiliating to 2.0% of all known *Streptomyces* species (17 out of 842). Although a rather small number of *Streptomyces* representatives were isolated, it is important to recall the immense number of species described of this genus, as a result of public and private initiatives which primarily aimed drug discovery (Hopwood 2007). Thus, *Streptomyces* is an exception in relation with the other actinobacterial genera (i.e., *Micromonospora*, 82 type strains) due to the large the number of available type strains.

The occurrence of *Verrucosipora*, *Dactylosporangium*, *Yimella*, *Ornithinimicrobium*, *Nocardiopsis*, *Microbacterium*, *Marmoricola*, *Geodermatophilus*, *Cellulosimicrobium*, *Actinomycesetospira*, and *Arthrobacter* was sample specific, since the isolation of these genera was restricted to single

samples (Table 3). The members of a larger number of genera (*Aeromicrobium*, *Blastococcus*, *Dietzia*, *Micromonospora*, *Nocardioides*, *Nonomuraea*, *Rhodococcus*, *Salinispora*, and *Streptomyces*) were isolated from more than one sample. The widest distribution in the studied area with isolates from different samples and also sampling sites was found by the representatives of *Aeromicrobium*, *Nocardioides*, *Nonomuraea*, *Micromonospora*, *Salinispora*, and *Streptomyces*.

16S rRNA gene sequence similarity, phylogenetic characterization, and uniqueness

By aligning our sequences with BLAST-NCBI database, and using type strain only, we determined that 50 out 72 isolated phylotypes shared $\geq 99\%$ similarity of 16S ribosomal RNA gene sequences to type strains, while 22 out 72 showed lower sequence similarity, ranging from 94 to 98%. Thirteen phylotypes had 98%, 5 phylotypes had 97%, 2 phylotypes had 96%, and 2 phylotypes had 94% (Table 4).

In order to analyze the phylogenetic relationships, just one representative strain per phylotype (according to affinity trees) was selected. Different phylogenetic trees are presented for *Micromonospora* and *Streptomyces* genera and the other *Actinobacteria* (Figs. 3, 4, and 5). *Micromonospora* was the most abundant genus found in our samples, with 60 isolates belonging to 29 phylotypes. According to the phylogenetic tree (Fig. 3), only 42% of the *Micromonospora* isolates from the Easter Island are closely associated with related type strains, while 58% showed poor association (SN28_51.1, SN27_670.1, SN10_5.1, SN22_5.1, SN26_25.1, SN27_101B.1, SN27_669.1, SN27_39.1, SN26_100.1, SN3_4.1, SN6_8.1, SN6_55.1, SN23_2.1, SN10_77.1, SN8_22.1, SN6_25.1, and SN25_6.1) and potentially represent new species.

In the case of *Streptomyces*, 24 isolates were obtained, which were distributed into 17 phylotypes according to sequence similarity. By evaluating the phylogenetic tree, we obtained that 65% of the Easter Island phylotypes were closely affiliated with type strains (97–99% sequence similarity) (Fig. 4), while 35% might belong to new *Streptomyces* species with 97–99% sequence similarity (SN28_94.1, SN28_50.1, SN20_12.1, SN27_5.1, SN28_222.1, and SN25_508.1).

Most of the other actinobacterial isolates from Easter Island showed a high 16S rRNA gene sequence similarity and clustered with type strains of known species. Therefore, they quite likely are strains of these species and identified as such (Fig. 5). Quite some of our isolates do, however, show significant differences in the 16S rRNA gene sequences, and these may be considered to represent new taxa.

Most significantly, isolate SN27_500.1 represents an interesting case, because it has only 96% sequence similarity to *Ornithinimicrobium kibberense* DSM 17687^T and

Table 4 First match of BLAST-NCBI comparison using 16S rRNA gene sequence. Only type strains were used for the determination of the next related type strain

Phylotype	16S rRNA sequence length (nt)	Genbank acc. no.	Next related type strain	Similarity %
SN27_9.1	1474	MH299440	<i>Salinispora arenicola</i> DSM 44819 ^T	100
SN20_15.1	1049	MH299453	<i>Micromonospora sediminicola</i> NBRC 107934 ^T	100
SN25_555.1	1340	MH299425	<i>Actinomycetospira straminea</i> JCM 17983 ^T	99
SN27_135A.1	1473	MH299426	<i>Aeromicrobium choanae</i> CCM 8650 ^T	99
SN26_23.1	1338	MH299428	<i>Arthrobacter koreensis</i> JCM 12361 ^T	99
SN26_101.1	1476	MH299430	<i>Cellulosimicrobium funkei</i> DSM 16025 ^T	99
SN25_202.1	1334	MH299431	<i>Blastococcus aggregatus</i> DSM 4725 ^T	99
SN3_2.1	1472	MH299433	<i>Dactylosporangium luteum</i> DSM 45324 ^T	99
SN3_3.1	1473	MH299434	<i>Dactylosporangium maewongense</i> JCM 15933 ^T	99
SN26_13.1A	1471	MH299435	<i>Dietzia cinnamea</i> DSM 44904 ^T	99
SN27_100.1	1475	MH299436	<i>Dietzia schimae</i> DSM 45139 ^T	99
SN25_10.1	1335	MH299437	<i>Geodermatophilus tzadiensis</i> DSM 45416 ^T	99
SN20_9.1	1336	MH299441	<i>Nocardiopsis dassonvillei</i> DSM 43111 ^T	99
SN28_40.1	1469	MH299443	<i>Nonomuraea jabiensis</i> DSM 45507 ^T	99
SN26_12.1	1475	MH299445	<i>Rhodococcus soli</i> DSM 46662 ^T	99
SN26_15.1	1477	MH299449	<i>Verrucosipora maris</i> DSM 45365 ^T	99
SN10_5.1	1473	MH299451	<i>Micromonospora chokoriensis</i> JCM 13247 ^T	99
SN10_77.1	1334	MH299452	<i>Micromonospora auratinigra</i> DSM 44815 ^T	99
SN20_17.1	1330	MH299454	<i>Micromonospora aurantiaca</i> DSM 43813 ^T	99
SN20_19.1	1325	MH299455	<i>Micromonospora auratinigra</i> DSM 44815 ^T	99
SN22_1.1	1322	MH299456	<i>Micromonospora schwarzwaldensis</i> DSM 45708 ^T	99
SN22_5.1	1307	MH299457	<i>Micromonospora krabiensis</i> DSM 45344 ^T	99
SN23_2.1	1330	MH299458	<i>Micromonospora auratinigra</i> DSM 44815 ^T	99
SN25_201.1	1332	MH299459	<i>Micromonospora purpureochromogenes</i> DSM 43821 ^T	99
SN25_3.1	1330	MH299460	<i>Micromonospora coxensis</i> JCM 13248 ^T	99
SN25_4.1	1209	MH299461	<i>Micromonospora chokoriensis</i> JCM 13247 ^T	99
SN25_5.1	1330	MH299462	<i>Micromonospora chokoriensis</i> JCM 13247 ^T	99
SN25_52.1	1470	MH299463	<i>Micromonospora tulbaghia</i> DSM 45142 ^T	99
SN25_6.1	1330	MH299464	<i>Micromonospora peucetia</i> DSM 43363 ^T	99
SN25_800.1	1466	MH299465	<i>Micromonospora auratinigra</i> DSM 44815 ^T	99
SN26_110.1	1330	MH299467	<i>Micromonospora echinospora</i> DSM 43816 ^T	99
SN26_25.1	1417	MH299468	<i>Micromonospora rifamycinica</i> DSM 44983 ^T	99
SN27_669.1	1330	MH299471	<i>Micromonospora aurantiaca</i> DSM 43813 ^T	99
SN27_670.1	1469	MH299472	<i>Micromonospora chokoriensis</i> JCM 13247 ^T	99
SN28_51.1	1336	MH299473	<i>Micromonospora chokoriensis</i> JCM 13247 ^T	99
SN3_1.1	1471	MH299474	<i>Micromonospora rifamycinica</i> DSM 44983 ^T	99
SN3_4.1	1329	MH299475	<i>Micromonospora pattaloongensis</i> JCM 12833 ^T	99
SN6_25.1	1468	MH299476	<i>Micromonospora echinospora</i> DSM 43816 ^T	99
SN6_55.1	1328	MH299477	<i>Micromonospora auratinigra</i> DSM 44815 ^T	99
SN8_22.1	1470	MH299479	<i>Micromonospora auratinigra</i> DSM 44815 ^T	99
SN20_4.1	1172	MH299481	<i>Streptomyces peucetius</i> DSM 40754 ^T	99
SN25_55.1	1341	MH299483	<i>Streptomyces nanshensis</i> SCSIO 01066 ^T	99
SN25_8.1	1339	MH299484	<i>Streptomyces fulvissimus</i> DSM 40593 ^T	99
SN26_22.1	1335	MH299485	<i>Streptomyces drozdowiczii</i> JCM 13580 ^T	99
SN27_300.1	1340	MH299486	<i>Streptomyces rimosus</i> DSM 40260 ^T	99
SN28_1.1	1337	MH299489	<i>Streptomyces champavatii</i> DSM 40841 ^T	99
SN28_3.1	1342	MH299491	<i>Streptomyces lydicus</i> ATCC 25470 ^T	99
SN28_4.1	1339	MH299492	<i>Streptomyces cyslabdanicus</i> DSM 42135 ^T	99
SN28_50.1	1346	MH299493	<i>Streptomyces chilikensis</i> DSM 42072 ^T	99
SN6_2.1	1338	MH299496	<i>Streptomyces chumphonensis</i> JCM 18522 ^T	99
SN27_51.1	1330	MH299432	<i>Blastococcus saxobsidens</i> DSM 44509 ^T	98
SN26_6.1	1481	MH299429	<i>Arthrobacter arilaitensis</i> DSM 16368 ^T	98
SN8_2.1	1135	MH299442	<i>Nonomuraea maritima</i> NBRC 106687 ^T	98
SN25_54.1	1339	MH299444	<i>Rhodococcus phenolicus</i> DSM 44812 ^T	98
SN25_300.1	1336	MH299446	<i>Marmoricola bigeumensis</i> DSM 19426 ^T	98
SN25_203.1	1343	MH299447	<i>Microbacterium thalassium</i> DSM 12511 ^T	98
SN25_53.1	1340	MH299450	<i>Yimella lutea</i> YIM 45900 ^T	98
SN26_100.1	1364	MH299466	<i>Micromonospora purpureochromogenes</i> DSM 43821 ^T	98
SN27_101B.1	1458	MH299469	<i>Micromonospora aurantiaca</i> DSM 43813 ^T	98
SN6_8.1	1349	MH299478	<i>Micromonospora pattaloongensis</i> DSM 43821 ^T	98
SN20_12.1	1323	MH299480	<i>Streptomyces panacagri</i> DSM 41871 ^T	98
SN27_5.1	1339	MH299488	<i>Streptomyces albus subsp. albus</i> DSM 40313 ^T	98
SN28_94.1	1226	MH299495	<i>Streptomyces fragilis</i> DSM 40044 ^T	98
SN27_39.1	1174	MH299470	<i>Micromonospora aurantiaca</i> DSM 43813 ^T	97

Table 4 (continued)

Phylotype	16S rRNA sequence length (nt)	Genbank acc. no.	Next related type strain	Similarity %
SN25_508.1	1342	MH299482	<i>Streptomyces marinus</i> DSM 41968 ^T	97
SN27_3.1	1299	MH299487	<i>Streptomyces deserti</i> KACC 15425 ^T	97
SN28_222.1	1336	MH299490	<i>Streptomyces marinus</i> DSM 41968 ^T	97
SN28_52.1	1351	MH299494	<i>Streptomyces macrosporus</i> NBRC 14748 ^T	97
SN25_200.1	1289	MH299438	<i>Nocardioides iriomotensis</i> JCM 17985 ^T	96
SN27_500.1	1478	MH299448	<i>Ornithinimicrobium kibberense</i> DSM 17687 ^T	96
SN7_3.1	1336	MH299427	<i>Aeromicrobium erythreum</i> DSM 8599 ^T	94
SN6_7.1	1437	MH299439	<i>Nocardioides exalbidus</i> JCM 23199 ^T	94

nt nucleotides

additionally formed a separate branch related to clusters of the genera *Ornithinimicrobium* and *Serinicoccus* in the phylogenetic tree (Fig. 5) which indicates that this isolate may represent a new genus of the *Actinobacteria*.

One of the two *Blastococcus* phylotypes obtained from Easter Island (isolate SN27_51.1) shared 98% of

similarity with *B. saxobsidens* DSM 44509^T and did not show close affinity to this reference strain in the phylogenetic tree, suggesting novelty. Similarly, one *Arthrobacter* isolate SN26_6.1 showed divergence from the related type strain, *A. protophormiae* DSM 20168^T, in the phylogenetic tree, as well as in the BLAST

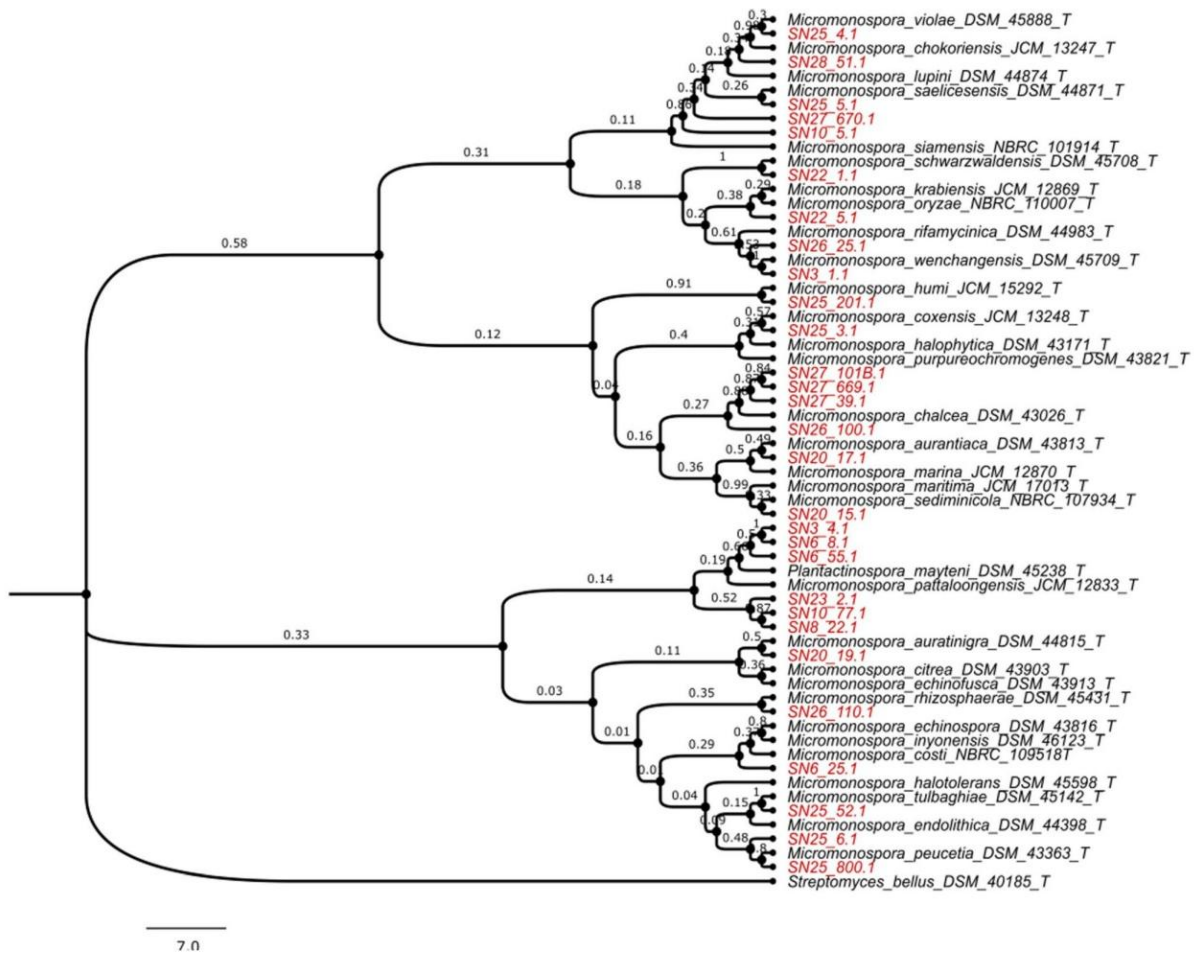

Fig. 3 Phylogenetic analysis of *Micromonospora* sp. isolates and *Micromonospora* sp. type strains by maximum likelihood method based on the Kimura 2-parameter model. Bootstrap: 1000 replicates. Red letters:

Easter Island *Micromonospora* sp. phylotypes. Black letters: *Micromonospora* sp. type strains. Scale bar: length is a function of nucleotide difference. *T* type strain

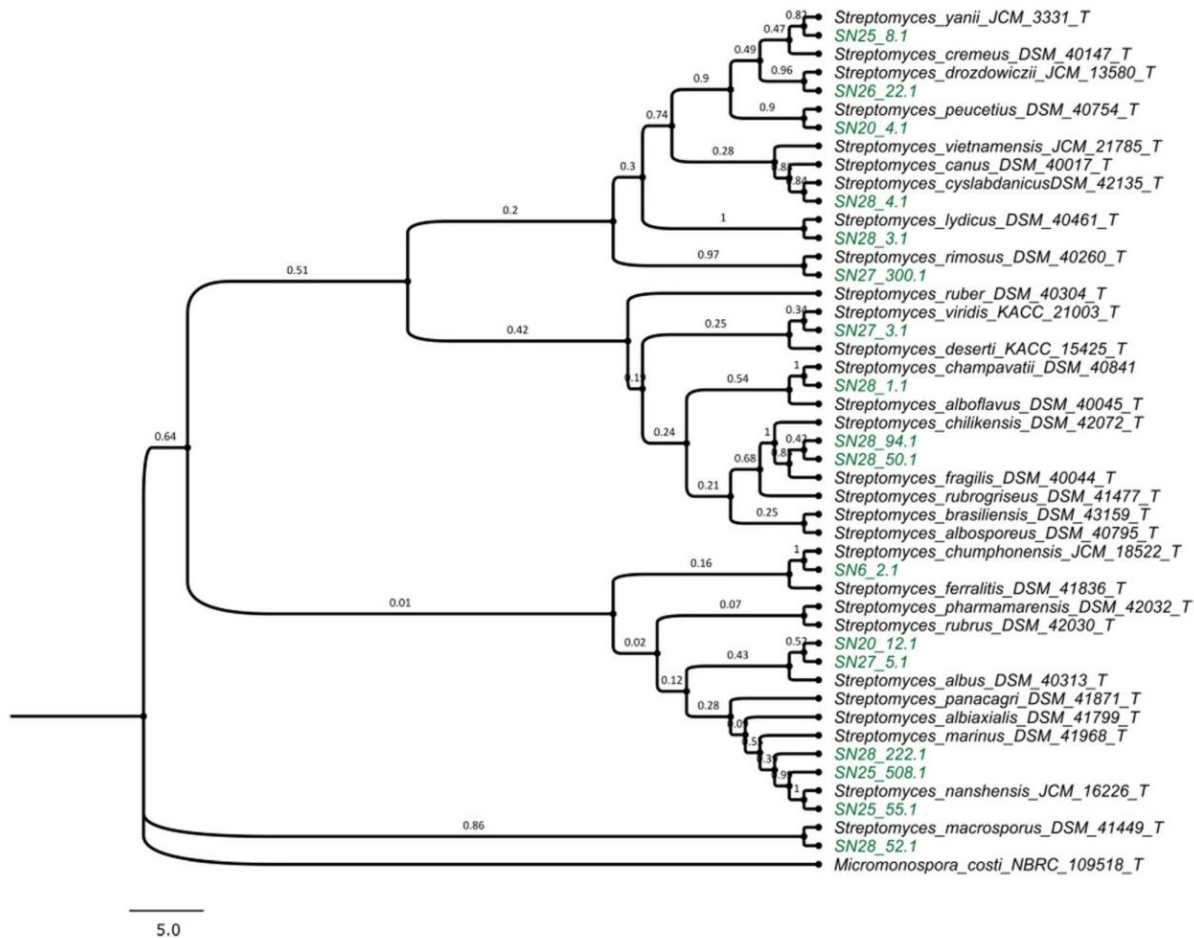

Fig. 4 Phylogenetic analysis of *Streptomyces* sp. isolates by maximum likelihood method based on the Tamura-Nei model. Bootstrap: 1000 replicates. Green letters: Easter Island *Streptomyces* sp. phylotypes. Black

letters: *Streptomyces* sp. type strains. Scale bar: length is a function of nucleotide difference. *T* type strain

analysis. *Dactylosporangium* isolates also (SN3_2.1, SN3_3.1) showed poor association with related type strains. *Nonomuraea* isolate SN8_2.1 did not match the branch of its reference strain, *N. maritima* NBRC 106687^T, suggesting phylogenetic differentiation. The 16S rRNA sequence similarity of 98% may support this statement. Furthermore, two *Aeromicrobium* isolates (SN7_3.1 and SN27_135A.1) showed poor association to the type strains of *A. choanae* CCM 8650^T and *A. erythreum* DSM 8599^T. The sequence of *Dietzia* isolate SN27_100.1 was separated from *D. schimae* DSM 1111^T in the tree despite having 99% of similarity, evidencing a disagreement with the phylogenetic evaluation and the BLAST analysis. Similarly, *Verrucosipora* sp. SN26_15.1 showed divergence from the next related type strain in the phylogenetic tree, despite close similarity of 16S rRNA sequence to *Verrucosipora maris* DSM 45365^T, by which it may represent a new species.

Discussion

The coastal zone of Easter Island presented a high *Actinobacteria* diversity with *Micromonospora* and *Streptomyces* as the most abundant genera dwelling in this territory. The predominance of these 2 genera is in accordance with other studies in marine (Maldonado et al. 2009) and terrestrial environments (Nimaichand et al. 2015). The diversity of Easter Island *Actinobacteria* at the genus level (18 different genera at one hot spot location) was higher compared to examples from other studies, with 9 genera of a terrestrial habitat (Nimaichand et al. 2015), 12 genera from a marine source (Maldonado et al. 2009), 5 genera from marine invertebrates (Jiang et al. 2007; Schneemann et al. 2010), 1 genus from insects (Arango et al. 2016), and 12 genera from plants (Nimaichand et al. 2015).

Culture media was an inflection point for the success in the number of isolates, phylotypes, and genera. Our data indicated that complex sugars as well as reduced

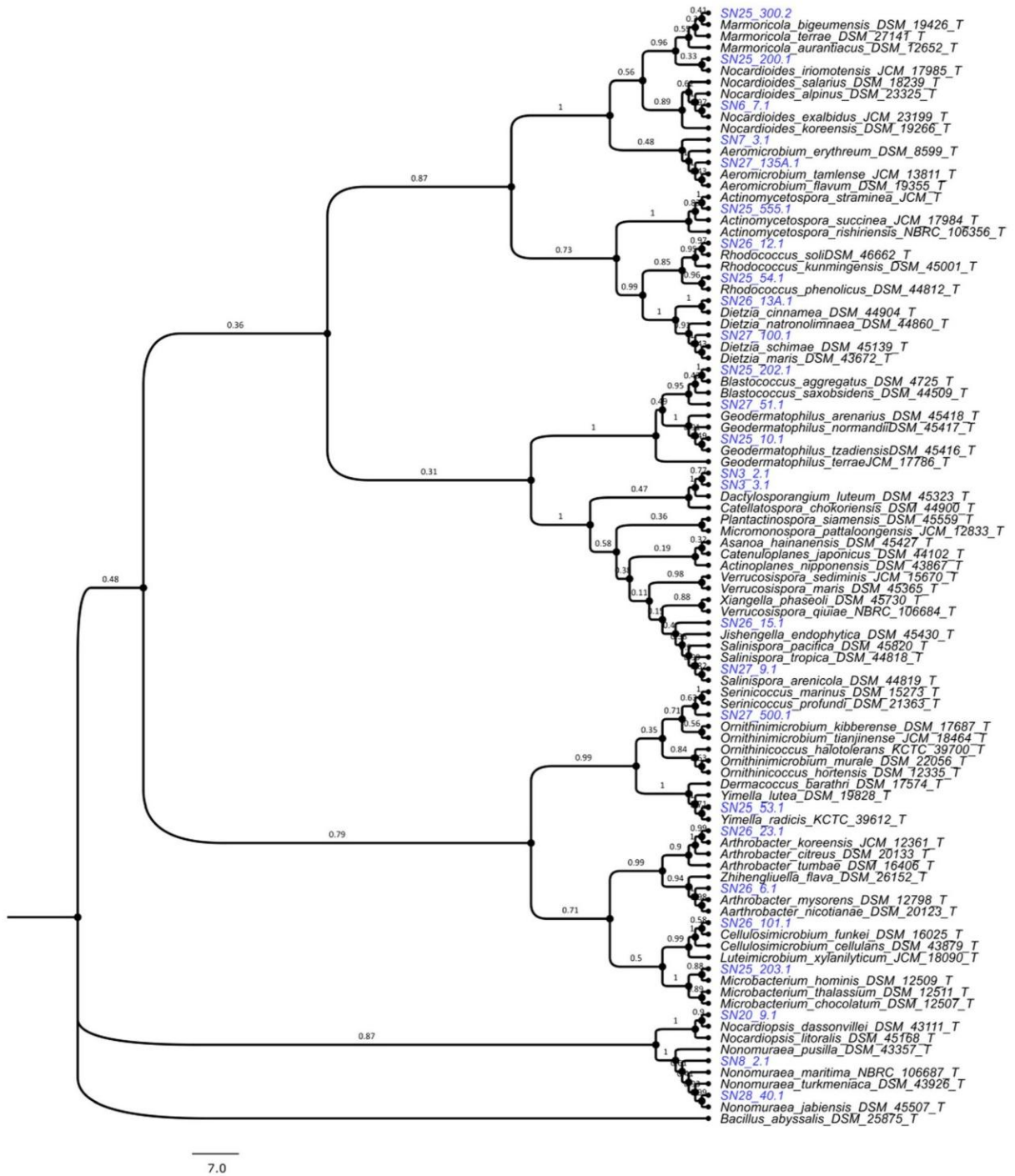

Fig. 5 Phylogenetic analysis of 16S rRNA gene sequences from *Actinobacteria* isolates by the maximum likelihood method based on the Kimura 2-parameter model. Bootstrap: 1000 replicates. Blue letters:

Easter Island actinobacterial phylotypes excluding *Micromonospora* and *Streptomyces*. Black letters: *Actinobacteria* type strains. Scale Bar: Length is a function of nucleotide difference. *T* type strain

concentrations of nitrogen sources were optimal for a high actinobacterial recovery. The optimal concentrations of carbohydrates were in the range of 1–3 g/L of carbon source

and 0.1–1.0 g/L of nitrogen sources. The data suggest that there was not a single optimal medium, rather it was found that the usage of a wide variety of media compositions was

the most relevant point to capture a really high diversity overall.

Salinity played a key role for the isolation of strains affiliating to marine-derived *Actinobacteria*, although a significant number of previously described soil-dwelling *Actinobacteria* was also obtained. Despite the fact that the media differed in kind of nutrients and nutrient concentrations, the data suggest that the salinity may have a specific effect on the isolation of kind and number of different phylotypes. For example, medium SIMA1 with 25 g/L of tropic marine salt produced 25 phylotypes distributed in 14 genera, medium BCM with 15 g/L tropic marine salt produced 20 phylotypes, distributed in 8 genera, medium BTM with 15 g/L tropic marine salt produced 18 phylotypes distributed in 8 genera, medium HA without salt added produced 8 phylotypes distributed in 8 genera, medium OLI with 25 g/L of NaCl and addition of other salts produced 8 phylotypes distributed in 6 genera, medium BSEM with 15 g/L (Baltic Sea salinity) produced 7 phylotypes distributed in 5 genera, and NSEM with 35 g/L (North Sea salinity) did not produce any isolate.

Oligotrophic media showed a different result, where an artificially prepared medium (medium OLI) was able to recover 6 different actinobacterial genera. Baltic Sea oligotrophic media (BSEM) was also able to recover actinobacterial representatives but in a relative minor level, since it yielded only representatives of 5 genera. Contrasting with these two prior oligotrophic media, the North Sea oligotrophic medium was unable to recover any actinobacterial representative. BSEM and NSEM were equally enriched with tyrosine and galactose. The main difference was based on natural components of the different sea water sources as well as salinity. It could be possible that a high degree of salinity (35 g/L) and a low level of nutrients resulted in a detrimental condition for *Actinobacteria*.

It should be noted that Easter Island represents an abundant *Actinobacteria* niche only through the evaluation of multiples samples from a different marine origin, and by the use of multiple culture media. These two conditions were quite important for a successful recovery of actinobacterial diversity. Nevertheless, a few exceptions can also be named, like the case of zone 6 with samples SN25, SN26, SN27, and SN28, which represented the highest abundance and diversity among the sample sites.

Among the isolates obtained from the genera *Aeromicrobium*, *Arthrobacter*, *Blastococcus*, *Dietzia*, *Dactylosporangium*, *Nonomuraea*, *Ornithinimicrobium*, and *Verrucosipora*, 1 or 2 phylotypes of each may possibly represent new species or even genera, if their genetic relationship (16S rRNA gene sequences) to the related type strains is considered (Figs. 3, 4, and 5). In the case of *Streptomyces*, 6 out of 17 *Streptomyces* phylotypes, and in the case of *Micromonospora*, 17 out of 29 phylotypes might be candidates of new species. On the other hand, 55% of our isolates were affiliated to known actinobacterial taxa, thus indicating

that *Actinobacteria* may have a wide global distribution at the species level.

Finally, we have to state that most likely the actual diversity is much higher than found in the present work. Due to the low abundance of some of the *Actinobacteria*, due to the specific nutrient requirement of some of them and the limited basis of conditions given by the selected culture conditions some specialists and *Actinobacteria* with very low abundance may not have been detected by this approach. However, the specific pretreatment of the samples acts as a kind of enrichment and preselection for *Actinobacteria* and quite likely increases the detection limit of those present in very low abundance. In addition, other selection procedures, such as the use of complex sugar-based media, low nutrient concentrations, variation of salinity, and addition of specific antibiotics can improve the selectivity for *Actinobacteria*, as this and other studies have demonstrated (Dorador et al. 2008). In contrast, metagenomic studies face several limitations which may not be prevented, and that can underestimate the actinobacterial diversity, such as non-suitable primers (Farris and Olson 2007), high G-C content (Varadaraj and Skinner 1994), poor lysis of cells and limited DNA extraction (Yang et al. 2015), disproportional bacterial abundance (Lynch and Neufeld 2015; Sahl et al. 2015), short 16S rRNA sequences (Yuan et al. 2015), lack of reference sequences for appropriate assignment (Menzel et al. 2016), and computational limitations and script specificity (Poussin et al. 2018). Although several of these limitations may be overcome by metagenomic genome analysis, the very low abundance of some of the *Actinobacteria* and the problems with DNA extraction from environmental samples give a clear disadvantage to the metagenomic approach compared to the culture approach. Therefore, the culture approach remains a valuable way to analyze the diversity of *Actinobacteria* in environmental samples, though these may be complemented by metagenomic data.

Conclusion

This first comprehensive study on the cultured diversity of *Actinobacteria* from Easter Island and Polynesia demonstrated an outstanding high diversity with apparently low abundance and high specificity in community composition of different sampling sites along the shoreline of the island. One hundred sixty-three isolates were grouped into 72 phylotypes within 20 different actinobacterial genera. According to 16S rRNA sequence data, 32 phylotypes quite likely represent new species, including 1 potential new genus (isolate SN27_500.1). The overall high diversity found is explained as the result of the wide array of media and nutritive sources used for isolation, and also by the number of samples taken all around the island. In terms of geographical distribution of *Actinobacteria* on Easter Island, it was observed that it varies

from hot spots in which 18 different genera coexist to other sites in which only 1 or 2 genera were found. The genera with the highest frequency among the samples were *Micromonospora*, *Streptomyces*, and *Salinispora*, while other genera were sample specific. The cultivation procedure and media were an inflection point between a high and poor *Actinobacteria* recovery, where medium SIMA1 (starch, yeast extract, peptone, 25 g/L salinity) yielded the highest number and diversity of isolates. Remarkable, we found that salinity played a key role for the isolation of marine-derived actinobacterial diversity. Finally, Easter Island showed to be an exceptional place to investigate microbial diversity due to the geographic isolation and outstanding degree of actinobacterial novelty.

Acknowledgments We show our gratitude to the Centre for Molecular Biology at Kiel University (IKMB) for the DNA sequencing support. We also thank Tanja Rahn for technical assistance. We thank Prof. Ute Hentschel Humeida (GEOMAR Helmholtz Centre for Ocean Research Kiel) and Prof. Frank Sönnichsen (Institut für Organische Chemie at Christian-Albrechts-Universität zu Kiel) for their fruitful feedback for the present work. Finally, I.S. thanks Millaray Sierra for her support during the research.

Funding information We thank the Deutscher Akademischer Austauschdienst (DAAD) and Helmholtz association for the financial support.

Compliance with ethical standards

Conflict of interest The authors declare that they have no conflict of interest.

Publisher's note Springer Nature remains neutral with regard to jurisdictional claims in published maps and institutional affiliations.

References

- Abdelmohsen UR, Pimentel-Elardo SM, Hanora A, Radwan M, Abou-El-Ela SH, Ahmed S, Hentschel U (2010) Isolation, phylogenetic analysis and anti-infective activity screening of marine sponge-associated actinomycetes. *Mar Drugs* 8:399–412
- Altschul SF, Gish W, Miller W, Myers EW, Lipman DJ (1990) Basic local alignment search tool. *J Mol Biol* 215:403–410
- Arango RA, Carlson CM, Currie CR, McDonald BR, Book AJ, Green F 3rd, Lebow NK, Raffa KF (2016) Antimicrobial activity of *Actinobacteria* isolated from the guts of subterranean termites. *Environ Entomol* 45:1415–1423
- Babalola OO, Kirby BM, Le Roes-Hill M, Cook AE, Cary SC, Burton SG, Cowan DA (2009) Phylogenetic analysis of actinobacterial populations associated with Antarctic Dry Valley mineral soils. *Environ Microbiol* 11:566–576
- Barnes SS, Matisoo-Smith E, Hunt TL (2006) Ancient DNA of the Pacific rat (*Rattus exulans*) from Rapa Nui (Easter Island). *J Archaeol Sci* 33:1536–1540
- Casanova M, Salazar O, Seguel O, Luzio W (2013) Main features of Chilean soils. In: *The soils of Chile*. Springer Netherlands, Dordrecht, pp 25–97. https://doi.org/10.1007/978-94-007-5949-7_2
- Cole JR, Wang Q, Fish JA, Chai B, McGarrell DM, Sun Y, Brown CT, Porras-Alfaro A, Kuske CR, Tiedje JM (2013) Ribosomal Database Project: data and tools for high throughput rRNA analysis. *Nucleic Acids Res* 42:D633–D642
- Cumsille A, Undabarrena A, González V, Claverías F, Rojas C, Cámara B (2017) Biodiversity of Actinobacteria from the South Pacific and the assessment of *Streptomyces* chemical diversity with metabolic profiling. *Mar Drugs* 15:286
- Dorador C, Busekew A, Vila I, Imhoff JF, Witzel K-P (2008) Molecular analysis of enrichment cultures of ammonia oxidizers from the Salar de Huasco, a high altitude saline wetland in northern Chile. *Extremophiles* 12:405–414
- Ellis RJ, Morgan P, Weightman AJ, Fry JC (2003) Cultivation-dependent and -independent approaches for determining bacterial diversity in heavy-metal-contaminated soil. *Appl Environ Microbiol* 69:3223–3230
- Farris MH, Olson JB (2007) Detection of Actinobacteria cultivated from environmental samples reveals bias in universal primers. *Lett Appl Microbiol* 45:376–381
- Frank JA, Reich CI, Sharma S, Weisbaum JS, Wilson BA, Olsen GJ (2008) Critical evaluation of two primers commonly used for amplification of bacterial 16S rRNA genes. *Appl Environ Microbiol* 74:2461–2470
- Glynn PW, Wellington GM, Riegl B, Olson DB, Bormeman E, Wieters EA (2007) Diversity and biogeography of the scleractinian coral fauna of Easter Island (Rapa Nui). *Pac Sci* 61:67–90
- Goodfellow M, Fiedler H-P (2010) A guide to successful bioprospecting: informed by actinobacterial systematics. *Antonie Van Leeuwenhoek* 98:119–142
- Grau J (1996) Jubaea, the palm of Chile and Easter Island? *Rapa Nui J* 10:37–40
- Hayakawa M, Nonomura H (1987) Humic acid-vitamin agar, a new medium for the selective isolation of soil actinomycetes. *J Ferment Technol* 65:501–509
- Hopwood DA (2007) *Streptomyces* in nature and medicine: the antibiotic makers. Oxford University Press, Oxford, New York
- Hunt TL, Lipo CP (2006) Late colonization of Easter Island. *Science* 311:1603–1606
- Jiang S, Sun W, Chen M, Dai S, Zhang L, Liu Y, Lee KJ, Li X (2007) Diversity of culturable actinobacteria isolated from marine sponge *Haliclona* sp. *Antonie Van Leeuwenhoek* 92:405–416
- Kaltenpoth M (2009) Actinobacteria as mutualists: general healthcare for insects? *Trends Microbiol* 17:529–535
- Kohn AJ, Lloyd MC (1973) Marine polychaete annelids of Easter Island. *Int Rev Hydrobiol* 58:691–712
- Kopf A, Bica M, Kottmann R, Schnetzler J, Kostadinov I, Lehmann K, Fernandez-Guerra A, Jeanthon C, Rahav E, Ullrich M, Wichels A, Gerdt G, Polymenakou P, Kotoulas G, Siam R, Abdallah RZ, Sonnenschein EC, Cariou T, O'Gara F, Jackson S, Orlic S, Steinke M, Busch J, Duarte B, Caçador I, Canning-Clode J, Bobrova O, Marteinsson V, Reynisson E, Loureiro CM, Luna GM, Quero GM, Löscher CR, Kremp A, DeLorenzo ME, Øvreås L, Tolman J, LaRoche J, Penna A, Frischer M, Davis T, Katherine B, Meyer CP, Ramos S, Magalhães C, Jude-Lemeilleur F, Aguirre-Macedo ML, Wang S, Poulton N, Jones S, Collin R, Fuhrman JA, Conan P, Alonso C, Stambler N, Goodwin K, Yakimov MM, Baltar F, Bodrossy L, van de Kamp J, Frampton DMF, Ostrowski M, van Ruth P, Malthouse P, Claus S, Deneudt K, Mortelmans J, Pitois S, Wallom D, Salter I, Costa R, Schroeder DC, Kandil MM, Amaral V, Biancalana F, Santana R, Pedrotti ML, Yoshida T, Ogata H, Ingleton T, Munnik K, Rodriguez-Ezpeleta N, Berteaux-Lecellier V, Wecker P, Cancio I, Vault D, Bienhold C, Ghazal H, Chaouni B, Essayeh S, Ettamimi S, Zaid EH, Boukhatem N, Bouali A, Chahboune R, Barrijal S, Timinouni M, el Otmani F, Bennani M, Mea M, Todorova N, Karamfilov V, ten Hoopen P, Cochrane G, L'Haridon S, Bizsel KC, Vezzi A, Lauro FM, Martin P, Jensen RM, Hinks J,

- Gebbels S, Rosselli R, de Pascale F, Schiavon R, dos Santos A, Villar E, Pesant S, Cataletto B, Malfatti F, Edirisinghe R, Silveira JAH, Barbier M, Turk V, Tinta T, Fuller WJ, Salihoglu I, Serakinci N, Ergoren MC, Bresnan E, Iriberrí J, Nyhus PAF, Bente E, Karlsen HE, Golyshin PN, Gasol JM, Moncheva S, Dzhenbekova N, Johnson Z, Sinigalliano CD, Gidley ML, Zingone A, Danovaro R, Tsiamis G, Clark MS, Costa AC, el Bour M, Martins AM, Collins RE, Ducluzeau AL, Martinez J, Costello MJ, Amaral-Zettler LA, Gilbert JA, Davies N, Field D, Glöckner FO (2015) The ocean sampling day consortium. *GigaScience* 4:27
- Lane D (1991) 16S/23S rRNA sequencing. In: Stackebrandt E, Goodfellow M (eds) *Nucleic acid techniques in bacterial systematics*. Wiley, Chichester, pp 115–175
- Lynch MDJ, Neufeld JD (2015) Ecology and exploration of the rare biosphere. *Nat Rev Microbiol* 13:217–229
- Mahmoud HM, Kalendar AA (2016) Coral-associated Actinobacteria: diversity, abundance, and biotechnological potentials. *Front Microbiol* 7:204
- Maldonado LA, Stach JEM, Pathom-aree W, Ward AC, Bull AT, Goodfellow M (2005) Diversity of cultivable actinobacteria in geographically widespread marine sediments. *Antonie Van Leeuwenhoek* 87:11–18
- Maldonado LA, Fragoso-Yáñez D, Pérez-García A, Rosellón-Druker J, Quintana ET (2009) Actinobacterial diversity from marine sediments collected in Mexico. *Antonie Van Leeuwenhoek* 95:111–120
- Mauri M, Elli T, Caviglia G, Uboldi G, Azzi M (2017) RAWGraphs: a visualisation platform to create open outputs. In: *Proceedings of the 12th Biannual Conference on Italian SIGCHI Chapter*, ACM, New York, pp 28:1–28:5
- Menzel P, Ng KL, Krogh A (2016) Fast and sensitive taxonomic classification for metagenomics with kaiju. *Nat Commun* 7:11257
- Miao V, Davies J (2010) Actinobacteria: the good, the bad, and the ugly. *Antonie Van Leeuwenhoek* 98:143–150
- Miller AZ, Pereira MFC, Calaforra JM, Forti P, Dionísio A, Saiz-Jimenez C (2014) Siliceous speleothems and associated microbe-mineral interactions from Ana Heva lava tube in Easter Island (Chile). *Geomicrobiol J* 31:236–245
- Montenegro Á, Avis C, Weaver A (2008) Modeling the prehistoric arrival of the sweet potato in Polynesia. *J Archaeol Sci* 35:355–367
- Moraga J, Valle-Levinson A, Olivares J (1999) Hydrography and geostrophy around Easter Island. *Deep-Sea Res I* 46:715–731
- Muscholl-Silberhorn A, Thiel V, Imhoff JF (2008) Abundance and bioactivity of cultured sponge-associated bacteria from the Mediterranean Sea. *Microb Ecol* 55:94–106
- Nimaichand S, Devi AM, Tamreihao K, Ningthoujam DS, Li W-J (2015) Actinobacterial diversity in limestone deposit sites in Hundung, Manipur (India) and their antimicrobial activities. *Front Microbiol* 6:413
- Osorio C, Cantuarias V (1989) Vertical distribution of mollusks on the rocky intertidal of Easter Island. *Pac Sci* 43:302–315
- Parte AC (2014) LPSN-list of prokaryotic names with standing in nomenclature. *Nucleic Acids Res* 42:D613–D616
- Pathom-aree W, Stach JEM, Ward AC, Horikoshi K, Bull AT, Goodfellow M (2006) Diversity of actinomycetes isolated from Challenger Deep sediment (10,898 m) from the Mariana Trench. *Extremophiles* 10:181–189
- Patin NV, Duncan KR, Dorrestein PC, Jensen PR (2016) Competitive strategies differentiate closely related species of marine actinobacteria. *ISME J* 10:478–490
- Poussin C, Sierro N, Boué S, Battey J, Scotti E, Belcastro V, Peitsch MC, Ivanov NV, Hoeng J (2018) Interrogating the microbiome: experimental and computational considerations in support of study reproducibility. *Drug Discov Today* 23:1644–1657
- QGIS Development Team (2018) QGIS Geographic Information System. Open Source Geospatial Foundation Project. <http://qgis.osgeo.org>
- Quast C, Pruesse E, Yilmaz P, Gerken J, Schweer T, Yarza P (2013) The SILVA ribosomal RNA gene database project: improved data processing and web-based tools. *Nucleic Acids Res* 41:D590–D596
- Rambaut A (2015) FigTree, a graphical viewer of phylogenetic trees (2007) <http://tree.bio.ed.ac.uk/software/figtree>
- Rehder HA (1980) *The marine mollusks of Easter Island (Isla de Pascua) and Sala y Gómez*. Smithsonian Inst Press, Washington
- Sahl JW, Schupp JM, Rasko DA, Colman RE, Foster JT, Keim P (2015) Phylogenetically typing bacterial strains from partial SNP genotypes observed from direct sequencing of clinical specimen metagenomic data. *Genome Med* 7:52
- Santelices B, Abbott I (1987) Geographic and marine isolation: an assessment of the marine algae of Easter Island. *Pac Sci* 41:1–20
- Schneemann I, Nagel K, Kajahn I, Labes A, Wiese J, Imhoff JF (2010) Comprehensive investigation of marine *Actinobacteria* associated with the sponge *Halichondria panicea*. *Appl Environ Microbiol* 76:3702–3714
- Sehgal SN (1998) Rapamune® (RAPA, rapamycin, sirolimus): mechanism of action immunosuppressive effect results from blockade of signal transduction and inhibition of cell cycle progression. *Clin Biochem* 31:335–340
- Seymour JR (2014) A sea of microbes: the diversity and activity of marine microorganisms. *Microbiol Aust* 35:183–187
- Staufenberger T, Thiel V, Wiese J, Imhoff JF (2008) Phylogenetic analysis of bacteria associated with *Laminaria saccharina*. *FEMS Microbiol Ecol* 64:65–77
- Tamura K, Peterson D, Peterson N, Stecher G, Nei M, Kumar S (2011) MEGA5: molecular evolutionary genetics analysis using maximum likelihood, evolutionary distance, and maximum parsimony methods. *Mol Biol Evol* 28:2731–2739
- Thaker MN, Waglechner N, Wright GD (2014) Antibiotic resistance-mediated isolation of scaffold-specific natural product producers. *Nat Protoc* 9:1469–1479
- Varadaraj K, Skinner DM (1994) Denaturants or cosolvents improve the specificity of PCR amplification of a G + C-rich DNA using genetically engineered DNA polymerases. *Gene* 140:1–5
- Vezina C, Kudelski A, Sehgal S (1975) Rapamycin (AY-22, 989), a new antifungal antibiotic. *J Antibiot* 28:721–726
- Vezzoli L, Acocella V (2009) Easter Island, SE Pacific: an end-member type of hotspot volcanism. *Geol Soc Am Bull* 121:869–886
- Wilmshurst JM, Hunt TL, Lipo CP, Anderson AJ (2011) High-precision radiocarbon dating shows recent and rapid initial human colonization of East Polynesia. *Proc Natl Acad Sci U S A* 108:1815–1820
- Yang Q, Franco CMM, Zhang W (2015) Sponge-associated actinobacterial diversity: validation of the methods of actinobacterial DNA extraction and optimization of 16S rRNA gene amplification. *Appl Microbiol Biotechnol* 99:8731–8740
- Yuan C, Lei J, Cole J, Sun Y (2015) Reconstructing 16S rRNA genes in metagenomic data. *Bioinformatics* 31:i35–i43

2. Anthraquinones from an Easter Island sea anemone and their actinobacterial origin

Antitumor anthraquinones from an Easter Island sea anemone: animal or bacterial origin?



Ignacio Sottorff, Sven Künzel, Jutta Wiese, Matthias Lipfert, Nils Preußke, Frank Sönnichsen, and Johannes F. Imhoff:

Marine Drugs, 2019

<https://doi.org/10.3390/md17030154>

Article

Antitumor Anthraquinones from an Easter Island Sea Anemone: Animal or Bacterial Origin?

Ignacio Sottorff^{1,2}, Sven Künzel³, Jutta Wiese¹, Matthias Lipfert⁴, Nils Preußke⁴,
Frank D. Sönnichsen⁴  and Johannes F. Imhoff^{1,*} 

¹ GEOMAR Helmholtz Centre for Ocean Research Kiel, Marine Microbiology, 24105 Kiel, Germany; isottorff@geomar.de (I.S.); jwiese@geomar.de (J.W.)

² Facultad de Ciencias Naturales y Oceanográficas, Universidad de Concepción, 4070386 Concepción, Chile

³ Max Planck Institute for Evolutionary Biology, 24306 Plön, Germany; kuenzel@evolbio.mpg.de

⁴ Otto Diels Institute for Organic Chemistry, University of Kiel, 24118 Kiel, Germany; mlipfert@oc.uni-kiel.de (M.L.); npreusske@oc.uni-kiel.de (N.P.); fsoennichsen@oc.uni-kiel.de (F.D.S.)

* Correspondence: jimhoff@geomar.de; Tel.: +49-431-600-4450

Received: 31 January 2019; Accepted: 26 February 2019; Published: 5 March 2019



Abstract: The presence of two known anthraquinones, Lupinacidin A and Galvaquinone B, which have antitumor activity, has been identified in the sea anemone (*Gyraactis sesere*) from Easter Island. So far, these anthraquinones have been characterized from terrestrial and marine Actinobacteria only. In order to identify the anthraquinones producer, we isolated Actinobacteria associated with the sea anemone and obtained representatives of seven actinobacterial genera. Studies of cultures of these bacteria by HPLC, NMR, and HRLCMS analyses showed that the producer of Lupinacidin A and Galvaquinone B indeed was one of the isolated Actinobacteria. The producer strain, SN26_14.1, was identified as a representative of the genus *Verrucosispora*. Genome analysis supported the biosynthetic potential to the production of these compounds by this strain. This study adds *Verrucosispora* as a new genus to the anthraquinone producers, in addition to well-known species of *Streptomyces* and *Micromonospora*. By a cultivation-based approach, the responsibility of symbionts of a marine invertebrate for the production of complex natural products found within the animal's extracts could be demonstrated. This finding re-opens the debate about the producers of secondary metabolites in sea animals. Finally, it provides valuable information about the chemistry of bacteria harbored in the geographically-isolated and almost unstudied, Easter Island.

Keywords: Easter Island; Actinobacteria; anthraquinones; symbionts; sea anemone; marine invertebrates; spectroscopy; chromatography

1. Introduction

Since the discovery of Easter Island, compelling explorations have characterized the flora [1] and fauna [2–4] of this geographically isolated location. However, little has been done to understand the chemistry harbored in this territory. The best-known finding is the discovery of rapamycin in a soil dwelling actinobacterial representative, which serves as an immunosuppressive drug [5,6]. Beyond that, little progress has been made in exploiting the chemical diversity harbored by marine invertebrates and microorganisms dwelling in this territory, despite the high degree of endemism found [7].

Marine invertebrates are immensely diverse, well distributed in the world oceans [8], and widely known to contain medicinally relevant molecules [9–11]. While these metabolites play different roles in nature, e.g., they act as chemical defense, chemical communication or reproductive signaling molecules, they also find application as human medicines [12]. During the last decades, much effort has been

made to identify and characterize the chemicals contained in marine invertebrates. This has resulted in the discovery of astonishing chemicals with novel biological activities and chemical scaffolds [12–14].

Further, the immense progress in DNA sequencing technologies, the development of bioinformatics, and an improvement in analytical techniques enables the identification of the source of the chemicals. Thus, several molecules contained in marine invertebrates have now been shown to actually be of microbial origin [15,16]. It is expected that with the increasing availability of metagenomic information more identifications of the real producers of these metabolites will be made and will establish the metabolite relevance for the interaction of host, symbiont, and the environment.

Marine sponges represent a classic example of marine invertebrates that harbor microbes producing secondary metabolites. They have been studied in detail to determine the origin of the metabolites [17,18]. Another example is the producer of the approved anticancer drug Yondelis (Ecteinascidin-743). This compound was first assigned to the tunicate *Ecteinascidia turbinata*, but later identified as the product of a microbe, *Candidatus Endoecteinascidia frumentensis* [16].

Anthraquinones have been characterized in different marine invertebrates, for example crinoids [19] and sponges [20]. Anthraquinones have broad biological activity and are substances of pharmaceutical relevance for revealing antitumor [21], antibacterial [22], antifungal [23] and epigenetic modulator activities [24]. Two recently isolated anthraquinones, Lupinacidin A (1) and Galvaquinone B (2), have been reported to be produced by Actinobacteria belonging to the genera *Streptomyces* and *Micromonospora*. Lupinacidin A (1) was firstly reported as a specific inhibitor on murine colon 26-L5 carcinoma cells [25], and Galvaquinone B (2) showed moderate cytotoxicity against non-small-cell lung cancer cells Calu-3 and H2887, in addition of epigenetic modulatory activity [24].

Herein, we report the identification of two known anthraquinone molecules, Lupinacidin A (1) and Galvaquinone B (2), contained in an Easter Island sea anemone, *Gyraetis sesere*. Interestingly, so far these molecules have been only characterized from microbial origin. Therefore, we undertook the isolation and culture of the Actinobacteria associated with this marine invertebrate. The culture, chemical and genomic evaluation of these bacteria showed that the real producer of the metabolites was an Actinobacterium belonging to the genus *Verrucosispora* and not the sea anemone.

2. Results and Discussion

2.1. Sea Anemone Dereplication

Samples of the sea anemone *Gyraetis sesere* [26], also known as *Actiniogeton rapanuiensis* [27], were collected in the intertidal zone of Easter Island, South Pacific Ocean, and extracted with chloroform to give 8 mg of a yellowish residue. The HRLCMS analysis of this crude extract showed the presence of two previously identified antitumor anthraquinones (Figure 1) [24,25], Lupinacidin A (1) ($[M + H]^+$ m/z 341.1378) and Galvaquinone B (2) ($[M + H]^+$ m/z 369.3510), which were confirmed by complete NMR-spectroscopic characterization.

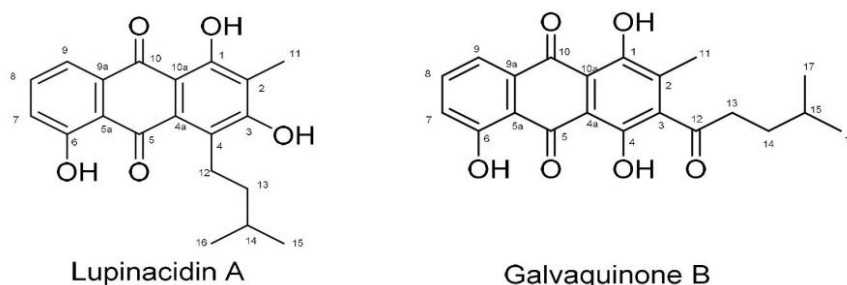

Figure 1. Identified molecules from the Easter Island sea anemone *Gyraetis sesere*.

Interestingly, the crude extract of the sea anemone (Figure 2) shows five resonances above 10 ppm; a region which is characteristic for hydroxyl protons. The resonances at δ 14.18 and 12.96 ppm are assigned to the groups at C-1 and C-6 of Lupinacidin A (1), as their vicinity and consequential hydrogen bonding to the ketogroups slows down their exchange. Similarly, the resonances at δ 13.49, 12.50, and 12.14 ppm originate from the three hydroxylprotons in Galvaquinone B (2).

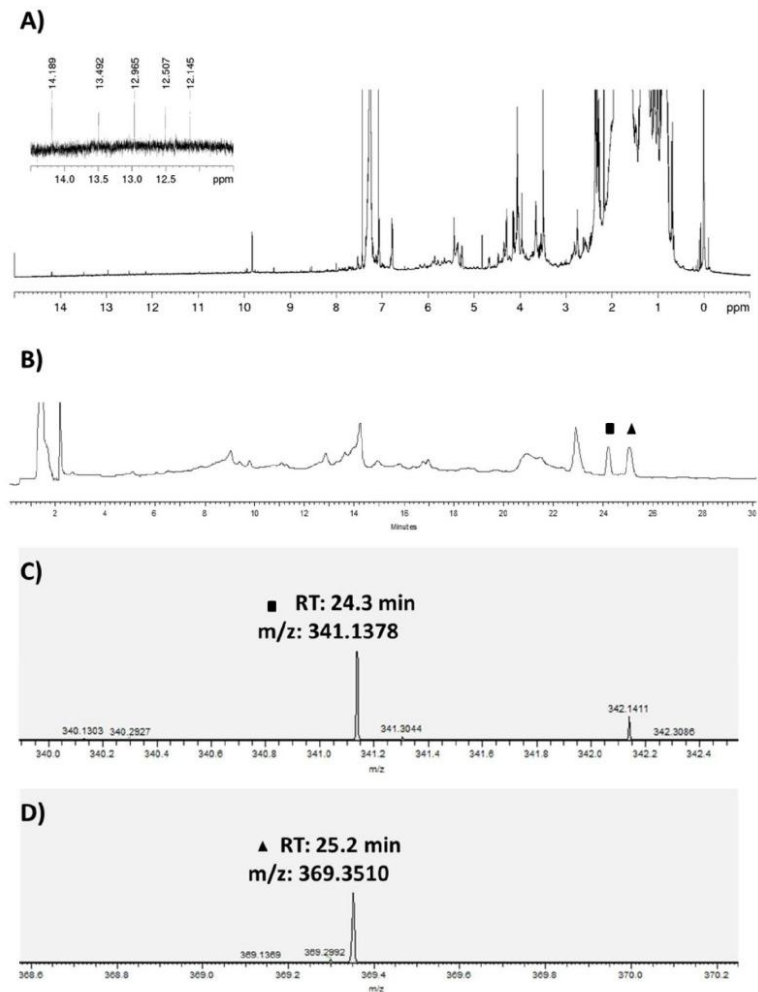

Figure 2. Chemical analysis of the crude extract of the sea anemone *Gyraetis sesere*. (A) ^1H NMR spectra of the crude extract of marine anemone *Gyraetis sesere* acquired in CDCl_3 , 600 MHz. Highlighted in the zoomed area are the frequencies of characteristic resonances originating from hydroxyl exchangeable protons in vicinity to ketogroups. (B) UV chromatogram (254 nm) of the crude extract of the sea anemone *Gyraetis sesere* highlighting the specific peaks for ■ RT: 24.3 min, and ▲: RT: 25.2 min. (C) High resolution mass for ■ (m/z $[\text{M} + \text{H}]^+$ 341.1378) and (D) high resolution mass for ▲ (2) (m/z $[\text{M} + \text{H}]^+$ 369.3510). *RT: Retention Time.

Other main peaks found in the sea anemone crude extract were peaks at RT 14.2 min with a HRMS $[\text{M} + \text{H}]^+$ m/z 295.19009 and at RT 23 min with a HRMS $[\text{M} + \text{H}]^+$ m/z 256.26312. Both exact masses were evaluated using the MarinLit database, however their HRMS did not match any known compound to-date.

2.2. Bacterial Metabolites and Harbored Bacteria

Lupinacidin A (**1**) and Galvaquinone B (**2**) have so far only been characterized in actinobacterial representatives, specifically from the genera *Streptomyces* [24,28] and *Micromonospora* [25], raising the question of the origin of these compounds in the sea anemone extract. Thus, we cultivated the Actinobacteria harbored by this sea anemone to determine if the anthraquinone producer was a bacterium or the sea anemone. Isolation media and the respective obtained strains are specified in Supplementary Table S1. Ten strains were identified through analysis of the 16S rRNA gene sequences as members of the genera *Micromonospora*, *Streptomyces*, *Verrucosipora*, *Dietzia*, *Arthrobacter*, *Rhodococcus*, and *Cellulosimicrobium* (Figure 3). Remarkably, *Gyrectis sesere* harbors a high number of Actinobacteria genera, in total seven; the most abundant genus being *Micromonospora* with three different species, followed by *Arthrobacter* with two different species. Other actinobacterial genera were present with only one species each. Outstandingly, the only isolate belonging to the *Verrucosipora* genus was the most abundant single Actinobacterium in the sea anemone.

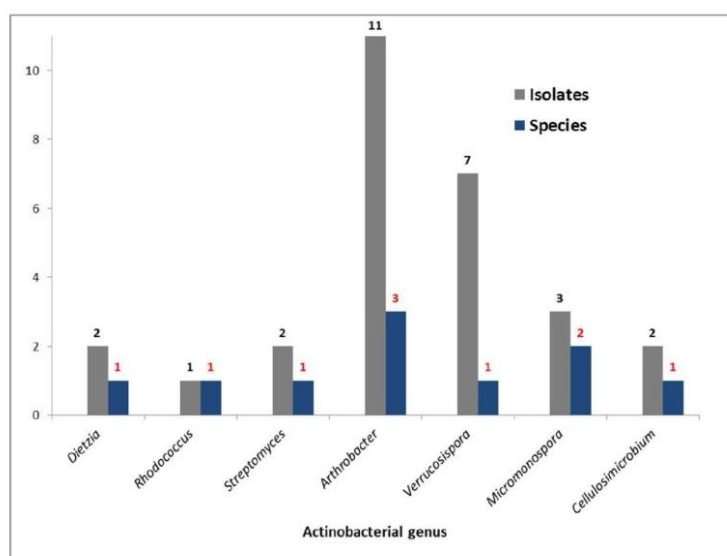

Figure 3. Genera and number of Actinobacteria species strains isolated from the sea anemone *Gyrectis sesere*.

2.3. Bacterial Growth

To evaluate the production of the anthraquinones by the isolated bacteria, we selected the actinobacterial representatives for growth experiments that were most closely related to known producers of the genera *Streptomyces*, *Micromonospora* and *Verrucosipora*. In addition, we also grew the *Dietzia* representative due to the lack of comprehensive information about its secondary metabolite production. On the other hand, *Rhodococcus*, *Arthrobacter*, and *Cellulosimicrobium* were omitted here because of their known poor production of secondary metabolites.

The growth yield of the selected Actinobacteria was in the range of 20 to 100 mg crude extract. The chromatograms of HPLC analyses of the crude extracts were compared in order to facilitate the metabolic comparison between grown bacteria, the sea anemone and the pure substances (Figure 4).

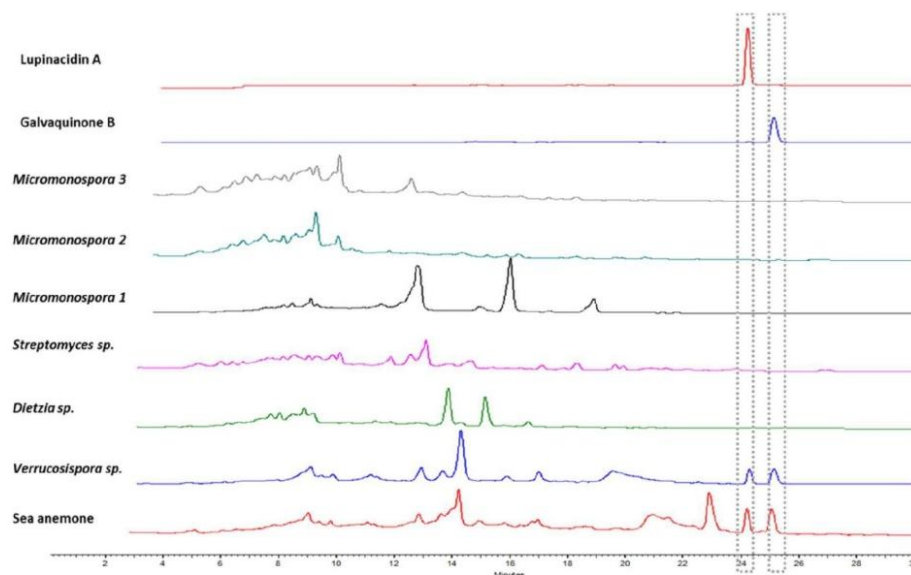

Figure 4. HPLC chromatograms of the crude extracts of the sea anemone *Gyraetis sesere*, its respective actinobacterial isolates, and the purified anthraquinones, Lupinacidin A (1) and Galvaquinone B (2). Approximate retention times of Lupinacidin A (1) and Galvaquinone B (2) are highlighted by boxes.

By comparison of chromatograms and retention times, we observed that Lupinacidin A (1) and Galvaquinone B (2) were only present in the crude extract of the sea anemone *Gyraetis sesere* and *Verrucospora sp.* SN26_14.1, and not in the other actinobacterial representatives. Clearly, *Verrucospora sp.* strain SN26_14.1 are dominant in the marine invertebrate. The chromatograms of *Verrucospora sp.* and sea anemone extracts are nearly identical and differ only slightly in the region of retention time 20–23 min. Notably the chromatogram of the sea anemone extract also does not show any peaks that suggest the presence of metabolites of any other of the cultivated bacteria. Together, this strongly suggests *Verrucospora* appeared to be the most abundant microbe in the sea anemone biomass during the collection.

The subtle difference in the metabolite profiles between *Verrucospora* and sea anemone extract in the retention time region 20–23 min appears to be to metabolites produced by the sea anemone itself. Overall, the amount appears to be surprisingly small. This may however be caused by the isolation methodology (chloroform extraction), that prioritizes lipophilic substances and selects against the isolation of polar compounds such as peptides.

2.4. Actinobacterial Producer

To confirm and replicate the production of these metabolites, we undertook a scale up culture of *Verrucospora sp.* SN26_14.1. Thus, 10 L of the Actinobacterium culture were grown, and extracted through the use of amberlite XAD-16 resin, yielding 1 g of crude extract with a brownish coloration. This extract was subjected to stepwise flash chromatography using iso-octane and ethyl acetate gradients, which produced a total of ten fractions. The fractions were evaluated through HPLC to find the fractions containing Lupinacidin A (1) and Galvaquinone B (2). The chromatogram evaluation showed that only the orange colored fraction two, which was eluted with 90% iso-octane and 10% ethyl acetate, contained 78 mg of metabolites enriched with Lupinacidin A (1) and Galvaquinone B (2). The purification of Lupinacidin A (1) and Galvaquinone B (2) was achieved through HPLC using normal and reverse phase chromatography.

Lupinacidin A (**1**) was isolated as a yellow powder, with a yield of 11 mg from a 10 L culture, which suggested to be an intermediate yield compared with *Streptomyces* and *Micromonospora* producers [24,25,28]. High resolution APCI-MS gave an $[M + H]^+$ adduct of m/z 341.1378, which results in a molecular formula of $C_{20}H_{20}O_5$. The calculation of the degree of unsaturation indicated 11 degrees. 1H NMR showed the characteristic exchangeable protons of (**1**) at δ at 14.18 and 12.96 ppm, in addition to the three neighboring aromatic proton signals δ 7.26, 7.62, and 7.79 ppm that showed the expected coupling pattern for three neighboring aromatic protons in a para-ortho, ortho-meta relationship (two doublets, and one doublet of doublets). The ^{13}C NMR experiment showed 20 carbons of which two represented ketone signals (δ 190.2 and 186.9 ppm), 12 aromatic carbons, and six aliphatic carbons (see Table 1). Two-dimensional NMR experiments, Homonuclear COrelated Spectroscopy (COSY), Heteronuclear Single Quantum Correlation (HSQC), and Heteronuclear Multiple Bond Correlation (HMBC), helped to confirm the identity of the molecules. These data were in agreement with the published information [24,25,28].

Table 1. Spectroscopic NMR data of Lupinacidin A (**1**) and Galvaquinone B (**2**).

Position	Lupinacidin A				Galvaquinone B			
	δ_C	δ_H Mult (J in Hz)	HMBC	COSY	δ_C	δ_H Mult (J in Hz)	HMBC	COSY
1	162.5				157.5			
2	117.5				137.1			
3	159.6				141.1			
4	130.4				153.8			
4a	127.9				116.2			
5	190.2				190.7			
5a	117.1				116.2			
6	162.6				162.7			
7	124.3	7.26, d (8.2)	5a, 6, 9	H-8	124.8	7.32, d (8.5, 1.3)	5a, 6, 9	H-8
8	136	7.62, dd (8.2, 7.5)	6, 9a	H-7, H-9	137.1	7.72, dd (8.5, 7.6)	6, 9, 9a	H-7, H-9
9	118.3	7.79, d (7.5)	5a, 7, 10	H-8	119.7	7.90, d (7.6, 1.3)	5a, 7, 10,	H-9
9a	133				133.4			
10	186.9				186.5			
10a	110.8				111.7			
11	8.4	2.27, s	1, 2, 3		13.2	2.25, s	1, 2, 3	
12	24.8	3.21, m (6.6)	3, 4a, 13, 14	H-13	204.9			
13	37.7	1.46, m (6.6)	4a, 12, 14, 15	H-12, H-14	42.4	2.85, m	12, 14, 15	H-14
14	28.4	1.80, m (6.6)	12, 13, 15, 16	H-13, H-15, H-16	31.9	1.63, m	14, 15, 16, 17	H-15
15	22.5	1.04, d (6.6)	13, 14, 16	H-14	27.6	1.63, m	14, 15, 16, 17	H-13, H-16, H-17
16	22.5	1.04, d (6.6)	13, 14, 15	H-14	22.4	0.93, d, (6.2)	14, 15, 17	H-15
17					22.4	0.93, d, (6.2)	14, 15, 16	H-15
1-OH		14.18	1, 2, 10a,			13.49, s	1, 2, 10a	
3-OH		5.62	2, 4a, 3					
4-OH						12.50, s	3, 4, 10a	
6-OH		12.96	5a, 6, 7			12.14, s	5a, 6, 8	

** 1H NMR (600 MHz) Solvent: $CDCl_3$ (δ^1H , mult, J in Hz), *** ^{13}C NMR (125 MHz), Solvent: $CDCl_3$.

Galvaquinone B (**2**) was isolated as a red powder, with a yield of 7 mg from a 10 L culture, which is an intermediate yield compared with *Streptomyces* and *Micromonospora* producers [24,28]. High

2.6. Biosynthesis

Recently, the biosynthetic machinery for the production of compound (1) and (2) was described as a type II polyketide synthase (PKS) that features a special Baeyer–Villiger type rearrangement, and was allocated to an Rsd gene cluster in *Streptomyces olivaceus* SCSIO T05 [28]. The Rsd biosynthetic gene cluster (BGC) showed great similarity to the Rsl BGC reported for the production of rishirilide A and B in *Streptomyces bottropensis* (also known as *Streptomyces. sp. Gc C4/4*) [29]. The BGC Rsd is responsible for the production of six molecules (rishirilide B, rishirilide C, Lupinacidin A (1), Lupinacidin D, Galvaquinone A and Galvaquinone B (2)), and among them compound (1) and (2) [28]. This raised the question of whether in *Verrucosipora*, compounds (1) and (2) follow the same biochemical assembly line as described for *Streptomyces*. Thus, the genome of *Verrucosipora sp. SN26_14.1* was sequenced using Illumina MiSeq. Although the obtained short reads were not complemented with a long read sequencing technology as PacBio, we were still able to obtain a 6.9 Mb draft genome (NCBI Bioproject Access # PRJNA522941). This data was annotated with Prokka and analyzed with the Antismash online platform [30] to identify the secondary metabolite biosynthesis gene clusters. As shown in Figure 6, the draft genome of *Verrucosipora sp. SN26_14.1* shared 60% of the genes of the Rsd gene cluster, as well as to an important percentage of the genes of the Rsl BGC. The similarity of the found genes ranged from 49% to 81%. The genetic architecture found in Vex BGC was quite similar to that of the Rsd and Rsl BGC. Remarkably, we could not detect any cyclase/aromatase and amidohydrolase sequences in our draft genome. Likely, this relates to the incompleteness of our sequence. Finally, it appears reasonable that *Verrucosipora sp. SN26_14.1* follows the same biosynthetic machinery for the production of Lupinacidin A (1) and Galvaquinone B (2) as found for *Streptomyces* species (Figure 6).

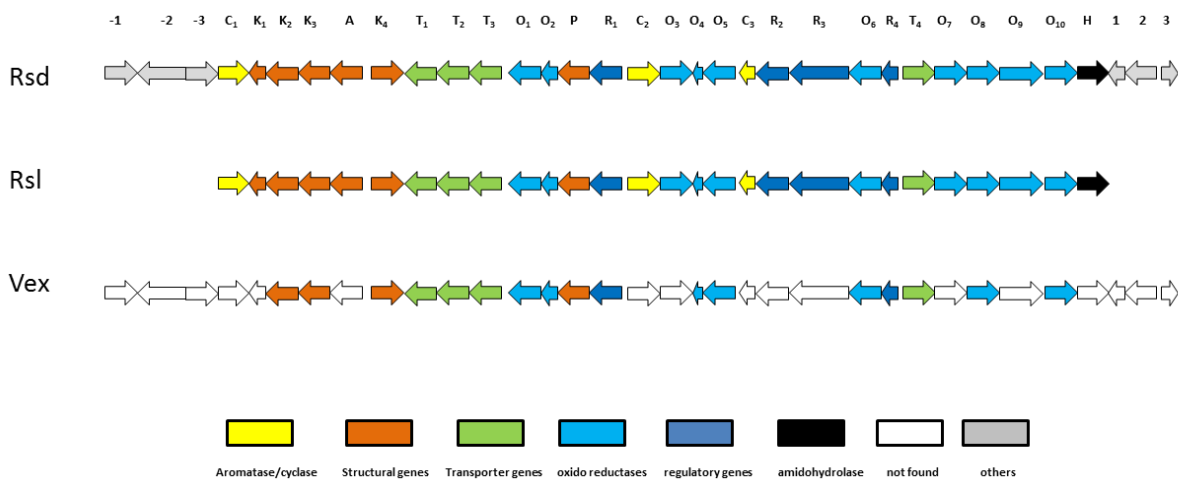

Figure 6. Biosynthetic gene cluster of anthraquinones producers. Rsd: *Streptomyces olivaceus* SCSIO T05 gene cluster [28], Rsl: *Streptomyces bottropensis* (*Streptomyces. sp. Gc C4/4*) gene cluster [29], Vex: *Verrucosipora sp. SN26_14.1*. C1: aromatase, K1: acyl carrier protein, K2: ketosynthase (beta), K3: ketosynthase (alpha), A: acyl transferase, K4: 3-oxoacyl-ACP synthase III, T1: ABC-transporter (substrate binding), T2: ABC-transporter (ATP binding), T3: ABC-transporter trans-membrane, O1: luciferase-like monooxygenase, O2: flavin reductase, P: phosphotransferase, R1: SARP family regulator, C2: second ring cyclase, O3: 3-oxoacyl-ACP reductase, O4: anthrone monooxygenase, O5: NADH: flavin oxidoreductase, C3: cyclase, R2: SARP regulatory protein, R3: LAL-family regulator, O6: luciferase-like monooxygenase, R4: MarR family transcriptional regulator, T4: drug resistance transporter, O7: putative NADPH quinone reductase, O8: putative NADPH: quinone oxidoreductase, O9: FAD-dependent oxidoreductase, O10: C9-keto reductase, H: amidohydrolase, -3: unknown function, -2: major facilitator superfamily protein, -1: Transcriptional regulatory protein, 1: cupin, 2: citrate/H⁺ symporter, 3: transcriptional regulator.

2.7. Antibiotic Activity Test

We performed a disc diffusion antibiotic test as a preliminary evaluation to determine if Lupinacidin A (1) and Galvaquinone B (2) have an inhibition effect on bacteria. As a positive control,

we used streptomycin at a concentration of 25 µg/disc. The results showed that Lupinacin A (1) and Galvaquinone B (2) did not produce any growth inhibition against the Gram-positive bacterium *Staphylococcus lentus* DSM 20352^T, and neither against the Gram-negative bacterium *Escherichia coli* DSM 498^T. In contrast, the positive control, streptomycin produced an inhibition halo of 22 mm for Gram-negative and 18 mm for Gram-positive bacteria.

3. Materials and Methods

3.1. Sample Collection

The sea anemone *Gyactis sesere* (also known as *Actiniogeton rapanuiensis*) was sampled from the coastal zone of Easter Island (27°08′45.1″S, 109°25′50.0″W) by the first author (Chilean citizen), in March 2016. The sampling site was outside the Isla de Pascua national park, and the sample was taken in agreement with regulations by the Chilean government. The sample was stored at 0 °C one hour after the sampling process.

3.2. Sea Anemone Dereplication

10 g of the sea anemone *Gyactis sesere* (wet weight) were thawed and homogenized with a mortar and pestle. When a creamy consistency was obtained, the tissue was transferred to a 250 mL beaker and 50 mL of chloroform was added. This extraction procedure was repeated three times. The obtained chloroform extract was concentrated until dryness under reduced pressure in a rotatory evaporator. The dried extract was resuspended in 1 L deionized water and transferred to a separation funnel, where it was partitioned with chloroform (3 × 300 mL). This process produced 8 mg of crude extract with a brownish coloration. Part of the crude extract (0.5 mg) was resuspended in methanol (HPLC grade) and injected in a HPLC (Merck Hitachi LaChrom Elite, Darmstadt, Germany) and in a HRLCMS Thermo Scientific™ Q Exactive™ Hybrid-Quadrupol-Orbitrap (Bremen, Germany), positive mode, and a 30 minute gradient of H₂O and acetonitrile supplemented with 0.1% of formic acid. The gradient developed as following: 0 min: 90% water, 10% acetonitrile, 25 min: 0% water, 100% acetonitrile, 28 min: 0% water, 100% acetonitrile, 30 min: 90% water, 10% acetonitrile. Mass spectroscopic data was evaluated with Xcalibur® (Thermo Fisher Scientific, San Jose, CA, USA), and compared with online databases (MarinLit, and Scifinder), and literature. The entire remaining sample was dissolved in deuterated chloroform (Eurisotop™, Saint-Aubin, France) and analyzed by ¹H NMR using a Bruker (Rheinstetten, Germany) Avance 600 MHz NMR spectrometer.

3.3. Bacterial Isolation

Approximately 1 cm³ (2 g) of the sea anemone *Gyactis sesere* (wet weight) were thawed and homogenized with a sterile mortar and pestle. Subsequently, the homogenized tissue was mixed with 9 mL of Ringer's buffer $\frac{1}{4}$ strength [31] to produce a final solution of 1:10. This solution was incubated at 56 °C for 10 min with the aim of reducing the viability of non-actinobacterial microbes. After the incubation, 1 min of vortex was applied. The inoculation of the culture media was done by adding 50 µL of the dilution into 15 cm diameter Petri dishes containing the media. The inoculum was spread out on the plate with a triangular cell spreader made of glass. Finally, plates were incubated at 25 °C in darkness. Darkness was chosen as a filtering factor to eliminate potential microalgae contamination. Four different media were prepared for the isolation of Actinobacteria from the sea anemone *Gyactis sesere*. Medium SIMA1 (*Salinispora* isolation media A1) was selected from literature and slightly modified as follows: 2.5 g starch, 1 g yeast extract, 0.5 g peptone, 1 L deionized water, and 25 g Tropic Marin™ salt (Wartenberg, Germany), 15 g/L agar [32]. The other media (BCM, BTM, and BSEM) were generated for this study as follows: BCM, 3 g chitin, 0.5 g N-acetyl glucosamine, 0.2 g K₂HPO₄, 0.25 g KNO₃, 0.25 g casein, 5 mL of mineral solution, 4 mL vitamin solution, 1 L deionized water, 15 g/L Tropic Marin™ salt (Wartenberg, Germany), 12 g/L Gellan gum, pH = 7.35; BTM, 1 g trehalose, 0.25 g histidine, 0.25 g proline, 0.2 g MgCl₂·6H₂O, 4 mL vitamin solution, 12 g/L Gellan

gum, 1 L deionized water, 15 g Tropic Marin™ salt (Wartenberg, Germany), pH = 7.2; and BSEM, 0.1 g tyrosine, 0.1 g D-galactose, 4 mL vitamin solution, 5 mL mineral solution, 1 L Baltic Sea water, 16 g/L agar, pH = 7.4. Mineral salt solution contained 1 L distilled water, 50 mg FeSO₄·7H₂O, 50 mg ZnCl₂, and 50 mg CuSO₄. Vitamin solution contained 1 L distilled water, 5 mg thiamine·HCl, 5 mg riboflavin, 5 mg niacin, 5 mg pyridoxine HCl, 5 mg inositol, 5 mg Ca-pantothenate, 5 mg p-amino benzoic acid, and 2.5 mg biotin.

The media were autoclaved for 35 min at 121 °C. Subsequently, the culture media were supplemented with 50 mg/L of nalidixic acid (Sigma-Aldrich, St. Louis, MO, USA) and 100 mg/L of cycloheximide (Carl Roth GmbH, Karlsruhe, Germany) [33], and poured into petri dishes. Once the sample was inoculated onto the petri dish, they were incubated for six weeks. When bacterial colonies were visually evident, we proceeded with the purification of the bacteria until obtaining an axenic culture. The isolated bacteria were conserved using Cryobank™ (Mast Diagnostica GmbH, Reinfeld, Germany) bacterial storage system.

3.4. Molecular Characterization and Phylogenetic Analysis

DNA was extracted from bacterial cells by use of a DNA isolation kit, DNeasy™ (Qiagen, Hilden, Germany), following the manufacturer instructions. Subsequently, the 16S rRNA gene sequence was amplified with PCR and the use of general bacterial primers in a concentration of 10 pmol/μL, i.e., 27f and 1492r [34], 342f and 534r [35], 1387r [36] as well as 1525r [37]. PCR reagents were obtained from GE Healthcare Illustra™ PuReTaq Ready-To-Go™ PCR Beads (GE Healthcare, Glattbrugg, Switzerland) containing DNA polymerase, MgCl₂, and dNTPs. The PCR conditions were the same as reported by Staufenger et al. [35]. Once the PCR amplification process was terminated, a quality check of the PCR products was performed by gel electrophoresis. The sequencing process was run at the Centre for Molecular Biology at Kiel University (IKMB). The 16S rRNA gene sequences were manually curated using Chromas pro software, version 1.7.6 (Technelysium Pty Ltd., Tewantin QLD, Australia), and saved in FASTA format. Sequences were aligned with nucleotide BLAST [38] and EZbiocloud [39]. Phylogenetic analysis involved the alignment of the sequences with related reference strains in the web platform SILVA-SINA [40]. MEGA was used to delete gap sites and to run bootstrapped phylogenetic trees using a neighbor-joining model [41].

3.5. Bacterial Growth for Secondary Metabolites Production

For the evaluation of the secondary metabolites production, we grew the Easter Island isolated strain *Verrucosispora* sp. SN26_14.1 in 10 × 2.5 L Thomson Ultra Yield® flasks (Thomson Instrument, Oceanside, CA, USA), which contained 1 L each of a modified starch-glucose-glycerol (SGG) liquid medium [31]. The composition of the production medium was: 5 g glucose, 5 g soluble starch, 5 g glycerol, 1.25 g cornsteep powder, 2.5 g peptone, 1 g yeast extract, 1.5 CaCO₃, and 1 L deionized water. The medium was also supplemented with 15 g/L Tropic Marin™ salt (Wartenberg, Germany). The pH was adjusted to 7.7 using 1 M HCl and NaOH. The culture was kept in orbital agitation at 240 RPM, 28 °C, for 14 days in darkness.

3.6. Chemical Extraction, Purification and Structure Elucidation

After the growth period, 20 g/L amberlite XAD-16 (Sigma-Aldrich, St. Louis, MO, USA) was added to each culture medium flask and mixed for one hour using orbital agitation with 120 rpm. Subsequently, the resin was separated through cheesecloth filtration [42], and the liquid was discarded. Afterwards, amberlite plus cheesecloth was mounted on a glass funnel, washed with 3 L of deionized water, and eluted with 1 L of acetone [42]. Acetone was then concentrated under reduced pressure until an aqueous residue was obtained. One liter of deionized water was added to the acetone residue, and it was brought to a separation funnel. The organic molecules were extracted using 3 × 1 L of ethyl acetate. The organic phase was concentrated under reduced pressure until dryness.

For the evaluation of the produced metabolites, we used HPLC-DAD (Merck Hitachi LaChrom Elite, Darmstadt, Germany) and a 30 min gradient of H₂O-acetonitrile supplemented with 0.1% of formic acid. The gradient was developed as following: 0 min: 90% water, 10% acetonitrile, 25 min: 0% water, 100% acetonitrile, 28 min: 0% water, 100% acetonitrile, 30 min: 90% water, 10% acetonitrile. The gravity SB™ C-18 column was obtained from Macherey-Nagel (Düren, Germany).

The purification of chemicals involved three different steps: 1) Flash chromatography using standard silica gel 60, pore size ~ 60 Å (Macherey-Nagel, Düren, Germany) as a stationary phase, mounted in a glass Buchner funnel (D = 70 mm, H = 180 mm). The mobile phase solvents were iso-octane and ethyl acetate. The chromatographic process was developed in a stepwise increase of polarity (10% each), starting with 100% iso-octane, and 0% of ethyl acetate, and ending in 0% iso-octane and 100% ethyl acetate, resulting in 10 different fractions. 2) The fraction that contained compound (1) and (2) was selected and worked in HPLC (Merck Hitachi LaChrom Elite, Darmstadt, Germany) using a normal phase NUCLEODUR® 100-5 column (4.6 × 250 mm) from Macherey-Nagel (Düren, Germany). The method used for the purification was a combination of isocratic and gradient solvent mix, with a flow rate of 1 mL/min, where A: iso-octane, B: ethyl acetate, and C: dichloromethane/methanol (50:50). The method was developed as following: 0 min: 100% A and 0% B, 3 min: 100% A and 0% B, 5 min: 95% A and 5% B, 9 min: 95% A and 5% B, 11 min: 0% A and 100% B, 13 min: 0% A and 100% B, 14 min: 10% A, 50% B, and 40% C, 16 min: 10% A, 50% B, and 40% C, 18 min: 50% A and 50% B, 19 min: 100% A and 0% B, 21 min: 100% A and 0% B. 3) The semi-purified compounds were purified through HPLC (Merck Hitachi LaChrom Elite, Darmstadt, Germany) using a reverse phase C-18 column, 10 × 250 mm (YMC, Kyoto, Japan). The method used for the purification was a combination of isocratic and gradient solvent mix, with a flow rate of 2.5 mL/min. The method was developed as following: 0 min: 90% A and 10% B, 5 min: 20% A and 80% B, 9 min: 20% A and 80% B, 13 min: 0% A and 100% B, 19 min: 0% A and 100% B, 23 min: 90% A and 10% B, 25 min: 90% A, 10% B (A: water, B: acetonitrile).

After these purification steps, Lupinacidin A (1) and Galvaquinone B (2) were obtained with high purity to perform structural elucidation experiments. HRLCMS was performed with a Thermo Scientific™ Q Exactive™ Hybrid-Quadrupol-Orbitrap (Thermo Scientific, Bremen, Germany), positive mode, and a 30 min gradient of H₂O and acetonitrile supplemented with 0.1% of formic acid. The gradient was developed as follows: 0 min: 90% water, 10% acetonitrile, 25 min: 0% water, 100% acetonitrile, 28 min: 0% water, 100% acetonitrile, 30 min: 90% water, 10% acetonitrile. Mass spectroscopic data was evaluated with Xcalibur® (Thermo Fisher Scientific, San Jose, CA, USA), and the compared with online databases (MarinLit, and Scifinder), and literature.

Additionally, ¹H and ¹³C NMR and two-dimensional NMR experiments (HMBC, HSQC, COSY) were acquired to characterize the main components of crude extract, and their chemical functionality. For this, compound (1) and (2) were redissolved in CDCl₃ (Eurisotop™, Saint-Aubin, France), and transferred to NMR tubes (178 × 5.0 mm). Experiments were acquired on a Bruker (Rheinstetten, Germany) Avance spectrometer operating at 600 MHz proton frequency equipped with a cryogenically cooled triple resonance z-gradient probe head using stand pulse sequences from the Bruker experiment library. Spectra were referenced against tetramethylsilane (Sigma-Aldrich, St. Louis, MO, USA) as internal standard.

3.7. Genome Sequencing

The samples were prepared with the Nextera® XT DNA sample preparation kit from Illumina (Illumina, San Diego, CA, USA) following the manufacturer's protocol. Afterwards the samples were pooled and sequenced on the Illumina MiSeq using the MiSeq® (Illumina, San Diego, CA, USA) Reagent Kit v3 600 cycles sequencing chemistry. The library was clustered to a density of approximately 1200 K/mm².

3.8. Genome Assembly

The quality control of reads was checked with FASTQC software [43] to evaluate the GC%, number of k-mers, sequence length, and total reads. Trimmomatic v0.36 [44] was used to filter low quality sequences and adapters. Filtered reads were assembled with SPAdes v3.11.0 [45] using default k-mer lengths. The obtained contigs were evaluated with QUAST tool [46] to select the best quality contig. Finally, Prokka [47] was used to annotate the draft genome.

3.9. Secondary Metabolites Gene Clusters Search

The online platform of Antismash [30] was used to detect the secondary metabolites gene clusters present in the draft genome.

3.10. Antibiotic Activity Test

To test the antibiotic activity, we used the disc diffusion method [48] as a primary indicator. Thus, compound (1) and (2) were tested to determine their activity on *Staphylococcus lentus* DSM 20352^T, and *Escherichia coli* DSM 498^T. These bacteria were cultured in GYM medium (4 g glucose, 4 g yeast extract, 10 g malt extract, 2 g CaCO₃, 1 L deionized water, pH = 7.2, and 12 g agar). Lupinacidin A (1), and Galvaquinone B (2) were transferred to a paper disc to reach a final concentration of 25 µg and 50 µg each in triplicate. Additionally, we used an antibiotic susceptibility disc of streptomycin (Oxoid[®], Columbia, MD, USA) as a positive indicator of antibiotic activity. The plates were inoculated with fresh culture of *Staphylococcus lentus* DSM 20352^T, and *Escherichia coli* DSM 498^T, and incubated at 37 °C for 24 h. After the incubation period, the inhibition zone was measured and registered.

4. Conclusions

We established that the Easter Island sea anemone *Gyraactis sesere* contained two anthraquinones, Lupinacidin A (1) and Galvaquinone B (2), which were ultimately found to be produced by one of the Actinobacteria associated with this marine invertebrate, *Verrucosipora* sp. SN26_14.1. The production of the identified metabolites by the bacterial isolate apparently follows a recently characterized PKS type II pathway with a Baeyer–Villiger type rearrangement assembly line. Our finding adds a new actinobacterial genus to the producers of these anthraquinones, implying that these metabolites are not exclusive to the genera *Streptomyces* and *Micromonospora*. It was demonstrated, that culture-based approaches remain as effective tools for the isolation of polyketide producing Actinobacteria as sources for secondary metabolites of potential use in drug discovery. Our study confirms that cnidarians, and in specific sea anemones, can be a source of such pharmacologically relevant microorganisms. Finally, these findings re-open the debate about the real producers of secondary metabolites in sea animals and add another example of associated bacteria as producers of substances present in sea animals. In addition, the study provides information on the chemistry harbored in biota of the geographically isolated and almost unstudied, Easter Island.

Supplementary Materials: The following are available online at <http://www.mdpi.com/1660-3397/17/3/154/s1>. Information on NMR spectra, HRLCMS data, and secondary metabolite gene cluster.

Author Contributions: I.S., J.F.I. and J.W. planned the experiments, I.S. performed the experiments, analyzed and evaluated the data and wrote the first draft of the publication. J.F.I., F.D.S. and J.W. supervised the work and revised the manuscript. S.K. sequenced the genome and supplied the genome data. M.L. and N.P. acquired LCMS and NMR data. F.D.S. acquired and analyzed NMR data.

Funding: We thank the Deutscher Akademischer Austauschdienst (DAAD) for financial support under the stipend # PKZ91564794. We acknowledge financial support by the Land Schleswig-Holstein within the funding programme Open Access Publikationsfonds.

Acknowledgments: We thank Marion Höftmann and Gitta Kohlmeyer-Yilmaz for her valuable help with the NMR data acquisition. We thank Ute Hentschel Humeida (GEOMAR Helmholtz Centre for Ocean Research Kiel) for her support. We also thank Philip A. Thomas (ImagesByPT@PhilipT.com), for providing high quality photography of the sea anemone *Gyraactis sesere*. I.S. thanks Millaray Sierra for her support during the research. N.P. thanks the Deutsche Bundesstiftung Umwelt (German Federal Environmental Foundation) for a predoctoral fellowship.

Conflicts of Interest: The authors declare no conflict of interest.

References

1. Dransfield, J.; Flenley, J.R.; King, S.M.; Harkness, D.D.; Rapu, S. A recently extinct palm from Easter Island. *Nature* **1984**, *312*, 750. [[CrossRef](#)]
2. Boyko, C.B. The endemic marine invertebrates of Easter Island: How many species and for how long? In *Easter Island: Scientific Exploration into the World's Environmental Problems in Microcosm*; Loret, J., Tanacredi, J.T., Eds.; Springer: Boston, MA, USA, 2003; pp. 155–175.
3. Skottsberg, C. *The Natural History of Juan Fernández and Easter Island*; Almqvist & Wiksells Boktryckeri: Uppsala, Sweden, 1920.
4. Kohn, A.J.; Lloyd, M.C. Marine polychaete annelids of Easter Island. *Int. Rev. Hydrobiol.* **1973**, *58*, 691–712. [[CrossRef](#)]
5. Sehgal, S.N. Rapamune® (RAPA, rapamycin, sirolimus): Mechanism of action immunosuppressive effect results from blockade of signal transduction and inhibition of cell cycle progression. *Clin. Biochem.* **1998**, *31*, 335–340. [[CrossRef](#)]
6. Vezina, C.; Kudelski, A.; Sehgal, S. Rapamycin (AY-22, 989), a new antifungal antibiotic. *J. Antibiot.* **1975**, *28*, 721–726. [[CrossRef](#)] [[PubMed](#)]
7. Allen, G.R. Conservation hotspots of biodiversity and endemism for Indo-Pacific coral reef fishes. *Aquat. Conserv.* **2008**, *18*, 541–556. [[CrossRef](#)]
8. Horton, T.; Kroh, A.; Ah Yong, S.; Bailly, N.; Boyko, C.B.; Brandão, S.N.; Costello, M.J.; Gofas, S.; Hernandez, F.; Holovachov, O.; et al. *World Register of Marine Species (WoRMS)*; WoRMS Editorial Board: Ostend, Belgium, 2018.
9. Urda, C.; Fernández, R.; Pérez, M.; Rodríguez, J.; Jiménez, C.; Cuevas, C. Protobenincins A and B, cytotoxic long-chain acylated xenicanes from the soft coral *Protodendron repens*. *J. Nat. Prod.* **2017**, *80*, 713–719. [[CrossRef](#)] [[PubMed](#)]
10. Nakamura, F.; Kudo, N.; Tomachi, Y.; Nakata, A.; Takemoto, M.; Ito, A.; Tabei, H.; Arai, D.; de Voogd, N.; Yoshida, M.; et al. Halistanol sulfates I and J, new SIRT1–3 inhibitory steroid sulfates from a marine sponge of the genus *Halichondria*. *J. Antibiot.* **2017**, *71*, 273. [[CrossRef](#)] [[PubMed](#)]
11. Aminin, D.; Menchinskaya, E.; Pislugin, E.; Silchenko, A.; Avilov, S.; Kalinin, V. Anticancer activity of sea cucumber triterpene glycosides. *Mar. Drugs* **2015**, *13*, 1202–1223. [[CrossRef](#)] [[PubMed](#)]
12. Hay, M.E. Marine chemical ecology: What's known and what's next? *J. Exp. Mar. Biol. Ecol.* **1996**, *200*, 103–134. [[CrossRef](#)]
13. Mehbub, M.F.; Lei, J.; Franco, C.; Zhang, W. Marine sponge derived natural products between 2001 and 2010: Trends and opportunities for discovery of bioactives. *Mar. Drugs* **2014**, *12*, 4539–4577. [[CrossRef](#)] [[PubMed](#)]
14. Blunt, J.W.; Copp, B.R.; Keyzers, R.A.; Munro, M.H.G.; Prinsep, M.R. Marine natural products. *Nat. Prod. Rep.* **2014**, *31*, 160–258. [[CrossRef](#)] [[PubMed](#)]
15. Piel, J.; Hui, D.; Wen, G.; Butzke, D.; Platzer, M.; Fusetani, N.; Matsunaga, S. Antitumor polyketide biosynthesis by an uncultivated bacterial symbiont of the marine sponge *Theonella swinhoei*. *Proc. Natl. Acad. Sci. USA* **2004**, *101*, 16222–16227. [[CrossRef](#)] [[PubMed](#)]
16. Rath, C.M.; Janto, B.; Earl, J.; Ahmed, A.; Hu, F.Z.; Hiller, L.; Dahlgren, M.; Kreft, R.; Yu, F.; Wolff, J.J.; et al. Meta-omic characterization of the marine invertebrate microbial consortium that produces the chemotherapeutic natural product ET-743. *ACS Chem. Biol.* **2011**, *6*, 1244–1256. [[CrossRef](#)] [[PubMed](#)]
17. Unson, M.D.; Holland, N.D.; Faulkner, D.J. A brominated secondary metabolite synthesized by the cyanobacterial symbiont of a marine sponge and accumulation of the crystalline metabolite in the sponge tissue. *Mar. Biol.* **1994**, *119*, 1–11. [[CrossRef](#)]
18. Schmidt, E.W.; Obraztsova, A.Y.; Davidson, S.K.; Faulkner, D.J.; Haygood, M.G. Identification of the antifungal peptide-containing symbiont of the marine sponge *Theonella swinhoei* as a novel δ -*Proteobacterium*, “*Candidatus Entotheonella palauensis*”. *Mar. Biol.* **2000**, *136*, 969–977. [[CrossRef](#)]
19. Feng, Y.; Khokhar, S.; Davis, R.A. Crinoids: Ancient organisms, modern chemistry. *Nat. Prod. Rep.* **2017**, *34*, 571–584. [[CrossRef](#)] [[PubMed](#)]
20. Khokhar, S.; Pierens, G.K.; Hooper, J.N.A.; Ekins, M.G.; Feng, Y.; Davis, R.A. Rhodocomatulin-type anthraquinones from the Australian marine invertebrates *Clathria hirsuta* and *Comatula rotularia*. *J. Nat. Prod.* **2016**, *79*, 946–953. [[CrossRef](#)] [[PubMed](#)]

21. Tietze, L.F.; Gericke, K.M.; Schubert, I. Synthesis of highly functionalized anthraquinones and evaluation of their antitumor activity. *Eur. J. Org. Chem.* **2007**, *2007*, 4563–4577. [[CrossRef](#)]
22. Yang, K.-L.; Wei, M.-Y.; Shao, C.-L.; Fu, X.-M.; Guo, Z.-Y.; Xu, R.-F.; Zheng, C.-J.; She, Z.-G.; Lin, Y.-C.; Wang, C.-Y. Antibacterial anthraquinone derivatives from a sea anemone-derived fungus *Nigrospora* sp. *J. Nat. Prod.* **2012**, *75*, 935–941. [[CrossRef](#)] [[PubMed](#)]
23. Kim, Y.-M.; Lee, C.-H.; Kim, H.-G.; Lee, H.-S. Anthraquinones isolated from *Cassia tora* (Leguminosae) Seed Show an Antifungal Property against Phytopathogenic Fungi. *J. Agric. Food Chem.* **2004**, *52*, 6096–6100. [[CrossRef](#)] [[PubMed](#)]
24. Hu, Y.; Martinez, E.D.; MacMillan, J.B. Anthraquinones from a marine-derived *Streptomyces spinoverrucosus*. *J. Nat. Prod.* **2012**, *75*, 1759–1764. [[CrossRef](#)] [[PubMed](#)]
25. Igarashi, Y.; Trujillo, M.E.; Martínez-Molina, E.; Yanase, S.; Miyanaga, S.; Obata, T.; Sakurai, H.; Saiki, I.; Fujita, T.; Furumai, T. Antitumor anthraquinones from an endophytic actinomycete *Micromonospora lupini* sp. nov. *Bioorg. Med. Chem. Lett.* **2007**, *17*, 3702–3705. [[CrossRef](#)] [[PubMed](#)]
26. Haddon, A.C.; Shackleton, A.M. Description of some new species of Actiniaria from Torres Straits. *R. Dublin Soc.* **1893**, *8*.
27. Carlgren, O. Actiniaria und zoantharia von Juan Fernandez und der Osterinsel. In *The Natural History of Juan Fernandez and Easter Island*; Skottsberg, C., Ed.; Almqvist & Wiksells Boktryckeri: Uppsala, Sweden, 1922; pp. 145–160.
28. Zhang, C.; Sun, C.; Huang, H.; Gui, C.; Wang, L.; Li, Q.; Ju, J. Biosynthetic Baeyer–Villiger chemistry enables access to two anthracene scaffolds from a single gene cluster in deep-sea-derived *Streptomyces olivaceus* SCSIO T05. *J. Nat. Prod.* **2018**, *81*, 1570–1577. [[CrossRef](#)] [[PubMed](#)]
29. Yan, X.; Probst, K.; Linnenbrink, A.; Arnold, M.; Paululat, T.; Zeeck, A.; Bechthold, A. Cloning and heterologous expression of three type II PKS gene clusters from *Streptomyces bottropensis*. *ChemBioChem* **2012**, *13*, 224–230. [[CrossRef](#)] [[PubMed](#)]
30. Weber, T.; Blin, K.; Duddela, S.; Krug, D.; Kim, H.U.; Bruccoleri, R.; Lee, S.Y.; Fischbach, M.A.; Müller, R.; Wohleben, W.; et al. AntiSMASH 3.0—A comprehensive resource for the genome mining of biosynthetic gene clusters. *Nucleic Acids Res.* **2015**, *43*, W237–W243. [[CrossRef](#)] [[PubMed](#)]
31. Goodfellow, M.; Fiedler, H.-P. A guide to successful bioprospecting: Informed by actinobacterial systematics. *J. Microb.* **2010**, *98*, 119–142. [[CrossRef](#)] [[PubMed](#)]
32. Patin, N.V.; Duncan, K.R.; Dorrestein, P.C.; Jensen, P.R. Competitive strategies differentiate closely related species of marine Actinobacteria. *ISME J.* **2015**, *10*, 478. [[CrossRef](#)] [[PubMed](#)]
33. Thaker, M.N.; Waglechner, N.; Wright, G.D. Antibiotic resistance-mediated isolation of scaffold-specific natural product producers. *Nat. Protoc.* **2014**, *9*, 1469. [[CrossRef](#)] [[PubMed](#)]
34. Lane, D.J. 16S/23S rRNA sequencing. In *Nucleic Acid Techniques in Bacterial Systematics*; Stackebrandt, E., Goodfellow, M., Eds.; John Wiley and Sons: Chichester, UK, 1991; pp. 115–175.
35. Staufenberg, T.; Thiel, V.; Wiese, J.; Imhoff, J.F. Phylogenetic analysis of bacteria associated with *Laminaria saccharina*. *FEMS Microbiol. Ecol.* **2008**, *64*, 65–77. [[CrossRef](#)] [[PubMed](#)]
36. Ellis, R.J.; Morgan, P.; Weightman, A.J.; Fry, J.C. Cultivation-dependent and independent approaches for determining bacterial diversity in heavy-metal-contaminated soil. *Appl. Environ. Microb.* **2003**, *69*, 3223. [[CrossRef](#)]
37. Frank, J.A.; Reich, C.I.; Sharma, S.; Weisbaum, J.S.; Wilson, B.A.; Olsen, G.J. Critical evaluation of two primers commonly used for amplification of bacterial 16S rRNA genes. *Appl. Environ. Microb.* **2008**, *74*, 2461. [[CrossRef](#)] [[PubMed](#)]
38. Altschul, S.F.; Gish, W.; Miller, W.; Myers, E.W.; Lipman, D.J. Basic local alignment search tool. *J. Mol. Biol.* **1990**, *215*, 403–410. [[CrossRef](#)]
39. Yoon, S.-H.; Ha, S.-M.; Kwon, S.; Lim, J.; Kim, Y.; Seo, H.; Chun, J. Introducing EzBioCloud: A taxonomically united database of 16S rRNA gene sequences and whole-genome assemblies. *Int. J. Syst. Evol. Microbiol.* **2017**, *67*, 1613–1617. [[CrossRef](#)] [[PubMed](#)]
40. Quast, C.; Pruesse, E.; Yilmaz, P.; Gerken, J.; Schweer, T.; Yarza, P.; Peplies, J.; Glöckner, F.O. The SILVA ribosomal RNA gene database project: Improved data processing and web-based tools. *Nucleic Acids Res.* **2013**, *41*, D590–D596. [[CrossRef](#)] [[PubMed](#)]

41. Tamura, K.; Peterson, D.; Peterson, N.; Stecher, G.; Nei, M.; Kumar, S. MEGA5: Molecular evolutionary genetics analysis using maximum likelihood, evolutionary distance, and maximum parsimony methods. *Mol. Biol. Evol.* **2011**, *28*, 2731–2739. [[CrossRef](#)] [[PubMed](#)]
42. Cheng, Y.B.; Jensen, P.R.; Fenical, W. Cytotoxic and antimicrobial napyradiomycins from two marine-derived *Streptomyces* strains. *Eur. J. Org. Chem.* **2013**, 3751–3757. [[CrossRef](#)] [[PubMed](#)]
43. Andrews, S. FastQC a Quality Control Tool for High Throughput Sequence Data. Available online: <http://www.bioinformatics.babraham.ac.uk/projects/fastqc/> (accessed on 30 May 2018).
44. Bolger, A.M.; Usadel, B.; Lohse, M. Trimmomatic: A flexible trimmer for Illumina sequence data. *Bioinformatics* **2014**, *30*, 2114–2120. [[CrossRef](#)] [[PubMed](#)]
45. Bankevich, A.; Nurk, S.; Antipov, D.; Gurevich, A.A.; Dvorkin, M.; Kulikov, A.S.; Lesin, V.M.; Nikolenko, S.I.; Pham, S.; Pribelski, A.D.; et al. SPAdes: A new genome assembly algorithm and its applications to single-cell sequencing. *J. Comput. Biol.* **2012**, *19*, 455–477. [[CrossRef](#)] [[PubMed](#)]
46. Gurevich, A.; Tesler, G.; Vyahhi, N.; Saveliev, V. QUASt: Quality assessment tool for genome assemblies. *Bioinformatics* **2013**, *29*, 1072–1075. [[CrossRef](#)] [[PubMed](#)]
47. Seemann, T. Prokka: Rapid prokaryotic genome annotation. *Bioinformatics* **2014**, *30*, 2068–2069. [[CrossRef](#)] [[PubMed](#)]
48. Bondi, A., Jr.; Spaulding, E.H.; Smith, D.E.; Dietz, C. A routine method for the rapid determination of susceptibility to penicillin and other antibiotics. *Am. J. Med. Sci.* **1947**, *213*, 221–225. [[CrossRef](#)] [[PubMed](#)]



© 2019 by the authors. Licensee MDPI, Basel, Switzerland. This article is an open access article distributed under the terms and conditions of the Creative Commons Attribution (CC BY) license (<http://creativecommons.org/licenses/by/4.0/>).

3. Chemical differences of two closely related *Streptomyces*

Different secondary metabolite profiles of phylogenetically almost identical *Streptomyces griseus* strains originating from geographically remote locations

Ignacio Sottorff, Jutta Wiese, Matthias Lipfert, Nils Preußke, Frank Sönnichsen, and Johannes F. Imhoff:

Microorganisms, 2019

<https://doi.org/10.3390/microorganisms7060166>



Article

Different Secondary Metabolite Profiles of Phylogenetically almost Identical *Streptomyces griseus* Strains Originating from Geographically Remote Locations

Ignacio Sottorff^{1,2}, Jutta Wiese¹, Matthias Lipfert³, Nils Preußke³, Frank D. Sönnichsen³ and Johannes F. Imhoff^{1,*}

¹ GEOMAR Helmholtz Centre for Ocean Research Kiel, Marine Microbiology, 24105 Kiel, Germany; isottorff@geomar.de (I.S.); jwiese@geomar.de (J.W.)

² Facultad de Ciencias Naturales y Oceanográficas, Universidad de Concepción, 4070386 Concepción, Chile

³ Otto Diels Institute for Organic Chemistry, University of Kiel, 24118 Kiel, Germany; mlipfert@oc.uni-kiel.de (M.L.); npreusske@oc.uni-kiel.de (N.P.); fsoennichsen@oc.uni-kiel.de (F.D.S.)

* Correspondence: jimhoff@geomar.de; Tel.: +49-431-600-4450

Received: 8 May 2019; Accepted: 4 June 2019; Published: 6 June 2019



Abstract: As *Streptomyces* have shown an outstanding capacity for drug production, different campaigns in geographically distant locations currently aim to isolate new antibiotic producers. However, many of these newly isolated *Streptomyces* strains are classified as identical to already described species. Nevertheless, as discrepancies in terms of secondary metabolites and morphology are possible, we compared two *Streptomyces* strains with identical 16S rRNA gene sequences but geographically distant origins. Chosen were an Easter Island *Streptomyces* isolate (*Streptomyces* sp. SN25_8.1) and the next related type strain, which is *Streptomyces griseus* subsp. *griseus* DSM 40236^T isolated from Russian garden soil. Compared traits included phylogenetic relatedness based on 16S rRNA gene sequences, macro and microscopic morphology, antibiotic activity and secondary metabolite profiles. Both *Streptomyces* strains shared several common features, such as morphology and core secondary metabolite production. They revealed differences in pigmentation and in the production of accessory secondary metabolites which appear to be strain-specific. In conclusion, despite identical 16S rRNA classification *Streptomyces* strains can present different secondary metabolite profiles and may well be valuable for consideration in processes for drug discovery.

Keywords: *Streptomyces*; geographical isolation; Easter Island; secondary metabolites; 16S rRNA; morphology; High Resolution Mass Spectroscopy (HRMS); Nuclear Magnetic Resonance (NMR); horizontal gene transfer

1. Introduction

The increasing number of pathogens that show antibiotic resistance has triggered the bioprospection of new antibiotics [1]. *Actinobacteria* have shown to be an exceptional source of new antibiotics and pharmaceuticals in general [2]. Within the *Actinobacteria* phylum, *Streptomyces* is the most prolific drug producing genus [3]. *Streptomyces* species have shown an outstanding capacity for the production of secondary metabolites, many of which effectively can treat human diseases. Secondary metabolites of *Streptomyces* species belong to different classes of compounds, such as: polyketides [4], peptides [5] and polyketide-peptides hybrids [6], and have been characterized with different biological activities, such as: antibacterial [7] antifungal [8], anticancer [9] and immune suppression [10].

Biogeographically, *Streptomyces* species have a wide distribution, since they can be found in the most diverse habitats, like polar territories [11], deserts [12], highlands [13], insects [14], marine invertebrates [15] and marine sediments [16,17].

As a result of the current drug bioprospection, multiple *Streptomyces* strains are isolated every year, however only a limited percentage of these bacteria represent new species [18]. Most of them represent already characterized species displaying similar or even identical phylogenetic features [19]. The most widely used method of bacterial characterization is the analysis of the 16S rRNA gene sequence which despite its utility and quickness, has shown ambiguity when discriminating closely related *Streptomyces* strains (>99% of similarity) [20]. Often known *Streptomyces* species are considered to be of little significance for drug discovery due to their lack of novelty in terms of phylogeny and physiology. In consequence, drug discovery may overlook new metabolites produced from *Streptomyces* strains which are closely related to already known strains since they are assumed to be producers of identical secondary metabolites [21]. However, investigations have shown that in addition to the core secondary metabolites, many *Streptomyces* strains have an accessory chemical arsenal which has not been completely studied [22]. Moreover, diverse experiments have demonstrated that changing culture conditions of *Streptomyces* strains may activate cryptic biosynthetic pathways, producing uncommon or unknown strain-specific metabolites [23,24].

The advancement in genome sequencing and the reduction of its cost has allowed the differentiation of closely related *Streptomyces* species at the genomic level [25] and has shed light about the unexploited cryptic biosynthetic pathways harbored by *Streptomyces* strains, or bacteria in general [26]. Despite the genomic advancement, we still lack the understanding of expression and regulation of biosynthetic pathways [26]. This makes it necessary to perform an in vitro characterization of *Streptomyces* strains to obtain specific information of their secondary metabolite features.

To date, few efforts have been made to thoroughly evaluate the differences in secondary metabolite production between two *Streptomyces* strains that are identical according to 16S rRNA phylogeny but originate from different geographic regions [19].

Therefore, we compared two phylogenetically identical *Streptomyces* strains, an isolate from a marine sediment sample from Easter Island, a remote location in the middle of the South Pacific Ocean, and as counterpart a reference strain isolated from Russian garden-soil. Our data showed that the phylogenetically almost identical *Streptomyces* strains shared a number of morphological and chemical features as widely recognized and also expected. However, we also found striking differences in the accessory metabolites produced, which appear to be strain specific. We suggest that these chemical differences may have risen through niche specialization, as well as horizontal gene transfer.

2. Materials and Methods

2.1. *Streptomyces* Strains

Streptomyces sp. SN25_8.1 was obtained from a marine sediment sample which was collected from the coastal zone of the Easter Island, Chile (27°08'45.0" S, 109°25'49.8" W), by the first author (Chilean citizen), in March 2016. The sampling site was outside of the Isla de Pascua national park, and the sample was taken in agreement with regulations by the Chilean government. *Streptomyces griseus* subsp. *griseus* DSM 40236^T was obtained from the German Collection of Microorganisms and Cell Cultures GmbH (DSMZ). This strain was isolated by Krainsky from a garden soil sample from Russia [27,28].

2.2. Culture Conditions

Cultivation and morphological comparison of the of *Streptomyces* strains were made using solid Glucose-Yeast extract-Malt extract medium (GYM), 4 g glucose × H₂O, 4 g yeast extract, 10 g malt extract, 2 g CaCO₃, 15 g agar, 1 L deionized water, and pH 7.2 [29].

For the evaluation of the secondary metabolites production, the *Streptomyces* strains were grown in Ultra Yield® flasks 2.5 L (Thomson, Oceanside, CA, USA), which contained 1 L of slightly modified Starch-Glucose-Glycerol (SGG) liquid medium [30]. The composition of the production medium was: 5 g soluble starch, 5 g glucose x H₂O, 5 g glycerol, 1.25 g cornsteep powder, 2.5 g peptone from soymeal, 1 g yeast extract, 1.5 CaCO₃, and 1 L deionized water. The medium was also supplemented with 15 g/L Tropic Marin™ salt (Wartenberg, Germany). The pH was adjusted to 7.7 using 1 M of HCl and NaOH. The culture was kept in orbital agitation at 240 rpm, 28 °C, for 14 days in darkness.

2.3. Molecular Characterization and Phylogenetic Analysis

DNA was extracted from the bacterial cells through the use of DNA isolation kit, DNeasy™ (Qiagen, Hilden, Germany), following the manufacturer instructions. Subsequently, the amplification of the 16S rRNA gene sequence was performed with PCR and the use of general bacterial primers in a concentration of 10 pmol/μL, i.e. 27f, 1492r [31,32], 1387r [33] and 1525r [34].

PCR reagents were obtained from GE Healthcare illustra™ PuReTaq Ready-To-Go™ PCR Beads (GE Healthcare, Glattbrugg, Switzerland) containing DNA polymerase, MgCl₂, and dNTPs. The PCR conditions were the same as reported by Staufenberg et al. [32]. The 16S rRNA genes were sequenced at the Center for Molecular Biosciences (ZMB) at Kiel University using the primers 27f [31], 342f [32], 534r [32] and 1525r [34]. The 16S rRNA gene sequences were manually curated using Chromas pro software, version 1.7.6 (Technelysium Pty Ltd, Tewantin QLD, Australia) and saved in FASTA format. Primary phylogenetic characterization of the *Streptomyces* strains was achieved using nucleotide NCBI-BLAST and EZbioCloud [35]. Subsequently, the obtained sequences were standardized according to the global SILVA alignment for rRNA genes [36]. This primary alignment was visually compared using ExPASy (SIB bioinformatics resource portal) [37] to determine the level or similarity or divergence of both *Streptomyces* 16S rRNA gene sequences. For the construction of a *Streptomyces* phylogenetic tree, we retrieved the next related type strains 16S rRNA gene sequences from NCBI. All the 16S rRNA gene sequences were gathered in a single FASTA file and aligned in SINA-SILVA web platform [36]. The outcome of SINA gave a multi-aligned *Streptomyces* sequences FASTA file which was processed with MEGA [38] to delete gap sites, and subsequently to run bootstrapped phylogenetic trees, using neighbor joining model.

2.4. Morphological Analysis

Three week-old plates of *Streptomyces* cultures on solid GYM medium were inspected and recorded under a stereo microscope (SZX16, Olympus, Japan), using a visual increase of 0.7-fold. Additionally, cells and spores of both *Streptomyces* strains were inspected under an Axiophot microscope using a 100x lens and recorded with Axio Cam MRm (Zeiss, Göttingen, Germany).

2.5. Chemical Analysis

After the growth period, 20 g/L of amberlite XAD-16 (Sigma-Aldrich, St. Louis, MO, USA) were added to each culture flask and mixed for one hour using orbital agitation in 120 rpm. Subsequently, the resin was separated through cheesecloth filtration [39], and the liquid was discarded. Amberlite was mounted on a glass funnel, and washed with 3 L of deionized water, and eluted with 1 L of acetone [39]. Acetone was then concentrated under reduced pressure until obtaining an aqueous residue. Subsequently, 1 L of deionized water was added to the acetone residue and brought to a separation funnel. To extract the organic molecules, 3 × 300 mL of ethyl acetate was used. The organic phase was concentrated under reduced pressure until dryness.

Streptomyces secondary metabolite profiles were acquired through high pressure liquid chromatography (HPLC, Merck-Hitachi, Darmstadt, Germany) coupled with evaporative light scattering detector (ELSD, Sedere, Olivet, France). The secondary metabolites profiling was developed primarily as screening strategy, using 30 min gradient. The gradient developed was as following: 0 min: 90% water, 10% acetonitrile, 20 min: 0% water, 100% acetonitrile, 23 min: 0% water, 100%

acetonitrile, 28 min: 90% water, 10% acetonitrile, 30 min: 90% water, 10% acetonitrile. The used column was reverse phase C18 gravity SB™ (Macherey-Nagel, Düren, Germany). The wavelengths recorded were 210 and 254 nm. Dereplication process and 254 nm HPLC profiling were made with a High Resolution Liquid Chromatography coupled with Mass Spectroscopy (HRLCMS), Thermo Scientific™ UltiMate 3000 RS UHPLC coupled to a Thermo Scientific™ Q Exactive™ Hybrid-Quadrupol-Orbitrap MS (Thermo, Bremen, Germany), positive mode, and a 35 minutes gradient of H₂O and acetonitrile supplemented with 0.1% of formic acid. The gradient developed was as following: 0 min: 90% water, 10% acetonitrile, 25 min: 0% water, 100% acetonitrile, 28 min: 0% water, 100% acetonitrile, 30 min: 90% water, 10% acetonitrile, 35 min: 90% water, 10% acetonitrile. The used column was reverse phase C18 gravity SB™ (Macherey-Nagel, Düren, Germany). The wavelength recorded was 254 nm. Mass and spectral data were evaluated with Xcalibur® (Thermo Scientific, San Jose, CA, USA), and compared with online databases (MarinLit, and Scifinder), and literature.

¹H Nuclear Magnetic Resonance (NMR) experiments of the crude extracts were acquired to characterize the main components. The samples were dissolved in deuterated chloroform (Eurisotop™, Saint-Aubin, France), and transferred to NMR tubes (178 × 5.0 mm). Experiments were acquired on a Bruker Avance III spectrometer (Rheinstetten, Germany) operating at 600 MHz proton frequency equipped with a cryogenically cooled triple resonance z-gradient probe head using stand pulse sequences from the Bruker experiment library. Spectra were referenced against tetramethylsilane (TMS) as internal standard. NMR data was analyzed with TopSpin (version 3.5.b.91 pl 7, Bruker BioSpin Ltd., Karlsruhe, Germany).

2.6. Antibiotic Activity

The disc diffusion method was used to determine the antibiotic activity [40]. Thus, crude extracts obtained from the *Streptomyces* strains were tested to determine their activity on Gram-positive and Gram-negative bacteria. For this purpose, we chose *Staphylococcus lentus* DSM 20352, and *Escherichia coli* DSM 498. These bacteria were cultured in TSB medium (17 g of peptone from casein, 3 g peptone from soymeal, 2.5 g glucose × H₂O, 5 g NaCl, 2.5 g K₂HPO₄, 1 L deionized water and pH to 7.3) at 37 °C for 24 h. Crude extracts were dissolved in MeOH to be subsequently transferred to a paper disc to reach a final concentration of 50 µg per disc. Additionally, we used an antibiotic susceptibility disc of streptomycin (Oxoid®, Columbia, MD, USA) as a positive indicator of antibiotic activity in a concentration of 25 µg per disc. All the used paper discs had a diameter of 6 mm. The plates were inoculated with fresh culture of *S. lentus* DSM 20352, and *E. coli* DSM 498, and incubated at 37 °C for 24 h. After the incubation period, the inhibition zone was measured and registered.

3. Results

3.1. Phylogenetic Analysis

Molecular characterization of both *Streptomyces* strains was performed with the sequence of the 16S rRNA gene as a genetic marker. The amplification and subsequent characterization resulted in nearly complete 16S rRNA sequences, whereby the Easter Island strain, *Streptomyces* sp. SN25_8.1, revealed a sequence with 1477 nucleotides (NCBI access# MK734066) compared to the sequence of the laboratory grown type strain of *Streptomyces griseus* subsp. *griseus* DSM 40236^T, with a sequence of 1476 nucleotides (NCBI access# MK734067). We used the new sequence of the 16S rRNA gene of the type strain, *Streptomyces griseus* subsp. *griseus* DSM 40236^T, for detailed sequence comparison, since the publicly available sequence dates to 2003 (NCBI access# AY207604). Both the new and old sequences are identical.

The alignment of the 16S rRNA gene sequences of strains DSM 40236^T (from a Russian garden soil sample) and SN25_8.1 (from Easter Island) showed that the strains shared identical sequences of the 16S rRNA gene (Supplementary Figure S1). The phylogenetic tree (Figure 1) revealed, that both strains affiliate to one cluster, which is separated from the other *Streptomyces* spp. strains.

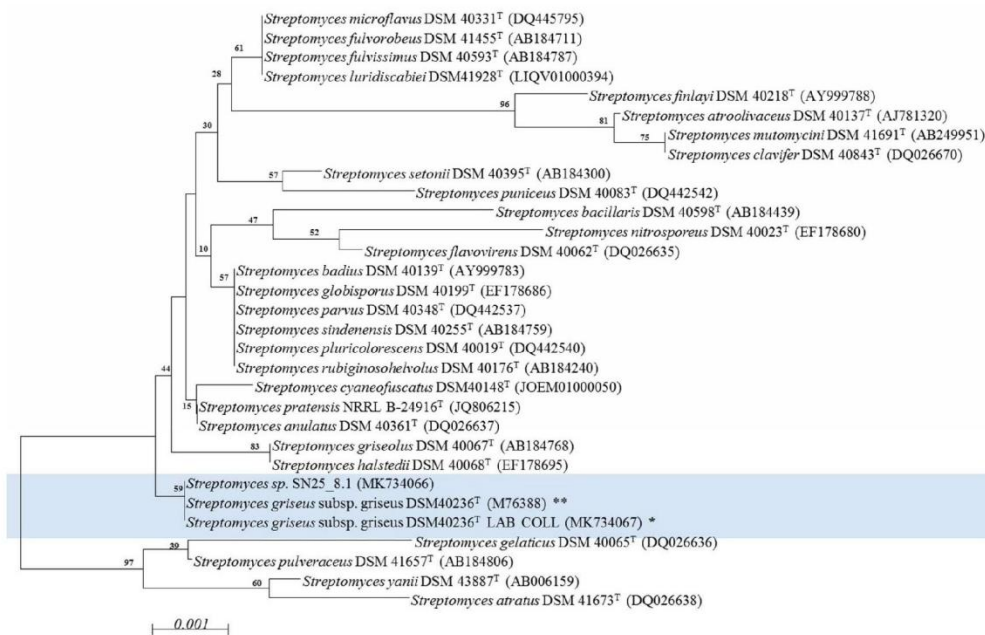

Figure 1. Phylogenetic characterization of the *Streptomyces* strains using a neighbor joining model. Light blue: experimentally compared *Streptomyces* strains. Bootstrap = 1000; Bootstrap values are shown on the branch, where 100 is maximum; ^T: type strain; NCBI access number is within parenthesis. * *Streptomyces griseus* subsp. *griseus* DSM 40236^T LAB COLL: Sequence experimentally obtained from fresh cultures and deposited in NCBI (MK734067). ** *Streptomyces griseus* subsp. *griseus* DSM 40236^T: Sequence retrieved from NCBI (M76388). The evolutionary distances were computed using the Jukes-Cantor method and are in the units of the number of base substitutions per site (scale). The analysis involved 31 nucleotide sequences. All positions containing gaps and missing data were eliminated. There were a total of 1338 positions in the final dataset.

3.2. Morphological Comparison

After cultivation of the strains in solid GYM medium for three weeks, we continued with a morphological comparison of the Easter Island *Streptomyces* sp. SN25_8.1 and the type strain, *Streptomyces griseus* subsp. *griseus* DSM 40236^T (Figure 2). The visual comparison showed evident macroscopic differences between the strains, such as; spore pigmentation, amount of spore formation, and aerial hyphae distribution on the colony. Light microscopic examination of the cells and spores of both strains showed no differences. Nevertheless, a detailed characterization of the spores and spore-bearing hyphae would require scanning electron microscopy.

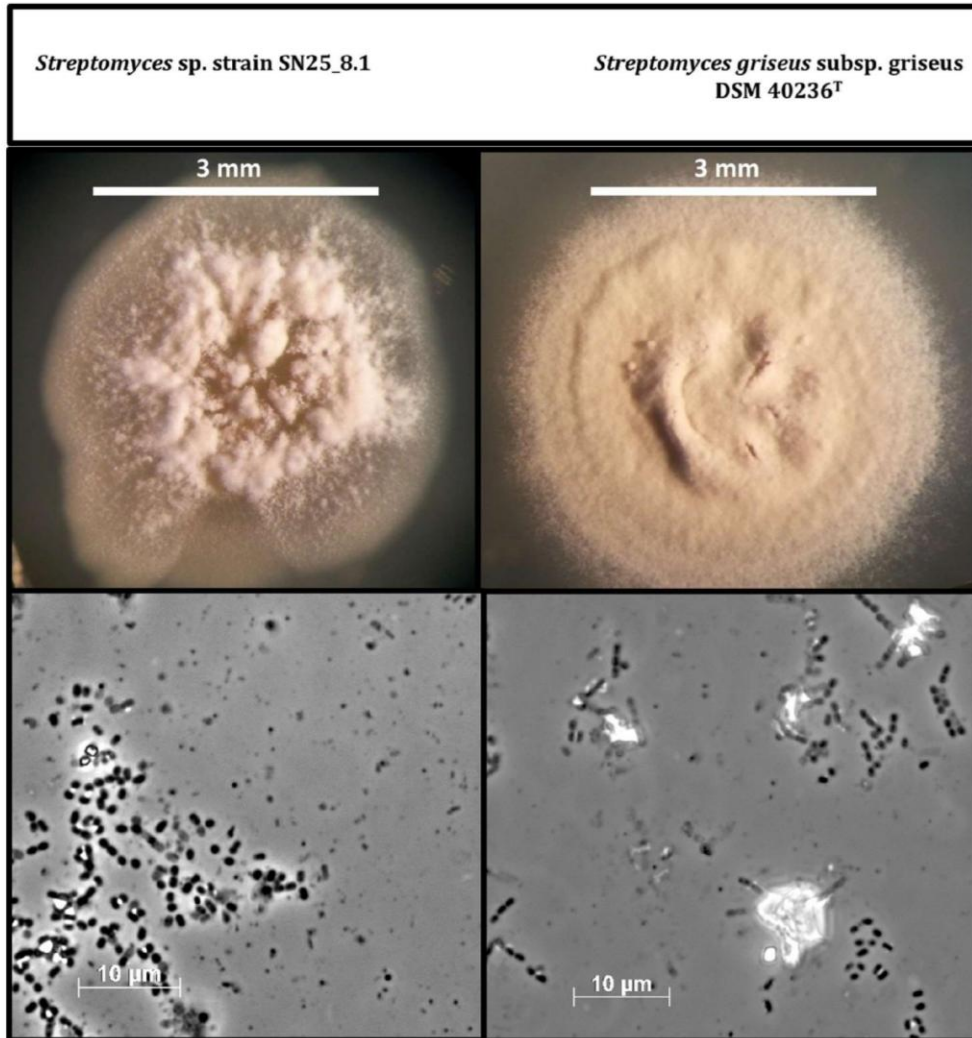

Figure 2. Comparison of cell and colony morphology of the two *Streptomyces* strains after growth on GYM medium for three weeks. Photos were recorded using a stereo microscope (upper figures) and microscope with a 100x lens (bottom figures).

3.3. Secondary Metabolites Production

Both *Streptomyces* strains produced different metabolites patterns and quantities after growth in a Starch-Glucose-Glycerol medium (slightly modified SGG). *Streptomyces* sp. SN25_8.1 produced a total of 60.9 mg of crude extract, while the type strain *Streptomyces griseus* subsp. *griseus* DSM 40236^T produced almost the double amount, 108.1 mg. The HPLC chromatograms of the crude extracts showed differences and similarities between the two *Streptomyces* strains (Figure 3A,B). The similarities found in the chromatograms (taking the Easter Island representative as a point of comparison, Figure 3B) were observed in the following retention time (RT): 5.8, 8.5, 9.33, 9.54, 11.0, 11.5, 12.0, 12.4, 13.1, 15.3, 16.0 and 18.8 min. The observed peak at RT 27.3 min is a methodic artifact and should not be considered in the comparison of the chromatograms. Differences were found between the chromatograms at RT 3.1, 4.5, 5.3, 7.2, 11.3, 11.6, 13.7, and 18.46. Considering this information, it is fair to state that these *Streptomyces* strains differ significantly, because they share some metabolites but differ in the production of others.

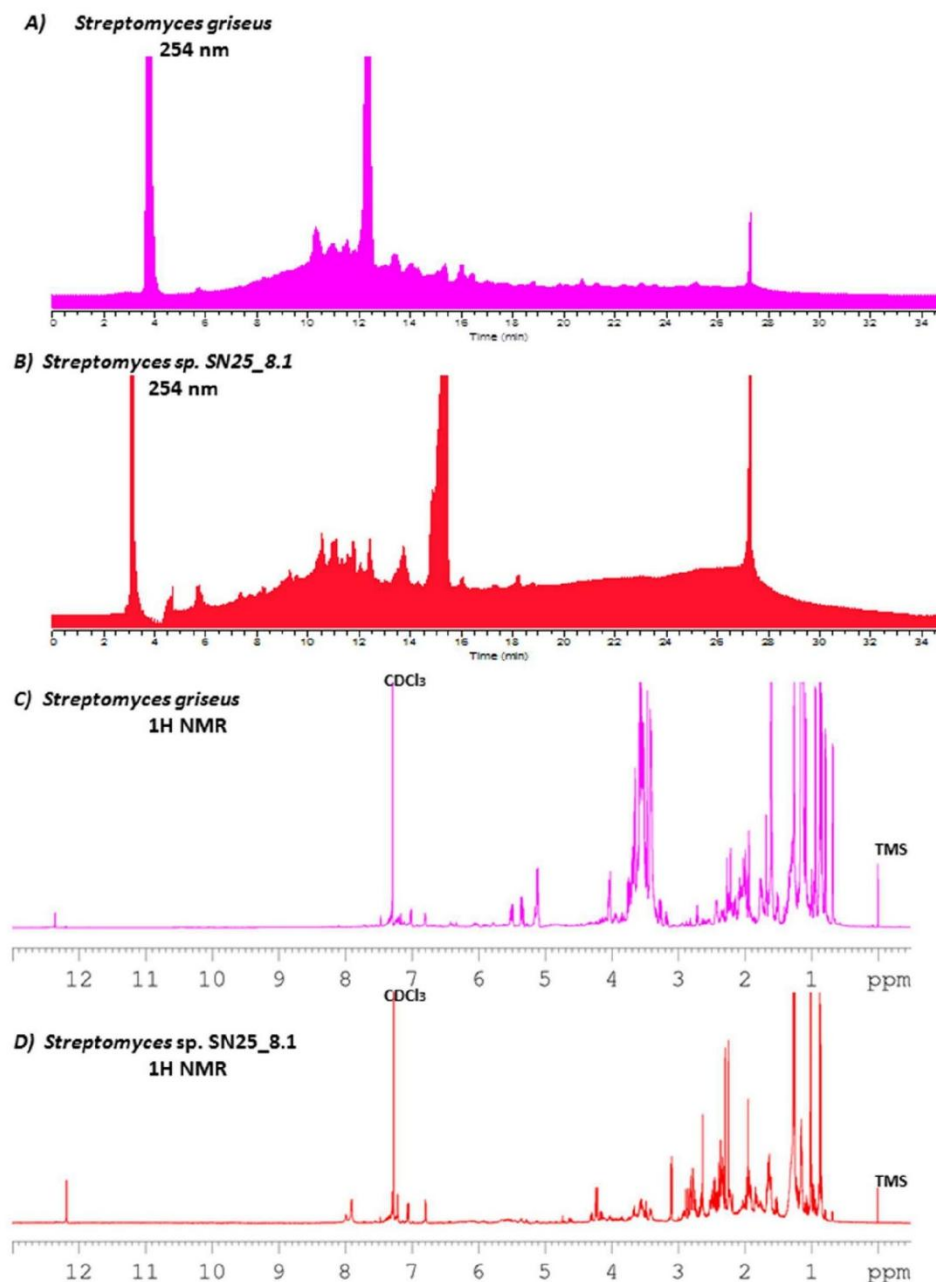

Figure 3. HPLC metabolite profile comparison of *Streptomyces sp.* SN25_8.1 from Easter Island, and *Streptomyces griseus* subsp. *griseus* DSM 40236^T from Russia, measured at 254 nm (A,B), and ¹H NMR comparison of the crude extract of both strains (C,D). CDCl₃: deuterated chloroform; TMS: tetramethylsilane.

In order to extend the previous HPLC data, ¹H NMR experiments were performed to again display similarities as well as differences among the most abundant chemical groups present in both samples (Figure 3C,D). For example, remarkable similarities were found in the aromatic proton zone (7–8 ppm), in the olefinic proton zone (of 4–6, ppm), and in the low frequency region (1.0–3.5 ppm), where aliphatic methyl, methylenes and methines are commonly found. However, abundant differences

between the two spectra are apparent for example in the high frequency protons around 12.2–12.4 ppm, the broad peaks close to 8 ppm, olefinic signals around 5.5 ppm, and the methyl protons around 0.65 ppm. Further, in particular the strongly differing intensities in the mentioned regions suggest also the presence of large differences in the relative metabolite contributions in these mixtures.

As simple one-dimensional ^1H NMR profiles do not allow for a compound identification, attempts to identify some of the mixture components by high resolution LC-MS techniques (HRLCMS) were undertaken. Several molecules could be identified in both *Streptomyces* representatives based on their exact masses and a chemical database search (Supplementary Materials). We observed that the two *Streptomyces* strains had a core chemical arsenal that is shared by both strains and an accessory chemical arsenal which seems to be strain specific (Figure 4). The identified core chemicals comprised gancidin W, YF-0200-R-B, emycin E, phenatic acid, netropsin, actiphenol, 6-beta-deoxy-5-hydroxy-tetracycline and TMC-86B. From the analysis of the accessory metabolites, we observed that the Easter Island representative, *Streptomyces* sp. SN25_8.1, produced seven detectable chemicals, which were: albidopyrone, cyclizidine, epithienamycin C, cycloheximide, SF-733C, protomycin and N-Valyldihydroxyhomoproline, as accessory metabolites. In contrast, we could detect only four chemicals in the reference strain *Streptomyces griseus* subsp. *griseus* DSM 40236^T as accessory metabolites, which were: fortimicin KK1, capromycin, YO-7625 and halstoctacosanolide B.

It is evident that the identified metabolites may be only a fraction of the total chemical components in the crude extracts. However, HRLCMS allowed us to have a depiction of the chemical diversity of both *Streptomyces* strains under the same analytical conditions.

The major components were determined through the use of HPLC-ELSD. The reference strain, *Streptomyces griseus* subsp. *griseus* DSM 40236^T, showed two main components: phenatic acid (RT 12.3 min), and a second one with RT 3.8 min, which could not be identified due to the lack of ionization in HRLCMS measurement. The major components in the Easter Island strain, *Streptomyces* sp. SN25_8.1, were determined as cycloheximide (RT 11.33 min) and actiphenol (RT 15.3 min).

Interestingly, *Streptomyces griseus* strains are well known for producing the antibiotic streptomycin, but this molecule was not produced by the strains under our experimental condition. In both *Streptomyces* strains, we found chemicals which did not show any match to known *Streptomyces* metabolites, suggesting potentially novel molecules. In the case of the Easter Island *Streptomyces* strain, we observed that the unknown chemical had a molecular weight of $[\text{M}+\text{H}]^+$ m/z 579.53381. This chemical showed a polyprotonation pattern, which points towards a peptide structure. The reference strain, *Streptomyces griseus* subsp. *griseus* DSM 40236^T showed an unknown metabolite with a molecular weight of $[\text{M}+\text{H}]^+$ m/z 813.59229. The isolation of these compounds from the crude extracts and chemical analyses would be necessary for structure elucidation.

samples (Figure 4C-D). For example, remarkable similarities were found in the aromatic proton zone (7-8 ppm), in the olefinic proton zone (of 4-6, ppm), and in the low frequency region (1.0-3.5 ppm), where aliphatic methyl, methylenes and methines are commonly found. However, abundant differences between the two spectra are apparent for example in the high frequency protons around 12.2-12.4 ppm, the broad peaks close to 8 ppm, olefinic signals around 5.5 ppm, and the methyl protons around 0.65 ppm. Further, in particular the strongly differing intensities in the mentioned regions suggest also the presence of large differences in the relative metabolite contributions in these mixtures.

As simple one-dimensional ^1H NMR profiles do not allow for a compound identification, attempts to identify some of the mixture components by high resolution LC-MS techniques (HRLCMS) were undertaken. Several molecules could be identified in both *Streptomyces* representatives based on their exact masses and a chemical database search. We observed that the two *Streptomyces* strains had a core chemical arsenal that is shared by both strains and an accessory chemical arsenal which seems to be strain specific (Figure 5). The identified core chemicals comprised gancidin W, YF-0200-R-B, emycin E, phenatic acid, netropsin, actiphenol, 6-beta-deoxy-5-hydroxy-tetracycline and TMC-86B. From the analysis of the accessory metabolites, we observed that the Easter Island representative, *Streptomyces* sp. SN25_8.1, produced seven detectable chemicals, which were: albidopyrone, cyclizidine, epithienamycin C, cycloheximide, SF-733C, protomycin and N-Valyldihydroxyhomoproline, as accessory metabolites. In contrast, we could detect only four chemicals in the reference strain *Streptomyces griseus* subsp. *griseus* DSM 40236^T as accessory metabolites, which were: fortimicin KK1, capromycin, YO-7625 and halstoctacosanolide B.

It is evident that the identified metabolites may be only a fraction of the total chemical components in the crude extracts. However, HRLCMS allowed us to have a depiction of the chemical diversity of both *Streptomyces* strains under the same analytical conditions.

The major components were determined through the use of HPLC-ELSD. The reference strain, *Streptomyces griseus* subsp. *griseus* DSM 40236^T, showed two main components: phenatic acid (RT 12.3 min), and a second one with RT 3.8 min, which could not be identified due to the lack of ionization in HRLCMS measurement. The major components in the Easter Island strain, *Streptomyces* sp. SN25_8.1, were determined as cycloheximide (RT 11.33 min) and actiphenol (RT 15.3 min).

Interestingly, *Streptomyces griseus* strains are well known for producing the antibiotic streptomycin, but this molecule was not produced by the strains under our experimental condition.

In both *Streptomyces* strains, we found chemicals which did not show any match to known *Streptomyces* metabolites, suggesting potentially novel molecules. In the case of the Easter Island *Streptomyces* strain, we observed that the unknown chemical had a molecular weight of $[\text{M}+\text{H}]^+$ m/z 579.53381. This chemical showed a polyprotonation pattern, which points towards a peptide structure. The reference strain, *Streptomyces griseus* subsp. *griseus* DSM 40236^T showed an unknown metabolite with a molecular weight of $[\text{M}+\text{H}]^+$ m/z 813.59229.

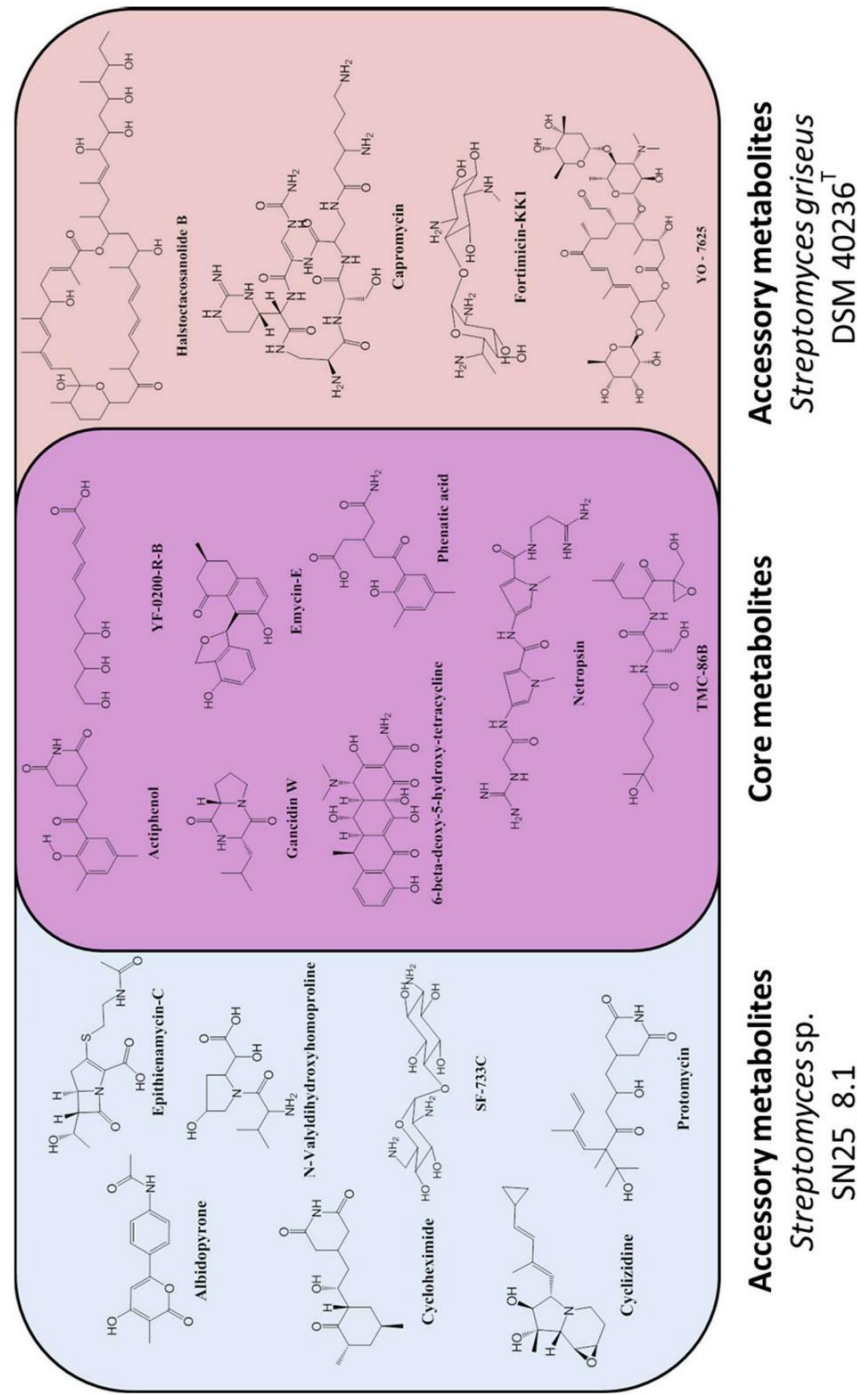

Figure 4. Chemical diversity of the studied *Streptomyces* representatives. Core metabolites: Metabolites shared by both strains. Accessory metabolites: Unique metabolites for each of the studied strains.

3.4. Antibiotic Activity

Antibiotic activity of the two *Streptomyces* crude extracts (Table 1) were evaluated through disc diffusion assay, using Gram-positive and Gram-negative bacteria. For the assay, we selected *Staphylococcus lentus* DSM 20352 and *Escherichia coli* DSM 498.

Table 1. Antibiotic activity of crude extracts.

Sample Tested	Inhibition Zone (mm)	
	<i>S. lentus</i> DSM 20352	<i>E. coli</i> DSM 498
<i>Streptomyces</i> sp. SN25_8.1	8	15
<i>Streptomyces griseus</i> subsp. <i>griseus</i> DSM 40236 ^T	8	20
Streptomycin	18	20

As shown in Table 1, the antibiotic activities of the crude extracts of both *Streptomyces* strains were quite similar as both produced an inhibition zone with the Gram-positive and the Gram-negative bacterium. Importantly, the crude extract of the reference strain, *Streptomyces griseus* subsp. *griseus* DSM 40236^T, had a stronger inhibitory effect against the Gram-negative bacterium, *E. coli*, which may be related to the higher concentrations of its components. The dereplication experiment suggested the presence of several metabolites with antibiotic activity like 6-beta-deoxy-5-hydroxy-tetracycline, gancidin W, phenatic acid and netropsin, which may be responsible for the observed antibiotic activity to both Gram-positive and Gram-negative bacteria. Streptomycin was used as a positive control.

4. Discussion

Much effort is being made for the isolation of new biologically active *Streptomyces* strains [41], since this genus has been found to be a reliable source of chemicals with human health application [42]. However, a significant number of new *Streptomyces* isolates are affiliated through the 16S rRNA molecular marker to already described species [43], a reason why they are also considered to be identical in secondary metabolite production.

Recent studies have proposed alternative analyses to determine the dissimilarity of closely related *Streptomyces* strains, such as: polyphasic characterization, multilocus sequence typing and full genome sequencing [19,44], which have shown to be a more precise tool for phylogenetic clarification and secondary metabolite dereplication [45–48]. None of these studies have dealt with the aspect of the large-scale geographic separation of the *Streptomyces* strains, which was investigated.

Alternatively, a direct comparison through the laboratory growth of *Streptomyces* still remains a more affordable and rapid way of determining how similar the metabolite profiles of the two strains are. Once grown, the studied *Streptomyces* can be compared using HRLCMS and ¹H NMR techniques, which vastly help in the dereplication process, since they are quite informative about the chemical identities and functionalities of the crude extracts.

Our results showed that *Streptomyces* closely related through the 16S rRNA gene marker presented differences in macroscopic features (pigmentation, aerial hyphae distribution, colony morphology), but kept similarities in cell morphology. In terms of secondary metabolite production, we found that closely related *Streptomyces* species kept a common set of chemicals, which has been addressed as core secondary metabolites [49]. This fact is in agreement with the common knowledge that *Streptomyces* strains with similar 16S rRNA gene sequences produce identical chemicals [44]. However, our finding also indicated that *Streptomyces* strains have a set of accessory secondary metabolites that are unique for each isolate, despite of the identical 16S rRNA gene sequences. These findings have also been observed in other *Streptomyces* species. For example, Antony-Babu et al. [19], developed a polyphasic analysis of 10 different *Streptomyces* strains with identical 16S rRNA gene sequences and they found, that by evaluating characteristic features like halotolerance, optimal pH growth, coloration and GC content at least 5 out of 10 clearly diverged as new species. These results were further supported with a

multilocus sequence analysis and phylogenetic tree. This study also showed the production of a core set of secondary metabolites and an accessory chemical diversity.

Another example was provided by Vicente et al. [44], who performed a similar study, but evaluated the genomes of six closely related *Streptomyces* strains. The evaluation of the biosynthetic gene clusters showed that the analyzed *Streptomyces* strains kept a core set of secondary metabolites and in addition, a set of strain-specific metabolites. Interestingly, Vicente et al. [44] also reported a set of chemicals with wide presence in *Streptomyces*, such as melanin, desferrioxamine B, hopene, isorenieratene and geosmin. However, none of them could be detected in our experimental work. This observation might be related with the evolutionary distance between *S. griseus* strains and the *Streptomyces* strains used by Vicente et al. [44]. This last finding may also be an indication of species-specific metabolites. Interestingly, Vicente et al. [44] also reported chromosome reorganization events (pericentral inversion) and suggested horizontal gene transfer for the acquisition of biosynthetic gene clusters for strain-specific secondary metabolites. Finally, this study also conveyed the finding of unknown biosynthetic gene clusters, suggesting potential for novel chemistry production.

Our data indicated that *Streptomyces* strains of the same species, isolated from geographical distant locations, can show important differences in the metabolite profiles. These may be overlooked if solely a genetic marker such 16S rRNA gene sequence is used as an indicator of secondary metabolite diversity. As described previously, genome sequencing and comparison, multilocus gene analysis or growth experiments associated with chemical analysis are three suitable alternatives to dereplicate closely related *Streptomyces* strains. This strategy can represent a valuable source of metabolites with biomedical and industrial application, by preventing the discard of unstudied *Streptomyces*.

Secondary metabolite production in *Streptomyces* is not essential for their life cycle, however these metabolites confer an evolutionary advantage over competitors, since these molecules can be used as a chemical weapon to control other bacterial and fungal competitors (deterrence, inhibition, decease). Since *Streptomyces* can profit from these molecules, *Streptomyces* might adapt their chemical arsenal in function of their habitat and their competitors to succeed in new environments.

It remains an open but interesting question, how genes necessary for the production of a particular secondary metabolite have been gained by individual *Streptomyces* strains. Different researchers have discussed this process in other actinobacterial genera, and the most widely accepted hypothesis is the horizontal transfer of genes (HGT) of entire biosynthetic pathways [50], which may have direct relation to the environment in which the *Streptomyces* strains are dwelling. However, gene duplication, mutation and genetic rearrangement should also not be discarded in the process of modifying secondary metabolite biosynthetic pathways. The gain and loss of secondary metabolites may be considered as a biochemical evolution of *Streptomyces* strains, since the process of selecting and discarding genes for the production of secondary metabolites may have direct relation to the environmental competition and survival needs of the strain. It seems reasonable to assume that phylogenetic almost identical *Streptomyces* strains may have diverged from a common ancestor because of their genetic and chemical similarities. Within a sufficient timeframe, *Streptomyces* strains may have acquired new biosynthetic abilities to produce different secondary metabolites, because of the need to adapt and specialize in their particular ecological niche. Environmental pressure may be a driving force for the retention/discarding/acquisition of the secondary metabolite genes. It has been shown that *Streptomyces* strains are capable of spontaneous combination of genetic information [21,51], generating previously unknown chemical hybrids [52]. However, it is not known for how long these naturally occurring *Streptomyces* hybrids have existed in the environment since many factors may influence the success of the new ecotypes.

5. Conclusions

We established that 16S rRNA gene sequences do not provide information reliable enough to evaluate the chemodiversity of *Streptomyces* strains since our analyses of the metabolite profiles showed differences in the production of secondary metabolites of strains identical on the basis of this genetic

marker. While we found a core set of secondary metabolites that is identical in both strains, a set of even more diverse accessory metabolites appear to be strain specific. Based on the phylogenetic closeness and the similarity of the metabolites, it is suggested that both *Streptomyces* had a common origin which went through a subsequent specialization in function of their habitat. In conclusion, this study has demonstrated that *Streptomyces* strains, with an identical phylogenetic classification to already known strains, still represent a diverse and putative source of novel secondary metabolites with potential for drug discovery; therefore, they should not be discarded in screening processes for bioprospection.

Supplementary Materials: The following are available online at <http://www.mdpi.com/2076-2607/7/6/166/s1>, Figure S1: 16S rRNA gene sequence alignment of the *Streptomyces* strains. Supplementary materials also contains dereplication overview, the individual identification of the molecules, their structures and chemical data, as well as antibiotic activity of the crude extracts.

Author Contributions: I.S., J.F.I. and J.W. planned the experiments, I.S. performed the experiments, analyzed and evaluated the data and wrote the first draft of the publication. J.F.I., F.D.S. and J.W. supervised the work and revised the manuscript. M.L. and N.P. acquired LCMS and NMR data. F.D.S. acquired and analyzed NMR data.

Funding: We thank the Deutscher Akademischer Austauschdienst (DAAD) for financial support under the stipend # PKZ91564794. NP thanks the Deutsche Bundesstiftung Umwelt (German Federal Environmental Foundation) for a predoctoral fellowship.

Acknowledgments: We thank Marion Höftmann and Gitta Kohlmeyer-Yilmaz for her valuable help with the NMR data acquisition. We thank Ute Hentschel Humeida (GEOMAR Helmholtz Centre for Ocean Research Kiel) for her support during the research. We also thank the Center for Molecular Biosciences (ZMB) at Kiel University for providing sequence technology. We thank Tanja Rahn for her help in microscopy recording. Finally, I.S. thanks Millaray Sierra for her support during the research.

Conflicts of Interest: The authors declare no conflict of interest.

References

1. Mohammadipanah, F.; Wink, J. *Actinobacteria* from arid and desert habitats: Diversity and biological activity. *Front. Microbiol.* **2016**, *6*, 1541. [[CrossRef](#)] [[PubMed](#)]
2. Barka, E.A.; Vatsa, P.; Sanchez, L.; Gaveau-Vaillant, N.; Jacquard, C.; Klenk, H.-P.; Clément, C.; Ouhdouch, Y.; van Wezel, G.P. Taxonomy, physiology, and natural products of *Actinobacteria*. *Microbiol. Mol. Biol. Rev.* **2016**, *80*, 1–43. [[CrossRef](#)]
3. Challis, G.L.; Hopwood, D.A. Synergy and contingency as driving forces for the evolution of multiple secondary metabolite production by *Streptomyces* species. *Proc. Natl. Acad. Sci. USA* **2003**, *100*, 14555–14561. [[CrossRef](#)] [[PubMed](#)]
4. Metsä-Ketelä, M.; Salo, V.; Halo, L.; Hautala, A.; Hakala, J.; Mäntsälä, P.; Ylihonko, K. An efficient approach for screening minimal PKS genes from *Streptomyces*. *FEMS Microbiol. Lett.* **1999**, *180*, 1–6. [[CrossRef](#)]
5. Miao, V.; Brost, R.; Chapple, J.; She, K.; Gal, M.-F.C.-L.; Baltz, R.H. The lipopeptide antibiotic A54145 biosynthetic gene cluster from *Streptomyces fradiae*. *J. Ind. Microbiol. Biotechnol.* **2006**, *33*, 129–140. [[CrossRef](#)] [[PubMed](#)]
6. Shen, B.; Du, L.; Sanchez, C.; Edwards, D.J.; Chen, M.; Murrell, J.M. The biosynthetic gene cluster for the anticancer drug bleomycin from *Streptomyces verticillus* ATCC15003 as a model for hybrid peptide–polyketide natural product biosynthesis. *J. Ind. Microbiol. Biotechnol.* **2001**, *27*, 378–385. [[CrossRef](#)] [[PubMed](#)]
7. Jang, K.H.; Nam, S.J.; Locke, J.B.; Kauffman, C.A.; Beatty, D.S.; Paul, L.A.; Fenical, W. Anthracimycin, a potent anthrax antibiotic from a marine-derived actinomycete. *Angew. Chem. Int. Ed.* **2013**, *52*, 7822–7824. [[CrossRef](#)]
8. Abou-Zeid, A.; El-Sherbini, S. Fermentative production of cycloheximide by *Streptomyces griseus* and *Streptomyces noursei*. *J. Appl. Chem. Biotechnol.* **1974**, *24*, 283–291. [[CrossRef](#)]
9. Nachtigall, J.; Kulik, A.; Helaly, S.; Bull, A.T.; Goodfellow, M.; Asenjo, J.A.; Maier, A.; Wiese, J.; Imhoff, J.F.; Süßmuth, R.D.; et al. Atacamycins A–C, 22-membered antitumor macrolactones produced by *Streptomyces* sp. C38*. *J. Antibiot.* **2011**, *64*, 775–780. [[CrossRef](#)]
10. Sehgal, S.N. Rapamune® (RAPA, rapamycin, sirolimus): Mechanism of action immunosuppressive effect results from blockade of signal transduction and inhibition of cell cycle progression. *Clin. Biochem.* **1998**, *31*, 335–340. [[CrossRef](#)]

11. Encheva-Malinova, M.; Stoyanova, M.; Avramova, H.; Pavlova, Y.; Gocheva, B.; Ivanova, I.; Moncheva, P. Antibacterial potential of streptomycete strains from Antarctic soils. *Biotechnol. Biotechnol. Equip.* **2014**, *28*, 721–727. [[CrossRef](#)]
12. Idris, H.; Labeda, D.P.; Nouioui, I.; Castro, J.F.; del Carmen Montero-Calasanz, M.; Bull, A.T.; Asenjo, J.A.; Goodfellow, M. *Streptomyces aridus* sp. nov., isolated from a high altitude Atacama Desert soil and emended description of *Streptomyces noboritoensis* Isono et al. 1957. *Antonie Van Leeuwenhoek* **2017**, *110*, 705–717. [[CrossRef](#)]
13. Malviya, M.K.; Pandey, A.; Trivedi, P.; Gupta, G.; Kumar, B. Chitinolytic activity of cold tolerant antagonistic species of *Streptomyces* isolated from glacial sites of Indian Himalaya. *Curr. Microbiol.* **2009**, *59*, 502–508. [[CrossRef](#)]
14. Book, A.J.; Lewin, G.R.; McDonald, B.R.; Takasuka, T.E.; Doering, D.T.; Adams, A.S.; Blodgett, J.A.V.; Clardy, J.; Raffa, K.F.; Fox, B.G.; et al. Cellulolytic *Streptomyces* strains associated with herbivorous insects share a phylogenetically linked capacity to degrade lignocellulose. *Appl. Environ. Microbiol.* **2014**, *80*, 4692–4701. [[CrossRef](#)]
15. Schneemann, I.; Nagel, K.; Kajahn, I.; Labes, A.; Wiese, J.; Imhoff, J.F. Comprehensive investigation of marine *Actinobacteria* associated with the sponge *Halichondria panicea*. *Appl. Environ. Microbiol.* **2010**, *76*, 3702–3714. [[CrossRef](#)]
16. Dalisay, D.S.; Williams, D.E.; Wang, X.L.; Centko, R.; Chen, J.; Andersen, R.J. Marine sediment-derived *Streptomyces* bacteria from British Columbia, Canada are a promising microbiota resource for the discovery of antimicrobial natural products. *PLoS ONE* **2013**, *8*, e77078. [[CrossRef](#)]
17. Zhao, X.-Q.; Li, W.-J.; Jiao, W.-C.; Li, Y.; Yuan, W.-J.; Zhang, Y.-Q.; Klenk, H.-P.; Suh, J.-W.; Bai, F.-W. *Streptomyces xinghaiensis* sp. nov., isolated from marine sediment. *Int. J. Syst. Evol. Microbiol.* **2009**, *59*, 2870–2874. [[CrossRef](#)]
18. Kamjam, M.; Sivalingam, P.; Deng, Z.; Hong, K. Deep sea actinomycetes and their secondary metabolites. *Front. Microbiol.* **2017**, *8*. [[CrossRef](#)]
19. Antony-Babu, S.; Stien, D.; Eparvier, V.; Parrot, D.; Tomasi, S.; Suzuki, M.T. Multiple *Streptomyces* species with distinct secondary metabolomes have identical 16S rRNA gene sequences. *Sci. Rep.* **2017**, *7*, 11089. [[CrossRef](#)]
20. Guo, Y.; Zheng, W.; Rong, X.; Huang, Y. A multilocus phylogeny of the *Streptomyces griseus* 16S rRNA gene clade: Use of multilocus sequence analysis for streptomycete systematics. *Int. J. Syst. Evol. Microbiol.* **2008**, *58*, 149–159. [[CrossRef](#)]
21. Doroghazi, J.R.; Buckley, D.H. Widespread homologous recombination within and between *Streptomyces* species. *ISME J.* **2010**, *4*, 1136. [[CrossRef](#)]
22. Choudoir, J.M.; Pepe-Ranne, C.; Buckley, H.D. Diversification of secondary metabolite biosynthetic gene clusters coincides with lineage divergence in *Streptomyces*. *Antibiotics* **2018**, *7*, 12. [[CrossRef](#)]
23. Romano, S.; Jackson, S.A.; Patry, S.; Dobson, A.D.W. Extending the “one strain many compounds” (OSMAC) principle to marine microorganisms. *Mar. Drugs* **2018**, *16*, 244. [[CrossRef](#)]
24. Kim, E.; Song, M.C.; Kim, M.S.; Beom, J.Y.; Jung, J.A.; Cho, H.S.; Yoon, Y.J. One-pot combinatorial biosynthesis of glycosylated anthracyclines by cocultivation of *Streptomyces* strains producing aglycones and nucleotide deoxysugars. *ACS Comb. Sci.* **2017**, *19*, 262–270. [[CrossRef](#)]
25. Rückert, C.; Albersmeier, A.; Busche, T.; Jaenicke, S.; Winkler, A.; Friðjónsson, Ó.H.; Hreggviðsson, G.Ó.; Lambert, C.; Badcock, D.; Bernaerts, K.; et al. Complete genome sequence of *Streptomyces lividans* TK24. *J. Biotechnol.* **2015**, *199*, 21–22. [[CrossRef](#)]
26. Wakefield, J.; Hassan, H.M.; Jaspars, M.; Ebel, R.; Rateb, M.E. Dual induction of new microbial secondary metabolites by fungal bacterial co-cultivation. *Front. Microbiol.* **2017**, *8*. [[CrossRef](#)]
27. Krainsky, A. Die Aktinomyceten und ihre Bedeutung in der Natur, Centr. Bakteriol. Parasitenk. *Abt. II.* **1914**, *42*, 649–688.
28. Waksman, S.; Henrici, A. Family III. Streptomycetaceae Waksman and Henrici. In *Bergey's Manual of Determinative Bacteriology*; Williams & Wilkins: Baltimore, MD, USA, 1948; pp. 929–977.
29. Atlas, R.M. *Handbook of Microbiological Media*, 4th ed.; CRC Press: Boca Raton, FL, USA, 2010; p. 2036.

30. Goodfellow, M.; Fiedler, H.-P. A guide to successful bioprospecting: Informed by actinobacterial systematics. *Antonie Van Leeuwenhoek* **2010**, *98*, 119–142. [[CrossRef](#)]
31. Lane, D. 16S/23S rRNA sequencing. In *Nucleic Acid Techniques in Bacterial Systematics*; Stackebrandt, E., Goodfellow, M., Eds.; John Wiley and Sons: Chichester, UK, 1991; pp. 115–175.
32. Staufenberger, T.; Vera, T.; Jutta, W.; Imhoff, J.F. Phylogenetic analysis of bacteria associated with *Laminaria saccharina*. *FEMS Microbiol. Ecol.* **2008**, *64*, 65–77. [[CrossRef](#)]
33. Ellis, R.J.; Morgan, P.; Weightman, A.J.; Fry, J.C. Cultivation-dependent and -independent approaches for determining bacterial diversity in heavy-metal-contaminated soil. *Appl. Environ. Microbiol.* **2003**, *69*, 3223–3230. [[CrossRef](#)]
34. Frank, J.A.; Reich, C.I.; Sharma, S.; Weisbaum, J.S.; Wilson, B.A.; Olsen, G.J. Critical evaluation of two primers commonly used for amplification of bacterial 16S rRNA genes. *Appl. Environ. Microbiol.* **2008**, *74*, 2461–2470. [[CrossRef](#)]
35. Yoon, S.-H.; Ha, S.-M.; Kwon, S.; Lim, J.; Kim, Y.; Seo, H.; Chun, J. Introducing EzBioCloud: A taxonomically united database of 16S rRNA gene sequences and whole-genome assemblies. *Int. J. Syst. Evol. Microbiol.* **2017**, *67*, 1613–1617. [[CrossRef](#)]
36. Quast, C.; Pruesse, E.; Yilmaz, P.; Gerken, J.; Schweer, T.; Yarza, P.; Peplies, J.; Glöckner, F.O. The SILVA ribosomal RNA gene database project: Improved data processing and web-based tools. *Nucleic Acids Res.* **2013**, *41*, D590–D596. [[CrossRef](#)]
37. Artimo, P.; Jonnalagedda, M.; Arnold, K.; Baratin, D.; Csardi, G.; de Castro, E.; Duvaud, S.; Flegel, V.; Fortier, A.; Gasteiger, E.; et al. ExPASy: SIB bioinformatics resource portal. *Nucleic Acids Res.* **2012**, *40*, W597–W603. [[CrossRef](#)]
38. Kumar, S.; Stecher, G.; Tamura, K. MEGA7: Molecular evolutionary genetics analysis version 7.0 for bigger datasets. *Mol. Biol. Evol.* **2016**, *33*, 1870–1874. [[CrossRef](#)]
39. Cheng, Y.B.; Jensen, P.R.; Fenical, W. Cytotoxic and antimicrobial napyradiomycins from two marine-derived *Streptomyces* strains. *Eur. J. Org. Chem.* **2013**, *2013*, 3751–3757. [[CrossRef](#)]
40. Bondi, A., Jr.; Spaulding, E.H.; Smith Dorothy, E.; Catherine, C. A routine method for the rapid determination of susceptibility to penicillin and other antibiotics. *Am. J. Med. Sci.* **1947**, *213*, 221–225. [[CrossRef](#)]
41. Parte, A.C. LPSN—List of prokaryotic names with standing in nomenclature (bacterio.net), 20 years on. *Int. J. Syst. Evol. Microbiol.* **2018**, *68*, 1825–1829. [[CrossRef](#)]
42. Anderson, A.S.; Wellington, E.M. The taxonomy of *Streptomyces* and related genera. *Int. J. Syst. Evol. Microbiol.* **2001**, *51*, 797–814. [[CrossRef](#)]
43. Singh, V.; Praveen, V.; Khan, F.; Tripathi, C.K.M. Phylogenetics of an antibiotic producing *Streptomyces* strain isolated from soil. *Bioinformation* **2009**, *4*, 53–58. [[CrossRef](#)]
44. Vicente, C.M.; Thibessard, A.; Lorenzi, J.-N.; Benhadj, M.; Hôtel, L.; Gacemi-Kirane, D.; Lespinet, O.; Leblond, P.; Aigle, B. Comparative genomics among closely related *Streptomyces* strains revealed specialized metabolite biosynthetic gene cluster diversity. *Antibiotics* **2018**, *7*, 86. [[CrossRef](#)] [[PubMed](#)]
45. Antony-Babu, S.; Stach, J.E.M.; Goodfellow, M. Genetic and phenotypic evidence for *Streptomyces griseus* ecovars isolated from a beach and dune sand system. *Antonie Van Leeuwenhoek* **2008**, *94*, 63–74. [[CrossRef](#)] [[PubMed](#)]
46. Rong, X.; Liu, N.; Ruan, J.; Huang, Y. Multilocus sequence analysis of *Streptomyces griseus* isolates delineating intraspecific diversity in terms of both taxonomy and biosynthetic potential. *Antonie Van Leeuwenhoek* **2010**, *98*, 237–248. [[CrossRef](#)] [[PubMed](#)]
47. Sullivan, M.J.; Petty, N.K.; Beatson, S.A. Easyfig: A genome comparison visualizer. *Bioinformatics* **2011**, *27*, 1009–1010. [[CrossRef](#)] [[PubMed](#)]
48. Weber, T.; Blin, K.; Duddela, S.; Krug, D.; Kim, H.U.; Brucoleri, R.; Lee, S.Y.; Fischbach, M.A.; Müller, R.; Wohlleben, W.; et al. AntiSMASH 3.0—A comprehensive resource for the genome mining of biosynthetic gene clusters. *Nucleic Acids Res.* **2015**, *43*, W237–W243. [[CrossRef](#)] [[PubMed](#)]
49. Seipke, R.F. Strain-level diversity of secondary metabolism in *Streptomyces albus*. *PLoS ONE* **2015**, *10*, e0116457. [[CrossRef](#)]
50. Ziemert, N.; Lechner, A.; Wietz, M.; Millán-Aguñaga, N.; Chavarría, K.L.; Jensen, P.R. Diversity and evolution of secondary metabolism in the marine actinomycete genus *Salinispora*. *Proc. Natl. Acad. Sci. USA* **2014**, *111*, E1130. [[CrossRef](#)] [[PubMed](#)]

51. Stoycheva, Z.; Todorov, T.; Peltekova, V. Intergeneric crosses between *Streptomyces ambofaciens* and *Saccharopolyspora erythraea*. *Folia Microbiol.* **1994**, *39*, 13–18. [[CrossRef](#)]
52. Alačević, M. Interspecific Recombination in *Streptomyces*. *Nature* **1963**, *197*, 1323. [[CrossRef](#)]



© 2019 by the authors. Licensee MDPI, Basel, Switzerland. This article is an open access article distributed under the terms and conditions of the Creative Commons Attribution (CC BY) license (<http://creativecommons.org/licenses/by/4.0/>).

VII. Discussion

1. Easter Island actinobacterial diversity

The performed investigation showed a high diversity and novelty of Actinobacteria from the coastal zone of Easter Island, a total of 163 pure cultures were obtained, which represented 72 phylotypes distributed in 20 different genera. From the sequencing and analysis of the 16S rRNA gene, we determined that at least 45% of the obtained strains may represent new species, which confirmed the observation that unexplored habitats still remain as a valuable source of novel bacterial taxa (Villalobos et al. 2018; Viver et al. 2015). *Streptomyces* and *Micromonospora* genera have been shown to be the most commonly reported Actinobacteria genera in terrestrial and marine samples (Maldonado et al. 2009; Nimaichand et al. 2015). This observation was also valid for the coastal zone actinobacterial diversity at Easter Island. Furthermore, we found one representative of the genus *Salinispora*, *S. arenicola*, a strict marine actinobacterium that has only been reported once in Fiji in the South Pacific Ocean (Millán-Aguíñaga et al. 2017), thus extending its distribution to Easter Island.

The richest sources of Actinobacteria found in this study were; marine sediment, a marine invertebrate, and a submerged marine stone. These findings agreed with other studies, in which marine invertebrates, like sponges, and marine sediment hold high actinobacterial richness (Jensen et al. 2005; Schneemann et al. 2010b). Interestingly, marine stones are rarely studied, despite their capacity to harbor remarkable actinobacterial diversity, as shown in this study. The influence of the culture medium was also analyzed and showed great relevance, since we observed that there was specificity in some actinobacterial genera for determined culture media. For example, the genus *Yimella* was only obtained in the medium BCM. Similarly, the genera *Ornithinimicrobium* and *Geodermatophilus* were only isolated with the medium SIMA1. These observations may facilitate the isolation of these actinobacterial groups, since they may specifically be isolated using these media in future efforts.

Considering previous studies developed in Easter Island, which were focused in Actinobacteria isolation, we observed that Vezina et al. (1975), isolated a single actinobacterial representative, *Streptomyces hygroscopicus* (rapamycin producer), which was not found in our investigation. This observation made clear the distribution of *Streptomyces hygroscopicus* at Easter Island was limited to terrestrial niches and not marine ones. Furthermore, Cumsille et al. (2017)

reported the isolation of sponge derived Actinobacteria from the offshore of Easter Island, where a total of 14 different genera were obtained. Remarkably, most of them belong to the commonly considered rare Actinobacteria. Some of the obtained rare actinobacterial representatives belong to the following genera; *Brachybacterium*, *Micrococcus*, *Brevibacterium*, *Janibacter*, *Knoellia*, *Kytococcus*, *Nesterenkonia*, *Gordonia*, *Serinococcus* and *Kocuria*. Interestingly, none of these rare actinobacterial genera were obtained in our study. However, there was a minor overlap between Cumsille et al. (2017) study and our results, these were the genera *Streptomyces*, *Arthrobacter*, *Rhodococcus*, and *Nocardioides*. Additionally, Cumsille et al. (2017) reported *Micrococcus*, *Kocuria* and *Streptomyces* as the most abundant actinobacterial genera. In contrast, our investigation determined that the most abundant genera in our marine-derived samples were *Micromonospora*, *Streptomyces* and *Dietzia*. Inconveniently, they did not pursue the investigation in the species level, which hindered a deeper understanding of the actinobacterial distribution.

2. Geographical distribution of Actinobacteria

When the Actinobacteria genera were evaluated in function of their geographical distribution on the coastal zone of Easter Island, we found that there was an Actinobacteria hotspot, Zone 6, from this single sample zone we obtained 18 different actinobacterial genera. In contrast, other sampling zones produced only 2-9 actinobacterial genera. The reason of this large difference is not clear, but it may be hypothesized that it has relation with the nutrient availability in Zone 6, which receives the rain runoff through a small watercourse. This input may bring plant exudates, minerals and other nutritive sources that affect positively the actinobacterial development. Further research needs to be made in order to clarify this speculation.

Because Easter Island is an isolated location in the Southern Pacific ocean, we wondered if our isolates were related with a specific zone of the world. To answer this question, we made a connection map between our isolates and the closest isolates worldwide using the 16S rRNA gene sequence as a reference marker. The comparison is presented in **Figure 14**, which is a world map with the connections between Easter Island actinobacterial representatives and their closest relatives worldwide, represented in function of their geographical origin. The depiction of the map revealed that Easter Island Actinobacteria are more closely associated to Asia than other geographical areas. Remarkably, no correlation was found with Hawaii, which has a similar

(oceanic volcano) origin than Easter Island. A weak point of our correlation may be the lack of data for Hawaii and Latin America.

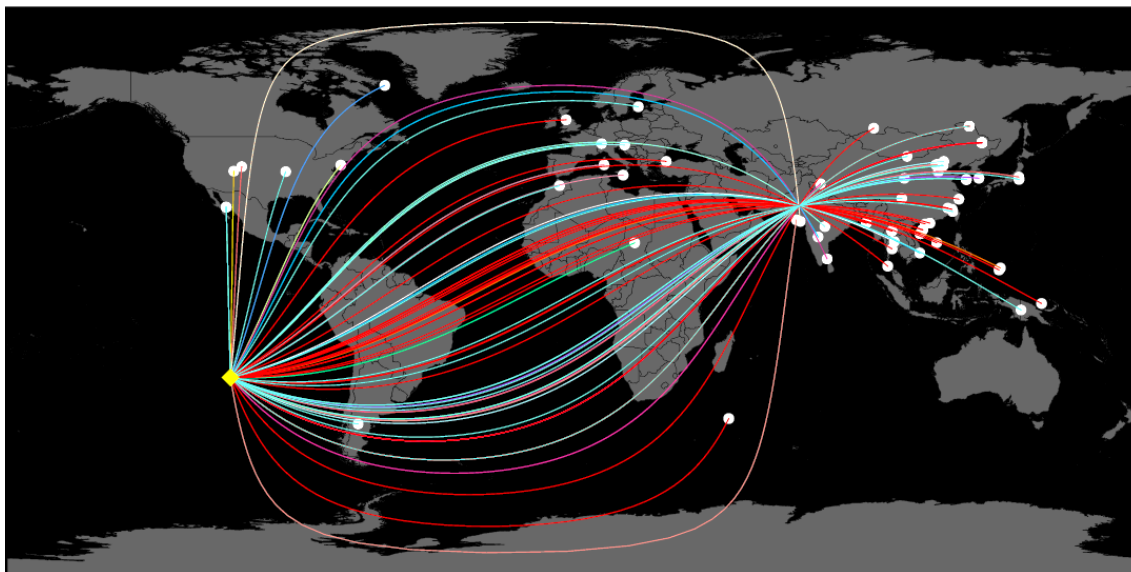

Figure 14 Connection map of Easter Island actinobacterial isolates and their closest relatives worldwide. Closeness determined in base of the 16S rRNA gene sequence. Yellow diamond: Origin (Easter Island). White circle: Closest actinobacterial relative.

3. Marine invertebrates, Actinobacteria and secondary metabolites

The dereplication of the Easter Island sea anemone, *Gyactis sesere*, reported the identification of two known anthraquinones, Lupinacidin A and Galvaquinone B, which have also been identified in terrestrial and marine actinobacterial representatives belonging to the *Micromonospora* and *Streptomyces* genera (Hu et al. 2012; Igarashi et al. 2007). This finding motivated the cultivation and chemical characterization of the sea anemone actinobacterial symbionts resulting in the clarification that an actinobacterial strain, *Verrucosispora* sp. SN26_14.1 was the actual producer of the chemicals.

A few years ago, this finding would have been controversial since it has extensible been assumed that marine invertebrates are producers of a large chemical diversity (Blunt et al. 2016). However it has been shown more recently that marine invertebrate symbionts are the real producers of many of these chemicals. A well-known example are marine sponges, which have shown an impressive chemical richness (Blunt et al. 2016), but it has progressively been revealed that the real

producers of the chemicals are microbial symbionts (Tianero et al. 2019). This observation is not limited to marine sponges, since other invertebrates like tunicates have shown the same pattern, in which the chemicals stored by the invertebrate were ultimately produced by microbes (Schofield et al. 2015). Although, this clarification tendency is growing, there are also cases in which the real producer of the secondary metabolites are the marine invertebrates and not the microbes, as is the case of sea cucumbers, which produced triterpenic saponins in specialized organs called Cuvier glands (Bahrami and Franco 2016; Kerr and Chen 1995). Sea anemones have not been extensively studied in microbiological and chemical terms, but the studies dealing with their chemistry have indicated the production of alkaloids (Cachet et al. 2009), peptides (Honma and Shiomi 2006), terpene derivatives (Yu et al. 2014) and toxins (Schweitz et al. 1981). The microbiology associated to sea anemones has not been developed comprehensively, but there are a few examples (Du et al. 2010; Schuett et al. 2007). For instance, a recent study of a sea anemone associated fungus, *Nigrospora* sp., revealed the production of nine anthraquinones, however the researchers did not analyze the sea anemone tissue to test the presence of the anthraquinones (Yang et al. 2012). Since sea anemones hold symbionts that produced anthraquinones, it is interesting to speculate what function these chemicals may play. It has been shown that anthraquinones can chelate metals ions like calcium, magnesium and zinc (Lee et al. 2016; Suemitsu 1963; Yeap et al. 2015) and in addition, have also shown activity to inhibit biofilm formation (Lee et al. 2016). More research is needed to clarify the function of these chemicals in sea anemones, due to their importance for harboring microorganisms that produce anthraquinones.

Finally, today there is lack of understanding in how marine invertebrates and microorganisms can co-evolve and generate interdependent relationships. Furthermore, there is almost no research involving how marine invertebrates can recruit bacteria or other microorganisms, which in turn may produce chemicals with a functional benefit for a given invertebrate that can be used as mechanism of defense (deterrent), sexual reproduction cue (pheromone) or even as a chemical modulator (chelator). In the coming future, it should be expected that microbiology and chemical ecology fused to be able to answer this chemical-evolutionary questions which would help to understand how a microbiome is generated and shaped.

4. 16S rRNA gene sequence as an indicator for chemical novelty

The isolation of *Streptomyces* strains is frequently reported in microbiological diversity studies, since they are one of the most abundant actinobacterial representatives (Jiang et al. 2007; Zhang et al. 2006). Despite their large diversity, it is common to find *Streptomyces* strains which have a very similar 16S rRNA gene sequence and therefore, are assumed as the same species (Antony-Babu et al. 2017). This observation undermines the real chemical capacity of *Streptomyces* strains. Therefore, we have evaluated two phylogenetically almost identical *Streptomyces*, which were isolated from geographically distant locations. Our data showed that despite the $\geq 99\%$ of similarity of the 16S rRNA, the compared *Streptomyces griseus* strains showed evident differences in morphology, pigmentation and spore formation. The analysis of the secondary metabolites showed a core set of metabolites which was identical in both strains. In addition, we found an accessory set of the metabolites which seemed to be strain specific. Both strains showed indications of chemical novelty, thus confirming the chemical potential of *Streptomyces*, even after several decades of drug research studies. Our results indicated that the 16S rRNA gene is not an appropriate marker to determine chemodiversity and novelty. Recently, Antony-Babu et. al (2017) has proposed that multilocus gene analysis is a more suitable and sensitive phylogenetic classification alternative to dereplicate closely related *Streptomyces* strains. Specifically, they suggest the use of a set of protein-coding housekeeping genes, such as *atpD*, *gyrB*, *recA*, *rpoB* and *trpB* for the construction of phylogenetic trees. This new strategy can facilitate the discerning process on drug research for a given *Streptomyces* strain.

Vicente et al. (2018) performed a similar study using closely related *Streptomyces* through comparative genomics and evaluated the different biosynthetic gene clusters contained in six different strains. The study also determined that there was a core set of secondary metabolites in the *Streptomyces* genomes, which was represented by melanin, ectoine, desferrioxamine B, lbaflavenone, hopene, isorenieratene and geosmin. Remarkably, none of these chemical were found in our analysis suggesting that there is not secondary metabolites generalism among different *Streptomyces* species. Vicente et al. (2018) also observed an accessory strain specific chemical diversity for each *Streptomyces* strain evaluated, however the evaluation was only made in the genetic level with no chemical analysis of the accessory metabolites.

Nowadays, different approaches of elicitation have been developed in order to obtain a larger chemical diversity of microorganisms that have been used extensively, like *Streptomyces*. Examples of elicitation strategies are, one strain many chemicals (Romano et al. 2018) and co-

cultivation procedures (Wu et al. 2018). It would be quite interesting to see the performance of two phylogenetically identical, but geographical distant *Streptomyces*, under elicitation conditions. This would contribute to the understanding of the secondary metabolite expression.

5. Gene transference and secondary metabolites

It may be reasonable to think that secondary metabolites may vary depending of the geographical location, as it has been shown in this study. Geographically distant *Streptomyces* strains showed a core set of secondary metabolites which was shared by the studied *Streptomyces griseus* strains. Concurrently, *Streptomyces griseus* strains also showed an accessory set of secondary metabolites, which was strain specific. This finding may be evidence that both strains may have shared a common origin and that from the point of rift, they have been acquiring new secondary metabolites biosynthetic potentials. It has been postulate that horizontal gene transference may play a role in the exchange and recruit of secondary metabolites genes (Ziemert et al. 2014). Secondary metabolites, specially antibiotic and antifungal molecules can confer advantage for competition in the environment, thus confining the nutritive resources to the organisms with the biochemical weapons to restrict the area or with the evolutionary tools for antibiotic tolerance. How *Streptomyces* recruit specific genes for secondary metabolites production, remains as an open question. It is interesting to speculate how the transference of genes occurs in the ocean, if there is a certain degree of control on what genes to acquire and for how long these genes may be held, if they are not beneficial. We think that our results may be applied to other actinobacterial genera, under the premise that accessory secondary metabolites are strain and geographically specific. Therefore, phylogenetically almost identical actinobacterial representatives should not be discarded for chemical investigation, even when they show very high similarity on the 16S rRNA marker.

VIII. Concluding remarks

1. Easter Island actinobacterial diversity

The investigation of samples from the coastal zone of Easter Island showed a high actinobacterial diversity and novelty, providing 72 phlotypes distributed in 20 different actinobacterial genera. Furthermore, 32 out of 72 phlotypes were associated to novel species in the genera *Micromonospora*, *Streptomyces*, *Nocardioides*, *Aeromicrobium*, *Dactylosporangium* and *Nonomuraea*. Interestingly, our data suggested the isolation of a new actinobacterial genus, isolate SN27_500, which didn't associated with its next related reference genera (*Serinicoccus* and *Ornithinimicrobium*) in the phylogenetic tree analysis. *Micromonospora*, *Streptomyces*, and *Salinispora* had the widest distribution in the Easter Island sample locations. Easter Island showed dissimilar actinobacterial diversity depending on the geographical origin, revealing a high degree of niche specialization. Finally, our data showed that Easter Island was indeed a rich source of novel Actinobacteria.

2. Antitumoral anthraquinones from an Easter Island sea anemone and their actinobacterial production

The chemical investigation of an Easter Island sea anemone, *Gyactis sesere*, revealed the presence of two antitumoral anthraquinones, Lupinacidin A and Galvaquinone B, which were ultimately found to be produced by an actinobacterial symbiont, *Verrucosispora* sp. SN26_14.1. Our finding showed that *Verrucosispora* was the most abundant actinobacterial species co-habiting with the sea anemone, among other actinobacterial species belonging to the genus *Streptomyces*, *Micromonospora*, *Arthrobacter*, *Dietzia*, *Rhodococcus* and *Cellulosimicrobium*. In addition, the sea anemone revealed a chloroform metabolic profile which was dominated by the *Verrucosispora* SN26_14.1 metabolites, in concordance with the microbiological data. This finding re-opens the debate about secondary metabolites in marine invertebrates and adds evidence that microbes are the real source of the chemicals. We predict that the coming years will deliver growing evidence that microbes are the ultimate chemical producer in most of the marine invertebrates.

3. Secondary metabolites comparison of two phylogenetically almost identical *Streptomyces griseus* strains originating from remote locations.

The comparison of two closely related *Streptomyces griseus* strains showed that the 16S rRNA gene is not a suitable marker to evaluate chemical diversity. Despite *Streptomyces griseus* strains keep a core secondary metabolites which is identical in the studied representatives, they also have an accessory and strain specific set of secondary metabolites, which is suitable for novel drug discovery. Morphological features also reassured our observations on the differences of the *S. griseus* strains. Therefore, *Streptomyces* strains with almost identical phylogenetic classification to already known strains still represent a diverse and novel source of secondary metabolites with potential for drug research.

4. A final remark

Finally, and after having explored microbiologically the unstudied Easter Island, its actinobacterial and chemical diversity, we hope that our studies may contribute to the scientific community, as well as to the general public to shape a better understanding of the microbial world, its role in the environment and our dependence in the microbial existence.

IX. Future directions

In this thesis three main topics were studied to contribute with the advancement of drug oriented microbiology and natural products research. Thus, this study dealt with actinobacterial diversity of the unexplored location, Easter Island, the potential of marine invertebrates as source of drug producing Actinobacteria and the secondary metabolites comparison of two closely related Actinobacteria. These studies were developed with culture based microbiology techniques, analytical chemistry, genome sequencing and bioinformatics. Further studies in actinobacterial systematics, natural products and genomics should be considered to amplify and refine the current knowledge that we have of remote location Actinobacteria.

The perspectives of my doctoral thesis are:

Characterization of new actinobacterial species and genus. Further studies need to be conducted in order to characterize the novel actinobacterial species obtained from Easter Island. For instance, multiples *Micromonospora* isolates presented a phylogenetic placement which is not close to known representatives in the genus, this strongly suggested that these isolates are new species that need to be investigated and classified. Additionally, isolate SN25_500 showed inconsistencies in classification in the genus level, adding evidence that it may represent a new actinobacterial genus. Therefore, further investigation should be done in order to characterize and compare the physiology and genomic traits of these actinobacterial representatives. The development of this data will allow reaffirming the potential of unexplored locations as a source of microbiological novelty.

The further chemical investigation of selected Easter Island actinobacterial isolates. Further work should be focused in the dereplication, isolation and structural elucidation of new secondary metabolites from Easter Island representatives. An interesting target can be found in the obtained *Streptomyces* isolates with low association to known species, as the case of SN28_94.1, SN20_12.1, SN25_508.1 and SN28_222.1. Other isolates, like *Salinispora*, *Micromonospora*, *Rhodococcus* and *Verrucosispora* showed diverse secondary metabolites profiles what suggested potential for further investigation. The work on this project should be undertaken primarily through ¹H NMR and HRLCMS to characterize and target the novel molecules in an early stage.

The genome sequencing of the Easter Island isolates for novel enzymatic abilities. The wide range of abilities of Actinobacteria should be scanned through genome sequencing and annotation, in order to find new enzymatic capabilities. Actinobacteria are known for their abilities to biotransform chemicals and to catabolize organic pollutants. The genome capabilities of the isolates should be closely associated to experimental evaluations for persistent organic molecules degradation, plastic consumption and heavy metal immobilization.

The further comparison between Easter Island representatives and geographical distant equivalents. Taking advantage of the genome sequencing of the Easter Island isolates, comparative genomics should be performed to rationalize the geographical differences of two closely related, but geographically separated actinobacterial representatives. This would help to understand the metabolic specialization of a particular environment, for instance Easter Island, an oceanic and isolated island in the South Pacific against an actinobacterial counterpart from an urban area with high anthropogenic influence.

X. References of introduction and discussion

- Abraham RT (1998) Mammalian target of rapamycin: immunosuppressive drugs uncover a novel pathway of cytokine receptor signaling. *Current opinion in immunology* 10:330-336.
- Alvarez, A., Saez, J.M., Davila Costa, J.S., Colin, V.L., Fuentes, M.S., Cuozzo, S.A., Benimeli, C.S., Polti, M.A., Amoroso, M.J (2017) Actinobacteria: current research and perspectives for bioremediation of pesticides and heavy metals. *Chemosphere* 166:41-62.
- Antony-Babu S, Stien D, Eparvier V, Parrot D, Tomasi S, Suzuki MT (2017) Multiple *Streptomyces* species with distinct secondary metabolomes have identical 16S rRNA gene sequences. *Scientific reports* 7:11089.
- Araujo, R., O. Kaewkla and C. M. M. Franco (2017) Endophytic Actinobacteria: Beneficial Partners for Sustainable Agriculture. Endophytes: Biology and Biotechnology: Volume 1. D. K. Maheshwari. Cham, Springer International Publishing: 171-191.
- Arnison, P.G., Bibb, M.J., Bierbaum, G., Bowers, A.A., Bugni, T.S., Bulaj, G., Camarero, J.A., Campopiano, D.J., Challis, G.L., Clardy, J. (2013) Ribosomally synthesized and post-translationally modified peptide natural products: overview and recommendations for a universal nomenclature. *Natural product reports* 30:108-160.
- Azizi, G., & Flenley, J. R. (2008) The last glacial maximum climatic conditions on Easter Island. *Quaternary International*, 184(1), 166-176.
- Bagley M.C., Dale J.W., Merritt E.A., Xiong X. (2005) Thiopeptide antibiotics. *Chemical reviews* 105:685-714.
- Bahrami Y., Franco C.M.M. (2016) Acetylated triterpene glycosides and their biological activity from holothuroidea reported in the past six decades. *Marine Drugs* 14:147.
- Barnes SS, Matisoo-Smith E, Hunt TL (2006) Ancient DNA of the Pacific rat (*Rattus exulans*) from Rapa Nui (Easter Island) *Journal of Archaeological Science* 33:1536-1540 doi.org/10.1016/j.jas.2006.02.006
- Barbe, V., M. Bouzon, S. Mangenot, B. Badet, J. Poulain, B. Segurens, D. Vallenet, P. Marlière and J. Weissenbach (2011) Complete Genome Sequence of *Streptomyces cattleya* NRRL 8057, a Producer of Antibiotics and Fluorometabolites. *Journal of Bacteriology* 193(18): 5055.
- Becking L.B. (1934) Geobiologie of inleiding tot de milieukunde. Vol. 18-19. W.P. Van Stockum & Zoon, The Hague, Netherlands.
- Blunt J.W., Copp B.R., Keyzers R.A., Munroa M., Prinsep M.R. (2016) Natural product reports. *Nat Prod Rep* 33:382-431.
- Braña, A. F., H.-P. Fiedler, H. Nava, V. González, A. Sarmiento-Vizcaíno, A. Molina, J. L. Acuña, L. A. García and G. Blanco (2015) Two *Streptomyces* species producing antibiotic, antitumor, and anti-inflammatory compounds are widespread among intertidal

macroalgae and deep-sea coral reef invertebrates from the central Cantabrian Sea. *Microbial ecology* 69:512-524.

- Buchanan BB, Gruissem W, Jones RL (2015) Biochemistry and molecular biology of plants. John Wiley & Sons, Chichester, UK.
- Bull, A. T., & Stach, J. E. (2007) Marine actinobacteria: new opportunities for natural product search and discovery. *Trends in microbiology*, 15(11), 491-499.
- Cachet N., Genta-Jouve G., Regalado E.L., Mokrini R., Amade P., Culioli G., Thomas O.P. (2009) Parazoanthines a–e, hydantoin alkaloids from the mediterranean sea anemone *Parazoanthus axinellae*. *Journal of natural products* 72:1612-1615.
- Caffrey P., Lynch S., Flood E., Finnan S., Oliynyk M. (2001) Amphotericin biosynthesis in *Streptomyces nodosus*: deductions from analysis of polyketide synthase and late genes *Chemistry & biology* 8:713-723.
- Casanova M., Salazar O., Seguel O., Luzio W. (2013) The soils of Chile. Springer Science & Business Media, Dordrecht, The Netherlands.
- Chaudhary P., Sharma R., Singh S.B., Nain L. (2011) Bioremediation of PAH by *Streptomyces sp.* *Bulletin of environmental contamination and toxicology* 86:268-271.
- Chisholm, R. H., Lorenzi, T., Lorz, A., Larsen, A. K., De Almeida, L. N., Escargueil, A., & Clairambault, J. (2015) Emergence of drug tolerance in cancer cell populations: an evolutionary outcome of selection, nongenetic instability, and stress-induced adaptation. *Cancer research*, 75(6), 930-939.
- Claesen J, Bibb MJ (2011) Biosynthesis and regulation of grisemycin, a new member of the linaridin family of ribosomally synthesized peptides produced by *Streptomyces griseus* IFO 13350. *Journal of bacteriology* 193:2510-2516.
- Cole, S. T., R. Brosch, J. Parkhill, T. Garnier, C. Churcher, D. Harris, S. V. Gordon, K. Eiglmeier, S. Gas, C. E. Barry, F. Tekaia, K. Badcock, D. Basham, D. Brown, T. Chillingworth, R. Connor, R. Davies, K. Devlin, T. Feltwell, S. Gentles, N. Hamlin, S. Holroyd, T. Hornsby, K. Jagels, A. Krogh, J. McLean, S. Moule, L. Murphy, K. Oliver, J. Osborne, M. A. Quail, M. A. Rajandream, J. Rogers, S. Rutter, K. Seeger, J. Skelton, R. Squares, S. Squares, J. E. Sulston, K. Taylor, S. Whitehead and B. G. Barrell (1998) Deciphering the biology of *Mycobacterium tuberculosis* from the complete genome sequence. *Nature* 393:537-544 doi:10.1038/31159.
- Cumsille A., Undabarrena A., González V., Claverías F., Rojas C., Cámara B. (2017) Biodiversity of Actinobacteria from the South Pacific and the assessment of *Streptomyces* chemical diversity with metabolic profiling. *Marine drugs* 15:286.
- Dhakal, D., Pokhrel, A. R., Shrestha, B., & Sohng, J. K. (2017) Marine rare actinobacteria: isolation, characterization, and strategies for harnessing bioactive compounds. *Frontiers in microbiology*, 8, 1106.
- Demain, A. L., & Sanchez, S. (2009) Microbial drug discovery: 80 years of progress. *The Journal of antibiotics*, 62(1), 5.

- DiSalvo L., Randall J., Cea A. (1988) Ecological reconnaissance of the Easter Island sublittoral marine-environment. *National Geographic Research* 4:451-473.
- Dong S.H., Kulikovskiy A., Zukher I., Estrada P., Dubiley S., Severinov K., Nair S.K. (2019) Biosynthesis of the RiPP trojan horse nucleotide antibiotic microcin C is directed by the N-formyl of the peptide precursor. *Chemical science* 10:2391-2395.
- Donia M.S., Ravel J., Schmidt E.W. (2008) A global assembly line for cyanobactins. *Nature chemical biology* 4:341.
- Du Z., Zhang W., Xia H., Lü G., Chen G. (2010) Isolation and diversity analysis of heterotrophic bacteria associated with sea anemones. *Acta Oceanologica Sinica* 29:62-69.
- Dubois A., Lenne P., Nahoe E., Rauch M., Meyer J. (2013) Plantas de rapa nui guía ilustrada de la flora de interés ecológico y patrimonial umanga mo te natura Santiago. CONAF, ONF International.
- Escalante P.D.I.R., Arancibia E.I. (2016) A checklist of marine crustaceans known from Easter Island. *Crustaceana* 89:63. doi.org/10.1163/15685403-00003507.
- Fenollar, F., X. Puéchal and D. Raoult (2007) Whipple's Disease. *New England Journal of Medicine* 356(1): 55-66.
- Fenical W., Jensen P.R., Palladino M.A., Lam K.S., Lloyd G.K., Potts B.C. (2009) Discovery and development of the anticancer agent salinosporamide A (NPI-0052). *Bioorganic & medicinal chemistry* 17:2175-2180.
- Fieseler, L., Horn, M., Wagner, M., & Hentschel, U. (2004) Discovery of the novel candidate phylum “Poribacteria” in marine sponges. *Appl. Environ. Microbiol.*, 70(6), 3724-3732.
- Finot, V. L., Marticorena, C., Marticorena, A., Rojas, G., & Barrera, J. A. (2015). Grasses (Poaceae) of Easter Island—native and introduced species diversity. In *Biodiversity in ecosystems-linking structure and function*. IntechOpen. DOI: 10.5772/59154.
- Fischer SR (2005) Island at the end of the world: the turbulent history of Easter Island. Reaktion, London, UK.
- Fitzpatrick SM, Callaghan R (2009) Examining dispersal mechanisms for the translocation of chicken (*Gallus gallus*) from Polynesia to South America, *Journal of Archaeological Science* 36:214-223 doi.org/10.1016/j.jas.2008.09.002.
- Grishko, V. V., Tarasova, E. V., & Ivshina, I. B. (2013) Biotransformation of betulin to betulone by growing and resting cells of the actinobacterium *Rhodococcus rhodochrous* IEGM 66. *Process Biochemistry*, 48(11), 1640-1644.
- Glynn P.W., Wellington G.M., Riegl B., Olson D.B., Borneman E., Wieters E.A. (2007) Diversity and biogeography of the scleractinian coral fauna of Easter Island (Rapa Nui). *Pac Sci* 61:67-90.
- Goodfellow, M., & Fiedler, H. P. (2010) A guide to successful bioprospecting: informed by actinobacterial systematics. *Antonie Van Leeuwenhoek*, 98(2), 119-142.

- Grau J. (1996) *Jubaea*, the palm of Chile and Easter Island? *Rapa Nui Journal* 10:37-40.
- Gray D., Gooday G., Prosser J.I. (1990) Apical hyphal extension in *Streptomyces coelicolor* A3 (2). *Microbiology* 136:1077-1084.
- Hamedi J., Poorinmohammad N., Wink J. (2017) The Role of Actinobacteria in Biotechnology. In: Wink J., Mohammadipanah F., Hamedi J (eds) *Biology and biotechnology of Actinobacteria*. Springer International Publishing, Cham, pp 269-328. doi:10.1007/978-3-319-60339-1_10.
- Hanshew A.S., McDonald B.R., Díaz C.D., Djiéto-Lordon C., Blatrix R., Currie C.R. (2015) Characterization of Actinobacteria associated with three ant-plant mutualisms. *Microbial ecology* 69:192-203.
- He, X., J. S. McLean, A. Edlund, S. Yooseph, A. P. Hall, S.-Y. Liu, P. C. Dorrestein, E. Esquenazi, R. C. Hunter, G. Cheng, K. E. Nelson, R. Lux and W. Shi (2015) Cultivation of a human-associated TM7 phylotype reveals a reduced genome and epibiotic parasitic lifestyle. *Proceedings of the National Academy of Sciences* 112(1): 244.
- Hentschel U., Fieseler L., Wehrl M., Gernert C., Steinert M., Hacker J., Horn M. (2003) Microbial diversity of marine sponges. In: *Sponges (Porifera)*. Springer, pp 59-88.
- Hohmann, C., K. Schneider, C. Bruntner, E. Irran, G. Nicholson, A. T. Bull, A. L. Jones, R. Brown, J. E. Stach and M. Goodfellow (2009) Caboxamycin, a new antibiotic of the benzoxazole family produced by the deep-sea strain *Streptomyces* sp. NTK 937. *The Journal of antibiotics* 62:99.
- Honma T., Shiomi K. (2006) Peptide toxins in sea anemones: structural and functional aspects. *Marine biotechnology* 8:1-10.
- Hopwood D.A. (2007) *Streptomyces* in nature and medicine : the antibiotic makers. Oxford University Press, Oxford ; New York.
- Hu Y., Martinez E.D., MacMillan J.B. (2012) Anthraquinones from a Marine-Derived *Streptomyces spinoverrucosus*. *Journal of Natural Products* 75:1759-1764 doi:10.1021/np3004326.
- Hunt TL, Lipo CP (2006) Late Colonization of Easter Island. *Science* 311:1603-1606 doi:10.1126/science.1121879
- Huttenhower, C., Gevers, D., Knight, R., Abubucker, S., Badger, J. H., Chinwalla, A. T., Creasy, H. H., Earl A. M., FitzGerald, M. G., Fulton, R. S. (2012) Structure, function and diversity of the healthy human microbiome. *Nature* 486(7402), 207.
- Igarashi, Y., M. E. Trujillo, E. Martínez-Molina, S. Yanase, S. Miyanaga, T. Obata, H. Sakurai, I. Saiki, T. Fujita and T. Furumai (2007) Antitumor anthraquinones from an endophytic actinomycete *Micromonospora lupini* sp. nov. *Bioorganic & Medicinal Chemistry Letters* 17:3702-3705 doi.org/10.1016/j.bmcl.2007.04.039.
- Imhoff J.F., Labes A., Wiese J. (2011) Bio-mining the microbial treasures of the ocean: new natural products. *Biotechnology advances* 29:468-482.

- Imhoff J.F., Stöhr R. (2003) Sponge-associated bacteria: general overview and special aspects of bacteria associated with *Halichondria panicea*. In: Müller Weg (ed) Sponges (Porifera). Springer Berlin Heidelberg, Berlin, Heidelberg, pp 35-57. doi:10.1007/978-3-642-55519-0_2.
- Jang K.H., Nam S.J., Locke J.B., Kauffman C.A., Beatty D.S., Paul L.A., Fenical W. (2013) Anthracimycin, a potent anthrax antibiotic from a marine-derived actinomycete. *Angewandte Chemie International Edition* 52:7822-7824.
- Jensen P.R., Gontang E., Mafnas C., Mincer T.J., Fenical W. (2005) Culturable marine actinomycete diversity from tropical Pacific Ocean sediments. *Environmental microbiology* 7:1039-1048.
- Jensen, P. R., Moore, B. S., & Fenical, W. (2015) The marine actinomycete genus *Salinispora*: a model organism for secondary metabolite discovery. *Natural product reports* 32(5), 738-751.
- Jiang, S., W. Sun, M. Chen, S. Dai, L. Zhang, Y. Liu, K. J. Lee and X. Li (2007) Diversity of culturable actinobacteria isolated from marine sponge *Haliclona sp.* *Antonie van Leeuwenhoek* 92:405-416 doi:10.1007/s10482-007-9169-z.
- Jiao J., Paterson J., Busche T., Rückert C., Kalinowski J., Harwani D., Gross H. (2018) Draft genome sequence of *Streptomyces sp.* strain DH-12, a soilborne isolate from the thar desert with broad-spectrum antibacterial activity. *Genome Announcements* 6:e00108-00118 doi:10.1128/genomeA.00108-18.
- Jones D., Keddie R.M. (2006) The genus *Arthrobacter*. *The Prokaryotes: Volume 3: Archaea Bacteria: Firmicutes, Actinomycetes*:945-960.
- Kapetanovic, I. M. (2008) Computer-aided drug discovery and development (CADD): in silico-chemico-biological approach. *Chemico-biological interactions*, 171(2), 165-176.
- Karimi E., Keller-Costa T., Slaby B.M., Cox C.J., da Rocha U.N., Hentschel U., Costa R. (2019) Genomic blueprints of sponge-prokaryote symbiosis are shared by low abundant and cultivatable Alphaproteobacteria. *Scientific Reports* 9:1999 doi:10.1038/s41598-019-38737-x.
- Kerr R.G., Chen Z. (1995) In vivo and in vitro biosynthesis of saponins in sea cucumbers. *Journal of natural products* 58:172-176.
- Kersten, R. D., Y.-L. Yang, Y. Xu, P. Cimermanic, S.-J. Nam, W. Fenical, M. A. Fischbach, B. S. Moore and P. C. Dorrestein (2011) A mass spectrometry-guided genome mining approach for natural product peptidogenomics. *Nature chemical biology* 7(11): 794.
- Knappe T.A., Linne U., Robbel L., Marahiel M.A. (2009) Insights into the biosynthesis and stability of the lasso peptide capistruin. *Chemistry & biology* 16:1290-1298.
- Knerr P.J., van der Donk W.A. (2012) Discovery, biosynthesis, and engineering of lantipeptides. *Annual review of biochemistry* 81:479-505.

- Koehn, F. E., & Carter, G. T. (2005) The evolving role of natural products in drug discovery. *Nature reviews Drug discovery*, 4(3), 206.
- Kohn A.J., Lloyd M.C. (1973) Marine polychaete annelids of Easter Island. *Int Rev Hydrobiol* 58:691-712.
- Krasil'nikov N. (1938) Ray fungi and related organisms—actinomycetales Moscow: Akademii Nauk SSSR (in Russian).
- Lee J.H., Kim Y.G., Yong Ryu S., Lee J. (2016) Calcium-chelating alizarin and other anthraquinones inhibit biofilm formation and the hemolytic activity of *Staphylococcus aureus*. *Scientific Reports* 6:19267 doi:10.1038/srep19267.
- Lewis A. L., G. E. Deitzler, M. J. Ruiz, C. Weimer, S. Park, L. S. Robinson, K. Hallsworth-Pepin, A. Wollam, M. Mitreva and W. G. Lewis (2016) Genome sequences of 11 human vaginal Actinobacteria strains. *Genome Announcement* 4:e00887-00816.
- Li H.R., Yu Y., Luo W., Zeng Y.X. (2010) *Marisediminicola antarctica* gen. nov., sp. nov., an actinobacterium isolated from the Antarctic. *International journal of systematic and evolutionary microbiology* 60:2535-2539.
- Lockhart S. R., K. A. Etienne, S. Vallabhaneni, J. Farooqi, A. Chowdhary, N. P. Govender, A. L. Colombo, B. Calvo, C. A. Cuomo, C. A. Desjardins, E. L. Berkow, M. Castanheira, R. E. Magobo, K. Jabeen, R. J. Asghar, J. F. Meis, B. Jackson, T. Chiller and A. P. Litvintseva (2016) Simultaneous emergence of multidrug-resistant *Candida auris* on 3 continents confirmed by whole-genome sequencing and epidemiological analyses. *Clinical Infectious Diseases* 64:134-140 doi:10.1093/cid/ciw691.
- Ludwig W., Euzéby J., Schumann P., Busse H.J., Trujillo M.E., Kämpfer P., Whitman W.B. (2012) Road map of the phylum Actinobacteria. In: *Bergey's manual® of systematic bacteriology*. Springer, pp 1-28.
- Mann, D., Edwards, J., Chase, J., Beck, W., Reanier, R., Mass, M., Bruce, F., Loret, J. (2008) Drought, vegetation change, and human history on Rapa Nui (Isla de Pascua, Easter Island). *Quaternary Research*, 69(1), 16-28.
- Maldonado L. A., W. Fenical, P. R. Jensen, C. A. Kauffman, T. J. Mincer, A. C. Ward, A. T. Bull and M. Goodfellow (2005) *Salinispora arenicola* gen. nov., sp. nov. and *Salinispora tropica* sp. nov., obligate marine actinomycetes belonging to the family Micromonosporaceae. *International Journal of Systematic and Evolutionary Microbiology* 55:1759-1766.
- Maldonado L.A., Frago-Yáñez D., Pérez-García A., Rosellón-Druker J., Quintana E.T. (2009) Actinobacterial diversity from marine sediments collected in Mexico. *Antonie van Leeuwenhoek* 95:111-120 doi:10.1007/s10482-008-9294-3.
- Manuelli M., L. De Luca, G. Iaria, P. Tatangelo, D. Sforza, L. Perrone, M. Bellini, R. Angelico, A. Anselmo and G. Tisone (2010) Conversion to rapamycin immunosuppression for malignancy after kidney transplantation. In: *Transplantation proceedings*, 2010. vol 4. Elsevier, pp 1314-1316.

- Marahiel M.A., Essen L.O. (2009) Nonribosomal Peptide Synthetases: Mechanistic and Structural Aspects of Essential Domains. In: *Methods in Enzymology*, vol 458. Academic Press, pp 337-351. doi.org/10.1016/S0076-6879(09)04813-7.
- Martínez-Hidalgo P., Galindo-Villardón P., Trujillo M.E., Igual J.M., Martínez-Molina E. (2014) *Micromonospora* from nitrogen fixing nodules of alfalfa (*Medicago sativa* L.). A new promising plant probiotic bacteria. *Scientific reports* 4:6389.
- Massin C. (1996) The holothurians of Easter Island Bulletin de l'Institut royal des Sciences naturelles de Belgique. *Biologie* 66:151-178.
- Merrifield, D. L., & Carnevali, O. (2014) Probiotic modulation of the gut microbiota of fish. *Aquaculture Nutrition: Gut Health, Probiotics and Prebiotics* 185-222.
- McKillop C., Elvin P., Kenten J. (1986) Cloning and expression of an extracellular α -amylase gene from *Streptomyces hygroscopicus* in *Streptomyces lividans* 66. *FEMS Microbiology Letters* 36:3-7 doi:10.1111/j.1574-6968.1986.tb01656.x.
- Miao V., Davies J. (2010) Actinobacteria: the good, the bad, and the ugly. *Antonie Van Leeuwenhoek* 98:143-150.
- Millán-Aguñaga N., Chavarria K.L., Ugalde J.A., Letzel A.C., Rouse G.W., Jensen P.R. (2017) Phylogenomic Insight into *Salinispora* (Bacteria, Actinobacteria) Species Designations. *Scientific Reports* 7:3564 doi:10.1038/s41598-017-02845-3.
- Miller A.Z., Pereira M.F.C., Calaforra J.M., Forti P., Dionísio A., Saiz-Jimenez C. (2014) Siliceous speleothems and associated microbe-mineral interactions from ana heva lava tube in Easter Island (Chile) *Geomicrobiology Journal* 31:236-245 doi:10.1080/01490451.2013.827762.
- Montenegro A, Avis C, Weaver A (2008) Modeling the prehistoric arrival of the sweet potato in Polynesia. *Journal of Archaeological Science* 35:355-367 doi.org/10.1016/j.jas.2007.04.004.
- Moyano H. (2001) Bryozoa from oceanic south eastern Pacific islands: diversity and zoogeography. *Bryozoa studies*:229-238.
- Mus, F., Crook, M.B., Garcia, K., Costas, A.G., Geddes, B.A., Kouri, E.D., Paramasivan, P., Ryu, M.H., Oldroyd, G.E., Poole, P.S. and Udvardi, M.K., (2016) Symbiotic nitrogen fixation and the challenges to its extension to nonlegumes. *Appl. Environ. Microbiol* 82(13), pp.3698-3710.
- Nair, M. G., Mishra, S. K., Putnam, A. R., & Pahdey, R. C. (1992) Antifungal anthracycline antibiotics, spartanamicins A and B from *Micromonospora* spp. *The Journal of antibiotics* 45(11), 1738-1745.
- Neilson J. W., J. Quade, M. Ortiz, W. M. Nelson, A. Legatzki, F. Tian, M. LaComb, J. L. Betancourt, R. A. Wing and C. A. Soderlund (2012) Life at the hyperarid margin: novel bacterial diversity in arid soils of the Atacama Desert, Chile. *Extremophiles* 16:553-566.
- Ng P.K.L., Boyko C.B. (2016) A new species of *Achaeus* Leach, 1817 (Decapoda: Brachyura: Majoidea: Inachidae) from Easter Island. *Nauplius* 24.

- Nimaichand S., Devi A.M., Tamreihao K., Ningthoujam D.S., Li W.J. (2015) Actinobacterial diversity in limestone deposit sites in Hundung, Manipur (India) and their antimicrobial activities. *Frontiers in Microbiology* 6. doi:10.3389/fmicb.2015.00413.
- O'Malley M.A. (2008) 'Everything is everywhere: but the environment selects': ubiquitous distribution and ecological determinism in microbial biogeography. *Studies in History and Philosophy of Science, Part C: Studies in History and Philosophy of Biological and Biomedical Sciences* 39:314-325 . doi.org/10.1016/j.shpsc.2008.06.005.
- Olano C., Méndez C., Salas J.A. (2010) Post-PKS tailoring steps in natural product-producing actinomycetes from the perspective of combinatorial biosynthesis. *Natural Product Reports* 27:571-616 doi:10.1039/B911956F.
- Ortega Manuel A., van der Donk Wilfred A. (2016) New Insights into the Biosynthetic Logic of ribosomally synthesized and post-translationally modified peptide natural products. *Cell Chemical Biology* 23:31-44. doi:10.1016/j.chembiol.2015.11.012.
- Osorio C., Cantuarias V. (1989) Vertical distribution of mollusks on the rocky intertidal of Easter Island. *Pacific Science* 43:302-315.
- Pamboukian C.R.D., Facciotti M.C.R. (2004) Production of the antitumoral retamycin during continuous fermentations of *Streptomyces olindensis*. *Process Biochemistry* 39:2249-2255.
- Paul V.J., Freeman C.J., Agarwal V. (2019) Chemical ecology of marine sponges: new opportunities through “-omics”. *Integrative and comparative biology*. doi:10.1093/icb/icz014
- Pervaiz I., Ahmad S., Madni M., Ahmad H., Khaliq F. (2013) Microbial biotransformation: a tool for drug designing. *Applied biochemistry and microbiology* 49:437-450.
- Polet C, Bocherens H (2016) New insights into the marine contribution to ancient Easter Islanders' diet. *Journal of Archaeological Science* 6:709-719 doi.org/10.1016/j.jasrep.2015.09.013.
- Polti, M. A., Aparicio, J. D., Benimeli, C. S., & Amoroso, M. J. (2014) Simultaneous bioremediation of Cr (VI) and lindane in soil by Actinobacteria. *International Biodeterioration & Biodegradation*, 88, 48-55.
- Randall J.E., Cea A. (2011) Shore fishes of Easter Island. Project MUSE. University of Hawai'i Press, Hawai'i, USA.
- Raoult D., Ogata H., Audic S., Robert C., Suhre K., Drancourt M., Claverie J.M. (2003) *Tropheryma whipplei* Twist: a human pathogenic actinobacteria with a reduced genome. *Genome Research* 13:1800-1809. doi:10.1101/gr.1474603.
- Rehder H.A. (1980) The marine mollusks of Easter Island (Isla de Pascua) and Sala y Gómez. Rehder, Harald A. Smithsonian Contributions to Zoology 289, Washington, USA.
- Retamal M. (2004) Decapods of the Chilean oceanic islands: Easter and Salas y Gómez. *Ciencia y Tecnología del Mar* 27:55-68.

- Rippon J.W. (1982) Medical mycology; the pathogenic fungi and the pathogenic actinomycetes. 2nd edition. W.B. Saunders Company, Eastbourne, UK.
- Riquelme, C., J. J. Marshall Hathaway, M. d. L. Enes Dapkevicius, A. Z. Miller, A. Kooser, D. E. Northup, V. Jurado, O. Fernandez, C. Saiz-Jimenez and N. Cheeptham (2015) Actinobacterial diversity in volcanic caves and associated geomicrobiological interactions. *Frontiers in microbiology* 6:1342.
- Rittner A., Grininger M. (2014) Modular polyketide synthases (PKSs): a new model fits all. *ChemBioChem* 15:2489-2493.
- Romano, S., Jackson, S., Patry, S., & Dobson, A. (2018) Extending the “one strain many compounds”(OSMAC) principle to marine microorganisms. *Marine drugs*, 16(7), 244.
- Routledge, S. (1917) Easter Island. *The Geographical Journal*, 49(5), 321-340.
- Sehgal, S. N. (1998) Rapamune® (RAPA, rapamycin, sirolimus): mechanism of action immunosuppressive effect results from blockade of signal transduction and inhibition of cell cycle progression. *Clinical Biochemistry* 31(5): 335-340.
- Schneemann, I., I. Kajahn, B. Ohlendorf, H. Zinecker, A. Erhard, K. Nagel, J. Wiese and J. F. Imhoff (2010) Mayamycin, a cytotoxic polyketide from a *Streptomyces* strain isolated from the marine sponge *Halichondria panicea*. *Journal of natural products* 73:1309-1312.
- Schneemann I., Nagel K., Kajahn I., Labes A., Wiese J., Imhoff J.F. (2010) Comprehensive investigation of marine Actinobacteria associated with the sponge *Halichondria panicea*. *Appl Environ Microbiol* 76:3702-3714.
- Schofield M.M., Jain S., Porat D., Dick G.J., Sherman D.H. (2015) Identification and analysis of the bacterial endosymbiont specialized for production of the chemotherapeutic natural product ET-743. *Environmental Microbiology* 17:3964-3975 doi:10.1111/1462-2920.12908.
- Schuett C., Doepke H., Grathoff A., Gedde M. (2007) Bacterial aggregates in the tentacles of the sea anemone *Metridium senile*. *Helgoland Marine Research* 61:211-216. doi:10.1007/s10152-007-0069-4.
- Schweitz H., Vincent J.P., Barhanin J., Frelin C., Linden G., Hugues M., Lazdunski M. (1981) Purification and pharmacological properties of eight sea anemone toxins from *Anemonia sulcata*, *Anthopleura xanthogrammica*, *Stoichactis giganteus* and *Actinodendron plumosum*. *Biochemistry* 20:5245-5252.
- Sosio, M., Stinchi, S., Beltrametti, F., Lazzarini, A., & Donadio, S. (2003) The gene cluster for the biosynthesis of the glycopeptide antibiotic A40926 by *Nonomuraea* species. *Chemistry & biology*, 10(6), 541-549.
- Stackebrandt E., Schumann P. (2006) Introduction to the taxonomy of Actinobacteria. In: Dworkin M., Falkow S., Rosenberg E., Schleifer K.H., Stackebrandt E. (eds) *The Prokaryotes: Volume 3: Archaea. Bacteria: Firmicutes, Actinomycetes*. Springer New York, New York, NY, pp 297-321. doi:10.1007/0-387-30743-5_16.

- Stewart, R.D., Auffret, M.D., Warr, A., Wiser, A.H., Press, M.O., Langford, K.W., Liachko, I., Snelling, T.J., Dewhurst, R.J., Walker, A.W. and Roehe, R., (2018) Assembly of 913 microbial genomes from metagenomic sequencing of the cow rumen. *Nature communications* 9(1), p.870.
- Suemitsu R. (1963) Studies on metal chelate compounds of anthraquinone derivatives. *Agricultural and Biological Chemistry* 27:1-7. doi:10.1080/00021369.1963.10858056.
- Sun Y., Shi Y.L., Wang H., Zhang T., Yu L.Y., Sun H., Zhang Y.Q. (2018) Diversity of bacteria and the characteristics of actinobacteria community structure in Badain Jaran Desert and Tengger Desert of China. *Frontiers in Microbiology* 9. doi:10.3389/fmicb.2018.01068.
- Tianero M.D., Balaich J.N., Donia M.S. (2019) Localized production of defence chemicals by intracellular symbionts of *Haliclona* sponges. *Nature Microbiology* doi:10.1038/s41564-019-0415-8.
- Trischman J. A., D. M. Tapiolas, P. R. Jensen, R. Dwight, W. Fenical, T. C. McKee, C. M. Ireland, T. J. Stout and J. Clardy (1994) Salinamides A and B: anti-inflammatory depsipeptides from a marine *streptomycete*. *Journal of the American Chemical Society* 116:757-758 doi:10.1021/ja00081a042.
- Trujillo M.E. (2016) Actinobacteria. In: eLS (ed). John Wiley & Sons, Ltd, Chichester, UK. doi:10.1002/9780470015902.a0020366.pub2.
- University of Hawaii, M. (2019). Rapanui: The Edmunds and Bryan Photographs. [online] Digicoll.manoa.hawaii.edu. Available at: <https://digicoll.manoa.hawaii.edu/rapanui/Pages/about.php?s=about> [Accessed 19 May 2019].
- Ventura M., Canchaya C., Tauch A., Chandra G., Fitzgerald G.F., Chater K.F., van Sinderen D. (2007) Genomics of Actinobacteria: tracing the evolutionary history of an ancient phylum. *Microbiology and Molecular Biology Reviews* 71:495 doi:10.1128/MMBR.00005-07.
- Vezina C., Kudelski A., Sehgal S. (1975) Rapamycin (AY-22, 989), a new antifungal antibiotic. *The Journal of antibiotics* 28:721-726.
- Vezzoli L., Acocella V. (2009) Easter Island, SE Pacific: An end-member type of hotspot volcanism. *Geol Soc Am Bull* 121:869-886. doi:10.1130/b26470.1.
- Vicente, C.M.; Thibessard, A.; Lorenzi, J.-N.; Benhadj, M.; Hôtel, L.; Gacemi-Kirane, D.; Lespinet, O.; Leblond, P.; Aigle, B. (2018) Comparative genomics among closely related *Streptomyces* strains revealed specialized metabolite biosynthetic gene cluster diversity. *Antibiotics* 7, 86.
- Villalobos A.S., Wiese J., Aguilar P., Dorador C., Imhoff J.F. (2018) *Subtercola vilae* sp. nov., a novel actinobacterium from an extremely high-altitude cold volcano lake in Chile. *Antonie van Leeuwenhoek* 111:955-963. doi:10.1007/s10482-017-0994-4.
- Viver T., Cifuentes A., Díaz S., Rodríguez-Valdecantos G., González B., Antón J., Rosselló-Móra R. (2015) Diversity of extremely halophilic cultivable prokaryotes in

Mediterranean, Atlantic and Pacific solar salterns: Evidence that unexplored sites constitute sources of cultivable novelty. *Systematic and Applied Microbiology* 38:266-275. doi.org/10.1016/j.syapm.2015.02.002.

- Waksman S.A. (1940) The microbiology of cellulose decomposition and some economic problems involved. *The Botanical Review* 6:637-665. doi:10.1007/bf02879311.
- Waksman S.A. (1967) The Actinomycetes. A summary of current knowledge. New York, The Ronald Press Co., USA.
- Wang C., X. X. Xu, Z. Qu, H. L. Wang, H. P. Lin, Q. Y. Xie, J. S. Ruan and K. Hong (2011) *Micromonospora rhizosphaerae* sp. nov., isolated from mangrove rhizosphere soil. *International journal of systematic and evolutionary microbiology* 61:320-324.
- Wang W., Qiu Z., Tan H., Cao L. (2014) Siderophore production by actinobacteria. *Biometals* 27:623-631.
- Watanabe K., Praseuth A.P., Praseuth M.B., Hotta K. (2009) Plasmid-borne gene cluster assemblage and heterologous biosynthesis of nonribosomal peptides in *Escherichia coli*. In: *Methods in Enzymology*, vol 458. Academic Press, pp 379-399. doi.org/10.1016/S0076-6879(09)04815-0.
- Weber, T., K. Blin, S. Duddela, D. Krug, H. U. Kim, R. Brucoleri, S. Y. Lee, M. A. Fischbach, R. Müller, W. Wohlleben, R. Breitling, E. Takano and M. H. Medema (2015) AntiSMASH 3.0 a comprehensive resource for the genome mining of biosynthetic gene clusters. *Nucleic Acids Research* 43(W1): W237-W243.
- Weissman K.J. (2009) Introduction to polyketide biosynthesis. In: *Methods in Enzymology*, vol 459. Academic Press, pp 3-16. doi.org/10.1016/S0076-6879(09)04601-1.
- Wilmshurst J.M., Hunt T.L., Lipo C.P., Anderson A.J. (2011) High-precision radiocarbon dating shows recent and rapid initial human colonization of East Polynesia. *Proceedings of the National Academy of Sciences* 108:1815-1820 doi:10.1073/pnas.1015876108.
- Wu, C., Zacchetti, B., Ram, A. F., Van Wezel, G. P., Claessen, D., & Choi, Y. H. (2015) Expanding the chemical space for natural products by *Aspergillus-Streptomyces* co-cultivation and biotransformation. *Scientific reports* 5, 10868.
- Yang K.L., M.Y. Wei, C.L. Shao, X.M. Fu, Z.Y. Guo, R.F. Xu, C.J. Zheng, Z.G. She, Y.C. Lin and C.Y. Wang (2012) Antibacterial anthraquinone derivatives from a sea anemone-derived fungus *Nigrospora* sp. *Journal of Natural Products* 75:935-941. doi:10.1021/np300103w.
- Yeap S., M. N. Akhtar, K. L. Lim, N. Abu, W. Y. Ho, S. Zareen, K. Roohani, H. Ky, S. W. Tan and N. Lajis (2015) Synthesis of an anthraquinone derivative (DHAQC) and its effect on induction of G2/M arrest and apoptosis in breast cancer MCF-7 cell line. *Drug design, development and therapy* 9:983.
- Yu S., Ye X., Chen L., Lian X.Y., Zhang Z. (2014) Polyoxygenated 24, 28-epoxyergosterols inhibiting the proliferation of glioma cells from sea anemone *Anthopleura midori*. *Steroids* 88:19-25.

- Zhang H., Lee Y.K., Zhang W., Lee H.K. (2006) Culturable Actinobacteria from the marine sponge *Hymeniacidon perleve*: isolation and phylogenetic diversity by 16S rRNA gene-RFLP analysis. *Antonie van Leeuwenhoek* 90:159-169. doi:10.1007/s10482-006-9070-1.
- Ziemert N., Lechner A., Wietz M., Millán-Aguiñaga N., Chavarria K.L., Jensen P.R. (2014) Diversity and evolution of secondary metabolism in the marine actinomycete genus *Salinispora*. *Proceedings of the National Academy of Sciences* 111:E1130. doi:10.1073/pnas.1324161111.

XI. Acknowledgments

I would like to thank enormously Prof. Dr. Johannes F. Imhoff for giving me the opportunity to undertake a PhD project with his supervision. Also, I would like to show my gratitude towards him for allowing me to submerge in the microbiological world, which without doubt will be an important part of my scientific life.

I would also like to thank Prof. Dr. Ute Hentschel-Humeida for her support during the research, as well as for allowing me to continue my research project in her laboratory. I also thank her critical and important feedback throughout all my stay.

I am grateful with Prof. Dr. Frank Sönnichsen, for his support and feedback during these years. I also thank very much his goodwill by giving me the opportunity to access the analytical instruments. I also thank his feedback and time to discuss data and improve manuscripts.

I thank the Deutscher Akademischer Austauschdienst (DAAD) for the financial support under the stipend # PKZ91564794.

I thank all the Marine Microbiology/Microbial Symbionts lab members for their feedback and help during this PhD period. In special, I thank Dr. Jutta Wiese for the feedback during the scientific discussions and experiments. I also thank Tanja Rahn for providing help, coordination and goodwill during all these years working together. I would like also to show my gratitude to Dr. Kristina Bayer and Bettina Reuter, for helping me each time that I required assistance.

I thank very much Marion Höftmann and Gitta Kohlmeyer-Yilmaz for their valuable help with the NMR, as well as Nils Preußke and Matthias Lipfert with their help in the mass spec data acquisition.

I state my acknowledgment and appreciation to Dr. Alvaro Villalobos who helped me during my introduction in the microbial world and cultivation techniques.

I also thank my family for their understanding and support during my stay abroad.

Finally, I would like to thank Millaray Sierra for her unconditional support and love during these years of hard work.

XII. Erklärung

Hiermit erkläre ich, dass ich die von mir vorgelegte Dissertation, bis auf die Beratung durch meine Betreuer, selbstständig und ohne Zuhilfenahme unerlaubter Hilfsmittel angefertigt habe. Alle benutzten Quellen und Hilfsmittel habe ich vollständig angegeben und die Zusammenarbeit mit anderen Wissenschaftlern habe ich kenntlich gemacht. Zudem versichere ich, dass diese Arbeit unter Einhaltung der Regeln guter wissenschaftlicher Praxis der Deutschen Forschungsgesellschaft verfasst wurde, und dass sie nach Form und Inhalt meine eigene Arbeit ist. Weder diese noch eine ähnliche Arbeit wurden an einer anderen Abteilung oder Hochschule im Rahmen eines Prüfungsverfahrens vorgelegt, veröffentlicht oder zur Veröffentlichung vorgelegt. Dies ist mein erstes und einziges Promotionsverfahren. Mir wurde kein akademischer Grad entzogen.

Ignacio Fernando Sottorff Neculhueque

Kiel, den 12.06.2019

XIII. Individual scientific contributions for multiple-author work

High diversity and novelty of Actinobacteria isolated from the coastal zone of the geographical remote young volcanic Easter Island, Chile.

Ignacio Sottorff, Jutta Wiese, and Johannes F. Imhoff:

International Microbiology, 2019

<https://doi.org/10.1007/s10123-019-00061-9>

Ignacio Sottorff developed the experimental design, took the samples, cultured the Actinobacteria, extracted DNA from the actinobacterial isolates, performed the amplification of the 16S rRNA gene, assembled the 16S rRNA sequences, evaluated the phylogenetic relatedness of the isolates, constructed phylogenetic trees and wrote the manuscript. Dr. Jutta Wiese and Prof. Dr. Johannes F. Imhoff supervised the design and performance of the investigation and revised the manuscript.

Antitumor anthraquinones from an Easter Island sea anemone: animal or bacterial origin?

Ignacio Sottorff, Sven Künzel, Jutta Wiese, Matthias Lipfert, Nils Preußke, Frank Sönnichsen, and Johannes F. Imhoff:

Marine Drugs, 2019

<https://doi.org/10.3390/md17030154>

Ignacio Sottorff developed the experimental design, took the sea anemone samples, performed the chemical extractions of the sea anemone and analyzed HRLCMS and NMR data. He isolated the Actinobacteria, extracted DNA from the actinobacterial isolates, performed the amplification of the 16S rRNA gene, assembled the 16S rRNA sequences, evaluated the phylogenetic relatedness of the Actinobacteria, constructed phylogenetic trees, performed the HPLC profiles of sea anemone and Actinobacteria, purified the anthraquinones, elucidated the chemical structures, assembled the genome, analyzed the anthraquinones biosynthetic gene clusters and wrote the manuscript. Matthias Lipfert performed NMR and HRLCMS experiments. Nils Preußke performed NMR and HRLCMS experiments. Sven Künzel sequenced the genome of the *Verrucosispora* strain. Prof. Dr. Frank Sönnichsen supervised NMR experiments, analyzed NMR data, discussed structural elucidation of the anthraquinones and revised the manuscript. Dr. Jutta Wiese and Prof. Dr. Johannes F. Imhoff supervised the design and performance of the investigation and revised the manuscript.

Different secondary metabolite profiles of phylogenetically almost identical *Streptomyces griseus* strains originating from geographically remote locations.

Ignacio Sottorff, Jutta Wiese, Matthias Lipfert, Nils Preußke, Frank Sönnichsen, and Johannes F. Imhoff:

Microorganisms, 2019

<https://doi.org/10.3390/microorganisms7060166>

Ignacio Sottorff developed the experimental design, cultured and isolated the *Streptomyces* strains, extracted DNA from the *Streptomyces* strains, performed the amplification of the 16S rRNA gene, assembled the 16S rRNA sequences, evaluated the phylogenetic relatedness of the *Streptomyces* isolates, constructed the phylogenetic tree, performed the HPLC profile of the *Streptomyces*, developed the morphological characterization of the *Streptomyces* strains, performed the chemical extractions, analyzed HRLCMS and NMR data, dereplicated the chemicals and wrote the manuscript. Matthias Lipfert performed NMR and HRLCMS experiments. Nils Preußke performed NMR and HRLCMS experiments. Prof. Dr. Frank Sönnichsen supervised and analyzed NMR experiments and revised the manuscript. Dr. Jutta Wiese and Prof. Dr. Johannes F. Imhoff supervised the design and performance of the investigation and revised the manuscript.

XIV. Curriculum Vitae

PERSONAL INFORMATION

Name : Ignacio Fernando Sottorff Neculhueque
Birthdate : 07.11.1985
Nationality : Chilean

EDUCATION

GEOMAR–Helmholtz Centre for Ocean Research and Kiel University, Kiel, Germany.
PhD in Microbiology and Natural products chemistry. October 2015 – Present.
Supervisor: Prof. Dr. Johannes F. Imhoff

Scripps Institution of Oceanography (SIO), UCSD, La Jolla, CA, USA.
M.Sc. in Marine-Chemical Biology. September 2012 – July 2014.
Supervisor: Prof. Dr. William Fenical

Universidad de Concepción (UDEC), Concepción, Chile.
Bachelor of Marine Biotechnology. March 2005 - December 2009.
Supervisor: Prof. Dr. Mario Silva-Osorio

RESEARCH EXPERIENCE

Doctoral Researcher, Geomar-Helmholtz Centre for Ocean Research. October 2015 – Present.

- Isolation and phylogenetic characterization marine-derived Actinobacteria for the production of secondary metabolites with pharmacological interest.
- Isolation and structure elucidation of secondary metabolites from marine-derived Actinobacteria.
- Actinobacterial genome sequencing, assembly, mining and annotation.

Technical Assistant, Universidad de Concepción. October 2014 – March 2015.

- Project Fondecyt: Deep sea fungi as a source of bioactive metabolites (1120924).

Master Student Researcher, Scripps Institution of Oceanography, CMBB. September 2012- July 2014.

- Chemical dereplication and characterization of a *Streptomyces* strain (CNT-373), using column chromatography, high pressure liquid chromatography (HPLC), mass spectroscopy (LC/MS-qTOF), NMR (1 and 2D), and chemical libraries.
- Isolation, purification and structure elucidation of a new epoxy steroid (unpublished).

Research Assistant, Universidad de Concepción. January 2011- May 2012.

- Somatic embryogenesis of *Aristotelia chilensis* to evaluate the production *in vitro* of indole alkaloids (aristoteline) through vegetal cell culture.

Summer Research Intern, Public Health Institute, Chile. December 2008- March 2009.

- Detection and quantification of residues of veterinary drugs on an animal matrix through Solid Phase Extraction (SPE) and HPLC-MS MS.

PUBLICATIONS

Sottorff, I., Wiese, J., Lipfert, M., Preußke, N., Sönnichsen, F. D., & Imhoff, J. F. (2019). Different Secondary Metabolite Profiles of Phylogenetically almost Identical *Streptomyces griseus* Strains Originating from Geographically Remote Locations. **Microorganisms**, 7, 166.

Sottorff, I., Künzel, S., Wiese, J., Lipfert, M., Preußke, N., Sönnichsen, F. D., & Imhoff, J. F. (2019). Antitumor Anthraquinones from an Easter Island Sea Anemone: Animal or Bacterial Origin? **Marine Drugs**, 17(3), 154.

Sottorff, I., Wiese, J., & Imhoff, J. F. (2019). High diversity and novelty of Actinobacteria isolated from the coastal zone of the geographically remote young volcanic Easter Island, Chile. **International Microbiology**, 1-14.

Sottorff, I., Aballay, A., Hernández, V., Roa, L., Muñoz, L. X., Silva, M., & Astuya, A. (2013). Characterization of bioactive molecules isolated from sea cucumber *Athyonidium chilensis*. **Revista de Biología Marina y Oceanografía**, 48(1), 23-35.

Sottorff, I., Díaz, A., Rozas, Z., Hernández, V., Becerra, J., Silva, M., Astuya, A. (2008). Compuestos bioactivos (saponinas) desde *Athyonidium chilensis*. ¿Fuente potencial de fármacos para la industria acuícola? **Biological Research**. R-107. Volume 41 (supplement A).

XV. Appendix

Supplementary information of publication 1

High diversity and novelty of *Actinobacteria* isolated from the coastal zone of the geographical remote young volcanic Easter Island, Chile

Supplementary Table 1 Isolation medium for each phylotype obtained from the coastal zone of Easter Island, Chile

Isolation medium	Phylotype	16S rRNA gene sequence length (nt)	Genbank acc. #	Next related type strain	Similarity %
BCM	SN26_23.1	1338	MH299428	<i>Arthroacter koreensis</i> JCM 12361 ^T	99
BCM	SN10_77.1	1334	MH299452	<i>Micromonospora auratinigra</i> DSM 44815 ^T	99
BCM	SN20_17.1	1330	MH299454	<i>Micromonospora aurantiaca</i> DSM 43813 ^T	99
BCM	SN20_19.1	1325	MH299455	<i>Micromonospora auratinigra</i> DSM 44815 ^T	99
BCM	SN22_1.1	1322	MH299456	<i>Micromonospora schwarzwaldensis</i> DSM 45708 ^T	99
BCM	SN25_52.1	1470	MH299463	<i>Micromonospora tulbaghia</i> DSM 45142 ^T	99
BCM	SN28_51.1	1336	MH299473	<i>Micromonospora chokoriensis</i> JCM 13247 ^T	99
BCM	SN6_25.1	1468	MH299476	<i>Micromonospora echinospora</i> DSM 43816 ^T	99
BCM	SN25_55.1	1341	MH299483	<i>Streptomyces nanshensis</i> SCSIO 01066 ^T	99
BCM	SN26_22.1	1335	MH299485	<i>Streptomyces drozdowiczii</i> JCM 13580 ^T	99
BCM	SN27_300.1	1340	MH299486	<i>Streptomyces rimosus</i> DSM 40260 ^T	99
BCM	SN28_50.1	1346	MH299493	<i>Streptomyces chilikensis</i> DSM 42072 ^T	99
BCM	SN27_51.1	1330	MH299432	<i>Blastococcus saxosidens</i> DSM 44509 ^T	98
BCM	SN26_6.1	1481	MH299429	<i>Arthroacter arilaitensis</i> DSM 16368 ^T	98
BCM	SN25_54.1	1339	MH299444	<i>Rhodococcus phenolicus</i> DSM 44812 ^T	98
BCM	SN25_53.1	1340	MH299450	<i>Yimella lutea</i> YIM 45900 ^T	98
BCM	SN27_5.1	1339	MH299488	<i>Streptomyces albus</i> subsp. <i>albus</i> DSM 40313 ^T	98
BCM	SN28_52.1	1351	MH299494	<i>Streptomyces macrosporus</i> NBRC 14748 ^T	97
BCM	SN6_7.1	1437	MH299439	<i>Nocardiolides exalbidus</i> JCM 23199 ^T	94
BSEM	SN27_135A.1	1473	MH299426	<i>Aeromicrobium choanae</i> CCM 8650 ^T	99
BSEM	SN26_101.1	1476	MH299430	<i>Cellulosimicrobium funkei</i> DSM 16025 ^T	99
BTM	SN27_9.1	1474	MH299440	<i>Salinispora arenicola</i> DSM 44819 ^T	100
BTM	SN26_13.1A	1471	MH299435	<i>Dietzia cinnamea</i> DSM 44904 ^T	99
BTM	SN27_100.1	1475	MH299436	<i>Dietzia schimae</i> DSM 45139 ^T	99
BTM	SN26_12.1	1475	MH299445	<i>Rhodococcus soli</i> DSM 46662 ^T	99
BTM	SN26_15.1	1477	MH299449	<i>Verrucosipora maris</i> DSM 45365 ^T	99
BTM	SN22_5.1	1307	MH299457	<i>Micromonospora krabiensis</i> DSM 45344 ^T	99

BTM	SN23_2.1	1330	MH299458	<i>Micromonospora auratinigra</i> DSM 44815 ^T	99
BTM	SN25_3.1	1330	MH299460	<i>Micromonospora coxensis</i> JCM 13248 ^T	99
BTM	SN25_4.1	1209	MH299461	<i>Micromonospora chokoriensis</i> JCM 13247 ^T	99
BTM	SN25_5.1	1330	MH299462	<i>Micromonospora chokoriensis</i> JCM 13247 ^T	99
BTM	SN25_6.1	1330	MH299464	<i>Micromonospora peucetia</i> DSM 43363 ^T	99
BTM	SN25_800.1	1466	MH299465	<i>Micromonospora auratinigra</i> DSM 44815 ^T	99
BTM	SN26_110.1	1330	MH299467	<i>Micromonospora echinospira</i> DSM 43816 ^T	99
BTM	SN26_25.1	1417	MH299468	<i>Micromonospora rifamycinica</i> DSM 44983 ^T	99
BTM	SN27_669.1	1330	MH299471	<i>Micromonospora aurantiaca</i> DSM 43813 ^T	99
BTM	SN27_670.1	1469	MH299472	<i>Micromonospora chokoriensis</i> JCM 13247 ^T	99
BTM	SN6_55.1	1328	MH299477	<i>Micromonospora auratinigra</i> DSM 44815 ^T	99
BTM	SN8_22.1	1470	MH299479	<i>Micromonospora auratinigra</i> DSM 44815 ^T	99
BTM	SN20_4.1	1172	MH299481	<i>Streptomyces peucetius</i> DSM 40754 ^T	99
BTM	SN27_101B.1	1458	MH299469	<i>Micromonospora aurantiaca</i> DSM 43813 ^T	98
BTM	SN28_94.1	1226	MH299495	<i>Streptomyces fragilis</i> DSM 40044 ^T	98
BTM	SN27_39.1	1174	MH299470	<i>Micromonospora aurantiaca</i> DSM 43813 ^T	97
HA	SN3_2.1	1472	MH299433	<i>Dactylosporangium luteum</i> DSM 45324 ^T	99
HA	SN3_3.1	1473	MH299434	<i>Dactylosporangium maewongense</i> JCM 15933 ^T	99
HA	SN28_40.1	1469	MH299443	<i>Nonomuraea jabiensis</i> DSM 45507 ^T	99
HA	SN10_5.1	1473	MH299451	<i>Micromonospora chokoriensis</i> JCM 13247 ^T	99
HA	SN3_4.1	1329	MH299475	<i>Micromonospora pattaloongensis</i> JCM 12833 ^T	99
HA	SN6_8.1	1349	MH299478	<i>Micromonospora pattaloongensis</i> DSM 43821 ^T	98
HA	SN28_222.1	1336	MH299490	<i>Streptomyces marinus</i> DSM 41968 ^T	97
OLI	SN20_9.1	1336	MH299441	<i>Nocardioopsis dassonvillei</i> DSM 43111 ^T	99
OLI	SN3_1.1	1471	MH299474	<i>Micromonospora rifamycinica</i> DSM 44983 ^T	99
OLI	SN28_1.1	1337	MH299489	<i>Streptomyces champavatii</i> DSM 40841 ^T	99
OLI	SN25_300.1	1336	MH299446	<i>Marmoricola bigeumensis</i> DSM 19426 ^T	98
OLI	SN27_3.1	1299	MH299487	<i>Streptomyces deserti</i> KACC J5425 ^T	97
SIMA1	SN20_15.1	1049	MH299453	<i>Micromonospora sediminicola</i> NBRC 107934 ^T	100
SIMA1	SN25_555.1	1340	MH299425	<i>Actinomycetospira straminea</i> JCM 17983 ^T	99
SIMA1	SN25_202.1	1334	MH299431	<i>Blastococcus aggregatus</i> DSM 4725 ^T	99

S1MA1	SN25_10.1	1335	MH299437	<i>Geodermatophilus tzadiensis</i> DSM 45416 ^T	99
S1MA1	SN25_201.1	1332	MH299459	<i>Micromonospora purpureochromogenes</i> DSM 43821 ^T	99
S1MA1	SN25_8.1	1339	MH299484	<i>Streptomyces fulvissimus</i> DSM 40593 ^T	99
S1MA1	SN28_3.1	1342	MH299491	<i>Streptomyces lydicus</i> ATCC 25470 ^T	99
S1MA1	SN28_4.1	1339	MH299492	<i>Streptomyces cyslabanicus</i> DSM 42135 ^T	99
S1MA1	SN6_2.1	1338	MH299496	<i>Streptomyces chumphonensis</i> JCM 18522 ^T	99
S1MA1	SN8_2.1	1135	MH299442	<i>Nonomuraea maritima</i> NBRC 106687 ^T	98
S1MA1	SN25_203.1	1343	MH299447	<i>Microbacterium thalassium</i> DSM 12511 ^T	98
S1MA1	SN26_100.1	1364	MH299466	<i>Micromonospora purpureochromogenes</i> DSM 43821 ^T	98
S1MA1	SN20_12.1	1323	MH299480	<i>Streptomyces panacagi</i> DSM 41871 ^T	98
S1MA1	SN25_508.1	1342	MH299482	<i>Streptomyces marinus</i> DSM 41968 ^T	97
S1MA1	SN25_200.1	1289	MH299438	<i>Nocardioides iriomatensis</i> JCM 17985 ^T	96
S1MA1	SN27_500.1	1478	MH299448	<i>Ornithinimicrobium kibberense</i> DSM 17687 ^T	96
S1MA1	SN7_3.1	1336	MH299427	<i>Aeromicrobium erythreum</i> DSM 8599 ^T	94

Supplementary information of publication 2

**Antitumor anthraquinones from an Easter Island sea anemone:
animal or bacterial origin?**

Antitumor anthraquinones from an Easter Island sea anemone: Animal or bacterial origin?

Ignacio Sottoriff^{1,2}, Sven Künzel³, Jutta Wiese¹, Matthias Lipfert⁴, Nils Preußke⁴, Frank D. Sönnichsen⁴, and Johannes F. Imhoff^{1,*}

¹ GEOMAR Helmholtz Centre for Ocean Research Kiel, Marine Microbiology, Kiel, Germany; isottorff@geomar.de, jwiese@geomar.de, jimhoff@geomar.de

² Facultad de Ciencias Naturales y Oceanográficas, Universidad de Concepción, Chile.

³ Max Planck Institute for Evolutionary Biology, Plön, Germany; kuenzel@evolbio.mpg.de

⁴ Otto Diels Institute for Organic Chemistry, University of Kiel; fsoennichsen@oc.uni-kiel.de, mlipfert@oc.uni-kiel.de, npreusske@oc.uni-kiel.de

* **Correspondence:** jimhoff@geomar.de; Tel.: +49 431 600-4450

Table 1. Isolated actinobacterial symbionts from the Easter Island sea anemone *Gyraactis sesere*.

Media	Sample	Closest type strain obtained from BLAST	Sequence length	Access number NCBI	% identity
BSEM	SN26_101.1	<i>Cellulosimicrobium funkeri</i> DSM 16025 ^T	1476	MH299430	99
BCM	SN26_23.1	<i>Arthrobacter koreensis</i> JCM 12361 ^T	1338	MH299428	99
BCM	SN26_6.1	<i>Arthrobacter arilaitensis</i> DSM 16368 ^T	1481	MH299429	98
BTM	SN26_12.1	<i>Rhodococcus soli</i> DSM 46662 ^T	1475	MH299445	99
BCM	SN26_22.1	<i>Streptomyces drozdowiczii</i> JCM 13580 ^T	1336	MH299485	99
BTM	SN26_13A.1	<i>Dietzia cinnamea</i> DSM 44904 ^T	1471	MH299435	99
BTM	SN26_14.1	<i>Verrucosipora maris</i> DSM 45365 ^T	1538	MK332504	99
BTM	SN26_25.1	<i>Micromonospora rifamycinica</i> DSM 44983 ^T	1417	MH299468	99
SIMA1	SN26_100.1	<i>Micromonospora purpureochromogenes</i> DSM 43821 ^T	1364	MH299466	98
BTM	SN26_110.1	<i>Micromonospora echinospora</i> DSM 43816 ^T	1330	MH299467	99

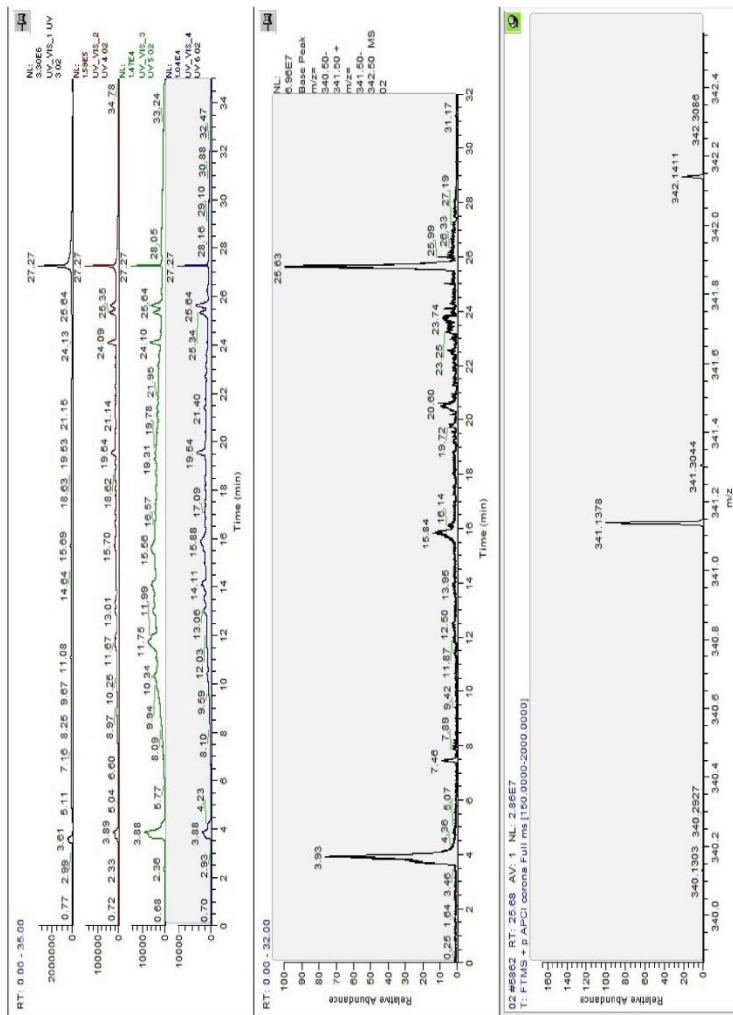

Suppl. Fig. 1. BPC extraction of Sea anemone chloroform extract for Lupinacidin A (1) (MW: 340).

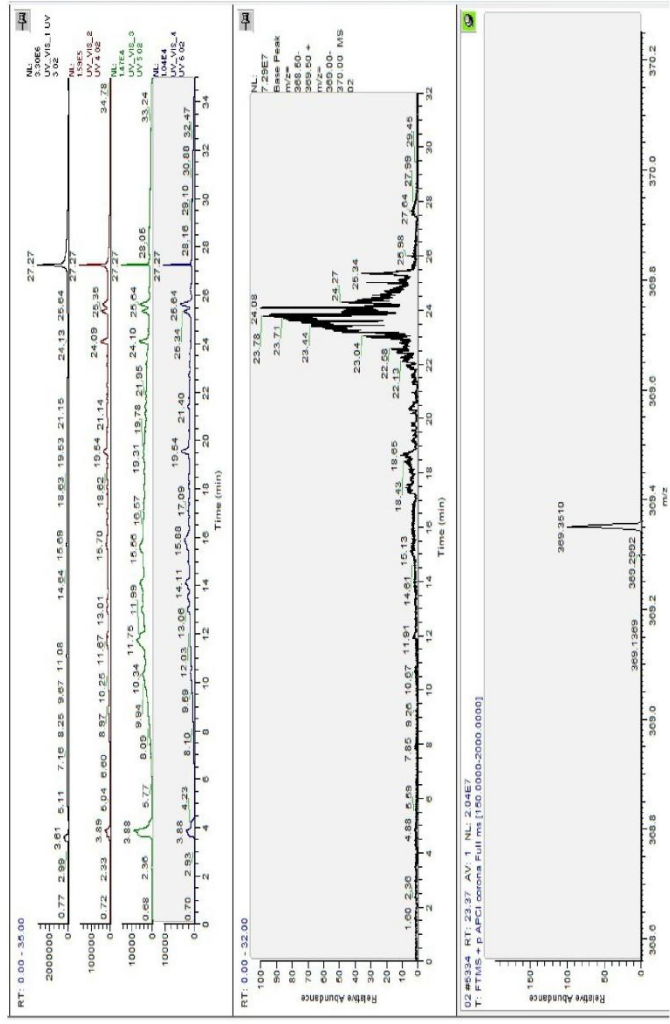

Suppl. Fig. 2. BPC extraction of Sea anemone- Chloroform extract for Galvaquinone B (2) (MW: 368).

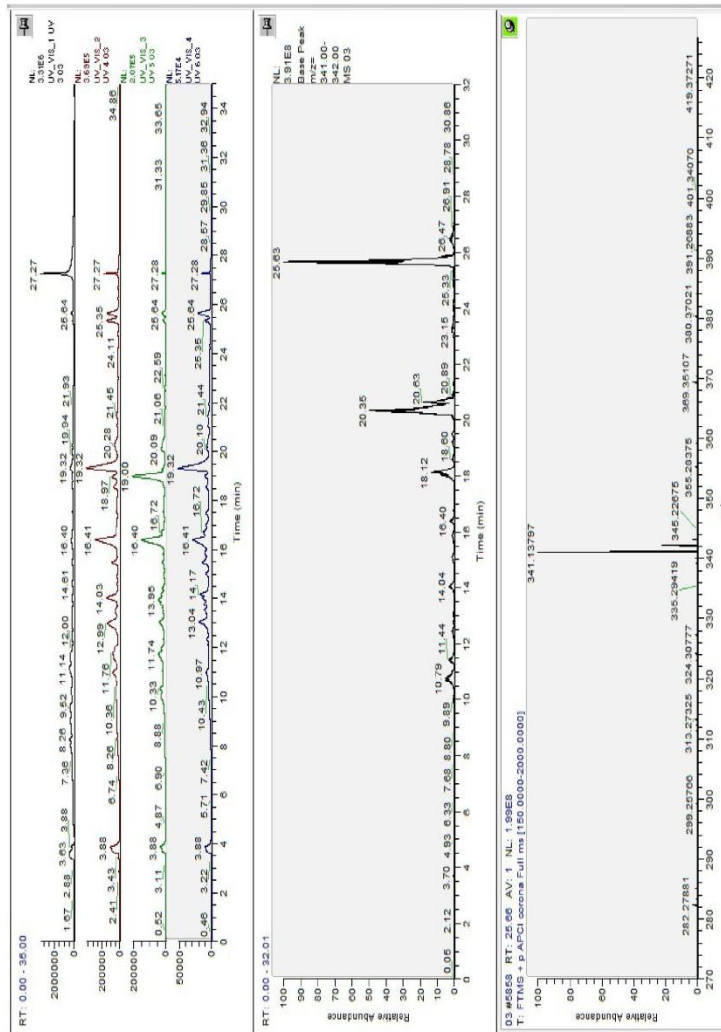

Suppl. Fig. 3. BPC extraction of Lupinacin A (1) (MW: 340) from the crude extract of *Verrucosipora* sp. SN26_14.1 isolated from the Easter Island sea anemone, *Gyactis sesere*.



Suppl. Fig. 6. Purified Galvaquinone B (**2**) (left) and Lupinacidin A (**1**) (right) obtained from the sea anemone symbiont, *Verrucosispora* sp. SN26_14.1.

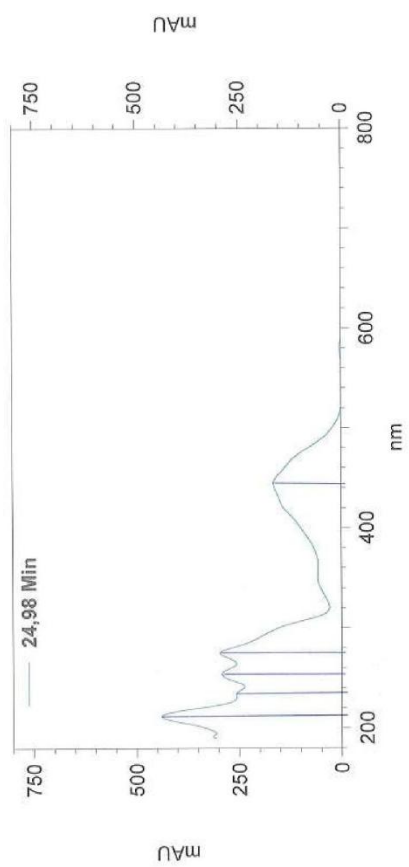

Suppl. Fig. 7. UV profile for Lupinacidin A (1).

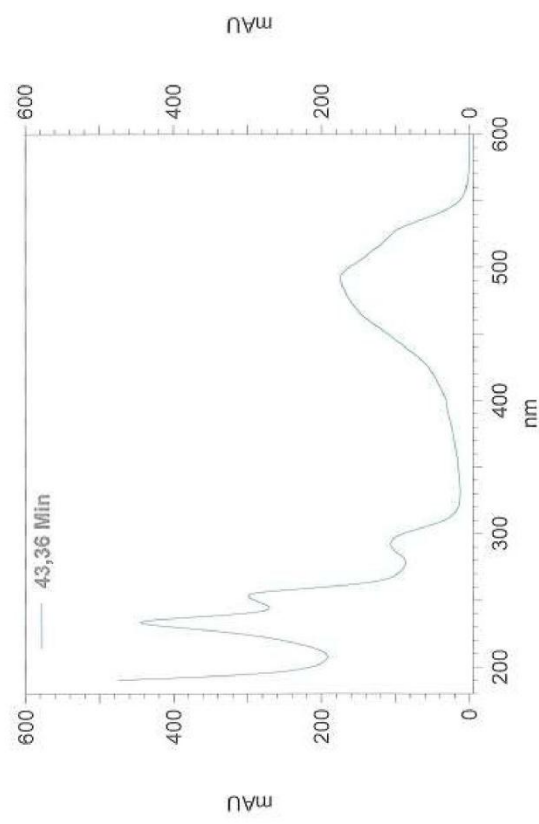

Suppl. Fig. 8. UV profile for Galvaquinone B (2).

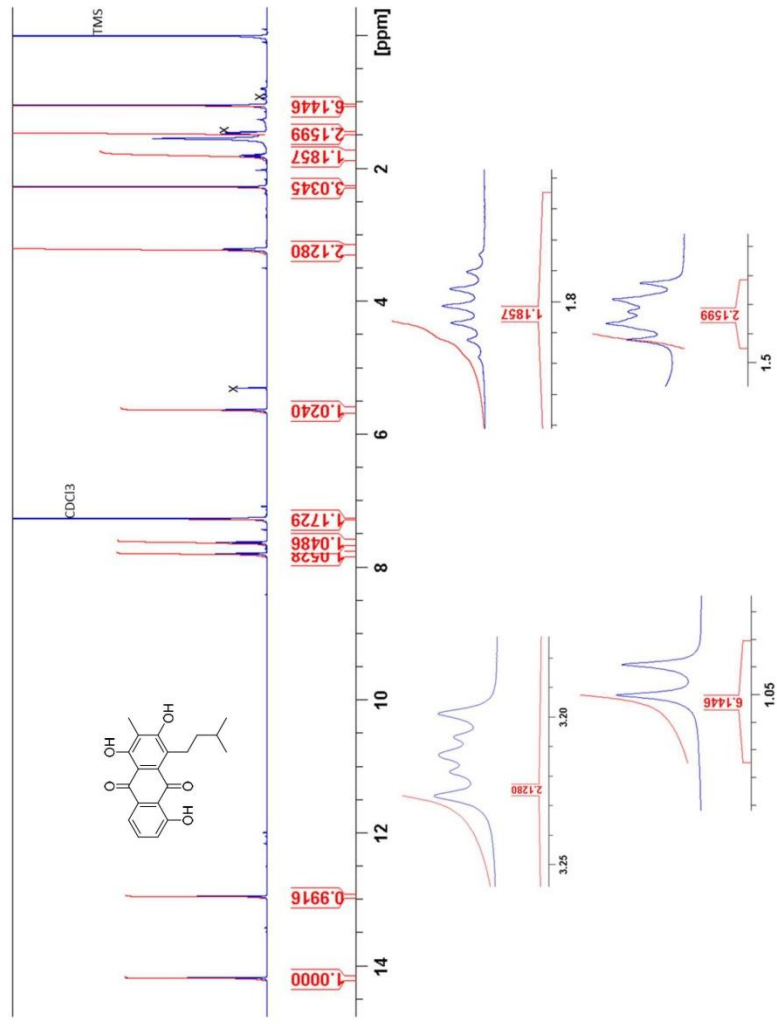

Suppl. Fig. 11. ¹H NMR of Lupinacinin A (1).

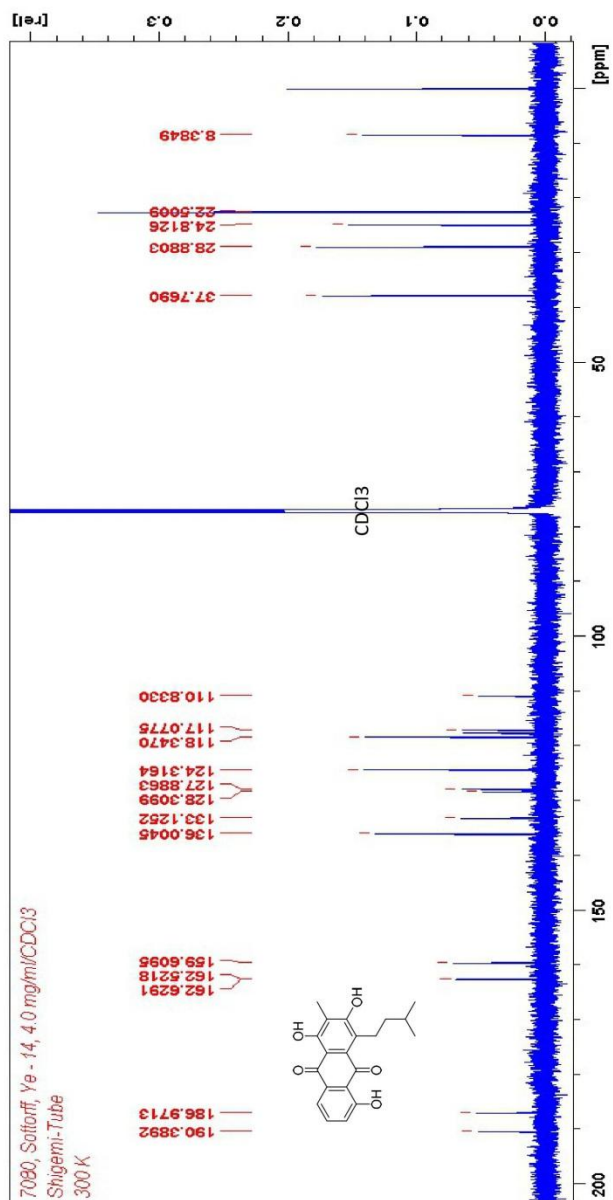

Suppl. Fig. 12. ¹³C Lupinacinin A (1).

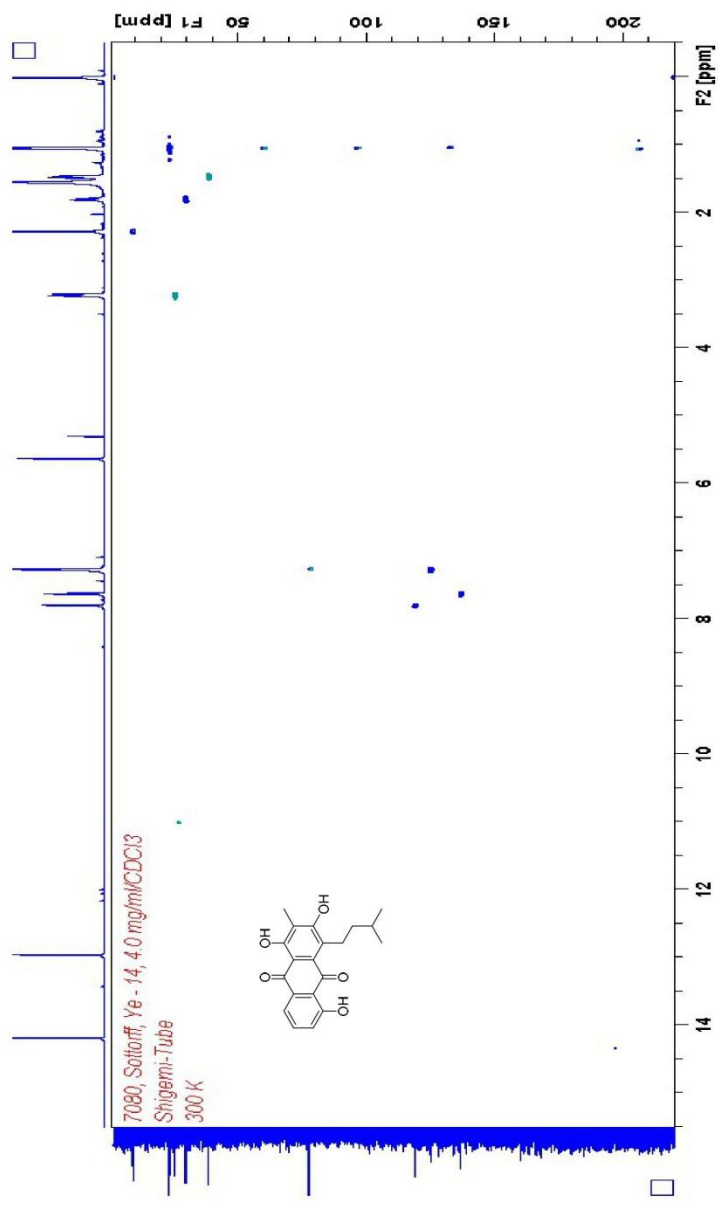

Suppl. Fig. 13. HSQC for Lupinacidin A (1).

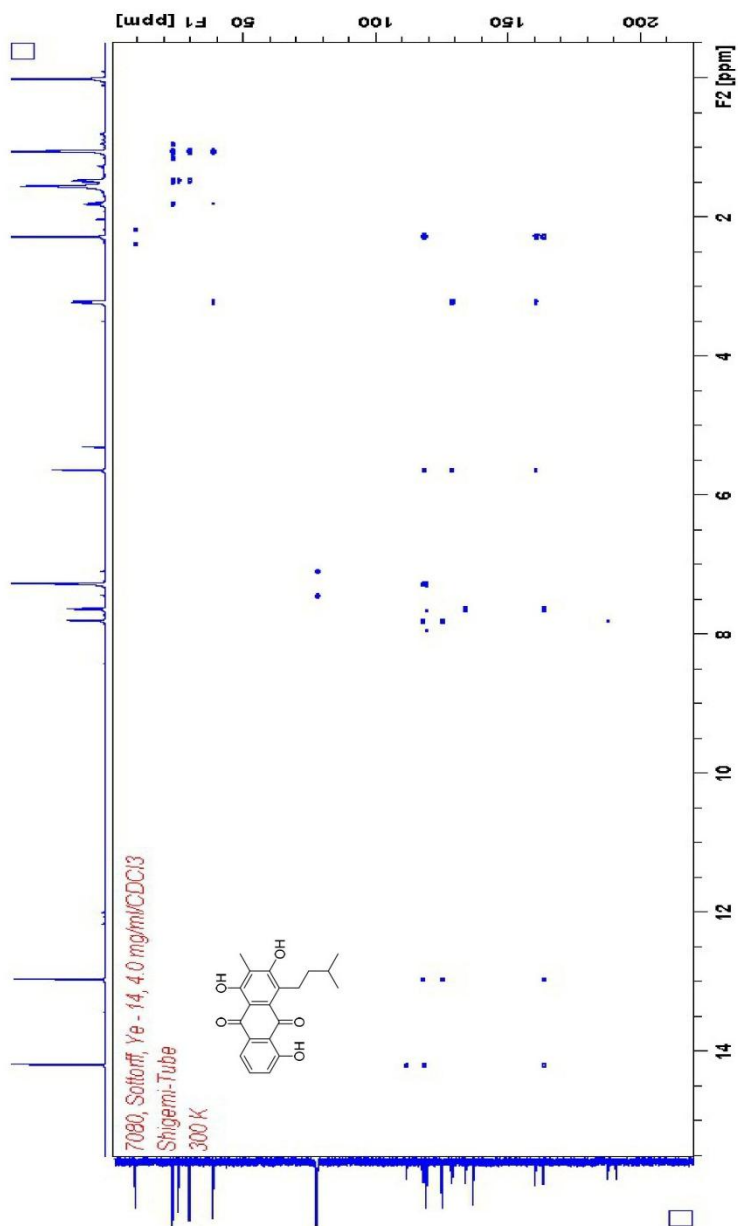

Suppl. Fig. 14. HMBC for Lupinacin A (1).

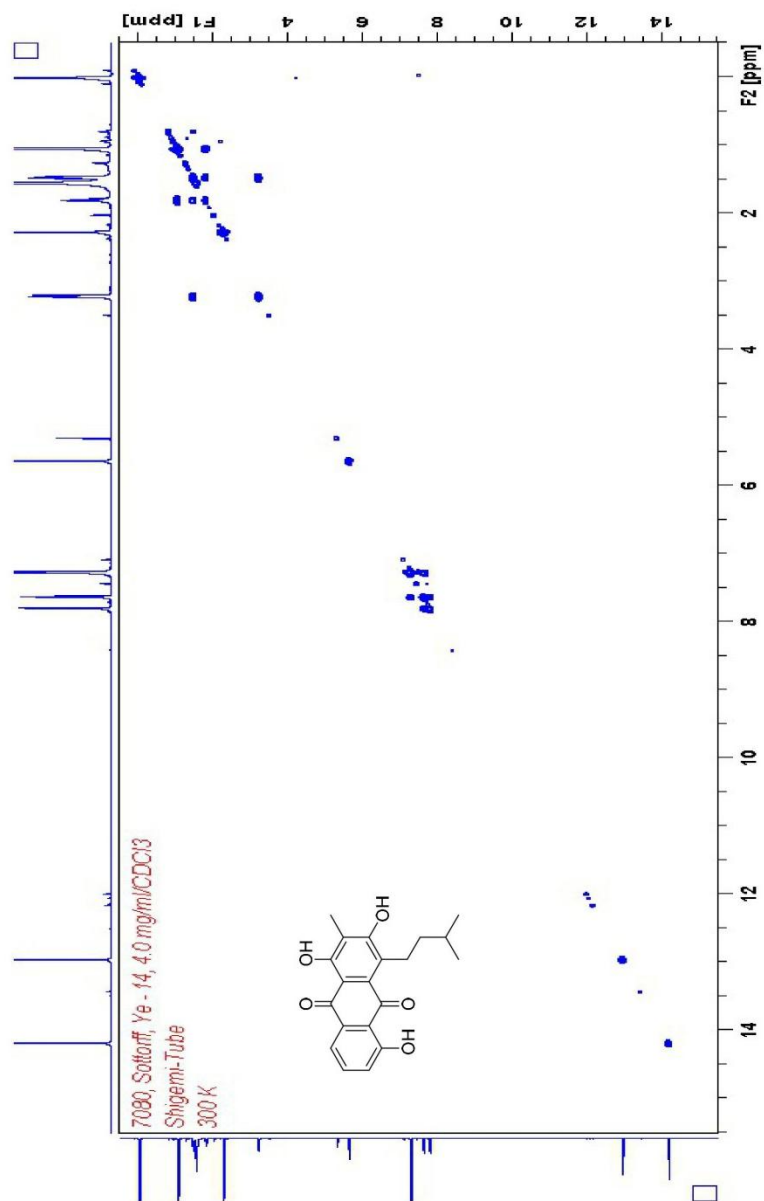

Suppl. Fig. 15. COSY for Lupinacidin A (1).

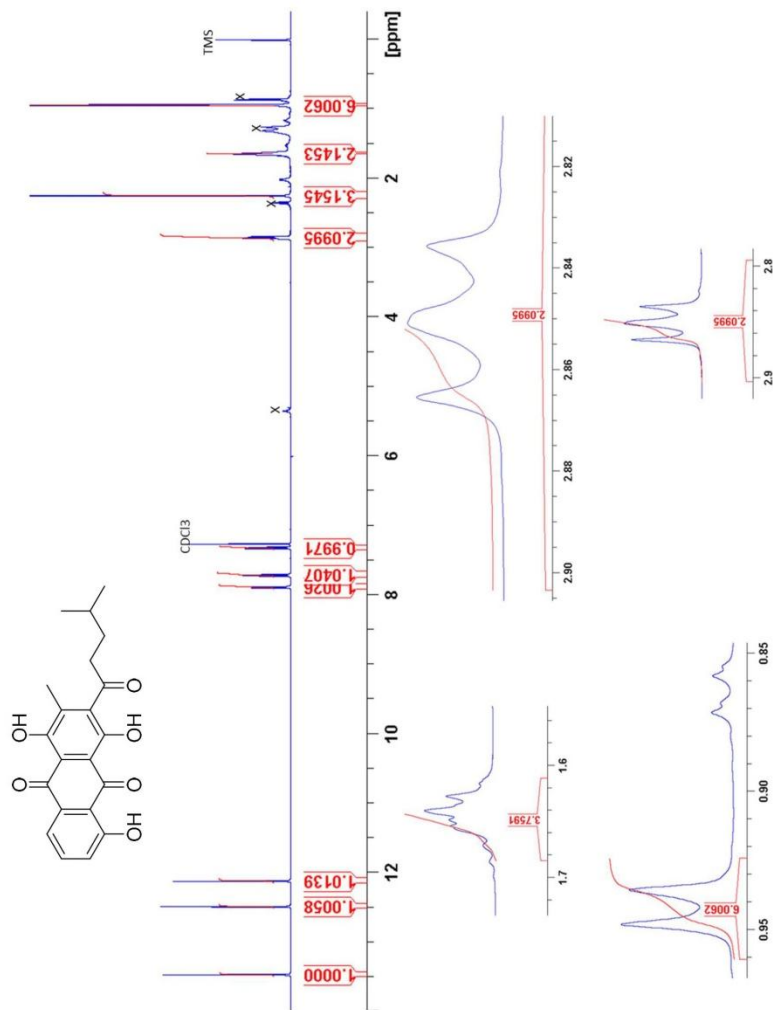

Suppl. Fig. 16. ¹H Galvaquinone B (2).

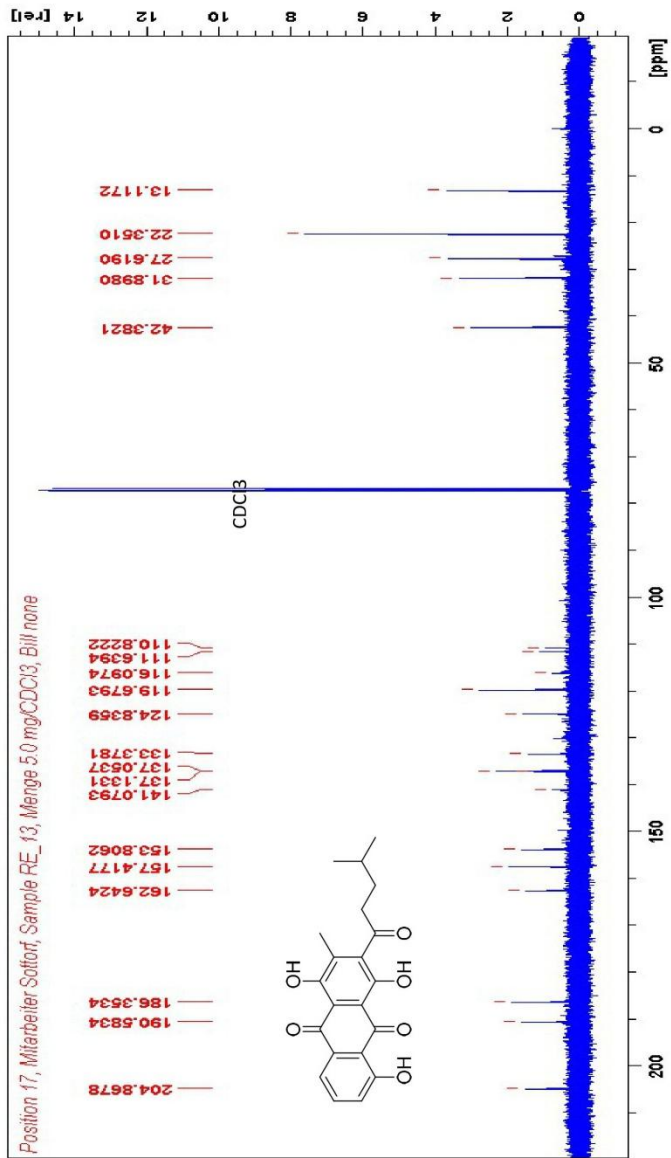

Suppl. Fig. 17. ¹³C Galvaquinone B (2).

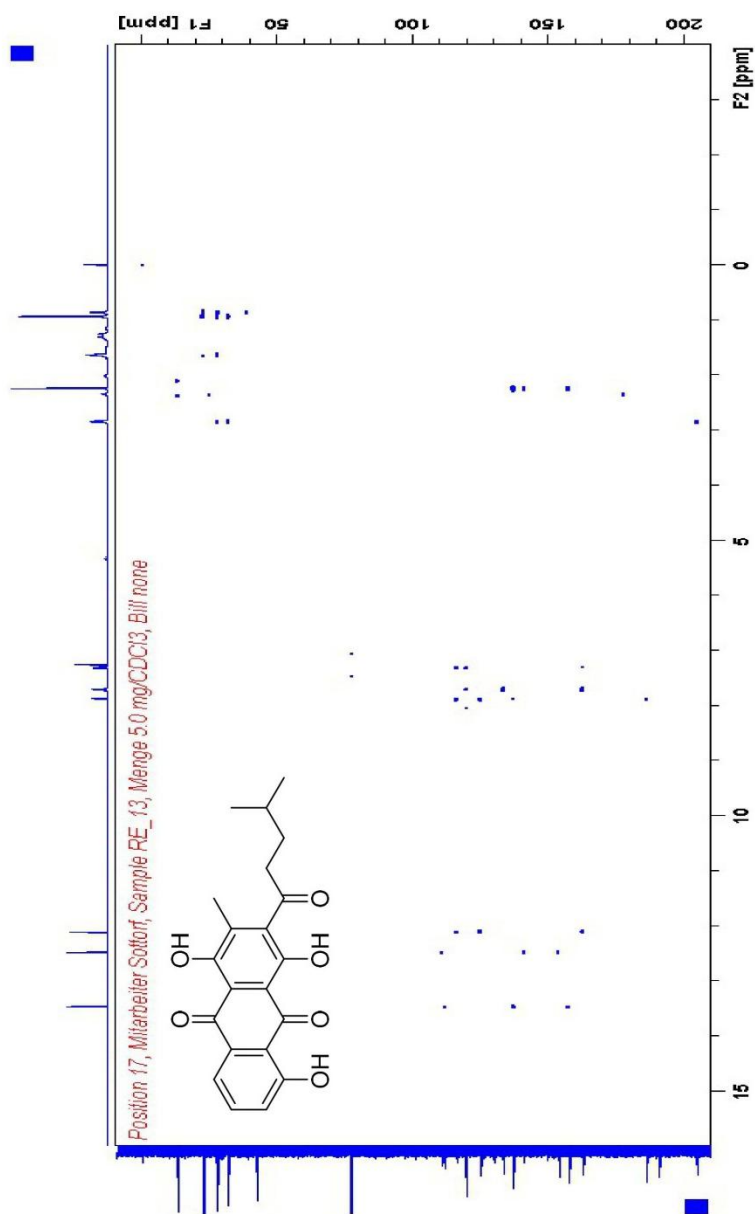

Suppl. Fig. 19. HMBC Galvaquinone B (2).

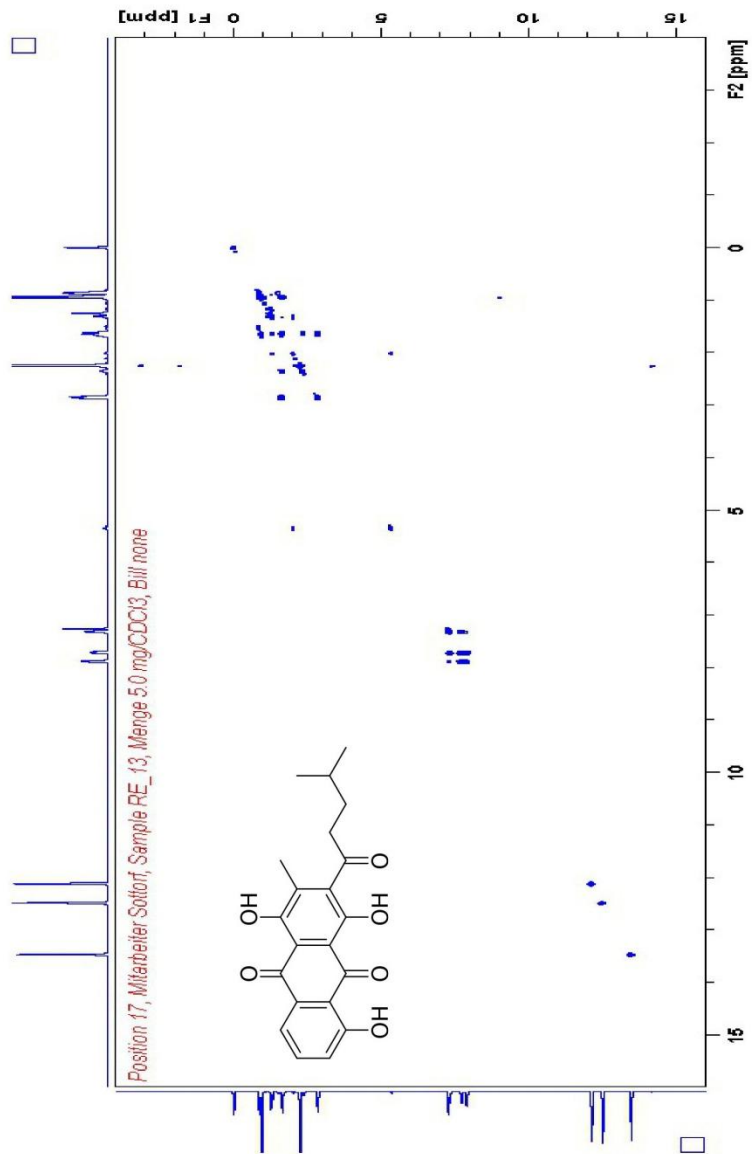

Suppl. Fig. 20. COSY Galvaquinone B (2).

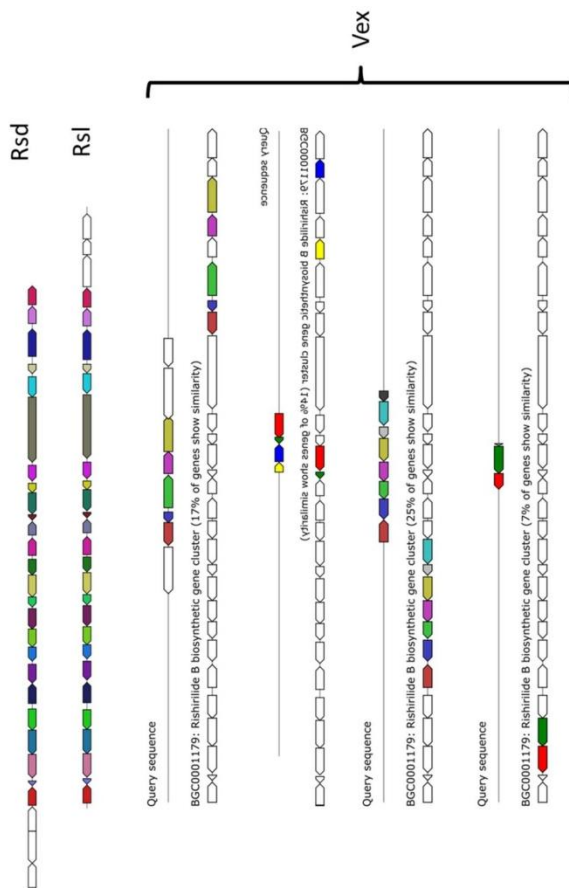

Suppl. Fig. 21. Rsd, Rsl, and Vex gene clusters comparison of the Lupinacidin A (1) and Galvaquinone B (2) producers.

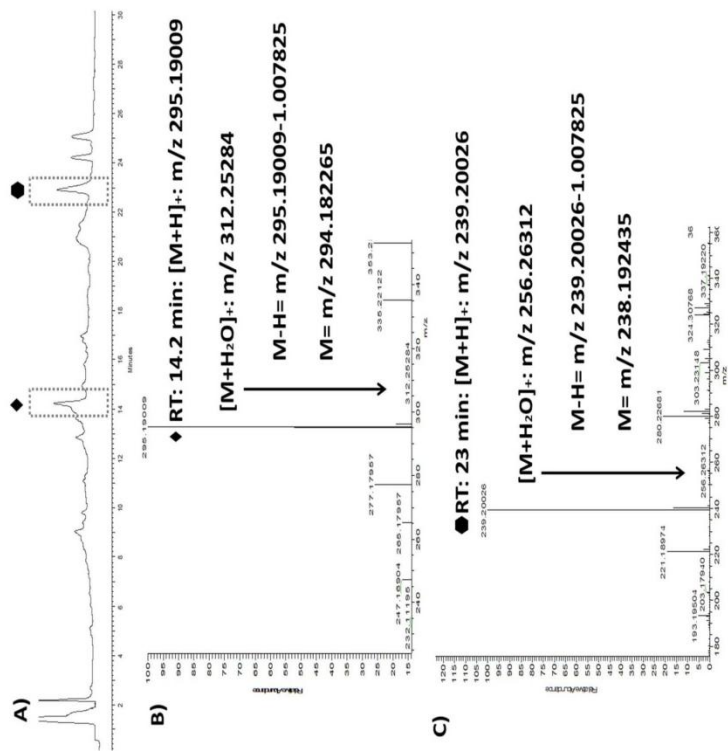

Suppl. Fig. 22. Complementary evaluation of the sea anemone crude extract. Diamond: RT:14.2 min. Hexagon: RT: 23 min. A) UV Chromatogram (254 nm) of the crude extract of the sea anemone *Gyrodactis sesere* highlighting the specific peaks for RT 14.2 min (diamond) and RT 23 min (hexagon). B) High resolution mass for RT 14.2 min. C) High resolution mass for RT 23 min. *RT: Retention Time.

Supplementary information of publication 3

Different secondary metabolite profiles of phylogenetically almost identical *Streptomyces griseus* strains originating from geographically remote locations



Article

Different secondary metabolite profiles of phylogenetically almost identical *Streptomyces griseus* strains originating from geographically remote locations

Ignacio Sottorff^{1, 2}, Jutta Wiese¹, Matthias Lipfert³, Nils Preußke³, Frank D. Sönnichsen³, and Johannes F. Imhoff^{1,*}

¹ GEOMAR Helmholtz Centre for Ocean Research Kiel, Marine Microbiology, 24105 Kiel, Germany; isottorff@geomar.de, jwiese@geomar.de, jimhoff@geomar.de

² Facultad de Ciencias Naturales y Oceanográficas, Universidad de Concepción, 4070386 Concepción, Chile.

³ Otto Diels Institute for Organic Chemistry, University of Kiel, 24118 Kiel, Germany; fsoennichsen@oc.uni-kiel.de, mlipfert@oc.uni-kiel.de, npreusske@oc.uni-kiel.de * Correspondence: jimhoff@geomar.de; Tel.: +49 431 600-4450

```

Easter_Island 1 UGACUUUUAUCUGGCUAGGACGAACGCUGGGGGCGUUCUUAAGCAUGCAAGUCGAAAGUUAAGGCUUUUGGGUUGUUUUGGGG
Russia 1 GAGUUUGAUCCUGGCAGGACGAACGCUGGGGGCGUUAACACAUGCAAGUCGAACGAUAAGGCUUUUGGGUUGUUUUGGGC

Easter_Island 91 AACGGUUAUUAACAGUUGGCAUUCUGCCUUGACUUGGGACAGGCCCUGAAACGGGCUUUAUAGCGUUAAGACUUAUUGCCGA
Russia 90 AACGGUUGAUUAACAGUUGGCAUUCGCCUUGACUUGGGACAGGCCCUGAAACGGGCUUUAUAGCGUUAACAGUUAUUGCCGA

Easter_Island 181 UGGACGGGUUAAGACUCGGCGGUUAAGGAUAGCCCGGGGCUUUAAGUUGUUGGUUGGGUUAUGGCUUGCAAGGGACGAGGG
Russia 180 UGGACGGGUUAAGACUCGGCGGUUAAGGAUAGCCCGGGGCUUUAAGUUGUUGGUUGGGUUAUGGCUUCCAGGGACGAGGG

Easter_Island 271 UAGCCGGCUUGAGAGGGACCGCCACAGUGGACUGAGACAGGCCAGACUUCUACGGGAGGCAGCAUUGGGAAUUAUGCACAU
Russia 270 UAGCCGGCUUGAGAGGGACCGCCACAGUGGACUGAGACAGGCCAGACUUCUACGGGAGGCAGCAUUGGGAAUUAUGCACAU

Easter_Island 361 GGGCAAAAGCUUAUCAGCGACCGCCUGAGGGAUAGCGCCUUCGGUUUAAGCUUUUACGAGGGAAGAGCGAGAGUAGCGG
Russia 360 GGGCAAAAGCUUAUCAGCGACCGCCUGAGGGAUAGCGCCUUCGGUUUAAGCUUUUACGAGGGAAGAGCGAGAGUAGCGG

Easter_Island 451 UACCUUGCAGAAAGCGCCGCUAACUACGUUCCAGCAGCCGGUUAUACGUAGGGCGCAAGGCUUUCGGAAUUAUUGGCUUAAAG
Russia 450 UACCUUGCAGAAAGCGCCGCUAACUACGUUCCAGCAGCCGGUUAUACGUAGGGCGCAAGGCUUUCGGAAUUAUUGGCUUAAAG

Easter_Island 541 AGUCUUGAGGGGCUUUCAGUCGGUUGAAAGCCCGGGCUUAACCCGGUUCGAUUCGAUACGGGUAGCUGAGAUUGGUAGG
Russia 540 AGUCUUGAGGGGCUUUCAGUCGGUUGAAAGCCCGGGCUUAACCCGGUUCGAUUCGAUACGGGUAGCUGAGAUUGGUAGG

Easter_Island 631 GGAGUUGGAUUCUGGUUAAGCGGUUAUUGCGAGAUUAAGGAGAACACCGUUGCGAAGCGGAUUCUUGGGCCUUAUUGAGC
Russia 630 GGAGUUGGAUUCUGGUUAAGCGGUUAUUGCGAGAUUAAGGAGAACACCGUUGCGAAGCGGAUUCUUGGGCCUUAUUGAGC

Easter_Island 721 CUGAGGAGCAAAAGCGUGGGAGCGAACAGGAUUAAGAUACCCUGGUUAUCACCGCCUUAAGCUUGGAAUUGGUUGGCGACAUUC
Russia 720 CUGAGGAGCAAAAGCGUGGGAGCGAACAGGAUUAAGAUACCCUGGUUAUCACCGCCUUAAGCUUGGAAUUGGUUGGCGACAUUC

Easter_Island 811 ACUCUUGGUGCCGAGCUAACCAUUAAGUUCGCCGUGGGAGUACGGCCGAAGCUAAAAUCAAAAGAUUAAGCGGGGCCG
Russia 810 ACUCUUGGUGCCGAGCUAACCAUUAAGUUCGCCGUGGGAGUACGGCCGAAGCUAAAAUCAAAAGAUUAAGCGGGGCCG

Easter_Island 901 CACAAGCAGCGAGCAUUGGCUUAUUCGACGCAACCGAAGAACUUAACCAAGGUUGAGAUUAACGGAAAGCAUCAGAGAUGGUC
Russia 900 CACAAGCAGCGAGCAUUGGCUUAUUCGACGCAACCGAAGAACUUAACCAAGGUUGAGAUUAACGGAAAGCAUCAGAGAUGGUC

Easter_Island 991 CCCCCUUGGGUGGUUAACAGUUGGUCUUGGUUCUGCAGUCGUUCUGUGAGAUUUUGUUAAAGUCCCGAACGAGCGCAACCCU
Russia 990 CCCCCUUGGGUGGUUAACAGUUGGUCUUGGUUCUGCAGUCGUUCUGUGAGAUUUUGUUAAAGUCCCGAACGAGCGCAACCCU

Easter_Island 1081 UUUUUUUUUUCCAGCAUUGCCUUGGGGUUAUUGGGACUACAGGAGACUCCGGGUUACUUGGAGGAAGGUUGGACGACGUCAA
Russia 1080 UUUUUUUUUUCCAGCAUUGCCUUGGGGUUAUUGGGACUACAGGAGACUCCGGGUUACUUGGAGGAAGGUUGGACGACGUCAA

Easter_Island 1171 GUCAUCAUGCCCUUAUGGUUGGGUGCACACUGGUAACAUUGGCCGUUACAAUGAGUGCGAUUGCCGAGGGGAGCGAAUUCAAA
Russia 1170 GUCAUCAUGCCCUUAUGGUUGGGUGCACACUGGUAACAUUGGCCGUUACAAUGAGUGCGAUUGCCGAGGGGAGCGAAUUCAAA

Easter_Island 1261 AAGCCGGUCUAGUUCGGAUUGGGUUCGCAACUGGACCCUUAAGUUGGAGUUGCUAGUUAUCGAGAUACGCAUUGCCGGUGAAU
Russia 1260 AAGCCGGUCUAGUUCGGAUUGGGUUCGCAACUGGACCCUUAAGUUGGAGUUGCUAGUUAUCGAGAUACGCAUUGCCGGUGAAU

Easter_Island 1351 ACGUUCGGGGCUUUAACACACCGCCGUCACUUCACGAAAGUGGUUAACACCGAAGCCGUUGGCCAACCCUUAUGGGAGGAGCU
Russia 1350 ACGUUCGGGGCUUUAACACACCGCCGUCACUUCACGAAAGUGGUUAACACCGAAGCCGUUGGCCAACCCUUAUGGGAGGAGCU

Easter_Island 1441 GUCGAAGUGGGACUGGCCAUUGGACGAAGUCGUAA
Russia 1440 GUCGAAGUGGGACUGGCCAUUGGACGAAGUCGUAA

```

Supplementary Figure 1 Alignment of the 16S rRNA gene sequences of two *Streptomyces* strains. Easter Island: *Streptomyces* sp. SN25_8.1 (NCBI access# MK734066), Russia: *Streptomyces griseus* subsp. *griseus* DSM 40236^T (NCBI access# MK734067)

Dereplication - HRLCMS

Table 1 Dereplication overview

<i>Streptomyces</i> sp. SN25_8.1			<i>Streptomyces griseus</i> subsp. <i>griseus</i> DSM 40236 τ		
rt	mass	compounds	rt	mass	compounds
3.1	259.0844	Albidopyrone			
5.38	292.19019	Cyclizidine			
8.58	211.14388	Gancidin W	8.58	211.14388	Gancidin W
9.33	245.12811	YF-0200-R-B	9.33	245.12811	YF-0200-R-B
9.54	311.13843	Emycin E	9.54	311.13843	Emycin E
10	445.23267	Tetracycline	10	445.23267	Tetracycline
10.56	315.13336	Epithienamycin C			
			10.65	367.26843	Fortimicin KK1
11.33	282.16956	Cycloheximide			
11.6	340.1748	SF-733 C			
12.39	294.13306	Phenatic acid	12.39	294.13306	Phenatic acid
13.12	431.20593	Netropsin	13.12	431.20593	Netropsin
13.73	261.18454	N-Valyldihydroxyhomoproline			
15.3	276.12268	Actiphenol	15.3	276.12268	Actiphenol
17.26	415.21118	TMC-86B	17.26	415.21118	TMC-86B
18.46	352.2164	Protomycin			
			18.97	669.47778	Capromycin
			19.18	831.60242	Halstoctacosanolide B
			20.42	889.64447	YO-7625
			24.98	813.59229	Unknown
24.8	579.53381	Unknown			

Supplementary material

Dereplication - HRLCMS

Streptomyces sp. SN25_8.1

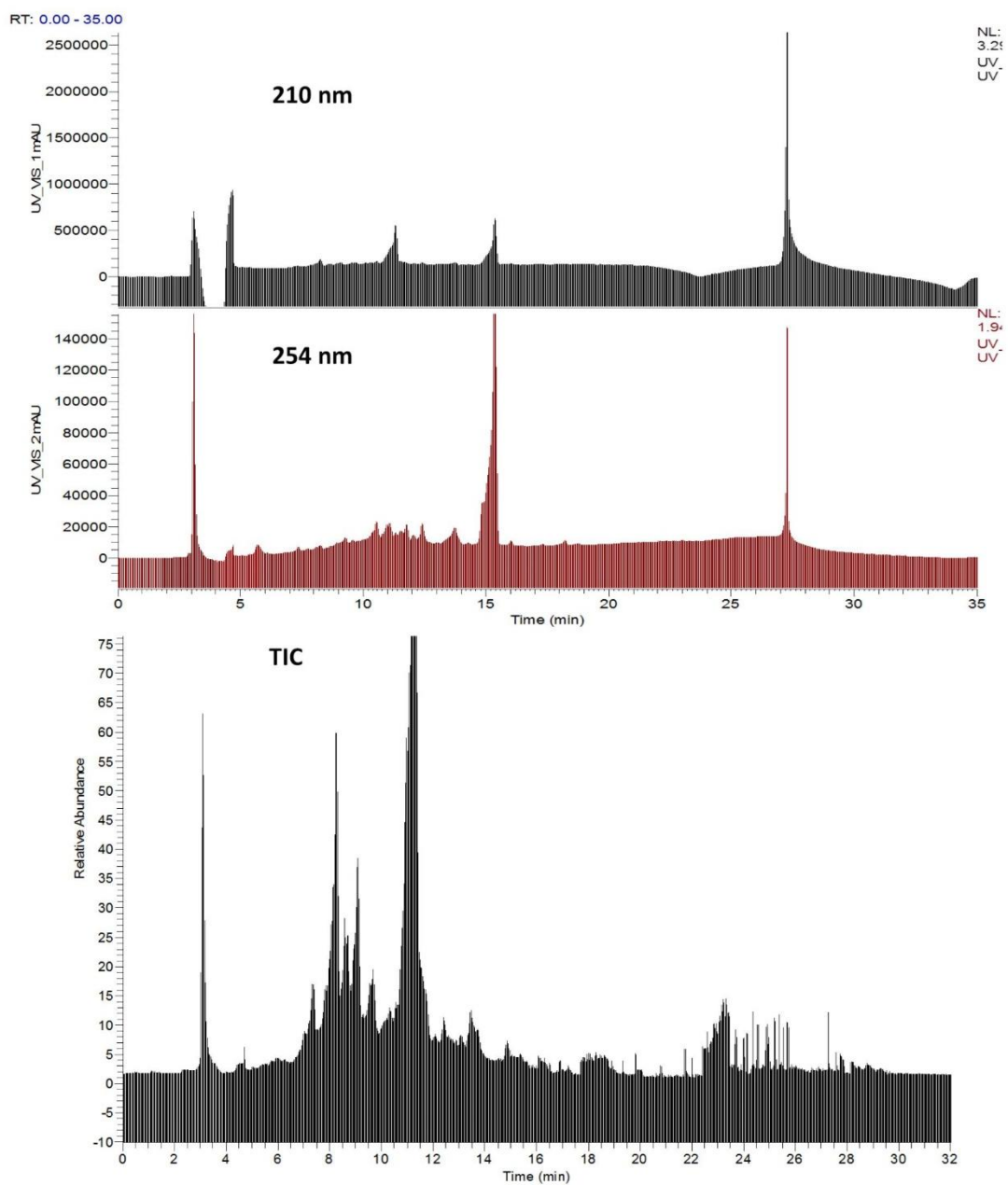

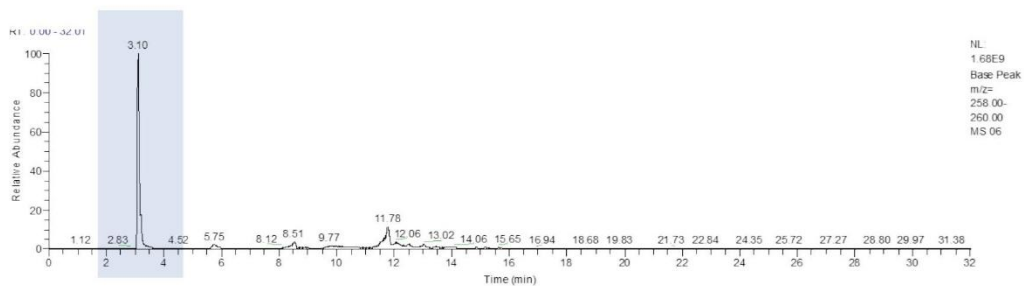

06 #712 RT: 3.12 AV: 1 NL: 1.30E9
T: FTMS + p APCI corona Full ms [150 0000-2000 0000]

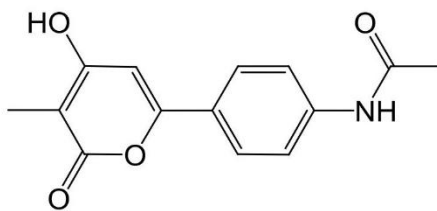
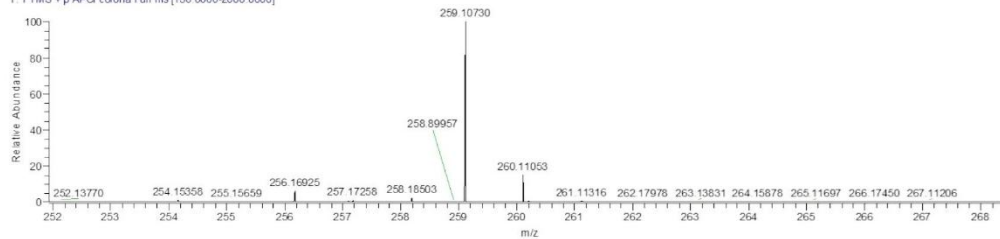

Albidopyrone

Chemical Formula: $C_{14}H_{13}NO_4$

Exact Mass: 259.08

Albidopyrone

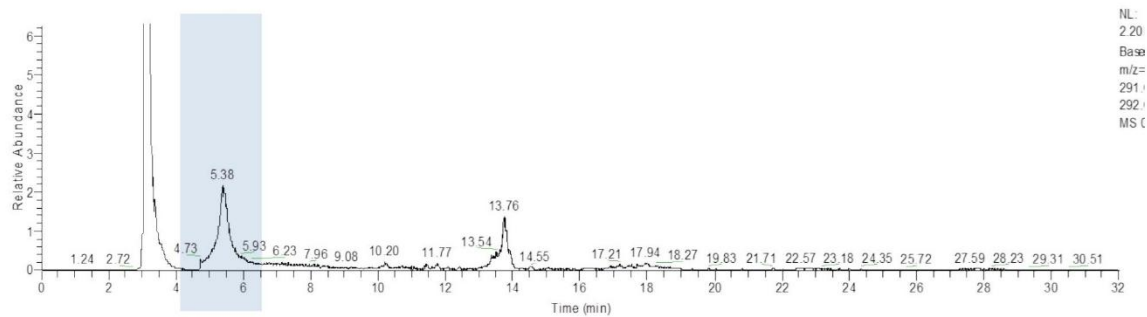

NL:
2.20
Base
m/z=
291.1
292.1
MS C

06 #1223 RT: 5.36 AV: 1 NL: 3.89E7
T: FTMS + p APCI corona Full ms [150.0000-2000.0000]

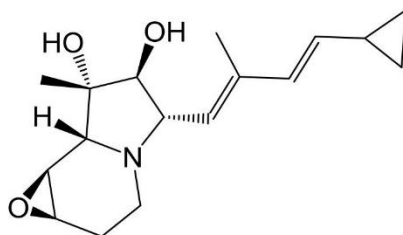
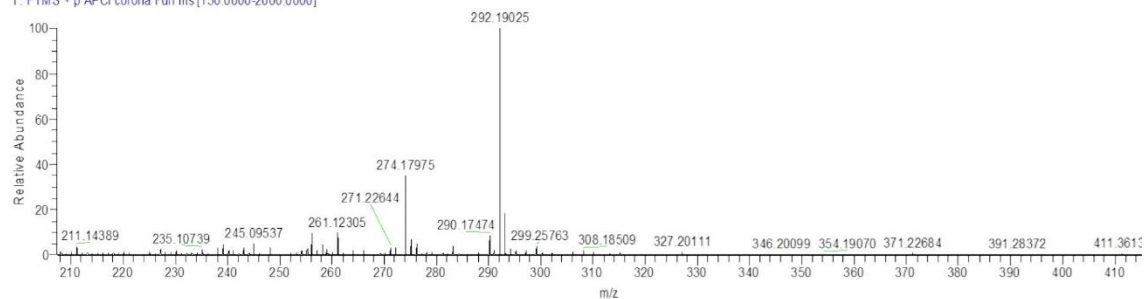

Cyclizidine

Chemical Formula: $C_{17}H_{25}NO_3$

Exact Mass: 291.18

Cyclizidine

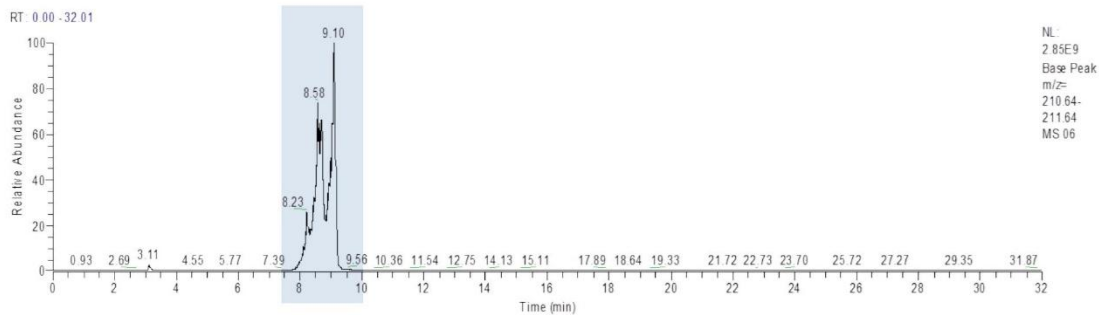

06 #1958 RT: 8.58 AV: 1 NL: 1.65E9
T: FTMS + p APCI corona Full ms [150.0000-2000.0000]

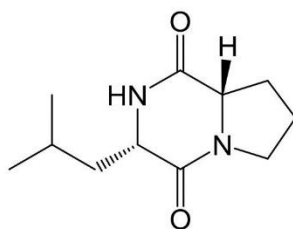
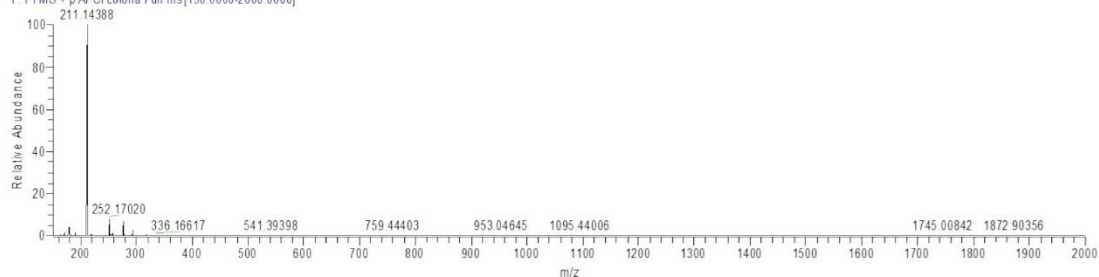

Gancidin W

Chemical Formula: $C_{11}H_{18}N_2O_2$

Exact Mass: 210.14

Gancidin W

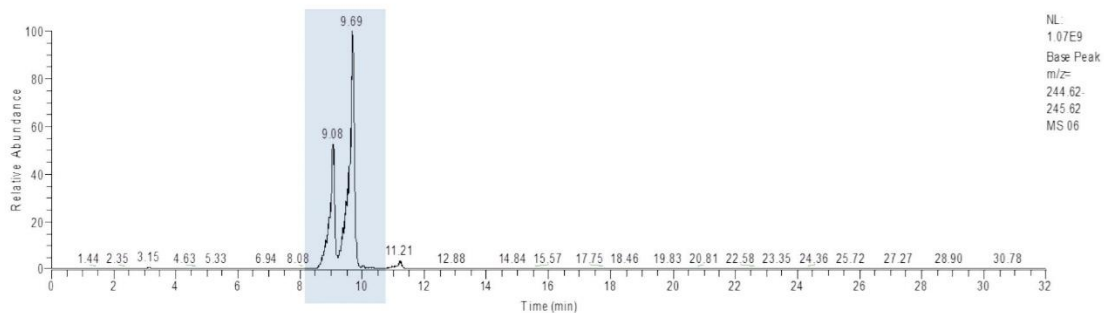

06 #2129 RT: 9.33 AV: 1 NL: 1.11E8
 T: FTMS + p APCI corona Full ms [150 0000-2000 0000]

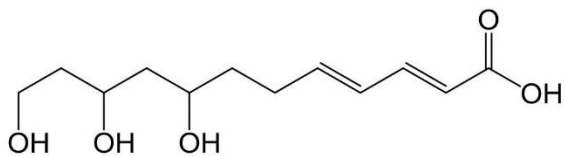
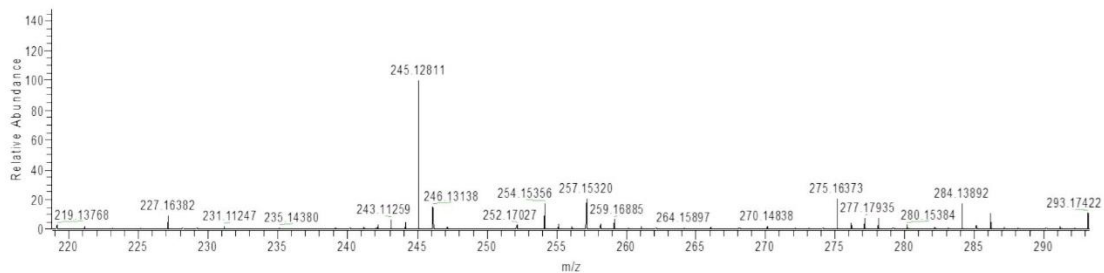

YF-0200-R-B

Exact Mass: 244.13
 Molecular Weight: 244.29

YF-0200-R-B

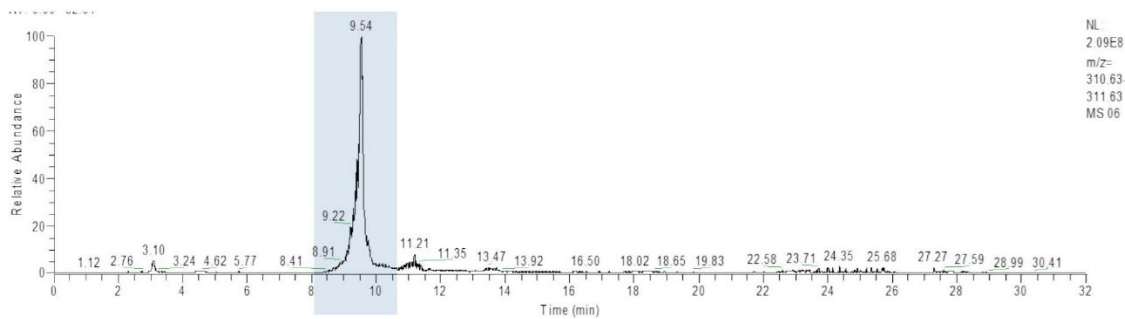

06 #2168 RT: 9.50 AV: 1 NL: 1.33E8
 T: FTMS + p APCI corona Full ms [150.0000.2000.0000]

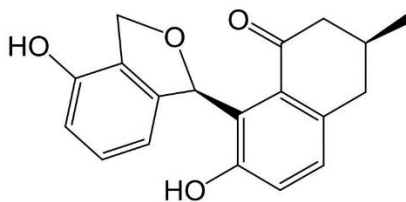
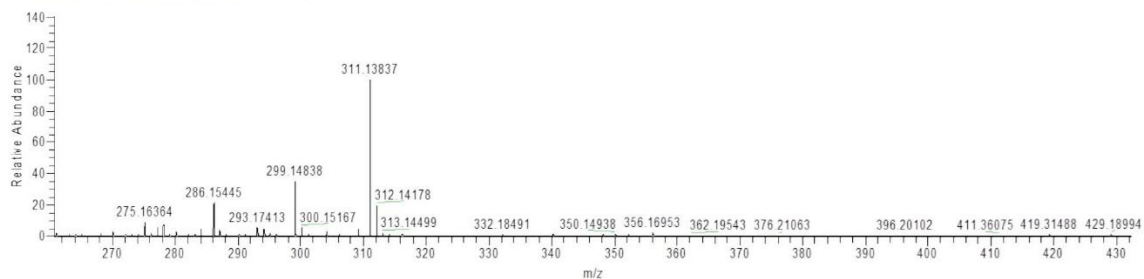

Emycin-E

Chemical Formula: $C_{19}H_{18}O_4$

Exact Mass: 310.12

Emycin E

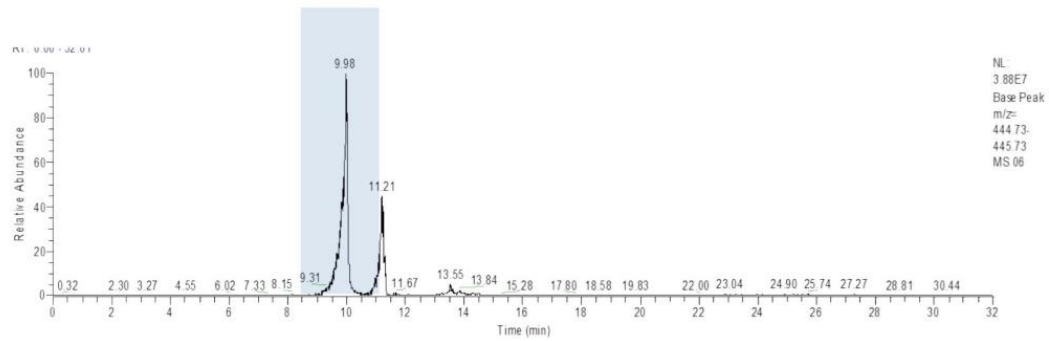

06 #2264 RT 9.92 AV 1 NL 1.85E7
 T FTMS + p APCI corona Full ms[150 0000-2000 0000]

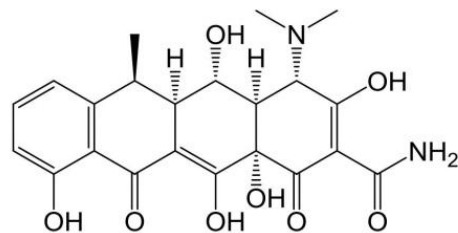
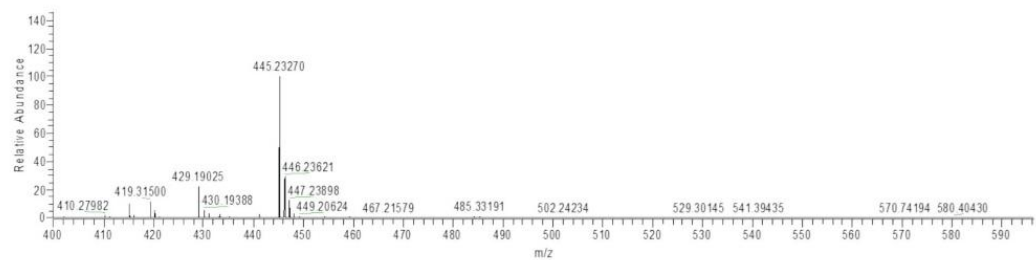

6-beta-deoxy-5-hydroxy-tetracycline

Chemical Formula: $C_{22}H_{24}N_2O_8$

Exact Mass: 444.15

6-beta-deoxy-5-hydroxy-tetracycline

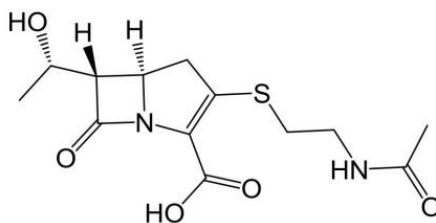
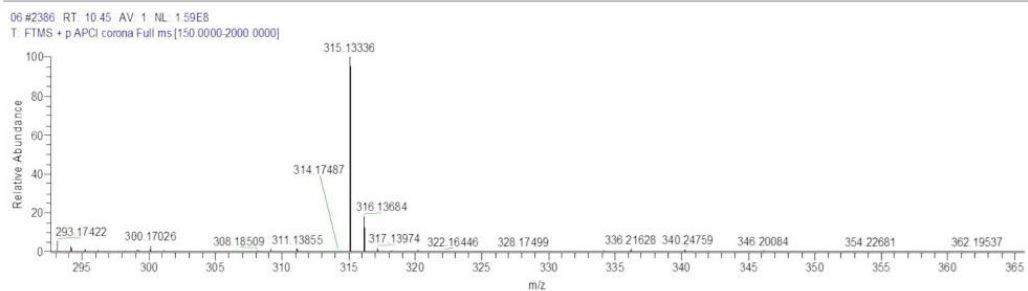
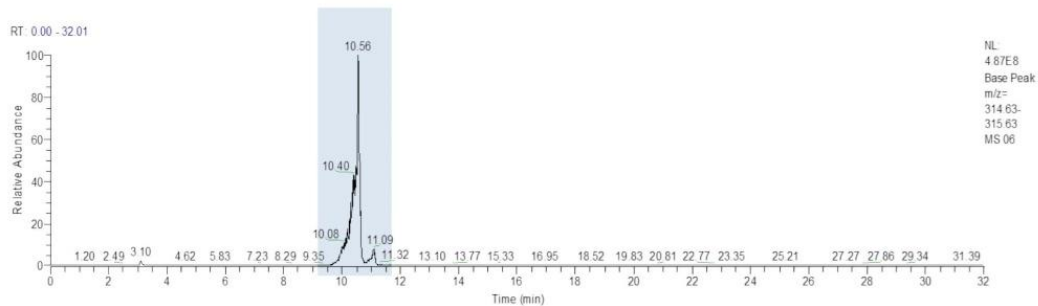

Epithienamycin-C

Chemical Formula: $C_{13}H_{18}N_2O_5S$

Exact Mass: 314.09

Epithienamycin C

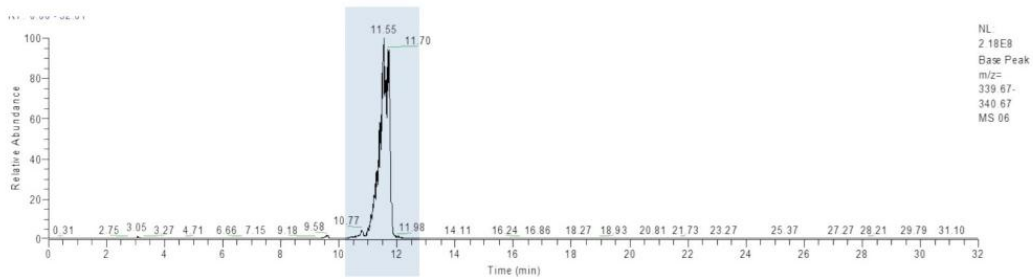

06 #2637 RT: 11.55 AV: 1 NL: 2.08E8
 T: FTMS + p APCI corona Full ms [150 0000-2000 0000]

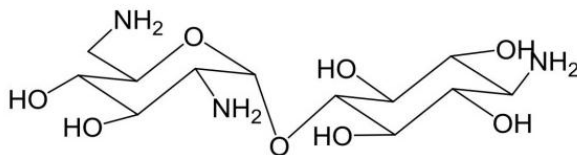
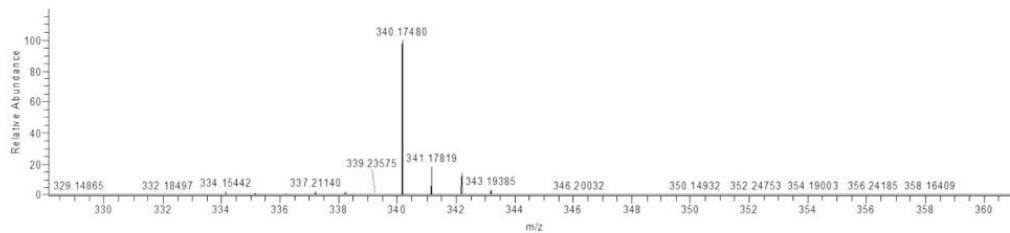

SF-733C

Chemical Formula: $C_{12}H_{25}N_3O_8$

Exact Mass: 339.16

SF-733 C

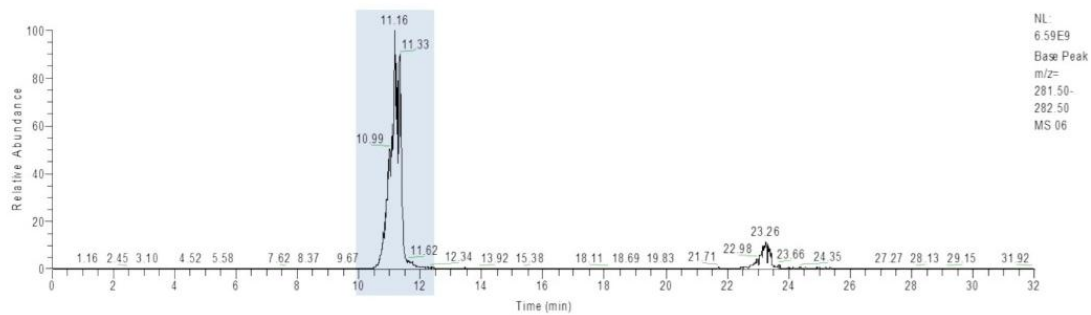

06 #2575 RT: 11.28 AV: 1 NL: 3.53E9
 T: FT MS + p APCI corona Full ms [150.0000-2000.0000]

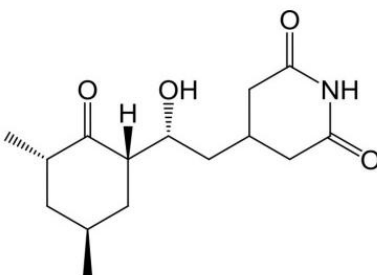
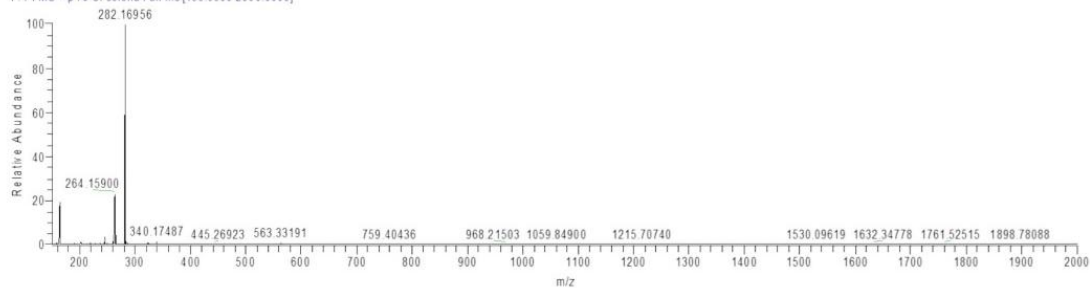

Cycloheximide

Chemical Formula: $C_{15}H_{23}NO_4$

Exact Mass: 281.16

Cycloheximide

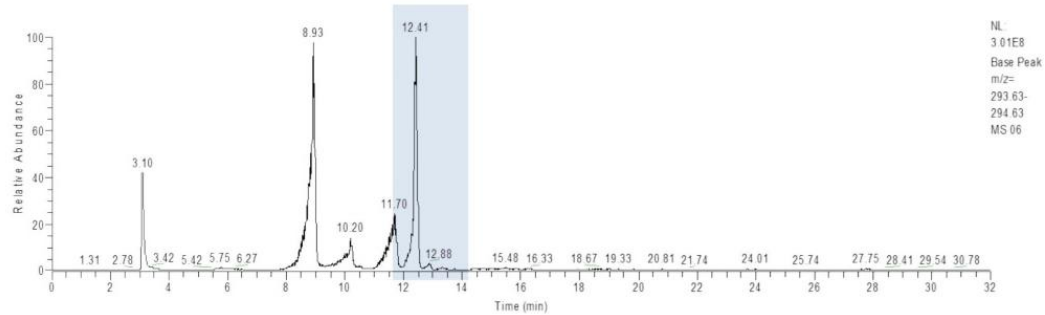

06 #2830 RT: 12.40 AV: 1 NL: 2.34E8
T: FTMS + p APCI corona Full ms [150.0000 2000.0000]

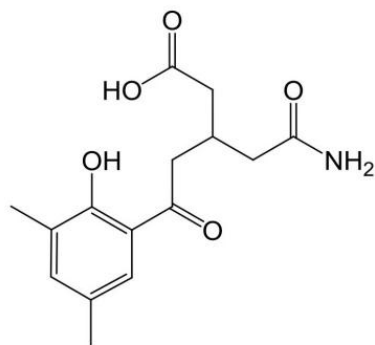
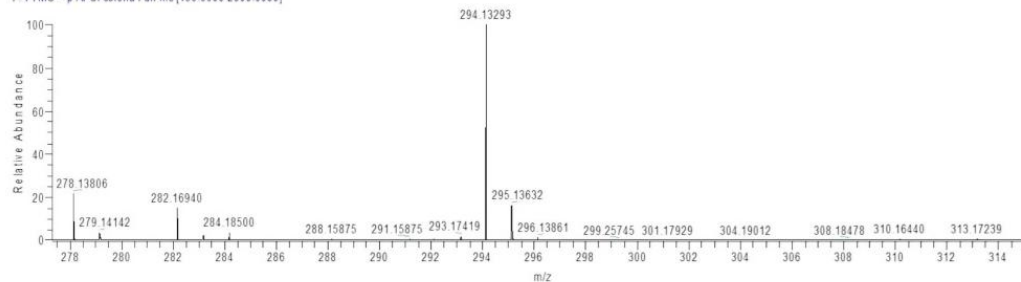

Phenetic acid

Chemical Formula: $C_{15}H_{19}NO_5$

Exact Mass: 293.13

Phenetic acid

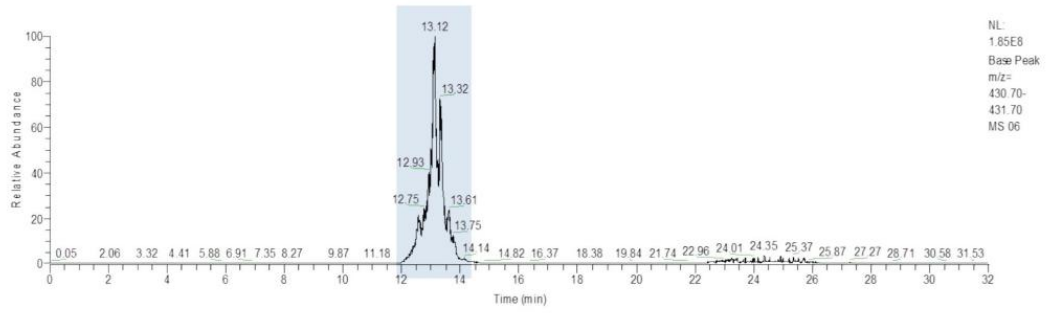

06 #2981 RT: 13.06 AV: 1 NL: 1.40E8
 T: FTMS + p APCI corona Full ms [150 0000-2000 0000]

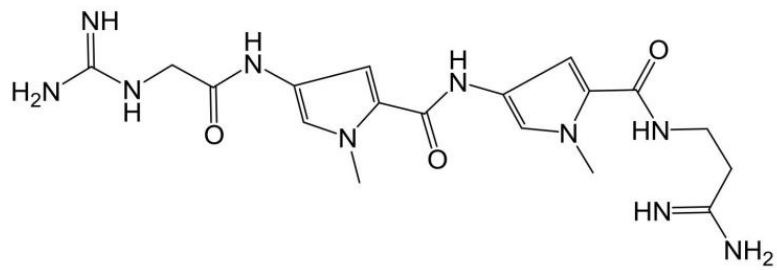
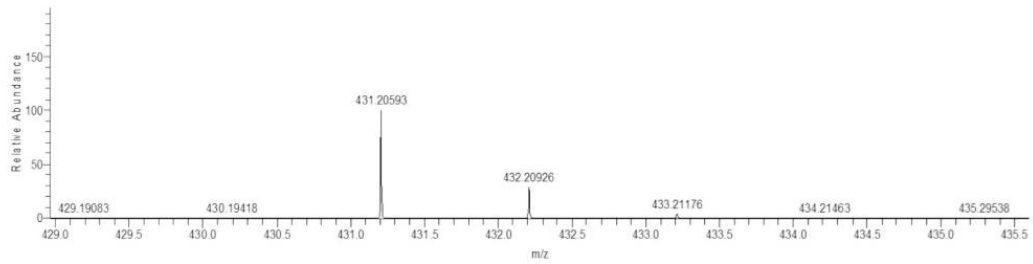

Netropsin

Chemical Formula: $C_{18}H_{26}N_{10}O_3$
 Exact Mass: 430.22

Netropsin

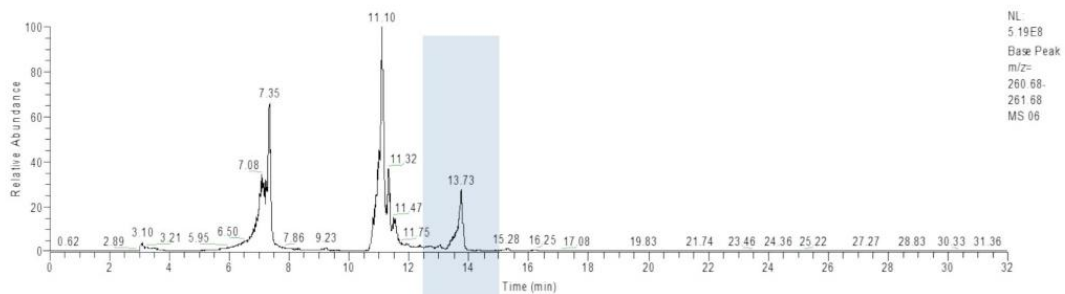

NL:
5.19E8
Base Peak
m/z:
260.68
261.68
MS 06

06 #3122 RT: 13.68 AV: 1 NL: 7.63E7
T: FTMS + p APCI corona Full ms [150.0000-2000.0000]

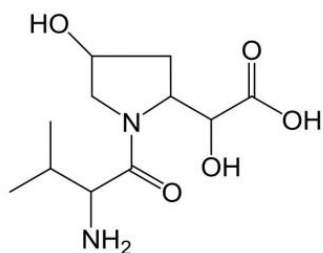
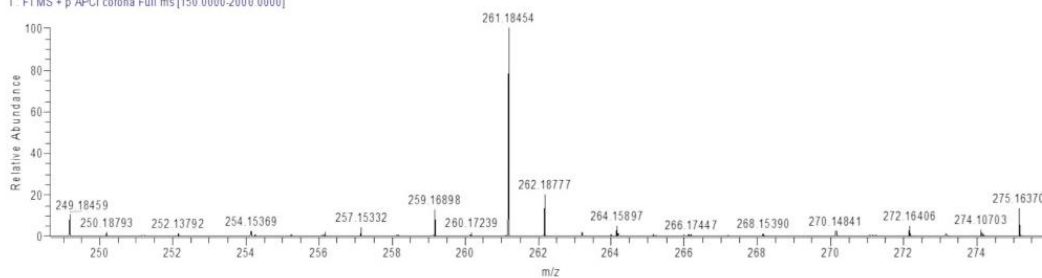

N-Valyldihydroxyhomoproline

Chemical Formula: $C_{11}H_{20}N_2O_5$

Exact Mass: 260.14

N-Valyldihydroxyhomoproline

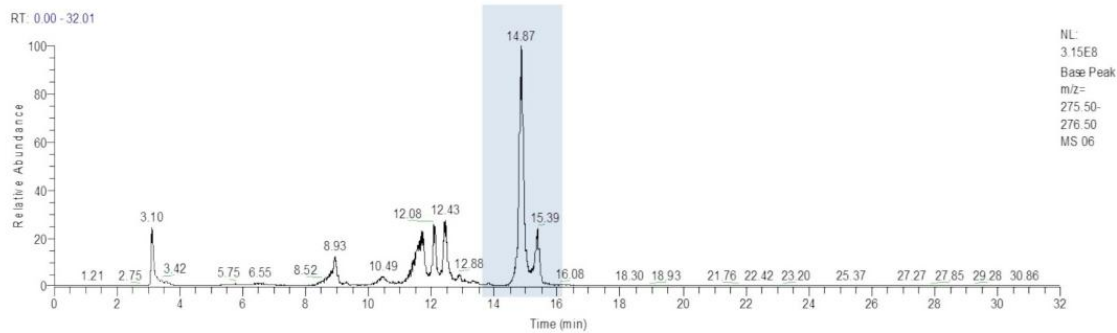

06 #3483 RT: 15.26 AV: 1 NL: 2.76E7
T: FT MS + p APCI corona Full ms [150 0000 2000 0000]

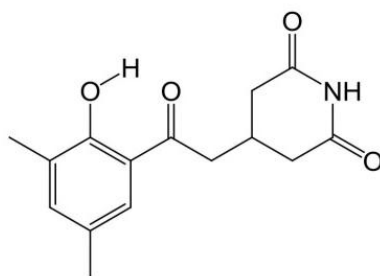
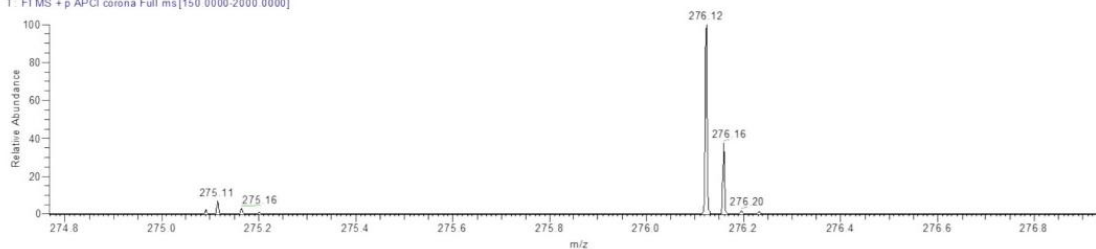

Actiphenol

Chemical Formula: $C_{15}H_{17}NO_4$

Exact Mass: 275.12

Actiphenol

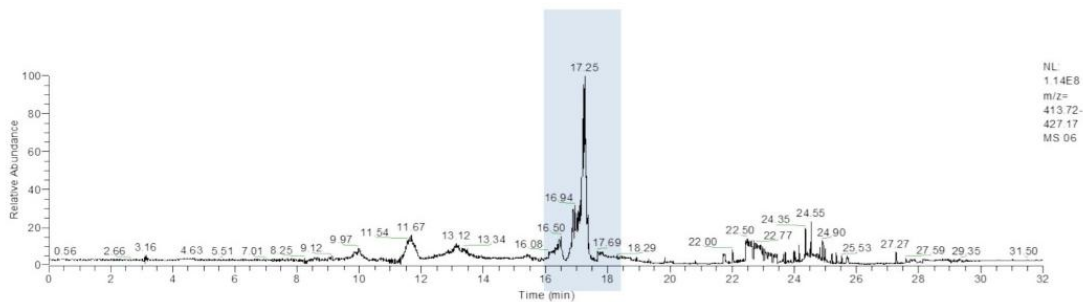

NL
1.14E8
m/z=
413.72-
427.17
MS 06

06 #3928 RT 17.21 AV 1 NL 7.57E7
T: FTMS + p APCI corona Full ms [150 0000-2000 0000]

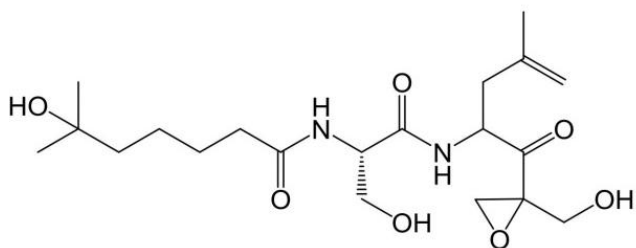
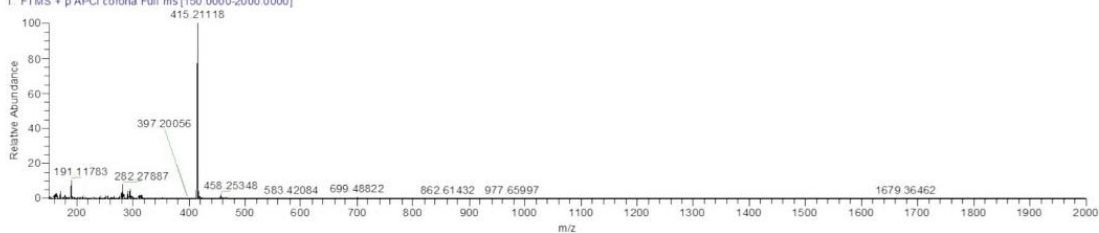

TMC-86B

Chemical Formula: $C_{20}H_{34}N_2O_7$

Exact Mass: 414.24

TMC-86B

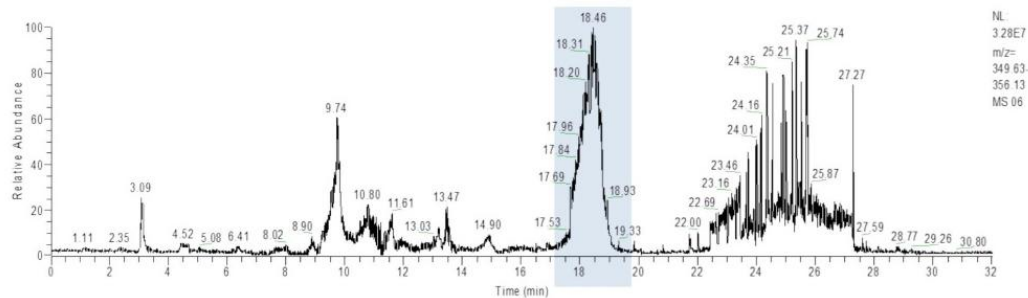

06 #4210 RT: 18.45 AV: 1 NL: 1.21E7
 T: FTMS + p APCI corona Full ms [150 0000.2000 0000]

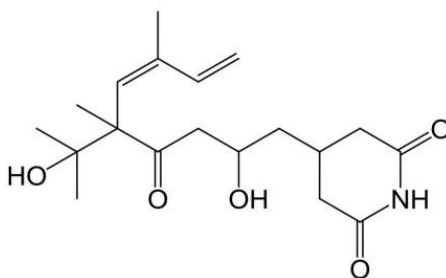
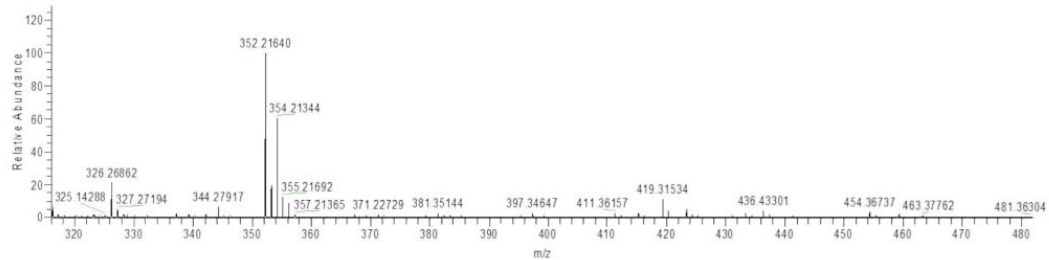

Protomycin

Chemical Formula: $C_{19}H_{29}NO_5$

Exact Mass: 351.20

Protomycin

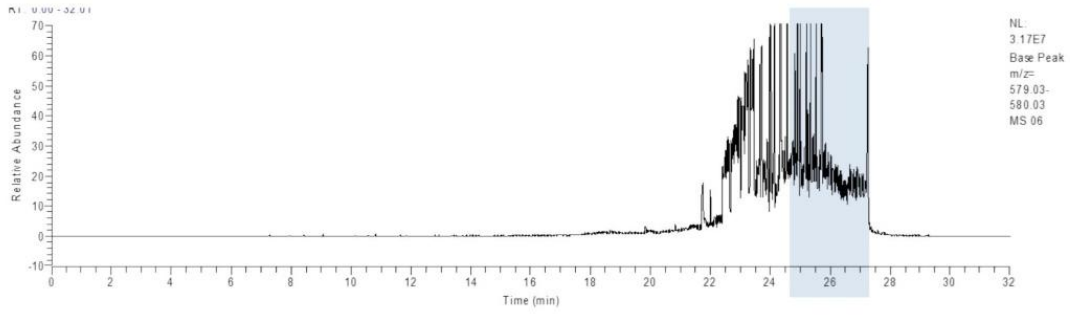

06 #6073 RT: 26.62 AV: 1 NL: 5.53E6
 T: FTMS + p APCI corona Full ms[150.0000:2000.0000]

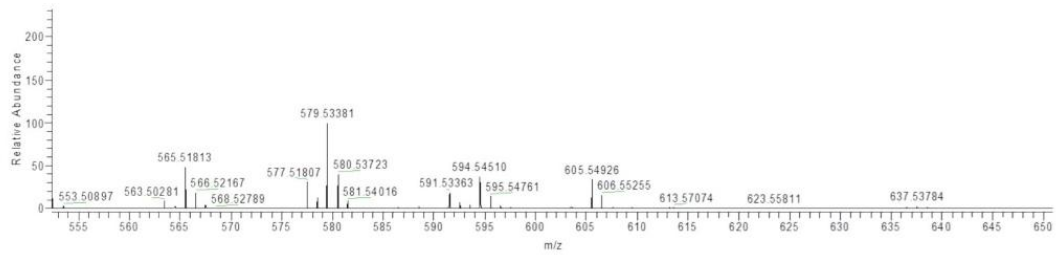

Unknown

Streptomyces griseus subsp. *griseus* DSM 40236^T

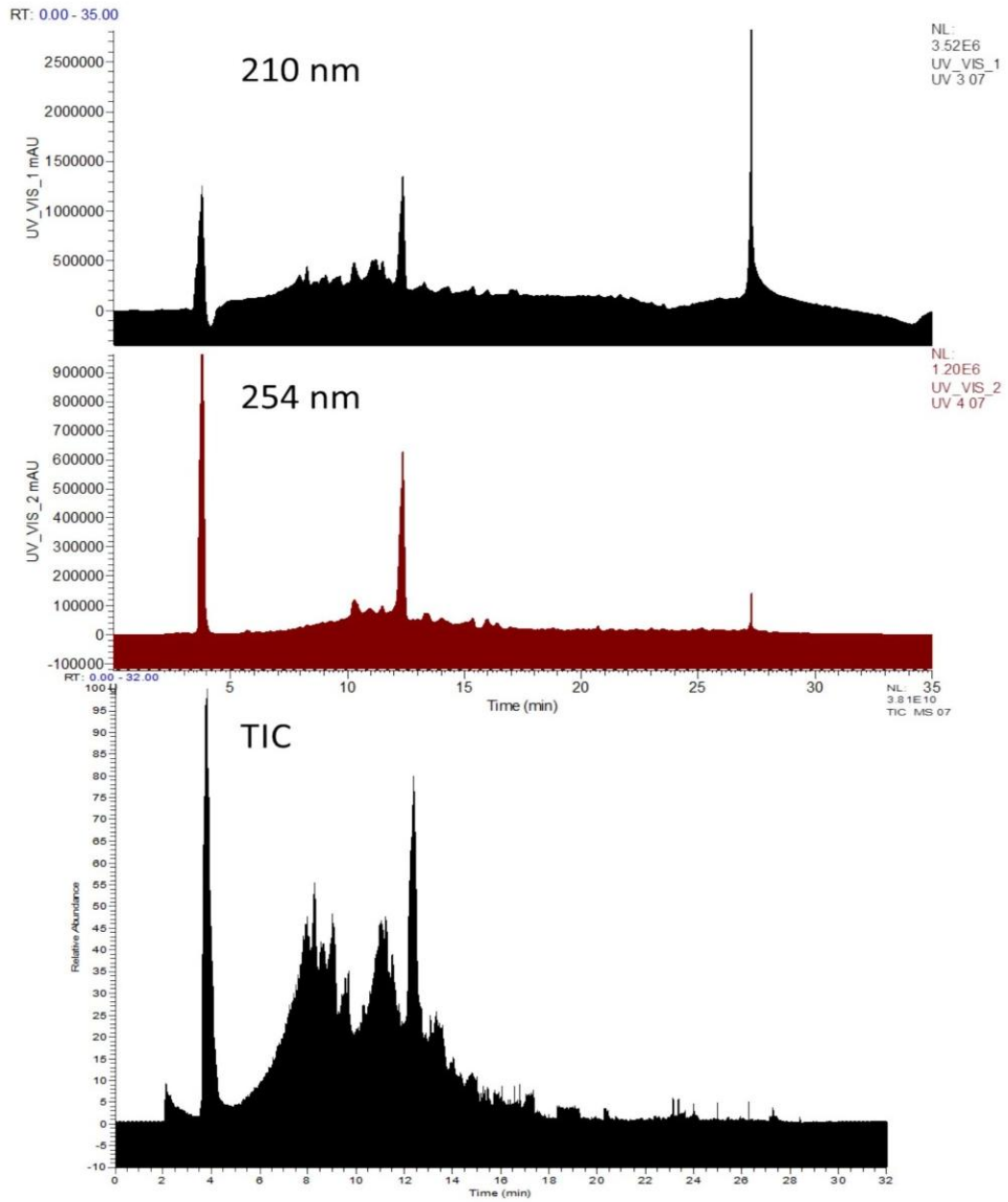

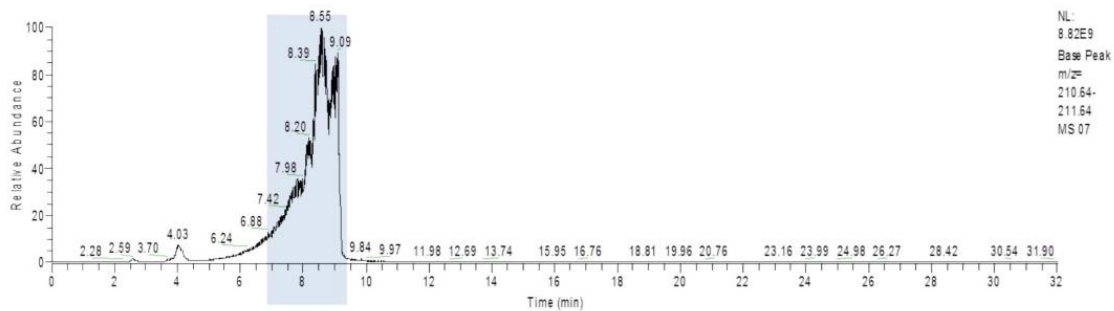

07#1927 RT: 8.44 AV: 1 NL: 6.31E9
 T: FTMS + p APCI corona Full ms[150.0000-2000.0000]

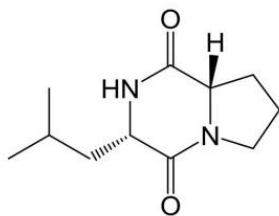
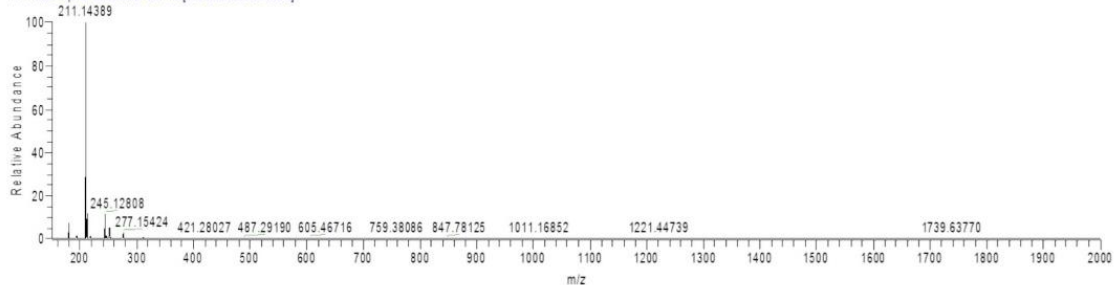

Gancidin W

Chemical Formula: C₁₁H₁₈N₂O₂

Exact Mass: 210.14

Gancidin W

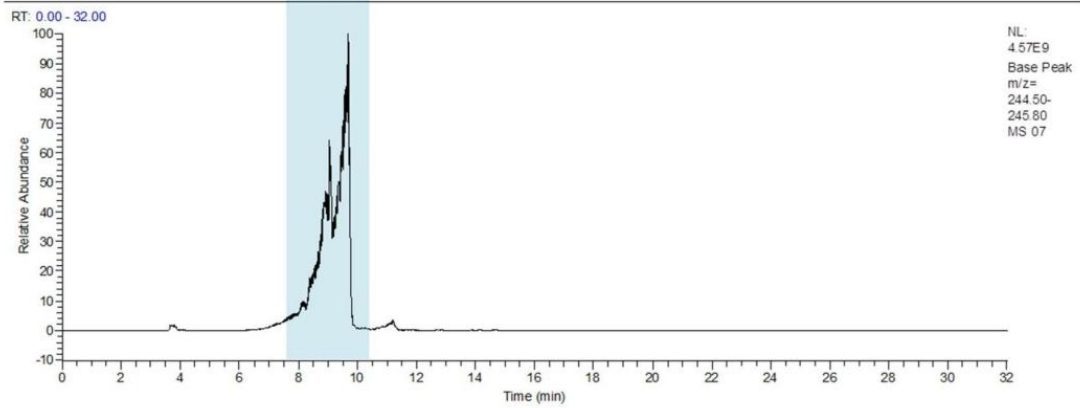

07 #2108 RT: 9.24 AV: 1 NL: 1.59E9
T: FTMS + p APCI corona Full ms [150.0000-2000.0000]

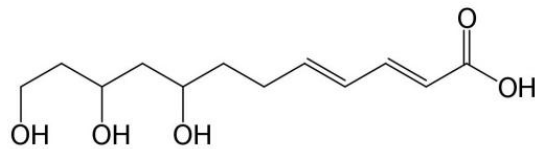
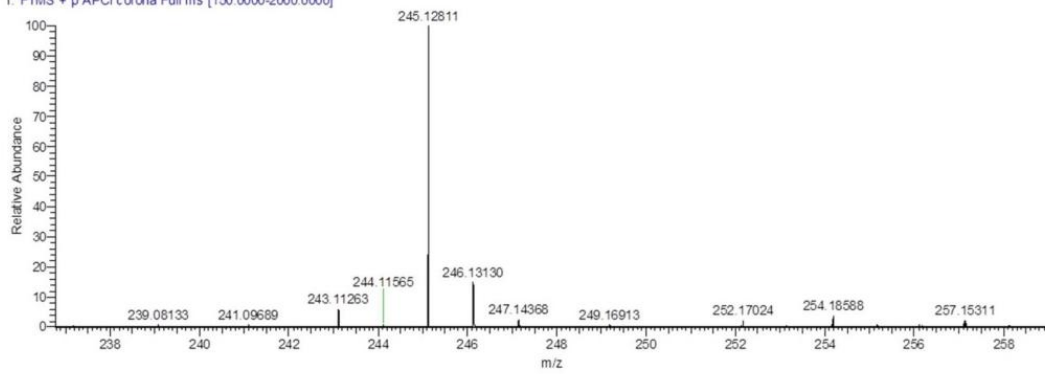

YF-0200-R-B

Exact Mass: 244.13
Molecular Weight: 244.29

YF-0200-R-B

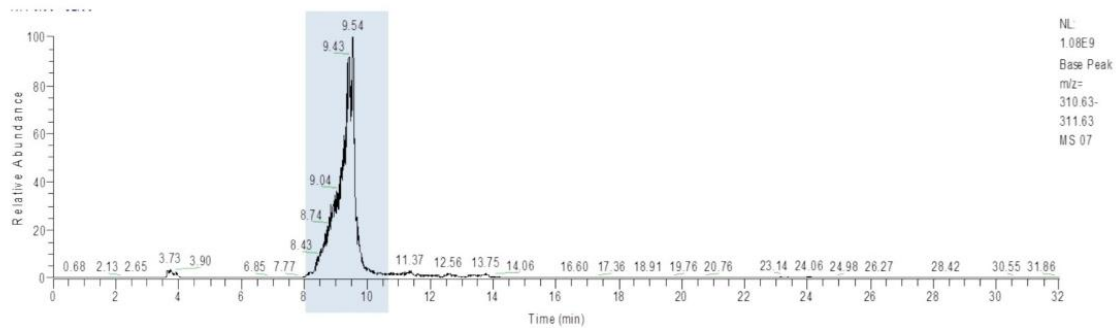

07 #2131 RT: 9.34 AV: 1 NL: 8.02E8
 T: FTMS + p APCI corona Full ms [150.0000-2000.0000]

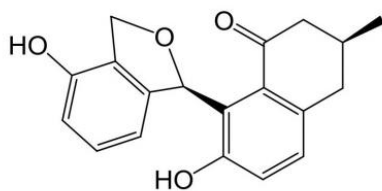
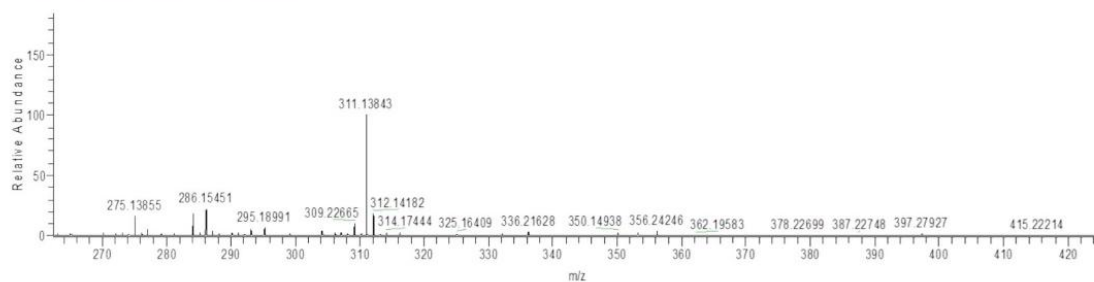

Emycin-E

Chemical Formula: $C_{19}H_{18}O_4$

Exact Mass: 310.12

Emycin E

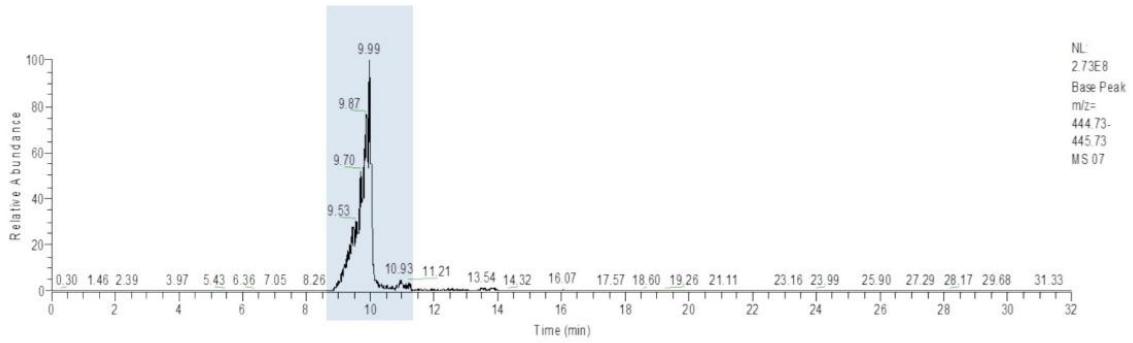

07 #2275 RT: 9.97 AV: 1 NL: 1.79E8
 T: FTMS + p APCI corona Full ms[150.0000-2000.0000]

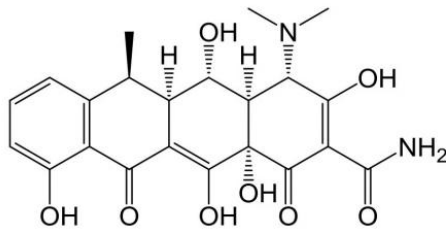
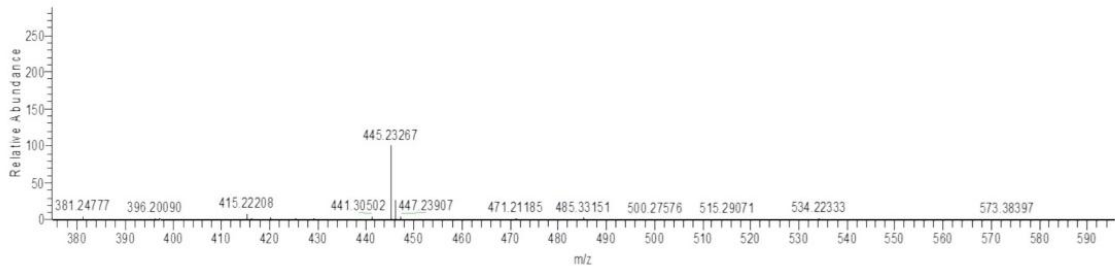

6-beta-deoxy-5-hydroxy-tetracycline

Chemical Formula: $C_{22}H_{24}N_2O_8$

Exact Mass: 444.15

6-beta-deoxy-5-hydroxy-tetracycline

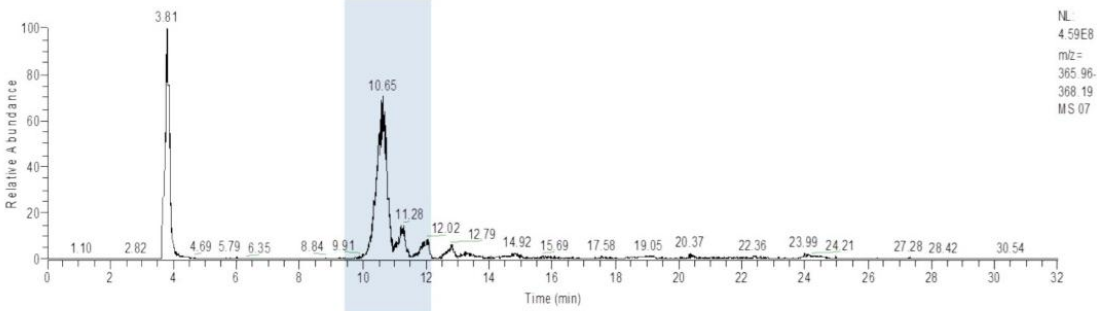

07 #2416 RT: 10.58 AV: 1 NL: 2.73E8
 T: FTMS + p APCI corona Full ms [150.0000-2000.0000]

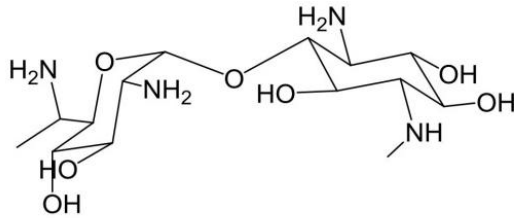
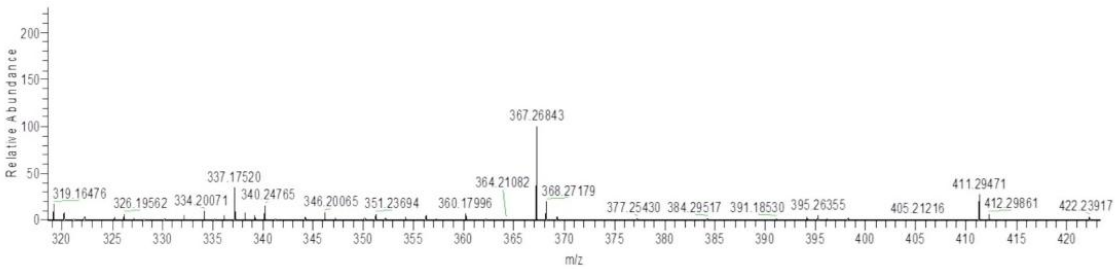

Fortimicin-KK1

Chemical Formula: $C_{14}H_{30}N_4O_7$

Exact Mass: 366.21

Fortimicin KK1

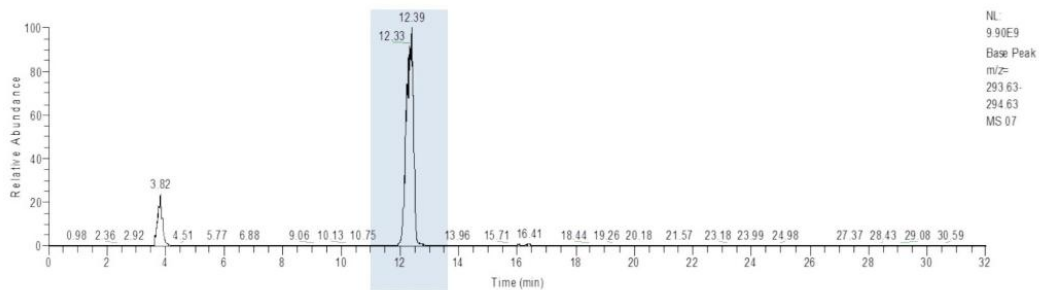

07 #2805 RT: 12.29 AV: 1 NL: 8.07E9
 T: FTMS + p APCI corona Full ms [150 0000-2000 0000]

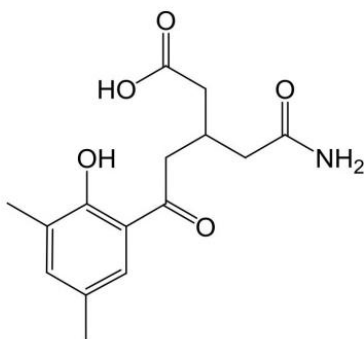
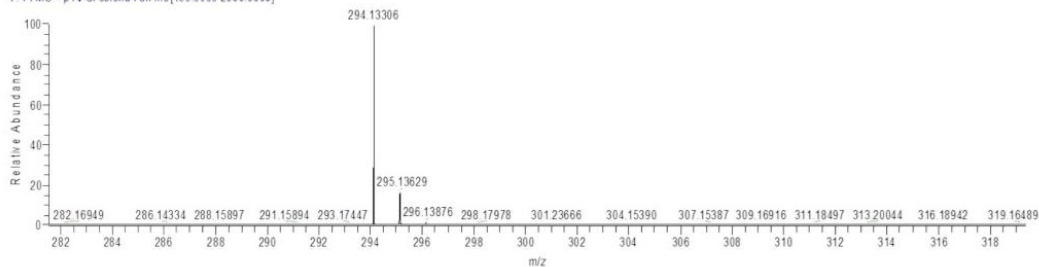

Phenatic acid

Chemical Formula: $C_{15}H_{19}NO_5$

Exact Mass: 293.13

Phenatic acid

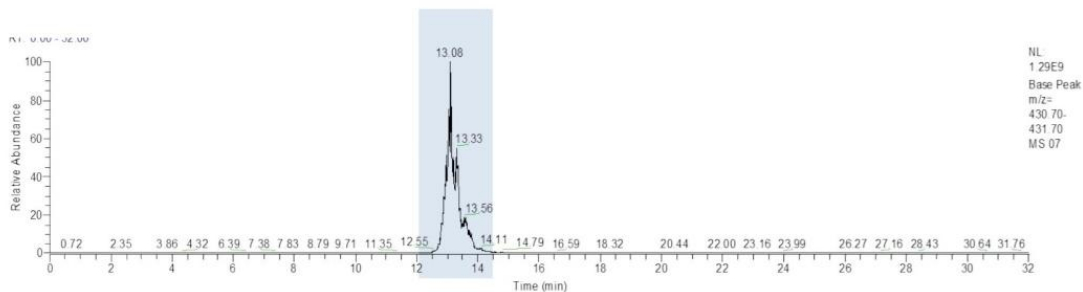

NL
1.29E9
Base Peak
m/z=
430.70
431.70
MS 07

07 #2998 RT: 13.13 AV: 1 NL: 9.14E8
T: FTMS + p APCI corona Full ms [150.0000-2000.0000]

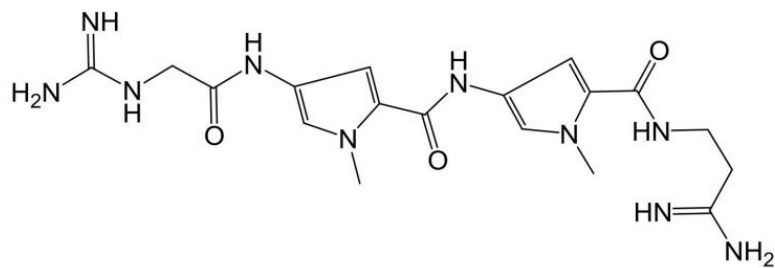
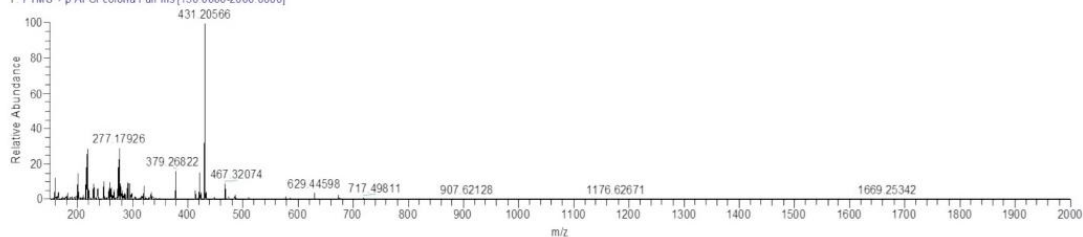

Netropsin

Chemical Formula: $C_{18}H_{26}N_{10}O_3$

Exact Mass: 430.22

Netropsin

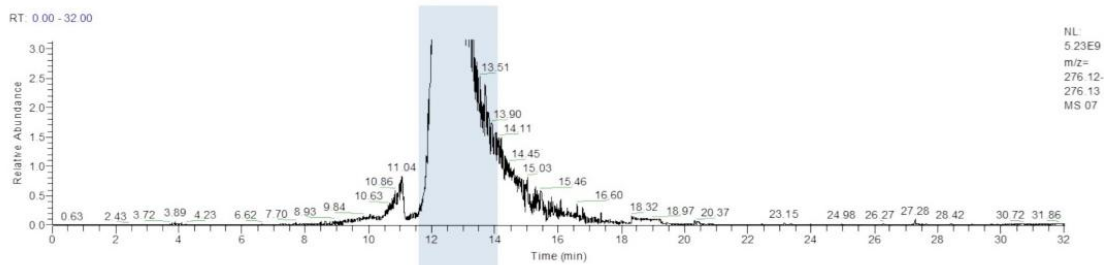

07 #3496 RT: 15.31 AV: 1 NL: 2.56E7
T: FTMS + p APCI corona Full ms [150.0000-2000.0000]

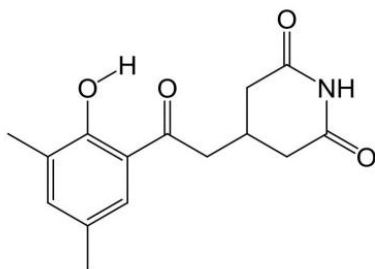
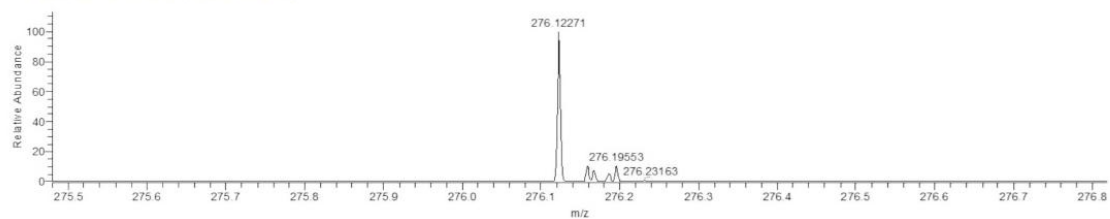

Actiphenol

Chemical Formula: $C_{15}H_{17}NO_4$

Exact Mass: 275.12

Actiphenol

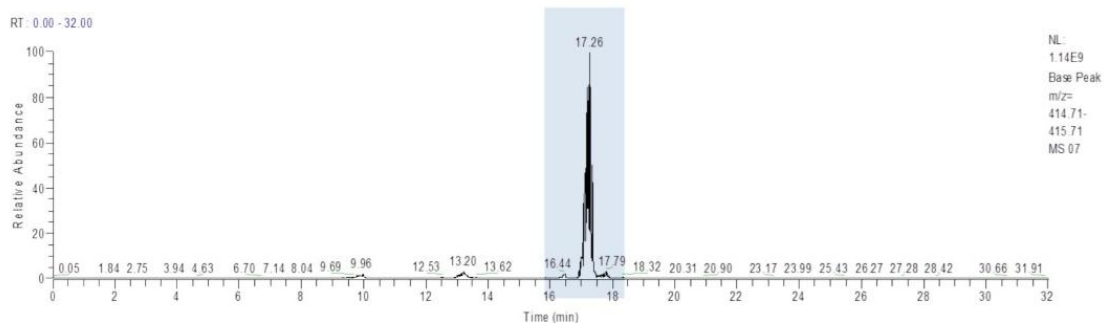

07 #3917 RT: 17.16 AV: 1 NL: 5.80E8
T: FTMS + p APCI corona Full ms [150.0000-2000.0000]

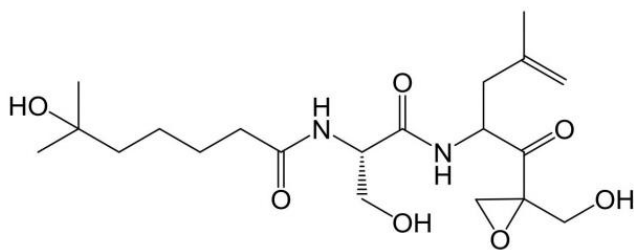
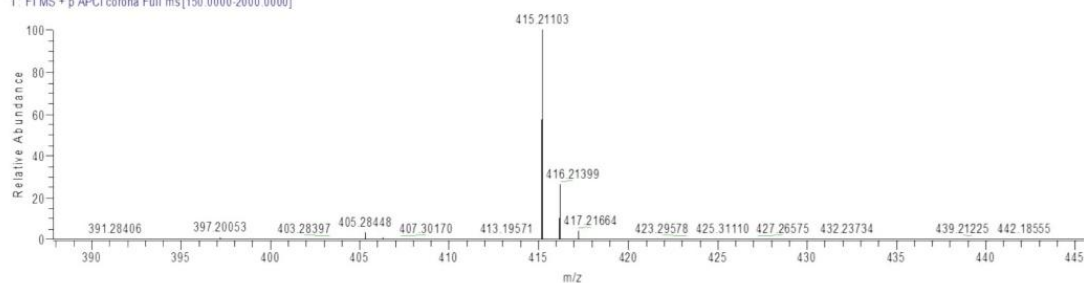

TMC-86B

Chemical Formula: $C_{20}H_{34}N_2O_7$

Exact Mass: 414.24

TMC-86B

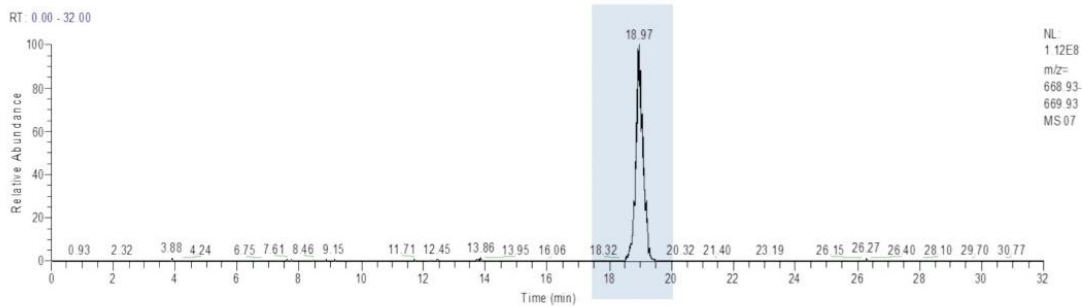

07#4324 RT: 18.94 AV: 1 NL: 9.44E7
T: FTMS + p APCI corona Full ms [150.0000.2000.0000]

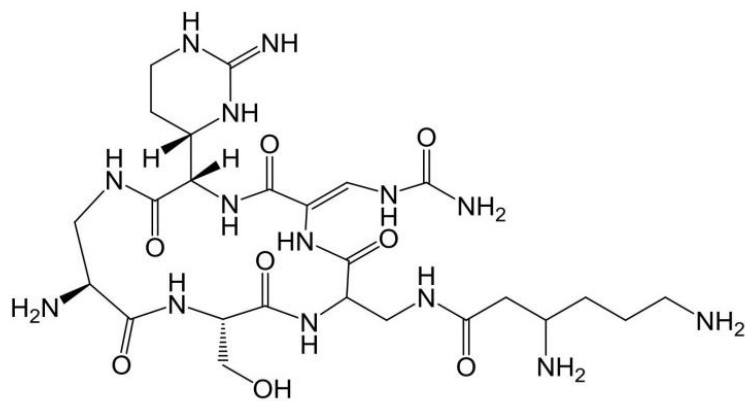
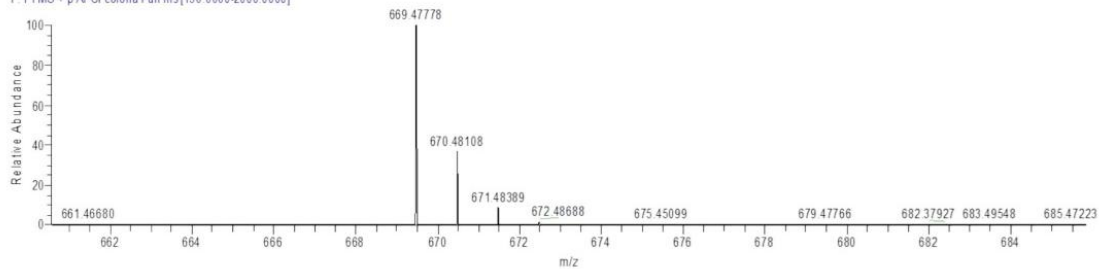

Capromycin

Chemical Formula: $C_{25}H_{44}N_{14}O_8$

Exact Mass: 668.35

Capromycin

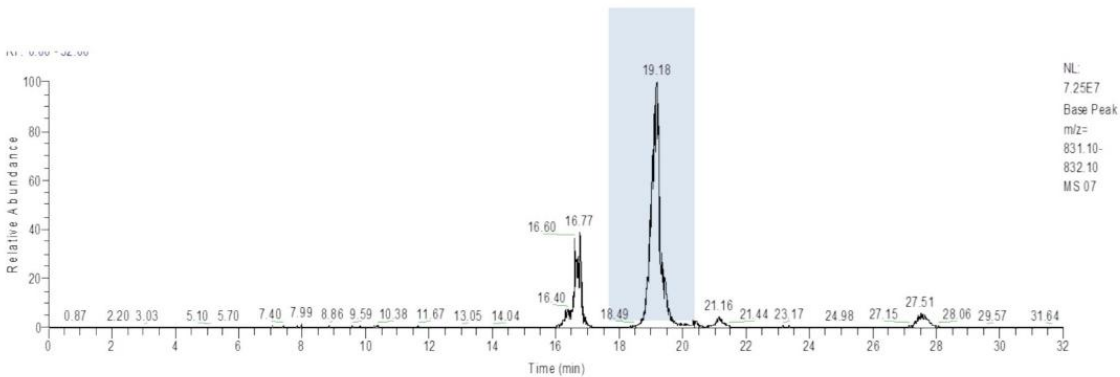

07 #4358 RT: 19.09 AV: 1 NL: 4.18E7
 T: FTMS + p APCI corona Full ms [150.0000-2000.0000]

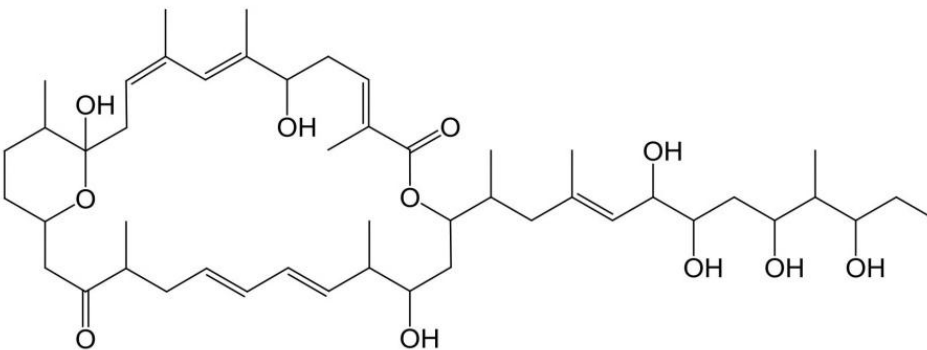
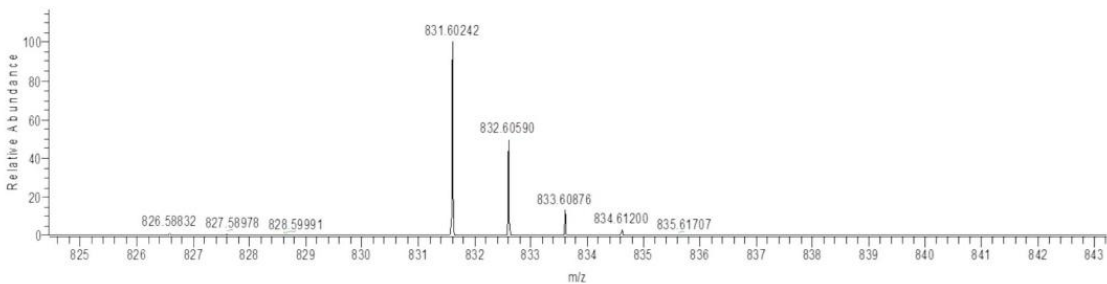

Halstoctacosanolide B

Chemical Formula: $C_{48}H_{78}O_{11}$
 Exact Mass: 830.55

Halstoctacosanolide B

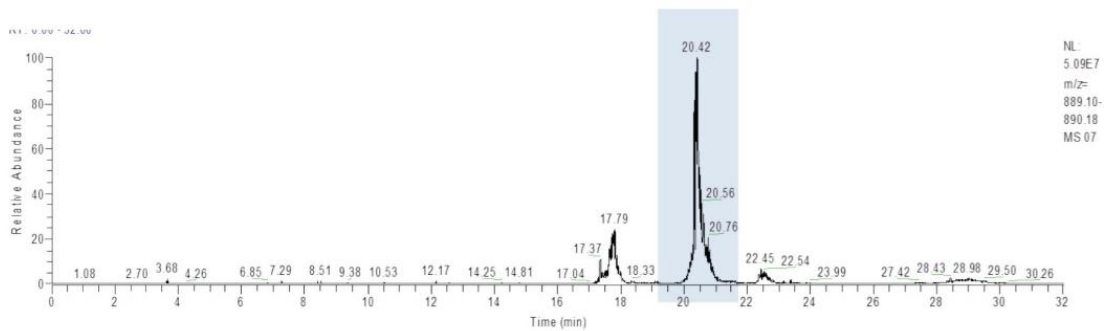

07 #4632 RT 20.29 AV 1 NL 6.69E6
 T: FTMS + p APCI corona Full ms [150.0000-2000.0000]

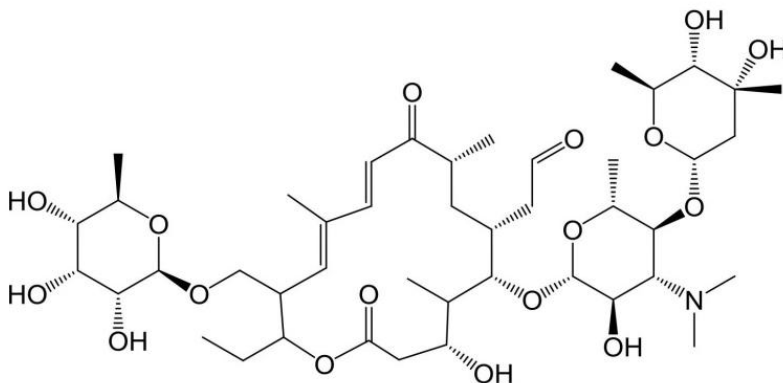
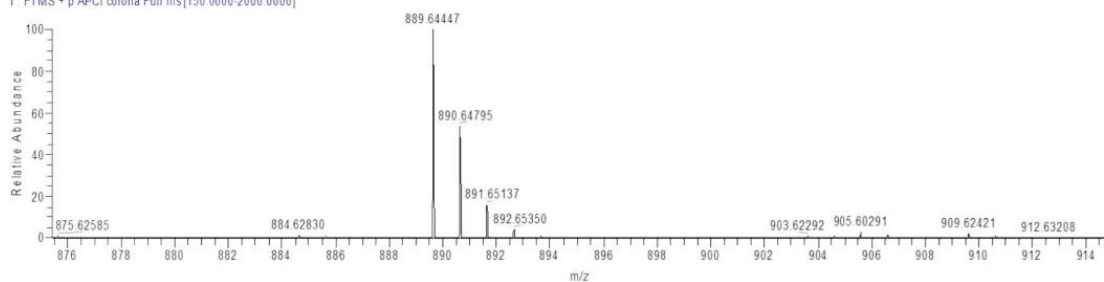

YO - 7625

Chemical Formula: $C_{44}H_{73}NO_{17}$

Exact Mass: 887.49

YO-7625

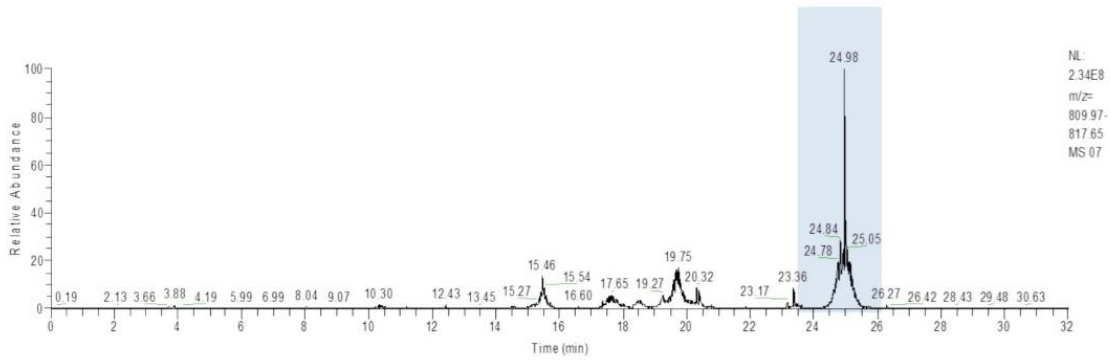

NL:
2.34E8
m/z=
809.97-
817.65
MS 07

07#5742 RT: 25.16 AV: 1 NL: 1.20E7
T: FTMS + p APCI corona Full ms[150.0000-2000.0000]

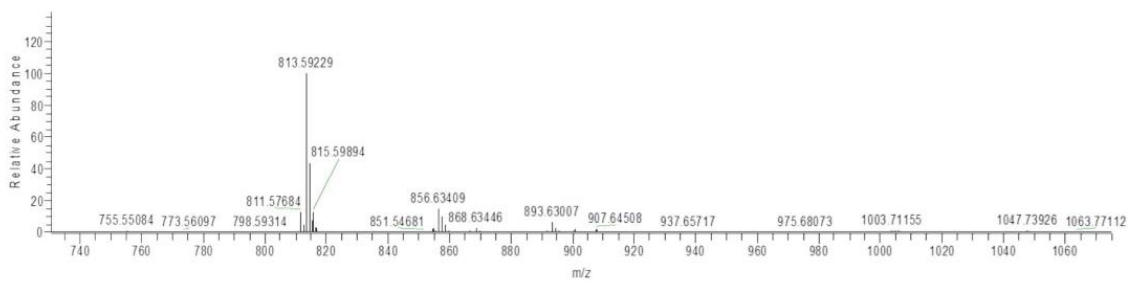

Unknown

Streptomyces griseus 16S rRNA comparison

3_1525: *Streptomyces* sp. SN25_8.1 from Easter Island marine sediment.

4_1525: *Streptomyces griseus* subsp. *griseus* DSM 40236^T from a Russian garden soil.

BLAST Results

[Questions/comments](#)

Job title: 3_1525

RID [TYT6T7XZ01R](#) (Expires on 09-18 16:24 pm)

Query ID |cl|Query_122625
Description 3_1525
Molecule type nucleic acid
Query Length 1477

Database Name nr
Description Nucleotide collection (nt)
Program BLASTN 2.8.0+

Graphic Summary

Distribution of the top 190 Blast Hits on 100 subject sequences



Descriptions

Sequences producing significant alignments:

Description	Max score	Total score	Query cover	E value	Ident	Accession
<i>Streptomyces griseus</i> subsp. <i>griseus</i> NBRC 13350 DNA, complete genome	2721	16327	99%	0.0	99%	AP009493.1
<i>Streptomyces pratensis</i> ATCC 33331, complete genome	2715	16238	99%	0.0	99%	CP002475.1
<i>Streptomyces globisporus</i> strain TFH56 chromosome, complete genome	2710	16238	99%	0.0	99%	CP029361.1
<i>Streptomyces fulvissimus</i> strain DSM 40593 16S ribosomal RNA, partial sequence	2710	2710	99%	0.0	99%	NR_103947.1
<i>Streptomyces fulvissimus</i> DSM 40593, complete genome	2710	16260	99%	0.0	99%	CP005080.1
<i>Streptomyces</i> sp. PAMC26508, complete genome	2710	16257	99%	0.0	99%	CP003990.1
<i>Streptomyces pratensis</i> strain ch24 16S ribosomal RNA, partial sequence	2706	2706	99%	0.0	99%	NR_125621.1
<i>Streptomyces globisporus</i> C-1027, complete genome	2704	16227	99%	0.0	99%	CP013738.1
<i>Streptomyces luridiscabiei</i> strain S63 16S ribosomal RNA, partial sequence	2704	2704	99%	0.0	99%	NR_025155.1
<i>Streptomyces flavolimosus</i> strain CGMCC 2027 16S ribosomal RNA gene, partial sequence	2702	2702	99%	0.0	99%	EF688620.1
<i>Streptomyces praecox</i> strain CGMCC 4.1782 clone 3 16S ribosomal RNA gene, complete sequence	2700	2700	99%	0.0	99%	JQ924404.1
<i>Streptomyces pratensis</i> strain ch24 16S ribosomal RNA, partial sequence	2700	2700	99%	0.0	99%	NR_125619.1
<i>Streptomyces</i> sp. SM18 chromosome, complete genome	2699	16183	99%	0.0	99%	CP029342.1
<i>Streptomyces flavofuscus</i> strain CGMCC 4.1938 clone 3 16S ribosomal RNA gene, complete sequence	2699	2699	99%	0.0	99%	JQ924409.1
<i>Streptomyces griseus</i> strain NRRL B-8030 16S ribosomal RNA gene, partial sequence	2699	2699	99%	0.0	99%	DQ026671.1
<i>Streptomyces</i> sp. Tue6075, complete genome	2695	16157	99%	0.0	99%	CP010833.1
<i>Streptomyces praecox</i> strain CGMCC 4.1782 clone 2 16S ribosomal RNA gene, complete sequence	2695	2695	99%	0.0	99%	JQ924403.1
<i>Streptomyces pratensis</i> strain ch24 16S ribosomal RNA, partial sequence	2695	2695	99%	0.0	99%	NR_125618.1
<i>Streptomyces violaceoruber</i> strain S21, complete genome	2693	16161	99%	0.0	99%	CP020570.1
<i>Streptomyces flavofuscus</i> strain CGMCC 4.1938 clone 2 16S ribosomal RNA gene, complete sequence	2693	2693	99%	0.0	99%	JQ924408.1
<i>Streptomyces flavofuscus</i> strain CGMCC 4.1938 clone 1 16S ribosomal RNA gene, complete sequence	2693	2693	99%	0.0	99%	JQ924407.1
<i>Streptomyces</i> sp. SirexAA-E, complete genome	2693	16133	99%	0.0	99%	CP002993.1
<i>Streptomyces flavofuscus</i> strain NRRL B-2594 16S ribosomal RNA gene, partial sequence	2693	2693	100%	0.0	99%	EF178690.1

Description	Max score	Total score	Query cover	E value	Ident	Accession
Streptomyces microflavus strain NRRL B-2156 16S ribosomal RNA gene, partial sequence	2691	2691	99%	0.0	99%	DQ445795.1
Streptomyces praecox strain CGMCC 4.1782 clone 5 16S ribosomal RNA gene, complete sequence	2689	2689	99%	0.0	99%	JQ924406.1
Streptomyces praecox strain CGMCC 4.1782 clone 4 16S ribosomal RNA gene, complete sequence	2689	2689	99%	0.0	99%	JQ924405.1
Streptomyces praecox strain CGMCC 4.1782 clone 1 16S ribosomal RNA gene, complete sequence	2689	2689	99%	0.0	99%	JQ924402.1
Streptomyces pratensis strain ch24 16S ribosomal RNA, partial sequence	2689	2689	99%	0.0	99%	NR_125620.1
Streptomyces anulatus strain NRRL B-2000 16S ribosomal RNA gene, partial sequence	2689	2689	99%	0.0	99%	DQ026637.1
Streptomyces baarnensis strain NRRL B-1902 16S ribosomal RNA gene, partial sequence	2687	2687	100%	0.0	99%	EF178688.1
Streptomyces flavogriseus partial 16S rRNA gene, type strain CBS 101.34T	2687	2687	99%	0.0	99%	AJ494864.1
Streptomyces sp. CFMR 7 strain CFMR-7, complete genome	2682	15924	99%	0.0	99%	CP011522.1
Streptomyces flavovirens strain CGMCC 4.575 clone 1 16S ribosomal RNA gene, complete sequence	2682	2682	99%	0.0	99%	JQ924386.1
Streptomyces griseus subsp. griseus gene for 16S rRNA, partial sequence, strain: NBRC 15744	2680	2680	98%	0.0	99%	AB184699.1
Streptomyces argenteolus strain JCM 4623 16S ribosomal RNA, partial sequence	2680	2680	99%	0.0	99%	NR_112120.1
Streptomyces flavovirens strain CGMCC 4.575 clone 2 16S ribosomal RNA gene, complete sequence	2678	2678	99%	0.0	99%	JQ924387.1
Streptomyces sp. YMS-799 gene for 16S rRNA, partial sequence	2678	2678	98%	0.0	99%	AB534176.1
Streptomyces flavovirens strain CGMCC 4.575 clone 5 16S ribosomal RNA gene, complete sequence	2676	2676	99%	0.0	99%	JQ924389.1
Streptomyces flavovirens strain CGMCC 4.575 clone 4 16S ribosomal RNA gene, complete sequence	2676	2676	99%	0.0	99%	JQ924388.1
Streptomyces microflavus strain NRRL B-1332 16S ribosomal RNA gene, partial sequence	2675	2675	98%	0.0	99%	EF178673.1
Streptomyces paretii 16S rRNA gene, type strain LMG 23704T	2675	2675	98%	0.0	99%	AJ969177.1
Streptomyces anulatus gene for 16S rRNA, partial sequence, strain: NBRC 13369	2673	2673	98%	0.0	99%	AB184875.1
Streptomyces cavourensis subsp. washingtonensis gene for 16S rRNA, partial sequence, strain: NBRC 15391	2673	2673	98%	0.0	99%	AB184642.1
Streptomyces acidoresistans gene for 16S rRNA, partial sequence, strain: NBRC 13442	2673	2673	98%	0.0	99%	AB184406.1
Streptomyces praecox gene for 16S rRNA, partial sequence, strain: NBRC 13073	2673	2673	98%	0.0	99%	AB184293.1
Streptomyces albiviridis gene for 16S rRNA, partial sequence, strain: NBRC	2673	2673	98%	0.0	99%	AB184256.1

Description	Max score	Total score	Query cover	E value	Ident	Accession
Streptomyces argenteolus gene for 16S rRNA, partial sequence, strain: NBRC 12841	2673	2673	98%	0.0	99%	AB184187.1
Streptomyces finlayi strain CGMCC 4.1436 clone 1 16S ribosomal RNA gene, complete sequence	2669	2669	99%	0.0	99%	JQ924390.1
Streptomyces rubiginosohelvolus gene for 16S rRNA, partial sequence, strain: NBRC 12912	2669	2669	98%	0.0	99%	AB184240.2
Streptomyces microflavus gene for 16S rRNA, partial sequence, strain: NBRC 13062	2669	2669	98%	0.0	99%	AB184284.1
Streptomyces fulvorobeus gene for 16S rRNA, partial sequence, strain: NBRC 15897	2667	2667	98%	0.0	99%	AB184711.1
Streptomyces griseus subsp. griseus gene for 16S rRNA, partial sequence, strain: NBRC 12875	2667	2667	97%	0.0	99%	AB184211.1
Streptomyces griseinus gene for 16S rRNA, partial sequence, strain: NBRC 12869	2667	2667	98%	0.0	99%	AB184205.1
Streptomyces sp. S8, complete genome	2665	15950	99%	0.0	99%	CP015362.1
Streptomyces flavofuscus gene for 16S rRNA, partial sequence, strain: NBRC 100768	2665	2665	98%	0.0	99%	AB249935.1
Streptomyces clavifer strain NRRL B-2557 16S ribosomal RNA gene, partial sequence	2663	2663	99%	0.0	99%	DQ026670.1
Streptomyces albovinaceus gene for 16S rRNA, partial sequence, strain: NBRC 12739	2663	2663	98%	0.0	99%	AB249958.1
Streptomyces erumpens gene for 16S rRNA, partial sequence, strain: NBRC 15403	2663	2663	97%	0.0	99%	AB184654.1
Streptomyces baarnensis gene for 16S rRNA, partial sequence, strain: NBRC 14727	2663	2663	98%	0.0	99%	AB184615.1
Streptomyces fimicarius gene for 16S rRNA, partial sequence, strain: NBRC 13037	2663	2663	98%	0.0	99%	AB184269.1
Streptomyces globisporus subsp. globisporus gene for 16S rRNA, partial sequence, strain: NBRC 12867	2663	2663	98%	0.0	99%	AB184203.1
Streptomyces cavourensis strain TJ430 chromosome, complete genome	2662	15856	99%	0.0	99%	CP030930.1
Streptomyces bacillaris strain ATCC 15855 chromosome, complete genome	2662	15972	99%	0.0	99%	CP029378.1
Streptomyces cavourensis strain 1AS2a chromosome, complete genome	2662	15928	99%	0.0	99%	CP024957.1
Streptomyces globisporus subsp. globisporus strain NRRL B-2872 16S ribosomal RNA gene, partial sequence	2662	2662	98%	0.0	99%	EF178686.1
Streptomyces griseolus gene for 16S rRNA, partial sequence, strain: NBRC 3415	2662	2662	98%	0.0	99%	AB184768.1
Streptomyces puniceus gene for 16S rRNA, partial sequence, strain: NBRC 12811	2662	2662	98%	0.0	99%	AB184163.1
Streptomyces halstedii gene for 16S rRNA, partial sequence, strain: NBRC 12783	2662	2662	98%	0.0	99%	AB184142.1

Description	Max score	Total score	Query cover	E value	Ident	Accession
Streptomyces atratus strain SCSIO_ZH16 chromosome, complete genome	2660	15961	99%	0.0	99%	CP027306.1
Streptomyces flavovirens strain NRRL B-2685 16S ribosomal RNA gene, partial sequence	2660	2660	99%	0.0	99%	DQ026635.1
Streptomyces pluricolaroscens gene for 16S rRNA, partial sequence, strain: NBRC 12808	2660	2660	98%	0.0	99%	AB184162.1
Streptomyces olivoviridis strain CGMCC 4.1739 clone 2 16S ribosomal RNA gene, complete sequence	2658	2658	99%	0.0	99%	JQ924394.1
Streptomyces finlayi strain CGMCC 4.1436 clone 2 16S ribosomal RNA gene, complete sequence	2658	2658	99%	0.0	99%	JQ924391.1
Streptomyces californicus gene for 16S rRNA, partial sequence, strain: NBRC 12750	2658	2658	98%	0.0	99%	AB184116.2
Streptomyces cinereorectus gene for 16S rRNA, partial sequence, strain: NBRC 15395	2658	2658	98%	0.0	99%	AB184646.1
Streptomyces mutomycini strain CGMCC 4.1747 clone 3 16S ribosomal RNA gene, complete sequence	2656	2656	99%	0.0	99%	JQ924399.1
Streptomyces halstedii strain NRRL B-1238 16S ribosomal RNA gene, partial sequence	2656	2656	98%	0.0	99%	EF178695.1
Streptomyces parvus gene for 16S rRNA, partial sequence, strain: NBRC 3388	2656	2656	98%	0.0	99%	AB184756.1
Streptomyces californicus gene for 16S rRNA, partial sequence, strain: NBRC 3386	2656	2656	98%	0.0	99%	AB184755.1
Streptomyces badius gene for 16S rRNA, partial sequence, strain: NBRC 12745	2656	2656	98%	0.0	99%	AB184114.1
Streptomyces lunaelactis strain MM109 chromosome, complete genome	2654	15660	99%	0.0	99%	CP026304.1
Streptomyces nitrosporeus strain CGMCC 4.1973 clone 4 16S ribosomal RNA gene, complete sequence	2654	2654	99%	0.0	99%	JQ924413.1
Streptomyces anulatus strain NRRL B-2873 16S ribosomal RNA gene, partial sequence	2654	2654	97%	0.0	99%	DQ026639.1
Streptomyces sindenensis gene for 16S rRNA, partial sequence, strain: NBRC 3399	2654	2654	98%	0.0	99%	AB184759.1
Streptomyces mediolani gene for 16S rRNA, partial sequence, strain: NBRC 15427	2654	2654	98%	0.0	99%	AB184674.1
Streptomyces olivoviridis strain CGMCC 4.1739 clone 5 16S ribosomal RNA gene, complete sequence	2652	2652	99%	0.0	99%	JQ924396.1
Streptomyces olivoviridis strain CGMCC 4.1739 clone 4 16S ribosomal RNA gene, complete sequence	2652	2652	99%	0.0	99%	JQ924395.1
Kitasatospora albologia strain YIM 101047, complete genome	2651	15858	99%	0.0	99%	CP020563.1
Streptomyces mutomycini strain CGMCC 4.1747 clone 1 16S ribosomal RNA gene, complete sequence	2651	2651	99%	0.0	99%	JQ924397.1

Description	Max score	Total score	Query cover	E value	Ident	Accession
Streptomyces flavovirens gene for 16S rRNA, partial sequence, strain: NBRC 3197	2651	2651	98%	0.0	99%	AB184827.1
Streptomyces ornatus gene for 16S rRNA, partial sequence, strain: NBRC 13069	2651	2651	97%	0.0	99%	AB184290.1
Streptomyces flavogriseus gene for 16S rRNA, partial sequence, strain: NBRC 13040	2651	2651	98%	0.0	99%	AB184271.1
Streptomyces flavovirens gene for 16S rRNA, partial sequence, strain: NBRC 12771	2651	2651	98%	0.0	99%	AB184133.1
Streptomyces nitrosporeus strain CGMCC 4.1973 clone 3 16S ribosomal RNA gene, complete sequence	2649	2649	99%	0.0	99%	JQ924412.1
Streptomyces nitrosporeus strain CGMCC 4.1973 clone 1 16S ribosomal RNA gene, complete sequence	2649	2649	99%	0.0	99%	JQ924411.1
Streptomyces olivoviridis strain CGMCC 4.1739 clone 1 16S ribosomal RNA gene, complete sequence	2647	2647	99%	0.0	99%	JQ924393.1
Streptomyces naraensis gene for 16S rRNA, partial sequence, strain: NBRC 13421	2647	2647	98%	0.0	99%	AB184391.2
Streptomyces fulvorobeus 16S rRNA gene, type strain LMG 19901	2647	2647	97%	0.0	99%	AJ781331.1
Streptomyces parvus gene for 16S rRNA, partial sequence, strain: NBRC 14599	2643	2643	98%	0.0	99%	AB184603.1
Streptomyces setonii gene for 16S rRNA, partial sequence, strain: NBRC 13085	2643	2643	97%	0.0	99%	AB184300.1

Alignments

Streptomyces griseus subsp. griseus NBRC 13350 DNA, complete genome
Sequence ID: **AP009493.1** Length: 8545929 Number of Matches: 6
Range 1: 2102343 to 2103819

Score	Expect	Identities	Gaps	Strand	Frame
2721 bits(1473)	0.0()	1476/1477(99%)	1/1477(0%)	Plus/Plus	
Features:					
rRNA-16S ribosomal RNA					
Query	1	GTTACGACTTCGT-CCAATCGCCAGTCCACCTTCGACAGCTCCCTCCACAAGGGGTG	59		
Sbjct	2102343	TACGACTTCGTCCCAATCGCCAGTCCACCTTCGACAGCTCCCTCCACAAGGGGTG	2102402		
Query	60	GGCCACCGGCTTCGGGTGTTACCGACTTTCGTGACGTGACGGGCGGTGTGTACAAGGCC	119		
Sbjct	2102403	GGCCACCGGCTTCGGGTGTTACCGACTTTCGTGACGTGACGGGCGGTGTGTACAAGGCC	2102462		
Query	120	GGGAACGTATTCACCGCAGCAATGCTGATCTGCGATTACTAGCAACTCCGACTTCATGGG	179		
Sbjct	2102463	GGGAACGTATTCACCGCAGCAATGCTGATCTGCGATTACTAGCAACTCCGACTTCATGGG	2102522		
Query	180	GTCGAGTTGCAGACCCCAATCCGAACTGAGACCGGCTTTTTGAGATTTCGCTCCGCCTCGC	239		
Sbjct	2102523	GTCGAGTTGCAGACCCCAATCCGAACTGAGACCGGCTTTTTGAGATTTCGCTCCGCCTCGC	2102582		
Query	240	GGCATCGCAGCTCATTGTACCGGCCATTGTAGCAGTGTGCAGCCCAAGACATAAGGGGC	299		
Sbjct	2102583	GGCATCGCAGCTCATTGTACCGGCCATTGTAGCAGTGTGCAGCCCAAGACATAAGGGGC	2102642		
Query	300	ATGATGACTTGACGTCGTCCACCTTCTCCGAGTTGACCCCGGAGTCTCCTGTGAGT	359		
Sbjct	2102643	ATGATGACTTGACGTCGTCCACCTTCTCCGAGTTGACCCCGGAGTCTCCTGTGAGT	2102702		
Query	360	CCCCATCAGCCGAAGGGCATGCTGGCAACACAGAACAAGGGTTGCGCTCGTTGCGGGAC	419		
Sbjct	2102703	CCCCATCAGCCGAAGGGCATGCTGGCAACACAGAACAAGGGTTGCGCTCGTTGCGGGAC	2102762		
Query	420	TTAACCAACATCTCAGACACGAGCTGACGACAGCCATGCACCACCTGTATACCGACCA	479		

BLAST Results

[Questions/comments](#)

Job title: 4_1525

RID [TYT8A0E301R](#) (Expires on 09-18 16:25 pm)

Query ID |cl|Query_130761
Description 4_1525
Molecule type nucleic acid
Query Length 1476

Database Name nr
Description Nucleotide collection (nt)
Program BLASTN 2.8.0+

Graphic Summary

Distribution of the top 190 Blast Hits on 100 subject sequences

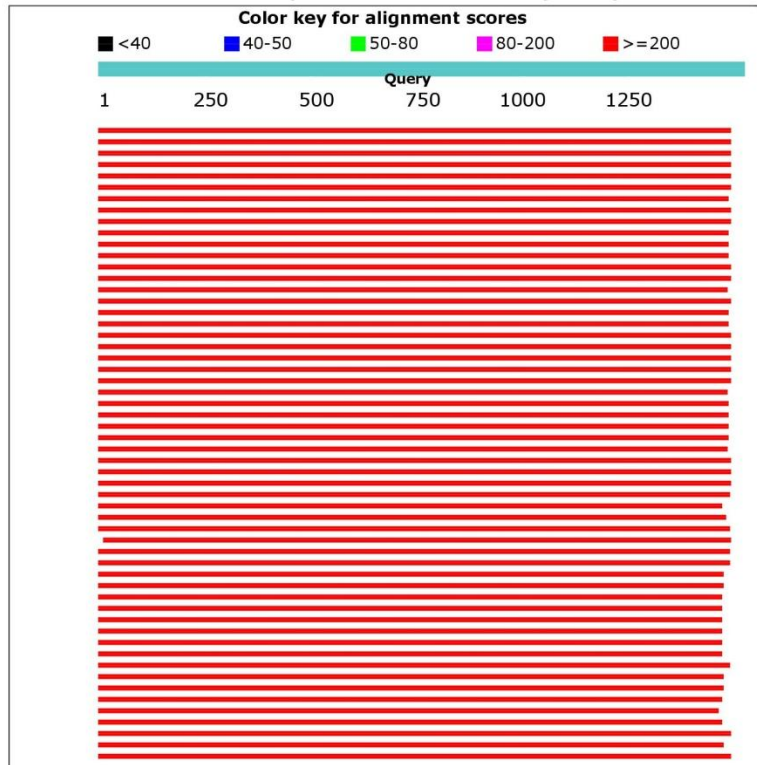

Descriptions

Sequences producing significant alignments:

Description	Max score	Total score	Query cover	E value	Ident	Accession
<i>Streptomyces griseus</i> subsp. <i>griseus</i> NBRC 13350 DNA, complete genome	2721	16327	100%	0.0	99%	AP009493.1
<i>Streptomyces pratensis</i> ATCC 33331, complete genome	2715	16238	100%	0.0	99%	CP002475.1
<i>Streptomyces globisporus</i> strain TFH56 chromosome, complete genome	2710	16238	100%	0.0	99%	CP029361.1
<i>Streptomyces fulvissimus</i> strain DSM 40593 16S ribosomal RNA, partial sequence	2710	2710	100%	0.0	99%	NR_103947.1
<i>Streptomyces fulvissimus</i> DSM 40593, complete genome	2710	16260	100%	0.0	99%	CP005080.1
<i>Streptomyces</i> sp. PAMC26508, complete genome	2710	16257	100%	0.0	99%	CP003990.1
<i>Streptomyces pratensis</i> strain ch24 16S ribosomal RNA, partial sequence	2706	2706	99%	0.0	99%	NR_125621.1
<i>Streptomyces globisporus</i> C-1027, complete genome	2704	16227	100%	0.0	99%	CP013738.1
<i>Streptomyces luridiscabiei</i> strain S63 16S ribosomal RNA, partial sequence	2704	2704	100%	0.0	99%	NR_025155.1
<i>Streptomyces flavolimosus</i> strain CGMCC 2027 16S ribosomal RNA gene, partial sequence	2702	2702	99%	0.0	99%	EF688620.1
<i>Streptomyces praecox</i> strain CGMCC 4.1782 clone 3 16S ribosomal RNA gene, complete sequence	2700	2700	99%	0.0	99%	JQ924404.1
<i>Streptomyces pratensis</i> strain ch24 16S ribosomal RNA, partial sequence	2700	2700	99%	0.0	99%	NR_125619.1
<i>Streptomyces</i> sp. SM18 chromosome, complete genome	2699	16183	100%	0.0	99%	CP029342.1
<i>Streptomyces flavofuscus</i> strain CGMCC 4.1938 clone 3 16S ribosomal RNA gene, complete sequence	2699	2699	99%	0.0	99%	JQ924409.1
<i>Streptomyces griseus</i> strain NRRL B-8030 16S ribosomal RNA gene, partial sequence	2699	2699	99%	0.0	99%	DQ026671.1
<i>Streptomyces</i> sp. Tue6075, complete genome	2695	16157	100%	0.0	99%	CP010833.1
<i>Streptomyces praecox</i> strain CGMCC 4.1782 clone 2 16S ribosomal RNA gene, complete sequence	2695	2695	99%	0.0	99%	JQ924403.1
<i>Streptomyces pratensis</i> strain ch24 16S ribosomal RNA, partial sequence	2695	2695	99%	0.0	99%	NR_125618.1
<i>Streptomyces violaceoruber</i> strain S21, complete genome	2693	16161	100%	0.0	99%	CP020570.1
<i>Streptomyces flavofuscus</i> strain CGMCC 4.1938 clone 2 16S ribosomal RNA gene, complete sequence	2693	2693	99%	0.0	99%	JQ924408.1
<i>Streptomyces flavofuscus</i> strain CGMCC 4.1938 clone 1 16S ribosomal RNA gene, complete sequence	2693	2693	99%	0.0	99%	JQ924407.1
<i>Streptomyces</i> sp. SirexAA-E, complete genome	2693	16133	100%	0.0	99%	CP002993.1
<i>Streptomyces flavofuscus</i> strain NRRL B-2594 16S ribosomal RNA gene, partial sequence	2691	2691	100%	0.0	99%	EF178690.1

Description	Max score	Total score	Query cover	E value	Ident	Accession
Streptomyces microflavus strain NRRL B-2156 16S ribosomal RNA gene, partial sequence	2691	2691	99%	0.0	99%	DQ445795.1
Streptomyces praecox strain CGMCC 4.1782 clone 5 16S ribosomal RNA gene, complete sequence	2689	2689	99%	0.0	99%	JQ924406.1
Streptomyces praecox strain CGMCC 4.1782 clone 4 16S ribosomal RNA gene, complete sequence	2689	2689	99%	0.0	99%	JQ924405.1
Streptomyces praecox strain CGMCC 4.1782 clone 1 16S ribosomal RNA gene, complete sequence	2689	2689	99%	0.0	99%	JQ924402.1
Streptomyces pratensis strain ch24 16S ribosomal RNA, partial sequence	2689	2689	99%	0.0	99%	NR_125620.1
Streptomyces anulatus strain NRRL B-2000 16S ribosomal RNA gene, partial sequence	2689	2689	99%	0.0	99%	DQ026637.1
Streptomyces flavogriseus partial 16S rRNA gene, type strain CBS 101.34T	2687	2687	100%	0.0	99%	AJ494864.1
Streptomyces baarnensis strain NRRL B-1902 16S ribosomal RNA gene, partial sequence	2686	2686	100%	0.0	99%	EF178688.1
Streptomyces sp. CFMR 7 strain CFMR-7, complete genome	2682	15924	100%	0.0	99%	CP011522.1
Streptomyces flavovirens strain CGMCC 4.575 clone 1 16S ribosomal RNA gene, complete sequence	2682	2682	99%	0.0	99%	JQ924386.1
Streptomyces griseus subsp. griseus gene for 16S rRNA, partial sequence, strain: NBRC 15744	2680	2680	98%	0.0	99%	AB184699.1
Streptomyces argenteolus strain JCM 4623 16S ribosomal RNA, partial sequence	2680	2680	99%	0.0	99%	NR_112120.1
Streptomyces flavovirens strain CGMCC 4.575 clone 2 16S ribosomal RNA gene, complete sequence	2678	2678	99%	0.0	99%	JQ924387.1
Streptomyces sp. YM5-799 gene for 16S rRNA, partial sequence	2678	2678	99%	0.0	99%	AB534176.1
Streptomyces flavovirens strain CGMCC 4.575 clone 5 16S ribosomal RNA gene, complete sequence	2676	2676	99%	0.0	99%	JQ924389.1
Streptomyces flavovirens strain CGMCC 4.575 clone 4 16S ribosomal RNA gene, complete sequence	2676	2676	99%	0.0	99%	JQ924388.1
Streptomyces microflavus strain NRRL B-1332 16S ribosomal RNA gene, partial sequence	2675	2675	98%	0.0	99%	EF178673.1
Streptomyces pasesii 16S rRNA gene, type strain LMG 23704T	2675	2675	98%	0.0	99%	AJ969177.1
Streptomyces anulatus gene for 16S rRNA, partial sequence, strain: NBRC 13369	2673	2673	98%	0.0	99%	AB184875.1
Streptomyces cavourensis subsp. washingtonensis gene for 16S rRNA, partial sequence, strain: NBRC 15391	2673	2673	98%	0.0	99%	AB184642.1
Streptomyces acidoresistans gene for 16S rRNA, partial sequence, strain: NBRC 13442	2673	2673	98%	0.0	99%	AB184406.1
Streptomyces praecox gene for 16S rRNA, partial sequence, strain: NBRC 13073	2673	2673	98%	0.0	99%	AB184293.1
Streptomyces albobivridis gene for 16S rRNA, partial sequence, strain: NBRC	2673	2673	98%	0.0	99%	AB184256.1

Description	Max score	Total score	Query cover	E value	Ident	Accession
Streptomyces argenteolus gene for 16S rRNA, partial sequence, strain: NBRC 12841	2673	2673	98%	0.0	99%	AB184187.1
Streptomyces finlayi strain CGMCC 4.1436 clone 1 16S ribosomal RNA gene, complete sequence	2669	2669	99%	0.0	99%	JQ924390.1
Streptomyces rubiginosohelvolus gene for 16S rRNA, partial sequence, strain: NBRC 12912	2669	2669	98%	0.0	99%	AB184240.2
Streptomyces microflavus gene for 16S rRNA, partial sequence, strain: NBRC 13062	2669	2669	98%	0.0	99%	AB184284.1
Streptomyces fulvorobeus gene for 16S rRNA, partial sequence, strain: NBRC 15897	2667	2667	98%	0.0	99%	AB184711.1
Streptomyces griseus subsp. griseus gene for 16S rRNA, partial sequence, strain: NBRC 12875	2667	2667	98%	0.0	99%	AB184211.1
Streptomyces griseinus gene for 16S rRNA, partial sequence, strain: NBRC 12869	2667	2667	98%	0.0	99%	AB184205.1
Streptomyces sp. S8, complete genome	2665	15950	100%	0.0	99%	CP015362.1
Streptomyces flavofuscus gene for 16S rRNA, partial sequence, strain: NBRC 100768	2665	2665	98%	0.0	99%	AB249935.1
Streptomyces clavifer strain NRRL B-2557 16S ribosomal RNA gene, partial sequence	2663	2663	99%	0.0	99%	DQ026670.1
Streptomyces albobovineus gene for 16S rRNA, partial sequence, strain: NBRC 12739	2663	2663	98%	0.0	99%	AB249958.1
Streptomyces erumpens gene for 16S rRNA, partial sequence, strain: NBRC 15403	2663	2663	97%	0.0	99%	AB184654.1
Streptomyces baarnensis gene for 16S rRNA, partial sequence, strain: NBRC 14727	2663	2663	98%	0.0	99%	AB184615.1
Streptomyces fimicarius gene for 16S rRNA, partial sequence, strain: NBRC 13037	2663	2663	98%	0.0	99%	AB184269.1
Streptomyces globisporus subsp. globisporus gene for 16S rRNA, partial sequence, strain: NBRC 12867	2663	2663	98%	0.0	99%	AB184203.1
Streptomyces cavourensis strain TJ430 chromosome, complete genome	2662	15856	100%	0.0	99%	CP030930.1
Streptomyces bacillaris strain ATCC 15855 chromosome, complete genome	2662	15972	100%	0.0	99%	CP029378.1
Streptomyces cavourensis strain 1AS2a chromosome, complete genome	2662	15928	100%	0.0	99%	CP024957.1
Streptomyces globisporus subsp. globisporus strain NRRL B-2872 16S ribosomal RNA gene, partial sequence	2662	2662	98%	0.0	99%	EF178686.1
Streptomyces griseolus gene for 16S rRNA, partial sequence, strain: NBRC 3415	2662	2662	98%	0.0	99%	AB184768.1
Streptomyces puniceus gene for 16S rRNA, partial sequence, strain: NBRC 12811	2662	2662	98%	0.0	99%	AB184163.1
Streptomyces halstedii gene for 16S rRNA, partial sequence, strain: NBRC 12783	2662	2662	98%	0.0	99%	AB184142.1

Description	Max score	Total score	Query cover	E value	Ident	Accession
Streptomyces atratus strain SCSIO_ZH16 chromosome, complete genome	2660	15961	100%	0.0	99%	CP027306.1
Streptomyces flavovirens strain NRRL B-2685 16S ribosomal RNA gene, partial sequence	2660	2660	99%	0.0	99%	DQ026635.1
Streptomyces pluricolorescens gene for 16S rRNA, partial sequence, strain: NBRC 12808	2660	2660	98%	0.0	99%	AB184162.1
Streptomyces olivoviridis strain CGMCC 4.1739 clone 2 16S ribosomal RNA gene, complete sequence	2658	2658	99%	0.0	99%	JQ924394.1
Streptomyces finlayi strain CGMCC 4.1436 clone 2 16S ribosomal RNA gene, complete sequence	2658	2658	99%	0.0	99%	JQ924391.1
Streptomyces californicus gene for 16S rRNA, partial sequence, strain: NBRC 12750	2658	2658	98%	0.0	99%	AB184116.2
Streptomyces cinereorectus gene for 16S rRNA, partial sequence, strain: NBRC 15395	2658	2658	98%	0.0	99%	AB184646.1
Streptomyces mutomycini strain CGMCC 4.1747 clone 3 16S ribosomal RNA gene, complete sequence	2656	2656	99%	0.0	99%	JQ924399.1
Streptomyces halstedii strain NRRL B-1238 16S ribosomal RNA gene, partial sequence	2656	2656	98%	0.0	99%	EF178695.1
Streptomyces parvus gene for 16S rRNA, partial sequence, strain: NBRC 3388	2656	2656	98%	0.0	99%	AB184756.1
Streptomyces californicus gene for 16S rRNA, partial sequence, strain: NBRC 3386	2656	2656	98%	0.0	99%	AB184755.1
Streptomyces badius gene for 16S rRNA, partial sequence, strain: NBRC 12745	2656	2656	98%	0.0	99%	AB184114.1
Streptomyces lunaelactis strain MM109 chromosome, complete genome	2654	15660	100%	0.0	99%	CP026304.1
Streptomyces nitrosporeus strain CGMCC 4.1973 clone 4 16S ribosomal RNA gene, complete sequence	2654	2654	99%	0.0	99%	JQ924413.1
Streptomyces anulatus strain NRRL B-2873 16S ribosomal RNA gene, partial sequence	2654	2654	97%	0.0	99%	DQ026639.1
Streptomyces sindenensis gene for 16S rRNA, partial sequence, strain: NBRC 3399	2654	2654	98%	0.0	99%	AB184759.1
Streptomyces mediolani gene for 16S rRNA, partial sequence, strain: NBRC 15427	2654	2654	98%	0.0	99%	AB184674.1
Streptomyces olivoviridis strain CGMCC 4.1739 clone 5 16S ribosomal RNA gene, complete sequence	2652	2652	99%	0.0	99%	JQ924396.1
Streptomyces olivoviridis strain CGMCC 4.1739 clone 4 16S ribosomal RNA gene, complete sequence	2652	2652	99%	0.0	99%	JQ924395.1
Kitasatospora albolonga strain YIM 101047, complete genome	2651	15858	100%	0.0	99%	CP020563.1
Streptomyces mutomycini strain CGMCC 4.1747 clone 1 16S ribosomal RNA gene, complete sequence	2651	2651	99%	0.0	99%	JQ924397.1

Description	Max score	Total score	Query cover	E value	Ident	Accession
Streptomyces flavovirens gene for 16S rRNA, partial sequence, strain: NBRC 3197	2651	2651	98%	0.0	99%	AB184827.1
Streptomyces ornatus gene for 16S rRNA, partial sequence, strain: NBRC 13069	2651	2651	97%	0.0	99%	AB184290.1
Streptomyces flavogriseus gene for 16S rRNA, partial sequence, strain: NBRC 13040	2651	2651	98%	0.0	99%	AB184271.1
Streptomyces flavovirens gene for 16S rRNA, partial sequence, strain: NBRC 12771	2651	2651	98%	0.0	99%	AB184133.1
Streptomyces nitrosporeus strain CGMCC 4.1973 clone 3 16S ribosomal RNA gene, complete sequence	2649	2649	99%	0.0	99%	JQ924412.1
Streptomyces nitrosporeus strain CGMCC 4.1973 clone 1 16S ribosomal RNA gene, complete sequence	2649	2649	99%	0.0	99%	JQ924411.1
Streptomyces olivoviridis strain CGMCC 4.1739 clone 1 16S ribosomal RNA gene, complete sequence	2647	2647	99%	0.0	99%	JQ924393.1
Streptomyces naraensis gene for 16S rRNA, partial sequence, strain: NBRC 13421	2647	2647	98%	0.0	99%	AB184391.2
Streptomyces fulvorobeus 16S rRNA gene, type strain LMG 19901	2647	2647	97%	0.0	99%	AJ781331.1
Streptomyces parvus gene for 16S rRNA, partial sequence, strain: NBRC 14599	2643	2643	98%	0.0	99%	AB184603.1
Streptomyces setonii gene for 16S rRNA, partial sequence, strain: NBRC 13085	2643	2643	97%	0.0	99%	AB184300.1

Alignments

Streptomyces griseus subsp. griseus NBRC 13350 DNA, complete genome
Sequence ID: **AP009493.1** Length: 8545929 Number of Matches: 6
Range 1: 2102343 to 2103819

Score	Expect	Identities	Gaps	Strand	Frame
2721 bits(1473)	0.0()	1476/1477(99%)	1/1477(0%)	Plus/Plus	

Features:

rRNA-16S ribosomal RNA

Query	1	GTTACGACTTCGT-CCAATCGCCAGTCCACCTTCGACAGCTCCCTCCCACAAGGGGTG	59
Sbjct	2102343	GTTACGACTTCGTCCCAATCGCCAGTCCACCTTCGACAGCTCCCTCCCACAAGGGGTG	2102402
Query	60	GGCCACCGGCTTCGGGTGTTACCGACTTTCGTGACGTGACGGGCGGTGTGTACAAGGCC	119
Sbjct	2102403	GGCCACCGGCTTCGGGTGTTACCGACTTTCGTGACGTGACGGGCGGTGTGTACAAGGCC	2102462
Query	120	GGGAACGTATTACCGCAGCAATGCTGATCTGCGATTACTAGCAACTCCGACTTCATGGG	179
Sbjct	2102463	GGGAACGTATTACCGCAGCAATGCTGATCTGCGATTACTAGCAACTCCGACTTCATGGG	2102522
Query	180	GTCGAGTTGCAGACCCCAATCCGAAGTGGACCGGCTTTTGGAGATTCGCTCCGCCTCGC	239
Sbjct	2102523	GTCGAGTTGCAGACCCCAATCCGAAGTGGACCGGCTTTTGGAGATTCGCTCCGCCTCGC	2102582
Query	240	GGCATCGCAGCTCATTGTACCGGCATTGTAGCACGTGTGACGCCAAGACATAAGGGGC	299
Sbjct	2102583	GGCATCGCAGCTCATTGTACCGGCATTGTAGCACGTGTGACGCCAAGACATAAGGGGC	2102642
Query	300	ATGATGACTTGACGTGCTCCCACTTCCTCCGAGTTGACCCCGCAGTCTCCTGTGAGT	359
Sbjct	2102643	ATGATGACTTGACGTGCTCCCACTTCCTCCGAGTTGACCCCGCAGTCTCCTGTGAGT	2102702
Query	360	CCCCATCACCCGAAGGGCATGCTGGCAACACAGAAAGGGTTGCGCTCGTTGCGGGAC	419
Sbjct	2102703	CCCCATCACCCGAAGGGCATGCTGGCAACACAGAAAGGGTTGCGCTCGTTGCGGGAC	2102762
Query	420	TTAACCAACATCTCACGACACGAGCTGACGACAGCCATGCACCACCTGTATACCGACCA	479

Antibiotic test

Antibiotic test	
EI:	<i>Streptomyces</i> sp. SN25_8.1
SG:	<i>Streptomyces griseus</i> subsp. <i>griseus</i> DSM 40236 ^T
ST:	Streptomycin

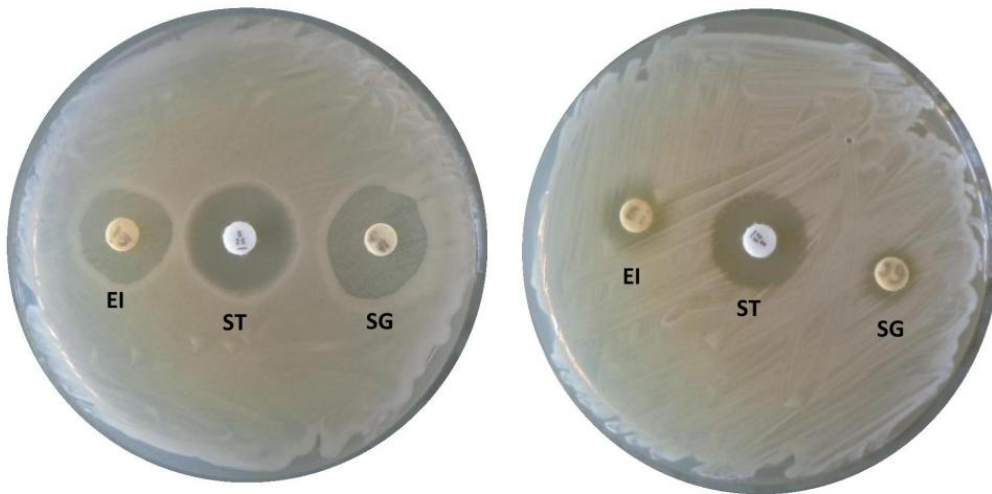

Antibiotic test Left plate: *E. coli* DSM 498, Right Plate: *S. lentus* DSM 20352

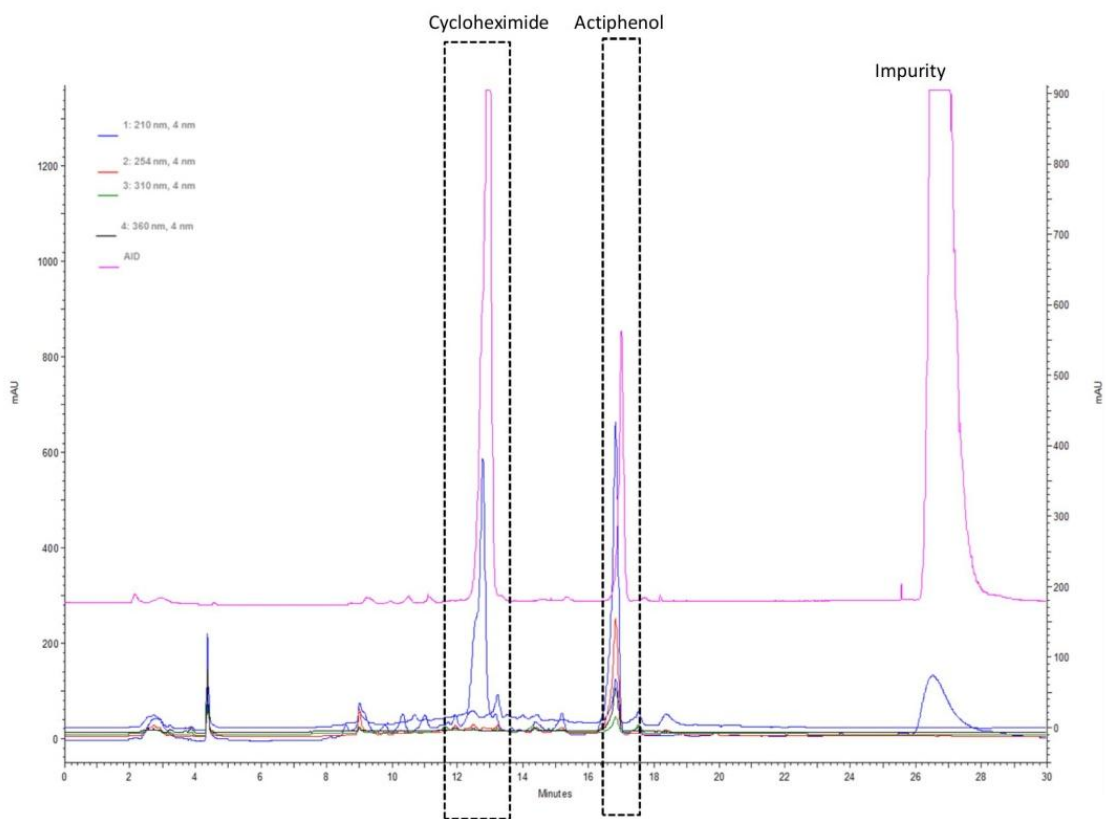

HPLC –ELSD profile of *Streptomyces* sp. SN25_8.1.

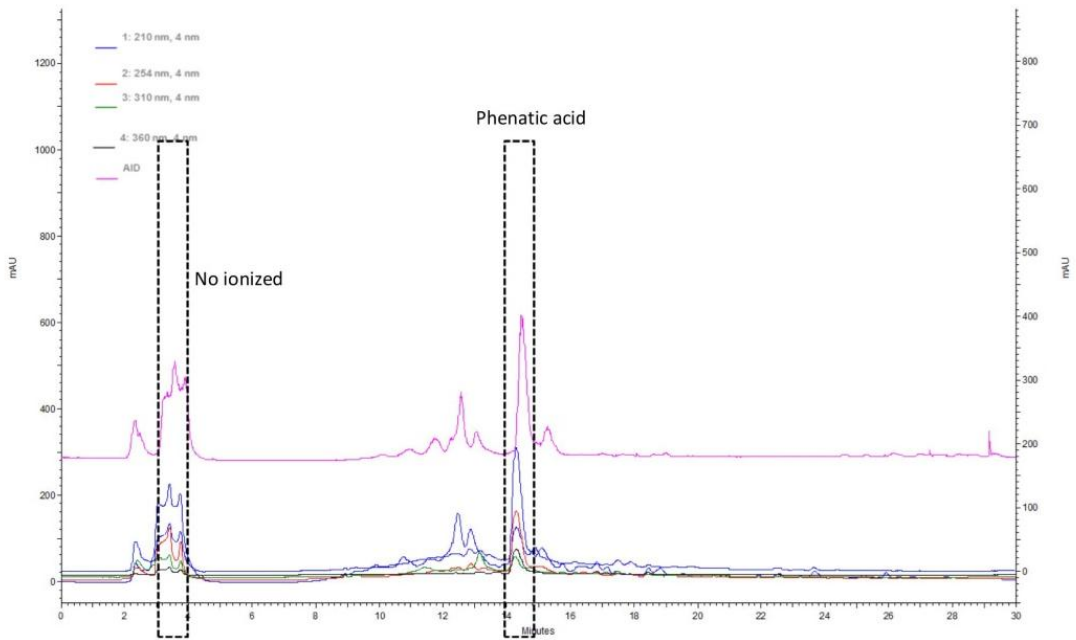

HPLC –ELSD profile of *Streptomyces griseus* subsp. *griseus* DSM 40236^T.

