



UNIVERSITY OF LA ROCHELLE, FRANCE
and
CHRISTIAN-ALBRECHTS-UNIVERSITY OF
KIEL, GERMANY



DOCTORAL SCHOOLS
EUCLIDE, University of La Rochelle, and POLMAR, Alfred Wegener Institute

DOCTORAL THESIS submitted by:
Luuk Hendrikus VAN DER HEIJDEN

Determination of the food sources and of the role of meiofauna in soft-bottom intertidal habitats of the Marennes-Oléron Bay, France, and the Sylt-Rømø Bight, Germany. Importance of the microphytobenthos-meiofauna pathway, highlighted by community structure, trophic markers and linear inverse food web models.

Dissertation in fulfilment of the requirements to obtain the title of Doctor of Philosophy from the University of La Rochelle, France, and the degree “Dr. rer. nat.” from the Faculty of Mathematics and Natural Sciences at Kiel University, Germany

Defended on: the 18th of December 2018 at the University of La Rochelle, France
Discipline: Biology of the environment, of populations, and of ecology

Hosting institutions:

UMR Littoral, ENvironnement et Sociétés, CNRS-University of La Rochelle, France
and
Alfred Wegener Institute – Helmholtz Centre for Polar and Marine Research,
Wadden Sea Station Sylt, Germany

Thesis supervised by:

Dr. Benoit LEBRETON and Dr. HDR Harald ASMUS

JURY:

Tom MOENS	Prof. Dr., Ghent University, Belgium	Reviewer
Jack MIDDELBURG	Prof. Dr., Utrecht University, Netherlands	Reviewer
Martin WAHL	Prof. Dr., University of Kiel, Germany	Reviewer
Benoit LEBRETON	Dr., University of La Rochelle, France	Thesis director
Harald ASMUS	Dr. HDR, University of Kiel, Germany	Thesis director/reviewer
Gérard BLANCHARD	Prof. Dr., University of La Rochelle, France	Examiner
Nathalie NIQUIL	Research director, CNRS, France	Examiner
Jadwiga RZEZNIK-ORIGNAC	Dr., University Pierre et Marie Curie, France	Examiner
Ragnhild ASMUS	Dr., Alfred-Wegener-Institute, Germany	Invited
Martin GRAEVE	Dr., Alfred-Wegener-Institute, Germany	Invited

UNIVERSITY OF LA ROCHELLE, FRANCE
and
CHRISTIAN-ALBRECHTS-UNIVERSITY KIEL, GERMANY

DOCTORAL THESIS submitted by:
Luuk Hendrikus VAN DER HEIJDEN

**Determination of the food sources and of the role of
meiofauna in soft-bottom intertidal habitats of the Marennes-
Oléron Bay, France, and the Sylt-Rømø Bight, Germany.
Importance of the microphytobenthos-meiofauna pathway,
highlighted by community structure, trophic markers and
linear inverse food web models.**

Dissertation in fulfilment of the requirements to obtain the title of Doctor of
Philosophy from the University of La Rochelle, France, and the degree “Dr. rer.
nat.” from the Faculty of Mathematics and Natural Sciences
at Kiel University, Germany

Defended on: the 18th of December 2018 at the University of La Rochelle, France
Discipline: Biology of the environment, of populations, and of ecology

Hosting institutions:

UMR Littoral, ENvironnement et Sociétés, CNRS-University of La Rochelle, France
and

Alfred Wegener Institute – Helmholtz Centre for Polar and Marine Research,
Wadden Sea Station Sylt, Germany

Thesis supervised by:

Dr. Benoit LEBRETON and Dr. HDR Harald ASMUS

JURY:

Tom MOENS	Prof. Dr., Ghent University, Belgium	Reviewer
Jack MIDDELBURG	Prof. Dr., Utrecht University, Netherlands	Reviewer
Martin WAHL	Prof. Dr., University of Kiel, Germany	Reviewer
Benoit LEBRETON	Dr., University of La Rochelle, France	Thesis director
Harald ASMUS	Dr. HDR, University of Kiel, Germany	Thesis director/reviewer
Gérard BLANCHARD	Prof. Dr., University of La Rochelle, France	Examiner
Nathalie NIQUIL	Research director, CNRS, France	Examiner
Jadwiga RZEZNIK-ORIGNAC	Dr., University Pierre et Marie Curie, France	Examiner
Ragnhild ASMUS	Dr., Alfred-Wegener-Institute, Germany	Invited
Martin GRAEVE	Dr., Alfred-Wegener-Institute, Germany	Invited

Foreword

This doctoral thesis was realized at the University of La Rochelle, within the team *BIOFEEL* (BIOdiversité et Fonctionnement des Ecosystèmes Littoraux) of the Littoral, ENvironnement et Sociétés (UMR 7266, CNRS – University of La Rochelle, France) and at the Wadden Sea Station Sylt of the Alfred Wegener Institute, within the team *Ecosystem analysis* of the Alfred Wegener Institute – Helmholtz Association for Polar and Marine Research, Germany. This thesis was part of a co-supervision agreement between the University of La Rochelle, France, and the Christian-Albrechts-University, Kiel, Germany.

This work was financially supported by the University of La Rochelle through a grant provided by the ‘Ministère de l’Enseignement Supérieur et de la Recherche’. This work was supported by the CNRS through the CNRS research chair provided to B. Lebreton. Financial support was provided by the Alfred Wegener Institute Helmholtz Centre for Polar and Marine Research, as well as the University of La Rochelle (Mobility for doctoral students) and the German Academic Exchange Service (DAAD: short-term research grant, 2017, no. 57314023).

Part of this work was carried out on a study area located within the Réserve Naturelle de Moëze-Oléron, France, administered by the Ligue de Protection des Oiseaux, as well as on a study location within the UNESCO World Heritage Site of the Wadden Sea, Germany.

The technical and analytical work of this thesis was carried out with the help of many people.

Fieldwork:

- Fieldwork sampling was performed at two habitats of the Marennes-Oléron Bay, France, with the help of Juliette Baumann, Denis Fichet, Nicolas Lachaussée, Benoit Lebreton and Philippe Pineau.
- Fieldwork sampling was performed at three habitats of the Sylt-Rømø Bight, Germany, with the help of Birgit Hussel, Petra Kadel, Sabine Horn, Martin Paar, Lasse Sander, Martin Burgdorf and Benoit Lebreton.
- Seawater samples were collected at two stations in the Marennes-Oléron Bay, France, with the help of Philippe Pineau, Nicolas Lachaussée and Benoit Lebreton. Seawater was also sampled at three stations in the Sylt-Rømø Bight, Germany, with the help of Petra Kadel, Benoit Lebreton and the Mya crew of AWI Sylt.

Sample preparation:

- Seagrass leaves and roots were handpicked for biomass estimations as well as later analyses of isotope compositions with the help of Martine Bréret.
- Seawater samples were filtered for collection of suspended particulate organic matter with the help of Martine Bréret and Petra Kadel.
- Preparation of organic material from potential food sources for isotope analyses were done with the help of Quentin Bernier.

Samples analyses:

- Taxonomic analyses of meiofauna was done with the help of Jadwiga Rzeznik-Orignac with a small training on meiofauna taxonomy at the Oceanography Station in Banyuls-sur-Mer, France.
- Bacteria abundances were analyzed using a flow cytometer with the help of Laureen Beugeard.
- Isotope analyses were run at the University of La Rochelle, France, with the help of Gaël Guillou.
- Fatty acid analyses and compound specific isotope analyses were conducted at the Alfred Wegener Institute Helmholtz Centre for Polar and Marine Research, Bremerhaven. I worked within the *Marine Chemistry* working group under supervision of Martin Graeve and had help from Dieter Janssen and Valeria Adrian.

Food web models:

- Food web models of the five intertidal habitats were constructed with the help of Harald Asmus, Ragnhild Asmus, Matilda Haraldsson, Nathalie Niquil, Quentin Nogues, Stephen Pacella, Blanche Saint-Béat and Camille de la Vega.

This work has also been accomplished thanks to the help of an intern, Quentin Bernier. Quentin did this internship as part of the compulsory internship of the 3rd year bachelor (co-supervision with Benoit Lebreton). He helped with the sorting and preparation of food sources for isotope analyses. His data analyses provided helpful information which was used in this thesis.

At the end of September part of the work in this thesis was published:
van der Heijden, L.H., Rzeznik-Orignac, J., Asmus, R., Fichet, D., Bréret, M., Kadel, P., Beugeard, L., Asmus, H., Lebreton, B. **How do food sources drive meiofauna community structure in soft-bottom coastal food webs?** *Marine Biology*, 165:166. doi:10.1007/s00227-018-3419-7

Part of this thesis has been presented at the Coastal estuarine Research Federation conference in November, 2017, in Providence, Rhode Island, USA. Other work related to the thesis was also presented at:

- the 2nd year symposium of the University of La Rochelle, France.

- the ENA-workshop 2017 at the Wadden Sea Station Sylt, Alfred Wegener Institute, Germany.
- the AWI PhD-days 2018 at the Wadden Sea Station Sylt, Alfred Wegener Institute, Germany.

This work has also been vulgarized in the form of a 5-minute video with which the jury price was won at the Festival de Film (pas trop) Scientifique 2017 organized by the association of doctoral students (ADOCS) at the University of La Rochelle, France.

In parallel of this thesis two years of teaching was conducted at the University of La Rochelle as part of a DCACE contract. Lectures were given in “*Ecophysiologie marine*” (1st year of Master). As well as practical work in “*Biologie animale 1*” (1st year of Bachelor) and “*Expérimentation au laboratoire appliquée au domaine marine*” (3rd year of Bachelor).

Acknowledgements

First of all, I would like to thank the reviewers, Jack Middelburg, Tom Moens, Martin Wahl and Harald Asmus, who have agreed to participate in the evaluation of this doctoral thesis.

I thank the University of La Rochelle, France and the Alfred Wegener Institute, Helmholtz Centre for Polar and Marine Research, Germany for permitting me to realize this work. Also, I would like to thank the doctoral schools *Gay-Lussac* (now *EUCLIDE*), University of La Rochelle, France, and *POLMAR*, AWI, Bremerhaven, Germany, for supporting me during my thesis. And finally, the University of La Rochelle, France, and the Christian-Albrechts-University, Kiel, Germany, for hosting my PhD.

I warmly thank my main supervisors, Benoit Lebreton and Harald Asmus, as well as Ragnhild Asmus, for giving me the chance to work these last three years on this PhD thesis. Thank you for your support and peacefulness that helped me to take the steps needed during my PhD. Your advice and comments are well appreciated, and helped me reduce the stress and worries that are common during a PhD. Your experiences in the scientific world made it easier and more comfortable for me during these last years. I thank you all for your trust in me. I am very grateful for your positivity, enthusiasm and support, as well as the independence you gave me. The collaborations and possibilities to work in so many laboratories and with so many different people gave this thesis an extra layer, which I am thankful for.

Thank you Benoit, from the beginning you were always there to explain, assist, complement, comment and translate. You made it easier for me to integrate in two new environments (countries), both in France and Germany, and were there to discuss with when needed. You have given me the opportunity to grow as a scientist and guided me where needed. You were there for the sampling, the sample preparation, the analyses and the data interpretation. Whenever I had a question, you were always able to answer or guide me into the right direction. Our discussions about science were very fruitful and constructive.

Harald and Ragnhild, you were there to help me, explain to me and discuss with me when I was at the Wadden Sea Station on Sylt. Our discussions about the project and the food web models were very helpful and highly appreciated. I could always knock on your door knowing that I would return with a satisfied feeling. You were there to guide me during many processes of young academic scientist, the data interpretation, critical notes, paper writing and presenting of data.

Jadwiga Rzeznik-Orignac, I thank you for introducing into the world of nematodes. Thanks to you I am now able to distinguish a *Metachromadora remanei* from a *Metachromadora vivipara*. Your experience in the field of nematodes and your previous work at the Marennes-Oléron Bay helped me a lot during my PhD. The stays I had at the Oceanographic station in Banyuls-sur-Mer were always very nice.

Martin Graeve, I warmly thank you for sharing your experience and introducing me to the world of fatty acids. You were there to teach me about fatty acids and all the processes involved in the fatty acid analyses. Your door was open whenever I had questions or wanted to discuss matters and I felt very welcome at your working group.

Nathalie Niquil, I thank you for sharing your experience on food web models, as well as, in the scientific world. The discussions we had were always very fruitful and I am grateful for your positivity. The opportunity you gave me to work on food web models and progress in the world of linear inverse models is much appreciated.

A special thanks to all the members of my PhD committee, Benoit Lebreton, Harald Asmus, Ragnhild Asmus, Jadwiga Rzeznik-Orignac, Martin Graeve, Nathalie Niquil and Gérard Blanchard. The committee meetings were very helpful and gave me the opportunity to approach the project from many different angles. Through your experiences in the various fields of marine ecology studies I obtained an interesting perspective and way of thinking.

– I would like to thank everybody at the University of La Rochelle and the AWI with whom I worked during my PhD –

I am very thankful for the people who helped me during fieldwork, lab work and working on models: Philippe Pineau, Nicolas Lachaussée, Denis Fichet, Juliette Baumann, Petra Kadel, Martin Pahr, Sabine Horn, Birgitte Hussel, Martin Burgdorf, Gaël Guillou, Quentin Bernier, Laureen Beaugeard, Martine Bréret, Valeria Adrian, Dieter Janssen, Matilda Haraldsson, Stephen Pacella, Quentin Nogues and the Mya II crew.

Phillipe, Nicolas, Juliette and Denis, thank you for your support during fieldwork in the Marennes-Oléron Bay. “Building sandcastles” was always fun with you all. Waiting on the boat for the tide to return all covered in mud. I couldn’t have done it without you.

Petra Kadel, Martin Pahr, Sabine Horn, Birgitte Hussel, Martin Burgdorf, thank you for your help during the fieldwork in the Sylt-Rømø Bight. Collecting samples with you was always a fun

experience. Especially during the winter season, which was a bit cold, I am grateful for your help. Petra, I am grateful for your assistance throughout a lot of my thesis work: collecting material throughout the lab, making orders, preparing fieldwork, sampling, filtering, freeze-drying, grinding, sieving. All this couldn't have been done without you. And you would even bring me soup when I was sick.

Gaël Guillou, Quentin Bernier, Laureen Beaugeard, Martine Bréret, thank you for your help during the lab analyses. Laureen, thank you for showing the ins and outs of flow cytometry, which enabled me to estimate bacteria abundances. Martine, thank you for your help during the sample preparation. Filtering liters of seawater, picking seagrass leaves and roots and analyzing chlorophyll *a* content, were all done with your help. Quentin Bernier, thank you for your help during the sample preparation of food sources for isotope analyses. This allowed me to focus on picking nematodes. You were a good intern and helped out a lot with the data collection and analyses. Finally, Gaël, thank you for your help with the isotope analyses. Your devotion in analyses isotope compositions was part of the main core of this thesis. The fact that you were able to estimate the isotope composition on ONE nematode, still strikes me.

– Many thanks to my friends, roommates, teammates and others that I spend my last three year with in La Rochelle, Bremerhaven and List auf Sylt –

Thanks to all my roommates and ex-roommates of the Villa Clovis, for listenings to me talk sort of “French”, watching movies, having beers, enjoying the BBQ, Saturday morning market and having parties till late in the morning. Thank you, Bertrand, François, Sophie, Mathilde, Helene, Juliette, Ion, Rasmus, Aurelie, Maxime, Amandine and Matias. Without the Villa I wouldn't have had the same nice time as I had over the last three years. I am very happy that I had the opportunity to move here and built these friendships with you all. And I will always have a nice memory on youtube to remember the carnivores, herbivores and chocolativores of Villa Clovis by.

Thank you as well to my former roommates in Bremerhaven, Sylke, Bea, Jonathan. I had a nice time in Bremerhaven, also thanks to you. I will most likely come back soon. Thank you, to the islanders of Sylt, Camille, Sabine, Marieke, Martin, Lasse, Jonas, Runne. I had a nice time on the isolated island of Sylt, mainly thanks to you. I enjoyed having beers and burgers at the Piratennest, fishbrötchen at Gosch, and drinking beers and BBQ'ing in the Pringsheim garden.

Thank you to all people that I met in La Rochelle. Alice, Pierre, Guillaume, Simon, Titi, Toto, Thomas, Greg, Cecile, Ben, Anthony, JR, Marine, Mathilde, Robin, Valerian, it was nice to enjoy the various activities in La Rochelle with you: surfing, drinking beers, watching movies, rugby matches, football games, trips, concerts... Also, thank you to the futsal team for letting me play football every

Tuesday afternoon, the footballers of Tuesday evening playing indoor and outdoor, and the third team of Cap AUNIS Lagord. Playing with you made it easier to clear my mind and enjoy the game of football in different settings.

– Many thanks to my friends and family back in the Netherlands –

Daan, Martijn en Maarten, thank you for the yearly weekends in La Rochelle, France. I was always lighting up when I knew you guys were arriving. The Eurovision songfestival, Mōlkky and games were standard material in these weekends. The appendicitis luckily only once... And I think we don't have to mention who is leading in the overall score of Mōlkky. Also, thank you also to all other friends in the Netherlands. Whenever I was back in the country you were there to have a beer with, play a game of football, watch a game of football, or do whatever was necessary to clear my mind and charge me again before going back to France. I will come back to the Netherlands soon to enjoy these activities with you on a more regular basis.

I am grateful to mom and dad, for your encouragements in everything I do, always pushing me and backing me up to pursue my dreams. This allowed me to go abroad, discover the world knowing that you would be there for me. I always appreciated your advice, listening to my worries, issues, and stories. You came to visit me in La Rochelle where I could show you what I was doing. You listened when I would tell about my results, discussion, and fieldwork. Going back to Hulsel, Netherlands and spending time together brought me the ease and the calm I needed to go through these three years of PhD. Thanks to my two sisters for being there at home. Although Kira, you are now on the other side of the world, we can still Skype or Facetime to let each other know what's going on. Lenne, it was always fun seeing you again back in the Netherlands. The dinners we had together in Eindhoven, Hulsel and Utrecht were always what I needed before I would go back to France.

– And finally, of course... –

And finally, of course, Emma, thank you for supporting me, listening to me, and backing me up on doing this. It was not always as easy and we had our tough moments living in different countries. But in the end, we are still here and that's what matters. We discovered together La Rochelle and the westcoast of France, the wine areas, the Banyonne festival, but also more exotic places like Malta, Montenegro and Colombia. And now, because we were already able to laugh together, enjoying food and drinks together, travel together, see movies together, go see friends together, argue together, work together, now we will finally live together. Thank you for being there.

Table of content

Foreword	I
Acknowledgements	V
Table of content	IX
List of figures	XIII
List of tables	XIX
List of appendices	XXI
List of abbreviations	XXV
<hr/>	
Chapter 1: General introduction	1
1. Context	3
1.1. Functioning of coastal ecosystems and role for human societies	3
1.2. Meiofauna and ecosystem processes	4
1.3. Current stakes about functioning of coastal ecosystems	5
2. Aims of the thesis	8
<hr/>	
Chapter 2: Meiofauna community structure and feeding ecology	13
1. Effect of abiotic and biotic factors on meiofauna community structure	15
1.1. Abiotic factors	16
1.2. Biotic factors	18
2. Meiofauna feeding ecology	20
2.1. Potential food sources	21
2.1.1. <i>Microphytobenthos</i>	21
2.1.2. <i>Phytoplankton</i>	22
2.1.3. <i>Vascular plant material</i>	22
2.1.4. <i>Bacteria</i>	23
2.2. Determination of meiofauna feeding ecology	23
2.2.1. <i>Buccal morphology of free-living marine nematodes</i>	23
2.2.2. <i>Bulk stable isotope analyses</i>	25
2.2.3. <i>Fatty acid analyses</i>	25
2.2.4. <i>Combining trophic marker analyses</i>	26
2.3. Food web models	30
2.3.1. <i>Stable isotope mixing models</i>	30
2.3.2. <i>Linear inverse modeling</i>	30
2.3.3. <i>Ecological network analyses</i>	31
<hr/>	
Chapter 3: How do food sources drive meiofauna community structure in soft-bottom coastal food webs?	33
Abstract	35
1. Introduction	36
2. Material and methods	38
2.1. Study sites	38
2.1.1. <i>Marennes-Oléron Bay</i>	38
2.1.2. <i>Sylt-Rømø Bight</i>	38
2.2. Field sampling and laboratory processes	38
2.2.1. <i>Sediment grain size</i>	39
2.2.2. <i>Benthic primary producers, composite food sources and bacteria</i>	39
2.2.3. <i>Suspended particulate organic matter</i>	40
2.2.4. <i>Meiofauna</i>	41
2.3. Data treatment and statistical methods	42
3. Results	43
3.1. Sediment grain size	43
3.2. Potential food sources	43
3.3. Meiofauna community structure	47
3.4. Nematode community structure	48
3.5. Relationship between environmental parameters and meiofauna trophic structure	51

4.	Discussion	55
4.1.	Habitat description	55
4.2.	Meiofauna community structure: spatial and temporal variations	56
4.3.	Benthic microalgae and sediment organic matter are important drivers of nematode community structure	57
4.4.	Role of bacteria as a food source?	60
4.5.	Effect of sediment depth on meiofauna: influence of oxic conditions	60
5.	Conclusion	62
Appendix: Chapter 3		63
Interchapter 3A: From biomass to trophic relationships		69
Chapter 4: Trophic importance of microphytobenthos and bacteria to meiofauna in soft-bottom intertidal habitats: a combined trophic marker approach.		73
Abstract		75
1.	Introduction	77
2.	Material and methods	78
2.1.	Study area	78
2.2.	Sampling and laboratory processing of benthic primary producers, composite food sources and meiofauna	79
2.2.1.	<i>Primary producers and composite food sources</i>	79
2.2.2.	<i>Meiofauna</i>	80
2.3.	Analytical procedure	80
2.3.1.	<i>Bulk stable isotope analyses</i>	80
2.3.2.	<i>Fatty acid analyses</i>	81
2.3.3.	<i>Compound specific isotope analyses of FA</i>	81
2.4.	Data treatment and statistical methods	82
2.4.1.	<i>Isotope data treatment</i>	82
2.4.2.	<i>FA data analyses</i>	82
2.4.3.	<i>Statistical methods</i>	83
3.	Results	84
3.1.	Primary producers	84
3.1.1.	<i>Isotope compositions</i>	84
3.1.2.	<i>Fatty acid profiles</i>	86
3.2.	Composite food sources	86
3.2.1.	<i>Isotope compositions</i>	86
3.2.2.	<i>Fatty acid compositions</i>	87
3.2.3.	<i>Isotope compositions of diatom and bacteria FA markers</i>	91
3.3.	Nematodes and benthic copepods and contributions of food sources	93
3.3.1.	<i>Isotope compositions</i>	93
3.3.2.	<i>Fatty acid compositions</i>	96
3.3.3.	<i>Isotope compositions of diatom and bacteria FA markers</i>	96
3.4.	Two-dimensional analysis on food sources and consumers using $\delta^{13}\text{C}$ values and FA compositions	98
4.	Discussion	103
4.1.	Distinction of microphytobenthos and seagrass material based on FA profiles	103
4.2.	Distinction of SPOM, SOM and primary producers based on bulk and FA isotope compositions	103
4.3.	Limited use of SPOM by nematodes and benthic copepods	105
4.4.	Limited use of seagrass material by nematodes and benthic copepods	105
4.5.	Importance of microphytobenthos and bacteria as food sources to nematodes and benthic copepods	106
4.6.	Usefulness of combining trophic markers and of FA marker ratios	108
5.	Conclusion	109
Appendix: Chapter 4		111

Interchapter 4A: From trophic relationships to energy flows	121
Chapter 5: Importance of microphytobenthos-meiofauna pathway in soft-bottom intertidal food webs leads to high production and transfer efficiency of meiofauna: A multi-habitat comparison using linear inverse food web modeling.	125
Abstract	128
1. Introduction	129
2. Material and methods	131
2.1. Study area	131
2.2. Stable isotope mixing models	131
2.3. Database and linear inverse model construction	132
2.4. Calculation of LIM solutions	135
2.5. Network analysis and statistical methods	135
3. Results	137
3.1. MixSIAR outputs	137
3.2. General characteristics of the food web models	137
3.3. Network analysis	142
3.4. Throughput and production of food sources	144
3.5. Meiofauna and macrofauna throughput and production	145
3.6. Transfer efficiency	146
3.7. Trophic levels and feeding types	149
4. Discussion	155
4.1. Comparisons of intertidal food webs	155
4.2. The effects of aggregating and splitting compartments	156
4.3. Central role of meiofauna in soft-bottom coastal food webs: high production	157
4.4. Central role of meiofauna in soft-bottom coastal food webs: trophic intermediary position	158
4.5. Reliance on microphytobenthos	159
4.6. Differences of food source reliance between meiofauna feeding types	159
4.7. Ecosystem functions provided by meiofauna	160
5. Conclusion	162
Appendix: Chapter 5	165
Chapter 6: General discussion	195
1. Major results of this thesis	197
1.1. Flows of organic matter from food sources to meiofauna	197
1.1.1. <i>Microphytobenthos as the main food source for meiofauna</i>	197
1.1.2. <i>Role of bacteria as a food source for meiofauna?</i>	200
1.1.3. <i>Fate of seagrass material and suspended particulate organic matter</i>	201
1.2. Role and fate of meiofauna in benthic food webs	202
1.2.1. <i>Meiofauna vs. macrofauna</i>	202
1.2.2. <i>Fate of meiofauna?</i>	203
2. Recommendations for future research	204
References	207
Curriculum vitea	233
Statement of originality	235
Summary / Résumé / Zusammenfassung	238

List of figures

Chapter 1

- Figure 1.1:** Conceptual diagram highlighting the relationship between meiofauna activities and ecosystems processes. These processes are linked to service flows that provided benefits for the socio-economic system, which can be also expressed in monetary or non-monetary values. After Schratzberger and Ingels (2017). **4**
- Figure 1.2a-d:** Conceptual diagrams illustrating meiofauna facilitated effects on **a)** sediment stability, **b)** nutrient cycling, **c)** waste removal and **d)** food web dynamics. Modified from Schratzberger and Ingels (2017). **7**
- Figure 1.3:** Conceptual diagram illustrating the influence of human and natural pressures on meiofauna community structure and the role of meiofauna in ecological processes and functions. The different observation scale (i.e., socio-ecosystem, ecosystem and habitat) are described on the left side of the diagram. To simplify the conceptual diagram, abiotic and biotic parameters are only illustrated for meiofauna. Chapters are referred to by colors as green refers to chapter 3, blue to chapter 4 and orange to chapter 5. **11**

Chapter 2

- Figure 2.1:** Conceptual diagram illustrating the abiotic and biotic parameters structuring meiofauna communities after Giere (2009). **16**
- Figure 2.2:** Conceptual diagram illustrating the effects of abiotic parameters on meiofauna community structure (i.e., biomass, abundance, biodiversity, characteristics species). **17**
- Figure 2.3:** Conceptual diagram illustrating the effects of biotic parameters on meiofauna community structure (i.e., biomass, abundance, biodiversity, characteristics species) and production. **19**
- Figure 2.4:** Trophic guilds of nematodes from different intertidal habitats based on buccal cavity morphology and related to sediment grain-size and organic content. After Giere (2009). **24**

Chapter 3

- Figure 3.1:** Sampling stations of the mudflats, seagrass beds and sandflat in the Marennes-Oléron Bay and the Sylt-Rømø Bight along the European coast. **39**
- Figure 3.2:** Ternary diagram presenting the sediment composition of the mudflats, seagrass beds and sandflat in the Marennes-Oléron Bay and the Sylt-Rømø Bight in spring and autumn. **43**
- Figure 3.3a-f:** Composition of potential benthic food sources for meiofauna and of meiofauna in the mudflats, seagrass beds and sandflat in the Marennes-Oléron Bay and the Sylt-Rømø Bight in spring and autumn. **a)** Hierarchical average cluster of dissimilarity for the proportional composition of potential food sources. **b)** Hierarchical average cluster of dissimilarity for proportional composition of meiofauna. Approximately unbiased probability values by multiscale bootstrap resampling are under each node and clusters are highlighted with gray rectangles. **c)** Proportional composition of potential food sources. **d)** Proportional composition of benthic copepods and trophic groups of nematodes. Trophic groups of genera with relative abundance > 5% are displayed. **e)** Biomass of potential food sources. **f)** Biomass of benthic copepods and trophic groups of nematodes. **46**
- Figure 3.4:** Proportional composition of meiofauna in the mudflats, seagrass beds and sandflat in the Marennes-Oléron Bay and the Sylt-Rømø Bight in spring and autumn and in both sediment layer (0-1 cm and 1-5 cm). **49**
- Figure 3.5a-b:** **a)** Principal component analyses for the environmental factors plotted for the mudflats, seagrass beds and sandflat in the Marennes-Oléron Bay and the Sylt-Rømø Bight in spring and autumn. **b)** Redundancy relationship analyses of environmental factors selected with stepwise forward procedure plotted against the different groups of meiofauna (benthic copepods, polychaetes, foraminifers, ostracods and trophic groups of nematodes) and the surface and sub-surface layers of the mudflats, seagrass beds and sandflat in the Marennes-Oléron Bay and the Sylt-Rømø Bight in spring and autumn. **53**
- Figure 3.6:** Relationship between the biomass of benthic microalgae and the ratio between densities of epigrowth feeders (2A) and densities of non-selective deposit feeders (1B) in the mudflats, seagrass beds and sandflat in the Marennes-Oléron Bay and the Sylt-Rømø Bight in spring and autumn. **54**

Figure 3.7: Relationship between the ratio of fresh organic material to detrital material and the relative abundance of selective deposit feeders (1A) in the mudflats, seagrass beds and sandflats in the Marennes-Oléron Bay and the Sylt-Rømø Bight in spring and autumn.	54
---	-----------

Interchapter 3A

Figure 3A.1: Conceptual diagram illustrating the important drivers of meiofauna community structure (biomass, diversity, and trophic structure).	70
---	-----------

Chapter 4

Figure 4.1: Sampling stations in mudflats, seagrass beds and sandflats in the Marennes-Oléron Bay and the Sylt-Rømø Bight along the European Atlantic coast.	78
Figure 4.2: Isotope compositions ($\delta^{13}\text{C}$ and $\delta^{15}\text{N}$) of food sources and nematodes and benthic copepods in the mudflats, seagrass beds and sandflat in the Marennes-Oléron Bay and Sylt-Rømø Bight in spring and autumn.	85
Figure 4.3: Fatty acid compositions of primary producers (i.e., microphytobenthos, seagrass leaves and roots, and detritus), in the mudflats, seagrass beds and sandflat in the Marennes-Oléron Bay and Sylt-Rømø Bight in spring and autumn.	88
Figure 4.4: Fatty acid compositions of composite food sources (i.e., suspended particulate organic matter and sediment organic matter), in the mudflats, seagrass beds and sandflat in the Marennes-Oléron Bay and Sylt-Rømø Bight in spring and autumn.	90
Figure 4.5: $\delta^{13}\text{C}$ values of fatty acids 20:5(<i>n</i> -3) (diatom FA marker) and 15:0 (bacteria FA marker) of potential food sources, nematodes and benthic copepods in the mudflats, seagrass beds and sandflat in the Marennes-Oléron Bay and Sylt-Rømø Bight.	92
Figure 4.6: Contributions (%) of bacteria, suspended particulate organic matter, sediment organic matter, microphytobenthos and fresh and detrital seagrass material as food sources for nematodes and benthic copepods provided by the stable isotope mixing model MixSIAR.	95

Figure 4.7: Fatty acids compositions of nematodes and benthic copepods in the mudflats, seagrass beds and sandflat in the Marennes-Oléron Bay and Sylt-Rømø Bight in spring and autumn.	97
Figure 4.8a-d: Mean $\delta^{13}\text{C}$ values and relative percentages of fatty acid trophic markers of food sources, nematodes and benthic copepods in the mudflats, seagrass beds and sandflat in the Marennes-Oléron Bay and Sylt-Rømø Bight. Data for surface (0 - 1 cm) and deep layers (4 - 5 cm) are displayed for nematodes. FAs were classified according to their trophic marker groups: a) diatoms, b) bacteria, c) vascular plants, and d) flagellates (see table 1).	100
Figure 4.9: Ratios of diatom vs. vascular plant fatty acid markers and of diatom vs. bacteria FA markers of potential food sources, nematodes and benthic copepods in the mudflats, seagrass beds and sandflat in the Marennes-Oléron Bay and Sylt-Rømø Bight.	102

Interchapter 4A

Figure 4A.1: Conceptual diagram of trophic relationships between food sources and meiofauna based on isotope composition and fatty acid profiles.	122
Figure 4A.2: Conceptual diagram of trophic relationships between food sources and meiofauna based on isotope composition and fatty acid profiles.	123

Chapter 5

Figure 5.1: Study sites in the mudflats, seagrass beds and sandflat in the Marennes-Oléron Bay (MO) and the Sylt-Rømø Bight (SR) along the European Atlantic coast.	132
Figure 5.2: Food webs of the mudflat and seagrass bed in the Marennes-Oléron Bay obtained by linear inverse modeling.	138
Figure 5.3: Food webs of the mudflat and seagrass bed in the Sylt-Rømø Bight obtained by linear inverse modeling.	140
Figure 5.4: Food of the sandflat in the Sylt-Rømø Bight web obtained by linear inverse modeling.	142

Figure 5.5: Ecological network analysis indices: total system throughput, Finn cycling index, relative redundancy, and system omnivory index for the mudflats, seagrass beds and sandflat in the Marennes-Oléron Bay and the Sylt-Rømø Bight.	143
Figure 5.6: Throughput, production, throughput/biomass ratios and production/biomass ratios of meiofauna and macrofauna from the mudflats, seagrass beds and sandflat in the Marennes-Oléron Bay and the Sylt-Rømø Bight.	146
Figure 5.7: Modified Lindeman spine describing food webs of the mudflats, seagrass beds, and sandflat in the Marennes-Oléron Bay and the Sylt-Rømø Bight.	148
Figure 5.8: Transfer efficiencies of meiofauna and macrofauna of the mudflats, seagrass beds, and sandflat in the Marennes-Oléron Bay and the Sylt-Rømø Bight.	149
Figure 5.9: Flows of carbon from food source to meiofauna and macrofauna in the mudflats, seagrass beds, and sandflat in the Marennes-Oléron Bay and the Sylt-Rømø Bight.	152
Figure 5.10: Flows of carbon from food source to selective deposit feeding nematodes, non-selective deposit feeding nematodes, epigrowth feeding nematodes, benthic copepods and omnivorous/predating nematodes in the mudflats, seagrass beds, and sandflat in the Marennes-Oléron Bay and the Sylt-Rømø Bight.	154

Chapter 6

Figure 6.1: Conceptual diagram illustrating the influence of human and natural pressures on meiofauna community structure and the role of meiofauna in ecological processes and functions. The different observation scale (i.e., socio-ecosystem, ecosystem and habitat) are described on the left side of the diagram. To simplify the conceptual diagram, abiotic and biotic parameters are only illustrated for meiofauna. Compartments and connections studied in the different chapters to address the questions of this thesis are colored in green (Chapter 3), blue (Chapter 4) and orange (Chapter 5). Main conclusions of this thesis are highlighted in the colored boxes, with summarizing conclusions of chapters 3, 4, and 5, in green, blue and orange, respectively.	199
---	------------

List of tables

Chapter 2

Table 2.1: Synthesis of the main advantages and drawbacks of several methods used in determining feeding behavior. Assessment of the methods in accordance with 12 variables: price, investment, scale (i.e., micro, small, and large), organisation level (i.e., individual, population, community, and ecosystem), ecological question (i.e., interaction, flux) and data type (qualitative or quantitative). Modified from Majdi et al. (2018).	29
---	-----------

Chapter 3

Table 3.1: Carbon: chlorophyll <i>a</i> ratios and percentage of carbon originating from fresh microalgae in sediment organic matter in the mudflats, seagrass beds and sandflat in the Marennes-Oléron Bay and the Sylt-Rømø Bight in spring and autumn.	45
Table 3.2: Results of the two-way ANOVA for differences in total meiofauna, nematode, and benthic copepod density and nematode and benthic copepod biomass across habitats and seasons.	48
Table 3.3: Number of nematode genera, Hill's diversity, and species evenness in the mudflats, seagrass beds and sandflat in the Marennes-Oléron Bay and the Sylt-Rømø Bight in spring and autumn.	50
Table 3.4: Results of the two-way ANOVA for differences in species richness, Hill's diversity, and species evenness between habitats, sediment layers and season in the mudflats, seagrass beds and sandflat in the Marennes-Oléron Bay and the Sylt-Rømø Bight.	50
Table 3.5: Density and biomass of nematodes and benthic copepods in mudflats, seagrass beds and sandflats from this study and from the available literature about marine soft-bottom intertidal systems.	58

Chapter 4

Table 4.1: Fatty acids and ratios used as trophic markers in the mudflats, seagrass beds and sandflat in the Marennes-Oléron Bay and Sylt-Rømø Bight food webs.	83
--	-----------

Chapter 5

Table 5.1: Biomass and abbreviations of compartments used in the food web models of the mudflats, seagrass beds and sandflats in the Marennes-Oléron Bay and the Sylt-Rømø Bight.	134
Table 5.2: Production and production/biomass ratios of microphytobenthos, phytoplankton, seagrass and bacteria in the mudflats, seagrass beds, and sandflat in the Marennes-Oléron Bay and the Sylt-Rømø Bight.	145
Table 5.3: Mean trophic levels and omnivory indices for trophic groups of nematodes and benthic copepods and detritivory/herbivory and bacterivory/herbivory ratios for meiofauna in the mudflats, seagrass beds, and sandflat in the Marennes-Oléron Bay (MO) and the Sylt-Rømø Bight (SR).	150

List of appendices

Chapter 3

- Appendix 3.1:** Biomass for nematodes, copepods, and selected nematode families/genera from the mudflats, seagrass beds and sandflat in the Marennes-Oléron Bay and the Sylt-Rømø Bight in spring and autumn. **64**
- Appendix 3.2:** Equations of Hill's diversity and species evenness, where p_i is the ratio of the count of the i^{th} species to the total number of individuals in the sample and S is the species number (Hill 1973). **65**
- Appendix 3.3:** Median sediment grain size and 90% quantile of the mudflats, seagrass beds and sandflat in the Marennes-Oléron Bay (MO) and the Sylt-Rømø Bight (SR) in spring and autumn for surface (0 – 1 cm) and sub-surface (1 – 5 cm) layers. **65**
- Appendix 3.4:** Suspended particulate organic matter at the different sampling stations in the Marennes-Oléron Bay (I-II) and the Sylt-Rømø Bight (III-V) in spring and autumn. **66**
- Appendix 3.5:** Abundances of meiofauna, nematodes and benthic copepods in the top 5 cm of the mudflats, seagrass beds and sandflat in the Marennes-Oléron Bay and the Sylt-Rømø Bight in spring and autumn. **66**
- Appendix 3.6:** Most dominant nematode genera and corresponding feeding types in the mudflats, seagrass beds and sandflat in the Marennes-Oléron Bay (MO) and the Sylt-Rømø Bight in spring and autumn for surface (0 – 1 cm) and sub-surface (1 – 5 cm) layers. **67**

Chapter 4

- Appendix 4.1:** Isotope compositions of potential food sources, nematodes and benthic copepods. Comparisons of $\delta^{13}\text{C}$ and $\delta^{15}\text{N}$ values between spring and autumn in the mudflats, seagrass beds and sandflat in the Marennes-Oléron Bay and Sylt-Rømø Bight. **112**

Appendix 4.2: Isotope compositions of sediment organic matter, detritus and nematodes per sediment layer.	113
Appendix 4.3: $\delta^{13}\text{C}$ values of food sources in the mudflats, seagrass beds and sandflat in the Marennes-Oléron Bay and Sylt-Rømø Bight.	114
Appendix 4.4: Mean $\delta^{13}\text{C}$ values of food sources in the mudflats, seagrass beds and sandflat in the Marennes-Oléron Bay and Sylt-Rømø Bight.	115
Appendix 4.5: Fatty acid compositions of primary producers and composite sources in the mudflats, seagrass beds and sandflat in the Marennes-Oléron Bay and Sylt-Rømø Bight in spring and autumn.	116
Appendix 4.6: Proportional contributions of bacteria, suspended particulate organic matter, sediment organic matter and microphytobenthos as food sources for benthic copepods and nematodes in the mudflats, seagrass beds and sandflat in the Marennes-Oléron Bay and Sylt-Rømø Bight.	118
Appendix 4.7: Fatty acid compositions of nematodes and benthic copepods in the mudflats, seagrass beds and sandflat in the Marennes-Oléron Bay and Sylt-Rømø Bight in spring and autumn.	119

Chapter 5

Appendix 5.1: Equations used for the linear inverse modeling of the mudflat in the Marennes-Oléron Bay, France, from Leguerrier et al. (2003).	166
Appendix 5.2: Inequalities used for the linear inverse modeling of the mudflat in the Marennes-Oléron Bay, France.	167
Appendix 5.3: Inequalities used for the linear inverse modeling of the seagrass bed in the Marennes-Oléron Bay, France.	169
Appendix 5.4: Inequalities used for the linear inverse modelling of the sandflat in the Sylt-Rømø Bight, Germany.	173
Appendix 5.5: Inequalities used in the linear inverse modelling of the mudflat in Sylt-Rømø Bight, Germany.	176

Appendix 5.6. Inequalities used in the linear inverse modelling of the seagrass bed in the Sylt-Rømø Bight, Germany.	179
Appendix 5.7. Formulas of the ecological network analysis indices. Calculations start from the balanced matrix T with n flows, with source compartments in rows and sink compartments in columns.	182
Appendix 5.8. MixSIAR derived dietary contributions for meiofauna in the mudflats, seagrass beds and sandflat in the Marennes-Oléron Bay and Sylt-Rømø Bight.	183
Appendix 5.9. Estimated flows in the food webs of the mudflats, seagrass beds and sandflat in the Marennes-Oléron Bay and Sylt-Rømø Bight.	184
Appendix 5.10. Statistical comparison of ecological network analysis indices between the mudflats, seagrass beds and sandflat in the Marennes-Oléron Bay and Sylt-Rømø Bight using Cliff's delta statistic.	188
Appendix 5.11. Mean trophic levels, export dependency, detritivory/herbivory and bacterivory/herbivory ratios of the food web in the mudflats, seagrass beds, and sandflat in the Marennes-Oléron Bay and the Sylt-Rømø Bight.	189
Appendix 5.12. Production and production/biomass ratios of meiofauna and macrofauna trophic groups and total meiofauna and total macrofauna in the mudflats, seagrass beds, and sandflat in the Marennes-Oléron Bay and the Sylt-Rømø Bight.	190
Appendix 5.13. Transfer efficiency of benthic copepods and trophic groups of nematodes in the mudflats, seagrass beds, and sandflat in the Marennes-Oléron Bay and the Sylt-Rømø Bight.	190
Appendix 5.14. Detritivory/herbivory, bacterivory/herbivory and bacterivory/detritivory ratios for macrofauna in the mudflats, seagrass beds, and sandflat in the Marennes-Oléron Bay and the Sylt-Rømø Bight.	191
Appendix 5.15. Dependency ratios of meiofauna (benthic copepods and trophic groups of nematodes) on food web compartments in the mudflats, seagrass beds and sandflat in the Marennes-Oléron Bay and Sylt-Rømø Bight.	191
Appendix 5.16. Dependency ratios of macrofauna (benthic grazers, benthic deposit feeders, suspension feeders and benthic omnivores) on food web compartments in the mudflats, seagrass beds and sandflat in the Marennes-Oléron Bay and Sylt-Rømø Bight.	192

List of abbreviation

a-iso	anteiso	MZO	Micro-zooplankton
BAC	Bacteria	N_1	Hill's diversity
B/D	Bacterivory/detritivory ratio	NBA/1A	Nematodes – selective deposit feeders
B/H	Bacterivory/herbivory ratio	NDF/1B	Nematodes – non-selective deposit feeders
BBA	Benthic bacteria	NEF/2A	Nematodes – epigrowth feeders
BDF	Macrofauna – Benthic deposit feeders	NOM/2B	Nematodes – omnivores/predators
BFI	Benthic fish	<i>Odo</i>	<i>Odontophora</i>
BGR	Macrofauna – Benthic grazers	PBA	Pelagic bacteria
BOM	Macrofauna – Benthic omnivorous	PCA	Principal Components Analysis
C:chl <i>a</i>	Carbon: chlorophyll <i>a</i> ratio	PHY	Phytoplankton
CBR	Carnivorous birds	<i>Pra</i>	<i>Praecanthochus</i>
<i>Chr</i>	<i>Chromadora</i>	<i>Pty</i>	<i>Ptycholaimellus</i>
<i>Com</i>	<i>Comesa</i>	R	Seagrass roots
COP	Benthic copepods	R/C	Relative redundancy
CSIA	Compound specific isotope analyses	RDA	Redundancy relationship analysis
<i>Cta</i>	<i>Chromadorita</i>	<i>Sab</i>	<i>Sabatieria</i>
D/H	Detritivory/herbivory ratio	SI	Stable isotope
<i>Dap</i>	<i>Daptonema</i>	SOI	System omnivory index
DET	Detrital material	SOM	Sediment organic matter
DOC	Dissolved organic matter	SOMLIT	Service d'Observation en Milieu Littoral
<i>Ele</i>	<i>Eleutherolaimus</i>	<i>Spha</i>	<i>Sphaerolaimus</i>
<i>Eno</i>	<i>Enoplolaimus</i>	<i>Spi</i>	<i>Spirinia</i>
FA	Fatty acids	SPOM	Suspended particulate organic matter
FCI	Finn cycling index	SR	Sylt-Rømø Bight
GPP	Growth primary production	SUS	Macrofauna – Suspension feeders
HBR	Herbivorous birds	T..	Total system throughput
i	iso	TE	Trophic efficiency
<i>J'</i>	Species evenness	<i>Ter</i>	<i>Terschellingia</i>
L	Seagrass leaves	<i>The</i>	<i>Theristus</i>
LIM-	Linear inverse model – Markov chain	TL	Trophic level
MCMC	Monte Carlo	TST	Total system through-flow
<i>Met</i>	<i>Metachromadora</i>	<i>Vis</i>	<i>Viscosia</i>
<i>Mic</i>	<i>Microlaimus</i>	ZOO	Meso-zooplankton
MO	Marenes-Oléron Bay	ZOS	<i>Zostera noltei</i> material
<i>Mon</i>	<i>Monoposthia</i>		
MPB	Microphytobenthos		

CHAPTER 1

General introduction

“Life originated in the sea, and about eighty percent of it is still there”

Isaac Asimov

1. GENERAL BACKGROUND

1.1. Functioning of coastal ecosystems and role for human societies

Coastal ecosystems, at the interface between land and sea on Earth, are made of a high diversity of habitats, connected with each other by flows of energy and organic matter, and support diverse communities (Burke et al. 2001). Coastal ecosystems are characterized high productivities (Reed 1990; MacIntyre et al. 1996; Duarte and Chiscano 1999; Underwood and Kromkamp 1999; Hemminga and Duarte 2000; Simas et al. 2001; McLusky and Elliott 2004) related to the massive inputs of terrestrial organic matter and nutrients they receive and the high amounts of material and energy they exchange with the open ocean (Gattuso et al. 1998; Gazeau et al. 2004).

Benthic habitats are important ecological components of the coastal areas in relation to their shallow depths and the high benthic-pelagic coupling (Day et al. 1989; Alongi 1998). Soft-bottom benthic habitats host a wide diversity of biota (i.e., plants and animals) that inhabit the marine sediments and play important roles in coastal ecosystem processes (Snelgrove 1997): e.g. direct or indirect nutrient cycling (Romero et al. 2006), food web dynamics (Lavelle et al. 2005), production and transport of organic matter and oxygen (Alongi 1998), carbon sequestration (Barbier et al. 2011), restructuring of sediment, i.e., bioturbation (Kristensen et al. 2012). Such ecosystem processes provide ecological functions, which are essential in the functioning of coastal socio-ecosystems and to human societies (Snelgrove 1999). As a result, human societies benefit from ecological functions provided by coastal ecosystems (Millennium Ecosystem Assessment 2005): exploitation (e.g. food, biofuels, leisure activities), regulation (e.g. waste treatment, nutrient cycling) (Schratzberger and Ingels 2017), nurseries and feeding grounds for fish and shore birds (Coull 1990; Asmus and Asmus 2000; Hemminga and Duarte 2000; Simas et al. 2001), coastal protection (Koch et al. 2009; Barbier et al. 2011). These ecological functions are often related to the presence of particular species (e.g. engineer species), functional groups (e.g. feeding groups) or habitat types (Prather et al. 2013). Meiofauna, a very diverse and highly productive group of fauna, contribute to these ecosystem processes and thus to this provision of ecological functions (Fig. 1.1.) but are, due to their small size, often poorly studied (Giere, 2009) and/or taken into account.

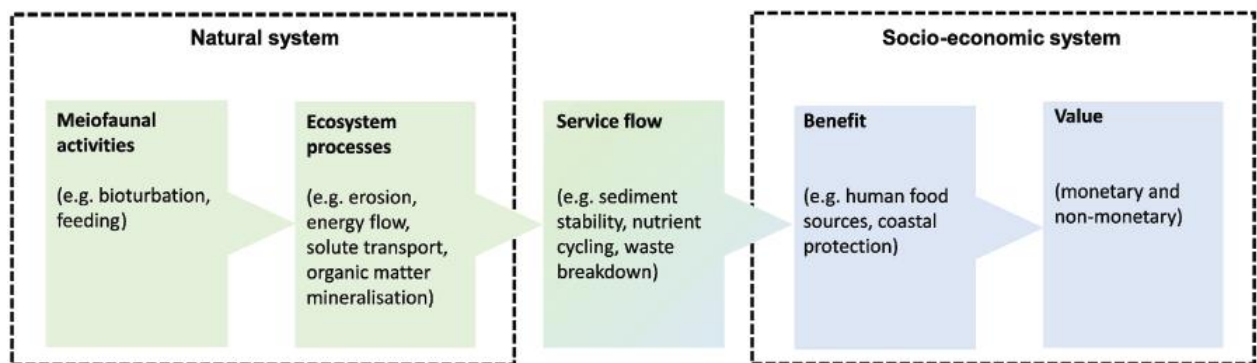

Figure 1.1. Conceptual diagram highlighting the relationship between meiofauna activities and ecosystems processes. These processes are linked to service flows that provided benefits for the socio-economic system, which can be also expressed in monetary or non-monetary values. After Schratzberger and Ingels (2017).

1.2. Meiofauna and ecosystem processes

The contribution of meiofauna to ecological functions ranges from stabilization of the sediment to nutrient cycling, including as well breakdown of pollutants and participation into food web dynamics (Fig. 1.2, Schratzberger & Ingels (2017)). Meiofauna are known to affect sediment processes (Fig. 1.2a) via bioturbation (Cullen 1973; Reichelt 1991; Fenchel 1996; Jensen 1996) and grazing on microphytobenthos (de Deckere et al., 2001; Moens et al., 2002), leading to a destabilization of the sediment due to biofilm disruption. Meiofauna directly affect nutrient cycling in the sediment (Fig. 1.2b) via bioturbation as it enhances the diffusion of solutes (Schratzberger and Ingels 2017). Meiofauna also indirectly affect nutrient cycling via its effect on microfauna. Microfauna is indeed playing a strong role in nutrient cycling and its distribution is strongly related to meiofauna grazing pressures (Montagna 1984; de Mesel et al. 2004; Nascimento et al. 2012). Meiofauna are also involved in waste removal and contaminant breakdown (Fig. 1.2c) by bioturbation (Bradshaw et al. 2006), grazing (Näslund et al. 2010; Louati et al. 2013) and accumulation of contaminants in their tissues (Monserrat et al. 2003). Meiofauna play also a very important role in food web dynamics: they have an intermediate position in the food web as they rely on primary producers (Rzeznik-Orignac et al. 2008; Leduc et al. 2009) as well as bacteria (Pascal et al. 2008; Vafeiadou et al. 2014) and transfer energy towards higher trophic levels (Coull 1999). As a result, meiofauna are a strong ecological agent. However, contributions of meiofauna to energy flows (i.e., consumption, production, respiration, egestion) within benthic food webs as well as their role in food web dynamics remains under debate (Fig. 1.2d) (Schratzberger and Ingels 2017). This role is even more complex to apprehend in soft-bottom coastal ecosystems due to their very complex functioning, as well as the large spatio-temporal variations occurring in these systems.

Soft-bottom coastal habitats are characterized by a relatively large diversity of food sources (i.e., seagrass, micro- and macroalgae, phytoplankton, bacteria), following spatial and temporal

variations (Gazeau et al. 2004), supporting complex and dynamic food webs (Boschker and Middelburg 2002; Baird et al. 2004b). Energy flows within soft-bottom intertidal food webs are mainly controlled by the production rate of microphytobenthos (Middelburg et al. 2000; Pinckney et al. 2003; van Oevelen et al. 2006) and the transfer of the produced carbon within the coastal food web via meiofauna (Montagna et al. 1995) and macrofauna (Kang et al. 2003, 2015; Haubois et al. 2005a). Microphytobenthos dominates primary production in soft-bottom intertidal habitats (Asmus and Asmus 1985; Daehnick et al. 1992; MacIntyre et al. 1996; Underwood and Kromkamp 1999; Kaldy et al. 2002; McLusky and Elliott 2004) and is an important food source for benthic herbivores (Herman et al. 1999, 2000; Lebreton et al. 2011b). Meiofauna are connected to microorganisms in the food web via the consumption of microalgae and bacteria (Moens and Vincx 1997b; Pascal et al. 2008; Rzeznik-Orignac et al. 2008; Giere 2009) and to the food webs of macroconsumers especially via its consumption by predatory invertebrates and small benthic fish (Gee 1989; Coull 1999; Hyndes and Lavery 2005). Meiofauna transfer material towards higher trophic levels (Coull 1990) and are an important factor in food web functioning because of their intermediate trophic position (Leguerrier et al. 2003; Giere 2009), high turn-over rate (Kuipers et al. 1981) and high secondary production (from 4 to 29 g C m⁻² year⁻¹) (Warwick et al. 1979; Escaravage et al. 1989; Chardy and Dauvin 1992; Danovaro et al. 2002b) often exceeding that of macrofauna (Giere 2009).

1.3. Current stakes about functioning of coastal ecosystems

Anthropogenic activities, global change and natural evolution of shorelines are affecting the geomorphology of coastal ecosystems (Davis & Fitzgerald 2004, Orth et al. 2006, Halpern et al. 2008, Waycott et al. 2009) as well as exert increasing pressures on the functioning of these systems. Continuous exploitations of coastal ecosystems leads to loss of habitats (Davis and Fitzgerald 2004; Orth et al. 2006) and negatively affects the stability and resilience of coastal areas (Lotze et al. 2006). For example, oyster farming increase the trapping of fine sediment close to oyster farming areas in the Marennes-Oléron bay (Sornin et al. 1983; Nugues et al. 1996; Mallet et al. 2006). In the bay of Sylt-Rømø, sand bank movements, due to tidal currents, regularly change the morphology of the Bay (Dolch and Hass 2008), leading to the disappearance of seagrass beds (Dolch and Reise 2010). Additionally, in soft-bottom ecosystems, geomorphological changes of coastal embayments also affect the structure of benthic microalgae assemblages, as these depend on sediment grain size (van de Koppel et al. 2001; Ubertini et al. 2015). Changes in availability, quantity and quality of food sources (e.g. microalgae, fresh or detrital seagrass material) therefore might alter meiofauna communities in terms of biomass, productivity and trophic positions. As a result, these geomorphological changes probably affect the role of meiofauna in the functioning of intertidal food webs (Schratzberger and Ingels 2017) and the ecosystem functions they provide (Eriksson et al. 2010). **There is therefore a need to better understand the role of meiofauna communities in the functioning of soft-bottom coastal**

ecosystems and to define how this role is changing when abiotic and biotic factors are modified, in order to better predict how ecological functions provided by meiofauna can be altered.

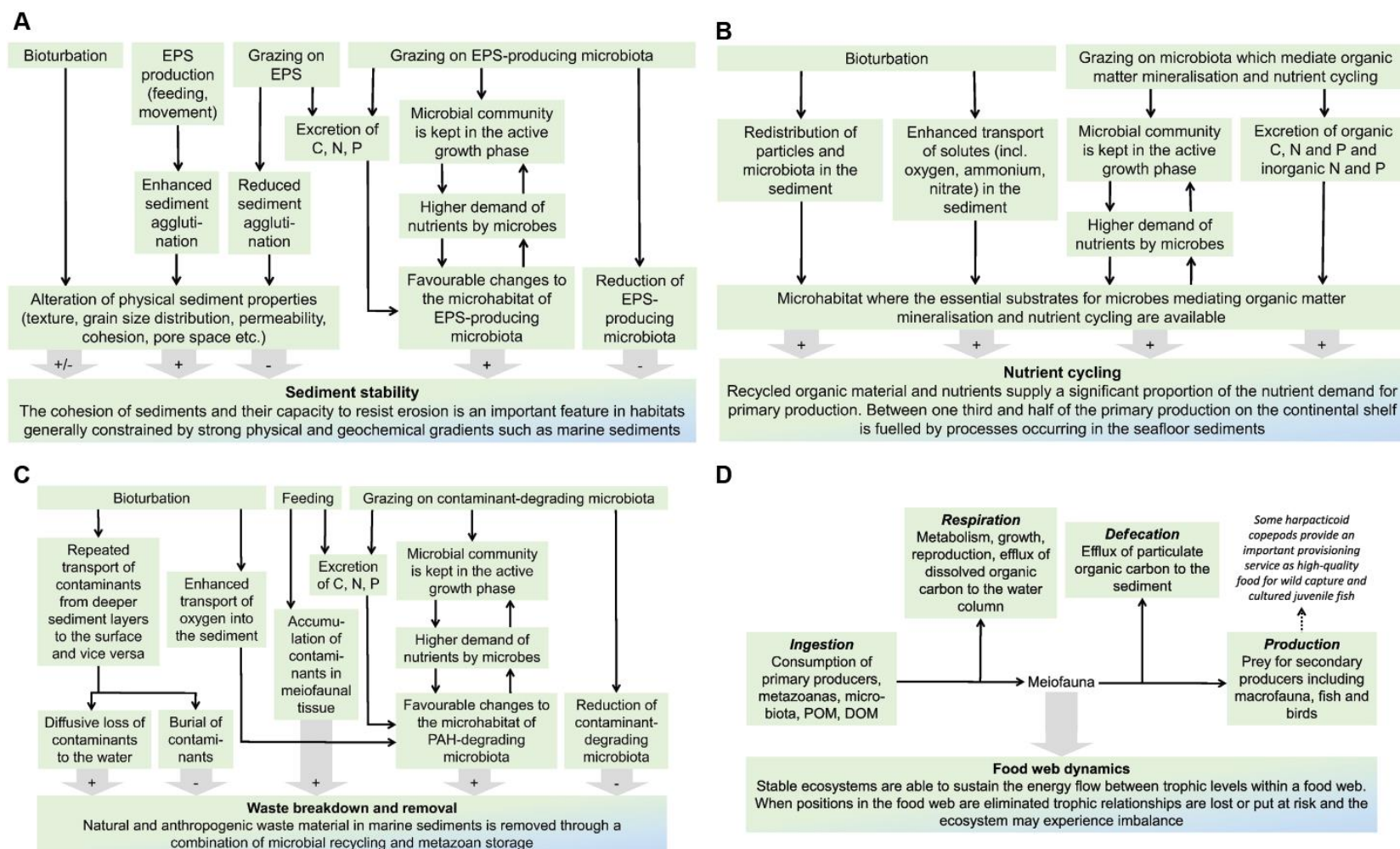

Figure 1.2a-d. Conceptual diagrams illustrating meiofauna-facilitated effects on **a)** sediment stability, **b)** nutrient cycling, **c)** waste removal and **d)** food web dynamics. C = carbon, DOM = dissolved organic matter, EPS = extracellular polymeric substances, N = nitrogen, P = phosphorous, PAH = polycyclic aromatic hydrocarbon, POM = particulate organic matter, + = stabilizing/stimulating effect, - = destabilizing/inhibitory effect. Modified from Schratzberger and Ingels (2017).

2. AIMS OF THE THESIS

The general aim of this thesis is to better understand the role of the meiofauna in food webs of soft-bottom habitats and, more precisely, to determine the major trophic resources of meiofauna in these habitats in relation to availability of these food sources. The potential differences in food web structure and functioning depending on food source availability will be determined using habitat comparisons (three different habitats from two ecosystems). Such an approach based on habitat comparisons will be used to define how changes in habitat structure can affect the functioning of these food webs. In this aim, several habitats (i.e., bare mudflats, seagrass beds and a sandflat) and ecosystems (i.e., Marennes-Oléron Bay, Sylt-Rømø Bight) were selected so the functioning of food webs could be compared depending on several gradients of potential food sources:

- **From systems with high loads of detrital matter (i.e., seagrass beds) to systems mostly dominated by fresh material (i.e., sandflat).** Seagrass are highly productive but most of the organic matter which is produced is exported or stored as detritus into the sediment (Mateo et al. 2006), thus representing a high load of detrital matter available to consumers. Contrarily, sandflats are generally characterized by low organic matter content into the sediment (Bergamaschi et al. 1997), likely due to hydrodynamics.
- **From systems dominated by epipellic diatoms (i.e., mudflats) to systems dominated by epipsammic diatoms (i.e., sandflats).** Benthic microalgae communities of intertidal bare mudflats are dominated by epipellic microalgae (Round 1971; Yallop et al. 1994; Thornton et al. 2002). These diatoms migrate towards the surface of the sediment at every diurnal low tide and create biofilms at the sediment surface (Blanchard et al. 2001). These biofilms represent a high concentration of food resources of high quality at the sediment surface. Benthic microalgae communities of intertidal bare sandflats are dominated by epipsammic microalgae (Asmus and Bauerfeind 1994). These diatoms attach to sediment grains and are therefore non- or very poorly motile (Round 1971). Such food resources are of high quality but are less available at the sediment surface as they are distributed within the first millimeters of the sediment (Méléder et al. 2005).
- **From systems largely influenced by inputs of estuarine and terrestrial organic matter (i.e., Marennes-Oléron Bay systems) to systems mostly influenced by oceanic inputs (i.e., Sylt-Romo Bight).** The Marennes-Oléron Bay receives continental inputs of organic matter from the Charente River (Riera et al. 1996), while the Sylt-Rømø Bight is without any large direct tributary (Asmus 2011).

In total, five food webs from different habitats will be described and compared: a bare mudflat and a seagrass bed in the Marennes-Oléron Bay, a bare mudflat, a sandflat and a seagrass bed in the Sylt-Rømø Bight. The description of these food webs will be carried out following a holistic way and using a combination of different approaches (community structure assessment, use of trophic markers, construction of food web models) so that the role of the meiofauna will be assessed in the framework of the whole system functioning, considering the other compartments and flows of organic matter. Each approach developed during this project corresponds to a chapter of this thesis. The combination of these chapters allows the reader to have a better understanding of the role of the meiofauna in soft-bottom coastal ecosystem food webs, and to determine how flows of organic matter change when habitat properties (particularly food resources) change. Before this, a first chapter will provide the reader the major information requested to well understand this thesis, in terms of scientific and methodological knowledge.

As stated before, **the aim of chapter two will be to provide some general background information about the role of meiofauna in the functioning of coastal ecosystems**, about how biotic and abiotic factors affect the meiofauna community structure. As this thesis is about food resources used by meiofauna, this chapter will also provide some information about feeding ecology of meiofauna, and more particularly about nematode trophic groups, about potential food sources meiofauna is relying on, and about the methods to determine the food resources used by these consumers. Due to the large range of knowledge and methods this thesis refers to, the aim of this chapter is not to provide exhaustive information, but to give the reader the major information needed for a good understanding of this manuscript. The references of the major publications are cited in this chapter so the reader can refer to these studies to get complementary information.

The third chapter describes the temporal and spatial variation of both food sources and meiobenthic assemblages in the five studied habitats (Fig. 1.3: indicated in green). The aim is to determine how food sources drive meiofauna community structure in soft-bottom intertidal food webs. Habitat comparison is carried out to reveal the effects of changes in availability, quality and quantity of food sources on meiofauna communities, with a particular focus on nematodes and benthic copepods. The relationships between different trophic groups of meiofauna and their food sources are described based on species composition of meiobenthos.

The fourth chapter describes the food resource uses by the two major groups of meiofauna, nematodes and benthic copepods in the five habitats, using trophic markers (Fig. 1.3: indicated in blue). These trophic markers are bulk stable isotope compositions (carbon and nitrogen), fatty acid profiles and compound-specific stable isotope compositions of fatty acids. Stable isotope compositions are useful in describing trophic relationships, however, they might be misleading in

complex systems, due to overlapping isotope compositions of food sources. Thus, additional information is required to discriminate some food sources in the form of fatty acid profiles (Sargent and Whittle 1981; Dalsgaard et al. 2003; Parrish 2013) and compound-specific isotope compositions of fatty acids (Boschker and Middelburg 2002; Bouillon and Boschker 2006; Middelburg 2014). The combination of bulk- and compound-specific stable isotope compositions and fatty acid profiles are effective for a good understanding of the functioning of complex food webs (Kharlamenko et al. 2001; Nyssen et al. 2005; Jaschinski et al. 2008; Leduc et al. 2009; Lebreton et al. 2011b; Braeckman et al. 2015).

In the fifth chapter, the role of the meiofauna in soft-bottom intertidal coastal food webs is determined (Fig. 1.3: indicated in orange) based on the integration of the new information from chapters three and four into food web models. The outputs of these food web models (i.e., one model per habitat) are compared to determine whether the feeding strategies of meiofauna depend on the availability of food sources. The food web models used in this chapter are built using previous ones describing the food web functioning in habitats of the Marennes-Oléron Bay and of the Sylt-Rømø Bight (Leguerrier et al. 2003, 2007, Baird et al. 2004b, 2007, 2012; Degré et al. 2006; Pacella et al. 2013; de la Vega et al. 2018b).

As stated before, chapters three, four and five provide some complementary information in order to give the reader a global understanding of the role of meiofauna in soft-bottom ecosystems. **In a general discussion, the main information from these different approaches is gathered to provide the reader an overview of the results from the systematic approach carried out in this thesis.** A section of this general discussion is also dedicated to scientific questions raised in this thesis and provides some recommendations about the future research which should be carried out to address these questions.

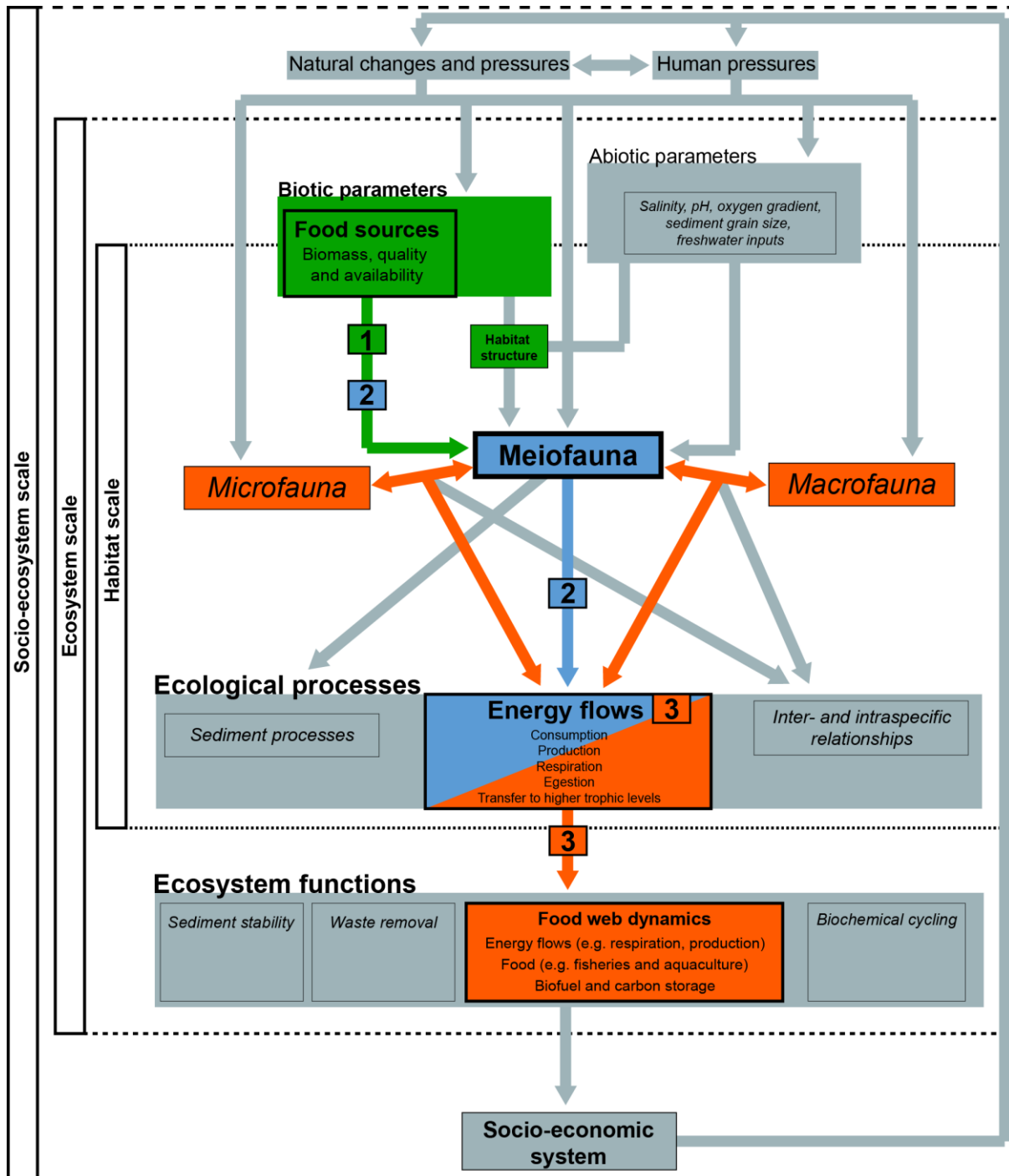

Figure 1.3. Conceptual diagram illustrating the influence of human and natural pressures on meiofauna community structure and the role of meiofauna in ecological processes and functions. The different observation scale (i.e., socio-ecosystem, ecosystem and habitat) are described on the left side of the diagram. To simplify the conceptual diagram, abiotic and biotic parameters are only illustrated for meiofauna. Chapters are referred to by colors as green refers to chapter 3, blue to chapter 4 and orange to chapter 5.

CHAPTER 2

Background and methodology

**Meiofauna community structure and feeding
ecology:**
Background and methodology

1. EFFECTS OF ABIOTIC AND BIOTIC FACTORS ON MEIOFAUNA COMMUNITY STRUCTURE

Meiofauna consist of microscopically small, motile aquatic animals (size ranging from 44 to 500 μm) occurring in and on soft substrates of both marine and freshwater ecosystems (Giere, 2009). Meiofauna are known for their high abundance within coastal ecosystems but their role within these complex ecosystems remains poorly understood (Rzeznik-Orignac et al. 2008; Lebreton et al. 2012). Nematodes generally dominate meiofauna communities in coastal intertidal ecosystems (Heip et al. 1985), often followed by benthic copepods as the second most abundant group (Hicks and Coull 1983). Nematodes, occurring from polar- to tropical regions and from sandy beaches to deep-sea sediments (Giere 2009). Their abundance is very high in intertidal soft-bottom coastal ecosystems, however this abundance can be quite variable (10^5 to 10^8 ind. m^{-2} ; Heip et al. 1985, Soetaert et al. 1995). Benthic copepods typically occur in habitats with medium-to-fine sand, where their abundance can be slightly higher than those of nematodes (Giere 2009). Other groups of meiofauna, such as foraminifera, ostracods, and polychaetes, are generally less abundant in soft-bottom intertidal habitats (Giere 2009). Distribution of meiofauna is regulated by complex interactions with biotic and abiotic factors (Fig. 2.1), which will be detailed in the following sections.

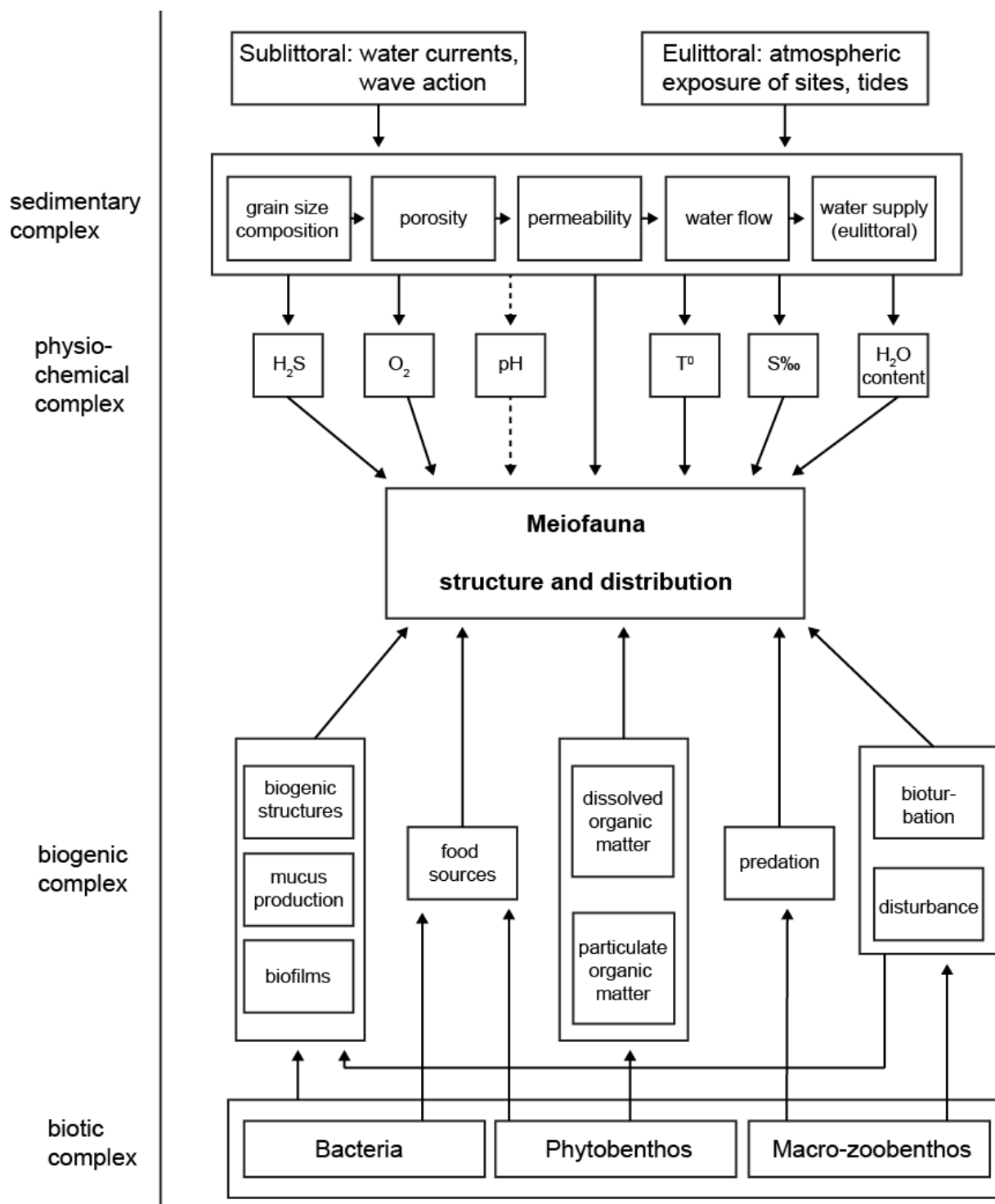

Figure 2.1. Conceptual diagram illustrating the abiotic and biotic parameters structuring meiofauna communities after Giere (2009).

1.1. Abiotic factors

The impact of abiotic factors on meiofauna communities have been studied since the 1960s. Among abiotic factors, oxygen depletion (Josefson and Widbom 1988; Austen and Wibdom 1991), hydrodynamics (Menn 2002; Reise 2002; Gheskiere et al. 2005), sediment grain size (Coull 1985; Heip

et al. 1985; Ndaro and Olafsson 1999; Steyaert et al. 2003; Schratzberger et al. 2004; Semprucci et al. 2010; Dupuy et al. 2015), changes in salinity (Ingole and Parulekar 1998; Richmond et al. 2007), temperature (Vafeiadou et al. 2018) and intertidal water levels (Smol et al. 1994; Steyaert et al. 2001) have been identified as structuring parameters (Fig. 2.2).

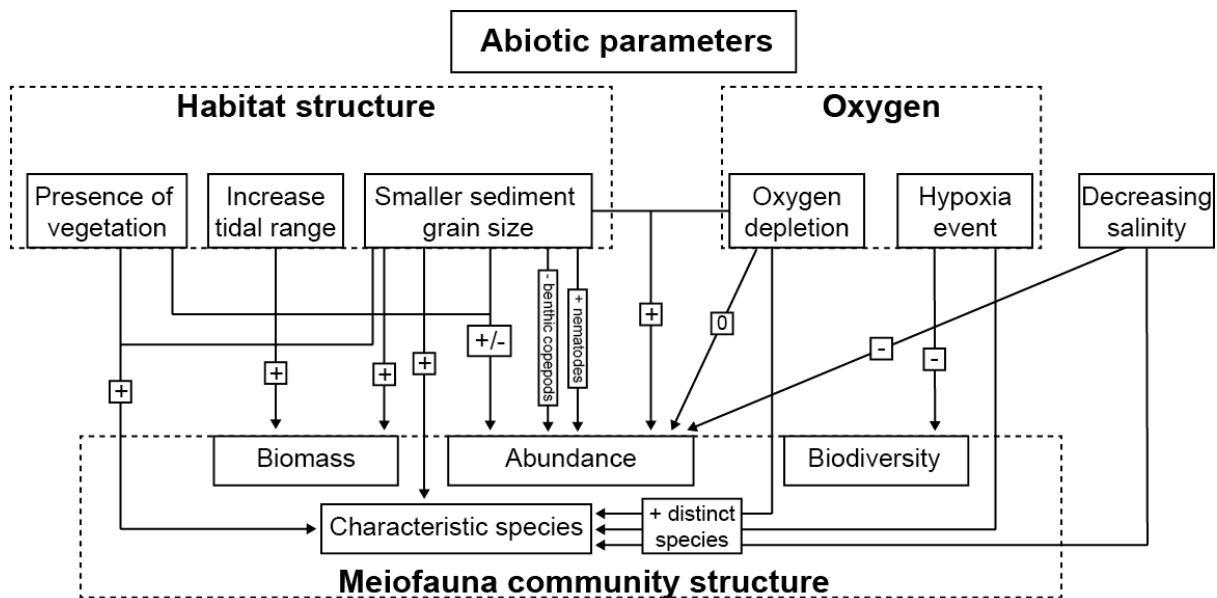

Figure 2.2. Conceptual diagram illustrating the effects of abiotic parameters on meiofauna community structure (i.e., biomass, abundance, biodiversity, characteristics species). After literature in section 1.1. and from Giere (2009). + = stimulating effect, - = negative effect

Meiofauna have a high tolerance to low oxygen concentrations (Wieser and Kanwisher 1961; Lassere and Renaud-Mornant 1973; Ott and Schiemer 1973) and Josefson & Widbom (1988) observed that the meiofauna community was hardly affected by low oxygen concentrations, whereas macrofauna was highly affected. However, an extreme event, such as hypoxia, could result in decreasing diversity and increased dissimilarity of the meiofauna community, also due to indirect effects related to decrease of macrofauna, changing macrofauna-meiofauna interactions (Austen and Wibdom 1991). Sediment grain size is known to affect meiofauna abundance, biomass and communities, both directly as well as indirectly (Heip et al. 1985), with generally higher abundances and biomass when sediment grain size is decreasing (Moens et al. 2013). Similar effects of smaller sediment grains related to higher abundances has been observed as well by Ndaro & Olafsson (1999) and Soetaert et al. (2009). Dupuy et al. (2015) showed that a larger sediment grain size leads to a higher abundance of larger nematodes, generally omnivorous/predating nematodes, and thus suggested a relationship between feeding ecology of nematodes and sediment grain size.

In addition to spatial variation, meiofauna communities also vary over depth which could be linked to sediment grain size and oxygen concentration (Steyaert et al. 2003; Vanaverbeke et al. 2004).

Lower diversity and abundance were observed in deeper layers related to decreasing oxygen concentration and sediment grain size (Steyaert et al. 2003, 2007). Hydrodynamics can play a role as well since both upward and downward migration have been observed during a tidal cycle (Steyaert et al. 2001).

Of course, these patterns of distribution and of migration are not only related to one of the previous factors, but to the combination and the interaction of all these factors (Steyaert et al. 2001; Giere 2009).

1.2. Biotic factors

As for studies on the effects of abiotic factors, investigations on the influence of biotic factors on meiofauna abundance and community structure have increased since the 1970s. Biotic parameters such as food availability and quality (Castel et al. 1989; Danovaro 1996; Danovaro et al. 2002b), the availability of specific food sources, i.e., microphytobenthos, bacteria (Danovaro and Gambi 2002; Fisher and Sheaves 2003; Fonseca et al. 2011) and phytodetritus (Vanaverbeke et al. 2004; Franco et al. 2008b), are known to affect meiofauna community (Fig. 2.3) (Woodin and Jackson 1979). Rudnick (1989) indicated that higher abundance of benthic copepods was linked to an increase in pelagic organic carbon, whereas abundance of nematodes and foraminifera was more related to increasing sediment organic carbon.

Danovaro (1996) and Fisher & Sheaves (2003) indicated a higher meiofauna abundance with increasing microbial biomass. Increase in food quantity and quality i.e., microphytobenthos and organic carbon lead to increasing meiofauna abundance and biomass as observed by Castel et al. (1989). The variations in availability of food sources, e.g. due to absence or seasonal variations of food sources, affected the meiofauna community as well. This relationship between seasonal fluctuations of meiofauna abundance and seasonal variations in its food sources, i.e., microphytobenthos and suspended particulate organic matter, has been observed frequently (Coull 1970; Montagna et al. 1983; Rudnick et al. 1985). Tietjen (1969) observed similar patterns linking increasing abundance of certain trophic groups such as epigrowth feeding nematodes as well as deposit and omnivorous feeding nematodes to increases in microphytobenthos and detritus, respectively. Danovaro & Gambi (2002) and Fonseca et al. (2011) observed that dominant trophic groups of meiofauna followed seasonal fluctuations of food sources. Seasonal or spatial variations also occur in the availability of habitat structuring vegetation, i.e., the presence or absence of vegetation, resulting in characteristic meiofauna taxa and nematode species as well as in a small effect on the meiofauna and nematode abundances (Fonseca et al. 2011). This could be linked to differences in habitat structure between vegetated and unvegetated habitats, e.g. lower hydrodynamics (Reise 2002) and lower and/or higher sediment grain

size in vegetated habitats (Fonseca et al. 2011; Leduc and Probert 2011). As a result, this is likely that meiofauna community structure changes between habitats (i.e., different food sources) and seasons (i.e., variation of food sources). Danovaro et al. (2002) observed an increase in meiofaunal production during microphytobenthos blooms and with the fall of seagrass leaves.

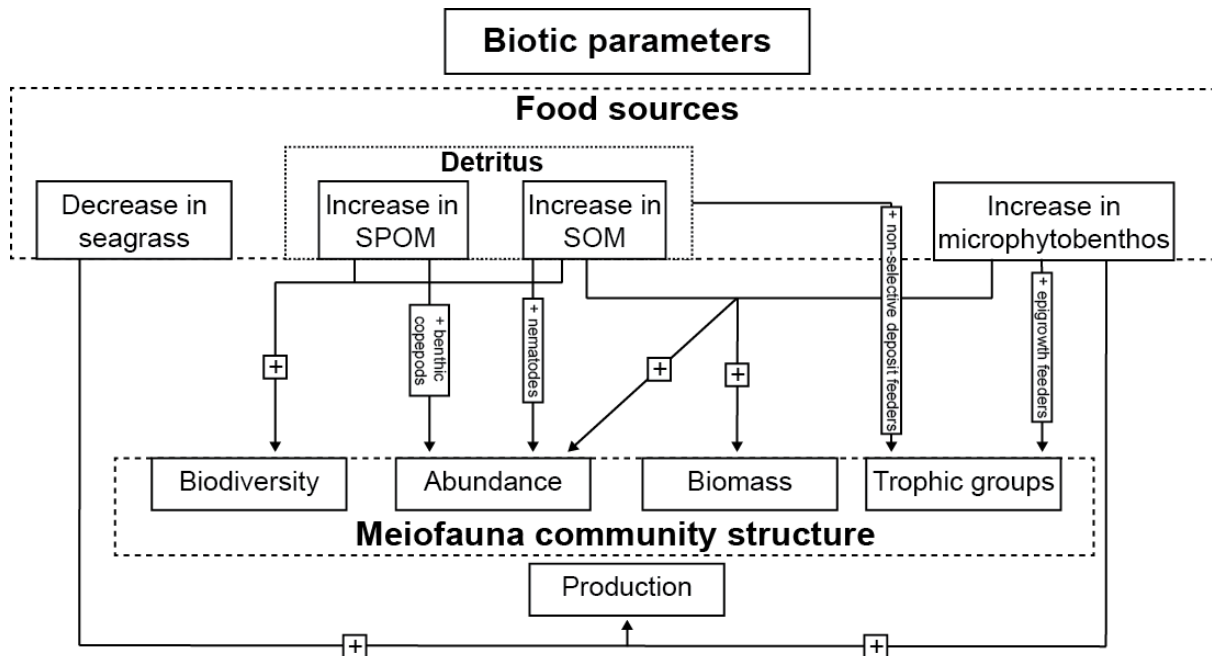

Figure 2.3. Conceptual diagram illustrating the effects of biotic parameters on meiofauna community structure (i.e., biomass, abundance, biodiversity, characteristics species) and production. After literature in section 1.2. and from Giere (2009). += stimulating effect, SOM = sediment organic matter, SPOM = suspended particulate organic matter.

2. MEIOFAUNA FEEDING ECOLOGY

Meiofauna, with its relatively small size has the ability to migrate through the interstitial space of the sediment and can therefore access a large diversity of food sources. Large heterogeneity, as well as high diversity of taxa, enables meiofauna to rely on a large diversity of food sources in marine coastal habitats (Fig. 1, Giere 2009). Free-living nematodes, generally the most abundant taxa, are known to feed on a large range of food sources (Leduc et al. 2009; Lebreton et al. 2012; Vafeiadou et al. 2014) but some trophic groups have very specific feeding behaviors (Rzeznik-Orignac et al. 2008; Maria et al. 2011; Moens et al. 2014). Several studies have demonstrated the important role of microphytobenthos in nematodes diets, either for non-selective deposit feeders or epigrowth feeders (Moens and Vincx 1997b; Moens et al. 1999a; Rzeznik-Orignac et al. 2008; Rzeznik-Orignac and Fichet 2012; Vafeiadou et al. 2014). The importance of bacteria was highlighted by Vafeiadou et al. (2014) for selective deposit feeders, which correspond to their mouth morphology. Nematodes are, due to their ability to migrate, involved in the degradation of seagrass detritus by both chemical and mechanical processes (Giere 2009). They seem to rely less on trapped phytoplankton as a food source, probably due to their ability to migrate through the sediment layers (Lebreton et al. 2012). Benthic copepods seem to be important consumers of settled phytoplankton (Vizzini and Mazzola 2003; de Troch et al. 2006b; Lebreton et al. 2012). However, they have been considered to rely on a broad range of food sources as well, including epipelagic or epiphytic diatoms, phytoplankton, bacteria, fungi and ciliates (Hicks and Coull 1983; de Troch et al. 2005; Giere 2009). Despite generally having a lower biomass than macrofauna, free-living nematodes and benthic copepods are considered as having an important role in marine food webs where they represent an important link from primary producers and bacteria to higher trophic levels (Hicks and Coull 1983; Coull 1999; Leguerrier et al. 2003; Rzeznik-Orignac et al. 2008; Giere 2009).

The grazing rates of meiofauna are considered to be high enough to control microphytobenthos biomass and production (Montagna et al. 1995; Rzeznik-Orignac et al. 2003). The short life cycle and high turnover rate of meiofauna (Heip et al. 1985) enables them to respond rapidly to inputs of primary production (e.g., microphytobenthos) and organic matter (Escaravage et al. 1989). Meiofauna grazing is tightly coupled to bacterial assemblages and there are multiple indications of meiofauna grazing on bacteria (Giere 2009). However, this connection is often indirect and not through direct bacterivory (Giere 2009), even though some nematodes specifically rely on bacteria (Wieser 1953; Pascal et al. 2008, 2009; Vafeiadou et al. 2014). In addition to control biomass of primary producers, detritus and bacteria via grazing, meiofauna are also known to affect food source biomass via the bioturbation and biostabilization of the sediment (Blanchard et al. 2001; Giere 2009). Last but not least, the grazing on detritus derived from phytoplankton creates a strong link between the benthic and the pelagic compartments (Giere 2009). Despite the important role of meiofauna in marine food webs, the

knowledge on their feeding ecology is still incomplete (Pace and Carman 1996; Moens et al. 2013). A comprehensive understanding of meiofauna feeding ecology is required to better assess their role in ecosystem functioning (Giere 2009; Moens et al. 2013).

2.1. Potential food sources

Food sources in benthic habitats that are known to be used by meiofauna communities, varies from benthic to pelagic organic matter, including living organisms such as microphytobenthos, trapped phytoplankton, vascular plants and bacteria. Benthic and pelagic organic matter, i.e., sediment organic matter (SOM) and suspended particulate organic matter (SPOM), consist of mixtures of several food sources, such as microphytobenthos, phytoplankton, bacteria and detritus (Dubois et al. 2012; Lebreton et al. 2012). SOM and SPOM are potential food sources for meiofauna as well, however the reliance of meiofauna on these food sources might be related to their quality (Danovaro et al. 2002a). Variations in availability of food sources as well as differences in quantity and quality might affect the meiofauna community structure and their feeding behavior (Castel et al. 1989; Danovaro and Gambi 2002; Danovaro et al. 2002a). The role of some of these food sources for meiofauna is, however, still under debate, e.g. seagrass material (Leduc et al. 2009; Lebreton et al. 2012), SPOM (Vafeiadou et al. 2014), and bacteria (Vafeiadou et al. 2014).

2.1.1. *Microphytobenthos*

Microphytobenthos, which refers to microscopic, unicellular algae and cyanobacteria living at the sediment surface, contributes significantly to total primary production of estuarine and shallow water ecosystems (MacIntyre et al. 1996; Underwood and Kromkamp 1999). Functional typology of benthic microalgae is closely related to sediment grain size (Giere 2009; Ubertini et al. 2015), promoting the dominance of epipellic (i.e., motile) diatoms on muddy sediment (Yallop et al. 1994; Thornton et al. 2002) whereas epipsammic (i.e., non-motile) diatoms mostly occur in sandy habitats (Asmus and Bauerfeind 1994). Benthic epipellic diatoms migrate vertically towards the sediment surface during diurnal low tide exposure, and form biofilms in combination with heterotrophic bacteria (Consalvey et al. 2004; Herlory et al. 2004). These diatoms and bacteria secrete a wide range of extracellular polymeric substances (EPS) which are the major components of biofilms (Holland et al. 1974; Smith and Underwood 1998). EPS are rich in polysaccharides, proteins, proteoglycans and lipids (Underwood et al. 2004; Pierre et al. 2010, 2012) and increase sediment stability (Sutherland et al. 1998; Underwood and Paterson 2003; Lubarsky et al. 2010). Microphytobenthos is responsible for the very high production in intertidal bare mudflats (MacIntyre et al. 1996; Underwood and Kromkamp 1999; McLusky and Elliott 2004) and seagrass beds (Asmus and Asmus 1985; Daehnick et al. 1992; Kaldy et al. 2002). The main factors determining microphytobenthos production are light availability,

temperature and sediment stability (MacIntyre et al. 1996; Underwood and Kromkamp 1999). Benthic microalgae are considered as an essential food source for numerous benthic species (macro- and microconsumers) in bare mudflats (Herman et al. 1999, 2000) as well as in seagrass meadows (Lebreton et al. 2011b). The biomass of microphytobenthos is relatively stable all year round whereas biomass of other primary producers (e.g., phytoplankton and seagrass) can be highly variable throughout the year (Gazeau et al. 2004; Lebreton et al. 2009).

2.1.2. *Phytoplankton*

In open water, phytoplankton is mainly consumed by microzooplankton (Jackson 1980; Landry and Hassett 1982) or removed from the system by sedimentation or cell lysis (Brussaard et al. 1995). However, in coastal and estuarine systems, the fate of the phytoplankton in the food web is highly variable (Calbet and Landry 2004) and there is a strong coupling between the water column and benthos: large quantities of phytoplankton can be grazed by suspension feeders (Asmus and Asmus 1991) or settle to the sediment (Grebmeier et al. 1988; Turner 2002; Gazeau et al. 2004). Resuspension of benthic material back to the water column can also be very high (Lucas et al. 2001). For example, resuspension of the benthic microbial biofilm stimulates pelagic phytoplankton production and the microbial food web (Saint-Béat et al. 2014). Vice versa, seagrass beds trap high quantities of pelagic material in the sediment because of reduced hydrodynamic forces within the canopy (Asmus and Asmus 2000; Koch et al. 2006).

2.1.3. *Vascular plant material*

Seagrass beds are valuable habitats of shallow coastal waters (Terrados and Borum 2004) and considered as one of the most productive marine habitats in the world (Duarte and Chiscano 1999; Hemminga and Duarte 2000). Seagrass meadows offer shelter and subsiding conditions to many organisms (Fig. 1, Hemminga & Duarte 2000). They provide a high diversity of food sources (Valentine and Duffy 2006) following temporal and spatial variations (Duarte 1989; Mateo et al. 2006). The surface of seagrass leaves is a substrate for epiphytic organisms forming an integral component of seagrass meadows (Borowitzka et al. 2006). Epiphytic algae are considered as important primary producers and contributors to the food web within seagrass meadows (Moncreiff and Sullivan 2001; Borowitzka et al. 2006; Hoshika et al. 2006). The seagrass leaves and roots themselves, however, are seldom used directly as a food source by invertebrate consumers (Valentine and Heck 1999). Seagrass material that is not consumed by herbivores enters the detrital compartment and is then stored as detritus or exported out of the system (Cebrián 1999). Within seagrass beds, the consumers usually feed on detritus (Cebrián 1999) being a substrate for the development of bacteria (Anesio et al. 2003; Holmer et al. 2004). A

study by Moriarty et al. (1986) suggests that bacterial productivity is most likely increasing due to excretion and decomposition of seagrass roots and rhizomes.

2.1.4. *Bacteria*

Bacterial abundance is generally considered to be constant in marine sediments (Schmidt et al. 1998), whereas large fluctuations are observed in production rates of bacteria (Sander and Kalff 1993). Bacteria are considered to be essential in processes such as remineralization of organic matter as well as production of particulate and dissolved organic carbon (Legendre and Rassoulzadegan 1996; Rivkin et al. 1996). Meiofauna communities might enhance the abundance (Lacoste et al. 2018) and production (Bonaglia et al. 2014) of bacteria due to bioturbation as well as grazing on bacteria (i.e., for production). Bacteria are consumed by microfauna (ciliates and flagellates) as well as by meiofauna and macrofauna in benthic systems (Kemp 1990; Moens et al. 1999b). Pascal et al. (2009) suggested that bacteria are an alternative food source for meiofauna when microphytobenthos is absent. However, meiofauna are considered to have a preference for microphytobenthos as food source over bacteria (Pascal et al. 2008). Studies about the consumption of bacteria by meiofauna and the role of benthic bacteria within food webs are scarce however, mostly because of technical difficulties (Kemp 1990; Pascal et al. 2008).

2.2. Determination of meiofauna feeding ecology

Over the last five decades, many techniques have been developed providing information about the food sources of meiofauna. This is especially the case for free-living marine nematodes, for which methods vary from observation of mouth morphology (Wieser 1953), feeding experiments on living nematodes (Moens and Vincx 1997b), stable isotope analyses (Moens et al. 2002; Rzeznik-Orignac et al. 2008; Leduc et al. 2009; Lebreton et al. 2012), gut content analyses (Majdi et al. 2012) and fatty acid analyses (Braeckman et al. 2015).

2.2.1. *Buccal morphology of free-living marine nematodes*

Free-living nematodes, generally the most dominant meiofauna taxa in coastal ecosystems, are known to feed on a broad range of resources (Giere 2009). Several classification methods have been utilized to determine the main food sources of nematode species based on mouth morphology, and thereby assign them to trophic groups. According to the morphology of their buccal cavity, Wieser (1953) classified nematode species in four feeding types: selective deposit feeders (1A), non-selective deposit feeders (1B), epigrowth feeders (2A), and omnivores/predators (2B) (Fig. 2.4).

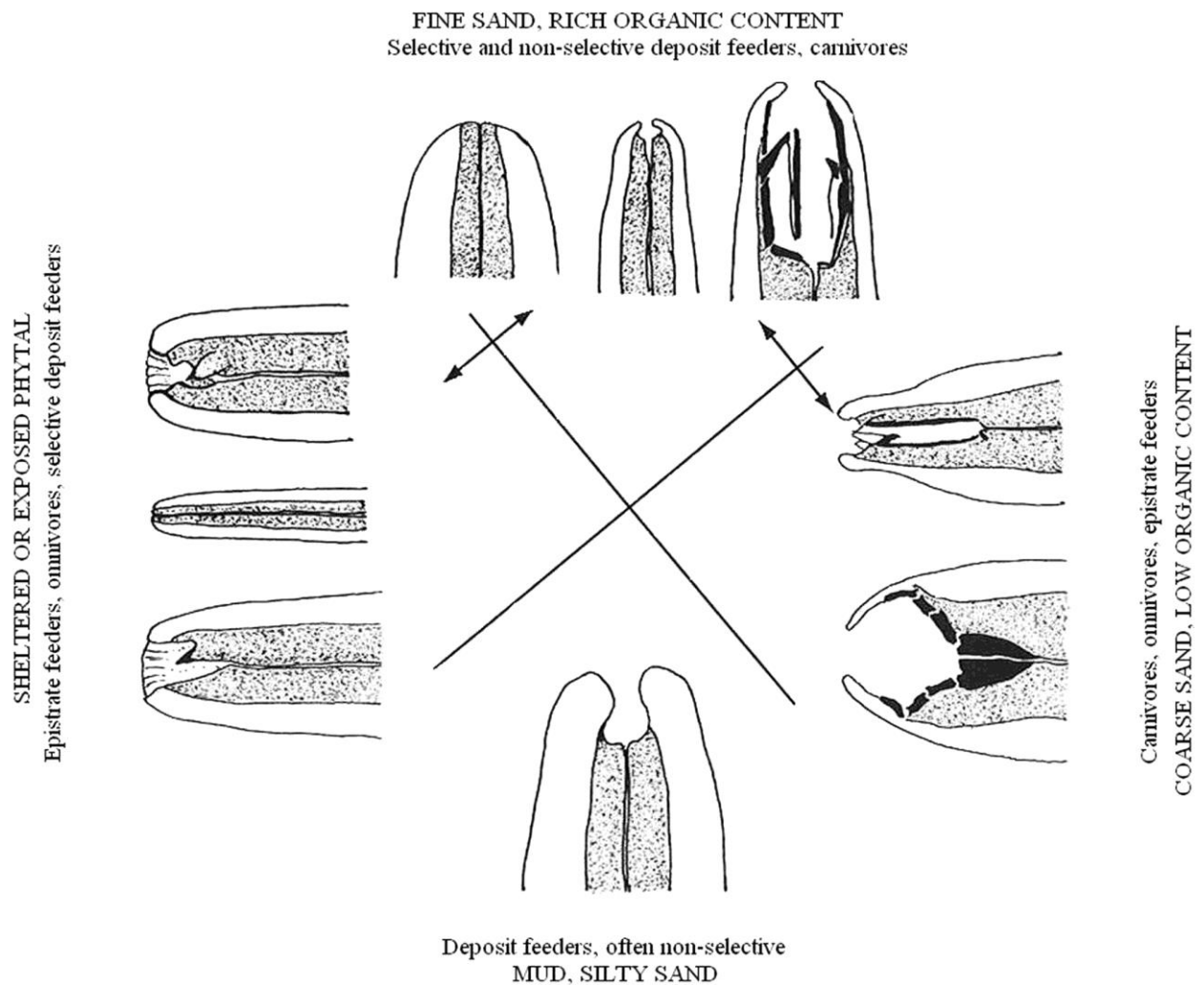

Figure 2.4. Trophic guilds of nematodes from different intertidal habitats based on buccal cavity morphology and related to sediment grain-size and organic content. After Giere (2009).

Primary division was based on the presence (2A and 2B) or absence (1A or 1B) of a buccal armature, i.e., teeth, onchia, denticles, mandibles or other sclerotized structures. Feeding types without buccal armature, i.e., 1A and 1B, are mainly distinguished from each other by the size of their buccal cavity. Selective deposit feeders with their smaller buccal cavity feed mainly on small, bacteria-sized food sources, whereas larger mouth openings of non-selective deposit feeders allow them to feed on a larger spectra of resource sizes. Epigrowth feeders and omnivores/predators are distinguished from these deposit feeders by the presence of a buccal armature. Epigrowth feeders are known to use their teeth to pierce or crack the food particles and scrape off food from the substrate (Moens and Vincx 1997b). This trophic group is assumed to feed mainly on microalgae (Moens and Vincx 1997b), however, bacteria and fungi are suggested as potential food sources as well (Iken et al. 2001). Omnivores/predators, generally larger nematodes, have usually wider mouth openings including a teeth or another buccal armature. Omnivores/predators consume their prey entirely or utilize their armature to pierce or tear open the prey. However, this classification scheme, based on buccal cavities, has

limitations in accurately representing the feeding behavior of nematodes. *In situ* observations of feeding behavior are contradicting particular classifications (Moens and Vincx 1997b; Pape et al. 2011; Guilini et al. 2013), and demonstrate difficulties in specifying a preference for bacteria or microphytobenthos based on buccal cavities (Moens and Vincx 1997b).

2.2.2. Bulk stable isotope analyses

Stable isotopes have been used more and more over the last decades to determine the food sources of meiofauna (Couch 1989; Moens et al. 2005b; Vafeiadou et al. 2014). The carbon stable isotope compositions of food sources differ due to variation in the origin of the CO₂ they rely on (e.g. terrestrial plants, marine phytoplankton, estuarine phytoplankton) or due to different biochemical pathways during photosynthesis (e.g. C₃ plants, C₄ plants), providing a good discrimination between food sources from terrestrial, pelagic and benthic origin (DeNiro and Epstein 1978; Rau et al. 1983; Hobson et al. 1994; Fry 2006). Carbon isotope compositions can be utilized to define consumption of resources since there is generally little differentiation in the isotope compositions of a consumer and its resource (Peterson and Fry 1987; Fry 2006). Nitrogen isotope composition differs substantially and can therefore provide information about the trophic level of a consumer (Fry 2006). Hence, stable isotope composition gives information about food source uses and trophic level of consumers. Isotope compositions of food sources might, however, be highly variable (e.g. spatial and/or seasonal variation) and $\delta^{13}\text{C}$ and $\delta^{15}\text{N}$ values may overlap, which makes it sometimes difficult to determine trophic relationships (Mutchler et al. 2004; Fry 2006). Partially due to these overlapping isotope compositions, stable isotope studies highlighted that nematodes can rely on a very large range of food sources in soft-bottom coastal habitats, i.e., microphytobenthos, seagrass material, phytoplankton and bacteria (Moens et al. 2005b; Rzeznik-Orignac et al. 2008; Leduc et al. 2009; Lebreton et al. 2012; Vafeiadou et al. 2014). Moreover, bacteria are difficult to isolate from environmental material for stable isotope analysis (Coffin et al. 1990; Pelz et al. 1997), and tend to have an isotope composition close to their substrate (Boschker et al. 2000). Therefore, additional information is required to distinguish food sources in these complex habitats, for instance fatty acid profiles, which have been proven to be useful tracers (Carman and Fry 2002; Kelly and Scheibling 2012).

2.2.3. Fatty acid analyses

Fatty acids (FAs) have been used as semi-quantitative markers to trace flows of organic matter in coastal food web studies (Kelly and Scheibling 2012) and they are frequently used to define trophic relationships (Sargent and Whittle 1981; Dalsgaard et al. 2003; Parrish 2013). However, lipid markers such as FAs have been only utilized occasionally for identifying meiofauna trophic relationships (Leduc et al. 2009; Braeckman et al. 2015; Cnudde et al. 2015). Primary producers and bacteria synthesize

specific FAs which can be used as good marker for organisms such as bacteria, diatoms, flagellates and vascular plants (Dalsgaard et al. 2003). Consumers are unable to synthesize these FAs or to largely alter their structure and therefore incorporate some of the FAs unchanged, reflecting the FA composition of their diet (Parrish et al. 2000; Dalsgaard et al. 2003).

Compound specific isotope analysis (CSIA) of FAs can be used as well to better determine the contributions of food sources with similar FA compositions when they have different isotope compositions (e.g. diatoms from the microphytobenthos *vs.* diatoms from the phytoplankton). Such a method is very useful to determine compositions of composite food sources such as sediment organic matter (SOM) and suspended particulate organic matter (SPOM) (van Gaever et al. 2009; Middelburg 2014; Braeckman et al. 2015), which are mixtures of various primary producers, bacteria and decomposed material (Mateo et al. 2006). CSIA of fatty acids can be utilized as well to determine the origin of organic matter in the diet of consumers, but, so far, have been rarely used in identifying feeding behavior and food sources used by meiofauna (Braeckman et al. 2015).

2.2.4. *Combination of trophic marker analyses*

All the trophic marker approaches have their limits and shortcomings (e.g. overlap of isotope compositions, similar FA profiles in composite food sources, Table 2.1). The combination of stable isotope compositions and fatty acid profiles has been shown to be effective in advancing the understanding of complex food webs (Kharlamenko et al. 2001; Nyssen et al. 2005; Jaschinski et al. 2008; Leduc et al. 2009; Lebreton et al. 2011b). Therefore, discriminating food sources with the combination of multiple trophic markers is a novel approach to determine the food resources of meiofauna in soft-bottom coastal systems. Few studies combined trophic markers, such as stable isotope compositions and fatty acid profiles (Leduc et al. 2009) or fatty acid profiles and fatty acid specific isotope ratios (Braeckman et al. 2015), to determine food resources of meiofauna.

Table 2.1. Synthesis of the main advantages and drawbacks of several methods used in determining feeding behavior. Assessment of the methods in accordance with 12 variables: price, investment, scale (i.e., micro, small, and large), organization level (i.e., individual, population, community, and ecosystem), ecological question (i.e., interaction, flux) and data type (qualitative or quantitative). 0 indicates “not adapted” and 1 indicates “strong affinity”. Exceptions on this are for the variables price, investment (0 = low, 1 = high) and data (0 = qualitative, 1 = quantitative). Modified from Majdi et al. (2018).

Detecting prey-predator relationships, or food sources	Price	Investment	Scale			Organization level				Interaction	Flux	Data	Advantages	Drawbacks
			Micro	Small	Large	Individual	Population	Community	Ecosystem					
Observation of feeding activity	0	1	0	1	1	1	1	0	0	1	0	1	Straightforward and well-established / relatively cheap / various interactions and scales (incl. intraspecific variability) / <i>In situ</i> or under Temporal and spatial scale are design-dependent / difficult to measure controlled conditions / Large scale records of feeding-behaviors are assimilation possible with miniaturization of loggers	
Incubation experiments	0	1	1	1	0	1	1	1	0	1	1	1	Effect-size of specific variables / suitable for filter-feeders	Mostly laboratory-based, so deviation from natural conditions
Gut & feces content	0	1	1	1	1	1	1	0	0	1	0	1	Well-established / relatively cheap / information on nature and size of ingested food items	Snapshot of diet (does not reveal interaction strength) / time consuming / labile tissues or prey might be overlooked
Gut DNA	1	1	0	1	1	1	1	1	0	1	0	0	Identification of gut microbiomes / works on partly digested, poorly recognizable, food items	Expensive / susceptible to typical drawbacks associated to molecular approaches
Parasites as biological tags	0	1	0	0	1	1	1	1	0	1	0	0	Host specificity / integration of diet over long time periods / potential information on diet provenance	Lethal / no information on prey size / needs empirical knowledge of life-cycles (and potentially biogeography) of parasites / bias due to side-effects of parasites on hosts' health and behavior
Bulk stable isotope analyses	0	0	0	1	1	1	1	1	1	0	1	1	Well-established / relatively cheap / traces the C and N food sources in consumers / important replication is possible / suited for <i>in situ</i> as well as laboratory studies	Turnover times and isotopic discrimination might vary among species, tissues and the environment studied / not well-suited when a large number of potential resources are considered
Isotopes as labels	1	1	0	1	1	1	1	1	1	0	1	1	Trace the fate (timing and scale) of carbon and nitrogen from microbes to macroscopic consumers / differentiation between N and C uptake from unlabeled C and N pools	Difficult to provide quantitative fluxes / needs to know turnover incorporation and routing in tissues (e.g. issue of uniformly labeling the food source) / can be relatively expensive depending on the scale or nature of the labeling
Fatty acids	1	1	1	1	1	1	1	1	1	0	1	0	Well-established / traces flux and nutritional quality	Non-specific biomarkers / needs <i>a priori</i> knowledge of producers' and consumers' metabolism / relatively expensive
Compound-specific isotope analyses	1	1	0	1	1	1	1	1	0	0	1	1	Integrative traces when coupled with a labeling / target analysis promising in microbial ecology / ideally it can trace limiting compounds and eventually detect minor food sources unseen by classical methods / better knowledge in fractionation and turnover times for specific compounds	Needs a good understanding of the biochemical and physiological pathways in investigated organisms or tissues / relatively expensive
Contaminants	1	1	1	1	1	1	1	1	0	1	1	0	Might trace spatio-temporal ingestion and assimilation depending on the persistence of compounds within tissues (e.g. lipophilic contaminants, might biomagnify along food chains) / potentially information on foraging area, and on contamination status of species and ecosystems	Needs a source of contamination / biases due to side-effects on health and behavior / needs knowledge of contaminants' biogeochemical cycle, distribution and persistence in organisms and in the environment / relatively expensive

2.3. Food web models

Food web models and ecological networks are used quite regularly to describe the functioning of large scale food webs. Such food webs, typically occurring in coastal ecosystems, are generally characterized by multiple interactions and variable responses to external stressors (Baird et al. 2007; Leguerrier et al. 2007; Kaufman and Borrett 2010; Pacella et al. 2013; Fath 2015; Horn et al. 2017; de la Vega et al. 2018b). The functioning of coastal ecosystems can be described and analyzed thanks to these holistic approaches, which permit defining the global properties of these systems (Jørgensen and Müller 2000; Breckling et al. 2005). Holistic perspectives are indeed required to adequately address the increasing changes of ecosystem functioning due to anthropogenic activities, global change and natural evolution of shorelines (Davis and Fitzgerald 2004). These geomorphological changes indeed affect the general functioning of coastal food webs, as they alter the availability and dynamics of food resources (Eriksson et al. 2010).

2.3.1. *Stable isotope mixing models*

Consumption is generally estimated using feeding experiments, feeding observations and stomach content analyses (Jacobsen 1967; Höfmann and Hörschelmann 1969; Goss-Custard et al. 1977; Fauchald and Jumars 1979; Jensen and Siegismund 1980; Turpie and Hockey 1984; Zwarts and Blomert 1992; Haubois et al. 2005a). However, for smaller organisms, such as meiofauna, carrying out such measurements and observations is very challenging (Moens et al. 2005b; Rzeznik-Orignac et al. 2008; Leduc et al. 2009; Lebreton et al. 2012). This problem led to the use of trophic marker based approaches to determine the feeding ecology of these animals (van Oevelen et al. 2009; Pacella et al. 2013). While the use of stable isotopes in trophic studies is becoming more common (Post 2002; Fry 2006; Lebreton et al. 2012), the use of stable isotope data in food web models is still rare (Baeta et al. 2011; Navarro et al. 2011; Pacella et al. 2013). However, integrating stable isotope data into food web models, by use of stable isotope mixing models (Parnell et al. 2010; Phillips et al. 2014; Stock et al. 2018), can provide more accurate estimations of food source used by consumers.

2.3.2. *Linear inverse modeling*

Field measurements, conceptual and physiological information as well as food source distributions derived from stable isotope mixing models can be translated into constraints related to production, respiration, consumption and egestion (Leguerrier et al. 2003, 2007; Degré et al. 2006; Niquil et al. 2006; Pacella et al. 2013; Saint-Béat et al. 2013b). The flows of energy can be determined using these constraints in linear inverse model-Markov chain Monte Carlo (LIM-MCMC) technique (Niquil et al. 2012). This technique provides the probability distribution of flows in underdetermined systems using a combination of field and relevant experimental data (Vézina and Platt 1988), and enable generating a static, mass-balanced, temporally integrated snapshot of complete food webs and its flows (Pacella et al. 2013). Defining the compartments,

which can range from a single species to functional groups, is the first requirement for inverse modeling. Functional groups are here defined as groups including species with similar diets and similar feeding modes. Johnson et al. (2009) highlighted that aggregating species into functional groups affects the structural and functional properties of food webs to a minor extent. These food web models are generally expressed in flow of carbon (Leguerrier et al. 2003; Baird et al. 2004b; Fath et al. 2007).

2.3.3. *Ecological network analysis*

Complex interactions within ecosystems have been assessed holistically using ecological network analyses (ENA), which examines the structural and functional properties of an ecosystem (Ulanowicz 2004; Baird et al. 2007; Fath et al. 2007). These network analyses provide insights about ecosystem complexity, cycling, transfer efficiency, assimilation efficiency, activity, and trophic structure (Baird and Ulanowicz 1989; Gaedke and Straile 1994; Niquil et al. 1999; Baird et al. 2004b; Saint-Béat et al. 2014), in the form of indices and system properties (Ulanowicz 2004; Borrett and Lau 2014). The information provided by ENA can be used for ecosystem management and policy making (de la Vega et al. 2018a). For example, the indices related to ascendancy provide information about the organization of the system as well as the specialization by flows and maturity (Ulanowicz 2004). Another index related to cycling, expressed in the form of the Finn cycling index, is assumed to provide information on the recycling potential of these systems and can be combined with other indices as stress indicator on system level (Baird et al. 2007).

In addition to indices which provide information at the global scale, individual indices can also be valuable for more detailed perspectives (Ulanowicz and Kay, 1991). These individual indices provide information on characteristics of single or multiple compartments, which can emphasize the variability of the whole food web model characteristics (Ulanowicz and Kay, 1991). The characteristics of compartments can be expressed with the use of individual indices, e.g. omnivory, mean trophic efficiency, dependency coefficients and detritivory/herbivory ratios (Baird and Ulanowicz, 1989; Kay et al., 1989; Ulanowicz, 2004; Ulanowicz and Kay, 1991).

CHAPTER 3

Intertidal habitat assessment

**“The heart of man is very much like the sea, it has its storms, it has its tides
and in its depths it has its pearls too”**

Vincent van Gogh

How do food sources drive meiofauna community structure in soft-bottom coastal food webs?

How do food sources drive meiofauna community structure in soft-bottom coastal food webs?

L.H. van der Heijden^{1,2}, J. Rzeznik-Orignac³, R. Asmus², D. Fichet¹, M. Bréret¹, P. Kadel², L. Beaugeard¹, H. Asmus², B. Lebreton¹

Accepted in *Marine Biology* on 25/09/2018

¹UMR 7266 Littoral, Environnement et Sociétés (CNRS - University of La Rochelle), Institut du littoral et de l'environnement, 2 rue Olympe de Gouges, 17000 La Rochelle, France

²Alfred-Wegener-Institut Helmholtz-Zentrum für Polar- und Meeresforschung, Wattenmeerstation Sylt, Hafenstrasse 43, 25992 List/Sylt, Germany

³Sorbonne Universités, UPMC Univ Paris 06, CNRS, Laboratoire d'Ecogéochimie des Environnements

Benthiques (LECOB UMR 8222), Observatoire Océanologique, 66650 Banyuls/mer, France

ABSTRACT

Meiofauna have a strong role in the functioning of coastal ecosystems but how their food sources affect their community structure remains unclear, likely due to the influence of abiotic parameters and the small size of these organisms. The meiofauna and their potential food sources were sampled in several intertidal habitats (i.e., mudflat, seagrass bed, sandflat) of the Marennes-Oléron Bay, France, and the Sylt-Rømø Bight, Germany, to assess the relationships between habitat characteristics and meiofauna community structure. Biomass and quality (carbon/chlorophyll *a* ratios) of food sources were estimated. Meiofauna community structure based on density and biomass was determined, as well as nematode diversity and feeding types. Meiofauna density and biomass varied highly within habitats and within ecosystems, ranging from $1.7 \cdot 10^5$ ind. m^{-2} to $3.4 \cdot 10^6$ ind. m^{-2} and from 0.057 gC m^{-2} to 1.541 gC m^{-2} , respectively. Benthic microalgae and sediment organic matter are important drivers in these food webs as the density of two important trophic groups of nematodes, non-selective deposit feeders and epigrowth feeders, varied in accordance with these food sources. No clear relationship was observed between bacterial biomass and selective deposit feeders (i.e., bacterivores) probably due to the high production rate of bacteria. Complementary information about production rates of food source as well as data from trophic markers would provide complimentary information to better understand flows of organic matter in intertidal habitats, particularly for opportunistic species such as non-selective deposit feeders.

Keywords: free-living nematodes; benthic copepods; benthic diatoms; meiofauna community structure; trophic groups; seagrass beds; mudflats; sandflat

1. INTRODUCTION

Soft-bottom intertidal habitats are highly productive (Underwood and Kromkamp 1999; Hemminga and Duarte 2000), fueling complex food webs and providing food resources for a large diversity of top consumers like fish and birds (Day et al. 1989; Duarte and Cebrián 1996) via trophic pathways going through meiofauna (Chardy and Dauvin 1992) and macrofauna (Haubois et al. 2005a). Meiofauna, here defined as metazoans associated with sediments with a size range from 40 to 500 μm , are considered as an important trophic component in the functioning of coastal ecosystems. They have an intermediate trophic position (Leguerrier et al. 2003; Giere 2009) and high secondary production (from 4 to 29 $\text{gC m}^{-2} \text{ year}^{-1}$) (Escaravage et al. 1989; Chardy and Dauvin 1992; Danovaro et al. 2002b) that often exceeds that of the macrofauna (Giere 2009). Meiofauna are connected to the microorganisms in the food web via the consumption of microalgae and bacteria (Rzeznik-Orignac et al. 2003; Vafeiadou et al. 2014) and to the food webs of macroconsumers especially via their consumption by small benthic fish and predatory invertebrates (Coull 1999). Nematodes are the most dominant group in meiofauna; their food resources can be very specific, or in the contrary, relatively diverse, and their buccal cavity is very distinct based on these feeding types. This morphological trait has been used for decades to define feeding types (Wieser 1953; Warwick 1971; Heip et al. 1985) and some more recent methods (i.e., feeding behavior experiments; (Moens and Vincx 1997), trophic markers (Moens et al. 2005)) permitted to revise or precise the feeding types of some genera (e.g. assort of *Metachromadora* from omnivores/predators to epigrowth feeders).

Both, biotic and abiotic parameters, have been shown to affect meiofauna community structure. Among biotic parameters, food availability in general (Castel et al. 1989; Danovaro 1996), availability of specific food sources such as bacteria and microphytobenthos (Danovaro and Gambi 2002; Fonseca et al. 2011), the quality of the food (Danovaro et al. 2002b) and the deposition of organic material of pelagic origin (Franco et al. 2008a) have been identified as structuring parameters. Abiotic parameters such as sediment grain-size (Steyaert et al. 2003; Dupuy et al. 2015), habitat structure (Fonseca et al. 2011), oxygen gradients (Josefson and Widbom 1988), intertidal water level (Steyaert et al. 2001) as well as anthropogenic impacts (Semprucci et al. 2010) are influencing meiofauna community structure. Studies on meiobenthic communities in intertidal systems have been carried out mainly on single habitats, focusing on effects of abiotic and biotic parameters at the habitat scale (Reise 1985; Rzeznik-Orignac et al. 2003; Lebreton et al. 2012). Factors affecting the community structure of meiofauna at a larger scale (Moens et al. 2013) in intertidal habitats are still poorly known, as few studies have compared several habitats and/or different ecosystems.

The present study investigates whether meiobenthic communities, especially free-living nematodes and benthic copepods, differ among habitats with different characteristics (i.e., mudflats, seagrass beds and sandflats; influence of terrestrial organic matter inputs or not) to define which factors

are structuring these communities. Particular attention is paid to the role of food sources, as they have been highlighted as important drivers of ecosystem functioning in intertidal habitats (Asmus and Asmus 1985; Underwood and Kromkamp 1999; McLusky and Elliott 2004). The aim of this study is, therefore, to define if changes in biomass and quality of food sources can affect meiofauna community structure. If yes, the objective is to determine—among all available food sources (i.e., benthic microalgae, sediment organic matter (SOM), suspended particulate organic matter (SPOM) and bacteria)—what food sources play a role and how changes in these food sources influence meiofauna community structure. In this aim, a temporal sampling was done in spring and autumn in several habitats to define the temporal and spatial variations of the food sources and those of meiofauna community structure.

2. MATERIALS AND METHODS

2.1. Study sites

2.1.1. *Marennes-Oléron Bay*

The Marennes-Oléron Bay is a semi-enclosed system, located in the middle of the western Atlantic coast of France, between the Oléron Island and the mainland (Fig. 3.1). The bay has a surface of 180 km² (Gouleau et al. 2000) and is influenced by both oceanic and continental inputs, mainly from the Charente River (river input ranges from 15 to 500 m³ s⁻¹) (Ravail et al. 1988). Tides are semi-diurnal, with a period of emersion of ca. 6 h per tidal cycle and a tidal range from 0.9 to 6.5 m (Kervella 2009). The system is dominated by intertidal bare mudflats (91 km², i.e., 58%) which have a flat bottom slope (1:1000) and represent a large tidal area (up to 4.5 km wide) (Gouleau et al. 2000).

The Brouage mudflat, located on the eastern part of the bay, is the most extensive mudflat (40 km²) (Fig. 3.1). The sediment consists mainly of silt and clay particles (95%) with a size smaller than 63 µm (Pascal et al. 2009). Seagrass beds, consisting of the species *Zostera noltii* (Lebreton et al. 2009), are located on the western side of the bay, along the coast of the Oléron Island, which is more influenced by offshore waters than the eastern side (Dechambenoy et al. 1977). The seagrass meadow is stretched out over 15 km along the upper part of the flat, with an average width of 1.5 km (Guillaumont 1991).

2.1.2. *Sylt-Rømø Bight*

The Sylt-Rømø Bight is a semi-enclosed basin, located in the north of Germany between the mainland of Germany and Denmark, the islands of Sylt (Germany) and of Rømø (Denmark) (Fig. 3.1). The bight consists of a mosaic of habitats, mainly intertidal and subtidal sandflats, seagrass beds, and mudflats (Asmus and Asmus 1985). The bight has a coverage of 404 km² of which 135 km² are intertidal (Asmus and Asmus 1985) and the tidal gauge is 1.8 m on average (Asmus and Asmus 1985).

The *Arenicola* sandflat is the most represented intertidal habitat in the bay with 91 km² (67%) (Asmus and Asmus 2005). However, *Zostera noltii* seagrass beds expanded over the last years, from 15 km² in 1995 to 83 km² (i.e., 21% of the bay surface) in 2010 (Reise and Kohlus 2008). The intertidal bare mudflats are poorly represented in the bight, with an area of 4 km² (Fig. 3.1).

2.2. Field sampling and laboratory processes

Three intertidal habitats were studied in the two bays: a bare mudflat (mudflat MO) and a seagrass bed (seagrass MO) in the Marennes-Oléron Bay, and a bare mudflat (mudflat SR), a seagrass bed (seagrass SR) and a sandflat (sandflat SR) in the Sylt-Rømø Bight (Fig. 3.1). Based on the knowledge already gained about these habitats in each of these five locations (Leguerrier et al. 2003; Baird et al.

2007; Pacella et al. 2013; Saint-Béat et al. 2013a) one sampling station that was the most representative for the studied habitat was selected.

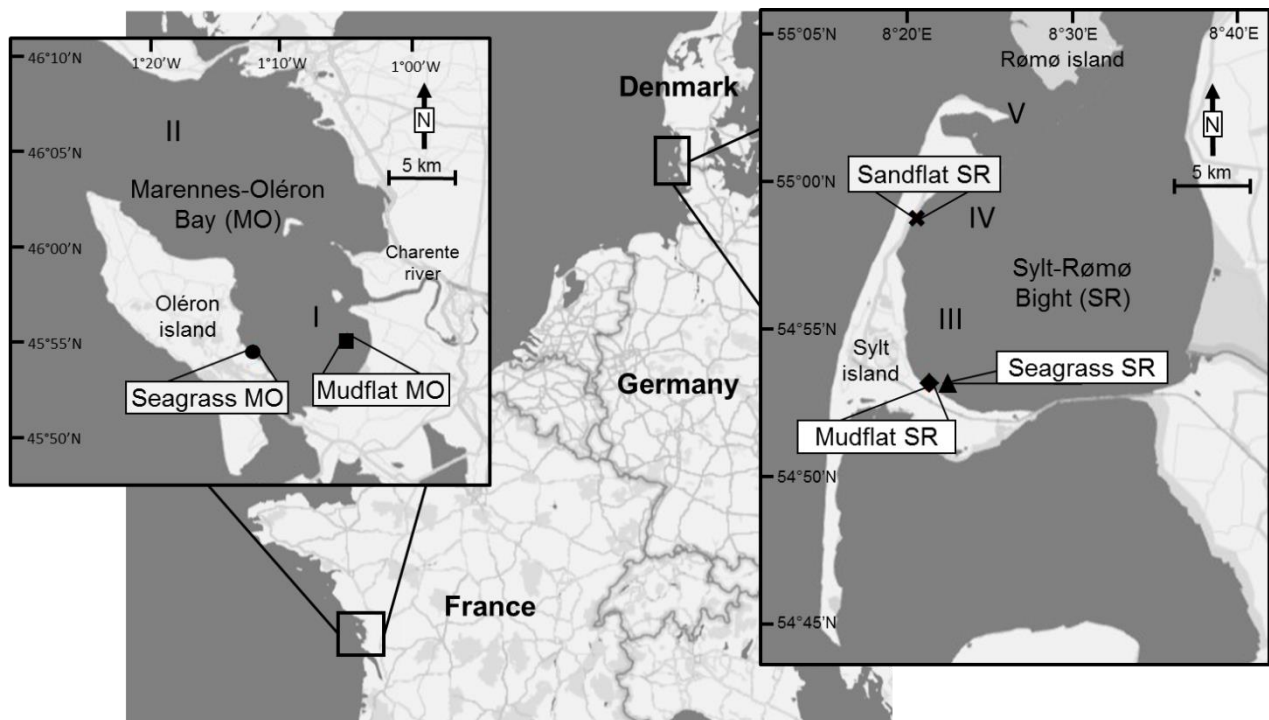

Figure 3.1. Sampling stations of the mudflats, seagrass beds and sandflat in the Marennes-Oléron Bay (MO) and the Sylt-Rømø Bight (SR) along the European coast. Pelagic sampling stations, where samples for suspended particulate organic matter were taken, are indicated by roman numbers in both Marennes-Oléron Bay (I-II) and Sylt-Rømø Bight (III-V).

2.2.1. Sediment grain size

Sediment samples ($n = 3$) were collected randomly with cores ($\phi = 4$ cm) and were split into 0-1 cm and 1-5 cm depth fractions. Sediment grain size was determined by laser granulometry analyses for the sediment from the seagrass bed and mudflats (Mastersize 2000, Malvern Instruments Limited, United Kingdom). The freeze-dried sediment of these habitats was rehydrated before analyses in order to avoid the use of ultrasound to disaggregate the sediment. Sediment grain size of freeze-dried samples from the sandflat of the Sylt-Rømø Bight was determined by dry sieving. Samples were classified based on their median sediment grain size after Wentworth (1922).

2.2.2. Benthic primary producers, composite sources and bacteria

For all stations, sampling was carried out in two seasons, in spring (from May 17 to June 17, 2016) and in autumn (from November 14 to December 15, 2016), to compare a season with a high primary production with a season with a high load of detrital matter. Sampling was carried out during low tide, starting about one hour before lowest water level.

Samples for sediment organic matter (SOM), detritus, and seagrass leaves and roots (3 replicates) were taken using cores ($\varnothing = 19$ cm) which were separated into two layers (a surface layer from 0-1 cm, a sub-surface layer from 1-5 cm). The collected material was gently sieved on a 500 μm mesh screen (1 mm for sandflat SR samples) after which the upper fraction was sorted in seagrass leaves, roots and detritus (brown to black colored leaves and roots). All samples were freeze-dried, then weighed (± 0.001 g). Carbon to dry weight ratios were determined on each sample: A small amount was ground to a fine and homogeneous powder using a ball mill (MM 400, Retsch, Germany) and carbon content was determined using an elemental analyzer (Flash EA 1112, Thermo Scientific, Italy). Sub-samples were collected in the lower fraction (SOM), freeze-dried, and ground using a mortar and pestle. Chlorophyll *a* and organic carbon concentrations were determined in sub-samples by fluorimetry (TD-700, Turner Designs, USA) using the method of Lorenzen (1966) and elemental analyses (Flash EA 1112, Thermo Scientific, Italy), respectively. Chlorophyll *a* values were converted into carbon biomass using the conversion ratio (47.63) provided by de Jonge (1980) and used as a proxy of fresh material of microalgae origin (i.e., microphytobenthos and trapped phytoplankton) in sediment, thereafter called “benthic microalgae”. Carbonates were removed prior to elemental analyses by adding HCl at 2 mol.l⁻¹ drop-by-drop on SOM samples until cessation of bubbling. Subsequently samples were dried at 60°C to constant weight, freeze-dried and ground again.

Bacterial biomass (3 replicates) was determined using cores ($\varnothing = 4$ cm) which were separated in two layers (0-1 cm and 1-5 cm). These sediment layers were homogenized with a spatula and 2 mL of this material were mixed with 2 mL formalin (4%). Samples were deep frozen in liquid nitrogen and stored at -80°C. The number of bacteria was determined following the protocol of Lavergne et al. (2014). Samples were diluted (1/2000) using sodium pyrophosphate (P-8010, Sigma Aldrich, France) and Tween 80 (P-1754, Sigma Aldrich, France), homogenized and then incubated at 4 °C during 30 minutes. Samples were then sonicated at 60 W during 30 seconds, after which 1 mL of the pre-diluted sample was stained with 20 μL of SYBR Green I (Invitrogen-11540746; 1/5000 final concentration) and incubated in the dark at room temperature for 15 minutes. Afterwards, 2 μL of calibration beads (1 μm) was added and the samples were analyzed using a flow cytometer (BD FACSCANTO II, BD Biosciences, USA). Bacterial densities were converted into carbon using the conversion factor (20 fgC cell⁻¹) established by Lee and Fuhrman (1987).

2.2.3. *Suspended particulate organic matter*

Sampling of the suspended particulate organic matter (SPOM) was conducted by collecting samples of surface water during high tide, in the same timeframe as the benthic samples. Water was sampled at two stations (I and II) in the Marennes-Oléron Bay and three stations (III, IV and V) in the Sylt-Rømø Bight (Fig. 3.1). Station I, in the north of the Brouage mudflat, represented the water mass covering the mudflat MO station. Station II, near the inlet of the Marennes-Oléron bay, represented the

water mass influencing the seagrass MO station. Station II is regularly sampled in the framework of the SOMLIT surveys (data provided by “Service d’Observation en Milieu Littoral, INSU-CNRS, La Rochelle station”). Water samples collected at stations III and IV represented water masses covering the sandflat SR (III), and the mudflat SR and seagrass SR stations (IV), respectively. Station V, near the entrance of the Sylt-Rømø Bight, represented the SPOM originating from the North Sea.

SPOM was sampled by collecting 10 to 100 mL of surface seawater which was pre-filtered on a 250- μm mesh screen to eliminate large particles/organisms. Water samples were then filtered on precombusted (4 hours, 450°C) Whatman GF/F glass fiber filters (0.7 μm nominal porosity) under moderate vacuum and these filters were freeze-dried. Chlorophyll *a* content, used as a proxy of phytoplankton biomass, of the freeze-dried GF/F filters was measured by fluorimetry using the method of Lorenzen (1966). Phytoplankton biomass was determined by using the conversion factor (56.4) established by Lü et al. (2009).

2.2.4. *Meiofauna*

Meiofauna were sampled for taxonomic composition, density (ind. m^{-2}) and biomass (gC m^{-2}) estimations at the same time as benthic primary producers and composite sources. Three replicates were collected randomly in a ten square meters area using cores ($\phi = 4$ cm). Cores were separated into two layers (0-1 cm and 1-5 cm) to study the changes of meiofauna communities related to sediment depth. Samples were sieved with a 500- μm mesh to eliminate macrofauna and large detritus. Meiofauna were extracted from the sediment using Ludox HS-40 (Sigma Aldrich, France) (de Jonge and Bouwman 1977) and retrieved with a 40- μm mesh sieve (Higgins and Thiel 1988). From each replicate, 100 nematodes were haphazardly taken with fine tweezers (#55, Dumont, Switzerland), mounted on slides in anhydrous glycerol to prevent dehydration (Seinhorst 1959) and examined microscopically. The taxonomic composition of the nematode community was determined at least to the genera level based on these 100 individuals according to the identification keys of Platt and Warwick (1983, 1988), and Warwick et al. (1998). Density was calculated for each genera as number of individuals per m^2 (ind. m^{-2}) and relative abundance as the percent composition of each genera relative to the total number of organisms. Species diversity indices were calculated on 100 individuals for each replicate at the five habitats for the two seasons. Community structure of the other meiofauna groups was not determined due to low densities. Nematodes were allocated into four trophic groups according to Wieser (1953) as follows: selective deposit-feeders (1A), non-selective deposit-feeders (1B), epigrowth feeders (2A), and omnivores/predators (2B). Various nematode genera, including at least one of each from the 4 different feeding groups, were selected for determination of individual dry weight and carbon content. Between 10 and 200 nematodes from the same genera were picked for dry weight determination, freeze-dried and weighed (± 1 μg) using a microbalance (ME 5, Sartorius, Germany). Organic carbon composition was determined using an elemental analyzer (Flash EA 1112, Thermo Scientific, Italy). Mean biomass

of species-specific nematodes and benthic copepods was used to convert the density of nematodes into grams of carbon per m² and dry weight per m² (Appendix 3.1).

2.3. Data treatment and statistical methods

All analyses were conducted using the R software (R Core Team, 2016) and all hypotheses were tested at $p < 0.05$ level. Normality of the data was tested using Shapiro-Wilks tests. Homogeneity of variance was checked using Bartlett and Levene tests. Average hierarchical clusters (data dissimilarity, Bray-Curtis distance) were realized to discriminate groups within the food sources and within the meiofauna trophic structure using the *vegan* package (Oksanen et al. 2017) and *pvclust* package (Suzuki and Shimodaira 2015). ANOVA followed by Tukey *post-hoc* test were used to compare sediment characteristics, meiofauna densities, biomass and diversity indices: Hill's diversity N_1 (Hill 1973) and species evenness J' (Formula in Appendix 3.2). Comparisons between sediment layers were conducted on meiofauna densities (ind. m⁻³) and biomass (gC m⁻³) expressed in volume of sediment. Comparisons between seasons and habitats were done on meiofauna densities, biomass and diversity indices from combined layers (expressed per surface area). Environmental variables have been analyzed through a preliminary Principal Components Analysis (PCA) to visualize the differences between habitats based on these variables. In a subsequent step copepods, other meiofauna taxa (ostracods, foraminifers and polychaetes) and feeding types of nematodes were compared with Bray-Curtis similarity redundancy relationship analyses (RDA) made with the *vegan* package (Oksanen et al. 2017). The relative abundance of copepods, ostracods, foraminifers and polychaetes and different feeding types of nematodes (dependent variables) were linked to environmental variables (independent variables) that were selected after stepwise forward procedure. Multicollinearity was tested for the explanatory variables using the *vif.cca* function in the *vegan* package (values over 10 indicated collinearity; Oksanen et al. 2017). The significance of the model was tested using a two-way ANOVA.

3. RESULTS

3.1. Sediment grain size

Sediment of the mudflats and seagrass beds consisted of a mixture of sand (29 to 64%), silt (29 to 58%) and clay (7 to 15%), while the sandflat consisted mainly of sand (98%) (Fig. 3.2). Sediments were classified as silt for mudflat MO, mudflat SR (autumn) and seagrass MO (autumn), very fine sand for seagrass SR, mudflat SR (spring) and seagrass MO (spring) and medium sand for sandflat SR. The mud content within the different layers of the same habitat was relatively similar, with a variation lower than 2%. The sediment grain-size of mudflat MO was lower than all other habitats with a median sediment grain-size of $32 \pm 4.3 \mu\text{m}$, and the grain-size of sandflat SR was higher than all other habitats with a median sediment grain-size of $407 \pm 16.3 \mu\text{m}$ (Appendix 3.3).

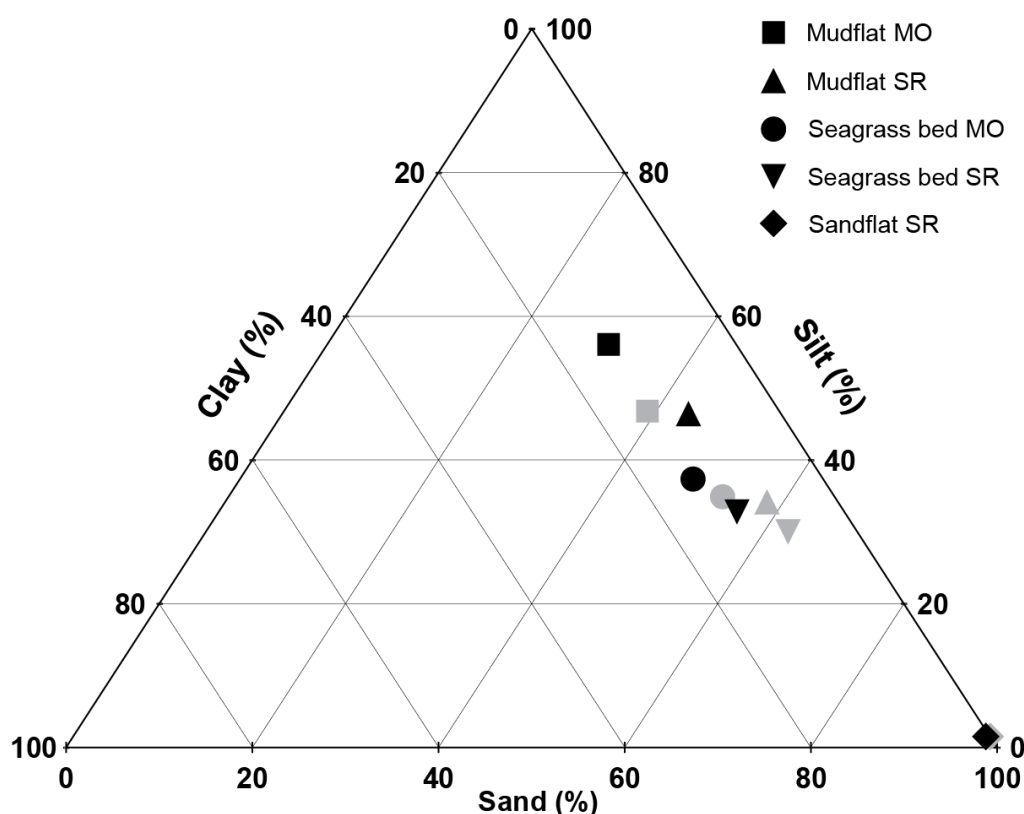

Figure 3.2. Ternary diagram presenting the sediment composition of the mudflats, seagrass beds and sandflat in the Marennes-Oléron Bay (MO) and the Sylt-Rømø Bight (SR) in spring (gray symbols) and autumn (black symbols). Separation by size for clay ($< 3.9 \mu\text{m}$), silty ($3.9 - 63 \mu\text{m}$), and sandy ($63 - 2000 \mu\text{m}$) sediment. ($n = 3$)

3.2. Potential food sources

The total biomass of benthic food sources ranged from 67.4 (sandflat SR, autumn) to 447.4 gC m^{-2} (mudflat SR, spring) (Fig. 3.3c and 2.3e). SOM was dominant in all habitats sources with proportions ranging from 29.3 to 94.5%, representing 19.8 (sandflat SR, autumn) to 290.3 gC m^{-2} (mudflat MO,

autumn). Benthic microalgae were the second most dominant food source, with biomass ranging from 7.1 gC m⁻² (3.7%, mudflat MO, spring) to 70.3 gC m⁻² (22.6%, seagrass SR, spring). Detrital matter was found mainly in the two seagrass beds and mudflat SR with 4.3 (1.0%, mudflat SR, spring) to 45.5 gC m⁻² (16.7%, seagrass bed MO, autumn). In the seagrass beds, leaves and roots were occurring with biomass ranging from 1.6 (0.5%, seagrass SR, autumn) to 15.0 gC m⁻² (5.1%, seagrass MO, spring) and 0.3 (0.1%, seagrass SR, autumn) to 24.4 gC m⁻² (8.2%, seagrass MO, autumn). Bacteria represented the lowest biomass in all habitats with 0.6 (0.9%, sandflat SR, autumn) to 20.1 gC m⁻² (4.5%, mudflat SR, spring). Some differences of food source biomass could be observed between the surface and the sub-surface layers, always with higher biomass in the surface layer when they occurred: detrital matter in mudflat SR in spring and in seagrass MO in autumn, bacteria in mudflat SR in spring, and benthic microalgae in all habitats in all seasons except for mudflat SR and sandflat SR in autumn (two-way ANOVA with Tukey *post-hoc* test, highest p-value 0.032).

The average hierarchical cluster of dissimilarities highlighted that food source composition in the sandflat SR was different than in the other habitats (Fig. 3.3a), due to the much lower biomass of SOM in sandflat SR (29.2 gC m⁻²) than in mudflats and seagrass beds (256.6 gC m⁻²; two-way ANOVA with Tukey *post-hoc* test, $p < 0.001$, Fig. 3.3c and 2.3e). Benthic microalgae biomass was much higher in sandflat SR (54.2 gC m⁻²) than in mudflat SR (27.8 gC m⁻²), mudflat MO (10.5 gC m⁻²) and seagrass MO (22.6 gC m⁻², two-way ANOVA with Tukey *post-hoc* test, $p < 0.001$). Food source composition in both mudflats and both seagrass beds of the two bays appeared to be similar as highlighted by the clustering but some variations could be pointed out based on the two-way ANOVA. Biomass of bacteria in spring was higher in mudflat SR (13.5 gC m⁻²) compared to mudflat MO (3.9 gC m⁻²), seagrass MO (4.2 gC m⁻²), seagrass SR (6.9 gC m⁻²) and sandflat SR (1.8 gC m⁻², two-way ANOVA with Tukey *post-hoc* test, $p < 0.001$). The presence of detrital matter in mudflat SR versus its absence in mudflat MO discriminated both mudflats as well. Lastly, biomass of leaves and roots in spring was higher in the Marennes-Oléron Bay (39.4 gC m⁻²) compared to the Sylt-Rømø Bight (6.4 gC m⁻², two-way ANOVA with Tukey *post-hoc* test, $p < 0.001$).

Some differences occurred at the seasonal scale as well, with higher biomass of primary producers in spring when a difference occurred. Such a pattern was observed for benthic microalgae in sandflat SR, seagrass SR and seagrass MO, and for seagrass leaves in seagrass bed MO (two-way ANOVA with Tukey *post-hoc* test, $p < 0.001$). Bacteria biomass of mudflat SR and seagrass SR was also higher in spring compared to autumn (two-way ANOVA followed by Tukey *post-hoc* test, $p < 0.001$). About detrital matter, seasonal changes followed an opposite pattern when they occurred, with an increase in biomass of detritus from spring to autumn in mudflat SR and seagrass MO (two-way ANOVA with Tukey *post-hoc* test, $p < 0.001$). SOM biomass was stable between spring and autumn (two-way ANOVA with Tukey *post-hoc* test, lowest p-value 0.44).

Regarding quality of potential food sources in the different habitats, they varied from being partly detrital in sandflat SR (57 to 63%) to being almost completely made out of detrital matter in mudflat MO (from 93 to 99%). Carbon: chlorophyll *a* (C:chl *a*) ratios of SOM were higher in mudflat MO (1201.4), mudflat SR (681.8) and seagrass MO (504.6) compared to seagrass SR (221.4) and sandflat SR (72.3; two-way ANOVA with Tukey *post-hoc* test, $p < 0.001$, Table 3.1). SOM had much higher C:chl *a* ratios in the sub-surface layer than in the surface layer (two-way ANOVA with Tukey *post-hoc* test, $p < 0.001$). Variation in C:chl *a* ratios between spring and autumn was not observed (two-way ANOVA, lowest p -value 0.33, Table 3.1). Proportions of SOM that were originating from fresh microalgae (i.e., microphytobenthos and trapped phytoplankton) ranged from 3.6 (mudflat MO, spring) to 71.1% (sandflat SR, autumn, Table 3.1). These proportions were much higher in sandflat SR (66.6%) and seagrass SR (22.0%) than in mudflat SR (7.0%) and mudflat MO (4.0%, two-way ANOVA with Tukey *post-hoc* test, Table 3.1). Quantities of SPOM ranged between 0.32 and 0.54 gC L⁻¹. Minor variations between habitats observed within SPOM are reported in the supplementary material (Appendix 3.4).

Table 3.1. Carbon: chlorophyll *a* ratios (mean \pm standard deviation, $n = 3$) and percentage of carbon originating from fresh microalgae (mean \pm standard deviation, %, $n = 3$) in sediment organic matter (SOM) in the mudflats, seagrass beds and sandflat in the Marennes-Oléron Bay (MO) and the Sylt-Rømø Bight (SR) in spring and autumn.

Habitat	Carbon: chlorophyll <i>a</i> ratio		Carbon of SOM originating from fresh microalgae	
	Spring	Autumn	%	
	Spring	Autumn	Spring	Autumn
Mudflat MO	1314.3 ^E \pm 35.3	1088.5 ^D \pm 166.2	3.6 ^A \pm 0.1	4.4 ^A \pm 0.7
Mudflat SR	643.9 ^C \pm 60.1	719.7 ^C \pm 60.6	7.4 ^A \pm 0.7	6.6 ^A \pm 0.6
Seagrass MO	389.2 ^B \pm 47.5	619.9 ^C \pm 47.6	12.4 ^{AB} \pm 1.4	7.7 ^A \pm 0.6
Seagrass SR	193.9 ^A \pm 14.3	249.0 ^{AB} \pm 29.8	24.6 ^C \pm 1.8	19.3 ^{BC} \pm 2.4
Sandflat SR	76.8 ^A \pm 2.2	67.8 ^A \pm 9.1	62.0 ^D \pm 1.7	71.1 ^D \pm 9.8

Letters displayed after mean values indicate grouping of similar samples (two-way ANOVA with Tukey *post-hoc* tests, $p < 0.05$).

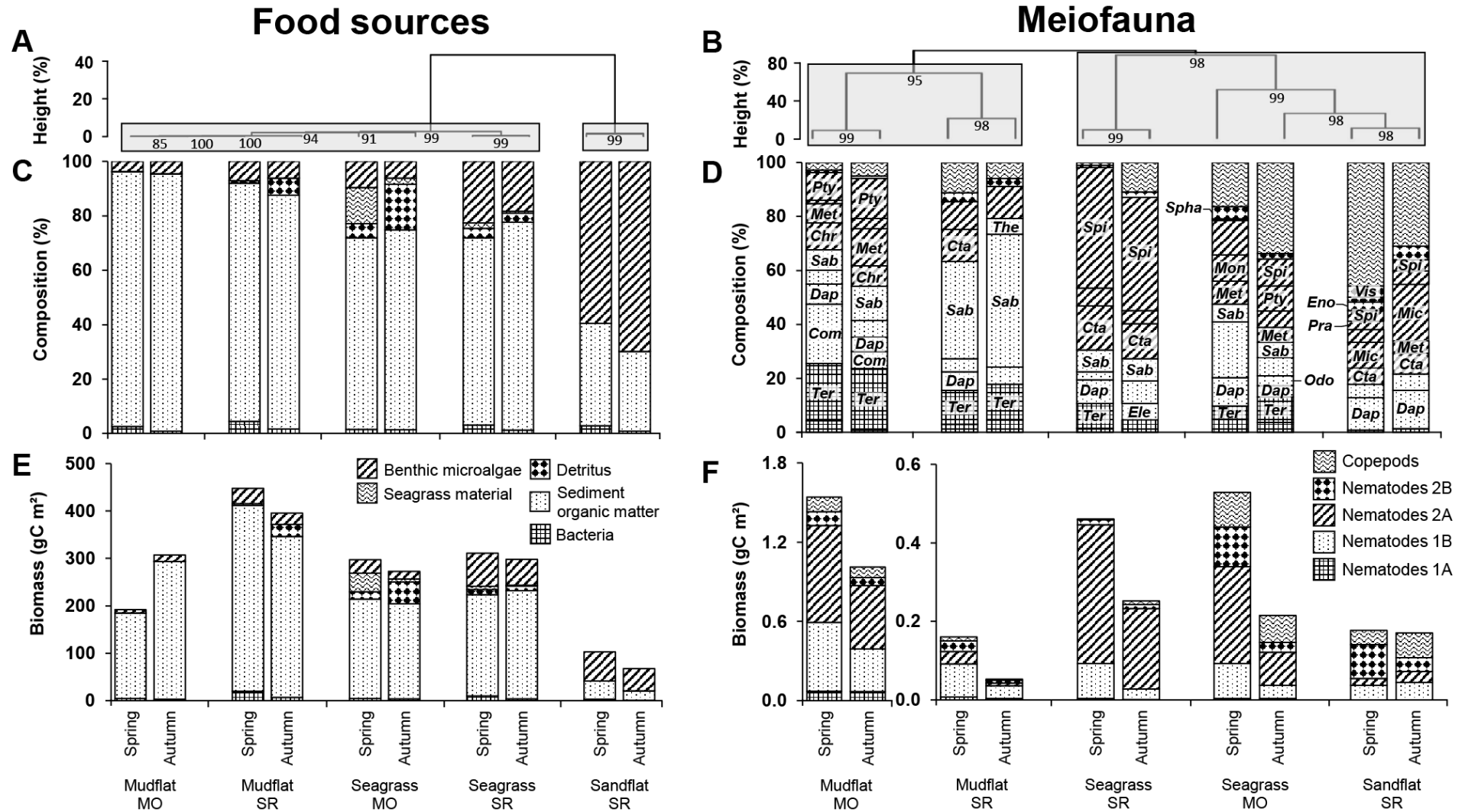

Figure 3.3a-f. Composition of potential benthic food sources for meiofauna and of meiofauna in the mudflats, seagrass beds and sandflat in the Marennes-Oléron Bay (MO) and the Sylt-Rømø Bight (SR) in spring and autumn. **a)** Hierarchical average cluster of dissimilarity for the proportional composition of potential food sources. **b)** Hierarchical average cluster of dissimilarity for proportional composition of meiofauna (nematodes and benthic copepods). Approximately, unbiased (AU) probability values (p-values) by multiscale bootstrap resampling are under each node and clusters (AU \geq 95%) are highlighted with gray rectangles. **c)** Proportional composition of potential food sources. **d)**

Proportional composition of benthic copepods and trophic groups of nematodes. Trophic groups of genera with relative abundance > 5% are displayed. e) Biomass of potential food sources. f) Biomass of benthic copepods and trophic groups of nematodes. Selective deposit feeders = 1A, non-selective deposit feeders = 1B, epigrowth feeders = 2A and omnivores/predators = 2B (Wieser 1953). Abbreviations: Chr = *Chromadora*, Cta = *Chromadorita*, Com = *Comesa*, Dap = *Daptonema*, Ele = *Eleutherolaimus*, Eno = *Enoplolaimus*, Met = *Metachromadora*, Mic = *Microlaimus*, Mon = *Monoposthia*, Odo = *Odontophora*, Pra = *Praeacanthochus*, Pty = *Ptycholaimellus*, Sab = *Sabatieria*, Spha = *Sphaerolaimus*, Spi = *Spirinia*, Ter = *Terschellingia*, The = *Theristus*, Vis = *Viscosia*. ($n = 3$)

3.3. Meiofauna community structure

The meiofauna community was dominated by nematodes with relative abundance ranging from 41.7% (sandflat SR, surface layer, spring) to 100% (mudflat MO, sub-surface layer, spring), except for the surface layer of sandflat SR where benthic copepods dominated (55.5%, Fig. 3.4). Three other meiofauna taxa occurred in the different habitats: foraminifera (0 to 7.4%), polychaetes (0 to 5.3%), and ostracods (0 to 0.4%). Total meiofauna density was higher in the surface layer than in the sub-surface layer in all habitats (two-way ANOVA with Tukey *post-hoc* test, highest p-value 0.033). Mean meiofaunal density of both layers combined ranged from $1.7 \cdot 10^5$ ind. m^{-2} (mudflat SR, autumn) to $3.4 \cdot 10^6$ ind. m^{-2} (mudflat MO, autumn, Appendix 1.5). Meiofauna densities (both layers combined) were similar between spring and autumn, except in seagrass SR where densities were higher in spring (two-way ANOVA with Tukey *post-hoc* test, highest p-value 0.020, Table 3.2).

The total biomass of nematodes (both layers combined) ranged from 0.053 gC m^{-2} ($1.6 \cdot 10^5$ ind. m^{-2} , mudflat SR, autumn) to 1.541 gC m^{-2} ($2.9 \cdot 10^6$ ind. m^{-2} , mudflat MO, spring, Fig. 3f). Nematode density and biomass were higher in the surface layers than in the sub-surface layers (two-way ANOVA with Tukey *post-hoc* test, highest p-value 0.042). Nematodes from the surface layers dominated the contribution to the total biomass in all habitats, with lowest proportions in seagrass SR (54.0%) and mudflat SR (55.4%) and higher proportions in sandflat SR (82.3%), mudflat MO (83.3%) and seagrass SR (95.7%). At the habitat scale, nematode density and biomass were much higher in mudflat MO (density: $3.0 \cdot 10^6$ ind. m^{-2} ; biomass: 1.257 gC m^{-2}) than in all other habitats (two-way ANOVA with Tukey *post-hoc* test, $p < 0.001$, Table 3.2, Appendix 1.5). Nematode biomass in the seagrass beds ranged from 0.146 (seagrass MO, autumn) to 0.459 gC m^{-2} (seagrass SR, spring). Nematode biomass of the mudflat SR and sandflat SR ranged from 0.054 (mudflat SR, autumn) to 0.150 gC m^{-2} (mudflat SR, spring). Some temporal variations occurred as well, with higher nematode densities in spring in seagrass SR and higher nematode biomass in spring in mudflat MO (two-way ANOVA with Tukey *post-hoc* test, highest p-value 0.005, Table 3.2).

Total biomass of benthic copepods, which were merely present in the surface layers, ranged from 0.003 gC m^{-2} ($1.0 \cdot 10^4$ ind. m^{-2} , mudflat SR, autumn) to 0.110 gC m^{-2} ($1.7 \cdot 10^5$ ind. m^{-2} , mudflat MO, spring, Fig. 3.3f). Copepod biomass of the mudflat MO (0.095 gC m^{-2}) was much higher than in the mudflat SR (0.006 gC m^{-2}), while copepod density was higher in the seagrass MO than in the seagrass SR and mudflat SR (two-way

ANOVA with Tukey *post-hoc* test, $p < 0.001$). Densities and biomass of benthic copepods were similar in spring and autumn (two-way ANOVA with Tukey *post-hoc* test, lowest p -value 0.178, Table 3.2).

Table 3.2. Results of the two-way ANOVA for differences in total meiofauna, nematode, and benthic copepod density and nematode and benthic copepod biomass across habitats and seasons.

Source	Total meiofauna			Nematodes		Benthic copepods	
	df	F-ratio	$P > F$	F-ratio	$P > F$	F-ratio	$P > F$
Density							
Habitat	4	363.0	< 0.001	385.8	< 0.001	12.7	< 0.001
Season	1	6.3	0.020	9.6	0.005	1.9	0.178
Habitat : season	4	8.8	< 0.001	9.1	< 0.001	2.8	0.052
Error	20						
Biomass							
Habitat	4			216.2	< 0.001	29.01	< 0.001
Season	1			34.5	< 0.001	0.47	0.503
Habitat : season	4			11.7	< 0.001	2.14	0.113
Error	40						

df = degree of freedom; F = F statistic; P = probability. Values in bold indicate a significant difference ($\alpha \leq 0.05$)

3.4. Nematode community structure

Five-thousand and four-hundred nematodes were determined at genus and/or species level. A total of 139 species, belonging to 65 genera and 20 families, were found at the five habitats in both the Marennes-Oléron Bay and the Sylt-Rømø Bight. Eight genera represented 70% of the community in the surface layer of all habitats combined: *Daptonema* (1B, 18%), *Chromadorita* (2A, 10%), *Metachromadora* (2A, 10%), *Sabatieria* (1B, 10%), *Ptycholaimellus* (2A, 7%), *Spirinia* (2A, 6%), *Terschellingia* (1A, 5%), and *Praeacanthonus* (2A, 4%). Four genera represented 70% of the community in the sub-surface layer of all habitats combined: *Terschellingia* (1A, 28%), *Sabatieria* (1B, 25%), *Spirinia* (2A, 13%), and *Metachromadora* (2A, 6%). The surface layer had a higher number of genera (from 3 to 9 genera, mean: 5.8) that represented 75% of the community compared to the sub-surface layer (from 2 to 9 genera, mean: 3.4) for all habitats. The ten most dominant genera per habitat, season and sediment layer are presented in the supplementary material (Appendix 3.6). Species richness varied from 8 to 28, Hill's diversity from 2.3 to 19.1, and species evenness from 0.41 to 0.88 (Table 3.3). Species richness, diversity and evenness decreased with depth at all habitats (two-way ANOVA, $p < 0.001$, Table 3.4). Species richness and evenness were higher at the seagrass MO than at the mudflat SR and the seagrass SR (two-way ANOVA with Tukey *post-hoc* test, $p < 0.001$). Hills diversity was higher at the seagrass MO than at all other habitats (two-way ANOVA with Tukey *post-hoc* test, $p < 0.001$). There was no difference in diversity and evenness between seasons (two-way ANOVA, lowest p -value 0.126, Table 3.4).

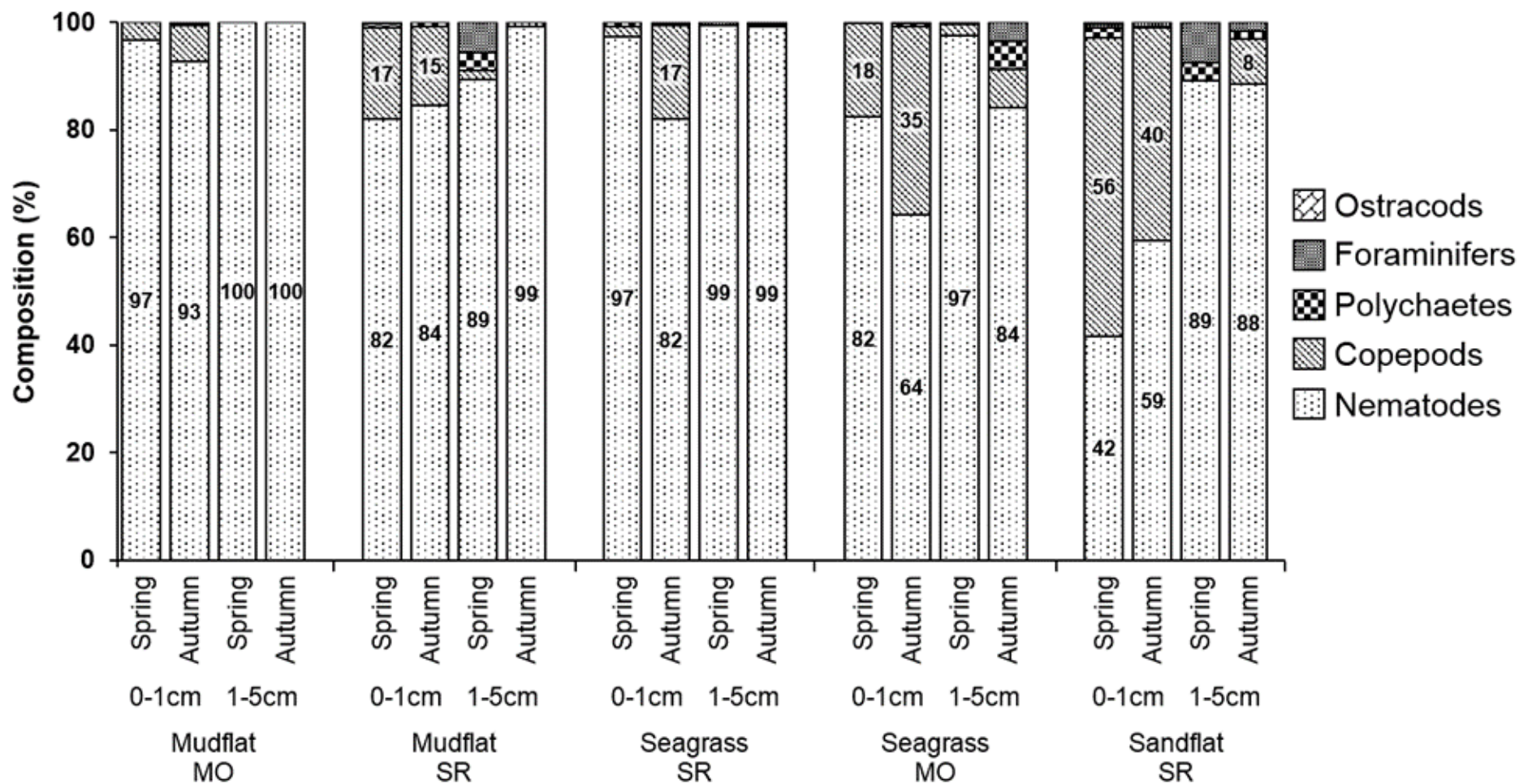

Figure 3.4. Proportional composition of meiofauna in the mudflats, seagrass beds and sandflat in the Marennes-Oléron Bay (MO) and the Sylt-Rømø Bight (SR) in spring and autumn and in both sediment layer (0-1cm and 1-5cm). Densities (%) are indicated when > 7.5%. ($n = 3$)

Table 3.3. Number of nematode genera, Hill's diversity (N_I), and species evenness (J') in the mudflats, seagrass beds and sandflat in the Marennes-Oléron Bay (MO) and the Sylt-Rømø Bight (SR) in spring and autumn. ($n = 3$)

	Mudflat MO		Mudflat SR		Seagrass SR		Seagrass MO		Sandflat SR	
	Spring	Autumn	Spring	Autumn	Spring	Autumn	Spring	Autumn	Spring	Autumn
Layer (in cm)	0-1	1-5	0-1	1-5	0-1	1-5	0-1	1-5	0-1	1-5
Species richness	22	11	21	13	23	12	15	13	16	11
Hill's diversity (N_I)	14	5	12	6	13	4	9	5	7	3
Species evenness (J')	0.9	0.6	0.8	0.7	0.8	0.6	0.8	0.6	0.7	0.5

Table 3.4. Results of the two-way ANOVA for differences in species richness, Hill's diversity (N_I), and species evenness (J') between habitats, sediment layers and season in the mudflats, seagrass beds and sandflat in the Marennes-Oléron Bay and the Sylt-Rømø Bight.

Source	Species richness			Hill's diversity		Species evenness	
	df	F-ratio	$P > F$	F-ratio	$P > F$	F-ratio	$P > F$
Layer	1	88.3	< 0.001	149.6	< 0.001	55.9	< 0.001
Habitat	4	11.0	< 0.001	29.0	< 0.001	16.2	< 0.001
Season	1	0.1	0.802	2.4	0.126	0.0	1.000
Layer : habitat	4	1.5	0.214	4.75	0.003	4.5	0.005
Layer : season	1	6.4	0.015	3.3	0.078	0.6	0.452
Habitat : season	4	3.1	0.026	1.9	0.134	0.3	0.878
Layer : habitat : season	4	2.3	0.079	2.5	0.062	2.3	0.077
Error	38						

df = degree of freedom; F = F statistic; P = probability. Values in bold indicate a significant difference ($\alpha \leq 0.05$)

Community compositions, based on proportions of benthic copepods and of trophic groups of nematodes, were similar between the two mudflats (besides the very large difference of biomass), as highlighted by the average hierarchical cluster analysis ($p < 0.05$, Fig. 3.3b). The sandflat SR and the two seagrass beds had similar communities as well. The difference of trophic structures between the mudflats and the other habitats was related to the higher proportions of selective deposit-feeders (1A) and of non-selective deposit-feeders (1B) in the mudflats. The mudflat MO was dominated by genera belonging to non-selective deposit feeders (36%, 0.579 gC m^{-2}), epigrowth feeders (34%, 0.525 gC m^{-2}), and selective deposit feeders (25%, 0.071 gC m^{-2}) with *Terschellingia* (1A, 22%, 0.055 gC m^{-2}), *Comesa* (1B, 14%, 0.082 gC m^{-2}) and *Ptycholaimellus* (2A, 13%, 0.048 gC m^{-2}) being the most common genera (Fig. 3.3d). At the mudflat SR, the non-selective deposit feeders dominated (55%), and the most abundant genera were *Sabatieria* (1B, 43%, 0.042 gC m^{-2}) and *Terschellingia* (1A, 13%, 0.004 gC m^{-2}). The seagrass bed SR was dominated by epigrowth feeders with the genera *Spirinia* (2A, 46%, 0.225 gC m^{-2}) and *Chromadorita* (2A, 16%, 0.026 gC m^{-2}). The seagrass bed MO was dominated by various genera belonging to epigrowth feeders (31%, 0.165 gC m^{-2}) and non-selective

deposit feeders (29%, 0.061 gC m⁻²). There, the biomass of nematodes was dominated by the epigrowth feeder genera *Metachromadora* (7%, 0.035 gC m⁻²). The sandflat SR was dominated by genera belonging to epigrowth feeders (35%, 0.023 gC m⁻²) and non-selective deposit feeders (19%, 0.040 gC m⁻²), with the genera *Microloaimus* (2A, 15%, 0.006 gC m⁻²) and *Daptonema* (1B, 13%, 0.028 gC m⁻²) being the most common.

3.5. Relationships between environmental parameters and meiofauna trophic structure

The PCA on the environmental variables explained 63.2% of the total variation (Axis 1: 39.9%, Axis 2: 23.3%, Fig. 3.5a). Axis 1 highlights a positive relationship between SPOM, benthic microalgae and sediment grain size. At the opposite, when biomass of benthic microalgae, SPOM and sediment grain size was low, quantities of SOM were higher, as well as bacteria and detritus biomass, and carbon:chlorophyll *a* ratios of SOM. Axis 2 demonstrates that biomass of bacteria increased with biomass of SOM, SPOM, and benthic microalgae. Sandflat SR is defined by larger sediment grain size, higher biomass of benthic microalgae and of SPOM, as highlighted on Axis 1. Axis 1 also discriminates seagrass SR from mudflat SR, mudflat MO and seagrass MO (autumn), the later ones being characterized with lower biomass of benthic microalgae and SPOM and/or higher carbon:chlorophyll *a* ratios of SOM, and higher biomass of SOM and detritus. In spring Axis 2 discriminates well the mudflat and seagrass bed in the Marennes-Oléron Bay compared to the Sylt-Rømø Bight, which could be due to higher biomass of bacteria (mudflat SR) and/or benthic microalgae (seagrass SR). In terms of temporal variations, Axis 1 highlights low variation in environmental variables between spring and autumn except for seagrass MO, which could be due to a significant increase in biomass of detritus from spring to autumn in this habitat. Axis 2 highlights a stronger temporal variation (Fig. 3.5a), especially in seagrass SR, seagrass MO and mudflat SR. For seagrass SR, this could be due to a decrease in bacteria, benthic microalgae, SPOM and SOM biomass from spring to autumn, as well as an increase in detrital matter, while changes in seagrass MO may be related to opposite patterns. For mudflat SR, variations could be explained by the decrease in biomass of benthic microalgae and bacteria and/or the increase in detritus biomass from spring to autumn.

The redundancy analyses (RDA) represented 51.8% of the total variation and 81.1% of the constrained variation (Fig. 3.5b). Fresh seagrass material was excluded from the RDA after stepwise forward selection of constraints due to collinearity ($vif.cca > 10$). Axis 1 explains 33.0% of the total variation and 51.8% of the constrained variation. Axis 2 explains 18.8% of the total variation and 29.4% of the constrained variation. Both axes significantly explain the model, which highlights relationships between differences of communities and environmental parameters, particularly biomass of benthic microalgae, SPOM, detritus, SOM, carbon:chlorophyll *a* ratios and sediment grain size. Patterns highlighted by Axis 1 about environmental parameters were similar as those highlighted in the PCA: there was a positive relationship between benthic microalgae and SPOM biomass, and sediment grain size. At the opposite, when benthic microalgae, SPOM and detritus biomass were low, the carbon:chlorophyll *a* ratio was higher, as well as biomass of SOM, bacteria and detritus. Differences of meiofauna trophic structure within habitats are mainly explained by sediment grain-size, carbon:chlorophyll *a* ratio of SOM, and biomass of SOM, SPOM, detritus, benthic microalgae, and

bacteria (Fig. 3.5). The two major groups affected by changes in abiotic and biotic parameters were nematodes and benthic copepods. Selective deposit feeders and non-selective deposit feeders occurred mainly within habitats where biomass of SOM, detritus and bacteria were high (i.e., surface layers of mudflat SR in autumn sub-surface layers of mudflat SR in both seasons, sub-surface layers of seagrass MO in both seasons, and sub-surface layers of mudflat MO in autumn). Epigrowth feeders dominated in habitats where benthic microalgae were an important driving factor (i.e., surface layers of mudflat MO in both seasons, sub-surface layers of mudflat MO in spring, surface and sub-surface layers of seagrass SR in both seasons, and sub-surface layers of sandflat SR in both seasons). Omnivore/predatory nematodes, benthic copepods and other meiofauna taxa occurred in habitats with high biomass of benthic microalgae and SPOM, as well as large sediment grain-size (i.e., surface and sub-surface layers of sandflat SR in both seasons and surface layers of seagrass MO in both seasons, and surface layers of mudflat SR in spring).

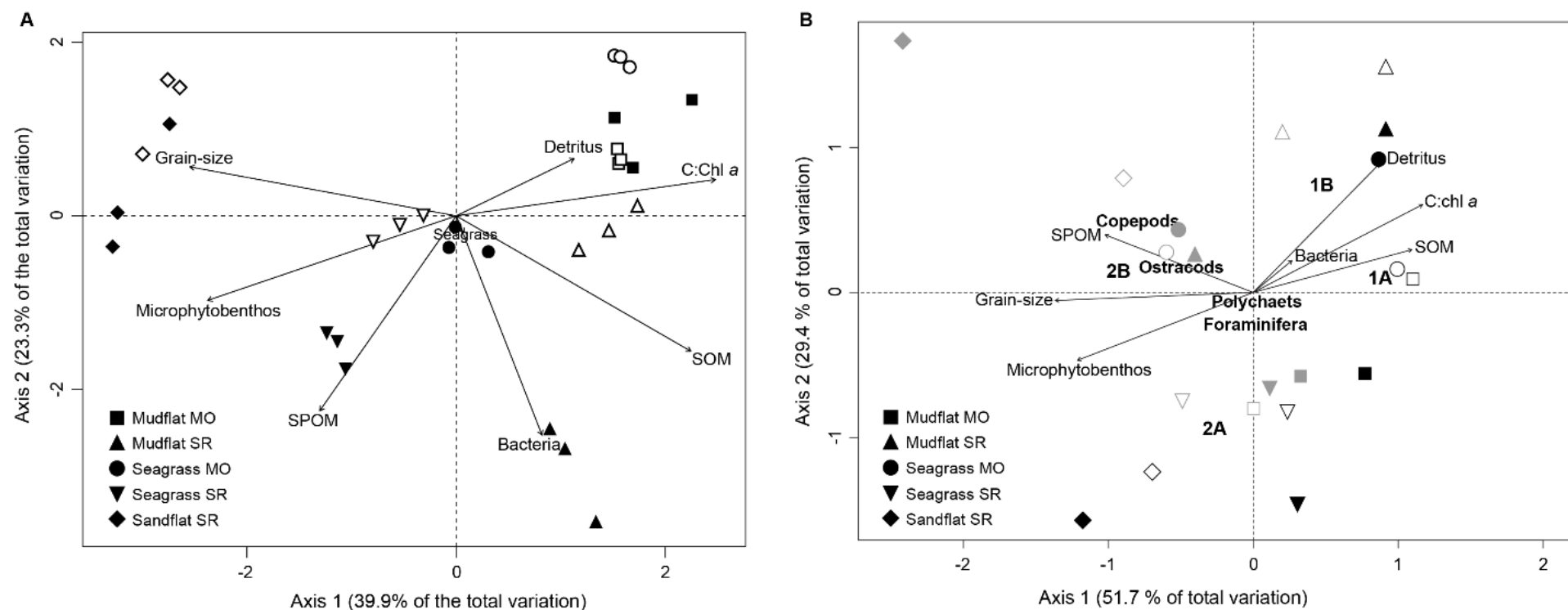

Figure 3.5a-b. **a**) Principal component analyses for the environmental factors (arrows) plotted for the mudflats, seagrass beds and sandflat in the Marennes-Oléron Bay (MO) and the Sylt-Rømø Bight (SR) in spring (closed symbols) and autumn (open symbols). **b**) Redundancy relationship analyses of environmental factors (arrows) selected with stepwise forward procedure plotted against the different groups of meiofauna (benthic copepods, polychaetes, foraminifers, ostracods and trophic groups of nematodes) and the surface (gray symbols) and sub-surface layers (black symbols) of the mudflats, seagrass beds and sandflat in the Marennes-Oléron Bay (MO) and the Sylt-Rømø Bight (SR) in spring (closed symbols) and autumn (open symbols). Abbreviations: SPOM = suspended particulate organic matter; SOM = sediment organic matter; 1A = nematodes, selective deposit feeders; 1B = nematodes, non-selective deposit feeders; 2A = nematodes, epigrowth feeders; 2B = nematodes, omnivores/predators.

A regression using nematode feeding type data from all habitats highlighted that the ratios between densities of epigrowth feeders and densities of non-selective deposit feeders increased when benthic microalgae biomass increased ($F[1, 8] = 10.4$, $p = 0.01$, $r^2 = 0.61$, Fig. 3.6). The relative abundance of selective deposit feeders was positively correlated to the ratio between biomass of fresh organic material (i.e., benthic microalgae and seagrass leaves and roots) and biomass of detrital material (i.e., SOM and detritus) ($F[1, 8] = 23.1$, $p < 0.01$, $r^2 = 0.74$, Fig. 3.7).

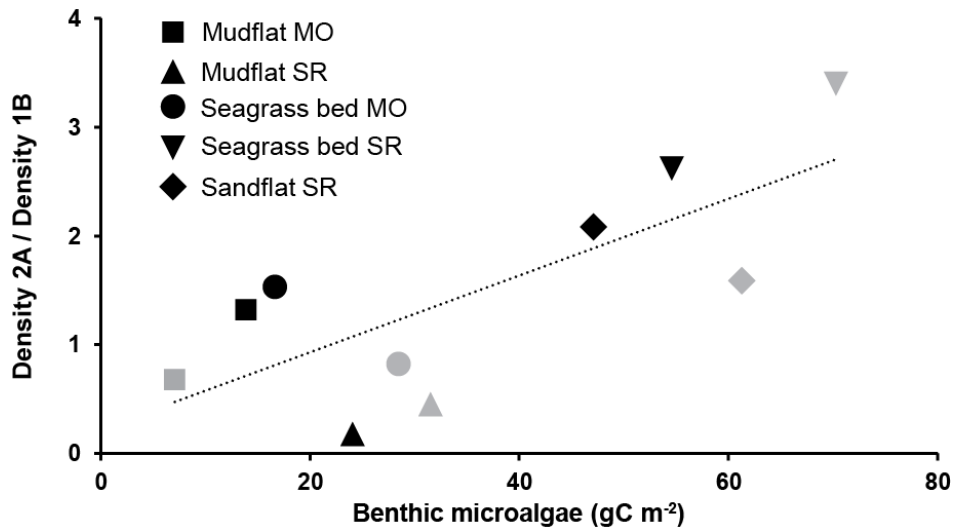

Figure 3.6 Relationship between the biomass of benthic microalgae and the ratio between densities of epigrowth feeders (2A) and densities of non-selective deposit feeders (1B) in the mudflats, seagrass beds and sandflat in the Marennes-Oléron Bay (MO) and the Sylt-Rømø Bight (SR) in spring (gray symbols) and autumn (black symbols). ($n = 3$)

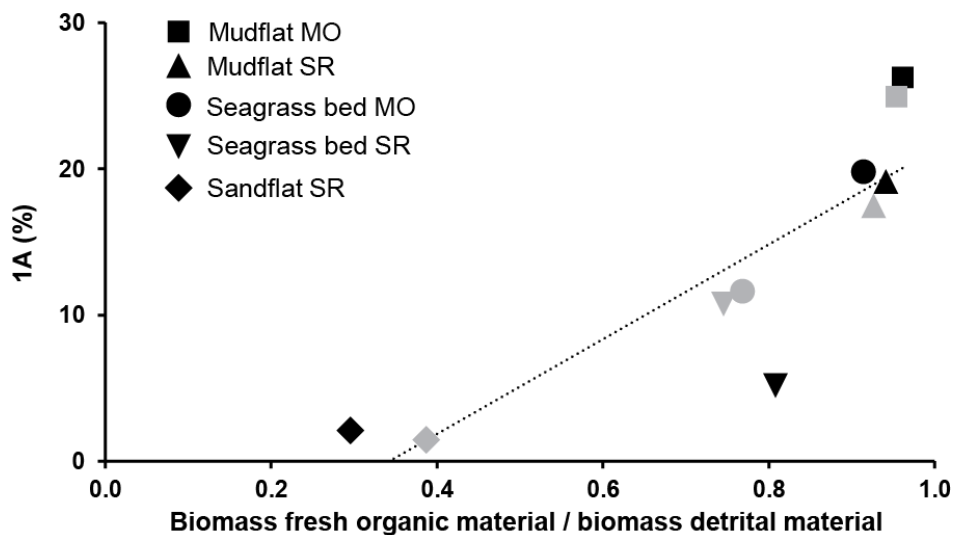

Figure 3.7. Relationship between the ratio of fresh organic material to detrital material and the relative abundance of selective deposit feeders (1A) in the mudflats, seagrass beds and sandflats in the Marennes-Oléron Bay (MO) and the Sylt-Rømø Bight (SR) in spring (gray symbols) and autumn (black symbols). ($n = 3$)

4. DISCUSSION

4.1. Habitat description

The different habitats compared in this study are characterized by a broad range of abiotic and biotic factors. This provides a good framework to determine how changes in these parameters, particularly potential food resources, may influence meiofauna community structure. Biomass of benthic microalgae was much higher in habitats with a larger sediment grain size (sandflat SR and seagrass SR) as already observed in the Marennes-Oléron Bay (Guarini et al. 1998), and benthic microalgae therefore represented a much higher proportion of the SOM in these habitats. This pattern is quite unusual, as habitats with large sediment grain size generally support less microphytobenthos biomass than habitats with small sediment grain size (Cammen 1991; de Jong and de Jonge 1995). Estimations of benthic microalgae biomass were based on chlorophyll *a* measurements and therefore included trapped fresh phytoplankton. Trapped phytoplankton represents a lower proportion of fresh microalgae material than benthic microphytobenthos, although some variations can occur depending on seasons and locations (Asmus 1983; Lebreton et al. 2012). Microphytobenthos community structure and its production may change as well depending on habitats: muddy sediments are usually dominated by large epipellic diatoms (Thornton et al. 2002; Azovsky et al. 2004) whereas small epipsammic diatoms are the main taxa in sandy habitats (Asmus and Bauerfeind 1994; Azovsky et al. 2004). Benthic microalgae production can be very high in muddy sediments (i.e., 372 gC m⁻² yr⁻¹ in mudflat MO) (Pinckney and Zingmark 1993; Leguerrier et al. 2003) and, under favorable conditions, epipellic diatoms can double their standing stock on a daily basis (Underwood and Paterson 1993). All these changes of biomass, community structure and production rates likely affect the use of this food resource by meiofauna.

Biomass of SOM was much lower in sandflat SR than in seagrass beds and mudflats. This is likely related to the high benthic microalgae production in bare mudflats (MacIntyre et al. 1996) and to the smaller sediment grain size in mudflats and seagrass beds (Bergamaschi et al. 1997). A decrease in sediment grain size generally leads to an increase in SOM (Bergamaschi et al. 1997) as fine particles enhance adsorption of organic compounds (Mayer 1994). Decrease of sediment grain size is also associated with lower hydrodynamics which increases sedimentation of organic matter particles (Frontalini et al. 2014) and of finer sediment. The presence of seagrass beds, reducing hydrodynamics and enhancing sedimentation as well (Leduc et al. 2009), also likely increased the load of SOM. As a result, even if SPOM was relatively similar between habitats, the presence of meadows may influence the biomass and the nature of the organic matter available to meiofauna between unvegetated and vegetated habitats (Machás and Santos 1999). The quality of the organic matter available to consumers was also correlated with sediment grain size, with SOM dominated by fresh organic matter in the sandflat and being of much lower quality in habitats made of fine sediments (seagrass bed and mudflats), where loads of detrital matter were higher.

Loads of detritus were high in seagrass beds, the largest ones being measured in seagrass MO, probably due to the much higher biomass of seagrass roots in this habitat compared to seagrass SR. The higher load of

detrital matter in mudflat SR compared to mudflat MO is much likely related to the proximity between the mudflat and the seagrass bed in the Sylt-Rømø Bight, highlighting that seagrass material can be exported to bare systems. The presence of seagrass in intertidal systems may also indirectly affect the composition of the detrital organic matter available to meiofauna and meiofauna distribution in the sediment (Marbà et al. 2006). The complex root structure of seagrass beds indeed plays a role for the amount of fine particles and detritus associated with the shallow oxic zone in vegetated sediments (Wetzel et al. 2001), as well as in the release of oxygen and dissolved organic matter by the roots (Pedersen et al. 1998). Nevertheless, seagrass material is generally poorly used by most of the consumers as fresh or as detrital material (Danovaro 1996; Vizzini et al. 2002). The presence of seagrass and detritus as well as smaller sediment grain size also affected the abundance of bacteria within the studied habitats. Much lower biomass of bacteria was observed in habitats with lower quantities of detrital matter and SOM and in habitats with coarser sediment (i.e., sandflat), likely due to the reduced surface for bacteria colonization (Dale 1974; Mayer 1994).

4.2. Meiofauna community structure: spatial and temporal variations

Meiofauna density and biomass varied highly within habitats and ecosystems, with lowest and highest values observed in mudflat SR (density: $0.17 \cdot 10^6$ ind. m^{-2} , biomass: 0.057 gC m^{-2}) and mudflat MO (density: $3.36 \cdot 10^6$ ind. m^{-2} , biomass: 1.598 gC m^{-2}), respectively. Meiofauna in all habitats were dominated by nematodes, followed by benthic copepods, as typically observed in intertidal habitats (Armonies and Hellwig-Armonies 1987; Rzeznik-Orignac et al. 2003; Leduc and Probert 2011). Data comparisons (Table 3.5) highlight that density and biomass of nematodes and benthic copepods measured in this study are in the range of those previously measured but, more generally, that these values can be highly variable between different soft-bottom habitats as well as within similar habitats (Heip et al. 1985; Castel et al. 1989; Kotwicki et al. 2005b).

In terms of community structure, proportions of benthic copepods increased from habitats with a lower complexity (mudflats: 6.2%) to habitats with a higher complexity caused by a higher seagrass biomass (seagrass beds: 15.5%) or by larger sediment grain size (sandflat: 38.4%). Larger proportions of copepods in the sandflat could be explained by a higher feeding efficiency in sandier sediment, probably due to a better accessibility to benthic microalgae and a better ability of these grazers to move in sand (de Troch et al. 2006a). Higher proportions of benthic copepods in seagrass bed MO may be related to a more developed seagrass bed and therefore a more complex habitat, providing a larger diversity of ecological niches (Ndaro and Olafsson 1999; de Troch et al. 2001). The presence and development stage of seagrass beds also affected nematode diversity as species richness was higher in the most dense seagrass bed (Marennes-Oléron) between the two studied ones. Hill's diversity was also higher in seagrass MO than in all other habitats, which could be partially linked to habitat complexity as well (Austen et al. 1998; Steyaert et al. 2003; Giere 2009). Proportions of omnivore/predatory nematodes increased as well when complexity increased due to larger sediment grain size as previously observed in sandflats of several other coastal ecosystems (Warwick 1971; Steyaert et al. 2003). This could be explained by the increase of foraging efficiency of predators with an increase in sediment grain size (Gallucci et al. 2005).

If some patterns could be observed between meiofauna community structure and habitat type, direct relationships between biomass of food sources and density and/or biomass of nematodes and benthic copepods could not be observed in this study. This is very likely related to the diversity of feeding types observed in nematodes (Moens et al. 2005b; Vafeiadou et al. 2014) and, to a lower extent, in benthic copepods (Cnudde et al. 2015), confirming the importance of approaches carried out at the scale of the feeding type, as this was done for nematodes in this study.

Within these different habitats nematode density, biomass and diversity were similar between spring and autumn, except for higher nematode density in seagrass SR and higher nematode biomass in mudflat MO in spring. No temporal variation was observed for meiofauna community structure. The lack of a clear temporal pattern between spring and autumn (Escaravage et al. 1989; Danovaro and Gambi 2002; Rzeznik-Orignac et al. 2003) could be partly explained by low temporal variation in parameters strongly defining meiofauna community structure (i.e., food sources and sediment grain size; Moens et al. 2013).

4.3. Benthic microalgae and sediment organic matter are important drivers of nematode community structure

Changes in benthic microalgae biomass influenced the community structure of nematodes: relative abundance of epigrowth feeders, relying on benthic microalgae, were reduced when biomass of this food source decreased. Such a relationship between biomass of benthic microalgae and density of epigrowth feeders had already been observed in a subtidal seagrass meadow (Danovaro and Gambi 2002) and during grazing experiments (Rzeznik-Orignac and Fichet 2012). Buccal cavities of epigrowth feeders are appropriate for consumption of benthic microalgae, due to the presence of a dorsal tooth which is used to pierce diatoms (Wieser 1953; Moens and Vincx 1997b). A relationship was also observed between biomass of benthic microalgae and relative abundances of benthic copepods and omnivores/predators. However, this relationship may be partly mediated by sediment grain size as benthic microalgae biomass (this study) and relative abundance of benthic copepods increase when sediment get coarser (Hicks and Coull 1983). Nevertheless, the much higher biomass of benthic microalgae in the sandflat compared to SOM suggests that consumers rely—at least partly—directly (i.e., copepods) or indirectly (i.e., omnivores/predators) on benthic microalgae in this habitat. Such a dependence to benthic microalgae as a food source has been demonstrated for benthic copepods (Leduc et al. 2009).

Table 3.5. Density (ind. m⁻² * 10⁶) and biomass (in gC m⁻² and/or g dry weight m⁻²) of nematodes and benthic copepods in mudflats, seagrass beds (*Zostera* spp.) and sandflats from this study and from the available literature about marine soft-bottom intertidal systems. Average conversion factors used to estimate biomass in gC m⁻² from densities are: nematodes: 2.28*10⁶, benthic copepods: 3.49*10⁶, and from biomass (in g dry-weight m⁻²) are: nematodes: 3.26, benthic copepods: 3.40. Converted values are in italic.

Habitat type	Location	Density		Biomass (g dry weight m ⁻²)		Biomass (gC m ⁻²)		Reference
		Nematodes	Copepods	Nematodes	Copepods	Nematodes	Copepods	
Mudflat	Papanui Inlet, New Zealand	2.1–3.2	0.5–1.1	0.163	0.125	<i>0.05</i>	<i>0.04</i>	Leduc and Probert 2011
	Danish Wadden Sea, Denmark	0.22		0.03–0.4		<i>0.01–0.12</i>		Smidt 1951
	Sylt-Rømø Bight, Germany	0.28	0.03	0.233	0.015	0.102	0.006	This study
	Cornwall, U.K.	1.1				<i>0.48</i>		Ellison 1984
	Marenes-Oléron Bay, France	2.1				<i>0.92</i>		Rzeznik-Orignac et al. 2003
	Sylt-Rømø Bight, Germany	2.4	0.07			<i>1.05</i>	<i>0.02</i>	Armonies and Hellwig-Armonies 1987
	Lynher estuary, U.K.	0.8–22.9		1.4–3.4		<i>0.43–1.49</i>		Warwick and Price 1979
	Marenes-Oléron Bay, France					0.2–1.5	< 0.09	Pascal 2008
	Marenes-Oléron Bay, France	3.03	0.13	6.070	0.346	1.257	0.095	This study
	South Carolina, U.S.A.	2.3–4.4				<i>1.01–1.93</i>		Sikora and Sikora 1982
European estuaries	0.13–14.5				<i>0.06–6.35</i>		Soetaert et al. 1995	
Seagrass bed	Papanui Inlet, New Zealand	4.9–5.2	< 0.04	0.480	< 0.009	<i>0.15</i>	<i>< 0.003</i>	Leduc and Probert 2011
	Marenes-Oléron Bay, France	0.65	0.21	1.303	0.459	0.294	0.078	This study
	Sylt-Rømø Bight, Germany	0.81	0.04	0.819	0.015	0.351	0.006	This study
	Sylt-Rømø Bight, Germany	2.0				<i>0.88</i>		Armonies and Hellwig-Armonies 1987
	Arcachon Bay, France	5.5–8.0		2.4–5.3		<i>0.74–2.32</i>		Castel et al. 1989; Escaravage et al. 1989
	Mira estuary, Portugal	1.8–3.3				<i>0.79–1.46</i>		Materatski et al. 2018
	Marenes-Oléron Bay, France					2.75	0.36	Lebreton 2009
Sandflat	North Sea intertidal sandflats	0.15	0.11			<i>0.07</i>	<i>0.03</i>	Kotwicki et al. 2005a
	Sylt-Rømø Bight, Germany	0.22	0.14	0.303	0.130	0.124	0.050	This study
	Arcachon Bay, France	0.7–1.2		0.8–1.3		<i>0.25–0.57</i>		Castel et al. 1989; Escaravage et al. 1989
	Oosterschelde, Netherlands	5.0	0.13	2.0	0.2	<i>0.61</i>	<i>0.06</i>	Smol et al. 1994
	Sylt-Rømø Bight, Germany	2.3	3.5			<i>1.01</i>	<i>1.00</i>	Armonies and Hellwig-Armonies 1987
	European intertidal flats	0.24–4.1	< 0.35			<i>0.11–1.80</i>	<i>< 0.10</i>	Hicks and Coull 1983; Kotwicki et al. 2005b

At a more global scale (i.e., whole meiofauna, all habitats combined), no general pattern could be observed between benthic microalgae biomass and those of nematodes and benthic copepods. Some other parameters should probably be taken into account to better consider relationships between this food resource and consumers. Benthic microalgae can indeed reach very high production rates and are a food source of high quality (Cebrián 1999). The high primary production of benthic microalgae in mudflat MO ($372 \text{ gC m}^{-2} \text{ yr}^{-1}$; Leguerrier et al. 2003) and high grazing pressure on this food source by the large biomass of nematodes (Blanchard 1991) could explain the lack of relationship between benthic microalgae and meiofauna biomass within these habitats. Quality is of high importance as well: Moens et al. (1999b) suggested that meiofauna migrate actively towards 'optimal' food sources. In addition to epigrowth feeders, several studies demonstrated that deposit feeders rely on microalgae (Moens and Vincx 1997b; Rzeznik-Orignac et al. 2003; Vafeiadou et al. 2014) likely due to the better quality of microalgae. A relationship between density of nematodes belonging to these feeding groups and microalgae has been observed (Moens et al. 1999a). In particular, grazing experiments using ^{14}C labeled diatoms indicated the dependence of a non-selective deposit feeding nematode (*Daptonema*), an epigrowth feeding nematode (*Metachromadora*) and benthic copepods on microalgae (Rzeznik-Orignac and Fichet 2012). Vafeiadou et al. (2014), using stable isotopes, confirmed that non-selective deposit feeding nematodes, epigrowth feeding nematodes and benthic copepods can largely rely on benthic microalgae in sparsely covered seagrass beds. Besides their very specific buccal cavity, it is also worth noting that epigrowth feeders can be opportunistic as well, and rely on other food resources (e.g. bacteria and/or fungi; Iken et al. 2001). As a result, benthic microalgae are often considered as the principal food source for nematodes and benthic copepods (Moens et al. 2005a; Rzeznik-Orignac et al. 2008; Maria et al. 2012).

Benthic microalgae followed an opposite pattern than detrital material (SOM and detritus), with decreasing biomass of benthic microalgae when detrital material increased. SOM biomass was stable between spring and autumn, as well as between surface and sub-surface layers, but large variations were observed between the different habitats (i.e., much lower biomass in sandflat SR). The relative abundance of non-selective deposit feeders, closely related to detrital matter based on the RDA, decreased when biomass of SOM was lowered. Higher SOM quality in the surface sediment layers could lead to higher biomass, density and diversity of nematodes in the surface layer compared to the sub-surface layer. As a result, the important role of SOM is very likely related to its very high amount, as well as variations in quality between the studied systems. A relationship between SOM and density of non-selective deposit feeders was also recognized in a subtidal seagrass meadow (Danovaro and Gambi 2002), while a grazing experiment indicated that the non-selective and selective deposit feeding nematode species assimilated predominantly SOM and bacteria (Tietjen and Lee 1977). The non-selective deposit feeders can, therefore, be considered as opportunistic feeders (Majdi et al. 2012), which may change feeding strategies depending on the availability of food sources (Moens and Vincx 1997b; Rzeznik-Orignac et al. 2008).

As a result, SOM and benthic microalgae appear to be important biotic factors driving the nematode community structure and, *a fortiori*, the composition of meiofauna assemblages as nematodes represent a large

proportion of the meiofauna in coastal ecosystems (Armonies and Hellwig-Armonies 1987; Rzeznik-Orignac et al. 2003; Leduc and Probert 2011).

4.4. Role of bacteria as a food source?

Selective deposit feeders had much higher relative abundances in habitats with larger loads of detritus and SOM compared to those dominated by fresh material. In addition, multivariate analyses indicated that biomass of bacteria was higher when loads of SOM increased. These results highlight a probable relationship between bacteria biomass and relative abundance of selective deposit feeders, endorsing that consumers from this trophic group rely on bacteria (Moens and Vincx 1997b), which develop on detrital particles (Day et al. 1989; Danovaro 1996), or dissolved organic matter (Moens and Vincx 1997b). The use of bacteria as food resources has been confirmed by stable isotope studies demonstrating that selective deposit feeders can rely on sulfide-oxidizing bacteria (Vafeiadou et al. 2014), such specific diets being related to their small buccal cavity (Wieser 1953; Moens and Vincx 1997b). The lack of direct relationship between abundances of selective deposit feeders and biomass of bacteria, as in Semprucci et al. (2010), might be due to the influence of additional abiotic parameters (i.e., oxic conditions (Jensen 1983) and sediment grain size (Steyaert et al. 2003)), the reliance of bacteria on a large diversity of substrates (Boschker et al. 2000), and high bacterial production which is only partially grazed (< 28%, Pascal et al. 2009). This lack of clear relationship may also be related to some limits of the Wieser (1953) classification, highlighting the importance to combine buccal cavity observations with other methods such as trophic markers (i.e., stable isotopes, fatty acids).

Multivariate analyses demonstrated as well a relationship between relative abundances of non-selective deposit feeders and biomass of detritus and, to a lower extent, those of bacteria and SOM. Nevertheless, no direct relationship was observed between relative abundances of non-selective deposit feeders and bacteria, SOM or detritus biomass, which is likely related to the more opportunistic feeding behavior of these nematodes (Moens and Vincx 1997b; Rzeznik-Orignac et al. 2008; Majdi et al. 2012). The shape of the buccal cavity of non-selective deposit feeders allows them to rely on a much larger diversity of food sources: benthic microalgae, SOM, bacteria and seagrass detritus, as demonstrated by stable isotope studies (Rzeznik-Orignac et al. 2008; Maria et al. 2012; Vafeiadou et al. 2014) and observations of feeding behavior (Moens and Vincx 1997b). Biomass of fresh seagrass matter, which varied highly between habitats in this study, could also not be linked to variations in non-selective deposit feeders. However, the lack of relation here is expected since this resource is poorly used by these nematodes, and, to a larger extent, to meiofauna in general, due to its low nutritional value and high lignocellulose content (Vizzini et al. 2002). This was confirmed by Materatski et al. (2015) who observed no changes in nematode density before and after a seagrass collapse.

4.5. Effect of sediment depth on meiofauna communities: influence of oxic conditions

Nematode and benthic copepod densities and biomass decreased from surface to sub-surface layers in all habitats, which is a common pattern in seagrass beds and unvegetated habitats (Castel et al. 1989; Lebreton 2009; Leduc and Probert 2011). Benthic microalgae, which have the highest biomass in the surface layer, might influence the vertical distribution and migration of nematodes and benthic copepods (Moens et al. 2013),

particularly nematode epigrowth feeders which specifically rely on benthic microalgae and which were very abundant in all habitats. Differences in abiotic parameters, such as oxygen depletion towards deeper layers, could affect as well the vertical distribution of meiofauna (Steyaert et al. 2003; Vanaverbeke et al. 2004), as anoxic conditions are much less favorable to nematodes and benthic copepods. Besides influencing biomass and densities, anoxic conditions affect diversity and community structure as well. Diversity of nematodes clearly decreased with depth in all the studied habitats, which was observed in other studies (Steyaert et al. 2003; Leduc and Probert 2011). *Terschellingia* spp. and *Sabatieria* spp. had a higher relative abundance in sub-surface layers than in surface layers, related to their higher tolerance regarding hypoxic conditions (Steyaert et al. 2007). *Terschellingia* spp. and *Sabatieria* spp. are also known to feed on sulfide-oxidizing bacteria that occur in these hypoxic zones (Semprucci and Balsamo 2012; Vafeiadou et al. 2014).

5. CONCLUSION

Benthic microalgae and SOM are two important drivers in the functioning of soft-bottom coastal food webs as changes in these food resources affect the two most dominant nematode trophic groups (i.e., non-selective deposit feeders, considered as more opportunistic, and epigrowth feeders, more specifically related to benthic microalgae). This is likely related to the high biomass of these food sources, as well as the quality and high production rates of benthic microalgae (MacIntyre et al. 1996; Cebrián 1999). Therefore, this study highlights the existence of some relationships between composition of food sources and the trophic structure of the meiofauna community, when studied at the scale of trophic groups. On the contrary, no clear relationship was observed between bacterial biomass and density of selective deposit feeders (bacterivores; 1A), despite a relationship between proportion of detrital matter and relative abundances of selective deposit feeders. This lack of relationship may be related to the high production rates of bacteria and the influence of abiotic factors, especially oxic conditions. Approaches such as trophic markers (e.g. stable isotope and/or fatty acid analyses) would be very complementary to the determination of feeding types based on the morphology of the buccal cavity. Such tools would provide a more comprehensive picture of food sources really assimilated by meiofauna and highlight how the use of food sources by meiofauna may change depending on availability. Combining trophic marker data with biomass and production data in food web models would then provide a much more complete overview of the functioning of coastal food webs.

APPENDIX: CHAPTER 3

Appendix 3.1. Biomass (mean \pm standard deviation, $\mu\text{g C ind.}^{-1}$, $n = 3$ except if noted otherwise) for nematodes, copepods, and selected nematode families/genera from the mudflats, seagrass beds and sandflat in the Marennes-Oléron Bay (MO) and the Sylt-Rømø Bight (SR) in spring and autumn.

	Mudflat MO		Mudflat SR		Seagrass SR		Seagrass MO		Sandflat SR	
	Spring	Autumn	Spring	Autumn	Spring	Autumn	Spring	Autumn	Spring	Autumn
Nematodes	0.43 \pm 0.14	0.29 \pm 0.17	0.39 \pm 0.19	0.50 \pm 0.23	0.47 \pm 0.10	0.40 \pm 0.04	0.35 \pm 0.16	0.32 \pm 0.32	0.41 \pm 0.12	0.36 \pm 0.11
Copepods	1.30 \pm 0.24	0.48 \pm 0.08	0.20 \pm 0.04	0.26 \pm 0.03	0.22 \pm 0.03	0.16 \pm 0.04	0.56 \pm 0.21	0.27 \pm 0.08	0.23 \pm 0.03	0.60 \pm 0.06
<i>Chromadoridae</i> (2A)	0.11 \pm 0.05	0.07 \pm 0.01	0.22 \pm 0.02	0.21 \pm 0.05	0.19 \pm 0.00	0.20 \pm 0.04			0.26 \pm 0.07	0.39 \pm 0.03
<i>Comesa</i> (2A)	0.64 \pm 0.06	0.40 \pm 0.05								
<i>Daptonema</i> (1B)	1.00 \pm 0.09	0.69 \pm 0.16	0.43 \pm 0.11	0.64 \pm 0.32	0.66 \pm 0.05	0.47 \pm 0.08	0.34 \pm 0.15	0.28 \pm 0.04	0.60 \pm 0.06	0.53 \pm 0.15
<i>Enoplolaimus</i> (2B)									3.10 \pm 0.19	2.23 \pm 0.48
<i>Metachromadora</i> (2A)	1.27 \pm 0.23	0.72 \pm 0.11	0.46 \pm 0.11	0.56 ($n = 1$)	0.73 \pm 0.31	0.50 ($n = 1$)	0.26 \pm 0.00	0.23 \pm 0.03	0.56 \pm 0.27	0.25 \pm 0.05
<i>Microalaimus</i> (2A)									0.10 \pm 0.02	0.14 \pm 0.03
<i>Monoposthia</i> (2A)							0.19 ($n = 1$)	0.15 \pm 0.03		
<i>Sabatieria</i> (1B)		0.20 \pm 0.01	0.43 \pm 0.09	0.30 \pm 0.08			0.15 ($n = 1$)			
<i>Sphaerolaimus</i> (2B)	3.30 \pm 0.75	1.53 \pm 0.45	1.60 \pm 0.12	3.07 \pm 1.36	1.24 \pm 0.49	0.87 \pm 0.21	1.76 \pm 0.47	1.32 \pm 0.63		
<i>Spirinia</i> (2A)					0.55 \pm 0.08	0.76 \pm 0.07				
<i>Terschellingia</i> (1A)	0.12 \pm 0.03	0.11 \pm 0.04	0.11 \pm 0.00	0.11 \pm 0.02	0.03 \pm 0.00		0.09 \pm 0.04	0.12 \pm 0.04		

1A: selective deposit feeders; 1B: non-selective deposit feeders; 2A: epigrowth feeders; 2B: omnivores/predators

Appendix 3.2. Equations of Hill's diversity (N_1) and species evenness (J'), where p_i is the ratio of the count of the i^{th} species to the total number of individuals in the sample and S is the species number (Hill 1973).

$$N_1 = e^{(-\sum p_i \times \ln p_i)}$$

$$J' = - \sum \frac{p_i \times \ln p_i}{\ln S}$$

Appendix 3.3. Median sediment grain size and 90% quantile (μm , $n = 3$) of the mudflats, seagrass beds and sandflat in the Marennes-Oléron Bay (MO) and the Sylt-Rømø Bight (SR) in spring and autumn for surface (0 – 1 cm) and sub-surface (1 – 5 cm) layers. Letters displayed after median values indicate groups of samples with similar grain-size (two-way ANOVA with Tukey *post-hoc* tests, $p < 0.05$).

Depth (in cm)	Mudflat MO				Mudflat SR				Seagrass SR				Seagrass MO				Sandflat SR			
	Spring		Autumn		Spring		Autumn		Spring		Autumn		Spring		Autumn		Spring		Autumn	
	0-1	1-5	0-1	1-5	0-1	1-5	0-1	1-5	0-1	1-5	0-1	1-5	0-1	1-5	0-1	1-5	0-1	1-5	0-1	1-5
Sediment grain-size	34 ^a	36 ^a	27 ^a	29 ^a	75 ^b	103 ^b	51 ^b	46 ^b	80 ^b	88 ^b	81 ^b	67 ^b	74 ^b	65 ^b	58 ^b	63 ^b	392 ^c	394 ^c	425 ^c	416 ^c
<5% - >95%	2 - 305	2 - 271	2 - 179	2 - 219	3 - 247	3 - 453	3 - 210	2 - 327	3 - 201	3 - 208	2 - 207	2 - 193	2 - 308	2 - 237	2 - 248	2 - 206	162 - 748	149 - 766	179 - 772	201 - 767

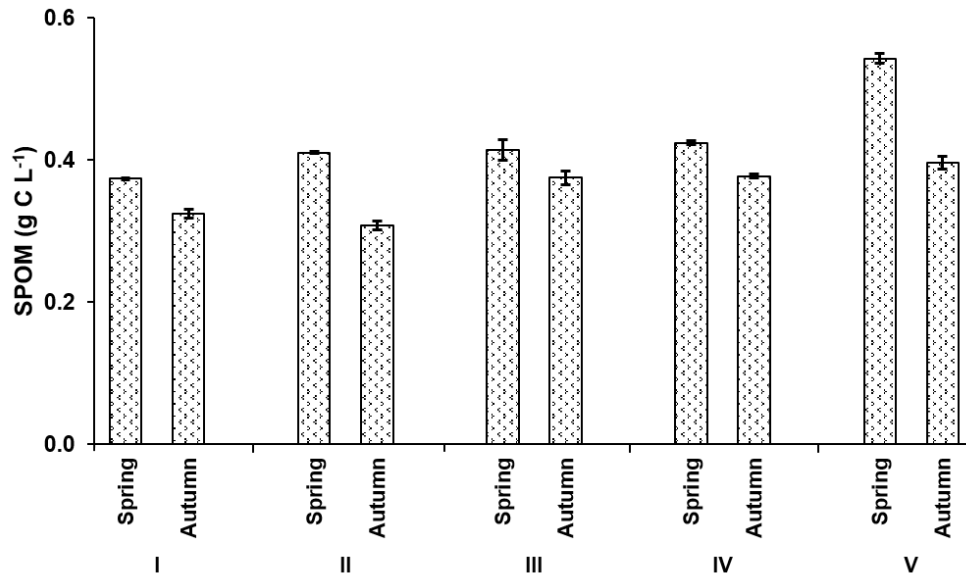

Appendix 3.4. Suspended particulate organic matter (SPOM) (mean \pm standard deviation) at the different sampling stations in the Marennes-Oléron Bay (I-II) and the Sylt-Rømø Bight (III-V) in spring and autumn. Sampling stations are presented on figure 1. ($n = 3$)

Appendix 3.5. Abundances of meiofauna, nematodes and benthic copepods (mean \pm standard deviation, ind. m⁻², $n = 3$) in the top 5 cm of the mudflats, seagrass beds and sandflat in the Marennes-Oléron Bay (MO) and the Sylt-Rømø Bight (SR) in spring and autumn. Letters displayed after median values indicate groups of samples with similar abundance (two-way ANOVA with Tukey *post-hoc* tests).

	Mudflat MO		Mudflat SR		Seagrass SR		Seagrass MO		Sandflat SR	
	Spring	Autumn	Spring	Autumn	Spring	Autumn	Spring	Autumn	Spring	Autumn
Abundance										
Nematodes	2.9*10 ⁶ A \pm 2.3*10 ⁵	3.2*10 ⁶ A \pm 1.2*10 ⁵	3.9*10 ⁵ CD \pm 6.4*10 ⁴	1.6*10 ⁵ D \pm 4.4*10 ⁴	1.1*10 ⁶ B \pm 2.8*10 ⁵	4.8*10 ⁵ CD \pm 2.0*10 ⁵	8.1*10 ⁵ BC \pm 4.5*10 ⁴	5.0*10 ⁵ CD \pm 7.8*10 ⁴	1.9*10 ⁵ D \pm 9.5*10 ⁴	2.5*10 ⁵ D \pm 3.6*10 ⁴
Benthic copepods	8.4*10 ⁴ BCD \pm 2.0*10 ⁴	1.7*10 ⁵ AB \pm 2.8*10 ⁴	4.6*10 ⁴ BCD \pm 7.0*10 ³	9.6*10 ³ D \pm 2.4*10 ³	1.2*10 ⁴ CD \pm 2.4*10 ³	5.9*10 ⁴ BCD \pm 1.6*10 ⁴	1.6*10 ⁵ ABC \pm 4.9*10 ⁴	2.5*10 ⁵ A \pm 1.3*10 ⁵	1.6*10 ⁵ AB \pm 5.8*10 ⁴	1.0*10 ⁵ BCD \pm 3.2*10 ⁴
Total meiofauna	3.0*10 ⁶ A \pm 2.4*10 ⁵	3.4*10 ⁶ A \pm 1.4*10 ⁵	4.6*10 ⁵ DE \pm 7.4*10 ⁴	1.7*10 ⁵ E \pm 4.3*10 ⁴	1.1*10 ⁶ B \pm 2.8*10 ⁵	5.5*10 ⁵ CDE \pm 2.0*10 ⁵	9.6*10 ⁵ BC \pm 2.2*10 ⁴	7.6*10 ⁵ BCD \pm 5.7*10 ⁴	3.7*10 ⁵ DE \pm 6.1*10 ⁴	3.7*10 ⁵ DE \pm 6.1*10 ⁴

Appendix 3.6. Most dominant nematode genera (mean, $n = 3$) and corresponding feeding types (FT) in the mudflats, seagrass beds and sandflat in the Marennes-Oléron Bay (MO) and the Sylt-Rømø Bight (SR) in spring and autumn for surface (0 – 1 cm) and sub-surface (1 – 5 cm) layers.

Layer	0 – 1 cm						1 – 5 cm					
	Spring			Autumn			Spring			Autumn		
Habitat	Genera	%	FT	Genera	%	FT	Genera	%	FT	Genera	%	FT
Mudflat MO	<i>Ptycholaimellus</i>	20.4	2A	<i>Ptycholaimellus</i>	28.5	2A	<i>Comesa</i>	44.5	2A	<i>Terschellingia</i>	45.5	1A
	<i>Chromadora</i>	19.9	2A	<i>Metachromadora</i>	18.0	2A	<i>Terschellingia</i>	32.6	1A	<i>Sabatieria</i>	21.4	1B
	<i>Metachromadora</i>	15.0	2A	<i>Chromadora</i>	15.2	2A	<i>Sabatieria</i>	12.5	1B	<i>Comesa</i>	13.6	2A
	<i>Daptonema</i>	14.0	1B	<i>Daptonema</i>	9.5	1B	<i>Daptonema</i>	1.6	1B	<i>Metachromadora</i>	11.0	2A
	<i>Terschellingia</i>	10.5	1A	<i>Sabatieria</i>	5.1	1B	<i>Ptycholaimellus</i>	1.0	2A	<i>Ptycholaimellus</i>	2.6	2A
	<i>Cervonema</i>	6.0	1A	<i>Axonolaimus</i>	4.8	1B	<i>Cervonema</i>	1.0	1A	<i>Daptonema</i>	1.3	1B
	<i>Ascolaimus</i>	3.1	1B	<i>Terschellingia</i>	3.2	1A	<i>Desmolaimus</i>	1.0	1B	<i>Axonolaimus</i>	1.3	1B
	<i>Sabatieria</i>	3.0	1B	<i>Desmolaimus</i>	3.1	1B	<i>Oxystomina</i>	1.0	1A	<i>Chromadora</i>	0.7	2A
	<i>Desmolaimus</i>	2.1	1B	<i>Praecanthochus</i>	2.9	2A	<i>Parodontophora</i>	1.0	1B	<i>Desmolaimus</i>	0.3	1B
	<i>Axonolaimus</i>	2.1	1B	<i>Neochromadora</i>	1.6	2A	<i>Chromadora</i>	1.0	2A	<i>Praecanthochus</i>	0.3	2A
Mudflat SR	<i>Chromadorita</i>	26.7	2A	<i>Sabatieria</i>	44.7	1B	<i>Sabatieria</i>	71.9	1B	<i>Sabatieria</i>	54.8	1B
	<i>Daptonema</i>	15.4	1B	<i>Terschellingia</i>	8.6	1A	<i>Terschellingia</i>	18.2	1A	<i>Terschellingia</i>	21.0	1A
	<i>Terschellingia</i>	10.0	1A	<i>Nemanema</i>	7.1	1A	<i>Spirinia</i>	2.0	2A	<i>Theristus</i>	6.4	1B
	<i>Sabatieria</i>	9.4	1B	<i>Chromadorita</i>	7.1	2A	<i>Theristus</i>	1.9	1B	<i>Daptonema</i>	4.1	1B
	<i>Metachromadora</i>	8.1	2A	<i>Theristus</i>	5.7	1B	<i>Metachromadora</i>	1.6	2A	<i>Spirinia</i>	2.9	2A
	<i>Spirinia</i>	4.5	2A	<i>Praecanthochus</i>	4.2	2A	<i>Halalaimus</i>	1.3	1A	<i>Eleutherolaimus</i>	2.0	1B
	<i>Sphaerolaimus</i>	4.2	2B	<i>Ptycholaimellus</i>	3.1	2A	<i>Eumorpholaimus</i>	0.7	1B	<i>Nemanema</i>	1.8	1A
	<i>Theristus</i>	3.8	1B	<i>Daptonema</i>	3.0	1B	<i>Microlaimus</i>	0.7	2A	<i>Sphaerolaimus</i>	1.3	2B
	<i>Viscosia</i>	3.1	2B	<i>Sphaerolaimus</i>	2.9	2B	<i>Praecanthochus</i>	0.6	2A	<i>Metachromadora</i>	1.2	2A
	<i>Halalaimus</i>	2.9	1A	<i>Spirinia</i>	2.2	2A	<i>Oxystomina</i>	0.3	1A	<i>Ptycholaimellus</i>	1.0	2A
Seagrass SR	<i>Chromadorita</i>	30.7	2A	<i>Spirinia</i>	37.2	2A	<i>Spirinia</i>	67.4	2A	<i>Spirinia</i>	64.0	2A
	<i>Spirinia</i>	23.8	2A	<i>Chromadorita</i>	29.5	2A	<i>Terschellingia</i>	14.3	1A	<i>Sabatieria</i>	12.0	1B
	<i>Daptonema</i>	14.8	1B	<i>Daptonema</i>	8.7	1B	<i>Sabatieria</i>	5.5	1B	<i>Eleutherolaimus</i>	12.0	1B
	<i>Sabatieria</i>	10.9	1B	<i>Dichromadora</i>	5.5	2A	<i>Daptonema</i>	2.7	1B	<i>Terschellingia</i>	7.0	1A
	<i>Metachromadora</i>	4.9	2A	<i>Sabatieria</i>	2.6	1B	<i>Metachromadora</i>	2.0	2A	<i>Theristus</i>	1.0	1B
	<i>Terschellingia</i>	4.4	1A	<i>Eleutherolaimus</i>	2.0	1B	<i>Oxystomina</i>	1.8	1A	<i>Sphaerolaimus</i>	1.0	2B
	<i>Ptycholaimellus</i>	1.9	2A	<i>Theristus</i>	1.9	1B	<i>Chromadorita</i>	1.8	2A	<i>Metalinhomoeus</i>	1.0	1B

	<i>Chromadora</i>	1.3	2A	<i>Viscosia</i>	1.6	2B	<i>Chromadora</i>	1.0	2A	<i>Nemanema</i>	1.0	1A
	<i>Theristus</i>	1.3	1B	<i>Sphaerolaimus</i>	1.6	2B	<i>Axonolaimus</i>	0.7	1B	<i>Odontophora</i>	1.0	1B
	<i>Odontophora</i>	1.3	1B	<i>Metalinhomoeus</i>	1.3	1B	<i>Ptycholaimellus</i>	0.7	2A	<i>Chromadorita</i>	0.0	2A
Seagrass	<i>Monoposthia</i>	15.3	2A	<i>Ptycholaimellus</i>	19.0	2A	<i>Terschellingia</i>	17.9	1A	<i>Terschellingia</i>	55.8	1A
MO	<i>Daptonema</i>	13.9	1B	<i>Spirinia</i>	16.7	2A	<i>Sabatieria</i>	13.0	1B	<i>Sabatieria</i>	10.8	1B
	<i>Metachromadora</i>	12.7	2A	<i>Metachromadora</i>	9.1	2A	<i>Daptonema</i>	9.8	1B	<i>Spirinia</i>	5.7	2A
	<i>Sphaerolaimus</i>	7.4	2B	<i>Daptonema</i>	8.4	1B	<i>Halalaimus</i>	9.7	1A	<i>Oxystomina</i>	5.1	1A
	<i>Bathylaimus</i>	6.7	1B	<i>Sabatieria</i>	8.4	1B	<i>Metalinhomoeus</i>	6.6	1B	<i>Metachromadora</i>	3.7	2A
	<i>Sabatieria</i>	6.7	1B	<i>Odontophora</i>	6.4	1B	<i>Spirinia</i>	5.2	2A	<i>Paralinhomoeus</i>	3.0	1B
	<i>Anoplostoma</i>	5.0	1B	<i>Monoposthia</i>	5.4	2A	<i>Bathylaimus</i>	4.9	1B	<i>Theristus</i>	2.1	1B
	<i>Spirinia</i>	4.3	2A	<i>Sphaerolaimus</i>	3.0	2B	<i>Monoposthia</i>	4.2	2A	<i>Ptycholaimellus</i>	2.0	2A
	<i>Praecanthochus</i>	3.2	2A	<i>Eleutherolaimus</i>	2.7	1B	<i>Eumorpholaimus</i>	4.1	1B	<i>Odontophora</i>	2.0	1B
	<i>Ptycholaimellus</i>	2.8	2A	<i>Desmolaimus</i>	2.4	1B	<i>Desmolaimus</i>	3.4	1B	<i>Metalinhomoeus</i>	1.6	1B
Sandflat	<i>Daptonema</i>	35.4	1B	<i>Daptonema</i>	37.1	1B	<i>Microlaimus</i>	46.1	2A	<i>Microlaimus</i>	53.5	2A
SR	<i>Chromadorita</i>	17.9	2A	<i>Chromadorita</i>	18.2	2A	<i>Spirinia</i>	17.2	2A	<i>Spirinia</i>	10.1	2A
	<i>Enoplolaimus</i>	8.5	2B	<i>Metachromadora</i>	8.2	2A	<i>Praecanthochus</i>	8.7	2A	<i>Metachromadora</i>	5.2	2A
	<i>Viscosia</i>	6.7	2B	<i>Microlaimus</i>	8.1	2A	<i>Viscosia</i>	8.3	2B	<i>Ptycholaimellus</i>	5.2	2A
	<i>Metachromadora</i>	4.9	2A	<i>Enoplolaimus</i>	4.4	2B	<i>Sabatieria</i>	3.1	1B	<i>Chromadorita</i>	3.5	2A
	<i>Chromadora</i>	3.3	2A	<i>Theristus</i>	4.0	1B	<i>Odontophora</i>	2.9	1B	<i>Daptonema</i>	3.1	1B
	<i>Anoplostoma</i>	3.3	1B	<i>Ptycholaimellus</i>	3.1	2A	<i>Daptonema</i>	2.0	1B	<i>Viscosia</i>	2.9	2B
	<i>Enoploides</i>	3.2	2B	<i>Metadesmolaimus</i>	2.4	1B	<i>Terschellingia</i>	1.7	1A	<i>Theristus</i>	2.8	1B
	<i>Praecanthochus</i>	2.9	2A	<i>Spirinia</i>	2.0	2A	<i>Enoplolaimus</i>	1.6	2B	<i>Enoploides</i>	2.1	2B
	<i>Odontophora</i>	2.1	1B	<i>Enoploides</i>	2.0	2B	<i>Theristus</i>	1.4	1B	<i>Anoplostoma</i>	1.8	1B

1A: selective deposit feeders; 1B: non-selective deposit feeders; 2A: epigrowth feeders; 2B: omnivores/predators

Interchapter 3A

From biomass to trophic relationships

The important drivers of meiofauna community structure are related to both biotic and abiotic parameters (Fig. 3A.1). The influence of abiotic parameters on meiofauna has been largely studied and effects of sediment grain size (Steyaert et al. 2003; Dupuy et al. 2015), habitat structure (Fonseca et al. 2011), oxygen gradients (Josefson and Wibdom 1988; Austen and Wibdom 1991) and intertidal water level (Steyaert et al. 2001) have been demonstrated to influence meiofauna community structure. Both biotic and abiotic factors are affected by anthropogenic impacts which thus indirectly influence meiofauna community structure as well (Semprucci et al. 2010). However, effects of biotic factors, e.g. availability, quality and quantity of food sources, on the meiofauna community structure in intertidal habitats are poorly known and few studies have compared several habitats.

Chapter three provided more insights about the important biotic drivers of meiofauna community structure. An assessment of the food sources as well as meiofauna communities demonstrated that microphytobenthos and SOM are two important drivers in the functioning of soft-bottom coastal food webs (Fig. 3A.1). The two most dominant nematode trophic groups (i.e., non-selective deposit feeders and epigrowth feeders) were the most affected by these changes in food sources. The influence of oxic conditions on the vertical distribution, meiofauna community structure and diversity has to be considered as well. However, questions arise from these outcomes: (I) what are the trophic relationships between food sources and meiobenthic consumers? And (II) what are the effects on meiofauna feeding behavior when food resources are changing in terms of availability and production?

Therefore, complementary information is needed to determine the trophic relationships between food sources and meiofauna. The lack of relationship between bacterial biomass and selective deposit feeding (bacterivorous) nematodes highlighted the importance in combining buccal cavity observations with trophic marker analyses. Two frequently used trophic markers, stable isotopes and fatty acids, were combined to investigate the trophic relationships between food sources and meiofauna. Determining trophic relationships of the feeding types of nematodes would be very complementary to the determination of feeding types based on the morphology of the buccal cavity. Such tools would indeed provide a more comprehensive picture of food sources assimilated by meiofauna and highlight how the use of these food sources by meiofauna may change depending on their availability.

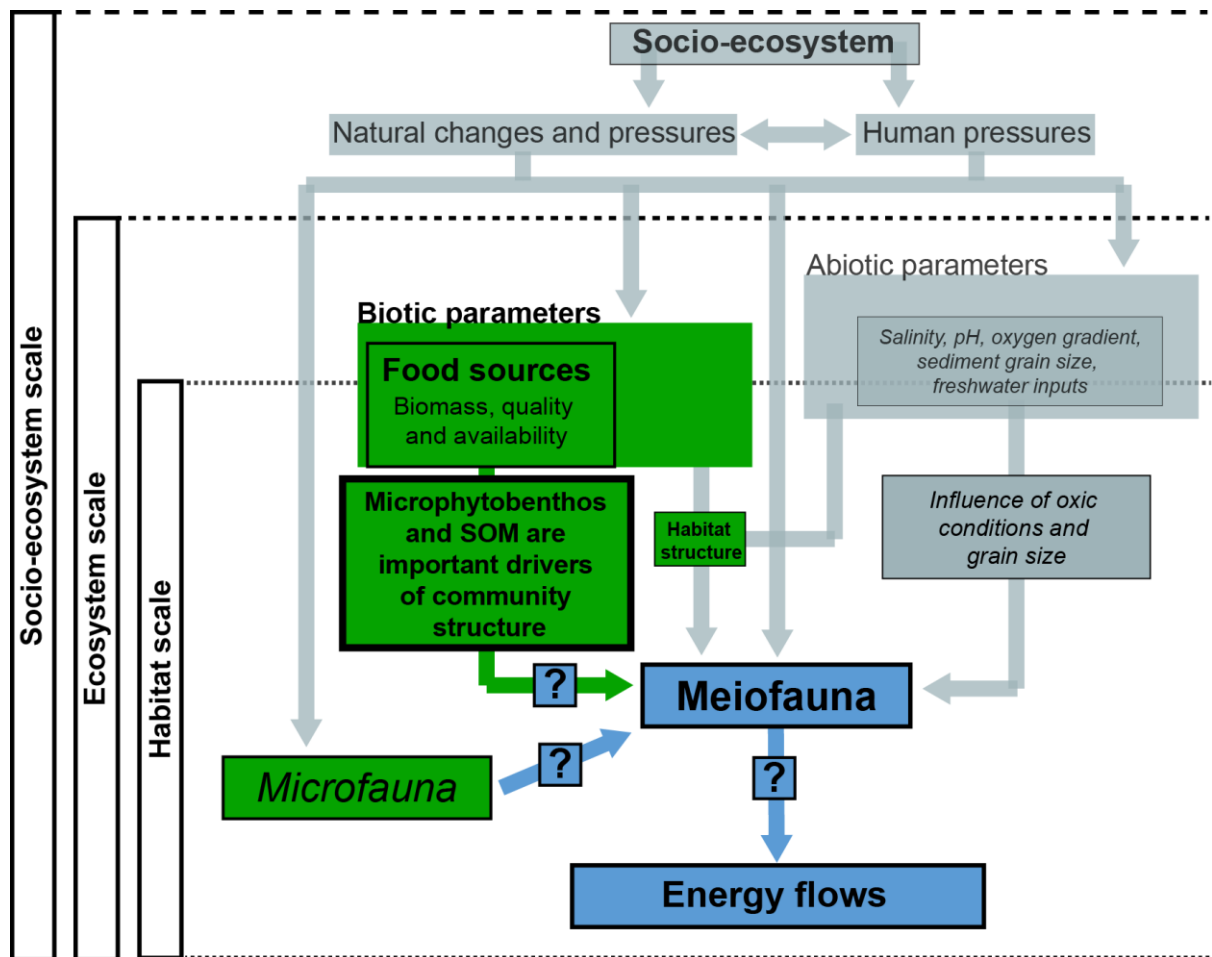

Figure 3A.1. Conceptual diagram illustrating the important drivers of meiofauna community structure (biomass, diversity, and trophic structure) and the questions that arose from habitat comparisons.

Meiofauna diet assessment

“Tell me what you eat, and I will tell you what you are”

Brillat-Savarin

**Trophic importance of microphytobenthos and
bacteria to meiofauna within soft-bottom intertidal
habitats:**

A combined trophic marker approach.

Trophic importance of microphytobenthos and bacteria to meiofauna in soft-bottom intertidal habitats: a combined trophic marker approach.

L.H. van der Heijden^{1,2}, M. Graeve³, R.M. Asmus², J. Rzeznik-Orignac⁴, N. Niquil⁵, Q. Bernier¹, G. Guillou¹, H. Asmus², B. Lebreton¹

¹*LIENSs, UMR 7266 University of La Rochelle, CNRS, 2 rue Olympe de Gouges, 17000 La Rochelle, France*

²*Alfred Wegener Institute Helmholtz Centre for Polar- and Marine Research, Wattenmeerstation Sylt, 25992 List, Sylt, Germany*

³*Alfred Wegener Institut Helmholtz Centre for Polar- and Marine Research, Bremerhaven, Germany*

⁴*Laboratoire d'Ecogéochimie des Environnements Benthiques, LECOB, Sorbonne Université, CNRS, Banyuls-sur-Mer, France*

⁵*Unité Biologie des Organismes et Ecosystèmes Aquatiques (BOREA), MNHN, CNRS, IRD, Sorbonne Université, Université de Caen Normandie, Université des Antilles, CS 14032, 14000 CAEN, France*

ABSTRACT

Meiofauna can play an important role in the carbon fluxes of soft-bottom coastal habitats. Investigation of their feeding behavior and trophic position remains challenging due to their small size. In this study, we determine and compare the food sources used by nematodes and benthic copepods by using stable isotope compositions, fatty acid profiles and compound specific isotope analyses of fatty acids in the mudflats, seagrass beds and sandflat of the Marennes-Oléron Bay, France, and the Sylt-Rømø Bight, Germany. Suspended particulate organic matter was much more ¹³C-depleted than other food sources and meiofauna, highlighting its poor role in the different studied habitats. The very low proportions of vascular plant fatty acid markers in meiofauna demonstrated that these consumers poorly relied on this food source, either as fresh or as detritus, even in seagrass beds. The combined use of stable isotopes and fatty acids emphasized microphytobenthos and benthic bacteria as the major food sources of nematodes and benthic copepods. Compound specific analyses of a bacteria marker confirmed that bacteria mostly used microphytobenthos as a substrate.

Keywords: free-living marine nematodes; benthic copepods; benthic diatoms; bacteria; trophic markers; seagrass beds; mudflats; sandflats.

1. INTRODUCTION

Soft-bottom coastal habitats are important ecosystems on Earth due to their high primary production (Underwood and Kromkamp 1999; Hemminga and Duarte 2000; McLusky and Elliott 2004) and their complex food webs based on a large diversity of potential food sources (Duarte and Cebrián 1996). Coastal ecosystems are under constant pressure due to anthropogenic activities, global changes and natural evolution (Davis and Fitzgerald 2004). Such pressures can affect primary production at spatial and/or temporal scales, e.g. degradation of seagrass beds, eutrophication, changes of sediment grain size, floods and droughts (Short and Wyllie-Echeverria 1996; Dolbeth et al. 2007; Baeta et al. 2011; Valle et al. 2014), which may alter the functioning of food webs, depending on the fate of these primary sources.

Among consumers relying on these primary food sources, meiofauna plays an important role in the carbon fluxes of soft-bottom coastal habitats due to their high biomass (Danovaro et al., 2002; Escaravage et al., 1989, van der Heijden et al. in press), high secondary production (from 4 to 29 gC m⁻² year⁻¹) (Escaravage et al. 1989; Chardy and Dauvin 1992; Danovaro et al. 2002b) and high turnover rate (Kuipers et al. 1981) as well as their intermediate position in food webs (Giere 2009) fueling the higher trophic levels (Coull 1999; Leguerrier et al. 2003). The large species diversity of meiofauna (Heip et al. 1985) results in different feeding behavior (Giere 2009), likely leading to different responses when dealing with changes in food sources. The feeding behavior of meiofauna has been studied in different coastal ecosystems using various methods. In bare coastal habitats meiofauna are known to feed mainly on microphytobenthos (Rzeznik-Orignac et al. 2008; Maria et al. 2011; Moens et al. 2014), whereas it has been reported that meiofauna use a larger range of food sources in vegetated sediments, e.g. microphytobenthos, phytoplankton and seagrass tissue (Leduc et al. 2009; Lebreton et al. 2012; Vafeiadou et al. 2014). Nevertheless, the role of some of these food sources is still under debate, e.g. seagrass material (Leduc et al., 2009), suspended particulate organic matter (SPOM; Vafeiadou et al., 2014), or poorly studied, like bacteria (Vafeiadou et al., 2014). The combination of several trophic markers appears to be very promising to better define the food sources of meiofauna as these methods are complementary and may therefore allow to address some limitations highlighted in previous studies.

The feeding behavior of nematodes, typically the predominant taxa in meiofauna, is often determined using the morphology of the buccal cavity (Wieser 1953). However, classifications based on buccal cavities have limitations, e.g. specifying a preference for bacteria or microphytobenthos (Moens and Vincx 1997b). Hence, the use of stable isotopes to describe the food resources of nematodes and other meiofauna taxa has been applied in a variety of coastal benthic ecosystems (Middelburg et al. 2000; Iken et al. 2001; Moens et al. 2005b; Vafeiadou et al. 2014). Isotope compositions of carbon and nitrogen can provide information about the food sources and the trophic level of meiofauna (Fry 1988;

Rzeznik-Orignac et al. 2008; Vafeiadou et al. 2014), as well as the fluxes of energy (Moens et al. 2002). However, in coastal ecosystems, the high variability and the close isotope compositions of some potential food sources (Mutchler et al. 2004; Fry 2006) may limit isotope data interpretation (Leduc et al. 2009; Lebreton et al. 2012; Vafeiadou et al. 2014). Moreover, bacteria, which also are a potential food source (Guilini et al. 2012; Vafeiadou et al. 2014), usually have isotope compositions close to their substrate (Boschker et al. 2000) and are difficult to isolate for stable isotope analysis (Coffin et al. 1990; Pelz et al. 1997). Fatty acid profiles are therefore very complementary to isotope compositions to discriminate the various food sources in complex systems (Sargent and Whittle 1981) and to determine trophic interactions in coastal food webs (Kelly and Scheibling 2012). Primary producers (e.g. diatoms, flagellates, vascular plants) and bacteria indeed synthesize specific fatty acids (FAs) which can be used as trophic markers since consumers incorporate some of these FAs unchanged (Graeve et al. 1997; Parrish et al. 2000; Dalsgaard et al. 2003). Complementary to bulk FA analyses, compound specific isotope analysis of FAs are utilized to determine the origin of the different primary producers (e.g. bacteria, diatoms) in composite food sources such as sediment organic matter (SOM) and suspended particulate organic matter (SPOM) and consumers (van Gaever et al. 2009; Middelburg 2014; Braeckman et al. 2015). Discriminating food sources with the use of multiple trophic markers is a novel approach to determine the food sources of meiofauna in soft-bottom coastal systems and has been shown to be effective in advancing the understanding of complex food webs (Nyssen et al. 2005; Jaschinski et al. 2008; Leduc et al. 2009; Lebreton et al. 2011b).

Using this combination of trophic markers, the aim of this study was to determine the food sources of meiofauna in several habitats (i.e., mudflats, seagrass beds and sandflat in the Marennes-Oléron Bay, France, and the Sylt-Rømø Bight, Germany) characterized by different primary producers. The comparison of these different habitats at different seasons (spring and autumn) provides us several food web scenarios to determine how meiofauna use the different potential food sources depending on their availability. Main trophic fluxes were assessed with the use of multiple trophic markers, i.e., stable isotope compositions, fatty acid profiles and compound specific isotope ratios for FAs, on major primary producers, composite food sources and the two dominant groups of meiofauna: nematodes and benthic copepods.

2. MATERIAL AND METHODS

2.1. Study area

The study was carried out in intertidal habitats of the Marennes-Oléron Bay, in the middle of the western Atlantic coast of France, and the Sylt-Rømø Bight, in the Southeastern North Sea in Germany (Fig. 4.1). The Marennes-Oléron Bay is dominated by intertidal bare mudflats (Gouleau et al. 2000) and influenced by oceanic and continental inputs of organic matter. The semi-enclosed basin of the Sylt-Rømø Bight is dominated by *Arenicola* sandflats (Asmus and Asmus 1985, 2005) and has negligible continental inputs. Sampling was carried out in three intertidal habitats within the two bays (see van der Heijden et al. in press, for additional information): a bare mudflat (mudflat MO) and a seagrass bed (seagrass MO) in the Marennes-Oléron Bay, and a bare mudflat (mudflat SR), a seagrass bed (seagrass SR) and a sandflat (sandflat SR) in the Sylt-Rømø Bight (Fig. 4.1). In both areas seagrass beds were formed by the dwarf seagrass *Zostera noltei* Hornemann. Based on knowledge already obtained about these habitats (Leguerrier et al. 2003; Baird et al. 2007; Pacella et al. 2013; Saint-Béat et al. 2013a) one sampling station was designated for each of these five locations in order to be representative of the studied habitat.

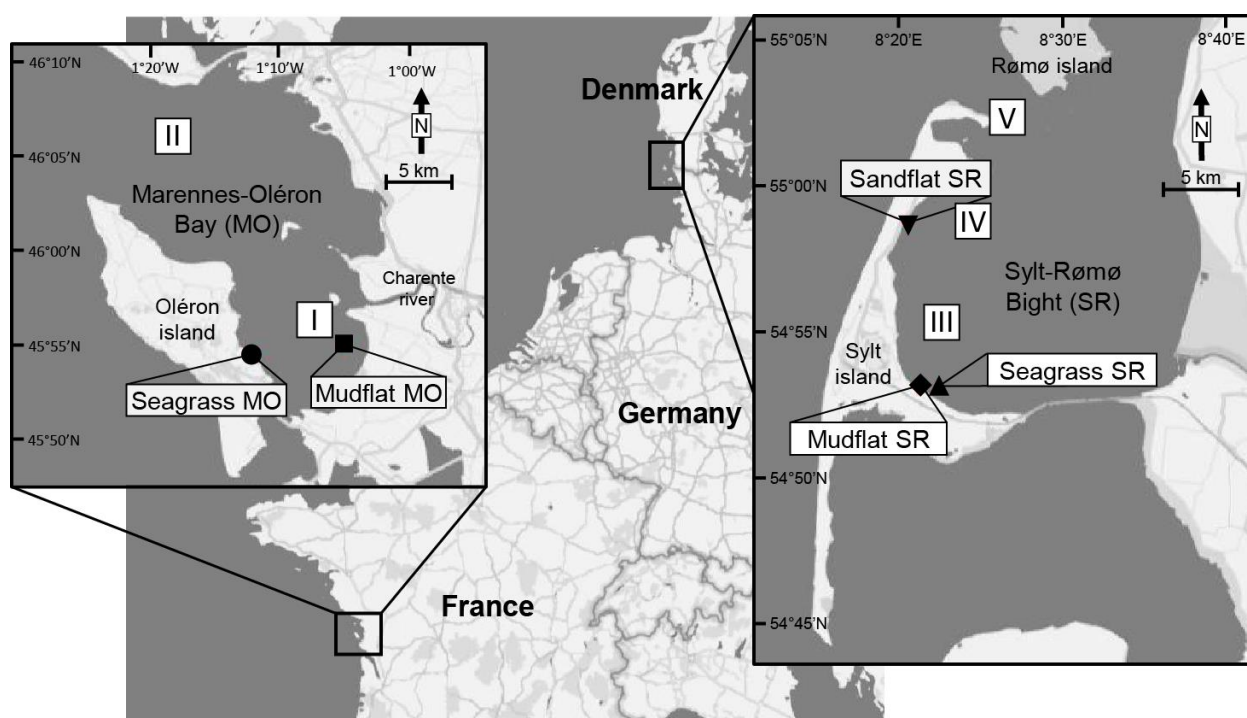

Figure 4.1. Sampling stations in mudflats, seagrass beds and sandflats in the Marennes-Oléron Bay (MO) and the Sylt-Rømø Bight (SR) along the European Atlantic coast. Pelagic sampling stations, where samples for suspended particulate organic matter were taken, are indicated with roman numbers in Marennes-Oléron Bay (I-II) and Sylt-Rømø Bight (III-V).

2.2. Sampling and laboratory processing of benthic primary producers, composite food sources and meiofauna

Sampling was carried out in two seasons, in spring (from May 17 to June 17, 2016) and in autumn (from November 14 to December 15, 2016), to compare a season with a high primary production with a season with a high load of detrital material (Galois et al. 1996).

2.2.1. Benthic primary producers and composite food sources

Benthic sampling campaigns were carried out during low tide, starting about one hour before the time of the lowest water level. Sediment organic matter (SOM), detritus, and seagrass leaves and roots were collected using sediment cores ($\varnothing = 19$ cm; three replicates) which were separated in two layers (a surface layer from 0-1 cm, a sub-surface layer from 1-5 cm). Each sediment layer was gently sieved with a 500 μm mesh (1 mm mesh for sandflat SR samples) after which the upper fraction (> 500 μm) was separated into seagrass leaves, roots and detritus (brown to black colored leaves and roots). SOM analyses were carried out on the lower fraction (< 500 μm). Microphytobenthos was collected by scraping surficial sediment in the field and was then extracted in the laboratory following the method of Riera and Richard (1996), slightly modified by Herlory et al. (2007). Microphytobenthos was mainly made up of benthic diatoms (e.g. *Pleurosigma* spp., *Navicula* spp., *Diploneis* spp) (Asmus, 1983; Haubois et al., 2005). Extracted samples were checked for cleanliness (i.e., absence of detrital material) with a microscope and concentrated by centrifugation. All samples were freeze-dried and a sub-sample was ground to a fine and homogeneous powder using a ball mill (MM 400, Retsch, Germany), except for SOM for which the sediment was ground using a mortar and pestle. Samples were stored at -20 $^{\circ}\text{C}$ for stable isotope analysis and at -80 $^{\circ}\text{C}$ under nitrogen atmosphere for fatty acid analysis.

Between 10 and 100 mL (for stable isotope analyses) and 50 L (for fatty acid analyses) of surface seawater was sampled during high tide to collect suspended particulate organic matter (SPOM), in the same timeframe as the benthic samples. Water samples were collected at two stations (I and II) in the Marennes-Oléron Bay and three stations (III, IV and V) in the Sylt-Rømø Bight for stable isotopes (Fig. 4.1). For fatty acid analyses, water samples were collected at stations I, II, and V. Station I, in the north of the Brouage mudflat, represented the water mass covering the mudflat MO station. Station II, near the inlet of the Marennes-Oléron bay, represented the water mass influencing the seagrass MO station. Station II is sampled every two weeks in the framework of the SOMLIT surveys (data provided by “Service d’Observation en Milieu Littoral, INSU-CNRS, La Rochelle station”). Water samples collected at stations III and IV represented water masses covering the sandflat SR (III), and the mudflat SR and seagrass SR stations (IV), respectively. Station V, near the entrance of the Sylt-Rømø Bight, represented the SPOM originating from the North Sea. Water was pre-filtered with a 250- μm sieve to eliminate large particles/organisms and then filtered on precombusted (4 hours, 450°C) Whatman GF/F glass fiber filters (0.7 μm nominal porosity) under moderate vacuum. Filters were freeze-dried and then

stored at -20 °C for stable isotope analysis and at -80 °C under nitrogen atmosphere for fatty acid analysis.

2.2.2. *Meiofauna*

Meiofauna was sampled using sediment cores ($\phi = 19$ cm; three replicates) which were separated in two layers (a surface layer from 0-1 cm, and a deep layer from 4-5 cm) to study the changes of meiofauna diet related to sediment depth. Samples were sieved with a 500- μ m mesh to eliminate macrofauna and large detritus. Meiofauna must be collected alive to allow evacuation of gut contents. Therefore, meiofauna was extracted from the sediment using a Ludox HS-40-based protocol (Sigma Aldrich, France) (de Jonge and Bouwman 1977), slightly modified by Lebreton et al. (2012) which allows the recovery of living organisms. The collected meiofauna was kept at 4 °C for 72 hours to empty their gut content (Riera et al. 1996) and then stored at -80 °C.

2.3. Analytical procedures

2.3.1. *Bulk stable isotope analyses*

Carbonates were removed from SOM and SPOM samples for $\delta^{13}\text{C}$ measurements. For SOM, carbonates were removed by adding HCl at 2 mol.l⁻¹ drop-by-drop on sediment samples until cessation of bubbling, then samples were dried at 60 °C. Dried samples were re-homogenized into ultrapure water using an ultrasonic bath, freeze-dried and ground again. Filters with SPOM were acidified for 4 hours using HCl fumes. $\delta^{15}\text{N}$ analyses were carried out on non-acidified samples.

A bulk of nematodes and benthic copepods were randomly picked with fine forceps (#55, Dumont). From 25 to 50 individuals (depending on the size ranges) were picked, cleaned in ultrapure water and transferred into a tin capsule, which had been previously weighed (± 1 μ g, ME 5, Sartorius, Germany) and filled with ultrapure water. Tin capsules were then freeze-dried.

All samples were precisely weighed (± 1 μ g) and were analyzed for isotope compositions using an elemental analyzer (Flash 2000, Thermo Scientific, Milan, Italy) coupled to an isotope ratio mass spectrometer (Delta V Plus with a Conflo IV interface, Thermo Scientific, Bremen, Germany). Analyses were conducted at the Littoral, Environment and Societies Joint Research Unit stable isotope facility (University of La Rochelle, France). Results are expressed in the δ notation as deviations from standards (Vienna Pee Dee Belemnite for $\delta^{13}\text{C}$ and N_2 in air for $\delta^{15}\text{N}$) following the formula: $\delta^{13}\text{C}$ or $\delta^{15}\text{N} = [(\text{R}_{\text{sample}}/\text{R}_{\text{standard}}) - 1] * 10^3$, where R is $^{13}\text{C}/^{12}\text{C}$ or $^{15}\text{N}/^{14}\text{N}$. Calibration was done using reference materials (USGS-24, -61, -62, IAEA-CH6, -600 for carbon; USGS-61, -62, IAEA-N2, -NO-3, -600 for nitrogen). The analytical precision of the measurements was $< 0.15\%$ for carbon and nitrogen based on analyses of USGS-61 and USGS-62 used as laboratory internal standards.

2.3.2. Fatty acid analyses

Lipids of primary producers and composite food sources were extracted from freeze-dried powdered samples using an accelerated solvent extractor (ASE 200, Dionex, Sunnyvale, USA) following the procedure from Folch et al. (1957), slightly modified. Samples were extracted three times with chloroform:methanol mixtures (1:2, 2:1 and 4:1, v/v) after which NaCl (1%) solution was added to the extracted sample to separate it into two phases. The lower phase (containing lipids) was then collected and stored in the dark at -20 °C. A bulk of nematodes from surface- and deep layers (80 – 400 individuals) as well as benthic copepods (100 – 600 individuals) were randomly picked, cleaned in ultrapure water, placed in GC vials filled with ultrapure water and then freeze dried. Samples were extracted manually following a similar protocol as for potential food sources and stored in the dark at -20 °C.

All samples were transmethylated by acid catalysis at 80 °C for 4h using a H₂SO₄-methanol (3%, w/v) reagent. Two internal standards (23:0 and 25:0) were added before transmethylation for the quantification of fatty acid methyl esters (FAMES). FAME solution was extracted with *n*-hexane and washed three times by addition of ultrapure water and *n*-hexane. FAMES of SOM and detrital material samples were purified using a high performance liquid chromatograph (HPLC) equipped with a Merck Hitachi L-6200A pump, a Rheodyne 7725-i injection valve (Techlab, Braunschweig, Germany) and a Sedex 75 ELSD detector (Sedere, Olivet, France). Samples were purified using a Merck Chromolith® Performance Si 100-4.6 column (Merck AG, Darmstadt, Germany) with a solvent mixture of Ethylacetate:Cyclohexane (475:25; v/v) at a flow rate of 1.4 ml min⁻¹. The FAMES were eluted after 1.0 to 2.5 minutes.

FAME compositions were determined at the Alfred Wegener Institute in Bremerhaven using a gas chromatograph (GC-6890N, Agilent Technologies) equipped with an automatic sampler and fitted with a J&W DB-FFAP column (60 m, 0.25 mm internal diameter, 0.25 µm film). Inlet and FID detector temperatures were set at 250 and 260°C, respectively. Helium was used as a carrier gas in constant flow mode at an average linear velocity of 25 cm sec⁻¹. Oven temperature was set up at 80 °C for 2 min, then increased following two ramps (till 160 °C at 20 °C min⁻¹, and then till 240 °C at 2 °C min⁻¹) with a final hold time of 20 min at 240 °C. FAME identification was performed by comparing relative retention times with those of known mixtures, essentially from Arctic and Antarctic copepods.

2.3.3. Compound-specific stable isotope analyses of fatty acids

Isotope compositions of 15:0 and 20:5(*n*-3) were determined using a Thermo GC-c-IRMS system (Thermo Scientific Corporation, Bremen, Germany), equipped with a Trace GC Ultra gas chromatograph, a GC Isolink and a Delta V Plus isotope ratio mass spectrometer connected via a Conflo IV interface. FAMES, dissolved in hexane, were injected in splitless mode and separated on a J&W DB-FFAP column (60 m, 0.25 mm internal diameter, 0.25 µm film thickness). Inlet temperature was set at

280 °C. Helium was used as a carrier gas in constant flow mode (1.6 ml min⁻¹). Oven configuration was the same as for the fatty acid analyses. Quality controls and analytical precision of the FAME carbon stable isotope compositions were established by analyzing two certificated standards (supplied by Indiana University, Arndt Schimmelmann) every 5 samples: FAME 16:0 (certified $\delta^{13}\text{C}$: -30.67‰, measured $\delta^{13}\text{C}$: -30.42‰ \pm 0.25) and 18:0 (certified $\delta^{13}\text{C}$: -23.24‰, measured $\delta^{13}\text{C}$: -23.71‰ \pm 0.27).

2.4. Data treatment and statistical methods

2.4.1. Isotope data treatment

Bayesian stable isotope mixing model MixSIAR was applied to calculate the contributions of the different food sources to the diet of benthic copepods and nematodes. The *MixSIAR* package (Stock et al. 2018) was used with $\delta^{13}\text{C}$ and $\delta^{15}\text{N}$ values (mean and standard deviation) of SPOM, SOM, microphytobenthos, seagrass leaves, seagrass roots, and detritus as input data. To reduce the number of food sources, which enhance the performance of the isotope mixing model (Parnell et al. 2010; Middelburg 2014), detrital material, seagrass leaves and roots were pooled as one single “seagrass material” group. Isotope composition of bacteria, which was not measured in this study, was considered as well based on $\delta^{13}\text{C}$ and $\delta^{15}\text{N}$ values from Vafeiadou et al. (2014). Trophic fractionation factor utilized were 1.0‰ \pm 1.2 for $\delta^{13}\text{C}$ and 2.5‰ \pm 2.5 for $\delta^{15}\text{N}$ (vander Zanden and Rasmussen 2001). Mixing models were run with 100,000 iterations (of which first 50,000 iterations were discarded), without food sources contribution data defined a priori. Median values and credibility intervals (CI) of 50% and 90% were computed. The model was conducted for the mudflats, seagrass beds and sandflat of the Marennes-Oléron Bay and the Sylt-Rømø Bight.

2.4.2. FA data analyses

FA data are expressed as percentage of each FA relative to the sum of all identified FAs. Identification of FA trophic markers was done using published literature (Table 4.1), and FAs were combined in several groups: bacteria, diatoms, flagellates, vascular plants, animals, ubiquitous, and others. Ratios between diatom/vascular plant FA markers- and diatom/bacteria FA markers were calculated for potential food sources and consumers and were used to well discriminate between food sources as well as potential food sources for meiofauna. Discrimination between primary producers, composite food sources and meiofauna was enhanced by plotting the carbon isotope compositions against relative percentages of FAs from bacteria, diatoms, flagellates, and vascular plants (Nyssen et al. 2005; Lebreton et al. 2011b).

Table 4.1. Fatty acids and ratios used as trophic markers in the mudflats, seagrass beds and sandflat in the Marennes-Oléron Bay (MO) and Sylt-Rømø Bight (SR) food webs. Abbreviations: i = iso, ai = anteiso.

Group	FA biomarkers	Reference
Diatoms	14:0, 16:1(<i>n</i> -7), 20:5(<i>n</i> -3) 16:2(<i>n</i> -4), 16:3(<i>n</i> -4), 16:4(<i>n</i> -1)	Dunstan et al., 1994; Ramos et al., 2003; Volkman et al., 1989 Graeve et al., 1994
Bacterial	i-15:0, ai-15:0, i-17:0, ai-17:0 15:0, 17:1, 17:1(<i>n</i> -9), 19:1(<i>n</i> -9) 17:0, 18:1(<i>n</i> -7), 19:0	Rajendran et al., 1993; Sargent, 1987; Volkman et al., 1980 Rajendran et al., 1993; Volkman et al., 1980 Sargent, 1987
Flagellates	18:4(<i>n</i> -3), 22:6(<i>n</i> -3) 22:5(<i>n</i> -3)	Ramos et al., 2003 Galois et al., 1996
Vascular plants	18:2(<i>n</i> -6), 18:3(<i>n</i> -3) 24:0	Kharlamenko et al., 2001; Viso et al., 1993 Viso et al., 1993
Ubiquitous	16:0, 18:0, 18:1(<i>n</i> -9) 20:4(<i>n</i> -6)	Sargent, 1987; Sargent and Whittle, 1981 Dunstan et al., 1988

2.4.3. Statistical methods

Data analysis and statistical tests were performed using the R software (R Core Team, 2016) and all hypotheses were tested at a $p < 0.05$ level. Non-parametric tests were applied due to the small sample size and non-independence of data within series. Kruskal-Wallis tests were applied to test for temporal and spatial variation of isotope compositions in food sources and consumers. These tests were then followed by Dunn's multiple comparisons of means ('Bonferroni' method) using the *PMCMRplus* package (Pohlert 2018). Pearson's Chi-square tests were performed to compare FA profiles of food sources and meiofauna among seasons, sites and sediment layers. Ellipses representing 95% confidence regions for isotope compositions of meiofauna were estimated based on bootstrap resampling ($n = 1,000$) utilizing the *CIplot_biv* function (Greenacre 2016) and ellipses were illustrated using the *ellipse* package (Murdoch and Chow 1996). Average hierarchical clusters (Ward.D2 method, Chi-squared distance) were performed to compare FA compositions of sources and meiofauna between habitats using a modified version of the *pvclust* package (Suzuki and Shimodaira 2015). To define the significance of identified clusters the p-values were calculated based on multiscale bootstrap resampling ($n = 10,000$).

3. RESULTS

3.1. Primary producers

3.1.1. Isotope compositions

Mean $\delta^{13}\text{C}$ values of microphytobenthos ranged from -17.3‰ (mudflat SR, spring) to -7.2‰ (sandflat SR, spring) (Fig. 4.2, Appendix 4.1). Mean $\delta^{13}\text{C}$ values of seagrass leaves ranged from -13.1‰ (seagrass SR, spring) to -10.4‰ (seagrass MO, autumn) and those of roots were between -13.3‰ (seagrass SR, spring) and -10.6‰ (seagrass MO, autumn). Seagrass leaves and roots had similar $\delta^{13}\text{C}$ values (Kruskal-Wallis tests, lowest p-value: 0.15), and are therefore grouped in the following sections as a single sample referred to as “seagrass material”. Mean $\delta^{13}\text{C}$ values of seagrass detrital material were similar within different sediment layers (Kruskal-Wallis tests, lowest p-value: 0.13, Appendix 4.2); they ranged from -19.0‰ (mudflat SR, spring) to -11.1‰ (seagrass MO, autumn). At each habitat, $\delta^{13}\text{C}$ values of microphytobenthos, seagrass material and detrital material were similar (Kruskal-Wallis tests, lowest p-value: 0.25, Appendix 4.1 and 4.3).

No temporal pattern occurred among $\delta^{13}\text{C}$ values of primary producers (Appendix 4.1). Spatial patterns were observed particularly between habitats. Microphytobenthos $\delta^{13}\text{C}$ values were higher in sandflat SR ($-9.4\text{‰} \pm 2.8$) compared to mudflat SR ($-16.2\text{‰} \pm 1.5$) (Kruskal-Wallis test, $p < 0.001$, Appendix 4.4). Seagrass material was more ^{13}C -enriched in the Sylt-Rømø Bight ($-11.7\text{‰} \pm 1.4$) than in the Marennes-Oléron Bay ($-12.4\text{‰} \pm 0.9$, Kruskal-Wallis test, $p < 0.001$), while the opposite pattern was observed for detrital material (seagrass MO: $-11.9\text{‰} \pm 1.0$, seagrass SR: $-14.7\text{‰} \pm 1.4$, Kruskal-Wallis test, $p < 0.001$).

Mean $\delta^{15}\text{N}$ values of microphytobenthos were relatively variable, ranging from 3.7‰ (seagrass MO, spring) to 13.8‰ (sandflat SR, autumn) (Fig. 4.2). Seagrass leaves and roots had similar $\delta^{15}\text{N}$ values, ranging from 7.2‰ (seagrass MO, autumn) to 8.1‰ (seagrass SR, spring) and from 5.9‰ (seagrass SR, spring) to 7.4‰ (seagrass SR, autumn), respectively (Kruskal-Wallis tests, lowest p-value: 0.23). Mean $\delta^{15}\text{N}$ values of detrital material ranged from 6.3‰ to 9.7‰ among sites, with similar $\delta^{15}\text{N}$ values between sediment layers (Kruskal-Wallis tests, lowest p-value: 0.063, Appendix 4.2). No temporal variations were observed in the $\delta^{15}\text{N}$ values of primary producers (Kruskal-Wallis tests, lowest p-value: 0.1, Appendix 4.1). Detrital material was the only primary food source with significantly different $\delta^{15}\text{N}$ values between habitats, being more ^{15}N -enriched in the Sylt-Rømø Bight seagrass bed ($8.2\text{‰} \pm 0.4$) than in the Marennes-Oléron Bay ($6.7\text{‰} \pm 0.5$) (Kruskal-Wallis test, $p < 0.001$).

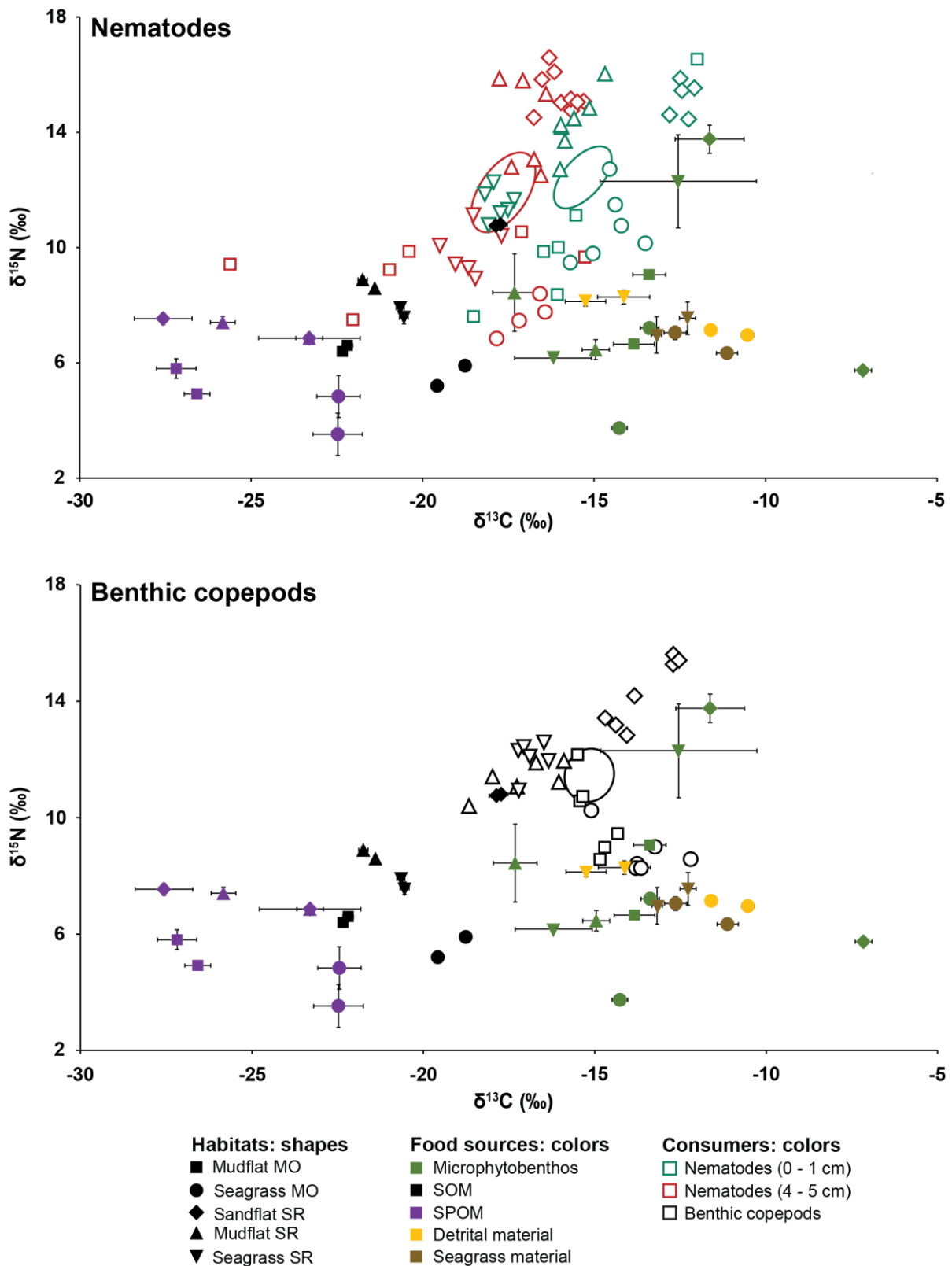

Figure 4.2. Isotope compositions ($\delta^{13}\text{C}$ and $\delta^{15}\text{N}$) of food sources (mean \pm SD, $n = 3$) and nematodes (top panel) and benthic copepods (bottom panel) in the mudflats, seagrass beds and sandflat in the Marennes-Oléron Bay (MO) and Sylt-Rømø Bight (SR) in spring and autumn. For nematodes and benthic copepods each point represents a group of 10 to 100 individuals. Ellipses represent 95% confidence regions for isotope compositions of surface layer nematodes (green), deep layer nematodes (red) and benthic copepods (black). Abbreviations: SPOM = suspended particulate organic matter, SOM = sediment organic matter.

3.1.2. Fatty acid compositions

Microphytobenthos FA compositions were very different from those of seagrass material (i.e., leaves, roots) and detritus (hierarchical cluster analysis, Fig. 4.3). Microphytobenthos was composed of high amounts of diatom markers (47–75%), and contained moderate amounts of bacteria markers (3–19%) and flagellate markers (5–11%), as well as ubiquitous FAs (10–34%). FA profiles of seagrass leaves and roots were composed of high amounts of vascular plant markers (45–60%) and of ubiquitous FAs (35–40%). Detritus were also composed of relatively high amounts of vascular plant markers (21–54%) and of ubiquitous FAs (26–41%) with a higher influence of bacteria markers (4–18%) and diatom markers (3–19%). Hierarchical clusters highlighted no temporal variation for FA compositions of microphytobenthos, seagrass leaves, seagrass roots and detrital material.

3.2. Composite food sources

3.2.1. Isotope compositions

SPOM had mean $\delta^{13}\text{C}$ values ranging from -27.6‰ (sandflat SR, spring) to -22.5‰ (seagrass MO, spring) and mean $\delta^{15}\text{N}$ values ranging from 3.5‰ (mudflat MO, autumn) to 7.5‰ (sandflat SR, spring, Fig. 4.2). Isotope compositions were similar between spring and autumn (Kruskal-Wallis tests, lowest p-value: 0.1, Appendix 4.1). SPOM from the Marennes-Oléron Bay ($\delta^{13}\text{C}$: -24.2‰ \pm 2.5; $\delta^{15}\text{N}$: 4.8‰ \pm 1.5) was more ^{13}C -enriched and ^{15}N -depleted compared to the Sylt-Rømø Bight ($\delta^{13}\text{C}$: -26.3‰ \pm 2.4; $\delta^{15}\text{N}$: 7.2‰ \pm 0.8; Kruskal-Wallis tests, highest p-value: 0.055). At the local scale, the SPOM in the Marennes-Oléron Bay seagrass bed was much more ^{13}C -enriched (-22.5‰ \pm 4.2) than in the mudflat (-26.9‰ \pm 5.4, Kruskal-Wallis test, $p < 0.001$), while SPOM isotope compositions were similar at all locations in the Sylt-Rømø Bight (Appendix 4.4).

Mean $\delta^{13}\text{C}$ values of SOM ranged from -22.5‰ in sub-surface layer of mudflat MO in spring to -17.7‰ in surface layer of sandflat SR in spring (Fig. 4.2, Appendix 4.1). SOM $\delta^{13}\text{C}$ values did not follow any temporal variation (Kruskal-Wallis tests, lowest p-value: 0.1, Appendix 4.1). At the spatial level, SOM was more enriched in ^{13}C in the sandflat (-17.8‰ \pm 0.4) than in the two mudflats (mudflat MO: -22.3‰ \pm 0.2, mudflat SR: -21.6‰ \pm 0.3, Kruskal-Wallis tests, highest p-value: 0.004, Appendix 4.4). In the Marennes-Oléron Bay, SOM from the seagrass bed (-19.2‰ \pm 0.5) had higher $\delta^{13}\text{C}$ values than in the mudflat (Kruskal-Wallis tests, highest p-value: 0.005). In the Sylt-Rømø Bight differences were also observed between sediment layers, with higher $\delta^{13}\text{C}$ values of SOM from sub-surface layers in the mudflat and the seagrass bed (Kruskal-Wallis tests, highest p-value: 0.031, Appendix 4.2).

Mean $\delta^{15}\text{N}$ values of SOM ranged from 4.9‰ in sub-surface layer of seagrass MO in spring to 10.9‰ in sub-surface layer of sandflat SR in spring. As for carbon, no clear temporal pattern was observed (Kruskal-Wallis tests, lowest p-value: 0.1, Appendix 4.1). SOM in the mudflat and the seagrass bed of the Sylt-Rømø Bight were significantly more ^{15}N -enriched in the sub-surface layer,

while the opposite was observed in the seagrass bed of Marennes-Oléron Bay (Kruskal-Wallis tests, highest p-value: 0.031, Appendix 4.2).

For each habitat, isotope compositions of benthic food sources (SOM, microphytobenthos and seagrass material), ranging from -22.5 to -7.2‰ were more ^{13}C -enriched than SPOM, ranging from -27.6 to -22.5‰ (Fig. 4.2, Appendix 4.3).

3.2.2. *Fatty acid compositions*

SOM and SPOM were relatively well discriminated based on their FA compositions, with SPOM samples being grouped into a single cluster and SOM samples being significantly separated into four clusters (Fig. 4.4). Within these four clusters, three were represented only by one or two samples. SOM was characterized by high proportions of diatom markers (17–62%, mean: 45%), bacteria markers (5–28%, mean: 16%) as well as ubiquitous FAs (20–58%, mean: 28%). All SOM samples had a similar FA composition except SOM from the sub-surface layer in seagrass MO in spring and autumn, from the sub-surface layer in mudflat MO in autumn and from the surface layer in sandflat SR in autumn, which differed for different reasons: sub-surface layer SOM in seagrass MO was characterized by much higher proportions of vascular plant markers (16–18%), sub-surface layer SOM from mudflat MO in autumn contained a higher proportion of typical animal FA (10%) and SOM from sandflat SR in autumn had a high proportion of flagellate FA markers (10%).

FA compositions of SPOM differed from those of SOM due to their lower proportions of diatom markers (29–51%), bacteria markers (5–13%) and flagellate markers (2–10%), as well as the higher proportions of ubiquitous FAs (28–46%, Fig. 4.4). Neither clear temporal nor spatial patterns could be observed in SPOM FA compositions.

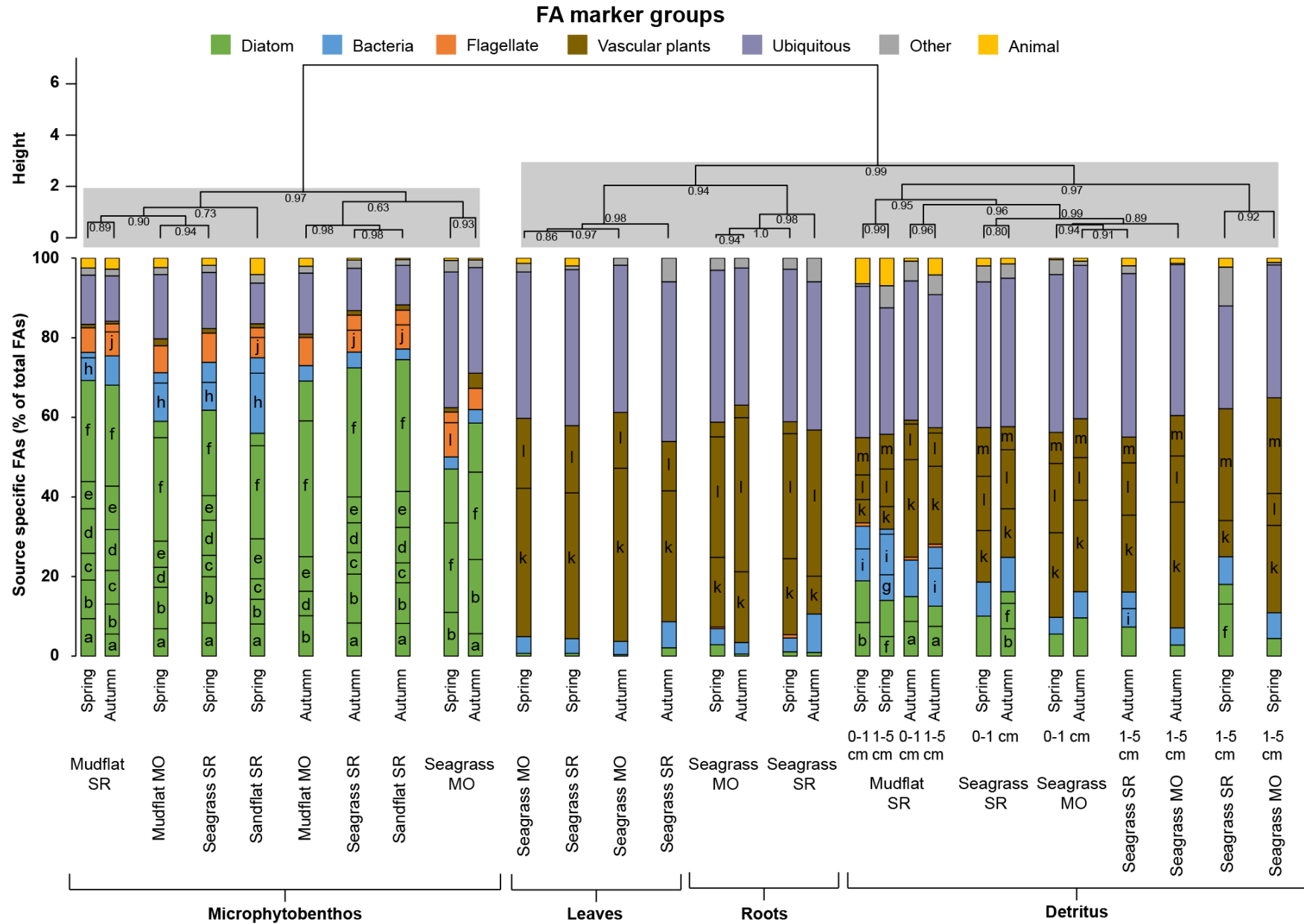

Figure 4.3. Fatty acid (FA) compositions (relative percentages, $n = 1$) of primary producers (i.e., microphytobenthos, seagrass leaves and roots, and detritus), in the mudflats, seagrass beds and sandflat in the Marennes-Oléron Bay (MO) and Sylt-Rømø Bight (SR) in spring and autumn. FAs are grouped according to their marker groups (see Table 4.1) and FAs with relative percentages $> 5\%$ (Appendix 4.5) are indicated with letters: (a) 14:0, (b) 16:1($n-7$), (c) 16:2($n-4$), (d) 16:3($n-4$), (e) 16:4($n-1$), (f) 20:5($n-3$), (g) *i*-15:0, (h) *a*-15:0, (i) 18:1($n-7$), (j) 22:5($n-3$), (k) 18:2($n-6$), (l) 18:3($n-3$) and (m) 24:0. Empty bars represent the sum of other FAs ($< 5\%$) for each FA marker group. Hierarchical clustering (Ward D2 method, Chi-squared distance) was performed. Approximately unbiased (AU) probability values (p-values) by multiscale bootstrap resampling ($n = 10,000$) are given under each node and identified clusters ($AU \geq 0.95$) are highlighted with gray boxes.

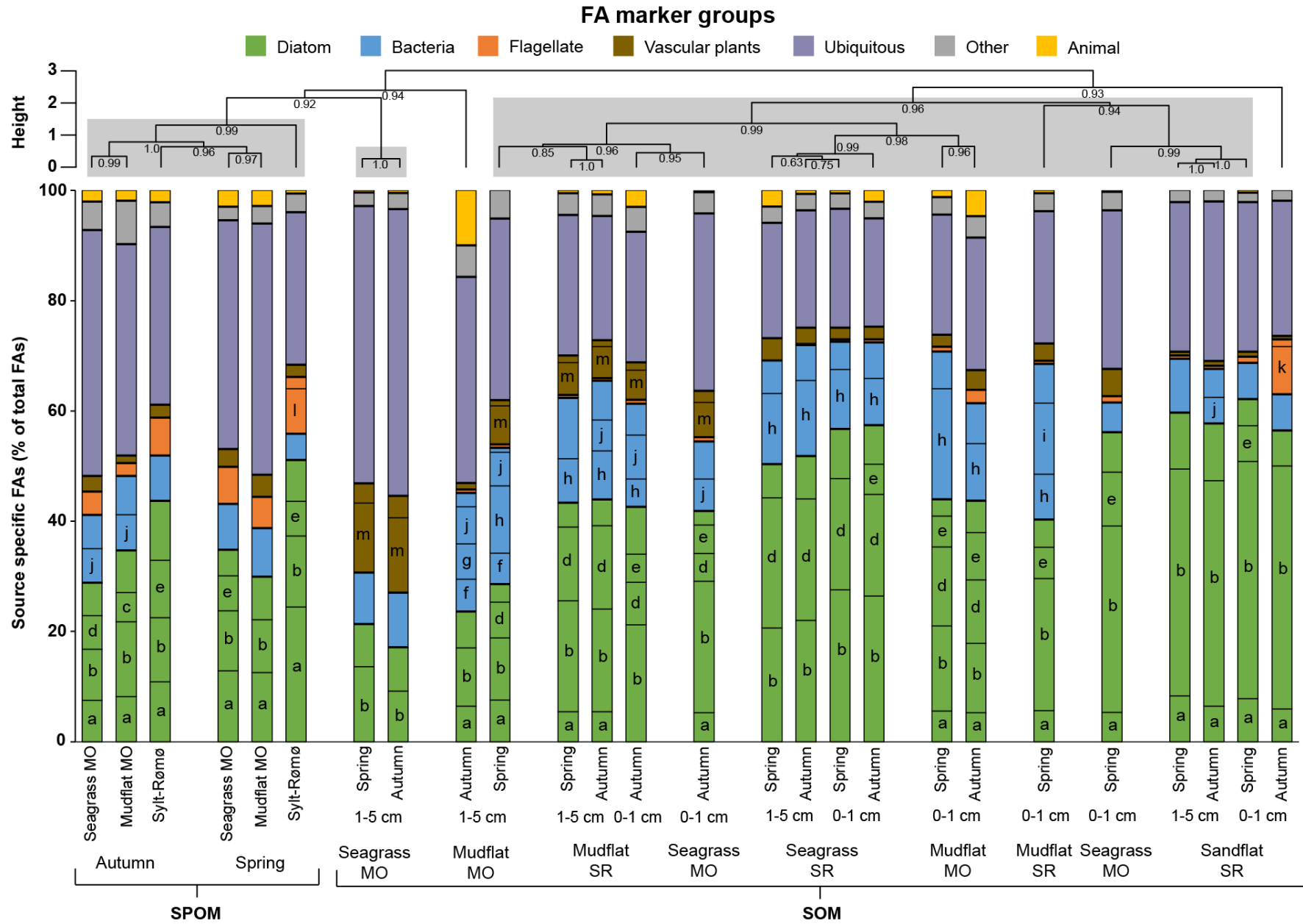

Figure 4.4. Fatty acid (FA) compositions (relative percentages, $n = 1$) of composite food sources (i.e., sediment organic matter (SOM) and suspended particulate organic matter (SPOM)), in the mudflats, seagrass beds and sandflat in the Marennes-Oléron Bay (MO) and Sylt-Rømø Bight (SR) in spring and autumn. Data for surface (0 - 1 cm) and sub-surface layers (1 - 5 cm) are displayed for detritus and SOM. FAs are grouped according to their marker groups (Table 4.1) and FAs with relative percentages > 5% (Appendix 4.5) are indicated with letters: (a) 14:0, (b) 16:1($n-7$), (c) 16:2($n-4$), (d) 16:3($n-4$), (e) 20:5($n-3$), (f) *i*-15:0, (g) *a*-15:0, (h) 15:0, (i) 17:1, (j) 18:1($n-7$), (k) 22:5($n-3$), (l) 22:6($n-3$), and (m) 24:0. Empty bars represent the sum of other FAs (< 5%) for each FA marker group. Hierarchical clustering (Ward D2 method, Chi-squared distance) was performed, approximately unbiased (AU) probability values (p-values) by multiscale bootstrap resampling ($n = 10,000$) are given under each node and identified clusters ($AU \geq 0.95$) are highlighted with gray boxes.

3.2.3. Isotope composition of diatom and bacteria FA markers

In potential food sources, $\delta^{13}\text{C}$ values of 20:5($n-3$) (i.e., diatom marker) were lower in SPOM than those in SOM and microphytobenthos (Kruskal-Wallis tests, highest p-value: 0.02; Fig. 4.5). $\delta^{13}\text{C}$ values of 20:5($n-3$) from SPOM indeed ranged from -33.1 to -25.4‰ while SOM and microphytobenthos had $\delta^{13}\text{C}$ values of 20:5($n-3$) between -30.5 and -14.7‰ and between -20.1 to -11.7‰, respectively. 20:5($n-3$) from SOM collected in mudflat MO was much more depleted in ^{13}C than in all other habitats. No temporal pattern occurred among $\delta^{13}\text{C}$ values of 20:5($n-3$) of primary producers and composite food sources (Kruskal-Wallis tests, lowest p-value: 0.11). SOM had similar $\delta^{13}\text{C}$ values of 20:5($n-3$) between both sediment layers (Kruskal-Wallis test, p-value: 0.83).

As for the 20:5($n-3$), the $\delta^{13}\text{C}$ values of the 15:0 (i.e., bacteria marker) well discriminated SPOM (range from -29.7 to -25.9‰) from microphytobenthos (range from -19.9 to -11.8‰, Fig. 4.5) (Kruskal-Wallis test, $p < 0.001$), with much lower values measured in SPOM. $\delta^{13}\text{C}$ values of 15:0 in SPOM were also lower than those of SOM (range from -23.5 to -17.4‰, Kruskal-Wallis test, $p < 0.02$), while 15:0 from SOM had lower $\delta^{13}\text{C}$ values compared to microphytobenthos (Kruskal-Wallis test, $p < 0.05$). No temporal pattern occurred among $\delta^{13}\text{C}$ values of 15:0 of primary producers and composite food sources (Kruskal-Wallis tests, highest p-value: 0.11). No temporal variations occurred among $\delta^{13}\text{C}$ values of 15:0 of primary producers and composite food sources (Kruskal-Wallis tests, lowest p-value: 0.07). SOM $\delta^{13}\text{C}$ values of 15:0 were more ^{13}C -enriched in surface layers than in sub-surface layers (Kruskal-Wallis tests, p-value: 0.033).

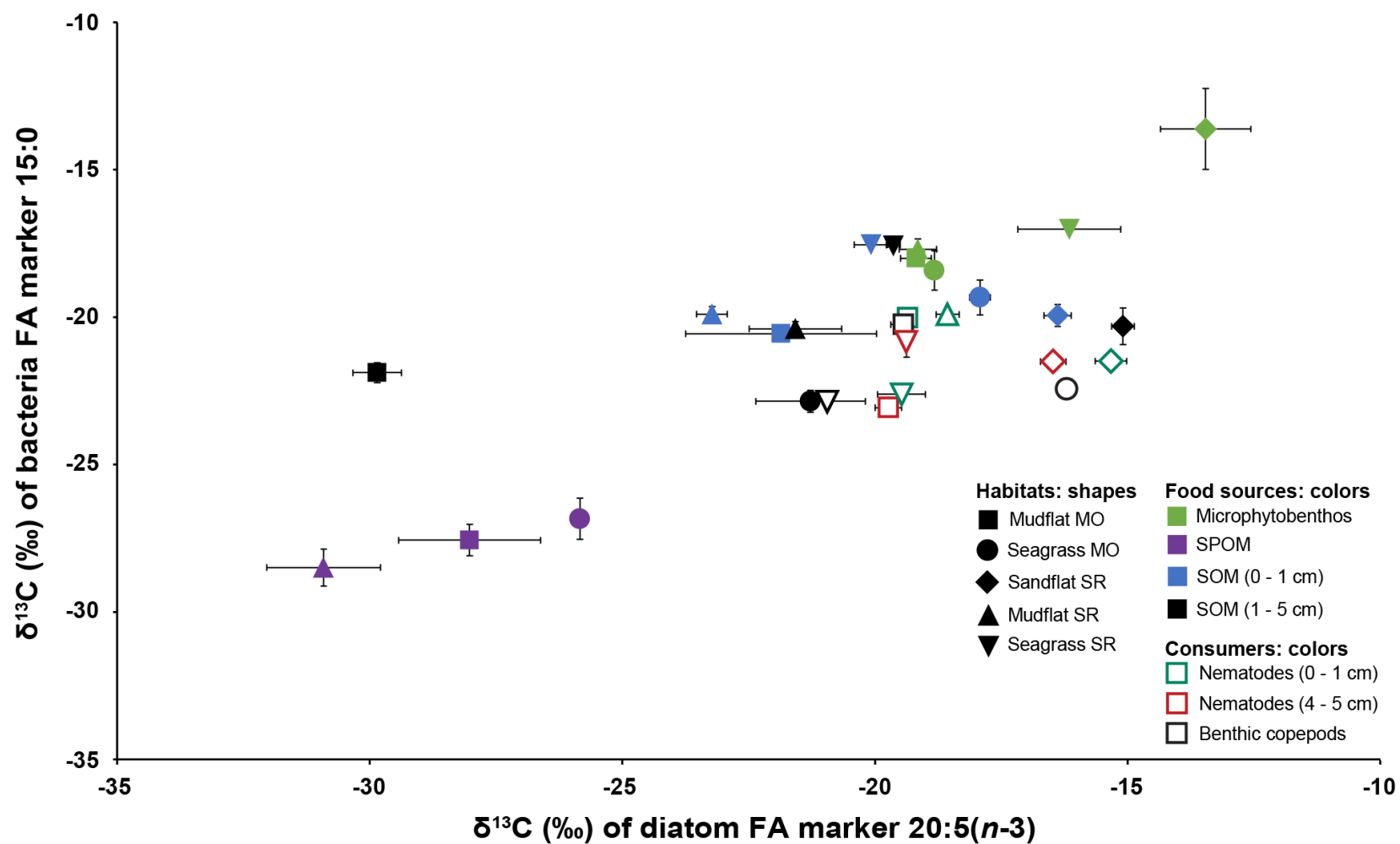

Figure 4.5. $\delta^{13}\text{C}$ values (mean \pm standard deviation, $n = 4$) of fatty acids 20:5($n-3$) (diatom FA marker) and 15:0 (bacteria FA marker) of potential food sources (i.e., microphytobenthos, suspended particulate organic matter (SPOM), and sediment organic matter (SOM)), nematodes and benthic copepods in the mudflats, seagrass beds and sandflat in the Marennes-Oléron Bay (MO) and Sylt-Rømø Bight (SR). Data for surface (0 - 1 cm) and sub-surface layers (1 - 5 cm) are displayed for SOM. Data for surface (0 - 1 cm) and deep layers (4 - 5 cm) are displayed nematodes.

3.3. Nematodes and benthic copepods

3.3.1. Isotope composition and contribution of food sources

Mean $\delta^{13}\text{C}$ values of nematodes from the surface and the deep layers ranged from -17.9‰ (seagrass SR, spring) to -12.2‰ (sandflat SR, autumn) and from -20.4‰ (mudflat MO, autumn) to -15.5‰ (sandflat SR, autumn), respectively (Fig. 4.2). In all habitats, nematodes were more ^{13}C -enriched in surface sediment layers than in deep sediment layers (Kruskal-Wallis tests, highest p-value: 0.020, Appendix 4.2). No temporal variation was observed in $\delta^{13}\text{C}$ values of nematodes (Kruskal-Wallis tests, lowest p-value: 0.1, Appendix 4.1).

Mean $\delta^{15}\text{N}$ values of nematodes ranged from 8.7‰ (mudflat MO, spring) to 15.3‰ (sandflat SR, spring) and from 7.4‰ (seagrass MO, spring) to 15.6‰ (mudflat MO, spring) in surface- and deep layers, respectively. The nematodes in the seagrass beds presented higher $\delta^{15}\text{N}$ values in the surface layer compared to the deep layer (Kruskal-Wallis tests, highest p-value: 0.011) while no difference was observed in other habitats (Kruskal-Wallis tests, lowest p-value: 0.65, Appendix 4.2). As for $\delta^{13}\text{C}$ values, no temporal variation occurred in $\delta^{15}\text{N}$ values of nematodes (Kruskal-Wallis tests, lowest p-value: 0.1, Appendix 4.1).

Isotope compositions of benthic copepods were in range with those of nematodes from the surface layers, with $\delta^{13}\text{C}$ and $\delta^{15}\text{N}$ values ranging between -18.3‰ (seagrass SR, spring) and -12.7‰ (sandflat SR, autumn) and between 8.3‰ (seagrass MO, spring) and 15.4‰ (sandflat SR, autumn), respectively (Fig. 4.2, Appendix 4.1). As for nematodes, isotope compositions of benthic copepods did not follow any temporal pattern (Kruskal-Wallis tests, lowest p-value: 0.1, Appendix 4.1).

At the habitat scale, MixSIAR outputs for nematodes from the surface layer highlighted the importance of two major food sources for these consumers: microphytobenthos and seagrass material (Fig. 4.6, Appendix 4.6). Microphytobenthos represented the highest dietary contributions to nematodes in mudflat MO (90% CI from 52 to 89%), in seagrass SR (22 to 68%) and in sandflat SR (50 to 89%). Contributions of seagrass material were the most important in mudflat SR (90% CI ranging from 8 to 98%) and in seagrass MO (26 to 79%), where the contributions of microphytobenthos were much lower. SOM contributions were intermediate in seagrass SR, sandflat SR, seagrass MO and mudflat MO with 90% CI ranging from 1 to 61%. The contribution of SPOM and bacteria to the food sources of nematodes was low with 90% CI ranging from 0 to 39% and from 0 to 18%, respectively.

Comparisons of MixSIAR outputs for nematodes from the deep layer at the habitat scale highlighted a higher role of SOM than in the surface layer (Fig. 4.6, Appendix 4.6). SOM represented the most important contributions in mudflat MO, seagrass MO, seagrass SR and sandflat SR with similar 90% CI ranges between 1 and 87%. Nevertheless, SOM contribution was very low in mudflat SR, where seagrass material had the highest dietary contributions for deep layer nematodes (90% CI from 15 to 95%). Seagrass material represented relatively important contributions in the seagrass beds

(90% CI from 1 to 63%) while microphytobenthos was an additional important food source of deep layer nematodes in the mudflats and sandflat (0 to 75%). As in the surface layers, the contributions of SPOM and of bacteria were relatively low, with 90% CI ranging from 0 to 52% and from 0 to 33%, respectively.

Benthic copepods revealed a similar pattern of MixSIAR outputs as for nematodes comparing the surface layer of the sediment between habitats (Fig. 4.6, Appendix 4.6). Microphytobenthos represented the highest dietary contributions to benthic copepods in mudflat MO (90% CI from 53 to 85%), in seagrass SR (30 to 66%), and in sandflat SR (39 to 78%). After the model, seagrass material was the most abundant food source of benthic copepods in seagrass MO (90% CI ranging from 25 to 76%) and in mudflat SR (21 to 87%), where contributions of microphytobenthos were much lower. SOM substantially contributed to the food sources of benthic copepods in all habitats with 90% CI ranging from 1 to 54%. Contributions of SPOM and bacteria were relatively low with upper limits of 90% CI lower than 30% and 15%, respectively.

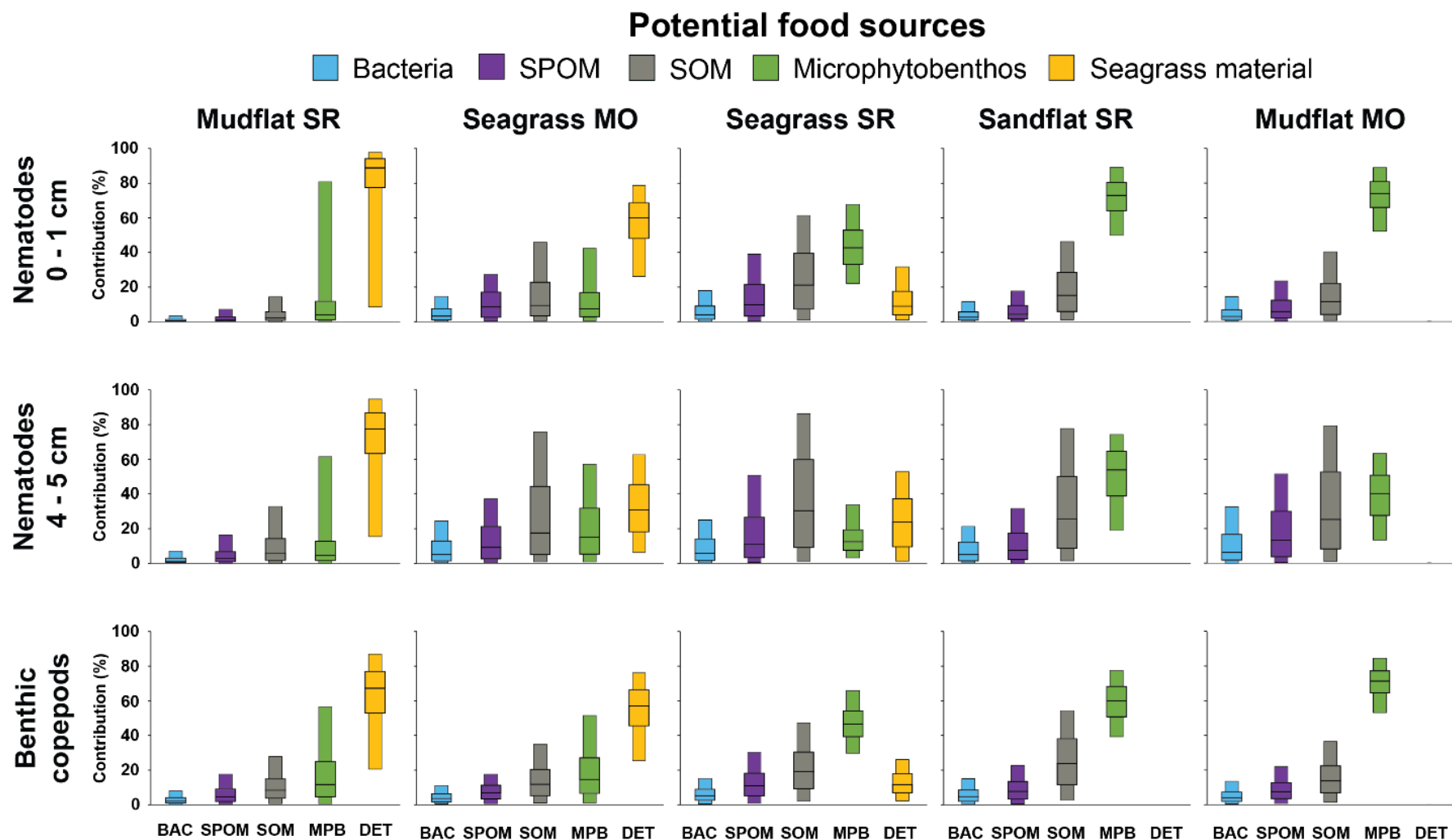

Figure 4.6. Contributions (%) of bacteria (BAC), suspended particulate organic matter (SPOM), sediment organic matter (SOM), microphytobenthos (MPB) and fresh and detrital seagrass material (DET) as food sources for nematodes and benthic copepods provided by the stable isotope mixing model MixSIAR. Median, 50% credibility intervals and 90% credibility intervals are displayed by the line, the large box and the smaller box, respectively (Appendix 4.6).

3.3.2. Fatty acid compositions

FA compositions of nematodes were characterized by high proportions of bacteria markers (16–51%) and diatom markers (13–27%) as well as ubiquitous FAs (15–41%) (Fig. 4.7). Benthic copepod FA profiles were composed of relatively high proportions of diatom markers (18–31%), bacteria markers (5–30%) and flagellate markers (5–21%). Ubiquitous FAs represented from 25% to 65% of the fatty acids in benthic copepods. Nematodes and benthic copepods were not clearly separated based on FA profiles, nevertheless, relative proportions of bacteria markers were generally lower in benthic copepods than in nematodes. Relative percentages of vascular plant markers were very low—particularly in benthic copepods—with highest proportions measured in nematodes from the seagrass bed SR (4–7%), seagrass MO (6–9%) and mudflat SR (autumn; 4%).

Nematodes from the sandflat had similar FA compositions within seasons and sediment layers. Benthic copepods from the mudflat MO had similar FA compositions within seasons. Comparisons of FA profiles between seasons and sediment layers was hampered by the low quantities of material in some samples. The amount of material was indeed too low for nematodes from mudflat SR and sandflat SR in spring, as well as seagrass MO in autumn. It was too low for benthic copepods of mudflat SR and sandflat SR in autumn.

3.3.3. Isotope composition of diatom and bacteria FA markers

$\delta^{13}\text{C}$ values of 20:5(*n*-3) (i.e., diatom marker) were slightly lower for benthic copepods (mean: $-20.3\text{‰} \pm 3.8$) compared to nematodes from the two sediment layers (mean $-18.2\text{‰} \pm 1.6$, Kruskal-Wallis tests, p-value: 0.038; Fig. 4.5). No temporal pattern occurred among $\delta^{13}\text{C}$ values of 20:5(*n*-3) of benthic copepods and nematodes from surface and deep layers (Kruskal-Wallis tests, lowest p-value: 0.24). Nematodes had similar $\delta^{13}\text{C}$ values of 20:5(*n*-3) in both sediment layers (Kruskal-Wallis tests, p-value: 0.30).

$\delta^{13}\text{C}$ values of 15:0 (i.e., bacteria marker) from nematodes ($-21.3\text{‰} \pm 1.2$) and benthic copepods ($-21.1\text{‰} \pm 1.4$) were similar (Kruskal-Wallis test, p-value: 0.53). No temporal pattern occurred among $\delta^{13}\text{C}$ values of 15:0 of benthic copepods and nematodes from surface and deep layers (Kruskal-Wallis tests, lowest p-value: 0.43). Nematodes 15:0 FA had similar $\delta^{13}\text{C}$ values between sediment layers, except in mudflat MO where more it was more ^{13}C -enriched in the surface layer (Kruskal-Wallis tests, p-value: 0.039).

Carbon isotope compositions of 20:5(*n*-3) and 15:0 from nematodes and benthic copepods were in range of those of microphytobenthos and SOM, and much more enriched in ^{13}C than those of SPOM.

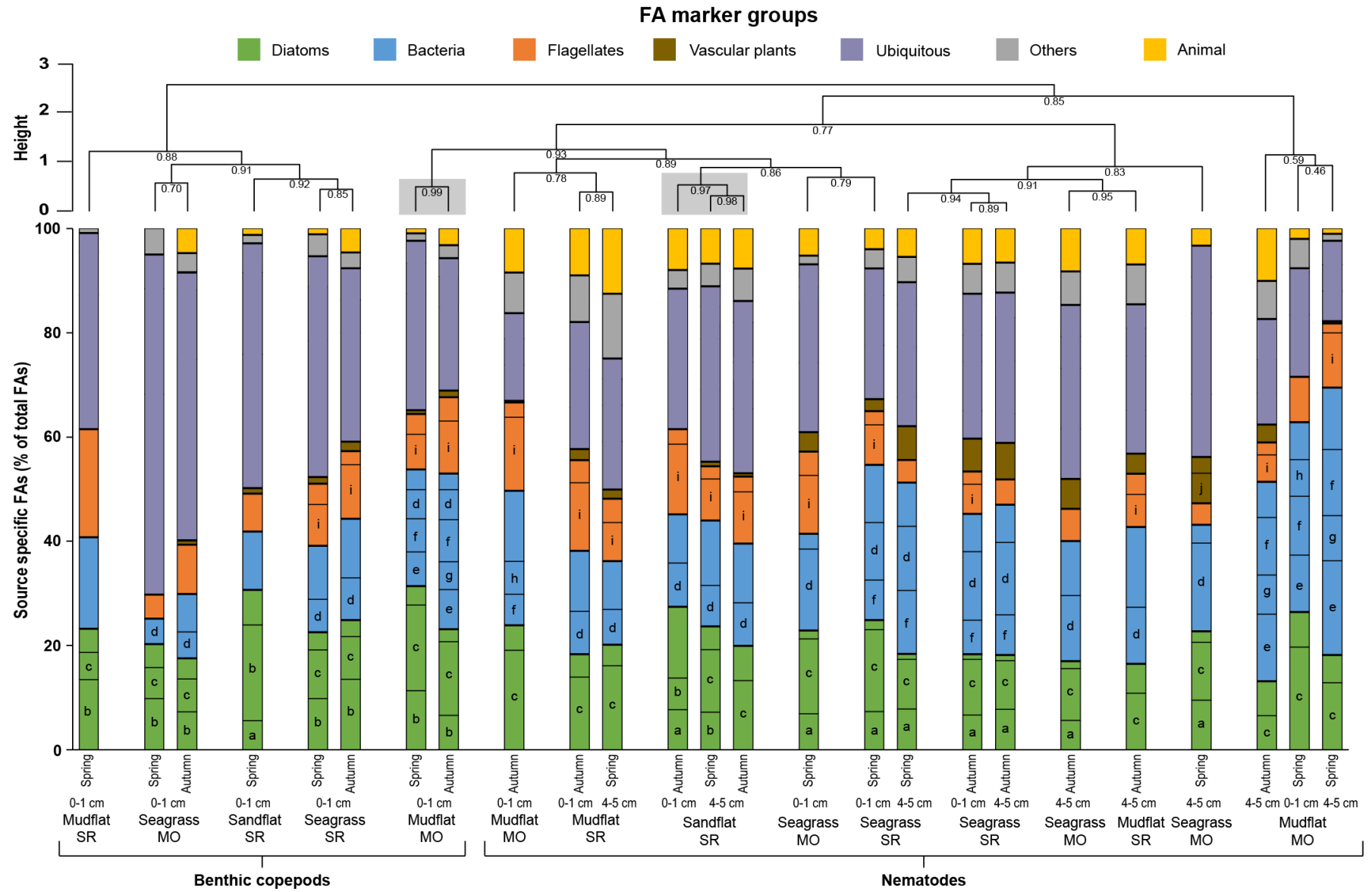

Figure 4.7. Fatty acids (FAs) compositions (relative percentages, $n = 1$) of nematodes and benthic copepods in the mudflats, seagrass beds and sandflat in the Marennes-Oléron Bay (MO) and Sylt-Rømø Bight (SR) in spring and autumn. Data for surface (0 - 1 cm) and deep layers (4 - 5 cm) are displayed for nematodes. FAs are grouped according to their marker groups (Table 4.1) and only FAs with relative percentages > 5% (Appendix 4.7) are indicated with letters: (a) 14:0, (b) 16:1($n=7$), (c) 20:5($n=3$), (d) 18:1($n=7$), (e) 15:0, (f) 17:1($n=9$), (g) 17:0, (h) 19:1($n=9$), (i) 22:6($n=3$), and (j) 18:2($n=6$). Empty bars represent the sum of other FAs (< 5%) for each FA marker group. Hierarchical clustering (Ward D2 method, Chi-squared distance) was performed. Approximately unbiased (AU) probability values (p-values) by multiscale bootstrap resampling ($n = 10,000$) are given under each node and identified clusters (AU ≥ 0.95) are highlighted with gray boxes.

3.4. Two-dimensional analysis on food sources and consumers using $\delta^{13}\text{C}$ values and FA compositions

Potential food sources were well separated based on the combination of their carbon isotope compositions and relative percentages of diatom markers (Fig. 4.8a). Seagrass material and detritus had high $\delta^{13}\text{C}$ values (from -19.0 to -10.4‰) and had low proportions of diatom markers (0–19%), SPOM had low $\delta^{13}\text{C}$ values (from -27.6 to -22.5‰) and intermediate relative percentages of diatom markers (29–51%), and microphytobenthos had high $\delta^{13}\text{C}$ values (from -17.3 to -7.2‰) and large proportions of diatom markers (47–75%). SOM and SPOM could be relatively well distinguished based on the combination of $\delta^{13}\text{C}$ values and relative percentages of bacteria markers (Fig. 4.8b): SPOM had low $\delta^{13}\text{C}$ values and relatively low amounts of bacteria markers (5–13%), while SOM was more ^{13}C -enriched (from -22.5 to -17.7‰) or had higher relative proportions of bacteria markers (5–28%). Seagrass material and detritus were well separated from microphytobenthos and composite food sources based on the combination of carbon isotope compositions and relative percentages of vascular plant markers (Fig. 4.8c). Proportions of vascular plant markers were high in seagrass material (45–60%) and detritus (21–54%), and substantially lower in SOM (1–18%), SPOM (1–4%), and microphytobenthos (1–4%). Lastly, the combination of carbon isotope compositions and proportions of flagellate markers could separate microphytobenthos from seagrass material and detritus (Fig. 4.8d). Where $\delta^{13}\text{C}$ values were in the same range, the higher proportions of flagellate markers in microphytobenthos samples (5–11%) separated them from seagrass material (0–1%) and detritus (0–1%).

The combination of consumers' carbon isotope compositions with their relative proportions in diatom, bacteria, vascular plant and flagellate FA markers highlighted that nematodes and benthic copepods had very similar compositions, even between different seasons and sediment layers (Fig. 4.8).

The low amounts of vascular plant markers (0–9%) in meiofauna clearly separated them from fresh and detrital seagrass material, despite their $\delta^{13}\text{C}$ values being in the same range (Fig. 4.8c). There was also a large difference between SPOM and meiofauna due to the much higher $\delta^{13}\text{C}$ values of the

latter (Fig. 4.8), which were close to those of benthic food sources (i.e., microphytobenthos, SOM, fresh and detrital seagrass material). The trophic marker composition of consumers had relatively equal contributions of diatoms (13–31%; Fig. 4.8a) and bacteria (5–51%; Fig. 4.8b) based on FA proportions, while material of flagellate origin contributed to a lower extent (4–21%; Fig. 4.8d).

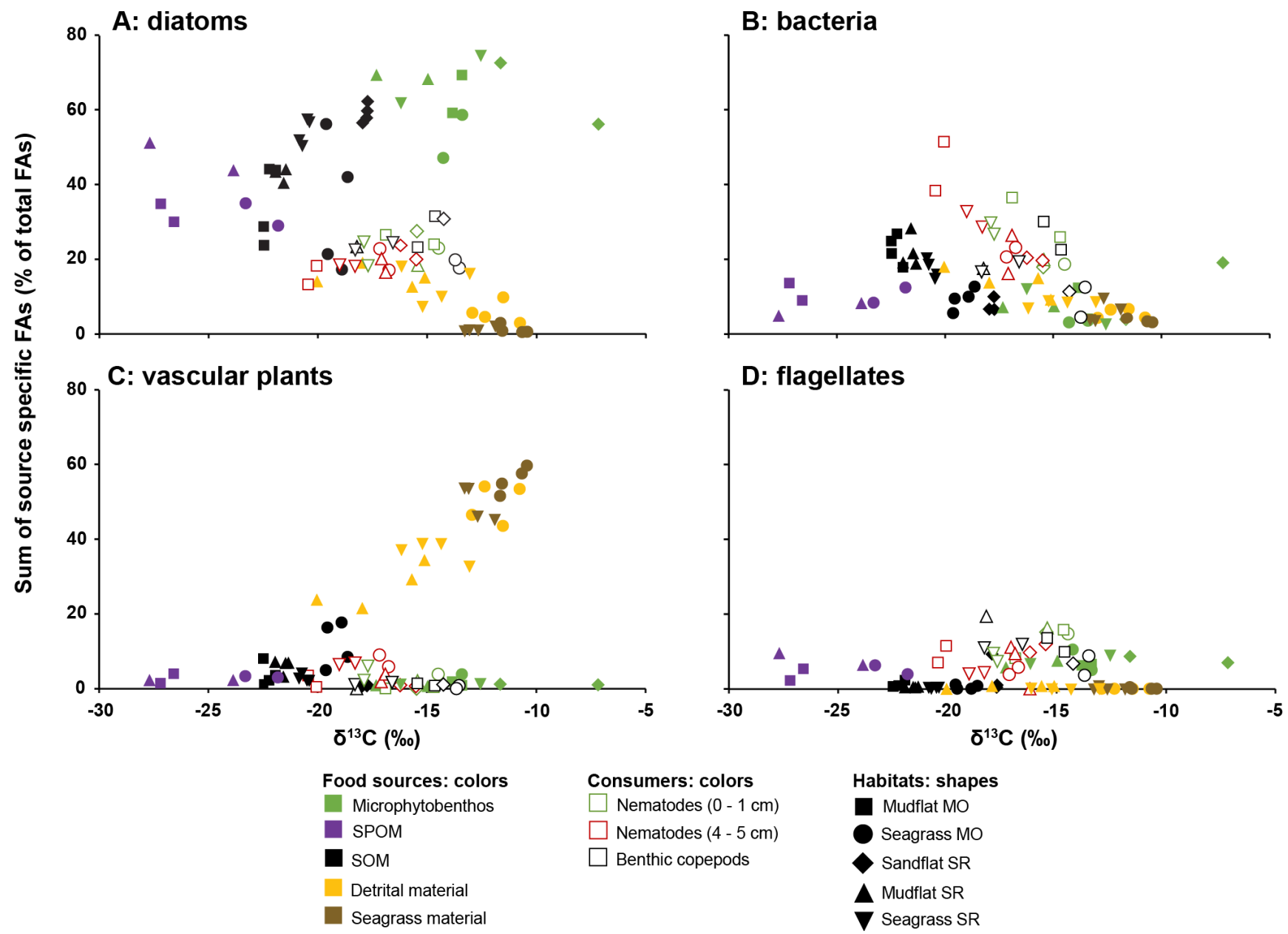

Figure 4.8a-d. Mean $\delta^{13}\text{C}$ values ($n = 3$) and relative percentages of fatty acid (FA) trophic markers ($n = 1$) of food sources, nematodes and benthic copepods in the mudflats, seagrass beds and sandflat in the Marennes-Oléron Bay (MO) and Sylt-Rømø Bight (SR). Data for surface (0 - 1 cm) and deep layers (4 - 5 cm) are displayed for nematodes. FAs were classified according to their trophic marker groups: **a**) diatoms, **b**) bacteria, **c**) vascular plants, and **d**) flagellates (see Table 4.1). SPOM: Suspended particulate organic matter, SOM: Sediment organic matter.

Potential food sources demonstrated diatom/bacteria FA marker ratios ranging from 0.08 to 0.85 (mean: 0.30 ± 0.19 , Fig. 4.9), well separating seagrass material from other potential food sources. Seagrass material had indeed diatom/bacteria FA marker ratios (0.39–0.58, mean: 0.49 ± 0.10) which were higher than other food sources. Seagrass roots had even higher diatom/bacteria FA marker ratios (0.73–0.85, mean: 0.78 ± 0.05). Microphytobenthos had among the lowest diatom/bacteria FA marker ratios ranging from 0.08 to 0.30 (mean: 0.15 ± 0.07). SOM, SPOM and detritus demonstrated relatively similar ranges of diatom/bacteria FA marker ratios with ranges from 0.08–0.43 (mean: 0.25 ± 0.11), from 0.18–0.38 (mean: 0.29 ± 0.08) and from 0.22–0.43 (mean: 0.33 ± 0.09), respectively.

Diatom/vascular plant FA marker ratios discriminate relatively well potential food sources (Fig. 4.9). Microphytobenthos had among the lowest diatom/vascular plant FA marker ratios ranging from 0.12 to 0.42 (mean 0.21 ± 0.10). SOM had generally higher diatom/vascular plant FA marker ratios (0.25–0.71, mean: 0.39 ± 0.13). SPOM demonstrated relatively higher diatom/vascular plant FA marker ratios (0.39–0.65, mean: 0.50 ± 0.10) compared to microphytobenthos. Detrital material was well distinguished from microphytobenthos, SOM and SPOM with much higher diatom/vascular plant FA marker ratios (0.77–0.92, mean: 0.84 ± 0.07). Seagrass leaves and roots were even more distinguished from microphytobenthos, SOM and SPOM and detritus with even higher diatom/vascular plant FA marker ratios for seagrass leaves (mean: 0.96 ± 0.02) and roots (mean: 0.98 ± 0.01).

Consumers had moderate mean diatom/bacteria FA marker ratios for surface layer nematodes (mean: 0.56 ± 0.13), deep layer nematodes (mean: 0.55 ± 0.07), and benthic copepods (mean: 0.39 ± 0.11) (Fig. 4.9). These ratios for consumers were much higher than the values measured in all potential food sources except for seagrass roots. Consumers had low diatom/vascular plant FA marker ratios (surface layer nematodes: 0.00–0.28, mean: 0.11 ± 0.12 , deep layer nematodes: 0.03–0.28, mean: 0.15 ± 0.10 , and benthic copepods: 0.00–0.07, mean: 0.03 ± 0.02), in the range of those measured in microphytobenthos and SOM. Within consumers, benthic copepods had the lowest range of diatom/vascular plant FA marker ratios, while ratios of nematodes from the surface- and deep layers were in the same range.

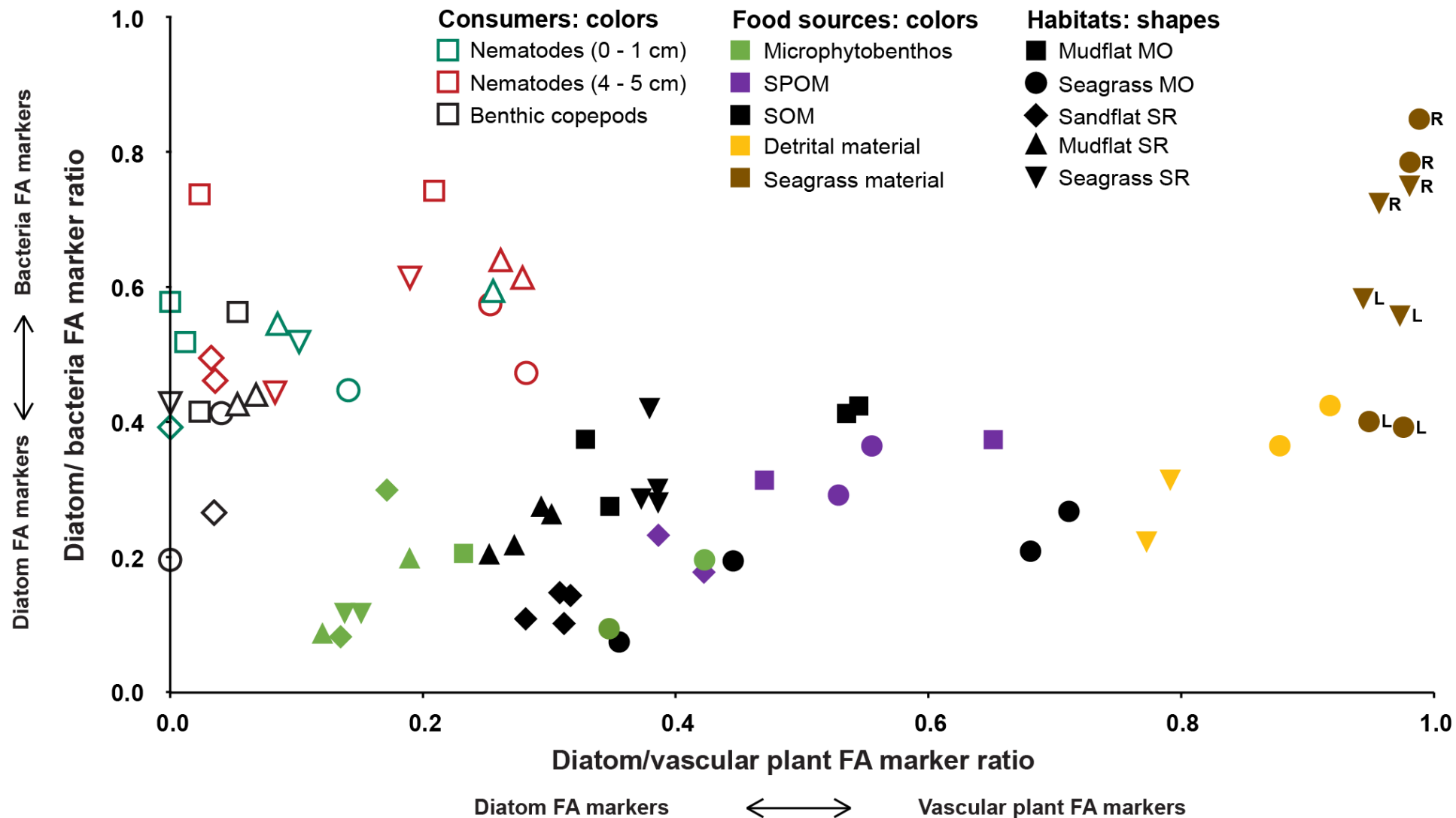

Figure 4.9. Ratios of diatom vs. vascular plant fatty acid (FA) markers and of diatom vs. bacteria FA markers of potential food sources, nematodes and benthic copepods in the mudflats, seagrass beds and sandflat in the Marennes-Oléron Bay (MO) and Sylt-Rømø Bight (SR). FAs were classified according to their trophic marker group (see Table 4.1). L: seagrass leaves, R: seagrass roots.

4. DISCUSSION

The aim of this study was to determine the food sources used by meiofauna in several habitats characterized by different primary producers in the Marennes-Oléron Bay, France, and the Sylt-Rømø Bight, Germany. Multiple trophic markers were used to discriminate food sources, since without a clear distinction of the potential food sources describing trophic relationships becomes challenging. These same trophic markers were then used to assess the main trophic fluxes between primary producers, bacteria and composite food sources and the two dominant groups of meiofauna: nematodes and benthic copepods.

4.1. Distinction of microphytobenthos and seagrass material based on FA profiles

Seagrass material and microphytobenthos were well separated based on their FA profiles whereas the discrimination of these food sources using their $\delta^{13}\text{C}$ and $\delta^{15}\text{N}$ values was very difficult. The mean $\delta^{13}\text{C}$ values of microphytobenthos, seagrass leaves and seagrass roots were within a similar range, as previously observed in mudflats (Riera et al., 1996; Rzeznik-Orignac et al., 2008) and seagrass beds (Lebreton et al., 2011). Microphytobenthos contained large amounts of diatom markers (i.e., 20:5(n -3), 16:1(n -7), and 16:4(n -1)), which confirmed the dominance of diatoms in the composition of microphytobenthos as observed by taxonomic studies (Asmus 1983). However, low to moderate amounts of bacteria markers also observed in microphytobenthos FA profiles, could be explained by the heterotrophic bacteria generally interacting with diatoms in microalgae mats (Agogué et al. 2014). This was contrarily to *Z. noltei* leaves and roots which exhibited large proportions of vascular plant markers (i.e., 18:2(n -6), 18:3(n -3), and 24:0) (Lebreton et al. 2011b). These different markers can be expressed as ratios between major FA groups, i.e., diatoms, bacteria, vascular plants, which provided a more synthetic overview of the distinction of food sources. The discrimination between microphytobenthos and seagrass material becomes even clearer when considering ratios of diatom/vascular plant markers and of diatom/bacteria markers. Ratios of diatom/vascular plant markers were much higher in seagrass material than in microphytobenthos. Microphytobenthos and seagrass roots were distinguished as well due to the higher diatom/bacteria ratios of seagrass roots. High diatom/bacteria ratios for seagrass roots could be explained by the high abundance of bacteria associated with seagrass roots (Jensen et al. 2007).

Detrital material had similar isotope compositions and FA profiles than seagrass leaves and roots indicating that it mostly originated from decaying seagrass. Because seagrass derived detrital material can be stored into the sediment (Duarte and Cebrián 1996), it is then available to endofauna. Additionally, the moderate proportions of vascular plant markers in detrital material of mudflat SR indicated that seagrass material can also be transported and stored in adjacent systems (van der Heijden et al. submitted). The diatom markers in the detrital material also highlighted an influence of microalgae in the composition of this material.

4.2. Distinction of SPOM, SOM and primary producers based on bulk and FA isotope compositions

Carbon isotope compositions of SPOM (-27.6‰ to -22.5‰)—much more ^{13}C -depleted than microphytobenthos (-17.3‰ to -7.2‰) and seagrass material (-19.0‰ to -10.4‰)—clearly separated SPOM

from these food sources. SPOM was mostly made of diatoms and, to a minor extent, of bacteria as highlighted by FA profiles. Very low proportions of vascular plant FA markers in SPOM indicated a negligible contribution of seagrass or terrestrial material, even in the Marennes-Oléron Bay where inputs of terrestrial organic matter are higher (Galois et al. 1996). Temporal differences were observed with higher proportions of flagellate markers in SPOM in spring compared to autumn (Lebreton et al. 2011b), which is most likely linked to the annual spring bloom of phytoplankton (Galois et al. 1996). Low $\delta^{13}\text{C}$ values of the diatom marker 20:5(*n*-3) indicated that diatoms in SPOM mostly originated from pelagic sources, as observed in the North Sea by Braeckman et al. (2015). As for diatoms, bacteria in SPOM relied mainly on pelagic sources as indicated by the low $\delta^{13}\text{C}$ values of the bacteria marker 15:0. These outcomes indicate a poor resuspension of benthic organic material at the two studied seasons, and therefore a minor benthic-pelagic coupling, which is much less important than estimated by previous studies (Dubois et al. 2012; Saint-Béat et al. 2014). Inputs of phytoplankton for several habitats might therefore be overestimated in constructed food web models constructed of the Marennes-Oléron Bay (Leguerrier et al. 2003; Saint-Béat et al. 2014) and the Sylt-Rømø Bight (Baird et al. 2007).

$\delta^{13}\text{C}$ values of SOM (-22.5‰ to -17.7‰) were similar to previous observations from mudflats (Rzeznik-Orignac et al. 2008), seagrass beds (Lebreton et al. 2011b; Vafeiadou et al. 2014) and sandflats (Moens et al. 2005b; Cnudde et al. 2015). They were intermediate between those of SPOM and those of microphytobenthos, detritus and seagrass material and could therefore not be used to well determine the contributions of the different primary producers, clearly highlighting the interest of the combination of SI and FA markers. Based on this last marker, SOM was mostly made of diatoms and bacteria, with very low contributions of seagrass or terrestrial material, even in seagrass beds where the load of seagrass material in the sediment was high (Lebreton et al., 2011; van der Heijden et al. in press). The highest contribution of seagrass material to SOM was observed in the sub-surface layer of seagrass MO, indicating that this material can be deeply buried. Diatoms from the SOM mainly originated from the microphytobenthos, as highlighted by the high $\delta^{13}\text{C}$ values of the diatom marker 20:5(*n*-3) (i.e., close to those of microphytobenthos). A similar pattern was found for bacteria: $\delta^{13}\text{C}$ values of the bacteria marker 15:0 in SOM indicated they used benthic primary producers, i.e., microphytobenthos, as a substrate (Boschker et al. 2000). Such results highlight the poor role of trapped material from the water column into the SOM, confirming the minor benthic-pelagic coupling between SPOM and SOM in the different studied habitats.

SOM compositions differed between habitats, with a much higher influence of diatoms in the SOM from sandflat SR (van der Heijden et al. submitted), as demonstrated by its higher $\delta^{13}\text{C}$ values and higher proportions of diatom FA markers. Isotope compositions of SOM varied also between sediment layers with SOM being more depleted in ^{13}C in the sub-surface layers, as already observed in the Schelde estuary (Moens et al. 2014). Such variations can be related to higher contribution of microphytobenthos (more ^{13}C -enriched; Dubois et al., 2012) in the surface layer and/or to a higher load of seagrass detrital material in the sub-surface layers. Detrital material generally has lower $\delta^{13}\text{C}$ values than its fresh counterpart (Lebreton et al. 2011b), as less labile compounds (e.g. lignin) are depleted in ^{13}C (Benner et al. 1987). Another explanation could be the

higher abundances of sulfide-reducing bacteria—characterized by very low $\delta^{13}\text{C}$ values (Robinson and Cavanaugh 1995)—in the deeper sediment layers (Wieringa et al. 2000).

4.3. Limited use of SPOM by nematodes and benthic copepods

Outputs of the mixing models indicated that contributions of SPOM as a food source to nematodes and benthic copepods were very low, due to the much higher $\delta^{13}\text{C}$ values of meiofauna compared to SPOM (between 6.3 and 10.7‰ higher). The limited use of diatoms and bacteria from SPOM by meiofauna is confirmed by the $\delta^{13}\text{C}$ values of the diatom marker 20:5(*n*-3) and of the bacteria marker 15:0, which are much higher in nematodes and benthic copepods than in SPOM. Low contribution of SPOM as a food source to nematodes and benthic copepods is evident in all habitats (i.e., vegetated and bare), even in seagrass beds where increased sedimentation of SPOM occurs (Ouisse et al., 2012). Such a poor role of SPOM as a food source for meiofauna is in accordance with previous studies carried out in mudflats and sandflats (Moens et al. 2005b, 2014; Rzeznik-Orignac et al. 2008). Low contribution of SPOM as a food source is also in agreement with the findings of Maria et al. (2011), who stated that meiofauna prefer locally produced benthic diatoms over marine pelagic food sources. This could be related to phytoplankton generally having higher fluctuations in biomass and production compared to other food sources (Galois et al. 1996) as well as to the ability of meiofauna to be more selective for food sources compared to their potential food competitors, i.e., macrofauna (Maria et al. 2011, 2012).

4.4. Limited use of seagrass material by nematodes and benthic copepods

Contributions of fresh and detrital seagrass material (*Z. noltei*) as food sources to nematodes and benthic copepods were very low, as highlighted by the very low proportions of vascular plant FA markers in nematodes and benthic copepods, even in seagrass beds where loads of seagrass material were high (van der Heijden et al. in press). The low use of seagrass material is much likely related to its poor nutritional value and high lignocellulose content (Vizzini et al. 2002). Such results are in contradiction with the outputs of the mixing models, which indicated moderate to high contributions of seagrass material to nematodes and benthic copepods, due to the close $\delta^{13}\text{C}$ values between this food source and meiofauna. The role of the seagrass material for meiofauna and, by extension, to coastal food webs is still under debate (Mateo et al. 2006). Leduc et al. (2009) demonstrated the significant contribution of seagrass detritus as a food source to meiofauna based on isotope compositions of potential sources and meiofauna, as well as FA profiles of fine SOM. Using stable isotope mixing models, Lebreton et al. (2012) and Vafeiadou et al. (2014) suggested that seagrass detritus could be a potential food source but highlighted some flaws related to overlapping isotope compositions of microphytobenthos and seagrass material, leading to possible overestimated contributions of seagrass material to the diet of meiofauna. As a result, our study highlights the importance of combining stable isotopes and fatty acids to better describe flows of organic matter, particularly when some food sources have close isotope compositions (which is often the case in coastal ecosystems). Especially combining stable isotopes and fatty acids in mixing models could provide complementary information in the form of more defined proportional dietary contributions. Using both isotopes compositions and fatty acid profiles, we clearly demonstrated that

seagrass material is poorly used by meiofauna, as previously also demonstrated for macrofauna (Jaschinski et al. 2008; Lebreton et al. 2011b), raising questions about the fate of this material in coastal ecosystems. Potential destinations of this material could be burial of seagrass material into the deeper sediment (Duarte and Cebrián 1996), exportation out of the system (McLusky and Elliott 2004; Mateo et al. 2006) and/or consumption by higher trophic levels such as herbivorous birds (Baird et al. 2007; Pacella et al. 2013). Isotope compositions and fatty acid profiles of deeper sediment could be helpful in determining the fate of this material.

4.5. Importance of microphytobenthos and bacteria as food sources to nematodes and benthic copepods

The use of multiple trophic markers (i.e., fatty acid profiles, bulk and FA specific stable isotope compositions) demonstrated the importance of microphytobenthos and bacteria as food sources for nematodes and benthic copepods in the mudflats, seagrass beds and sandflat of the Marennes-Oléron Bay and the Sylt-Rømø Bight in spring and autumn.

The important role of diatoms was demonstrated by the high proportions of diatom markers in the FA profiles of consumers and the large contributions of microphytobenthos to meiofauna as estimated by the mixing models. The close $\delta^{13}\text{C}$ values of the diatom marker 20:5(*n*-3) from microphytobenthos and meiofauna, much more ^{13}C -enriched than those of SPOM, confirmed that diatoms used by meiofauna originated from the benthos. The importance of microphytobenthos to meiofauna has been observed before in bare intertidal habitats (Rzeznik-Orignac et al. 2008; Leduc et al. 2009) as well as vegetated intertidal systems (Cnudde et al. 2015). Therefore, the combination of our results with previous observations indicates that microphytobenthos is an important food source to meiofauna, even when variation in food sources occurs due to habitat characteristics (e.g. growth of seagrass beds, sediment grain size) or seasonal variation (e.g. phytoplankton blooms).

The role of bacteria for the carbon requirements of meiofauna is of major importance as well, as highlighted by high proportions of bacteria FA markers in nematodes and benthic copepods. The $\delta^{13}\text{C}$ values of the bacteria marker 15:0 from the SOM ($-20.0\text{‰} \pm 1.7$) were much higher than the carbon isotope compositions of sulfide-oxidizing bacteria ($-35.0\text{‰} \pm 5.0$; Vafeiadou et al., 2014), indicating that most of the benthic bacteria from the SOM relied on microphytobenthos as a substrate (Boschker et al. 2000) and that biomass of sulfide-oxidizing bacteria were generally low. The $\delta^{13}\text{C}$ values of the bacteria marker 15:0 from nematodes and benthic copepods, in range with $\delta^{13}\text{C}$ values of bulk microphytobenthos, highlighted that meiofauna relied on benthic bacteria, themselves using microphytobenthos as a substrate. The close isotope composition of microphytobenthos and of bacteria actually used by meiofauna likely lowered the role of the bacteria when estimated using mixing models, as the isotope composition of sulfide-oxidizing bacteria (Vafeiadou et al. 2014) was used for such models. These bacteria, that use microphytobenthos as a substrate, could be of high importance as a food source for meiofauna (Pascal et al. 2008), particularly due to their constant biomass (Schmidt et al. 1998). However, determining the trophic relationship between these

microphytobenthos related bacteria and meiofauna remains problematic due to the difficulties of extracting bacteria and determining their isotope compositions (Coffin et al. 1990; Pelz et al. 1997).

Despite the high variability in biomass (van der Heijden et al. in press) and production (Blanchard et al. 1997; Asmus et al. 1998) of food sources between the different habitats, meiofauna relies primarily on high-quality food sources, i.e., microphytobenthos and bacteria. Both of these food sources are tightly connected as bacteria mostly uses microphytobenthos as a substrate. Exopolysaccharides (EPS) produced by microphytobenthos may be an important substrate as well, as an ecological equilibrium was observed between exopolysaccharides (EPS) production by microphytobenthos and consumption of EPS by bacteria (Pierre et al. 2013). The reliance of meiofauna on microphytobenthos might be related to its high nutritional quality, assimilation rates (Cebrián 1999) and constant biomass (Lebreton et al., 2009, van der Heijden et al. in press). Even if no temporal difference of meiofauna fatty acid compositions was observed between the two sampled seasons, a better understanding of the role of these two food sources (i.e., microphytobenthos and bacteria) remains needed. Indeed, even if their biomass were constant (van der Heijden et al. in press), their seasonal dynamics may be quite different with a lower production of microphytobenthos during summer due to photoinhibition (Blanchard et al. 1997; Serôdio et al. 2008) and therefore a more important role of bacteria at this season (Pascal et al. 2009; Saint-Béat et al. 2013a). Sundbäck et al. (1996) reported highly variable production rates of both microphytobenthos and bacteria, however, observed much higher turnover rates of bacteria (0.15–1.5 days) compared to microphytobenthos (2–44 days). Therefore, complementary information in the form of food web models could help in better determining the role of these food sources in relationship with meiofauna by taking into account both biomass and production (Warwick et al. 1979; Leguerrier et al. 2003).

Comparisons between sediment layers demonstrated, however, a relatively low contribution of microphytobenthos as a food source to nematodes living in deep sediment layers, as highlighted by the more ^{13}C -depleted isotope compositions of nematodes from deep layers, as observed by Vafeiadou et al., (2014). Lower biomass of microphytobenthos in deeper layers could be related to this decrease in consumption by meiofauna (van der Heijden et al. in press). However, higher relative abundances of selective deposit feeding nematodes in deep layers (van der Heijden et al. in press), which are known to feed on ^{13}C -depleted bacteria (Vafeiadou et al. 2014), could also explain the lower $\delta^{13}\text{C}$ values and therefore the higher contribution of bacteria. This highlights that determining the feeding behavior of nematodes at the scale of trophic groups would provide very complementary information as some nematodes can have very specific diets (i.e., relying on bacteria or on diatoms only) while some others can be more opportunistic (Majdi et al. 2012; Braeckman et al. 2015). Determining food sources of these different groups could therefore provide information about how nematodes with specific diets and more opportunistic ones can adjust their diets depending on available food resources.

4.6 Recommendations of combining trophic markers and of FA marker ratios

The simultaneous use of multiple trophic markers, i.e., stable isotopes, fatty acid profiles and compound specific isotope compositions of FAs, provided very complementary information and new insights about the feeding behavior of meiofauna. Information from FA profiles was indeed very complementary to stable isotope data when food sources had close isotope compositions. This was particularly the case in this study for two major food resources: microphytobenthos and seagrass material. The use of FA profiles permitted to discriminate clearly these two food sources and to highlight that nematodes and benthic copepods did not rely on seagrass material. FA profiles were also very useful at determining the importance of bacteria as a food source to meiofauna thanks to the very specific FA synthesized by bacteria (e.g. 15:0, 17:0, 18:1(*n*-7)). Combined to the isotope composition of a specific bacteria marker (i.e., 15:0), such information permitted to determine that these bacteria mostly used microphytobenthos as a substrate. Combining several trophic markers therefore avoids limits related to similar isotope compositions and provides very useful information about the origin of the food sources used by consumers.

As already done for a while in pelagic systems (Kharlamenko et al. 1995; Auel et al. 2002; Dalsgaard et al. 2003; El-Sabaawi et al. 2009; Gonçalves et al. 2012), determining ratios between the major groups of FA markers was also useful to better discriminate between food sources and to determine the use of food sources by meiofauna. Here we used two ratios, one to discriminate between bacteria and vascular plants and the other one to discriminate between bacteria and diatoms. It is very likely that other ratios can be developed to discriminate between other potential food sources in other benthic systems, depending on which food sources need to be studied.

5. CONCLUSION

Microphytobenthos and bacteria are the most important food sources used by nematodes and benthic copepods in several habitats of two soft-bottom coastal ecosystems on the east Atlantic coast. The important contribution of benthic algae to nematodes and benthic copepods is clearly indicated by high proportions of diatom FA markers as well as by a similar isotope composition of microphytobenthos and consumers. The important contribution of bacteria FA markers to meiofauna highlighted the importance of this food source utilizing mainly microphytobenthos as a substrate. Such a reliance on benthic diatoms and benthic bacteria is likely related to the high quality of these food sources in comparison with seagrass and detrital material. SPOM was also poorly used by meiofauna, probably due to its low and irregular trapping into the sediment, even in areas where sedimentation is generally higher (i.e., seagrass beds).

This study emphasizes the importance of utilizing multiple trophic markers when determining trophic relationships in coastal ecosystems. The limitations of each trophic marker could be overruled by the combination of several trophic markers. Combining these trophic markers could estimate more precisely fluxes of carbon in several benthic and pelagic environments, especially if determined for specific trophic groups. Using these estimated flows of energy in combination with biomass and productions rates in food web models could improve our knowledge regarding the role of meiofauna in the functioning of coastal food webs.

APPENDIX: CHAPTER 4

Appendix 4.1. Isotope compositions (‰, mean ± standard deviation, $n = 3$) of potential food sources, nematodes and benthic copepods. Comparisons of $\delta^{13}\text{C}$ and $\delta^{15}\text{N}$ values between spring and autumn (Kruskal-Wallis tests, p -values) in the mudflats, seagrass beds and sandflat in the Marennes-Oléron Bay (MO) and Sylt-Rømø Bight (SR). Data for surface (0 - 1 cm) and sub-surface (1 - 5 cm) layers are provided for sediment organic matter (SOM) and detritus. Data for surface (0 - 1 cm) and deep (4 - 5 cm) layers are provided for nematodes. SPOM: Suspended particulate organic matter.

Site	Microphytobenthos						SPOM						SOM						SOM					
	0 - 1 cm			1 - 5 cm			0 - 1 cm			1 - 5 cm			0 - 1 cm			1 - 5 cm			0 - 1 cm			1 - 5 cm		
	$\delta^{13}\text{C}$	$\delta^{15}\text{N}$	p	$\delta^{13}\text{C}$	$\delta^{15}\text{N}$	p	$\delta^{13}\text{C}$	$\delta^{15}\text{N}$	p	$\delta^{13}\text{C}$	$\delta^{15}\text{N}$	p	$\delta^{13}\text{C}$	$\delta^{15}\text{N}$	p	$\delta^{13}\text{C}$	$\delta^{15}\text{N}$	p	$\delta^{13}\text{C}$	$\delta^{15}\text{N}$	p	$\delta^{13}\text{C}$	$\delta^{15}\text{N}$	p
Seagrass MO	-14.3 ± 0.5	-13.4 ± 0.5	0.1	3.7 ± 0.2	7.2 ± 0.4	0.1	-22.5 ± 1.3	-22.5 ± 1.4	0.9	4.9 ± 1.5	5.8 ± 1.5	0.4	-19.6 ± 0.3	-18.6 ± 0.2	0.1	5.5 ± 0.1	6.1 ± <0.1	0.1	-19.5 ± 0.3	-18.9 ± 0.1	0.1	4.9 ± 0.3	5.7 ± <0.1	0.1
Mudflat MO	-13.8 ± 1.2	-13.4 ± 1.0	0.7	6.6 ± 0.2	9.1 ± 0.1	0.1	-26.6 ± 0.8	-27.2 ± 1.1	0.7	4.8 ± 0.1	3.5 ± 0.6	0.2	-22.2 ± 0.1	-21.9 ± 0.1	0.1	6.4 ± 0.1	6.6 ± 0.1	0.1	-22.5 ± 0.1	-22.5 ± 0.1	1	6.4 ± 0.2	6.6 ± <0.1	0.2
Sandflat SR	-7.2 ± 0.5	-11.6 ± 2.0	0.1	5.7 ± 0.3	13.8 ± 1.0	0.1	-27.6 ± 1.7	-25.9 ± 0.8	0.2	7.5 ± 0.4	7.0 ± 0.2	0.2	-17.7 ± 0.5	-18.0 ± 0.6	0.7	10.7 ± 0.3	10.8 ± 0.3	0.7	-17.7 ± 0.4	-17.8 ± 0.3	1	10.9 ± 0.2	10.7 ± 0.2	0.2
Mudflat SR	-17.3 ± 1.3	-15.0 ± 0.8	0.1	8.4 ± 2.7	6.5 ± 0.7	0.4	-25.8 ± 0.7	-23.3 ± 3.0	0.2	7.4 ± 0.4	6.9 ± 0.1	0.1	-21.6 ± 0.3	-21.3 ± <0.1	0.1	8.8 ± 0.3	8.4 ± 0.1	0.2	-21.9 ± 0.1	-21.5 ± 0.1	0.1	9.0 ± 0.1	8.8 ± 0.1	0.1
Seagrass SR	-16.2 ± 2.2	-12.6 ± 4.6	0.4	6.2 ± 0.2	12.3 ± 3.2	0.1	-25.8 ± 0.7	-23.3 ± 3.0	0.2	7.4 ± 0.4	6.9 ± 0.1	0.1	-20.4 ± 0.2	-20.5 ± 0.1	0.1	7.4 ± 0.6	7.6 ± 0.1	1	-20.7 ± 0.1	-20.8 ± 0.1	0.7	7.8 ± 0.2	8.2 ± 0.2	0.1

Site	<i>Z. noltii</i> leaves						<i>Z. noltii</i> roots						Detritus						Detritus					
	0 - 1 cm			1 - 5 cm			0 - 1 cm			1 - 5 cm			0 - 1 cm			1 - 5 cm			0 - 1 cm			1 - 5 cm		
	$\delta^{13}\text{C}$	$\delta^{15}\text{N}$	p	$\delta^{13}\text{C}$	$\delta^{15}\text{N}$	p	$\delta^{13}\text{C}$	$\delta^{15}\text{N}$	p	$\delta^{13}\text{C}$	$\delta^{15}\text{N}$	p	$\delta^{13}\text{C}$	$\delta^{15}\text{N}$	p	$\delta^{13}\text{C}$	$\delta^{15}\text{N}$	p	$\delta^{13}\text{C}$	$\delta^{15}\text{N}$	p	$\delta^{13}\text{C}$	$\delta^{15}\text{N}$	p
Seagrass MO	-11.6 ± 0.3	-10.4 ± 0.4	0.1	7.3 ± 0.3	7.2 ± 0.3	0.7	-11.6 ± 0.3	-10.6 ± 0.4	0.1	6.9 ± 0.3	6.7 ± 0.1	0.4	-12.9 ± 0.9	-11.5 ± 0.3	0.1	7.4 ± 0.3	6.4 ± 0.3	0.1	-12.3 ± 0.1	-10.7 ± 0.6	0.1	6.7 ± 0.2	6.3 ± 0.1	0.1
Mudflat SR	-	-	-	-	-	-	-	-	-	-	-	-	-17.9 ± 0.8	-15.1 ± 0.3	0.1	9.9 ± 0.9	9.9 ± 0.8	1	-20.0 ± 3.4	-15.7 ± 1.7	0.1	9.0 ± 1.3	9.6 ± 1.0	0.4
Seagrass SR	-13.1 ± 0.3	-12.7 ± 0.2	0.1	8.1 ± 0.5	7.7 ± 1.2	0.7	-13.3 ± 0.3	-11.9 ± 0.2	0.1	5.9 ± 0.4	7.4 ± 1.3	0.2	-14.3 ± 0.3	-13.1 ± 0.4	0.1	8.3 ± 0.3	8.3 ± 0.6	1	-16.2 ± 0.9	-15.2 ± 1.5	0.7	8.0 ± 0.4	8.3 ± 0.5	0.7

Site	Nematodes						Nematodes						Benthic copepods											
	0 - 1 cm			4 - 5 cm			0 - 1 cm			4 - 5 cm			0 - 1 cm			4 - 5 cm								
	$\delta^{13}\text{C}$	$\delta^{15}\text{N}$	p	$\delta^{13}\text{C}$	$\delta^{15}\text{N}$	p	$\delta^{13}\text{C}$	$\delta^{15}\text{N}$	p	$\delta^{13}\text{C}$	$\delta^{15}\text{N}$	p	$\delta^{13}\text{C}$	$\delta^{15}\text{N}$	p	$\delta^{13}\text{C}$	$\delta^{15}\text{N}$	p						
	spring	autumn	p	spring	autumn	p	spring	autumn	p	spring	autumn	p	spring	autumn	p	spring	autumn	p	spring	autumn	p	spring	autumn	p

Seagrass MO	-14.5 ± 1.1	-14.7 ± 0.3	0.7	10.1 ± 0.6	11.3 ± 1.5	0.4	-17.2 ± 0.7	-	-	7.4 ± 0.5	-	-	-13.7 ± 0.2	-13.5 ± 2.9	0.7	8.3 ± 0.2	9.3 ± 1.7	0.1
Mudflat MO	-16.9 ± 1.4	-14.7 ± 2.4	0.4	8.7 ± 1.2	12.5 ± 3.5	0.2	-20.0 ± 2.6	-20.4 ± 5.2	1	9.1 ± 1.5	9.7 ± 0.2	0.7	-14.6 ± 0.5	-15.4 ± 0.1	0.1	9.0 ± 0.9	11.2 ± 1.8	0.1
Sandflat SR	-12.6 ± 0.2	-12.2 ± 0.1	0.2	15.3 ± 0.6	15.0 ± 0.8	0.4	-16.2 ± 0.4	-15.5 ± 0.2	0.1	15.2 ± 0.7	15.1 ± 0.1	0.8	-14.2 ± 0.7	-12.7 ± 0.2	0.1	13.4 ± 1.1	15.4 ± 0.3	0.1
Mudflat SR	-15.7 ± 0.4	-15.4 ± 0.7	0.6	14.2 ± 0.5	14.4 ± 1.7	0.9	-17.1 ± 0.7	-16.9 ± 0.4	1	15.6 ± 0.3	12.8 ± 0.3	0.1	-18.2 ± 1.5	-16.2 ± 0.9	0.1	11.0 ± 1.0	11.7 ± 0.8	0.1
Seagrass SR	-17.9 ± 0.3	-17.7 ± 0.4	0.7	11.8 ± 0.5	11.2 ± 0.4	0.2	-19.0 ± 0.5	-18.3 ± 0.5	0.3	9.5 ± 0.6	10.3 ± 0.9	0.4	-18.3 ± 4.5	-16.6 ± 0.6	0.1	11.8 ± 1.4	12.2 ± 0.7	1

Appendix 4.2. Isotope compositions (‰, mean ± standard deviation, $n = 6$) of sediment organic matter (SOM), detritus and nematodes per sediment layer. Comparisons of $\delta^{13}\text{C}$ and $\delta^{15}\text{N}$ values between surface (0 - 1 cm) and sub-surface (1 - 5 cm) layers for SOM and detritus and surface (0 - 1 cm) and deep (4 - 5 cm) layers for nematodes (Kruskal-Wallis tests, p -values) in the mudflats, seagrass beds and sandflat in the Marennes-Oléron Bay (MO) and Sylt-Rømø Bight (SR). Significant differences ($p < 0.050$) are indicated in bold.

Site	Detritus						SOM						Nematodes					
	$\delta^{13}\text{C}$		p	$\delta^{15}\text{N}$		p	$\delta^{13}\text{C}$		p	$\delta^{15}\text{N}$		p	$\delta^{13}\text{C}$		p	$\delta^{15}\text{N}$		p
0 - 1 cm	1 - 5 cm	0 - 1 cm		1 - 5 cm	0 - 1 cm		1 - 5 cm	0 - 1 cm		1 - 5 cm	0 - 1 cm		4 - 5 cm	0 - 1 cm		4 - 5 cm		
Seagrass MO	-12.2 ± 1.0	-11.5 ± 1.0	0.22	6.9 ± 0.6	6.5 ± 0.3	0.063	-19.1 ± 0.6	-19.2 ± 0.4	0.44	5.8 ± 0.4	5.3 ± 0.5	0.031	-14.6 ± 0.7	-16.9 ± 0.6	0.004	10.7 ± 1.2	7.6 ± 0.7	0.011
Mudflat MO	-	-	-	-	-	-	-22.1 ± 0.2	-22.5 ± 0.1	0.18	6.5 ± 0.1	6.5 ± 0.2	0.31	-16.3 ± 1.2	-21.2 ± 3.1	0.011	9.5 ± 1.4	9.3 ± 1.1	0.65
Sandflat SR	-	-	-	-	-	-	-17.8 ± 0.5	-17.8 ± 0.3	1.0	10.8 ± 0.3	10.8 ± 0.2	0.84	-12.4 ± 0.3	-16.0 ± 0.5	0.003	15.2 ± 0.6	15.3 ± 0.7	0.74
Mudflat SR	-16.5 ± 1.6	-17.9 ± 3.4	0.84	9.9 ± 0.8	9.3 ± 1.1	0.094	-21.4 ± 0.2	-21.7 ± 0.3	0.031	8.6 ± 0.3	8.9 ± 0.2	0.031	-15.6 ± 0.5	-17.0 ± 0.5	0.003	14.3 ± 1.0	14.2 ± 1.6	0.89
Seagrass SR	-13.7 ± 0.8	-15.7 ± 1.2	0.13	8.3 ± 0.4	8.1 ± 0.4	0.44	-20.4 ± 0.2	-20.8 ± 0.1	0.031	7.5 ± 0.4	8.0 ± 0.3	0.031	-17.8 ± 0.3	-18.7 ± 0.6	0.020	11.5 ± 0.5	9.9 ± 0.8	0.006

Appendix 4.3. $\delta^{13}\text{C}$ values of food sources (annual mean, ‰, $n = 6$) in the mudflats, seagrass beds and sandflat in the Marennes-Oléron Bay (MO) and Sylt-Rømø Bight (SR). Comparisons between food sources (Kruskal-Wallis tests, p-values, post-hoc comparisons via Bonferroni's method). Significant differences ($p < 0.050$) are indicated in bold. SPOM: suspended particulate organic matter, SOM: sediment organic matter.

		Mudflat MO			Mudflat SR			Sandflat SR			Seagrass MO			Seagrass SR		
		$\delta^{13}\text{C}$		p	$\delta^{13}\text{C}$		p	$\delta^{13}\text{C}$		p	$\delta^{13}\text{C}$		p	$\delta^{13}\text{C}$		p
SPOM	vs SOM (0 - 1 cm)	-26.9	< -22.1	0.02	-24.6	-21.4	1.0	-26.7	-17.8	0.18	-22.5	-19.1	1.0	-24.6	-20.4	1.0
SPOM	vs SOM (1 - 5 cm)	-26.9	-22.5	0.85	-24.6	-21.7	1.0	-26.7	-17.8	0.15	-22.5	-19.2	1.0	-24.6	-20.8	1.0
SPOM	vs Microphytobenthos	-26.9	< -13.6	< 0.001	-24.6	< -16.0	< 0.001	-26.7	< -9.4	< 0.001	-22.5	-13.8	0.16	-24.6	< -14.4	0.009
SPOM	vs Detritus	-	-	-	-24.6	< -17.2	< 0.001	-	-	-	-22.5	< -11.9	< 0.001	-24.6	< -14.7	0.004
SPOM	vs Seagrass	-	-	-	-	-	-	-	-	-	-22.5	< -12.4	< 0.001	-24.6	< -11.7	< 0.001
SOM (0 - 1 cm)	vs SOM (1 - 5 cm)	-22.1	-22.5	0.85	-21.4	-21.7	1.0	-17.8	-17.8	1.0	-19.1	-19.2	1.0	-20.4	-20.8	1.0
SOM (0 - 1 cm)	vs Microphytobenthos	-22.1	-13.6	0.85	-21.4	-16.0	0.22	-17.8	-9.4	0.15	-19.1	-13.8	1.0	-20.4	-14.4	0.79
SOM (0 - 1 cm)	vs Detritus	-	-	-	-21.4	-17.2	0.52	-	-	-	-19.1	-11.9	0.11	-20.4	-14.7	0.74
SOM (0 - 1 cm)	vs Seagrass	-	-	-	-	-	-	-	-	-	-19.1	< -12.4	0.005	-20.4	< -11.7	0.012
SOM (1 - 5 cm)	vs Microphytobenthos	-22.5	< -13.6	0.02	-21.7	< -16.0	0.027	-17.8	-9.4	0.18	-19.2	-13.8	1.0	-20.8	-14.4	0.11
SOM (1 - 5 cm)	vs Detritus	-	-	-	-21.7	-17.2	0.061	-	-	-	-19.2	-11.9	0.071	-20.8	-14.7	0.072
SOM (1 - 5 cm)	vs Seagrass	-	-	-	-	-	-	-	-	-	-19.2	< -12.4	0.003	-20.8	< -11.7	< 0.001
Microphytobenthos	vs Detritus	-	-	-	-16.0	-17.2	1.0	-	-	-	-13.8	-11.9	1.0	-14.4	-14.7	1.0
Microphytobenthos	vs Seagrass	-	-	-	-	-	-	-	-	-	-13.8	-12.4	0.25	-14.4	-11.7	1.0
Detritus	vs Seagrass	-	-	-	-	-	-	-	-	-	-11.9	-12.4	1.0	-14.7	-11.7	1.0

Appendix 4.4. Mean $\delta^{13}\text{C}$ values of food sources ($n = 6$) in the mudflats, seagrass beds and sandflat in the Marennes-Oléron Bay (MO) and Sylt-Rømø Bight (SR). Comparison (Kruskal-Wallis, p-value, post-hoc comparisons via Bonferroni's method) between habitats. Significant differences ($p < 0.050$) are indicated in bold. SPOM: suspended particulate organic matter, SOM: sediment organic matter.

		Microphytobenthos			SOM (0 - 1 cm)			SOM (1 - 5 cm)			SPOM			
		$\delta^{13}\text{C}$		p	$\delta^{13}\text{C}$		p	$\delta^{13}\text{C}$		p	$\delta^{13}\text{C}$		p	
Mudflat MO	vs	Mudflat SR	-13.6	-16.0	0.37	-22.1	-21.4	1.0	-22.5	-21.7	1.0	-26.9	-24.6	0.25
Mudflat MO	vs	Seagrass MO	-13.6	-13.8	1.0	-22.1	< -19.1	0.005	-22.5	< -19.2	0.004	-26.9	< -22.5	0.001
Mudflat MO	vs	Seagrass SR	13.6	-14.4	1.0	-22.1	-20.4	0.22	-22.5	-20.8	0.18	-26.9	-24.6	0.25
Mudflat MO	vs	Sandflat SR	-13.6	-9.4	0.75	-22.1	< -17.8	< 0.001	-22.5	< -17.8	< 0.001	-26.9	-26.7	1.0
Mudflat SR	vs	Seagrass MO	-16.0	-13.8	0.55	-21.4	-19.1	0.14	-21.7	-19.2	0.18	-24.6	-22.5	0.78
Mudflat SR	vs	Seagrass SR	-16.0	-14.4	1.0	-21.4	-20.4	1.0	-21.7	-20.8	1.0	-24.6	-24.6	1.0
Mudflat SR	vs	Sandflat SR	-16.0	< -9.4	< 0.001	-21.4	< -17.8	0.004	-21.7	< -17.8	0.004	-24.6	-26.7	0.57
Seagrass MO	vs	Seagrass SR	-13.8	-14.4	1.0	-19.1	-20.4	1.0	-19.2	-20.8	1.0	-22.5	-24.6	0.78
Seagrass MO	vs	Sandflat SR	-13.8	-9.4	0.53	-19.1	-17.8	1.0	-19.2	-17.8	1.0	-22.5	> -26.7	0.005
Seagrass SR	vs	Sandflat SR	-14.4	-9.4	0.07	-20.4	-17.8	0.20	-20.8	-17.8	0.18	-24.6	-26.7	0.57

Appendix 4.5. Fatty acid (FA) compositions (% of total FAs, mean, $n = 3$) of primary producers and composite sources in the mudflats, seagrass beds and sandflat in the Marennes-Oléron Bay (MO) and Sylt-Rømø Bight (SR) in spring and autumn. Values of the five most abundant FAs are in **bold**. FAs are classified according to their trophic marker groups: diatoms, bacteria, flagellates, vascular plants, and ubiquitous (see Table 4.1). Animal FA markers are consisting of 20:0, 20:1($n-7$), 20:1($n-9$), 20:1($n-11$), 20:1, 22:1($n-7$), 22:1($n-9$), 22:1($n-11$), 22:2($n-6$), 22:2($n-9$). SOM = Sediment organic matter, SPOM = Suspended particulate organic matter.

Station	Sediment layer	Season	Diatoms					Bacteria					Flagellates		Vascular plants			Ubiquitous		Others	Animal		
			14:0	16:1($n-7$)	16:2($n-4$)	16:3($n-4$)	16:4($n-1$)	20:5($n-3$)	i-15:0	a-15:0	15:0	17:0	17:1	18:1($n-7$)	18:4($n-3$)	22:6($n-3$)	18:2($n-6$)	18:3($n-3$)	24:0			16:0	18:0
Microphytobenthos	Seagrass MO	Spring	4.5	11.0	3.2	3.0	3.0	22.4	0.9	1.5		0.7	8.6	2.7	1.1				31.9	1.5	0.8	2.9	0.6
		Autumn	5.7	18.6	3.6	3.0	5.7	22.0	0.8	2.2			0.4	3.0	2.3	0.5	3.3		25.3	0.8	0.5	1.9	0.4
	Mudflat MO	Spring	6.9	10.4	4.1	5.1	6.5	26.0	0.5	9.6		1.7	0.5	1.9	4.8	0.6	0.8	0.4	14.7	0.6	0.9	1.8	2.3
		Autumn	5.0	10.2	5.0	6.1	8.7	34.1	0.8	1.8	0.1	0.8	0.4	2.3	4.7	0.4	0.3	0.1	14.5	0.6	0.3	1.7	2.0
	Sandflat SR	Spring	8.1	6.2	5.1	3.1	10.1	23.4	0.5	15.1	0.4	2.8	0.1	2.4	5.1	0.5	0.2	0.3	9.5	0.3	0.5	2.2	4.1
		Autumn	8.4	12.3	5.4	7.4	6.5	32.4	1.7	0.4		0.8	1.0	3.7	5.6	0.4	0.3	0.4	9.5	0.7	0.4	2.0	0.5
	Mudflat SR	Spring	9.4	9.7	6.7	11.2	6.8	25.3	0.8	5.7	0.2		0.4	1.8	4.4	0.6	0.4		10.4	0.3	1.6	1.8	2.4
		Autumn	5.6	7.5	8.5	10.2	10.9	25.4	0.9	3.7		1.8	0.8	2.1	6.0	0.4	0.2		9.9	0.6	0.9	1.7	2.7
	Seagrass SR	Spring	8.4	11.6	5.4	8.8	6.2	21.5	1.0	7.0	0.4	2.5	1.2	2.5	4.8	0.5	0.3	0.3	12.1	1.3	0.8	1.7	1.8
		Autumn	8.2	10.3	5.0	8.9	9.0	33.1					0.7	2.0	3.7	6.0	0.4	0.4	0.6	8.1	1.3	0.4	1.5
	Detritus	Seagrass MO	0 - 1 cm	Spring	2.0				3.6	0.6	0.7			2.9		21.2	17.4	7.8	30.5	4.8	4.4	3.8	0.3
			Autumn	1.4	5.2	0.4	0.3		2.3	1.9	0.9			3.8		23.0	10.7	9.8	27.6	4.4	6.5	1.1	0.7
1 - 5 cm		Spring	1.4	2.5				0.6	2.7	0.9			2.8		22.0	8.0	24.0	23.2	4.6	5.6	0.7	1.0	
		Autumn	0.8	1.8				0.3	1.2	0.7			2.4		31.6	11.6	10.1	26.5	4.1	7.3	0.3	1.3	
Seagrass SR		0 - 1 cm	Spring	2.8	4.5		0.5		2.3	4.1	1.1			3.3		13.0	13.6	12.3	27.8	4.9	4.0	4.0	1.9
		Autumn	1.7	6.9	0.5	0.7		6.3	2.5	0.9			5.3		12.2	14.7	5.8	27.1	5.0	5.3	3.6	1.4	
1 - 5 cm		Spring	1.8	3.2				13.1	2.7	0.9			3.3		9.1		28.1	21.5	4.3		9.8	2.2	
		Autumn	1.6	4.7				1.1	3.1	1.0			4.6		19.3	13.1	6.5	30.8	5.0	5.3	2.0	1.9	
Mudflat SR		0 - 1 cm	Spring	4.7	8.5	0.8	0.7		4.4	3.9	1.8		8.0	0.8		5.9	6.2	9.4	26.5	6.4	5.1	0.6	6.4
		Autumn	8.7	3.6	0.4			2.3	3.8	0.6			4.7	0.8		24.5	9.0	0.9	24.6	1.8	8.6	5.0	0.7
1 - 5 cm		Spring	4.3	4.7				5.0	6.4	1.3			10.2			5.6	9.4	8.7	21.7	6.5	3.6	5.5	6.9
		Autumn	7.5	4.5	0.3			0.3	4.4	0.9			9.5	0.8		19.5	8.4	1.3	22.1	3.4	8.0	5.0	4.2
Leaves	Seagrass MO	Spring	1.4	1.0				0.5	2.1	0.3			1.7	0.4		17.5	30.3	3.7	32.1	3.9	2.2	3.0	
		Autumn	0.5						1.8	0.2			1.0			17.7	38.8	3.1	30.2	3.0	1.3	2.4	

Roots	Seagrass SR	Spring	1.1					1.9	0.2		1.4	0.8	19.1	31.5	2.9	32.8	3.5	2.1	2.7				
		Autumn	0.9		0.1			3.9	0.5	2.0	3.2			9.5	36.8		30.9	4.8	1.5	5.9			
	Seagrass MO	Spring	0.7					0.9	0.5	0.6	0.5	1.6		37.3	17.5		27.4	3.7	5.6	2.2	1.3		
		Autumn	0.4					0.5	0.4	0.4		2.0		43.5	14.0		26.7	3.5	6.8	1.7			
	Seagrass SR	Spring	0.7					0.9	0.5			2.3		36.6	16.9		29.8	3.4	6.0	0.9	1.9		
		Autumn	1.6	0.6				1.4	0.9	0.7		3.6		32.9	12.4		30.1	4.1	5.9	5.9			
Mudflat SR	Spring	9.4	9.7	5.4	7.4	6.5	32.4	1.7	0.4		0.8	1.0	3.7	5.6	0.4	0.3	0.4	9.5	0.7	0.4	2.0	0.5	
	Autumn	5.6	7.5	8.5	10.2	10.9	25.4	0.9	3.7		1.8	0.8	2.1	6.0	0.4	0.2		9.9	0.6	0.9	1.7	2.7	
Seagrass SR	Spring	8.4	11.6	5.4	8.8	6.2	21.5	1.0	7.0	0.4	2.5	1.2	2.5	4.8	0.5	0.3	0.3	12.1	1.3	0.8	1.7	1.8	
	Autumn	8.2	10.3	5.0	8.9	9.0	33.1				0.7	2.0	3.7	6.0	0.4	0.4	0.6	8.1	1.3	0.4	1.5	0.4	
SOM	Seagrass MO 0 - 1 cm	Spring	5.3	33.8	2.4	4.1	0.7	9.7	2.2	3.2			1.2	2.3	0.8	1.8	26.6	2.2		3.4	0.2		
		Autumn	5.2	23.9	2.1	5.0	0.5	5.2	3.6	3.2		5.8	0.8	1.5	0.6	6.3	25.3	3.9	2.9	3.8	0.3		
	1 - 5 cm	Spring	4.0	13.6	0.7	1.5		1.5	3.7	2.2			3.4		2.8	0.8	12.7	31.4	16.3	2.5	2.5	0.4	
		Autumn	2.4	9.2	0.4	1.0		4.2	3.3	1.8	0.4	4.4		3.2	0.7	13.6	30.0	18.1	3.9	3.0	0.4		
	Mudflat MO 0 - 1 cm	Spring	5.6	15.5	1.6	14.3	1.5	5.6	2.8	20.0			3.9	0.9	0.4		1.7	18.4	1.8	1.5	3.2	1.2	
		Autumn	5.2	12.6	1.9	11.5	3.9	8.6	3.1	10.4			4.2	1.3	1.2	0.4		3.1	19.0	3.1	2.0	3.9	4.7
	1 - 5 cm	Spring	7.6	11.2	1.0	6.5	0.9	1.4	5.7	12.2	0.8		6.1	0.6	0.5	0.6	6.9	24.4	5.8	2.7	5.1		
		Autumn	6.5	10.6	1.4	3.0	1.1	1.1	5.8	6.4		2.5	6.7	0.6	0.6	0.6		25.9	7.7	3.2	5.7	10.0	
	Sandflat SR 0 - 1 cm	Spring	7.8	43.0	1.2	3.7		6.5	0.7	2.9			2.9	0.5	0.6	0.5	0.2	0.3	24.5		2.7	1.8	0.3
		Autumn	6.0	44.1	2.2	3.6	0.6		1.1	1.3			4.2	0.8	0.4	0.5	0.2		20.0	1.2	3.3	1.8	
	1 - 5 cm	Spring	8.3	41.1	1.4	4.6		4.3	1.2	3.4	0.9	0.5	3.9	0.5	0.4		0.3	23.1	1.4	2.7	2.1		
		Autumn	6.4	40.9	1.4	4.2		4.8	1.5	2.8	0.9		4.7	0.5	0.4		0.5	24.0	1.7	3.3	2.0		
Mudflat SR 0 - 1 cm	Spring	5.6	24.0	1.3	2.3	1.4	5.6	2.0	8.2	1.4	12.9	3.7	0.5	0.9	0.3	2.0	20.1	2.1	1.8	3.3	0.5		
	Autumn	4.8	21.2	1.7	7.7	2.0	5.1	3.0	5.0	1.4	1.3	8.0	0.7	0.9	0.6	5.4	18.2	2.8	2.6	4.5	3.0		
1 - 5 cm	Spring	5.4	20.1	1.3	13.4	1.6	1.6	3.4	8.0	1.9	1.1	4.6	0.5	1.3		5.8	20.1	3.4	1.9	4.0	0.5		
	Autumn	5.4	18.6	1.5	15.1	1.9	1.4	3.7	8.8	1.9	1.4	5.6	0.5	0.7	0.4	5.7	20.4		2.2	3.9	0.7		
Seagrass SR 0 - 1 cm	Spring	3.8	27.5	1.0	20.2	1.3	2.9	1.1	10.8	1.2	0.7	2.0	0.4	0.9	0.2	1.1	18.9	1.2	1.4	2.9	0.5		
	Autumn	3.7	26.5	1.4	18.4	2.0	5.5	1.4	8.5	1.1	0.8	3.1	0.6	0.7		1.6	17.0	1.2	1.5	3.0	2.0		
1 - 5 cm	Spring	3.2	20.6	0.8	23.6	1.5	0.7	1.5	12.8	1.9	0.8	1.9		0.7		3.4	17.6	1.7	1.5	3.0	2.9		
	Autumn	3.7	22.0	0.8	22.0	1.3	1.9	1.5	13.7	2.0	0.9	2.1	0.3	0.6		2.2	18.4	1.5	1.5	3.0	0.6		
SPOM	Seagrass MO	Spring	12.8	10.9	2.8	0.6	1.3	6.4	1.1	1.2	0.5	0.6	4.8	2.5	4.2	1.8	1.4	24.6	12.4	4.5	2.4	3.0	
		Autumn	7.5	9.3	6.2	1.5	0.5	3.9	1.6	2.8	1.1	0.6	6.2	2.5	1.7	1.9	1.0	27.6	10.4	6.6	5.2	2.0	
	Mudflat MO	Spring	12.6	9.5	2.4	0.6	1.0	3.8	1.2	1.4	0.6	0.7	5.0	3.5	2.2	1.7	2.3	32.3	8.2	5.1	3.2	2.9	
		Autumn	8.2	13.5	5.3	2.4	1.1	4.3	2.0	2.8	1.1	1.1	6.4	1.7	0.6	0.8	0.6	24.7	7.9	5.7	7.9	1.9	
Sylt-Rømø	Spring	24.4	12.9	2.5	1.3	3.7	6.3	0.9	1.0	0.6	0.7	1.5	2.1	8.1	0.8	1.1	0.3	18.8	7.0	1.9	3.4	0.6	
	Autumn	10.9	11.6	4.9	2.2	3.7	10.4	1.3	1.9	0.6	0.8	3.5	3.5	3.4	1.1	1.2	20.3	6.1	5.9	4.4	2.2		

Appendix 4.6. Proportional contributions (median value with lower and upper limits of 90% confidence interval in parentheses, %) of bacteria, suspended particulate organic matter (SPOM), sediment organic matter (SOM) and microphytobenthos as food sources for benthic copepods and nematodes in the mudflats, seagrass beds and sandflat in the Marennes-Oléron Bay (MO) and Sylt-Rømø Bight (SR). Data for surface (0 - 1 cm) and deep (4 - 5 cm) layers are displayed for nematodes.

		Bulk nematodes (0 - 1 cm)	Bulk nematodes (4 - 5 cm)	Benthic copepods
Mudflat MO	Bacteria	3.0 (0.2 – 14.4)	6.2 (0.2 – 32.5)	4.1 (0.4 – 13.5)
	SPOM	5.8 (0.3 – 23.4)	13.3 (0.4 – 51.5)	7.5 (0.7 – 21.9)
	SOM	11.4 (0.6 – 40.3)	25.2 (1.0 – 79.3)	13.7 (1.4 – 36.5)
	Microphytobenthos	74.0 (52.2 – 88.9)	40.0 (13.3 – 63.3)	71.3 (53.1 – 84.5)
Mudflat SR	Bacteria	0.5 (0.0 – 3.3)	1.2 (0.1 – 7.0)	2.1 (0.1 – 8.0)
	SPOM	1.2 (0.1 – 7.2)	2.6 (0.1 – 16.3)	4.7 (0.3 – 17.6)
	SOM	2.3 (0.1 – 14.2)	5.9 (0.2 – 32.8)	8.4 (0.7 – 27.9)
	Microphytobenthos	3.8 (0.1 – 80.7)	4.7 (0.2 – 61.5)	11.7 (0.7 – 56.6)
	Detritus	88.8 (8.5 – 97.7)	77.6 (15.4 – 94.8)	67.3 (20.6 – 87.0)
Seagrass MO	Bacteria	3.2 (0.2 – 14.6)	5.0 (0.2 – 24.4)	3.6 (0.4 – 11.1)
	SPOM	8.5 (0.3 – 27.3)	9.3 (0.3 – 37.1)	7.0 (0.7 – 17.6)
	SOM	9.4 (0.5 – 45.8)	17.5 (0.7 – 75.8)	11.8 (1.0 – 35)
	Microphytobenthos	7.5 (0.5 – 42.3)	14.9 (0.7 – 57.1)	14.6 (1.1 – 51.5)
	Detritus	59.8 (26.1 – 78.6)	30.7 (6.4 – 62.6)	57.1 (25.4 – 76.2)
Seagrass SR	Bacteria	4.0 (0.2 – 17.9)	5.8 (0.2 – 25)	5.3 (0.5 – 15.2)
	SPOM	9.8 (0.4 – 38.9)	10.8 (0.4 – 50.7)	10.9 (0.9 – 30.3)
	SOM	21.1 (1.0 – 61.4)	30.3 (1.2 – 86.3)	19.3 (2.1 – 47.2)
	Microphytobenthos	42.7 (22.0 – 67.7)	12.5 (3.1 – 33.8)	46.6 (29.8 – 65.9)
	Detritus	8.9 (0.9 – 31.6)	23.8 (1.2 – 52.8)	11.7 (2.2 – 26.1)
Sandflat SR	Bacteria	2.6 (0.1 – 11.5)	5.0 (0.2 – 21.2)	4.8 (0.3 – 15.0)
	SPOM	4.2 (0.2 – 17.7)	7.5 (0.2 – 31.6)	7.7 (0.5 – 22.8)
	SOM	15.2 (1.1 – 46.2)	25.4 (1.4 – 77.7)	23.8 (2.6 – 54.4)
	Microphytobenthos	72.9 (49.8 – 89.0)	53.9 (18.9 – 74.5)	60.1 (39.3 – 77.6)

Appendix 4.7. Fatty acid (FA) compositions (% of total FAs, mean, $n = 3$) of nematodes and benthic copepods in the mudflats, seagrass beds and sandflat in the Marennes-Oléron Bay (MO) and Sylt-Rømø Bight (SR) in spring and autumn. Values of the five most abundant FAs are in **bold**. FAs are classified according to their trophic marker groups: diatoms, bacteria, flagellates, vascular plants, and ubiquitous (see Table 4.1). Animal FAs are consisting of 20:0, 20:1($n-7$), 20:1($n-9$), 20:1($n-11$), 20:1, 22:1($n-7$), 22:1($n-9$), 22:1($n-11$), 22:2($n-6$), 22:2($n-9$).

Station	Sediment layer	Season	Diatoms			Bacteria					Flagellates			Vascular plants		Ubiquitous				Others	Animal				
			14:0	16:1($n-7$)	20:5($n-3$)	15:0	i-17:0	a-17:0	17:0	17:1($n-9$)	18:1($n-7$)	19:0	19:1($n-9$)	18:4($n-3$)	22:5($n-3$)	22:6($n-3$)	18:2($n-6$)	18:3($n-3$)	24:0			16:0	18:0	18:1($n-9$)	20:4($n-6$)
Nematodes	Seagrass MO	0 - 1 cm	Spring	1.5	6.9	14.4	1.2			1.7	15.7			4.6	11.2	2.5	1.2		13.4	14.5	4.3		1.7	5.2	
		Autumn																							
		4 - 5 cm	Spring	2.1	9.5	11.1				3.5	16.9				4.1	5.8	3.1		12.1	15.5	7.0	6.0		3.2	
			Autumn	1.4	5.6	9.9	1.4	1.2	0.9	1.7	3.5	12.6	0.8	1.1		3.0	3.1	4.1	1.6	9.7	11.6	6.1	6.0	6.4	8.2
	Mudflat MO	0 - 1 cm	Spring	2.2	4.5	19.7	10.9			4.4	11.3	2.8	7.0			8.8			11.9	8.3	0.7		5.6	2.0	
			Autumn	1.2	3.6	19.1	4.0			3.0	5.9	5.3	1.2	6.3	0.6	2.3	14.1	0.3		6.9	5.0	1.1	3.8	7.8	8.4
		4 - 5 cm	Spring	3.5	1.8	12.9	18.1			8.7	12.7	2.9	4.2	4.8		1.8	10.5	0.4		5.8	5.1	1.4	3.2	1.3	1.0
			Autumn	2.8	3.8	6.6	12.9	1.8	0.4	7.5	11.0	0.3	4.4			2.3	5.2	3.5		6.0	6.5	4.1	3.7	7.2	10.1
	Sandflat SR	0 - 1 cm	Spring																						
			Autumn	7.7	6.1	13.7	1.9	0.6	0.4	2.2	2.0	8.4	0.8	1.4		2.9	13.4			11.6	8.6	3.3	3.5	3.6	7.9
		4 - 5 cm	Spring	4.5	7.2	12.0	2.7	1.3	0.9	2.4	3.2	7.9	0.9	1.1		2.4	8.0	0.9		13.8	9.8	3.8	6.2	4.4	6.7
			Autumn	2.0	4.8	13.2	1.8	1.1	0.7	2.2	2.7	8.2	1.1	1.8	0.4	2.5	9.9	0.7		12.3	8.9	4.1	7.7	6.2	7.7
	Mudflat SR	0 - 1 cm	Spring																						
			Autumn	1.3	3.1	13.9	1.4	1.2	0.8	1.9	2.8	8.2	1.0	2.4	0.3	4.0	13.1	1.0	1.1	8.0	7.2	4.6	4.6	9.0	9.0
	4 - 5 cm	Spring	1.2	2.8	16.1	1.0	1.5	0.7	1.7	2.4	6.8	0.5	1.5	0.4	4.1	7.4	0.8	1.0	9.2	7.0	5.0	4.0	12.4	12.5	
		Autumn	1.8	3.8	10.9	2.1	1.5	1.0	2.2	5.0	10.9	1.0	2.7	0.7	3.2	6.3	1.8	2.0	8.3	10.4	5.4	4.6	7.6	6.9	
Seagrass SR	0 - 1 cm	Spring	1.8	7.3	15.7	2.6	1.5	1.3	2.2	7.7	11.1	0.6	2.8		2.6	7.8	2.3		10.4	9.6	5.1		3.7	4.0	
		Autumn	1.0	6.6	10.7	0.8	1.0	1.0	1.7	6.5	13.2	0.8	1.9	0.2	2.2	5.7	3.9	2.4	5.4	9.4	5.1	8.0	5.7	6.8	
	4 - 5 cm	Spring	1.1	7.8	9.5	2.0	0.9	0.6	1.9	12.2	12.3	0.8	2.3		1.6	2.8	4.0	2.5	5.5	9.7	4.2	8.2	4.8	5.5	
		Autumn	1.1	7.8	9.3	0.9	0.9	1.0	1.7	7.7	13.9	0.7	2.0	0.2	1.5	3.2	4.3	2.7	5.6	10.1	4.8	8.3	5.8	6.5	
Benthic copepods	Seagrass MO	Spring	4.5	9.8	5.9						5.0			4.6					38.5	20.2	6.6		4.9		
		Autumn	3.9	7.3	6.3	2.5	0.8		2.4	0.7	5.1	0.9		4.9	4.5	0.7			34.8	13.3	2.4	1.0	3.6	4.7	
	Mudflat MO	Spring	3.6	11.3	16.4	6.6			3.0	6.4	5.6	0.9	1.1	2.8	6.7	0.7			22.3	5.9	3.1	1.2	1.4	0.9	
		Autumn	2.4	6.6	14.1	7.7	0.6	0.3	5.3	8.1	5.8	0.6	1.6	0.5	4.0	10.1	0.5	0.8	16.0	5.8	1.0	2.5	2.5	3.2	

Chapter 4

Sandflat SR	Spring	5.5	18.4	6.8	2.4	0.5	2.0	1.2	4.6	0.4	0.4	2.6	4.2	1.1	25.7	15.7	3.8	1.8	1.6	1.2
	Autumn																			
Mudflat SR	Spring	4.6	13.4	5.2	5.0	1.4	3.4	2.8	4.9				20.8		25.6	8.4	2.3	1.3	0.8	
	Autumn																			
Seagrass SR	Spring	3.4	9.8	9.4	3.7	1.2	2.9	2.4	6.4		4.0	8.0	1.3		26.2	10.4	4.1	1.7	4.2	1.1
	Autumn	3.1	13.5	8.2	2.7	1.9	1.2	2.3	3.1	8.2	2.6	10.4	1.2	0.6	21.0	6.3	4.1	2.0	3.0	4.6

Interchapter 4A

From trophic relationship to energy flows

The aim of chapter four was to determine the trophic relationships between food sources and meiobenthic consumers in several habitats characterized by different primary producers (Fig. 4A.1: indicated in blue). The combination of bulk stable isotope compositions, fatty acid profiles and compound-specific isotope compositions of fatty acids was effective in expanding the understanding of the functioning of these complex food webs (Nyssen et al. 2005; Jaschinski et al. 2008; Leduc et al. 2009; Lebreton et al. 2011b; Braeckman et al. 2015).

Combined trophic markers highlighted the importance of microphytobenthos and benthic bacteria as food sources to nematodes and benthic copepods (Fig. 4A.1), even when variation in food sources occurred due to habitat characteristics (e.g. growth of seagrass beds, sediment grain size leading to different microalgae communities) or temporal variations (e.g. phytoplankton blooms). Both bacteria and microphytobenthos represent high contributions to SOM, which was used by meiofauna as well. Bacteria from the SOM, used as a food source by meiofauna, mainly utilized microphytobenthos as a substrate. This highlighted the importance of microphytobenthos and bacteria for meiofauna, however, their role in the food webs of these systems has to be clarified (Fig. 4A.2). Implementing information of meiofauna feeding behavior into food web models could provide better insights the importance of these two food resources.

Biomass data and information gained from trophic markers were included into pre-existing food web models describing the functioning of the five studied habitats (Leguerrier et al. 2003; Baird et al. 2007; Pacella et al. 2013; Saint-Béat et al. 2013b, 2014). Such models provide a systematic approach and will be of high interest to better assess the role of meiofauna into the functioning of the whole food webs. These models indeed take into account information related to production, egestion and respiration—in addition to the data which were gained in the two previous chapters—and therefore provide information about all the carbon flows into a food web. Such food web models will thus permit to answer our main question: what is the role of meiofauna in soft-bottom intertidal habitats?

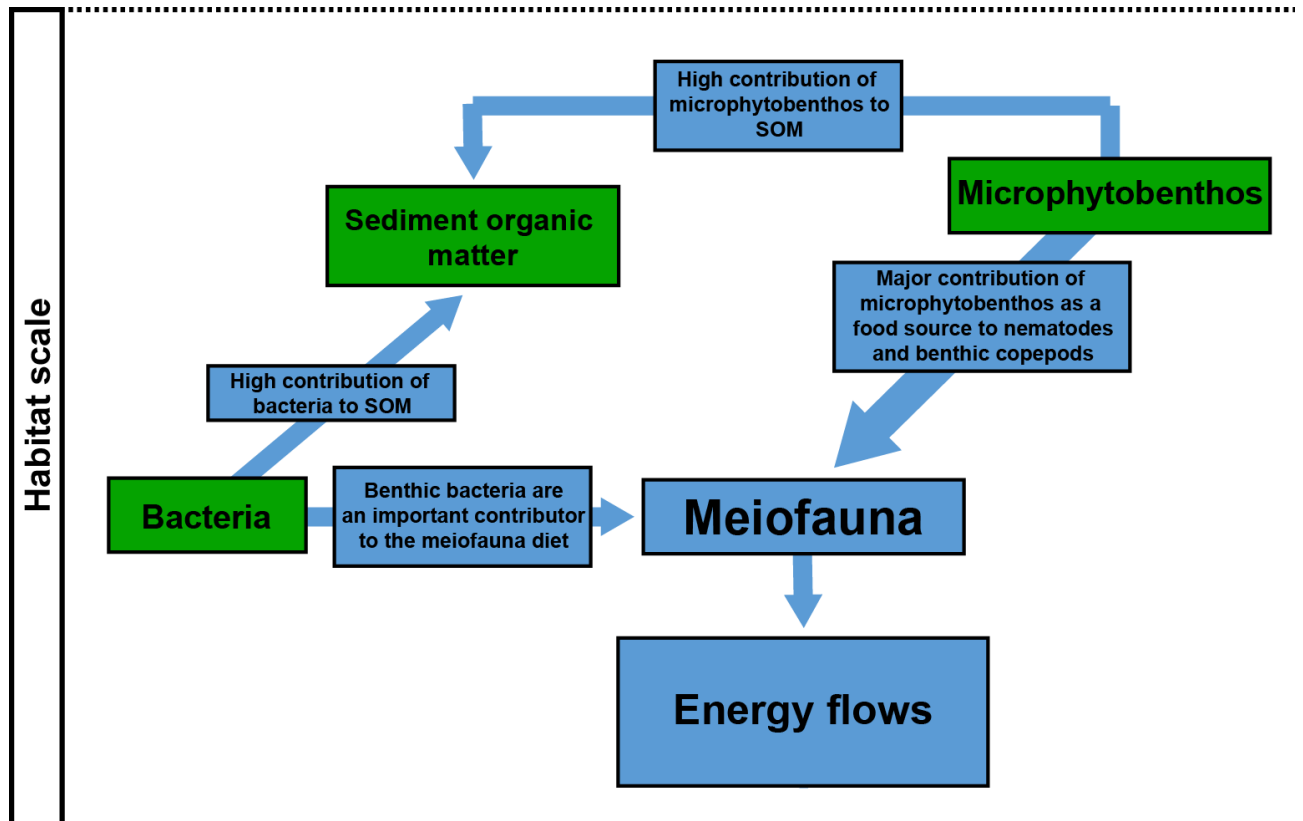

Figure 4A.1. Conceptual diagram of trophic relationships between food sources and meiofauna based on isotope composition and fatty acid profiles. SOM = sediment organic matter.

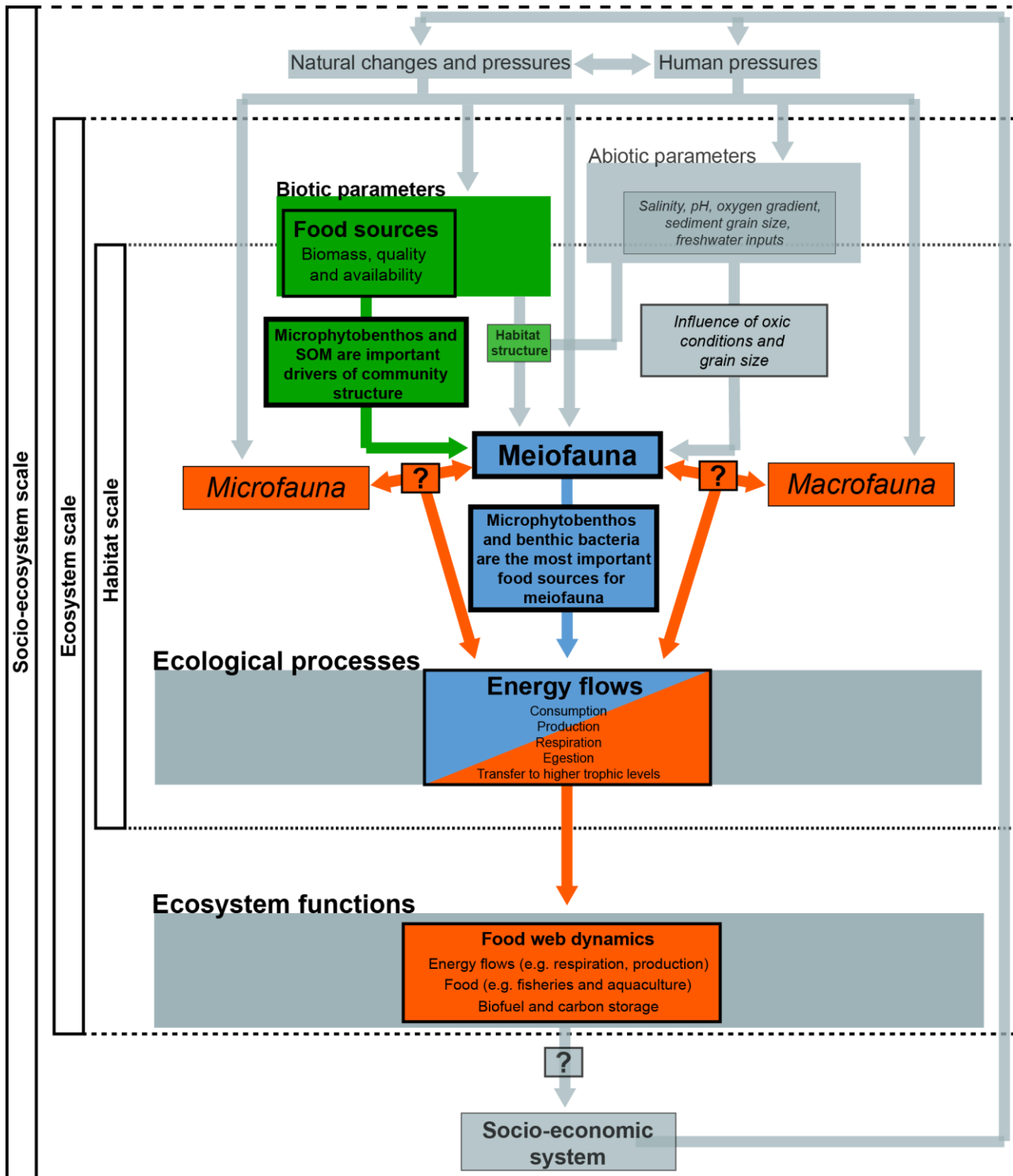

Figure 4A.2. Conceptual diagram of trophic relationships between food sources and meiofauna based on isotope composition and fatty acid profiles and the questions that arose from this trophic marker study. SOM = sediment organic matter.

CHAPTER 5

Food web model assessment

“Food is the burning question in animal society, and the whole structure and activities of the community are dependent upon questions of food supply”

Charles Elton

**Importance of microphytobenthos-meiofauna pathway
in soft-bottom intertidal food webs leads to high
production and transfer efficiency of meiofauna:**

A multi-habitat comparison using linear inverse food web
modeling.

Importance of microphytobenthos-meiofauna pathway in soft-bottom intertidal food webs leads to high production and transfer efficiency of meiofauna: A multi-habitat comparison using linear inverse food web modeling.

L.H. van der Heijden^{1,2,*}, N. Niquil³, R. Asmus², M. Haraldsson^{3,4}, B. Saint-Béat⁵, S. Pacella⁶, M. Graeve⁷, J. Rzeznik-Orignac⁸, H. Asmus², B. Lebreton¹

¹*UMR 7266 Littoral, Environnement et Sociétés (CNRS - University of La Rochelle), Institut du littoral et de l'environnement, 2 rue Olympe de Gouges, 17000 La Rochelle, France*

²*Alfred-Wegener-Institut Helmholtz-Zentrum für Polar- und Meeresforschung, Wattenmeerstation Sylt, Hafenstrasse 43, 25992 List/Sylt, Germany*

³*Centre National de la Recherche Scientifique (CNRS)/University of Caen Normandy, BOREA, Caen, France*

⁴*Sorbonne Université, Université Paris Est Créteil, Université Paris Diderot, CNRS, INRA, IRD, Institute of Ecology and Environmental sciences - Paris, IEES-Paris, 75005 Paris, France*

⁵*Québec-Océan and Takuvik, Département de Biologie, Université Laval, Québec City, QC, Canada*

⁶*College of Earth, Ocean, and Atmospheric Sciences, Oregon State University, 104 Wilkinson Hall, Corvallis, OR 97331, USA*

⁷*Alfred Wegener Institut Helmholtz Centre for Polar- and Marine Research, Bremerhaven, Germany*

⁸*Laboratoire d'Ecogéochimie des Environnements Benthiques, LECOB, Sorbonne Université, CNRS, Banyuls-sur-Mer, France*

ABSTRACT

The highly productive microphytobenthos and meiofauna compartments play an important role in the carbon fluxes of five soft-bottom intertidal habitats, as highlighted by food web models. Flows of carbon were determined using the linear inverse model-Markov chain Monte Carlo technique. New data on biomass and feeding ecology of meiofauna was integrated into existing food web models from the Marennes-Oléron Bay and the Sylt-Rømø Bight. Ecological network analyses provided insights on food web model characteristics, e.g. cycling, throughput and redundancy, which were compared between the modeled systems. The pathway from microphytobenthos to meiofauna was the largest flow in all habitats, with little influence of variations in availability and productivity of food sources. This resulted in high production and short turnover time of meiofauna. Macrofauna relied on a wider range of food sources and had a much longer turnover time. All trophic groups of meiofauna, except for selective deposit feeders, had a very high dependency on microphytobenthos. Selective deposit feeders relied instead on a wider range of food sources, with varying contributions of bacteria, microphytobenthos and sediment organic matter. Splitting meiofauna compartments and aggregating macrofauna compartments, resulting in a similar number of compartments, reduced the food web model cycling and increased the redundancy.

Keywords: ecological model; food web model; inverse analysis; meiofauna; microphytobenthos; macrofauna; stable isotope mixing models; mudflats; seagrass beds; sandflats

1. INTRODUCTION

Meiofauna are known to have a high production due to their high turnover rate (Kuipers et al. 1981) and high transfer efficiency (Danovaro et al. 2007), despite their general relatively lower biomass. Their metabolic importance sometimes overtake that macrofauna in intertidal and deep-sea ecosystems (Schwinghamer et al. 1986; Giere 2009). Meiofauna are also known to be an important connection between primary producers and secondary consumers (Leguerrier et al. 2003; Rzeznik-Orignac et al. 2008), as well as transferring carbon from bacterial communities towards higher trophic levels (Pascal et al. 2008; Vafeiadou et al. 2014). Thus, given the important role of meiofauna in several ecological processes, such as grazing on primary producers, secondary production, and transfer of energy to higher trophic levels, unravelling their role in intertidal food webs is of very high importance (Schratzberger and Ingels 2017). Nevertheless, the role of meiofauna in food web dynamics is generally poorly described and understood (Leguerrier et al. 2003; Schratzberger and Ingels 2017), especially in benthic-pelagic coupled food web models (e.g. Gamito and Erzini, 2005; Lercari et al., 2010; Saint-Béat et al., 2014; Tecchio et al., 2015).

In most recent food web models meiofauna is described as a single compartment, or at most split into nematodes and benthic copepods (Leguerrier et al. 2003, 2007; Baird et al. 2007; Pacella et al. 2013). However, nematodes, generally the most abundant taxa of meiofauna, can be divided into various trophic groups with different feeding behavior, i.e., herbivory, bacterivory, or omnivory/carnivory (Wieser 1953). Abundances of nematodes from these trophic groups and their feeding behavior might change depending on availability, quantity and quality of food sources (Giere, 2009). In bare systems, meiofauna have been reported to feed mainly on microphytobenthos (Rzeznik-Orignac et al. 2008; Moens et al. 2014), whereas their range of food sources is much larger in vegetated sediments (Leduc et al. 2009; Lebreton et al. 2012; Vafeiadou et al. 2014). Non-selective deposit feeders feed on various food sources such as microphytobenthos, bacteria, detritus, and their diet changes depending on the availability of these food sources (Moens and Vincx 1997b; Rzeznik-Orignac et al. 2008). Therefore, separating meiofauna into major trophic groups is needed to better understand their relationships with specific food sources and the role of these organisms in food webs.

Due to methodological challenges, field measurements to determine the role of smaller organisms (e.g. bacteria, meiofauna, and small macrofauna) in food webs have rarely been included into monitoring and time series, and data on these groups are therefore often derived from single experimental studies (Schiemer et al. 1980; Woombs and Laybourn-Parry 1985; Vranken and Heip 1986; Herman and Vranken 1988). Over the last decades, consumption flows have been estimated using several methods such as feeding experiments, feeding observations and stomach content analyses (Goss-Custard et al. 1977; Fauchald and Jumars 1979; Jensen and Siegismund 1980; Turpie and Hockey

1984; Haubois et al. 2005a). Trophic marker based approaches (e.g. stable isotopes) have been used to overcome these methodological issues on the field (Moens et al. 2005b; Rzeznik-Orignac et al. 2008; Leduc et al. 2009; Lebreton et al. 2012), and trophic marker data have been used as constraints into food web models to better assess the role of small organisms (van Oevelen et al. 2009; Pacella et al. 2013).

Quantitative food web models (and particularly Linear Inverse Models) are usually constructed using conceptual and physiological information as well as field measurements, which are then translated into constraints related to production, respiration, consumption and egestion of the various organisms (Leguerrier et al. 2003, 2007; Degré et al. 2006; Niquil et al. 2006; Pacella et al. 2013; Saint-Béat et al. 2013b). Linear inverse models can then be used to generate a static, mass-balanced, temporally integrated snapshot of the complete food web and their flows using a combination of field and relevant data (Vézina and Platt 1988; Niquil et al. 2012). Indeed, inverse modeling is a powerful method in estimating unmeasured components within an ecosystem (Leguerrier et al. 2003, 2007; Degré et al. 2006; Pacella et al. 2013). Combined with the Markov chain Monte Carlo method, which provides the probability distribution of flows in underdetermined systems and avoids underestimations in both the size and complexity of the modeled food web (Kones et al. 2006; Johnson et al. 2009), this technique permits to generate a static, mass-balanced, temporally integrated snapshot of the complete food webs and their flows (Kones et al. 2006; van der Meersche et al. 2009; van Oevelen et al. 2009). Outputs of models in terms of quantitative flow values are then generally analyzed using Ecological Network Analyses (ENA) which provide numerous indices of the network properties that permit comparing the functioning of ecosystems (Kay et al. 1989; Wulff et al. 1989; Christian et al. 2005; Ulanowicz 2011; Niquil et al. 2012). These type of food web models can provide information on the effects of environmental changes on the ecosystem structure and functioning (Niquil et al. 2012). They are also interesting from a theoretical point of view (Ulanowicz et al. 2009) since they can be utilized to define food web characteristics, such as recycling, dependencies, and efficiencies (Niquil et al. 2012), which in turn can be useful information in ecosystem management and policy making (de la Vega et al. 2018a; Schückel et al. 2018).

The aims of the present study were to understand the role of meiofauna in soft-bottom intertidal habitats and to determine potential changes in meiofauna feeding strategy depending on the availability and productivity of food sources using food web modeling. Food web models of the Marennes-Oléron Bay and of the Sylt-Rømø Bight had already been built, mostly considering meiofauna as a single compartment being partly herbivorous and detritivorous (Leguerrier et al. 2003, 2007, Baird et al. 2004b, 2007). We integrated new data from biomass assessments (van der Heijden et al. in press) and trophic markers (van der Heijden et al. submitted). We compare five intertidal habitats to better

understand the role of meiofauna in coastal ecosystems, both in terms of quantitative flow values and food web properties using ENA analysis.

2. MATERIAL AND METHODS

2.1. Study sites

The Marennes-Oléron Bay, France, dominated by intertidal bare mudflats, is influenced by oceanic and continental inputs (i.e., Charente river) of organic matter (Gouleau et al. 2000), whereas the semi-enclosed basin of the Sylt-Rømø Bight, Germany, has little direct continental inputs (Asmus and Asmus 1985, 2005). The Sylt-Rømø Bight is influenced on the other hand by the coastal water masses of the North Sea that are on their part to a high extent influenced by the large rivers Elbe, Weser and Rhine.

Benthic-pelagic coupled food web models were built for several intertidal habitats from the two bays: a bare mudflat (mudflat MO) and a seagrass bed (seagrass MO) in the Marennes-Oléron Bay, and a bare mudflat (mudflat SR), a seagrass bed (seagrass SR) and a sandflat (sandflat SR) in the Sylt-Rømø Bight (Fig. 5.1). These different habitats are characterized by different plant and animal communities which previously been described: seagrass MO (Lebreton 2009; Lebreton et al. 2009), mudflat MO (Rzeznik-Orignac et al. 2003; Haubois et al. 2005b; Bocher et al. 2007), Sylt-Rømø Bight habitats (Asmus and Asmus 1993, 1998, 2000, 2005; Asmus and Bauerfeind 1994; Gätje and Reise 1998), and additional information can be found in van der Heijden et al. (in press). Food web models have already been constructed for different habitats (Leguerrier et al. 2003; Baird et al. 2007; Pacella et al. 2013; Saint-Béat et al. 2013b, 2014).

2.2. Stable isotope mixing models

Stable isotope mixing models MixSIAR (Stock et al. 2018) were applied to isotope data from van der Heijden et al. (submitted) to compute the dietary contribution of food sources to benthic copepods and trophic groups of nematodes. Dietary contributions for these consumers were estimated for the mudflats, seagrass beds and sandflat of the Marennes-Oléron Bay and the Sylt-Rømø Bight using the $\delta^{13}\text{C}$ and $\delta^{15}\text{N}$ values (mean and standard deviation) of suspended particulate organic matter (SPOM), sediment organic matter (SOM) and microphytobenthos from van der Heijden et al. (submitted) and those of sulfide-oxidizing bacteria from Vafeiadou et al. (2014). Isotope compositions of consumers were provided for benthic copepods and trophic groups of nematodes, namely selective deposit feeders, non-selective deposit feeders, epigrowth feeders and omnivores/predators. Trophic fractionation factors used were $1.0\text{‰} \pm 1.2$ for $\delta^{13}\text{C}$ and $2.5\text{‰} \pm 2.5$ for $\delta^{15}\text{N}$ (vander Zanden and Rasmussen 2001). Models were run for 100,000 iterations (of which the first 50,000 iterations were

discarded), and *a priori* defined data was absent. The 90% credibility intervals (CI) provided by the mixing models are reported here and were used as constraints in the food web models, following the approach of Pacella et al. (2013) and as described below.

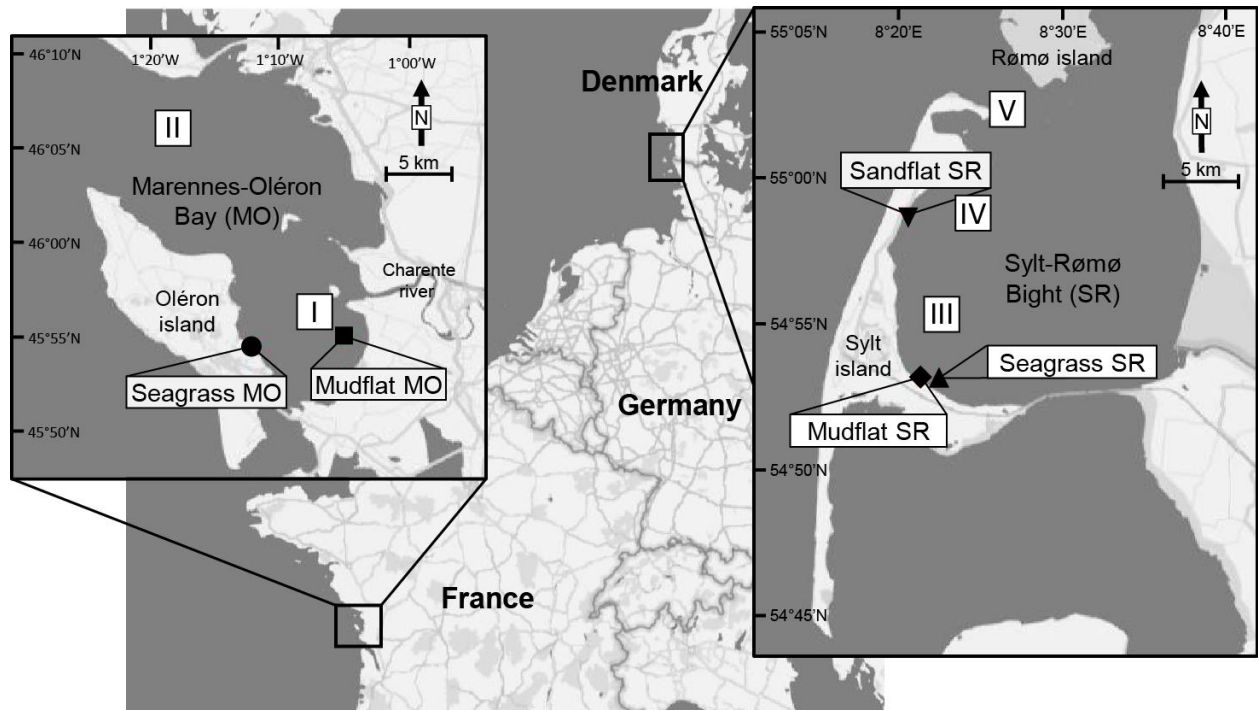

Figure 5.1. Study sites in the mudflats, seagrass beds and sandflat in the Marennes-Oléron Bay (MO) and the Sylt-Rømø Bight (SR) along the European Atlantic coast.

2.3. Database and linear inverse model construction

Linear inverse ecosystem models with Markov chain Monte Carlo (LIM-MCMC) were built to determine carbon flows in the five habitats on a daily basis ($\text{mgC m}^{-2} \text{d}^{-1}$) using the R software (R Core Team, 2016). Flow estimations were expressed as daily averages, converted from the annual averages, to compare the food web models of these habitats. This allowed us to limit the seasonal and daily fluctuations that influence network indices due to fluctuating temperature (monthly: Baird et al. (1998), or between seasons: Baird and Ulanowicz, (1989) and Gaedke and Straile, (1994)), daily variations of nitrogen concentrations (Field et al. 1989), seasonal nutrient loads and hypoxia (Baird et al. 2004a), and the amount of freshwater inflows in estuaries (Scharler and Baird 2005). These models were further constrained using outputs of the stable isotope mixing models and biomass of meiofauna (van der Heijden et al. submitted) in order to better determine the role of meiofauna within soft-bottom coastal habitats.

The model of mudflat MO was based on data provided by Leguerrier et al. (2003), Degré et al. (2006) and Saint-Béat et al. (2014) (Appendix 5.1 and 5.2). Original compartments of this model were used as a basis for the other food web models and therefore no aggregations were conducted.

The seagrass MO model was based on data provided by Pacella et al. (2013) (Appendix 5.3). Biomass of bacteria was changed with the value obtained in Leguerrier et al., (2003), since similar biomass was observed in both habitats of the Marennes-Oléron Bay (van der Heijden et al. in press). Macrofauna constraints used in Pacella et al. (2013) were aggregated based on feeding types. Trophic groups were benthic deposit feeders (*Abra* spp., *Arenicola marina*, and *Notomastus latericeus*), benthic grazers (*Peringia ulvae* and gastropod grazers), benthic omnivores/predators (*Carcinus maenas*, *Crangon crangon*, and *Cerebratulus marginatus*), and suspension feeders (*Cerastoderma edule*, *Limecola balthica*, *Mytilus galloprovincialis*, *Scrobicularia plana*, and *Tapes* spp.). Consumption rates of these feeding groups were estimated using aggregated stable isotope values (Pacella et al. 2013). Aggregation was done based on weighted averages using biomass and flows of the different genera.

The models of habitats from the Sylt-Rømø Bight were based on data provided by Baird et al. (2007) and modified by Saint-Béat et al. (2013) (Appendix 5.4 to 5.6). Because less minimum and maximum values of flow constraints (mainly production and consumption constraints) were known compared to models of the Marennes-Oléron Bay, equalities, provided by Saint-Béat et al. (2013), were converted to inequalities by subtracting and adding 30% to these values. This was considered to be the most convenient estimations based on sensitivity analyses from Guesnet et al., (2015), and corresponds with seasonal fluctuations for macrofauna observed by (Asmus 1987).

Table 5.1. Biomass and abbreviations of compartments used in the food web models of the mudflats, seagrass beds and sandflats in the Marennes-Oléron Bay (MO) and the Sylt-Rømø Bight (SR). NA = no data available.

		Mudflat MO	Seagrass MO	Sandflat SR	Mudflat SR	Seagrass SR
Number of compartments		19	21	17	17	20
Number of flows		123	138	100	96	108
Compartment	Abbr.	Biomass (mg C m⁻²)				
Terrestrial						
Carnivorous birds	CBR	7.0	6.0	121.3	174.7	417.3
Herbivorous birds	HBR	-	1.0	-	-	71.7
Benthic						
Microphytobenthos	MPB	3125.0	9250.0	130.0	120.0	120.0
<i>Zostera noltei</i> (seagrass tissues)	ZOS	-	6133.3	-	-	30890.0
Benthic bacteria	BBA	947.0	947.0	625.0	625.0	625.0
Nematodes – bacterivorous	NBA	70.5	4.6	0.3	5.5	4.6
Nematodes – non-selective deposit feeders	NDF	496.9	60.8	40.3	58.2	60.8
Nematodes – epigrowth feeders	NEF	607.5	165.5	23.2	19.4	165.5
Nematodes – omnivores/predators	NOM	82.5	63.2	60.2	19.1	63.2
Benthic copepods	COP	94.8	78.3	50.1	6.0	6.1
Macrofauna – benthic deposit feeders	BDF	3.5	98.8	6797.6	3997.6	12841.2
Macrofauna – benthic grazers	BGR	695.6	4076.6	406.0	8004.0	7174.6
Macrofauna – benthic suspension feeders	SUS	42.7	1704.8	19204.6	6275.6	12048.1
Macrofauna – benthic omnivores/carnivores	BOM	597.4	50.8	729.6	2939.8	1097.9
Sediment organic matter	SOM	NA	27560.0	19000.0	19000.0	19000.0
Pelagic						
Phytoplankton	PHY	254.5	254.5	1040.0	1040.0	1040.0
Pelagic bacteria	PBA	157.2	157.2	9.0	9.0	9.0
Mesozooplankton	ZOO	160.0	160.0	11.2	-	-
Microzooplankton	MZO	110.0	-	-	-	-
Benthic fish	BFI	195.0	195.0	2.9	1.5	14.9
Suspended particulate organic matter	SPOM	NA	1044.2	500.0	500.0	500.0
Dissolved organic matter	DOC	-	1850.3	-	-	62.0

2.4. Calculation of LIM solutions

Model simulations were realized using a script of *limSolve* package from van Oevelen et al. (2009) with the use of the R software (R Core Team, 2016). Mass balance of each compartment and constraints were integrated into the LIM-MCMC models. Matrices of the linear equations (A and G) were combined with the vectors of equalities (b) and inequalities (h) to generate the vector of unknown flows (x) (van der Meersche et al. 2009):

$$\text{Equality equation: } A * x = b$$

$$\text{Inequality equation: } G * x \geq h$$

The vectors x were then estimated by sampling through a solution space using the LIM-MCMC mirror defined by van den Meersche et al. (2009) and revised by van Oevelen et al. (2010). 500,000 solutions were calculated, using a jump size of 0.5, and uncertainty was estimated, which provided a range of possible values for each flow. Visual observations of iterated flow values provided information on the stability of the iterations and the completeness of the sampled solution space and thereby validated the total number of iterations and jumps selected.

2.5. Network analysis and statistical methods

Network analysis and statistical tests were performed using the R software. Four ENA indices were computed from the 500,000 estimated solutions: Total system throughput (T..), Finn cycling index (FCI), relative redundancy (R/C) and system omnivory index (SOI) (formulas in Appendix 5.7). T.. reflects the sum of all network flows within the system (Latham et al., 2006), also considered as the total power generated within the system (Baird et al. 1998). Note the difference between the total system throughput (T..) and total system through-flow (TST), used by Baird et al. (2007) and Leguerrier et al. (2003). TST, which is the sum of compartmental through-flow (Latham et al., 2006), is estimated here as well to facilitate comparison. The individual throughput of a compartment is an estimation of the compartment activity, defined as the sum of all fluxes of matter passing through this compartment (Kay et al. 1989). FCI reflects the retentiveness of the system and is estimated by the ratio of T_c and T.., where T_c is the amount devoted to cycling (Baird and Ulanowicz 1989; Baird et al. 2004b, a). R/C highlights the diversity of food sources within the diet of consumers (Ulanowicz and Norden 1990). The SOI highlights the omnivory of all compartments, weighted by the logarithm of each compartment's ingestion (Pauly et al. 1993). Cliff's delta statistic method (Cliff 1993; MacBeth et al. 2012), as defined in Tecchio et al. (2016), was used to test for significant differences of index values between the five habitats. This method uses a non-parametric effect size statistic to estimate the probability that a randomly selected value in the first sample is higher than a randomly selected value in the second sample, minus the reverse probability. Whether the difference is due to an effective

ecological meaning or sample size alone can be tested by comparing the degree of overlap between the two distributions. Threshold values determined the significant difference (Romano et al., 2006) with low threshold values considered as similarly (negligible: $|\delta| < 0.147$ and small $|\delta| < 0.33$), whereas higher delta values (medium $|\delta| < 0.474$ and large $|\delta| > 0.474$) were considered as significantly different (Tecchio et al. 2016).

Further, the trophic levels and omnivory indices were calculated for each individual compartment (formulas in Appendix Table 5.7). Trophic levels were also estimated for the whole food webs. Several ratios were calculated from the estimated solutions for each individual compartments: detritivory/herbivory ratio, bacterivory/herbivory ratio, dependency ratio, throughput/biomass ratio and production/biomass ratio. Detritivory/herbivory ratios were estimated based on the detritivory (consumption of SOM, SPOM and dissolved organic carbon (DOC)) and herbivory (consumption of microphytobenthos, phytoplankton and seagrass) of each consumer compartment. Bacterivory/herbivory ratios were estimated based on the bacterivory (consumption of benthic and pelagic bacteria) and herbivory of each consumer compartment. Dependency ratios determines the dependence of consumers on the sources through both direct and indirect pathways. Its allows to determine the origin of carbon ingested by each compartment. Because an atom of carbon can go through several compartments before it is consumed by a particular organism, the sum of dependency ratios can exceed 100% (Baird and Ulanowicz 1989). Throughput/biomass and production/biomass ratios, an estimation of the activity per biomass unit, were estimated based on the throughput, production and biomass of each consumer compartment and thus permits determining the active compartments of the ecosystem. Cliff's delta statistic was used to test for significant differences in detritivory/herbivory and bacterivory/herbivory ratios between the five habitats.

Modified Lindeman spines were used to illustrate the five complex food webs as linear food chains with integer trophic levels (Wulff et al. 1989). In this modified version, primary producers and detritus form the first trophic level. Consumers were distributed in their respective trophic levels according to their feeding behavior and the trophic levels were separated between meiofauna and other consumers. For each trophic level the inputs, losses due to respiration, exports and output as detritus and transfers to higher trophic levels were detailed. The trophic efficiency was calculated based on these flows and highlights the efficiency of the energy transferred from one trophic level to the next one (Baird et al. 2004b).

3. RESULTS

3.1. MixSIAR outputs

Mixing models highlighted the importance of microphytobenthos as a food source for non-selective deposit feeding nematodes (50.1–97.8%), epigrowth feeding nematodes (35.2–98.1%), and benthic copepods (37.6–96.5%) in all of the five habitats (Appendix 5.8). The food sources used by selective deposit feeding nematodes were more variable depending on the habitat. In the Marennes-Oléron Bay selective deposit feeders relied mainly on bacteria (38.6–88.2%) and to a lesser extent on microphytobenthos (8.3–49.1%). The role of bacteria was much lower in the Sylt-Rømø Bight (2.8–42.5%), whereas contributions of microphytobenthos were higher (23.5–62.7%). SPOM (0.4–52.2%) and SOM (0.4–38.8%) had variable contributions in the Sylt-Rømø Bight habitats. Food sources were much more diverse for omnivores/predating nematodes, as these consumers were relying on nematodes (0.1–65.9%) and benthic copepods (0.8–54.5%), as well as on primary producers (i.e., microphytobenthos, 0.6–58.4%).

3.2. General characteristics of the food web models

The food web models of the five habitats in each system, the Marennes-Oléron Bay and the Sylt-Rømø Bight, integrated different compartments with varying biomass (Table 5.1), energy requirements, production estimates, resulted in distinct simulated trophic interactions (Fig. 5.2-5.4, Appendix 5.9).

Habitats of the Marennes-Oléron Bay had a higher biomass of microphytobenthos, benthic bacteria, pelagic bacteria, zooplankton and benthic fish compared to the Sylt-Rømø Bight, whereas biomass for seagrass, phytoplankton, benthic deposit feeders, suspension feeders and carnivorous birds in the Sylt-Rømø Bight compared to the Marennes-Oléron Bay (Table 5.1). Local patterns were also observed between habitats in the two ecosystems: higher biomass of nematodes (all trophic groups) in mudflat MO than in all other habitats, and higher biomass of benthic grazers and suspension feeders in seagrass MO than in mudflat MO. The different habitats in the Sylt-Rømø Bight were generally more similar in terms of compartment biomass.

The carbon flow networks of the five habitats were cast into a simplified construction of each food web (Fig. 5.2-5.4). Such diagrams highlighted that larger proportions of the energy passed through meiofauna in the Marennes-Oléron Bay habitats (43.7–70.4%, Fig. 5.2), while higher proportions of energy flowed through macrofauna compartments in the Sylt-Rømø Bight habitats (54.6–70.6%, Fig. 5.2 and 5.3).

Mudflat MO

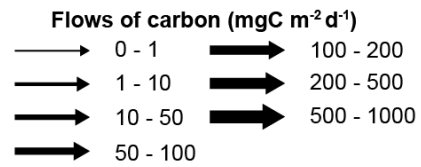
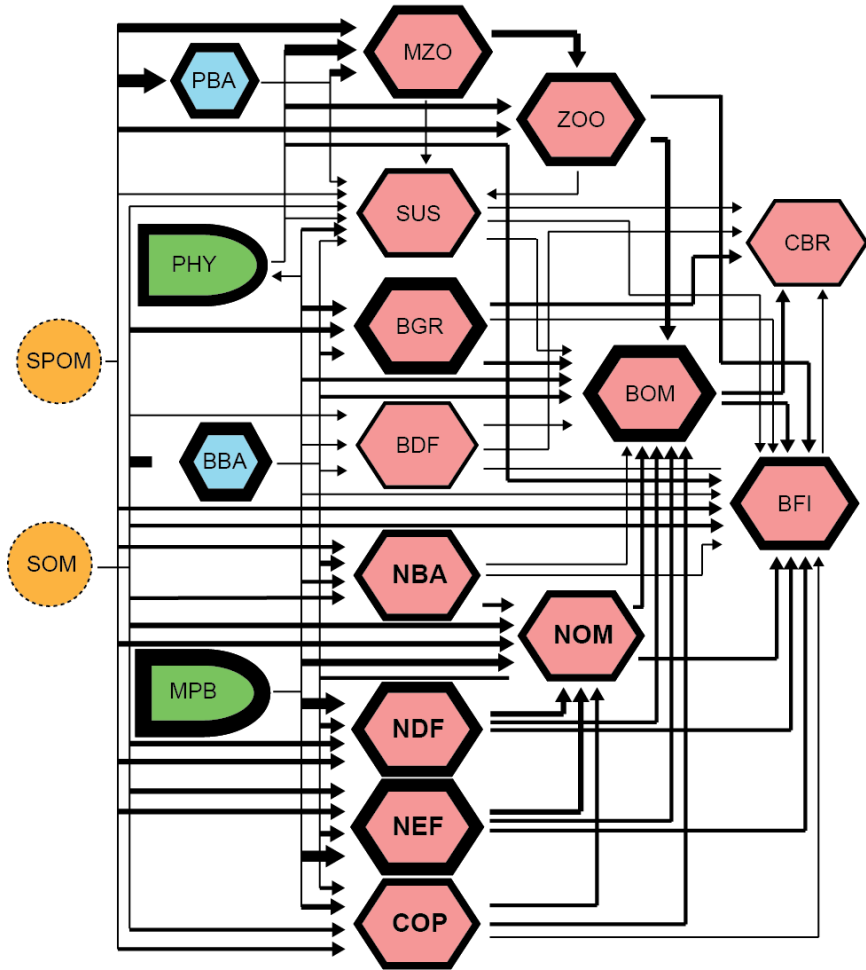

Seagrass MO

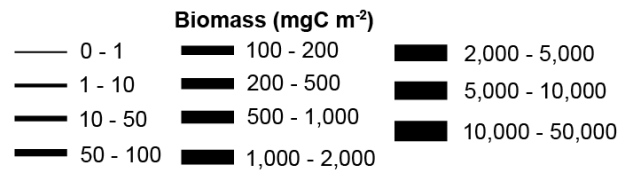
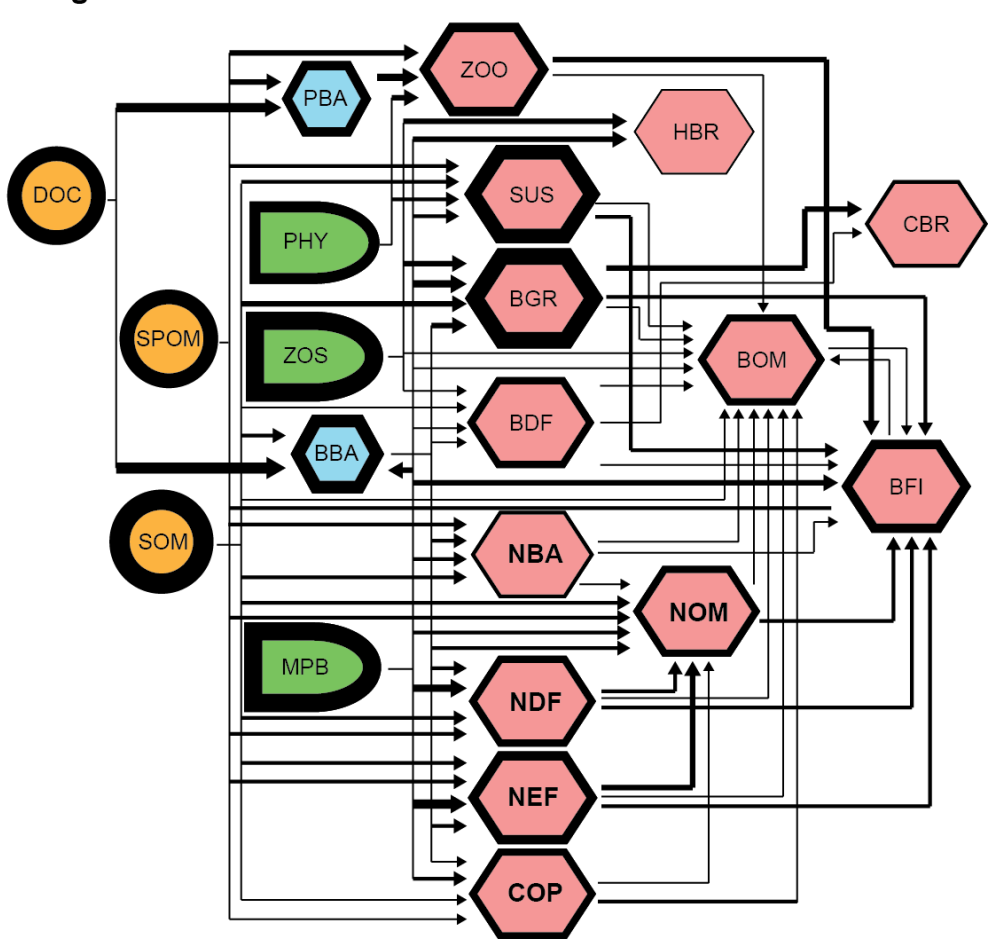
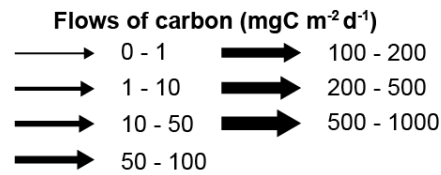
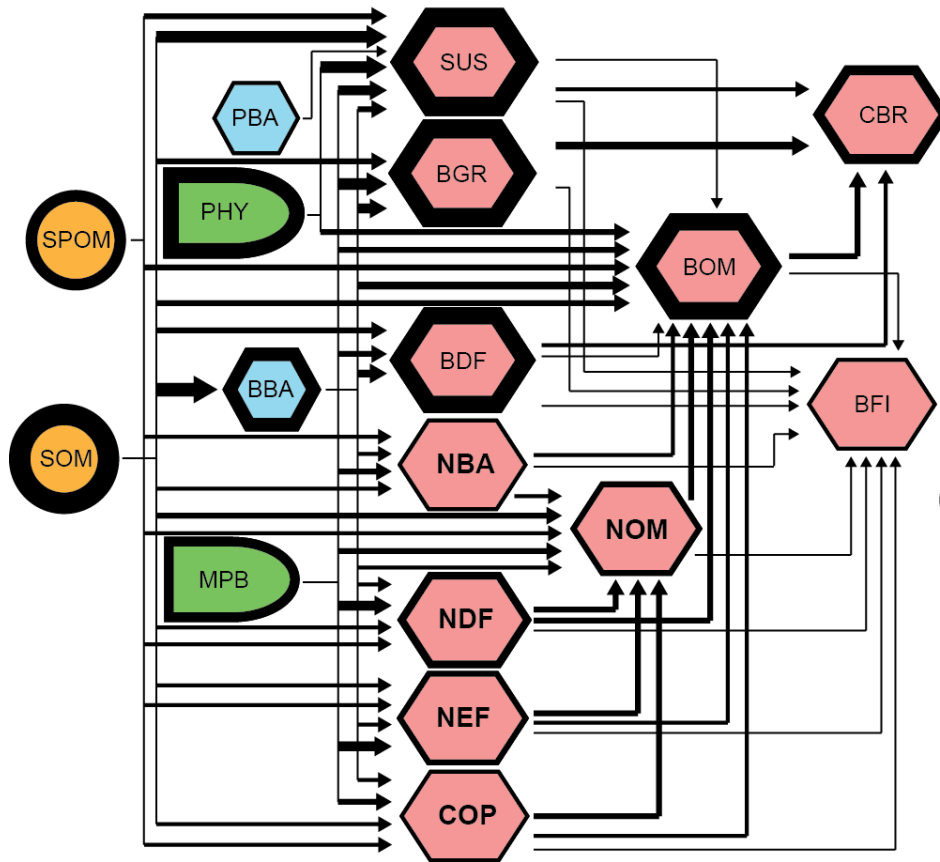

Figure 5.2. Food webs of the mudflat and seagrass bed in the Marennes-Oléron Bay (MO) obtained by linear inverse modeling. Mudflat MO food web model consists of two primary producer compartments (green), two bacteria compartments (blue), two detrital compartments (orange) and 13 consumer compartments (pink). Seagrass MO food web model consists of three primary producer compartments (green), two bacteria compartments (blue), three detrital compartments (orange) and 13 consumer compartments (pink). Arrow thickness indicates the magnitude of the flow between compartments. Unknown biomass for SOM and SPOM of mudflat MO. Meiofauna compartments are in bold. BBA =benthic bacteria, BDF = benthic deposit feeding macrofauna, BFI = benthic fish, BGR = benthic grazing macrofauna, BOM = benthic omnivorous macrofauna, COP = benthic copepods, CBR = carnivorous birds, DOC = dissolved organic carbon, HBR = herbivorous birds, MPB = microphytobenthos, MZO = microzooplankton, NBA = selective deposit feeding nematodes, NDF = non-selective deposit feeding nematodes, NEF = epigrowth feeding nematodes, NOM = omnivorous/predating nematodes, PBA = pelagic bacteria, PHY = phytoplankton, SPOM = suspended particulate organic matter, SOM = sediment organic matter, SUS = suspension feeding macrofauna, ZOO = mesozooplankton, ZOS = *Zostera noltei* material.

Mudflat SR



Seagrass SR

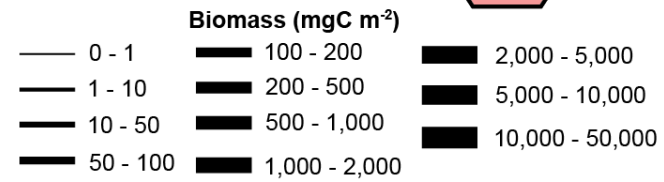
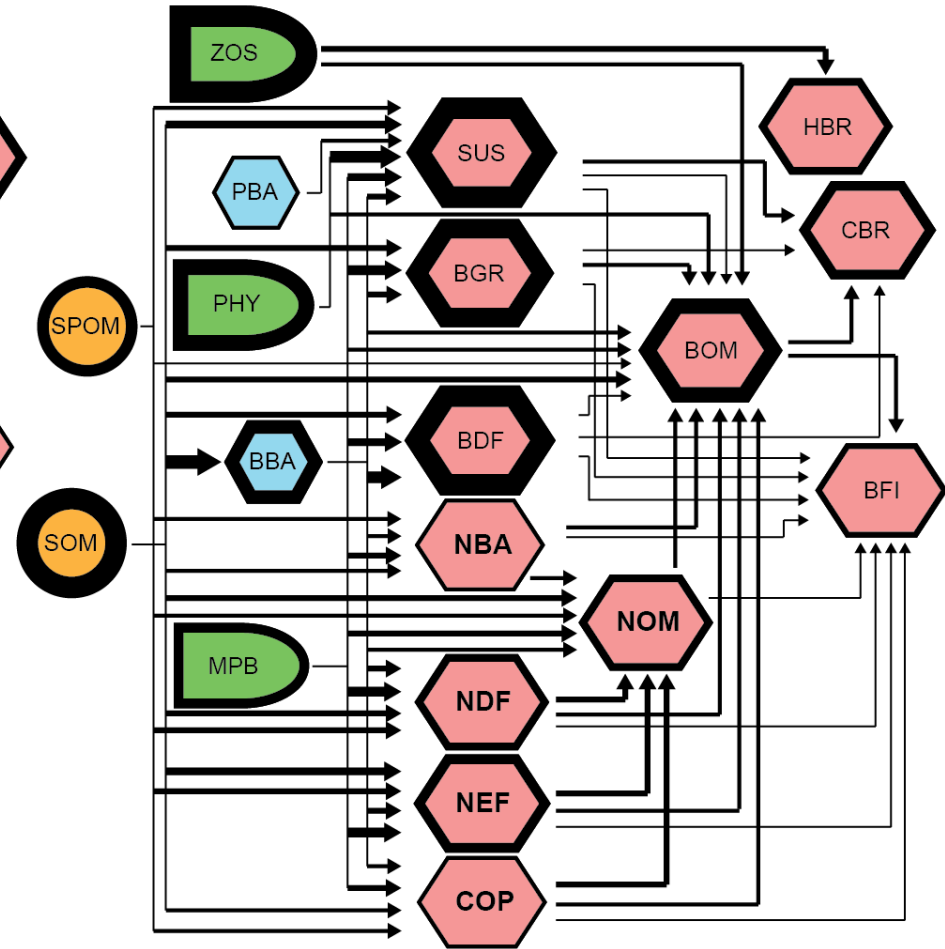

Figure 5.3. Food webs of the mudflat and seagrass bed in the Sylt-Rømø Bight (SR) obtained by linear inverse modeling. Mudflat SR food web model consists of two primary producer compartments (green), two bacteria compartments (blue), two detrital compartments (orange) and 11 consumer compartments (pink). Seagrass MO food web model consists of three primary producer compartments (green), two bacteria compartments (blue), two detrital compartments (orange) and 12 consumer compartments (pink). Arrow thickness indicate the magnitude of the flow between compartments. Meiofauna compartments are in bold. BBA =benthic bacteria, BDF = benthic deposit feeding macrofauna, BFI = benthic fish, BGR = benthic grazing macrofauna, BOM = benthic omnivorous macrofauna, COP = benthic copepods, CBR = carnivorous birds, HBR = herbivorous birds, MPB = microphytobenthos, NBA = selective deposit feeding nematodes, NDF = non-selective deposit feeding nematodes, NEF = epigrowth feeding nematodes, NOM = omnivorous/predating nematodes, PBA = pelagic bacteria, PHY = phytoplankton, SPOM = suspended particulate organic matter, SOM = sediment organic matter, SUS = suspension feeding macrofauna, ZOS = *Zostera noltei* material.

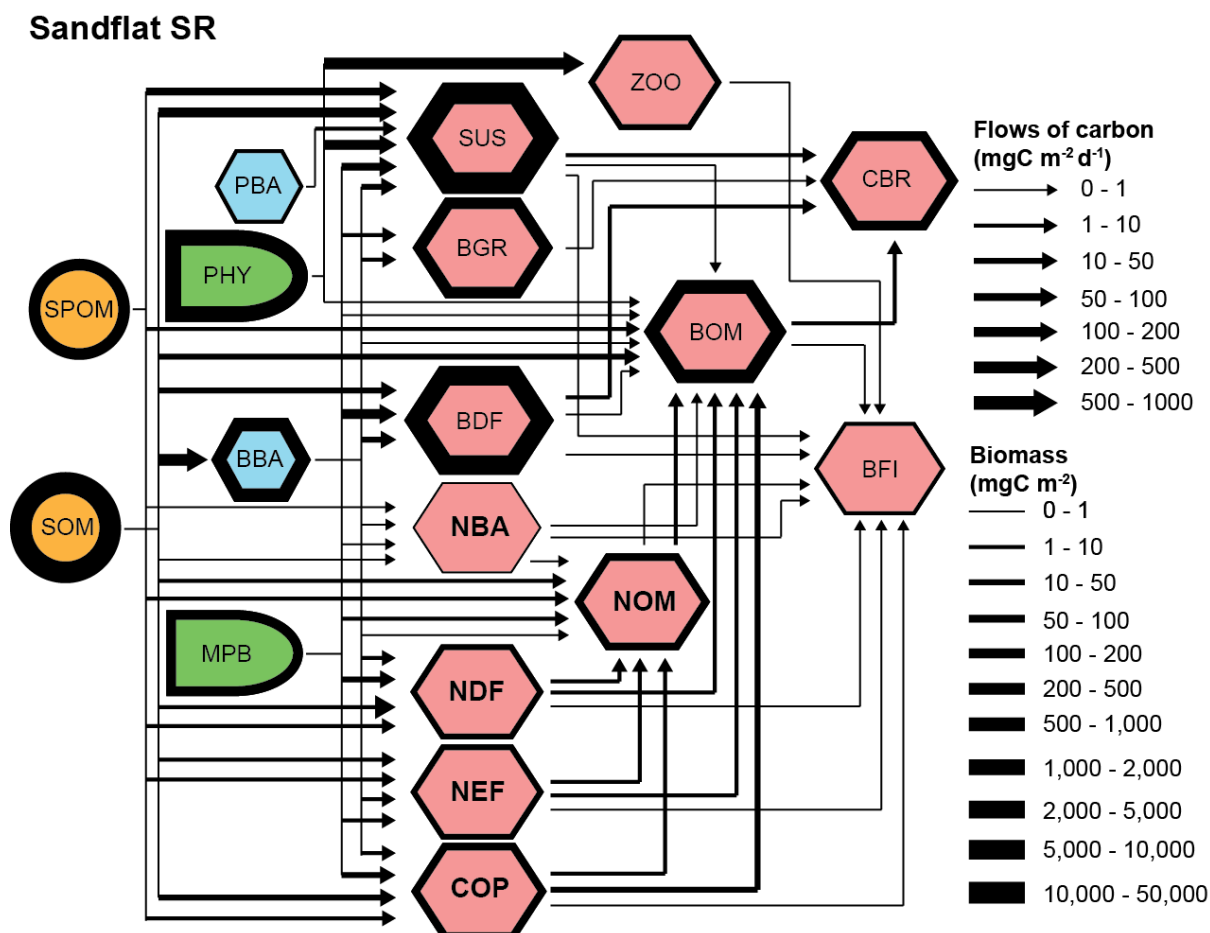

Figure 5.4. Food of the sandflat in the Sylt-Rømø Bight (SR) web obtained by linear inverse modeling. This model consists of two primary producer compartments (green), two bacteria compartments (blue), two detrital compartments (orange) and 12 consumer compartments (yellow). Arrow thickness indicate the magnitude of the flow between compartments. Meiofauna compartments are in bold. BBA = benthic bacteria, BDF = benthic deposit feeding macrofauna, BFI = benthic fish, BGR = benthic grazing macrofauna, BOM = benthic omnivorous macrofauna, COP = benthic copepods, CBR = carnivorous birds, MPB = microphytobenthos, MZO = microzooplankton, NBA = selective deposit feeding nematodes, NDF = non-selective deposit feeding nematodes, NEF = epigrowth feeding nematodes, NOM = omnivorous/predating nematodes, PBA = pelagic bacteria, PHY = phytoplankton, SPOM = suspended particulate organic matter, SOM = sediment organic matter, SUS = suspension feeding macrofauna, ZOO = mesozooplankton.

3.3. Network analysis

Total system throughput (T..) was significantly higher in the Marennes-Oléron Bay habitats (mudflat: $8943 \text{ mgC m}^{-2} \text{d}^{-1}$, seagrass: $8888 \text{ mgC m}^{-2} \text{d}^{-1}$) compared to the Sylt-Rømø Bight habitats (mudflat: $7142 \text{ mgC m}^{-2} \text{d}^{-1}$, seagrass: $7990 \text{ mgC m}^{-2} \text{d}^{-1}$, sandflat: $5037 \text{ mgC m}^{-2} \text{d}^{-1}$) (Fig. 5.5, Appendix 5.10). Total system through-flow (TST) was higher in mudflat MO ($6859 \text{ mgC m}^{-2} \text{d}^{-1}$) compared to other habitats (seagrass SR: $6067 \text{ mgC m}^{-2} \text{d}^{-1}$, seagrass MO: $5716 \text{ mgC m}^{-2} \text{d}^{-1}$, mudflat SR: $5711 \text{ mgC m}^{-2} \text{d}^{-1}$ and sandflat SR: $3735 \text{ mgC m}^{-2} \text{d}^{-1}$). Of the total carbon flows in the food webs, proportions involved in cycling pathways ranged from 2.4% (seagrass MO) to 13.1% (mudflat SR), with higher FCI

in the Sylt-Rømø Bight mudflat than in all other habitats, especially the seagrass bed of the Marennes-Oléron Bay. Relative redundancy (R/C) varied between 57.3% (sandflat SR) and 69.8% (seagrass MO), with the R/C in seagrass MO being higher than in all other habitats, and sandflat SR being lower than all other habitats. Total system omnivory index ranged from lowest index values in the sandflat of the Sylt-Rømø Bight (0.10) to the highest index in the mudflat of the Marennes-Oléron Bay (0.16, Fig. 5.5).

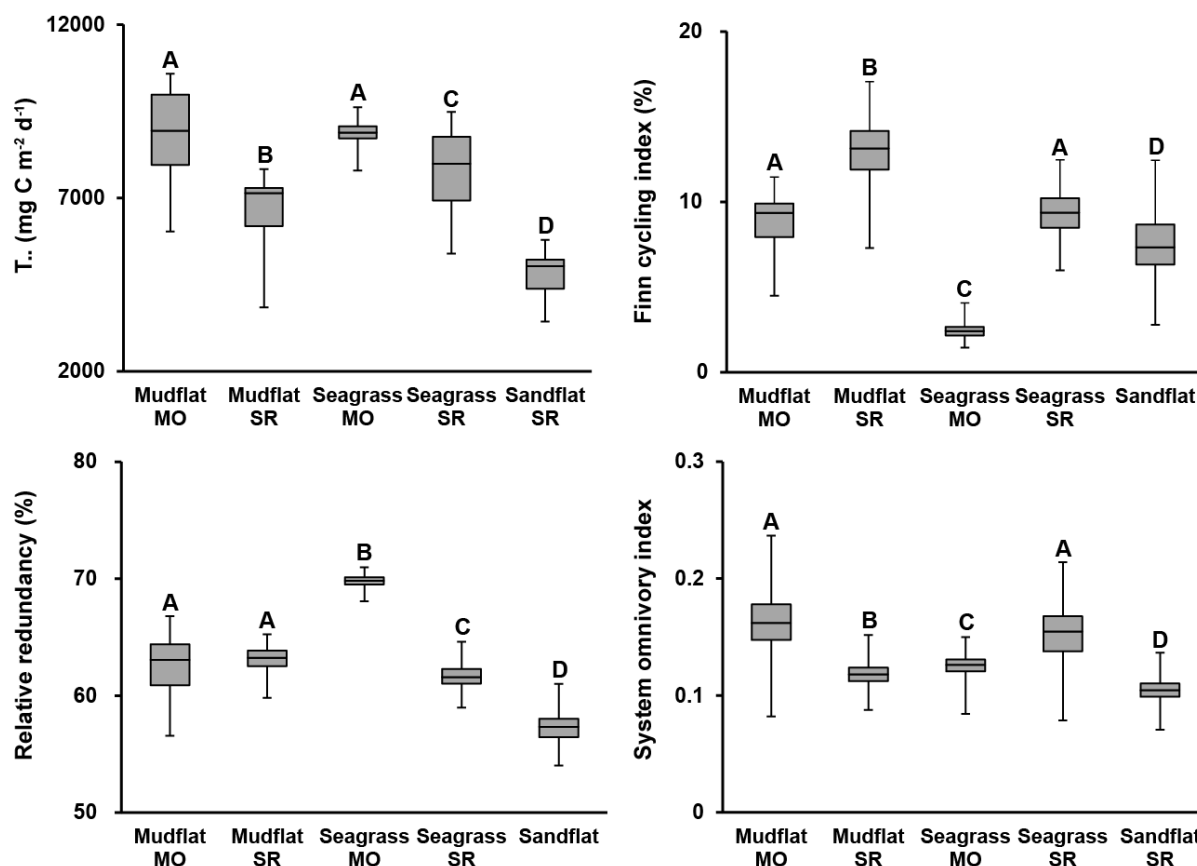

Figure 5.5. Ecological network analysis indices: total system throughput (T..) (top left panel), Finn cycling index (top right panel), relative redundancy (bottom left panel), and system omnivory index (bottom right panel) for the mudflats, seagrass beds and sandflat in the Marennes-Oléron Bay (MO) and the Sylt-Rømø Bight (SR). Letters displayed above boxes indicate groups of samples with similar indices using Cliff's delta statistics.

Mean trophic levels varied between habitats and ranged from 2.1 (seagrass MO) to 2.4 (mudflat MO and mudflat SR; Appendix 5.11). A low dependency on export was observed in mudflat SR (7.6%), seagrass MO (4.1%) and seagrass SR (6.2%), whereas the export dependency was slightly higher for mudflat MO and sandflat SR (Appendix 5.11). Detritivory/herbivory and bacterivory/herbivory ratios varied significantly between each habitat, when compared using Cliff delta statistics (lowest delta-value: 0.069, Appendix 5.10). The food web of mudflat MO had the highest detritivory/herbivory ratio (1.32), whereas seagrass MO had the lowest (0.38). Bacterivory/herbivory ratios were much lower, with the lowest ratio for seagrass MO (0.04) and the highest ratio in seagrass SR (0.32).

3.4. Throughput and production of food sources

The high total system throughput in seagrass MO was assigned mainly to the high input ($971.8 \text{ mgC m}^{-2} \text{ d}^{-1}$) and export ($1125.3 \text{ mgC m}^{-2} \text{ d}^{-1}$) of dissolved organic carbon (Appendix 5.9). Primary production of microphytobenthos represented the largest flows within the food webs of all habitats when exogenous flows were excluded, ranging from 774.4 (sandflat SR) to $1215.2 \text{ mgC m}^{-2} \text{ d}^{-1}$ (mudflat MO, Table 5.2). This was particularly the case in the Sylt-Rømø Bight where very high primary production/biomass (P/B) ratios of microphytobenthos were observed (6.45 to 7.87 d^{-1}), while they ranged from 0.11 to 0.39 d^{-1} in the Marennes-Oléron Bay habitats. The proportion of primary production by microphytobenthos ranged from 45.2% (seagrass SR) to 81.3% (seagrass MO) and microphytobenthos was the most important primary producer in all habitats with gross primary production (GPP) ranging from 774.4 (sandflat SR) to $1215.2 \text{ mgC m}^{-2} \text{ d}^{-1}$ (mudflat MO). GPP of seagrass was much lower than that of microphytobenthos in seagrass MO (45.1 compared to $1043.1 \text{ mgC m}^{-2} \text{ d}^{-1}$) and slightly lower than that of microphytobenthos in seagrass SR (792.8 compared to $857.8 \text{ mgC m}^{-2} \text{ d}^{-1}$).

Production of bacteria was more variable than production of microphytobenthos, with much higher values in the Sylt-Rømø Bight (147.7 to $339.8 \text{ mgC m}^{-2} \text{ d}^{-1}$) than for the Marennes-Oléron Bay (41.3 to $97.0 \text{ mgC m}^{-2} \text{ d}^{-1}$, Table 5.2). P/B ratios of bacteria were much lower than those of microphytobenthos and ranged from 0.04 (seagrass MO) to 0.54 d^{-1} (seagrass SR), with highest values in the Sylt-Rømø Bight (0.24 to 0.54 d^{-1}). Export of living compartments was much higher in seagrass MO ($490 \text{ mgC m}^{-2} \text{ d}^{-1}$) than in all other habitats (0.5 to $336.7 \text{ mgC m}^{-2} \text{ d}^{-1}$, Appendix 5.9). This export was mainly occurring in pelagic or migrating compartments, such as phytoplankton, pelagic bacteria, zooplankton, benthic fish and carnivorous birds.

Table 5.2. Production and production/biomass ratios of microphytobenthos, phytoplankton, seagrass and bacteria in the mudflats, seagrass beds, and sandflat in the Marennes-Oléron Bay (MO) and the Sylt-Rømø Bight (SR).

	Production ($\text{mgC m}^{-2} \text{d}^{-1}$)				
	Mudflat	Mudflat	Seagrass	Seagrass	Sandflat
	MO	SR	MO	SR	SR
Microphytobenthos	1215.2	1023.1	1043.1	857.8	774.4
Phytoplankton	604.9	237.4	194.2	247.5	446.5
Seagrass	-	-	45.1	792.8	-
Bacteria	97.0	313.2	41.3	339.8	147.7

	Production/biomass ratio (d^{-1})				
	Mudflat	Mudflat	Seagrass	Seagrass	Sandflat
Microphytobenthos	0.39	7.87	0.11	7.15	6.45
Phytoplankton	2.38	0.23	0.76	0.24	0.43
Seagrass	-	-	0.01	0.03	-
Bacteria	0.10	0.50	0.04	0.54	0.24

3.5. Meiofauna and macrofauna throughput and production

Meiofauna and macrofauna throughputs ranged from 285.0 (seagrass MO) to 996.1 $\text{mgC m}^{-2} \text{d}^{-1}$ (mudflat MO) and from 87.7 (mudflat MO) to 1490.0 $\text{mgC m}^{-2} \text{d}^{-1}$ (mudflat SR, Fig. 5.6), respectively. Meiofauna throughputs were higher than those of macrofauna in the Marennes-Oléron Bay habitats (throughput ratio from 1.7 to 11.4), while the opposite pattern was observed in the Sylt-Rømø Bight habitats (throughput ratios from 0.2 to 0.7). Meiofauna throughput was much higher than macrofauna throughput in mudflat MO.

Biomass of meiofauna (108.2–1352.1 mgC m^{-2}) was much lower than macrofauna (1339.2–33161.7 mgC m^{-2}) in all habitats, except in mudflat MO where biomass of meiofauna and macrofauna were similar (i.e., 1352.1 and 1339.2 mgC m^{-2} , Table 5.1). In seagrass MO, meiofauna biomass was 15-fold lower, whereas in the Sylt-Rømø Bight biomass of meiofauna were between 100-fold (seagrass SR) and 200-fold (mudflat SR) lower compared to macrofauna biomass. Throughput/biomass ratios of meiofauna were higher than those of macrofauna, ranging from 0.66 (sandflat SR) to 4.69 (mudflat SR), whereas macrofauna had much lower throughput/biomass ratios, ranging from 0.03 (seagrass MO) to 0.07 (mudflat SR).

Mean production ranged from 14.5 (seagrass MO) to 35.8 $\text{mgC m}^{-2} \text{d}^{-1}$ (mudflat MO) for meiofauna and from 3.2 (seagrass SR) to 41.3 $\text{mgC m}^{-2} \text{d}^{-1}$ (mudflat SR) for macrofauna. Mean production of meiofauna was higher than macrofauna production in mudflat MO, seagrass SR and sandflat, whereas they were more similar in mudflat SR and seagrass MO (Fig. 5.6, Appendix 5.12).

Production of meiofauna compartments ranged from 0.6 (benthic copepods, seagrass MO) to 48.7 $\text{mgC m}^{-2} \text{d}^{-1}$ (epigrowth feeders, mudflat MO, Appendix 5.12). Production of macrofauna compartments ranged from 0.1 (benthic deposit feeders, mudflat MO) to 90.1 $\text{mgC m}^{-2} \text{d}^{-1}$ (benthic grazers, mudflat SR).

Meiofauna production/biomass (P/B) ratios were much higher in the Sylt-Rømø Bight mudflat (0.28 d^{-1}) than in all other habitats (from 0.03 to 0.09 d^{-1}) (Fig. 5.6, Appendix 5.12). Macrofauna P/B ratios were between four (mudflat MO) and 1000 times (seagrass SR) smaller than meiofauna P/B ratios, and therefore lower than 0.01 d^{-1} in all habitats.

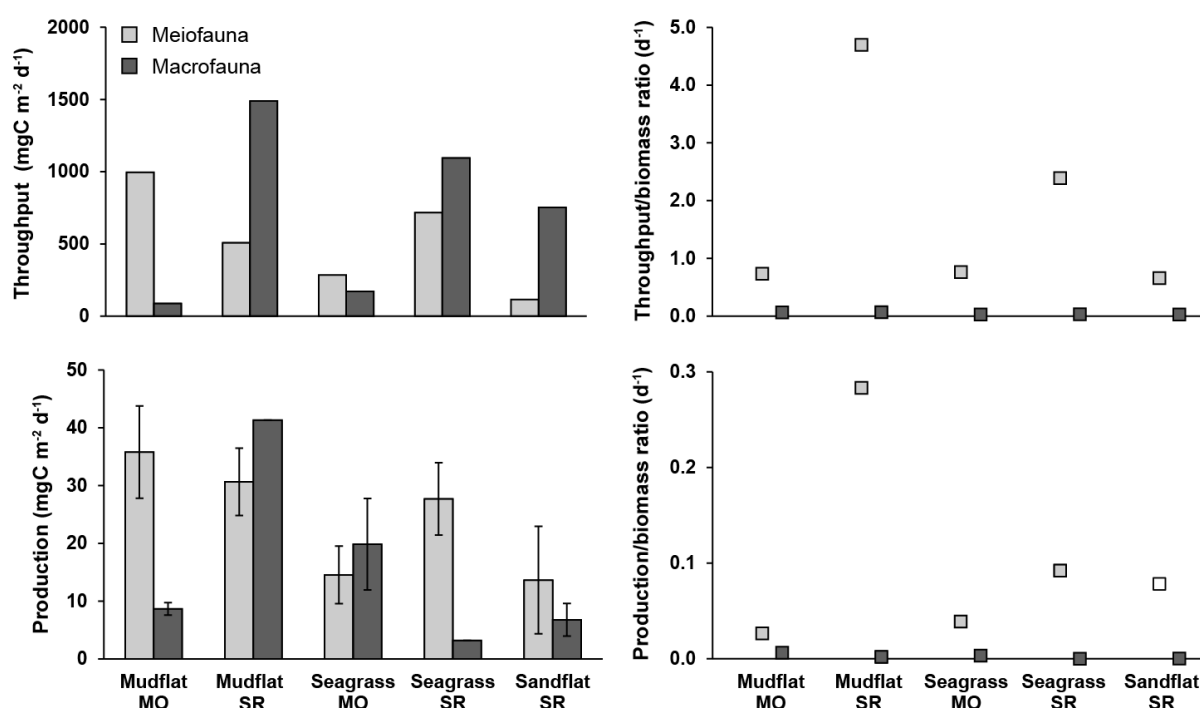

Figure 5.6. Throughput (left top panel), production (left bottom panel), throughput/biomass ratios (right top panel) and production/biomass ratios (right bottom panel) of meiofauna and macrofauna from the mudflats, seagrass beds and sandflat in the Marennes-Oléron Bay (MO) and the Sylt-Rømø Bight (SR).

3.6. Transfer efficiency

Modified Lindeman spines highlighted that input for primary producers (i.e., an aggregation of primary production and phytoplankton inputs) ranged from 1215.2 (mudflat MO) to 1900.1 $\text{mgC m}^{-2} \text{d}^{-1}$ (seagrass SR; Fig. 5.7). Transfer efficiencies (TE) of this integer trophic level I ranged from 33.3% (seagrass MO) to 77.8% (mudflat SR). Exogenous detritus input was much higher in seagrass MO ($1546.1 \text{ mgC m}^{-2} \text{d}^{-1}$) than in mudflat MO ($308.0 \text{ mgC m}^{-2} \text{d}^{-1}$) and all habitats of the Sylt-Rømø Bight ($39.2\text{--}54.0 \text{ mgC m}^{-2} \text{d}^{-1}$). Similarly, detritus export was three to five times higher in seagrass MO ($1866.8 \text{ mgC m}^{-2} \text{d}^{-1}$) than in all other habitats ($390.0\text{--}571.9 \text{ mgC m}^{-2} \text{d}^{-1}$).

TEs of meiofauna (23.1–27.9%) were higher than of macrofauna in the Sylt-Rømø Bight (5.1–12.9%), whereas TEs of meiofauna (11.0–17.3%) in the Marennes-Oléron Bay were slightly lower than TEs of macrofauna (21.6–27.9%). Meiofauna from mudflat MO had much higher losses due to respiration compared to meiofauna in all other habitats (Appendix 5.9). Respiration of meiofauna in mudflat MO represented 15% of the total system respiration, which was much higher than in other habitats (1.1–2.1%). Egestion of meiofauna had relatively higher contributions to total system egestion in all habitat (18.1–38.2%), except for the sandflat of the Sylt-Rømø Bight (5.5%). Macrofauna had low proportions of respiration (2.0–10.1%) and egestion (2.0–4.4%) in the Marennes-Oléron Bay compared to the Sylt-Rømø Bight (respiration: 32.3–58.5%, egestion: 36.3–51.2%).

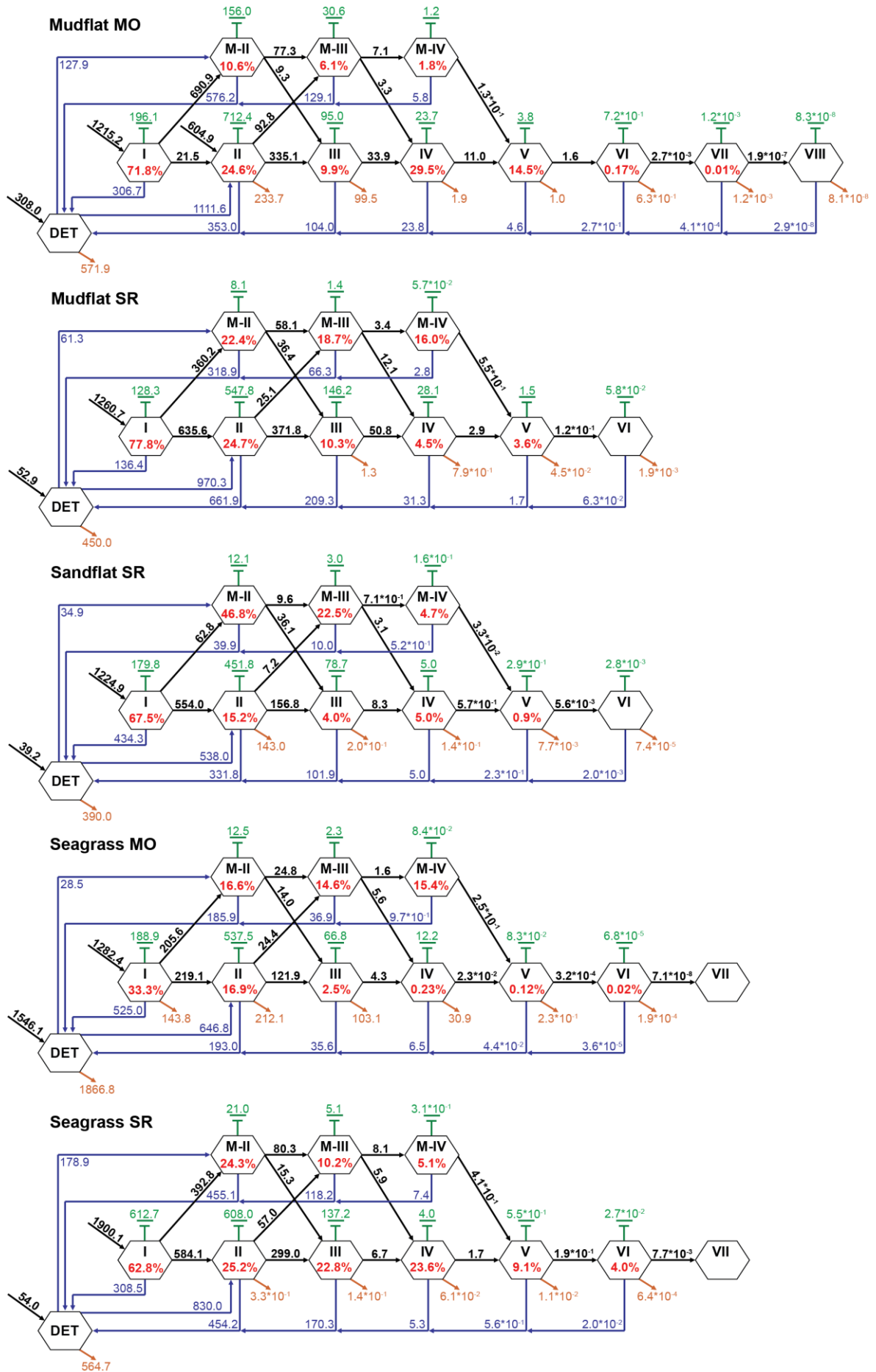

Figure 5.7. Modified Lindeman spine describing food webs of the mudflats, seagrass beds, and sandflat in the Marennes-Oléron Bay (MO) and the Sylt-Rømø Bight (SR). Boxes separated between integer trophic levels with meiofauna (“M” followed by roman numbers) and integer trophic levels with remaining compartments (roman numbers). Percentages refer to the trophic transfer efficiency. Black arrows indicate energy flows between trophic levels as well as imports. Export flows are indicated using brown arrows and flows from and to detritus (DET) are indicated using blue arrows. Green ground symbols display energy losses due to respiration. All values are given in $\text{mgC m}^{-2} \text{d}^{-1}$.

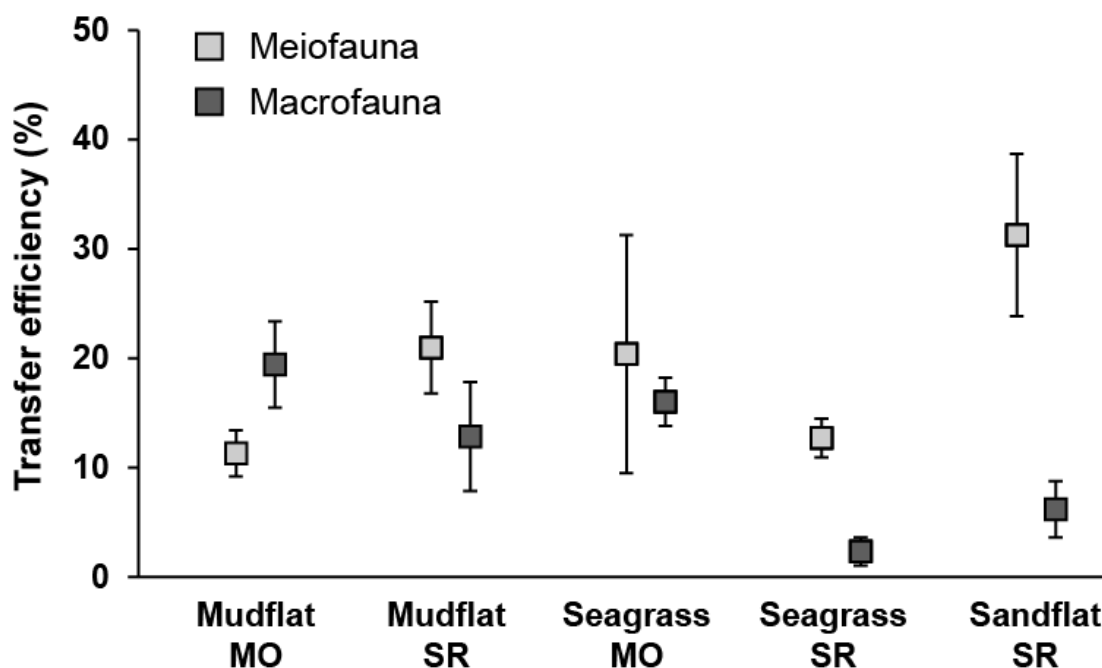

Figure 5.8. Transfer efficiencies of meiofauna and macrofauna of the mudflats, seagrass beds, and sandflat in the Marennes-Oléron Bay (MO) and the Sylt-Rømø Bight (SR).

TEs of meiofauna trophic groups were similar within the mudflat SR and seagrass SR, however, were more variable in mudflat MO, seagrass MO and sandflat SR (Appendix 5.13). Epigrowth feeders, omnivores/predators and benthic copepods had higher TEs than selective deposit feeders and non-selective deposit feeders in sandflat SR and seagrass MO. In mudflat MO omnivores/predators and benthic copepods had much lower TEs compared to other nematode feeding groups.

3.7. Trophic levels and feeding types

Meiofauna trophic groups had effective trophic levels (TL) ranging from 2.0 (non-selective deposit feeders, mudflat SR) to 2.8 (selective deposit feeders, mudflat MO; Table 5.3). Benthic copepods, non-selective deposit feeding and epigrowth feeding nematodes had the lowest TLs and were similar between habitats ranging from 2.0 to 2.1. Selective deposit feeding nematodes and omnivorous/predating nematodes had much higher TLs with highest values for omnivores/predators in

all habitats (2.5–2.7), except in mudflat MO where TL of selective deposit feeders was 2.8. Compared to other trophic groups much higher variability was observed in TLs of selective deposit feeders, with higher TLs in the Marennes-Oléron Bay (2.5–2.8) compared to the Sylt-Rømø Bight habitats (2.2).

Non-selective feeding nematodes (0.03–0.08), epigrowth feeding nematodes (0.03–0.08) and benthic copepods (0.05–0.10) were characterized by low omnivory. Contrarily, selective deposit feeding nematodes and omnivorous/predating nematodes had relatively higher omnivory index which ranged from 0.16 to 0.25 and from 0.26 to 0.31, respectively (Table 5.3).

Meiofauna detritivory/herbivory ratios ranged from 0.14 (seagrass MO) to 0.57 (sandflat SR), with meiofauna in the Sylt-Rømø Bight habitats having the highest ratios (Table 5.3, lowest delta-value: 0.155, Appendix 5.10). Detritivory/herbivory ratios were much lower for meiofauna compared to macrofauna (0.31-1.26, Appendix 5.14) and the whole food web (0.38-1.32, Appendix 5.11) in each of the habitats. Bacterivory/herbivory ratios of meiofauna (0.07-0.15) were similar (Marennes-Oléron Bay) or smaller (Sylt-Rømø Bight) than detritivory/herbivory ratios, with the lowest ratios measured in mudflat SR (0.07) (Table 5.3, lowest delta-value: 0.669, Appendix 5.10). Bacterivory/herbivory ratios of macrofauna, ranging from 0.15 (seagrass MO) to 0.54 (sandflat SR), were higher than those of meiofauna.

Table 5.3. Mean trophic levels and omnivory indices for trophic groups of nematodes and benthic copepods (COP) and detritivory/herbivory (D/H) and bacterivory/herbivory (B/H) ratios for meiofauna in the mudflats, seagrass beds, and sandflat in the Marennes-Oléron Bay (MO) and the Sylt-Rømø Bight (SR). Trophic groups of nematodes are selective deposit feeders (NBA), non-selective deposit feeders (NDF), epigrowth feeders (NBA) and omnivores/predators (NOM). Letters displayed next to ratios indicate groups of samples with similar values using Cliff's delta statistics.

	Mean trophic level					Omnivory index					D/H ratio	B/H ratio
	NBA	NDF	NEF	NOM	COP	NBA	NDF	NEF	NOM	COP	Meiofauna	Meiofauna
Mudflat MO	2.8	2.1	2.1	2.6	2.1	0.18	0.05	0.07	0.30	0.08	0.19 ^A (± 0.04)	0.13 ^A (± 0.01)
Mudflat SR	2.2	2.0	2.0	2.7	2.1	0.17	0.03	0.03	0.26	0.08	0.18 ^A (± 0.04)	0.07 ^B (± 0.02)
Seagrass MO	2.5	2.1	2.0	2.7	2.1	0.25	0.08	0.04	0.26	0.05	0.14 ^C (± 0.03)	0.12 ^C (± 0.02)
Seagrass SR	2.2	2.1	2.1	2.7	2.1	0.16	0.07	0.08	0.27	0.10	0.46 ^D (± 0.11)	0.15 ^A (± 0.05)
Sandflat SR	2.2	2.1	2.1	2.5	2.1	0.19	0.05	0.07	0.28	0.06	0.57 ^E (± 0.17)	0.12 ^C (± 0.04)

More specialized feeding behavior was observed for meiofauna compared to macrofauna (Fig. 5.9). Flows of energy from food sources to macrofauna highlighted much larger flow values in the Sylt-Rømø Bight than in the Marennes-Oléron Bay. For meiofauna, herbivory was related to feeding merely on microphytobenthos (62.8 to 690.9 mgC m⁻² d⁻¹) and the highest computed carbon flow was from microphytobenthos to meiofauna in mudflat MO. Carbon flows from microphytobenthos to

macrofauna were lower than to meiofauna in all habitats, except in mudflat SR ($398.2 \text{ mgC m}^{-2} \text{ d}^{-1}$). Carbon flows from detrital origin to meiofauna (i.e., sum of SOM and SPOM) were much lower than those from microphytobenthos to meiofauna, with the highest of such flows observed in mudflat MO ($127.9 \text{ mgC m}^{-2} \text{ d}^{-1}$) and seagrass SR ($178.9 \text{ mgC m}^{-2} \text{ d}^{-1}$). Detritivory of macrofauna was higher than that of meiofauna, mainly due to a higher reliance of macrofauna on SOM. Flows of bacteria to meiofauna were much lower than those of bacteria to macrofauna in the Sylt-Rømø Bight, but similar in seagrass MO and even higher in mudflat MO ($92.8 \text{ mgC m}^{-2} \text{ d}^{-1}$). Flows from seagrass material towards consumers were very low.

Total flows of carbon from microphytobenthos to benthic secondary consumers, i.e., meiofauna and macrofauna, were higher than flows from bacteria or SOM in the Marennes-Oléron Bay habitats (Appendix 5.9). In these habitats carbon flows of microphytobenthos account for about 70% of total sum of flows. Carbon flows from food sources to benthic consumers in the Sylt-Rømø Bight habitats were originating from more diverse sources such as microphytobenthos (21.4–42.9%), SOM (18.1–25.2%), bacteria (9.7–21.1%) and phytoplankton (3.0–10.3%).

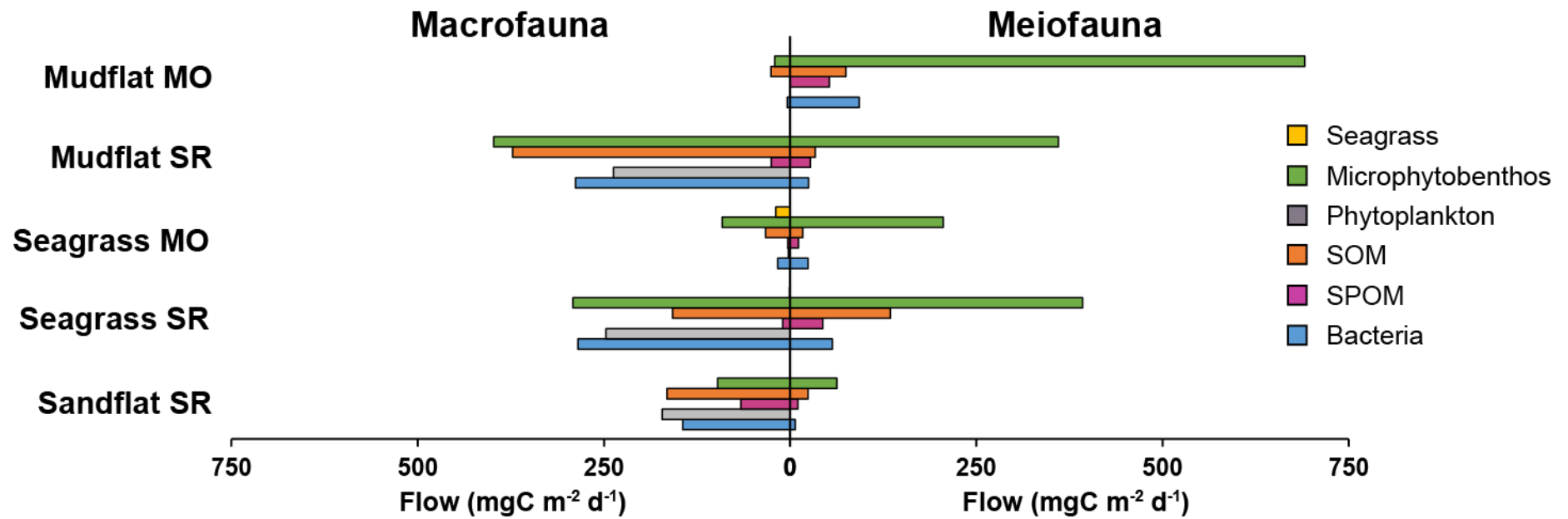

Figure 5.9. Flows of carbon from food source to meiofauna and macrofauna in the mudflats, seagrass beds, and sandflat in the Marennes-Oléron Bay (MO) and the Sylt-Rømø Bight (SR). SOM = sediment organic matter, SPOM = suspended particulate organic matter.

Carbon flows highlighted large fluxes from microphytobenthos to several trophic groups of meiofauna, especially to non-selective deposit feeding nematodes ($15.4\text{--}290.8 \text{ mgC m}^{-2} \text{ d}^{-1}$), epigrowth feeding nematodes ($9.9\text{--}314.6 \text{ mgC m}^{-2} \text{ d}^{-1}$) and benthic copepods ($1.8\text{--}29.3 \text{ mgC m}^{-2} \text{ d}^{-1}$, Fig. 5.10, Appendix 5.9). Omnivorous/predating nematodes relied on microphytobenthos ($7.8\text{--}56.3 \text{ mgC m}^{-2} \text{ d}^{-1}$) as well as on other meiofauna ($10.3\text{--}88.4 \text{ mgC m}^{-2} \text{ d}^{-1}$), whereas selective deposit feeding nematodes relied on more variable food sources. Selective deposit feeders relied most on bacteria in the Marennes-Oléron Bay habitats ($8.2\text{--}34.9 \text{ mgC m}^{-2} \text{ d}^{-1}$), whereas they relied more on microphytobenthos in the Sylt-Rømø Bight habitats ($0.5\text{--}16.1 \text{ mgC m}^{-2} \text{ d}^{-1}$). Lower contributions of bacteria were observed in the Sylt-Rømø Bight ($0.5\text{--}7.5 \text{ mgC m}^{-2} \text{ d}^{-1}$), whereas microphytobenthos was the second most important contributor to these nematodes in the Marennes-Oléron Bay habitats ($5.7\text{--}6.8 \text{ mgC m}^{-2} \text{ d}^{-1}$).

Dependency ratios of benthic copepods, non-selective deposit feeders, epigrowth feeders and omnivores/predators, ranging from 0.75 (benthic copepods, seagrass SR) to 0.96 (non-selective deposit feeders, mudflat MO), demonstrated that these trophic groups depend mostly on microphytobenthos in all habitats (Appendix 5.15). Dependency ratios to other food sources were lower, ranging from 0.04 (epigrowth feeders, seagrass MO) to 0.50 (epigrowth feeders, seagrass SR) for SOM and from 0.00 to 0.18 for other food sources (i.e., benthic bacteria, SPOM, seagrass material). Selective deposit feeders depended on a large diversity of food sources (i.e., microphytobenthos, SOM and bacteria) in all habitats, except in seagrass MO where they depended equally on bacteria and microphytobenthos.

Carbon flows from food sources to macrofauna (Appendix 5.9) as well as dependency ratios of macrofauna (Appendix 5.16) indicated much more variability in food sources with no clear dependency on a specific food source.

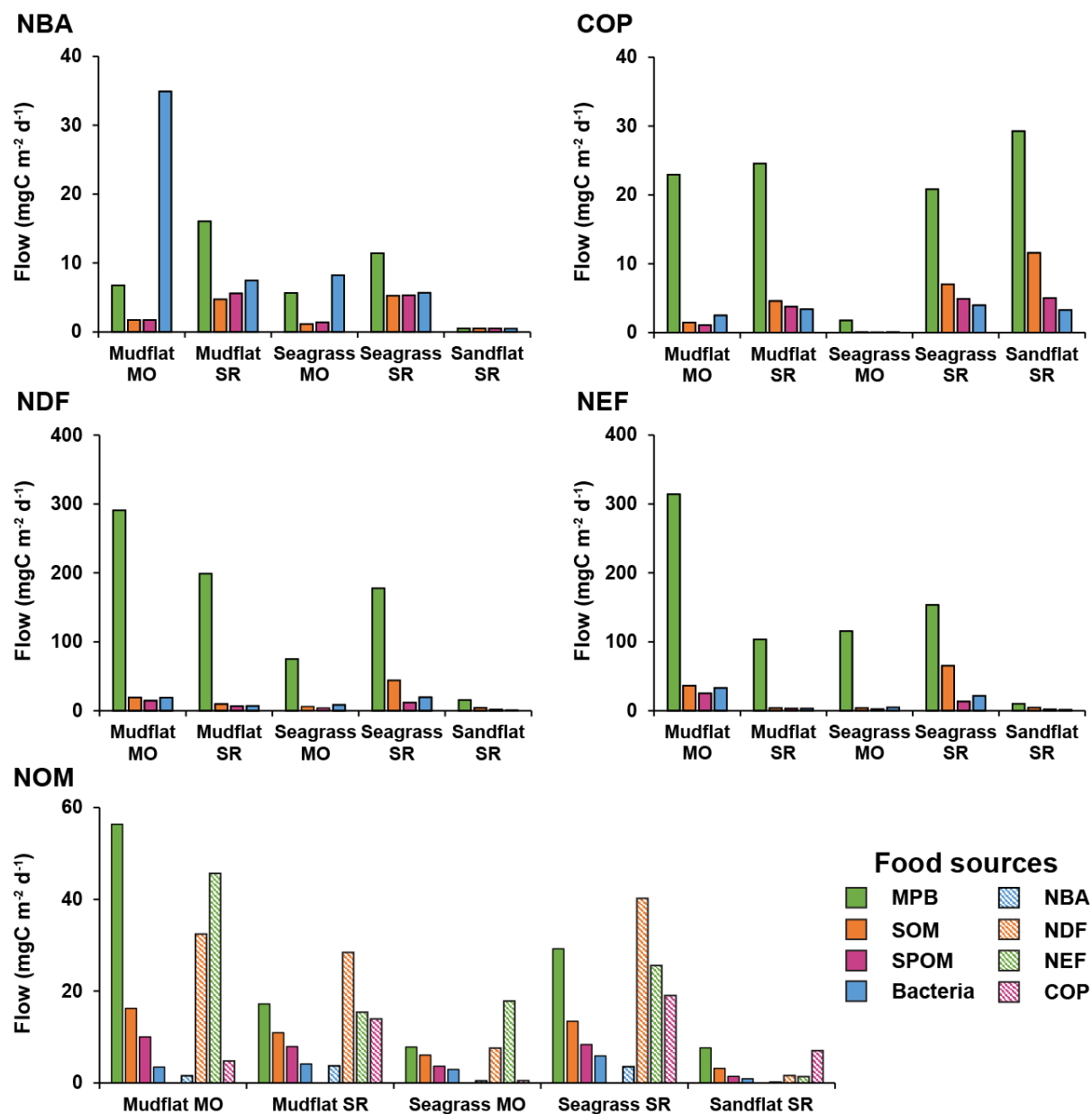

Figure 5.10. Flows of carbon from food source to selective deposit feeding nematodes (NBA), non-selective deposit feeding nematodes (NDF), epigrowth feeding nematodes (NEF), benthic copepods (COP) and omnivorous/predating nematodes (NOM) in the mudflats, seagrass beds, and sandflat in the Marennes-Oléron Bay (MO) and the Sylt-Rømø Bight (SR). MPB = microphytobenthos, SOM = sediment organic matter, SPOM = suspended particulate organic matter.

4. DISCUSSION

4.1. Comparisons of intertidal food webs

Food web models of the mudflats, seagrass beds and sandflat in the Marennes-Oléron Bay and the Sylt-Rømø Bight had higher $T..$ and R/C , and lower FCI when compared to ENA indices previously estimated for these food webs (Baird et al., 2007; Degré et al., 2006; Leguerrier et al., 2003; Pacella et al., 2013).

The low $T..$ values characterizing the sandflat and mudflat of the Sylt-Rømø Bight was related to the lower primary production and/or lower exogenous flows in these habitats (Baird et al., 2007). Primary production of microphytobenthos represented the highest carbon flow in all habitats, except for the seagrass bed of the Marennes-Oléron Bay where it was the second one after exogenous flows. All these intertidal soft-bottom food webs therefore mostly relied on autochthonous production as also observed by van Oevelen et al. (2006) and Pacella et al. (2013).

Total system through-flows (TST) in the Sylt-Rømø Bight mudflat were comparable to previously estimated values (Baird et al., 2007). TST of the sandflat and the seagrass bed of the Sylt-Rømø Bight were lower than previous estimated values (Baird et al., 2007). Higher TST was observed in the Marennes-Oléron Bay mudflat compared to the value from Leguerrier et al. (2003) due to higher throughputs of phytoplankton, SOM, SPOM, pelagic bacteria and meiofauna. The much higher biomass of meiofauna used in our study can result in much higher throughput of meiofauna and indirectly increase the throughput of bacteria and SOM, on which they feed. The opposite pattern was observed in the Marennes-Oléron Bay seagrass bed where lower $T..$, when compared to the $T..$ from Pacella et al. (2013), was related to decreasing throughput of bacteria, meiofauna and benthic fish.

Recycling in a system is strongly linked to the movement of detritus between compartments (Saint-Béat et al., 2015). The low cycling in the seagrass bed of the Marennes-Oléron Bay could be related to the lower degree of detritivory compared to the other habitats. Cycling was generally lower for all five habitats compared to previous studies from these systems (Baird et al., 2007; Leguerrier et al., 2003; Pacella et al., 2013). This pattern seemed to partly be due to the integration of detailed information on the feeding ecology of meiofauna leading to (I) higher fluxes of carbon from microphytobenthos to meiofauna and (II) the lowering of carbon fluxes involved in the cycling pathway (i.e., lower consumption of detritus and/or bacteria), both events reducing FCI in studied systems. This highlights how sensitive the determination of ecosystem characteristics can be to the level of information included in the models.

Low cycling can be a characteristic of a low system maturity (Odum, 1969; Vasconcellos et al., 1997), although debated (Baird et al., 2007; Christensen, 1995; Saint-Béat et al., 2015). Because mature systems have a higher capacity to recycle material they are more likely to recover from perturbations (Vasconcellos et al.,

1997). Another indicator of system maturity, the omnivory index (McCann and Hastings, 1997), indicated a moderate maturity in our studied systems (0.105–0.162) when compared to several different systems, such as bays (0.009 – 0.177, Rybarczyk et al., 2003; Tecchio et al., 2015), estuaries (~0.10–0.30, Monaco and Ulanowicz, 1997; Tecchio et al., 2016), sandy beaches (0.0007–0.037, Lercari et al., 2010) and coastal lagoons (0.092, Gamito and Erzini, 2005). However, as for cycling, there are still some uncertainties in the role of omnivory in ecosystem dynamics (Saint-Béat et al., 2015).

Contrarily to cycling, the relative redundancy of these food webs were higher when compared to previously estimated values (Baird et al., 2007; Pacella et al., 2013), with highest redundancy for the seagrass bed of the Marennes-Oléron Bay. Higher R/C proportions indicates a higher resilience of a system (Virgo et al., 2006), which is caused by a high number of parallel trophic pathways enabling the system to rely on the remaining pathways to function when other parallel pathways are restrained (Ulanowicz, 2004). As a result, high R/C proportions in all habitat food webs indicate they all were relatively stable: the most stable one being the seagrass bed of the Marennes-Oléron Bay (i.e., highest R/C). The opposite pattern between low maturity (i.e., low FCI and SOI) and high resilience (high R/C) highlights the importance to further assess the system stability and maturity by using ENA indices, as highlighted by Saint-Béat et al. (2015).

4.2. The effects of aggregating and splitting compartments

Aggregating macrofauna species into four compartments and splitting meiofauna into five compartments was required to compare the indices and flow outputs between the different models. These modifications indirectly resulted in slight changes of ENA indices (e.g. throughputs, lower cycling and higher redundancy) and carbon flows compared to previous models (Baird et al., 2007; Leguerrier et al., 2003; Pacella et al., 2013). The effect on T.. was very small in the Sylt-Rømø Bight food webs (Baird et al., 2009, 2007) and the lower values in the Marennes-Oléron Bay seagrass bed (Pacella et al., 2013) were rather considered to be related to changes of biomass.

The cycling values on the other hand were lower than those of previous models (Baird et al., 2007; Leguerrier et al., 2003; Pacella et al., 2013), which could be partially related to aggregating or splitting of compartments (Baird et al., 2009). The slight modifications of the original Marennes-Oléron Bay food web models might have affected the cycling as well, e.g. by the reduced bacteria biomass in the Marennes-Oléron Bay seagrass bed model or by revising values from Degré et al. (2006) and Saint-Béat et al. (2014) for the Marennes-Oléron Bay mudflat model.

Finally, the relatively higher R/C determined in this study compared to previous food web models (Baird et al., 2007; Leguerrier et al., 2003; Pacella et al., 2013), indicating increased stability of food webs, is partially related to the splitting of the meiofauna into five trophic groups (Baird et al., 2009). Multiple compartments of meiofauna indeed divided the flows going from primary producers, bacteria and detritus to

meiofauna into several parallel pathways, as well as increased the pathways from meiofauna to higher trophic levels. The redundancy is especially higher in our food web models as the meiofauna is characterized by a diversity of trophic groups, which can rely on similar food sources (van der Heijden et al. submitted) and who in turn can be preyed upon by similar consumers (Coull, 1999). High diversity could result in a higher redundancy index (Chapin III et al., 2000; Saint-Béat et al., 2015). Taken together, these changes in indices highlight the importance of making similar aggregations for meiofauna (Johnson et al., 2009) as it has been the case for macrofauna (Saint-Béat et al., 2013). Due to the effects of aggregating and/or splitting compartments on several indices (Baird et al., 2009; Johnson et al., 2009), caution was taken when comparing indices with previously estimated values.

4.3. Central role of meiofauna in soft-bottom coastal food webs: high production

Meiofauna play a very important role in the functioning of the five intertidal habitats, as highlighted by their high production ($14\text{--}36 \text{ mgC m}^{-2} \text{ d}^{-1}$) and P/B ratios ($0.03\text{--}0.28 \text{ d}^{-1}$). Meiofauna production were either similar (the seagrass bed of the Marennes-Oléron Bay and the mudflat of the Sylt-Rømø Bight), or higher (2 to 9 times, all other habitats), than macrofauna production (Appendix B.6), and generally agreed well with previous estimations ($10 \text{ to } 80 \text{ mgC m}^{-2} \text{ d}^{-1}$) (Chardy and Dauvin, 1992; Danovaro et al., 2002; Escaravage et al., 1989). Their higher production combined with similar and/or lower biomass resulted in much higher P/B than macrofauna, i.e. from 4 to 1000 times. The meiofauna P/B ratios in the Marennes-Oléron Bay and the sandflat and seagrass bed of the Sylt-Rømø Bight of were in the same range as observed in two other bays along the French Atlantic coast (Chardy et al., 1993; Chardy and Dauvin, 1992). In the mudflat of the Sylt-Rømø Bight, however, the P/B ratios of meiofauna were much higher. Higher production and P/B ratios of meiofauna compared to macrofauna is known to be related to their higher weight-specific metabolic rate (Kuipers et al., 1981), shorter turn-over time (Gerlach, 1971; Kuipers et al., 1981) and shorter generation time (Moens and Vincx, 1997b; Vranken and Heip, 1986). The biomass/production ratio (B/P), which can be used as a rough measure of turnover time (Sundbäck et al., 1996), indicated that the turnover times of meiofauna (4–37 days) were much lower than those of macrofauna (150–10,000 days), as demonstrated before for smaller organisms (Tumbiolo and Downing, 1994). The short turnover times of meiofauna was also reflected in the higher throughput per gram of consumer (0.7–4.7), which was between 10 and 70 times higher than those of macrofauna. Further related to their smaller body size (Kleiber, 1932) meiofauna metabolic rate can be up to 21 times higher than for macrofauna (Kuipers et al., 1981). High metabolism of meiofauna compared to macrofauna was also observed by Carey (1967) who determined that meiofauna and bacteria are together consuming the major proportion of energy from the benthos. Indeed, Warwick and Price (1979) estimated that meiofauna can consume two times and produce four times more than macrofauna, despite representing only half of the macrofauna biomass. High consumption by meiofauna was also observed in the Marennes-Oléron Bay where throughput was two to tenfold higher than that of macrofauna, whereas biomass was similar (mudflat) or even a 15-fold lower (seagrass). In the Sylt-Rømø Bight habitats on the other hand, meiofauna

throughput was lower than that of macrofauna (between 1.5 and 6.5 times) seemingly as a result of a much lower biomass (100- to 200-fold) than that of macrofauna.

4.4. Central role of meiofauna in soft-bottom coastal food webs: trophic intermediary position

Meiofauna also play a major role in the different studied food webs as they represent very important trophic mediators between primary production and higher consumers, as highlighted by the dependency ratios and flows to and from the meiofauna. The role of meiofauna as a mediator is enhanced by the different feeding types of meiofauna as reflected within the various integer trophic levels. Integer trophic levels II of meiofauna in modified Lindeman spines were indeed an important compartment in the transfer of carbon from trophic levels I, i.e., primary producers, towards higher trophic levels ($63\text{--}691 \text{ mgC m}^{-2} \text{ d}^{-1}$). The relative consumption on primary producers by meiofauna is high (19–97 %) when compared to the ingestion of primary producers by macrofauna, especially when considering their much lower biomass. Trophic levels III of meiofauna were important as well, as demonstrated by the consumption of bacteria ($7\text{--}93 \text{ mgC m}^{-2} \text{ d}^{-1}$), the consumption of omnivorous/predating nematodes on other meiofauna ($10\text{--}88 \text{ mgC m}^{-2} \text{ d}^{-1}$) and the through flow towards higher trophic levels ($13\text{--}49 \text{ mgC m}^{-2} \text{ d}^{-1}$). Meiofauna has a high nutritional value (Coull, 1999) and their concentration in the very top sediment layer make them a very available and valuable food source to consumers (Castel et al., 1989; Leduc and Probert, 2011; van der Heijden et al., 2018). The important role of meiofauna as a food source for benthic feeding fish (e.g. mullets, gobies, flatfish, grunts and croakers) was demonstrated in mudflats (Carpentier et al., 2014; Gordon and Duncan, 1979; Lassere et al., 1975; Smith and Coull, 1987; Smith et al., 1984), sandflats (Castel and Lassere, 1982; Gee, 1987; Hicks, 1984; Pihl, 1985) and salt marshes (Lebreton et al., 2013, 2011b). However, the exact fate of meiofauna remains unclear (Giere, 2009) and further research should focus on the flows from meiofauna to higher trophic levels in food webs.

Comparison between habitats highlighted that channeling of the flows of organic matter through meiofauna was slightly higher than channeling through macrofauna in the Sylt-Rømø Bight and slightly lower in the Marennes-Oléron Bay. TEs of meiofauna (23–28%) were indeed higher than TEs of macrofauna (5–13%) in the Sylt-Rømø Bight, whereas meiofauna TEs (11–17%) were lower than macrofauna TEs (22–28%) in the Marennes-Oléron Bay. Short turnover times of microphytobenthos and bacteria in the Sylt-Rømø Bight may partly explain the higher TEs of meiofauna in the latter ecosystem compared to the Marennes-Oléron Bay. However, it is important to highlight that slight differences in constraints between models may affect their outcomes, and therefore TEs. As a result, the highest possible coherency should be pursued when selecting model constraints to improve the accuracy of food web models and to make them comparable.

4.5. Reliance on microphytobenthos

Meiofauna mostly relied on microphytobenthos in all habitats, whereas macrofauna relied on a wider variety of food sources. The high reliance of meiofauna on microphytobenthos confirmed the outcomes of the combined trophic marker approach carried out by van der Heijden et al. (submitted). Microphytobenthos has

a pivotal role as a food source in marine systems and mudflats in particular, and their importance for the food web functioning of the mudflat of the Marennes-Oléron Bay has previously been highlighted (Leguerrier et al., 2003; Pacella et al., 2013). Their importance as a food source likely stem from its short turnover times (0.1–8.9 days) and high production (774–1215 mgC m⁻² d⁻¹). More importantly so, these rates (Degré et al., 2006) and their biomass (Lebreton et al., 2009; van der Heijden et al., 2018) are generally constant all year round, resulting in a reliable food source all year round. Microphytobenthos also has a high nutritional quality (Cebrián, 1999), opposed to seagrass material which has a low nutritional value (Vizzini et al., 2002) and follow strong seasonal fluctuations in biomass (van der Heijden et al., 2018) and is therefore poorly used by both meiofauna and macrofauna (Lebreton et al., 2011a). Meiofauna is even known to actively migrate towards high quality food source (Moens et al., 1999). Moreover, certain nematodes have buccal cavities suitable for consumption of microphytobenthos (i.e., epigrowth feeders, Moens and Vincx, 1997a; Wieser, 1953), as they use a tooth to pierce diatoms, making these food items easy to assimilate.

Comparisons between habitats highlighted much shorter turnover times of microphytobenthos in the Sylt-Rømø Bight (0.1–0.2 days) than in the Marennes-Oléron Bay (2.6–8.9 days). These turnover times were in the range of those measured in other European estuarine mudflats (~ 3 days) (Admiraal et al., 1982). A similar pattern was observed for another important food source of meiofauna, bacteria, which partly use microphytobenthos as a substrate (Boschker et al., 2000; van der Heijden et al. submitted). Bacteria had shorter turnover times as well in the Sylt-Rømø Bight (1.8–4.2 days) than in the Marennes-Oléron Bay (9.8–23.0 days). These shorter turnover times in the Sylt-Rømø Bight could be caused by higher consumption rates (Asmus and Asmus, 1985), which could have a positive feedback on bacteria and microphytobenthos productions (Blanchard et al., 2001; Fenchel and Jorgensen, 1977). Differences in physical parameters, such as lower resuspension and turbulence in the Sylt-Rømø Bight (Dame and Prins, 1998; Widdows et al., 2008) and/or less stable sediment (Dolch and Hass, 2008; Mielck et al., 2015), could also result in lower turnover times.

4.6. Differences of food source reliance between meiofauna feeding types

The degree of which meiofauna relied on microphytobenthos differed depending on meiofauna feeding types. Non-selective deposit feeding nematodes, epigrowth feeding nematodes and benthic copepods had a high reliance on microphytobenthos as indicated by carbon flows (2–314 mgC m⁻² d⁻¹) as well as their dependency ratios to microphytobenthos (0.75–0.96). For these groups, most of the carbon was originating from microphytobenthos (56 to 91%) in all habitats, highlighting that these feeding types relied mostly on high quality food sources (Cebrián, 1999). The importance of microphytobenthos as a food source has been demonstrated through grazing experiments on epigrowth feeders and benthic copepods (Rzeznik-Orignac and Fichet, 2012) which is in agreement with epigrowth feeders buccal cavity morphology optimized for consumption of microphytobenthos (Wieser, 1953). Higher relative reliance on SOM for non-selective deposit feeders, epigrowth feeders and benthic copepods in the sandflat and seagrass bed in the Sylt-Rømø Bight

(dependency ratio: 0.33–0.50) could be related to the high quality of the organic matter in these habitats (van der Heijden et al., 2018). Also omnivorous/predating nematodes relied largely on carbon of microphytobenthos origin as well, as indicated by their dependency ratios (0.77–0.92). Their relatively higher omnivory index compared to other groups of meiofauna highlighted that these consumers relied both directly and indirectly on microphytobenthos, through predation on lower meiofauna trophic groups (i.e., non-selective deposit feeders and epigrowth feeders) (Rzeznik-Orignac et al., 2008; Vafeiadou et al., 2014; van Oevelen et al., 2006), themselves feeding on microphytobenthos.

Selective deposit feeding nematodes relied on a larger variety of food sources, as highlighted by their relatively higher omnivory indices and similar values of carbon flows originating from benthic bacteria, SOM as well as microphytobenthos. Similar to epigrowth feeders, their buccal cavity morphology is adapted to efficiently feed on bacteria (Wieser, 1953) which was confirmed by the high reliance on bacteria. The isotope composition of bacteria used to determine feeding constraints with mixing models was coming from sulfide-oxidizing bacteria (Vafeiadou et al., 2014). However, van der Heijden et al. (submitted) suggested that these consumers mostly fed on another pool of bacteria, who in turn relied mainly on microphytobenthos and SOM. This suggests that the role of bacteria as a food resource for meiofauna may be underestimated, especially for selective deposit feeders. This can also explain the high dependence of this group on microphytobenthos and SOM, as it was computed via our models. These results highlight the importance of considering all potential food sources when determining trophic relationships. We also demonstrate here that aggregating meiofauna trophic groups into a single compartment should be avoided whenever possible, as meiofauna can rely on very different food resources. As a result, this compartment should be treated in a similar way as macrofauna.

4.7. Ecosystem functions provided by meiofauna

Meiofauna has impacts on the functioning of ecosystems as well as for human societies in multiple ways (Schratzberger and Ingels, 2017). In this work we found important ecosystem functions related to meiofauna, as partly discussed above. Firstly, through the high carbon flow that meiofauna channels from primary producers (i.e. microphytobenthos, 63–691 mgC m⁻² d⁻¹) and bacteria (7–93 mgC m⁻² d⁻¹) towards higher trophic levels (10–88 mgC m⁻² d⁻¹). Utilization of available primary sources is essential for a well functioning food web, and provision of food resources to human societies via fisheries (Schratzberger and Ingels, 2017). Secondly, meiofauna's high production (14–36 mgC m⁻² d⁻¹) and short turnover time (4–37 days). The turnover times were between four and 1000 times shorter than those of macrofauna, clearly highlighting how this compartment may contribute to the food web dynamics. Especially since meiofauna constitutes a food source of high quality for higher trophic levels due to their high nitrogen content (Couch, 1989; Coull, 1999; Sikora et al., 1977) and their ability to biosynthesize highly unsaturated fatty acids (Braeckman et al., 2015; Leduc, 2009). Therefore, in combination with their high production and short turnover time they benefit higher trophic levels, such as fish or shrimps (Coull, 1999), and in the next step human societies who rely on fisheries. Thirdly, meiofauna can also affect the sediment stability

(Schratzberger and Ingels, 2017). Intensive grazing on microalgae, as shown in this work, could indeed affect sediment processes by removing the microphytobenthos, a main contributor of sediment stability (de Deckere et al., 2001; Moens et al., 2002). The meiofauna grazing also contributes to the redistribution of the microfauna to nutrient rich places, the enhanced mineralization of organic matter and the excretion of nutrients due to grazing (de Mesel et al., 2004; Montagna, 1984; Nascimento et al., 2012)

Finally, our results suggests that meiofauna may play an important role in the food web stability. More parallel pathways, due to splitting meiofauna into trophic groups, resulted in a higher redundancy of the food webs compared to previous studies (Baird et al., 2007; Leguerrier et al., 2003; Pacella et al., 2013) and higher redundancy has been considered to represent a more stable ecosystem.

5. CONCLUSION

Food web models highlighted the importance of the trophic pathway between microphytobenthos and meiofauna in soft-bottom intertidal habitats. Microphytobenthos was indeed the most important primary producer and the most important food resource for meiofauna in these habitats ($63\text{--}691\text{ mgC m}^{-2}\text{ d}^{-1}$), even when high loads of seagrass material were present. The important role of meiofauna was highlighted by their high production ($14\text{--}36\text{ mgC m}^{-2}\text{ d}^{-1}$) and throughput ($115\text{--}996\text{ mgC m}^{-2}\text{ d}^{-1}$). As a result, meiofauna is responsible for a large part of the production as well as carbon flows from microphytobenthos towards higher trophic levels in intertidal soft-bottom habitats, while the slower-growing macrofauna is more accountable for energy storage and relies on a larger diversity of food sources. These two compartments therefore appear to provide complementary ecosystem functions.

The importance of the trophic pathway between microphytobenthos and meiofauna was observed in each studied habitat, even if these habitats were characterized by strong differences in terms of food sources. Differences between habitats in terms of production, P/B ratios and transfer efficiencies were also observed, partly due to different biomass of meio- and macrofauna resulting in differences in respiration, consumption and egestion of meiofauna, and partly due to different model parameters. Nevertheless, besides the effect of these differences on the models (i.e., maybe leading to potential technical issue), the role of meiofauna was still very important in the functioning of all studied habitats, indicating that our conclusions about the important role of the meiofauna are quite robust.

Nevertheless, this study highlights the importance of consistency when constructing and comparing food web models. Using the same type of constraints when constructing models can result in a more reliable comparison between food webs. Further, more precise determination of these constraints will also result in more precise quantification of carbon fluxes. Using outputs from mixing models with data from both stable isotopes and fatty acid analyses could result in higher precision, e.g. on the role of bacteria within these food webs.

Most trophic groups of meiofauna revealed a high reliance on microphytobenthos in all habitats ($2\text{--}314\text{ mgC m}^{-2}\text{ d}^{-1}$), where flows of carbon were direct (herbivory) or indirect (carnivory). Merely, selective deposit feeders relied on a larger variety of food source with highest dependencies varying between microphytobenthos, bacteria and SOM. These differences in feeding behavior justify the splitting of meiofauna into different compartments, as is traditionally done for macrofauna in most studied food webs. We therefore argue that these feeding types of meiofauna should be considered as separate compartments in future studies.

We clearly highlighted the importance of the trophic pathway from microphytobenthos to meiofauna in this study. In the next step, to better determine the fate of meiofauna within benthic ecosystems could provide an even better understanding of their role in the functioning of coastal habitats. Nematodes, which are

considered a food source of high nutritional value for higher trophic value (Braeckman et al., 2015; Leduc, 2009), has the potential to represent an important food source. So far, most studies in coastal habitats used stomach content analyses to determine the consumption on meiofauna by benthic fish (Alheit and Scheibel, 1982; Coull, 1999; Gee, 1989, 1987; Hicks, 1984; Smith and Coull, 1987). However, these might underestimate the contribution of nematodes as a food source to fish due to a quicker digestion of nematodes compared to benthic copepods (Scholz et al., 1991). Better assessment of the fate of meiofauna could be realized by combining molecular techniques, trophic markers and stomach content analyses and use the outcomes as constraints into existing food web models.

APPENDIX: CHAPTER 5

Appendix 5.1. Equations used for the linear inverse modeling of the mudflat in the Marennes-Oléron Bay (MO), France, from Leguerrier et al. (2003).

Compartments	Equation	Sources
Microphytobenthos	Production = 372 g C m ⁻² yr ⁻¹	Blanchard et al. (1997)
Zooplankton	Production = biomass * 56 (yr ⁻¹) Respiration = biomass * 112 (yr ⁻¹)	Averaged after Sautour and Castel (1998, 1993a, 1993b) Newell and Linley (1984)
Pelagic bacteria	Production = consumption * 0.31	Newell and Linley (1984)
Suspension feeders	Pelagic consumption = benthic consumption	Leguerrier et al. (2003)
Birds	Assimilation efficiency = 85%	Leguerrier et al. (2003)

Appendix 5.2. Inequalities used for the linear inverse modeling of the mudflat in the Marennes-Oléron Bay, France. PHY = phytoplankton, MPB = microphytobenthos, NBA = selective deposit feeding nematodes, NDF = non-selective deposit feeding nematodes, NEF = epigrowth feeding nematodes, NOM = omnivorous/predating nematodes, COP = benthic copepods, BDF = benthic deposit feeding macrofauna, BGR = benthic grazing macrofauna, SUS = benthic suspension feeding macrofauna, BOM = benthic omnivorous macrofauna, BFI = benthic fish, CBR = carnivorous birds, ZOO = zooplankton, MZO = micro-zooplankt and protozoa, BBA = benthic bacteria, PBA = pelagic bacteria, SOM = sediment organic matter, SPOM = suspended particulate organic matter, GPP = growth primary production.

Processes	Compartments	Lower limit	Upper limit	Unit	Sources
Primary production	PHY	240	1200	mg C m ⁻² d ⁻¹	Saint-Béat et al. (2014)
Resuspension	MPB	137	319	g C m ⁻² yr ⁻¹	Leguerrier et al., (2003)
Respiration	MPB	5	30	%	Vézina and Platt, (1988)
	PHY	5	30	%	Vézina and Platt, (1988)
Respiration / biomass	NBA/NDF/NEF/ NOM/COP	40	54	yr ⁻¹	Chardy et al. (1993); Chardy and Dauvin (1992); Dame and Patten (1981); Gerlach (1971); Giere (1993); Pace et al. (1984)
	BBA	40	195	yr ⁻¹	Garet (1996); Newell and Linley (1984)
	BDF	1.09	9.5	yr ⁻¹	Asmus (1987); Banse and Mosher (1980); Chardy et al. (1993); Dame and Patten (1981)
	BGR	1.09	9.5	yr ⁻¹	Estimated from Leguerrier et al. (2003)
	SUS		10	yr ⁻¹	Estimated from Leguerrier et al. (2003)
	BOM	2.6	7.3	yr ⁻¹	Chardy et al. (1993)
	BFI	5.424	87.072	mg C m ⁻² d ⁻¹	Saint-Béat et al. (2014)
Consumption/biomass	BOM		73	yr ⁻¹	Pace et al. (1984)
	BFI	3	8	%	Como et al. (2014); Saint-Béat et al. (2014)
Total consumption	CBR	1.1	7.8	g C m ⁻² yr ⁻¹	Leguerrier et al. (2003)
Consumption					
- on MPB	BOM		20	% of diet	Leguerrier et al. (2003)
	NBA	8.3	21.1	% of diet	This study (MixSIAR outputs)
	NDF	75.0	92.7	% of diet	This study (MixSIAR outputs)
	NEF	70.0	87.9	% of diet	This study (MixSIAR outputs)
	NOM	2.4	45.4	% of diet	This study (MixSIAR outputs)
	COP	73.8	93.3	% of diet	This study (MixSIAR outputs)
- on SOM	NBA	0.2	7.4	% of diet	This study (MixSIAR outputs)
	NDF	0.1	9.9	% of diet	This study (MixSIAR outputs)
	NEF	0.1	13.9	% of diet	This study (MixSIAR outputs)
	NOM	0.3	15.8	% of diet	This study (MixSIAR outputs)

	COP	0.1	11.2	% of diet	This study (MixSIAR outputs)
- on bba	NBA	72.8	88.2	% of diet	This study (MixSIAR outputs)
	NDF	4.7	16.5	% of diet	This study (MixSIAR outputs)
	NEF	7.7	18.8	% of diet	This study (MixSIAR outputs)
	NOM	0.1	7.3	% of diet	This study (MixSIAR outputs)
	COP	4.2	17.1	% of diet	This study (MixSIAR outputs)
- on SPOM	NBA	0.1	7.6	% of diet	This study (MixSIAR outputs)
	NDF	0.0	8.0	% of diet	This study (MixSIAR outputs)
	NEF	0.1	11.0	% of diet	This study (MixSIAR outputs)
	NOM	0.2	10.8	% of diet	This study (MixSIAR outputs)
	COP	0.1	8.3	% of diet	This study (MixSIAR outputs)
- on NBA	NOM	0.1	6.3	% of diet	This study (MixSIAR outputs)
- on NDF	NOM	2.5	56.2	% of diet	This study (MixSIAR outputs)
- on NEF	NOM	0.9	43.8	% of diet	This study (MixSIAR outputs)
- on COP	NOM	1.8	54.5	% of diet	This study (MixSIAR outputs)
- on BFI	CBR		0.03	% of diet	Leguerrier et al. (2003)
Production/biomass	NBA/NDF/NEF/ NOM/COP	3	31	yr ⁻¹	Chardy et al. (1993); Chardy and Dauvin (1992); Dame and Patten (1981); Gerlach (1971); Giere (1993); Pace et al. (1984)
	BBA	41	51	yr ⁻¹	Garet (1996); Newell and Linley (1984)
	PBA	1.08	2.2	d ⁻¹	Garet (1996)
	BDF	2.5	6.6	yr ⁻¹	Chardy et al. (1993)
	BGR	2.5	6.6	yr ⁻¹	Estimated from Leguerrier et al. (2003)
	SUS	0.652	5.511	yr ⁻¹	Estimated from Leguerrier et al. (2003)
	BOM	1.5	1.9	yr ⁻¹	Asmus (1987); Chardy et al. (1993); Chardy and Dauvin (1992)
Net growth efficiency	NBA/NDF/NEF/NOM	60	90	%	van Oevelen et al. (2006)
	COP	30	50	%	van Oevelen et al. (2006)
	BDF/BGR/SUS/BOM	50	70	%	van Oevelen et al. (2006)
Assimilation efficiency	NBA/NDF/NEF/NOM	6	30	%	van Oevelen et al. (2006)
	COP	57	97	%	van Oevelen et al. (2006)
	BDF/BGR/SUS/BOM	40	75	%	van Oevelen et al. (2006)
	ZOO	50	90	%	van Oevelen et al. (2006)
	MZO	50	90	%	van Oevelen et al. (2006)
	BFI	50	90	%	Leguerrier et al. (2004)
Excretion	PHY	5	30	% (of GPP)	Vézina and Platt (1988)
Excretion/biomass	SUS	0.6	20	yr ⁻¹	Beukema and Cadée (1991); Chardy et al. (1993); Dame and Patten (1981)

Mortality BBA 11 128 yr⁻¹ Garet (1996); Newell and Linley (1984)

Appendix 5.3. Inequalities used for the linear inverse modeling of the seagrass bed in the Marennes-Oleron Bay, France. PHY = phytoplankton, MPB = microphytobenthos, ZOS = *Zostera noltei* material, NBA = selective deposit feeding nematodes, NDF = non-selective deposit feeding nematodes, NEF = epigrowth feeding nematodes, NOM = omnivorous/predating nematodes, COP = benthic copepods, BDF = benthic deposit feeding macrofauna, BGR = benthic grazing macrofauna, SUS = benthic suspension feeding macrofauna, BOM = benthic omnivorous macrofauna, BFI = benthic fish, CBR = carnivorous birds, ZOO = zooplankton, BBA = benthic bacteria, PBA = pelagic bacteria, HBR = herbivorous birds, SOM = sediment organic matter, SPOM = suspended particulate organic matter, mpbLOSS = loss to microphytobenthos, GPP = growth primary production.

Processes	Compartments	Lower limit	Upper limit	Unit	Sources
Primary production	PHY	16.00	59.67	mg C m ⁻² d ⁻¹	Degré et al. (2006)
	MPB	912.33	1115.07	mg C m ⁻² d ⁻¹	Baeta et al. (2011)
	ZOS	36.07	47.95	mg C m ⁻² d ⁻¹	Baeta et al. (2011)
Respiration	PHY	5	30	% of GPP	Vézina and Platt (1988)
	MPB	16	30	% of GPP	van Oevelen et al. (2006)
	ZOS	5	30	% of GPP	Vézina and Platt (1988)
	BBA	516.99	2520.31	mg C m ⁻² d ⁻¹	Pacella et al. (2013)
	PBA	28.13	111.00	mg C m ⁻² d ⁻¹	Pacella et al. (2013)
	ZOO	39.28	58.92	mg C m ⁻² d ⁻¹	Pacella et al. (2013)
	NBA	0.14	0.33	mg C m ⁻² d ⁻¹	Calculated from Pacella et al. (2013)
	NDF	1.82	4.43	mg C m ⁻² d ⁻¹	Calculated from Pacella et al. (2013)
	NEF	4.96	12.07	mg C m ⁻² d ⁻¹	Calculated from Pacella et al. (2013)
	NOM	1.89	4.61	mg C m ⁻² d ⁻¹	Calculated from Pacella et al. (2013)
	COP	0.62	0.72	mg C m ⁻² d ⁻¹	Calculated from Pacella et al. (2013)
	BDF	0.91	1.10	mg C m ⁻² d ⁻¹	Aggregated from Pacella et al. (2013)
	BGR	66.21	84.96	mg C m ⁻² d ⁻¹	Aggregated from Pacella et al. (2013)
SUS	7.22	7.82	mg C m ⁻² d ⁻¹	Aggregated from Pacella et al. (2013)	
BOM	0.25	0.36	mg C m ⁻² d ⁻¹	Aggregated from Pacella et al. (2013)	
BFI	19.83	198.31	mg C m ⁻² d ⁻¹	Pacella et al. (2013)	
Uptake som by	BBA	mpbLOSS			Pacella et al. (2013)
Grazing on bba		3		% of production	Pacella et al. (2013)
Total consumption	HBR	26	45	% of zos GPP	Pacella et al. (2013)
Consumption					
- on ZOS	BDF	0.3	70.4	% of diet	Aggregated from Pacella et al. (2013)
	BGR	11.1	81.1	% of diet	Aggregated from Pacella et al. (2013)
	BOM	1.3	33.9	% of diet	Aggregated from Pacella et al. (2013)

- on MPB	BFI	36.0	44.0	mg C m ⁻² d ⁻¹	Pacella et al. (2013)
	NBA	26.3	49.1	% of diet	This study (MixSIAR outputs)
	NDF	76.0	94.9	% of diet	This study (MixSIAR outputs)
	NEF	88.9	98.1	% of diet	This study (MixSIAR outputs)
	NOM	0.6	26.6	% of diet	This study (MixSIAR outputs)
	COP	81.7	96.5	% of diet	This study (MixSIAR outputs)
	BDF	4.3	80.8	% of diet	This study (MixSIAR outputs)
	SUS	7.8	64.9	% of diet	This study (MixSIAR outputs)
	BGR	5.4	76.1	% of diet	This study (MixSIAR outputs)
	BOM	1.1	33.3	% of diet	This study (MixSIAR outputs)
- on SOM	NBA	0.3	15.9	% of diet	This study (MixSIAR outputs)
	NDF	0.1	14.5	% of diet	This study (MixSIAR outputs)
	NEF	0.0	6.5	% of diet	This study (MixSIAR outputs)
	NOM	0.4	19.5	% of diet	This study (MixSIAR outputs)
	COP	0.1	10.2	% of diet	This study (MixSIAR outputs)
	BDF	1.7	45.7	% of diet	This study (MixSIAR outputs)
	SUS	3.3	67.2	% of diet	This study (MixSIAR outputs)
	BGR	0.3	24.7	% of diet	This study (MixSIAR outputs)
	BOM	1.4	24.4	% of diet	This study (MixSIAR outputs)
- on BBA	NBA	38.6	61.3	% of diet	This study (MixSIAR outputs)
	NDF	2.1	12.0	% of diet	This study (MixSIAR outputs)
	NEF	0.8	5.4	% of diet	This study (MixSIAR outputs)
	NOM	0.2	9.2	% of diet	This study (MixSIAR outputs)
	COP	1.5	9.6	% of diet	This study (MixSIAR outputs)
	BDF	1.2	19.9	% of diet	This study (MixSIAR outputs)
	BGR	0.3		% of diet	This study (MixSIAR outputs)
- on PHY	SUS	1.9	39.5	% of diet	This study (MixSIAR outputs)
- on SPOM	NBA	0.2	21.1	% of diet	This study (MixSIAR outputs)
	NDF	0.1	9.0	% of diet	This study (MixSIAR outputs)
	NEF	0.0	4.2	% of diet	This study (MixSIAR outputs)
	NOM	0.2	12.8	% of diet	This study (MixSIAR outputs)
	COP	0.0	6.7	% of diet	This study (MixSIAR outputs)
	SUS	3.0	46.5	% of diet	This study (MixSIAR outputs)
- on ZOO	BOM	0.4	18.2	% of diet	This study (MixSIAR outputs)
- on NBA	NOM	0.3	16.0	% of diet	This study (MixSIAR outputs)

	BOM	0.3	14.3	% of diet	This study (MixSIAR outputs)
- on NDF	NOM	5.8	61.3	% of diet	This study (MixSIAR outputs)
	BOM	0.6	15.6	% of diet	This study (MixSIAR outputs)
- on NEF	NOM	1.3	49.1	% of diet	This study (MixSIAR outputs)
	BOM	0.0	25.6	% of diet	This study (MixSIAR outputs)
- on NOM	BOM	0.1	17.3	% of diet	This study (MixSIAR outputs)
- on COP	NOM	1.0	44.9	% of diet	This study (MixSIAR outputs)
	BOM	1.1	26.7	% of diet	This study (MixSIAR outputs)
- on BDF	BOM	0.1	14.4	% of diet	This study (MixSIAR outputs)
- on BGR	BOM	0.7	18.1	% of diet	This study (MixSIAR outputs)
- on SUS	BOM	0.3	17.7	% of diet	This study (MixSIAR outputs)
- on BFI	BOM	1.0	19.1	% of diet	This study (MixSIAR outputs)
Production	BBA	10.0	60.0	% of assimilation	Pacella et al. (2013)
	BBA	529.91	659.16	mg C m ⁻² d ⁻¹	Pacella et al. (2013)
	ZOO	19.64	29.46	mg C m ⁻² d ⁻¹	Pacella et al. (2013)
	BDF	0.19	0.24	mg C m ⁻² d ⁻¹	Aggregated from Pacella et al. (2013)
	BGR	23.59	32.77	mg C m ⁻² d ⁻¹	Aggregated from Pacella et al. (2013)
	SUS	1.38	1.78	mg C m ⁻² d ⁻¹	Aggregated from Pacella et al. (2013)
	BOM	0.09	0.11	mg C m ⁻² d ⁻¹	Aggregated from Pacella et al. (2013)
	NBA	0.52	0.98	mg C m ⁻² d ⁻¹	Calculated from Pacella et al. (2013)
	NDF	6.92	13.09	mg C m ⁻² d ⁻¹	Calculated from Pacella et al. (2013)
	NEF	18.84	35.64	mg C m ⁻² d ⁻¹	Calculated from Pacella et al. (2013)
	NOM	7.20	13.61	mg C m ⁻² d ⁻¹	Calculated from Pacella et al. (2013)
	COP	30	50	% of assimilation	van Oevelen et al. (2006)
Assimilation efficiency	PBA	10	60	% of production	Pacella et al. (2013)
	ZOO	50	90	% of consumption	Vézina and Platt (1988)
	BDF/BGR/SUS/BOM	40	75	% of consumption	van Oevelen et al. (2006)
	NBA/NDF/NEF/NOM	6	30	% of consumption	van Oevelen et al. (2006)
	COP	57	77	% of consumption	van Oevelen et al. (2006)
	BFI	50	90	% of consumption	Leguerrier et al. (2004); van Oevelen et al. (2006)
	HBR/CBR	21	99	% of consumption	Pacella et al. (2013)
Egestion	MPB	46.3	56.3	% of GPP	Goto et al. (1999)
	ZOS	1.5	6.0	% of GPP	Pacella et al. (2013)
	PHY	12	14	% of GPP	Baines and Pace (1991)
	ZOO/BFI	33	100	% of respiration	Pacella et al. (2013)
	BDF/BGR/SUS/BOM	33	100	% of respiration	Pacella et al. (2013)

	HBR/CBR	33	100	% of respiration	Pacella et al. (2013)
Import	BFI	50	150	% of export	Pacella et al. (2013)
	SPOM	534.29	653.02	mg C m ⁻² d ⁻¹	Pacella et al. (2013)
Import/Export	PHY	130.21	159.15	mg C m ⁻² d ⁻¹	Pacella et al. (2013)
	PBA	80.46	98.34	mg C m ⁻² d ⁻¹	Pacella et al. (2013)
	ZOO	81.86	100.06	mg C m ⁻² d ⁻¹	Pacella et al. (2013)
	BFI	110.86	221.71	mg C m ⁻² d ⁻¹	Pacella et al. (2013)
	HBR	0.43	0.85	mg C m ⁻² d ⁻¹	Pacella et al. (2013)
	CBR	2.59	5.19	mg C m ⁻² d ⁻¹	Pacella et al. (2013)
	DOC	946.68	1157.05	mg C m ⁻² d ⁻¹	Pacella et al. (2013)
Export	SPOM		653.02	mg C m ⁻² d ⁻¹	Pacella et al. (2013)
	SOM	1	50	% of production	Pacella et al. (2013)
	ZOS	5	100	% of GPP	Pacella et al. (2013)
	PHY/ZOO			Export < Import	Pacella et al. (2013)

Appendix 5.4. Inequalities used for the linear inverse modelling of the sandflat in the Sylt-Rømø Bight, Germany. PHY = phytoplankton, MPB = microphytobenthos, NBA = selective deposit feeding nematodes, NDF = non-selective deposit feeding nematodes, NEF = epigrowth feeding nematodes, NOM = omnivorous/predating nematodes, COP = benthic copepods, BDF = benthic deposit feeding macrofauna, BGR = benthic grazing macrofauna, SUS = benthic suspension feeding macrofauna, BOM = benthic omnivorous macrofauna, BFI = benthic fish, CBR = carnivorous birds, ZOO = zooplankton, BBA = benthic bacteria, PBA = pelagic bacteria, SOM = sediment organic matter, SPOM = suspended particulate organic matter, GPP = growth primary production.

Processes	Compartments	Lower limit	Upper limit	Unit	Sources
Primary production	PHY	315.0	585.0	mg C m ⁻² d ⁻¹	Modified from Saint-Béat et al. (2013)
	MPB	694.26	1289.34	mg C m ⁻² d ⁻¹	Modified from Saint-Béat et al. (2013)
	SPOM	51.75	96.11	mg C m ⁻² d ⁻¹	Modified from Saint-Béat et al. (2013)
Respiration	MPB	5	50	% of GPP	Vézina and Platt, (1988)
	NBA	0.026	0.032	mg C m ⁻² d ⁻¹	Saint-Béat et al. (2013)
	NDF	3.190	3.905	mg C m ⁻² d ⁻¹	Saint-Béat et al. (2013)
	NEF	1.836	2.247	mg C m ⁻² d ⁻¹	Saint-Béat et al. (2013)
	NOM	4.769	5.838	mg C m ⁻² d ⁻¹	Saint-Béat et al. (2013)
	COP	3.965	4.853	mg C m ⁻² d ⁻¹	Saint-Béat et al. (2013)
	BBA	59.9	757.22	mg C m ⁻² d ⁻¹	Saint-Béat et al. (2013)
	BDF	20.85	68.27	mg C m ⁻² d ⁻¹	Saint-Béat et al. (2013)
	BGR	0.16	2.9	mg C m ⁻² d ⁻¹	Saint-Béat et al. (2013)
	SUS	131.56	363.48	mg C m ⁻² d ⁻¹	Saint-Béat et al. (2013)
	BOM	7.15	20.14	mg C m ⁻² d ⁻¹	Saint-Béat et al. (2013)
	BFI	0.052	0.827	mg C m ⁻² d ⁻¹	Saint-Béat et al. (2013)
	CBR	1.185	16.585	mg C m ⁻² d ⁻¹	Saint-Béat et al. (2013)
Total consumption	NBA	0.024	2.341	mg C m ⁻² d ⁻¹	Saint-Béat et al. (2013)
	NDF	2.913	289.598	mg C m ⁻² d ⁻¹	Saint-Béat et al. (2013)
	NEF	1.676	166.638	mg C m ⁻² d ⁻¹	Saint-Béat et al. (2013)
	NOM	4.354	432.939	mg C m ⁻² d ⁻¹	Saint-Béat et al. (2013)
	COP	3.620	359.924	mg C m ⁻² d ⁻¹	Saint-Béat et al. (2013)
	BDF	49.31	4290	mg C m ⁻² d ⁻¹	Saint-Béat et al. (2013)
	BGR	0.4	12	mg C m ⁻² d ⁻¹	Saint-Béat et al. (2013)
	SUS	120.298	10466	mg C m ⁻² d ⁻¹	Saint-Béat et al. (2013)

	BOM	8.93	77	mg C m ⁻² d ⁻¹	Saint-Béat et al. (2013)
	BFI	0.165	2.103	mg C m ⁻² d ⁻¹	Saint-Béat et al. (2013)
	CBR	4.443	62.195	mg C m ⁻² d ⁻¹	Saint-Béat et al. (2013)
Consumption					
- on PHY	BOM	0.266	0.494	mg C m ⁻² d ⁻¹	Modified from Saint-Béat et al. (2013)
- on MPB	NDF	50.1	89.9	% of diet	This study (MixSIAR outputs)
	NEF	35.2	78.4	% of diet	This study (MixSIAR outputs)
	NOM	1.0	58.4	% of diet	This study (MixSIAR outputs)
	COP	40.4	78.8	% of diet	This study (MixSIAR outputs)
	BGR	0.84	1.56	mg C m ⁻² d ⁻¹	Modified from Saint-Béat et al. (2013)
	BDF	21.994	40.846	mg C m ⁻² d ⁻¹	Modified from Saint-Béat et al. (2013)
	SUS	44.73	83.07	mg C m ⁻² d ⁻¹	Modified from Saint-Béat et al. (2013)
- on SOM	BOM	0.308	0.572	mg C m ⁻² d ⁻¹	Modified from Saint-Béat et al. (2013)
	NDF	1.2	45.9	% of diet	This study (MixSIAR outputs)
	NEF	1.7	61.7	% of diet	This study (MixSIAR outputs)
	NOM	0.5	25.7	% of diet	This study (MixSIAR outputs)
	COP	3.3	54.3	% of diet	This study (MixSIAR outputs)
	BOM	19.033	35.347	mg C m ⁻² d ⁻¹	Modified from Saint-Béat et al. (2013)
- on BBA	BBA	181.965	337.935	mg C m ⁻² d ⁻¹	Modified from Saint-Béat et al. (2013)
	NDF	0.1	10.6	% of diet	This study (MixSIAR outputs)
	NEF	0.1	15.5	% of diet	This study (MixSIAR outputs)
	NOM	0.1	7.9	% of diet	This study (MixSIAR outputs)
	COP	0.3	13.8	% of diet	This study (MixSIAR outputs)
	BDF	93.34	173.342	mg C m ⁻² d ⁻¹	Modified from Saint-Béat et al. (2013)
	SUS	22.33	41.47	mg C m ⁻² d ⁻¹	Modified from Saint-Béat et al. (2013)
- on SPOM	BOM	0.483	0.897	mg C m ⁻² d ⁻¹	Modified from Saint-Béat et al. (2013)
	NDF	0.2	16.0	% of diet	This study (MixSIAR outputs)
	NEF	0.3	24.8	% of diet	This study (MixSIAR outputs)
	NOM	0.2	11.8	% of diet	This study (MixSIAR outputs)
	COP	0.5	21.2	% of diet	This study (MixSIAR outputs)
- on NBA	BFI	0.00005	0.00009	mg C m ⁻² d ⁻¹	Modified from Saint-Béat et al. (2013)
- on NDF	NOM	2.3	65.9	% of diet	This study (MixSIAR outputs)
	BFI	0.00613	0.011384	mg C m ⁻² d ⁻¹	Modified from Saint-Béat et al. (2013)
- on NEF	NOM	0.8	47.9	% of diet	This study (MixSIAR outputs)
	BFI	0.00353	0.00655	mg C m ⁻² d ⁻¹	Modified from Saint-Béat et al. (2013)

- on NOM	BFI	0.00916	0.01702	mg C m ⁻² d ⁻¹	Modified from Saint-Béat et al. (2013)
- on COP	NOM	0.9	49.0	% of diet	This study (MixSIAR outputs)
	BFI	0.00762	0.01415	mg C m ⁻² d ⁻¹	Modified from Saint-Béat et al. (2013)
- on BGR	CBR	0.07	0.13	mg C m ⁻² d ⁻¹	Modified from Saint-Béat et al. (2013)
- on BDF	BOM	0.28	0.52	mg C m ⁻² d ⁻¹	Modified from Saint-Béat et al. (2013)
	BFI	0.11928	0.22152	mg C m ⁻² d ⁻¹	Modified from Saint-Béat et al. (2013)
	CBR	0.966	1.794	mg C m ⁻² d ⁻¹	Modified from Saint-Béat et al. (2013)
- on SUS	BOM	0.07	0.13	mg C m ⁻² d ⁻¹	Modified from Saint-Béat et al. (2013)
	BFI	0.0720	0.13377	mg C m ⁻² d ⁻¹	Modified from Saint-Béat et al. (2013)
	CBR	5.81	10.79	mg C m ⁻² d ⁻¹	Modified from Saint-Béat et al. (2013)
- on BOM	BOM	0.917	1.703	mg C m ⁻² d ⁻¹	Modified from Saint-Béat et al. (2013)
	BFI	0.0784	0.1456	mg C m ⁻² d ⁻¹	Modified from Saint-Béat et al. (2013)
- on ZOO	BFI	0.0182	0.0338	mg C m ⁻² d ⁻¹	Modified from Saint-Béat et al. (2013)
Production	BDF/BGR/SUS/BOM		70	% of assimilation	Calow (1977); Nielsen et al. (1995)
	PBA	2.82	5.23	mg C m ⁻² d ⁻¹	Modified from Saint-Béat et al. (2013)
Assimilation efficiency	BBA	11	61	% of consumption	del Giorgio and Cole (1998)
	NBA/NDF/NEF/ NOM/COP	6	30	% of consumption	van Oevelen et al. (2006)
	BDF/BGR/SUS/BOM	40	75	% of consumption	Arifin and Bendell-Young (1997); Jordana et al. (2001); Loo and Rosenberg (1996)
Egestion	BFI		90	% of consumption	Leguerrier et al. (2004); van Oevelen et al. (2006)
	MPB	5	73	% of GPP	Goto et al., (1999)
	BGR		9.48	mg C m ⁻² d ⁻¹	Modified from Saint-Béat et al. (2013)
	BDF	0.493	3389.1	mg C m ⁻² d ⁻¹	Modified from Saint-Béat et al. (2013)
	SUS	1.203	8261.14	mg C m ⁻² d ⁻¹	Modified from Saint-Béat et al. (2013)
	BOM	0.09	631.83	mg C m ⁻² d ⁻¹	Modified from Saint-Béat et al. (2013)
	BFI	0.017	1.05	mg C m ⁻² d ⁻¹	Modified from Saint-Béat et al. (2013)
	CBR	0.889	12.439	mg C m ⁻² d ⁻¹	Modified from Saint-Béat et al. (2013)

Appendix 5.5. Inequalities used in the linear inverse modelling of the mudflat in Sylt-Rømø Bight, Germany. PHY = phytoplankton, MPB = microphytobenthos, NBA = selective deposit feeding nematodes, NDF = non-selective deposit feeding nematodes, NEF = epigrowth feeding nematodes, NOM = omnivorous/predating nematodes, COP = benthic copepods, BDF = benthic deposit feeding macrofauna, BGR = benthic grazing macrofauna, SUS = benthic suspension feeding macrofauna, BOM = benthic omnivorous macrofauna, BFI = benthic fish, CBR = carnivorous birds, BBA = benthic bacteria, PBA = pelagic bacteria, SOM = sediment organic matter, SPOM = suspended particulate organic matter, GPP = growth primary production.

Processes	Compartments	Lower limit	Upper limit	Unit	Sources
Primary production	PHY	173.705	322.595	mg C m ⁻² d ⁻¹	Modified from Saint-Béat et al. (2013)
	MPB	680.82	1264.38	mg C m ⁻² d ⁻¹	Modified from Saint-Béat et al. (2013)
	SPOM	35.483	65.897	mg C m ⁻² d ⁻¹	Modified from Saint-Béat et al. (2013)
Respiration	MPB	5	50	% of GPP	Vézina and Platt (1988)
	BBA	77.76	982.935	mg C m ⁻² d ⁻¹	Saint-Béat et al. (2013)
	NBA	0.437	0.535	mg C m ⁻² d ⁻¹	Saint-Béat et al. (2013)
	NDF	4.603	5.637	mg C m ⁻² d ⁻¹	Saint-Béat et al. (2013)
	NEF	1.537	1.883	mg C m ⁻² d ⁻¹	Saint-Béat et al. (2013)
	NOM	1.513	1.853	mg C m ⁻² d ⁻¹	Saint-Béat et al. (2013)
	COP	0.475	0.581	mg C m ⁻² d ⁻¹	Saint-Béat et al. (2013)
	BDF	9.6	60.36	mg C m ⁻² d ⁻¹	Saint-Béat et al. (2013)
	BGR	31.35	98.44	mg C m ⁻² d ⁻¹	Saint-Béat et al. (2013)
	SUS	101.61	363.58	mg C m ⁻² d ⁻¹	Saint-Béat et al. (2013)
	BOM	17.34	213.73	mg C m ⁻² d ⁻¹	Saint-Béat et al. (2013)
	BFI	0.02	0.329	mg C m ⁻² d ⁻¹	Saint-Béat et al. (2013)
	CBR	12.088	169.226	mg C m ⁻² d ⁻¹	Saint-Béat et al. (2013)
Total consumption	NBA	0.399	39.660	mg C m ⁻² d ⁻¹	Saint-Béat et al. (2013)
	NDF	4.204	418.022	mg C m ⁻² d ⁻¹	Saint-Béat et al. (2013)
	NEF	1.404	139.619	mg C m ⁻² d ⁻¹	Saint-Béat et al. (2013)
	NOM	1.382	137.381	mg C m ⁻² d ⁻¹	Saint-Béat et al. (2013)
	COP	0.434	43.119	mg C m ⁻² d ⁻¹	Saint-Béat et al. (2013)
	BDF		516.416	mg C m ⁻² d ⁻¹	Saint-Béat et al. (2013)
	SUS		801.305	mg C m ⁻² d ⁻¹	Saint-Béat et al. (2013)
	BOM		182.595	mg C m ⁻² d ⁻¹	Saint-Béat et al. (2013)
	BFI	0.068	0.839	mg C m ⁻² d ⁻¹	Saint-Béat et al. (2013)
CBR	45.328	634.599	mg C m ⁻² d ⁻¹	Saint-Béat et al. (2013)	

Consumption					
- on PHY	BOM	9.324	17.316	mg C m ⁻² d ⁻¹	Modified from Saint-Béat et al. (2013)
- on MPB	NBA	32.8	65.5	% of diet	This study (MixSIAR outputs)
	NDF	85.0	97.8	% of diet	This study (MixSIAR outputs)
	NEF	86.5	98.1	% of diet	This study (MixSIAR outputs)
	NOM	0.8	29.4	% of diet	This study (MixSIAR outputs)
	COP	55.3	86.6	% of diet	This study (MixSIAR outputs)
	BGR	166.53	309.27	mg C m ⁻² d ⁻¹	Modified from Saint-Béat et al. (2013)
	BDF	8.68	16.12	mg C m ⁻² d ⁻¹	Modified from Saint-Béat et al. (2013)
	SUS	85.96	159.64	mg C m ⁻² d ⁻¹	Modified from Saint-Béat et al. (2013)
- on SOM	BOM	10.388	19.292	mg C m ⁻² d ⁻¹	Modified from Saint-Béat et al. (2013)
	NBA	0.4	29.8	% of diet	This study (MixSIAR outputs)
	NDF	0.1	8.7	% of diet	This study (MixSIAR outputs)
	NEF	0.0	7.5	% of diet	This study (MixSIAR outputs)
	NOM	0.4	19.2	% of diet	This study (MixSIAR outputs)
	COP	0.1	32.0	% of diet	This study (MixSIAR outputs)
	BGR	27.72	51.48	mg C m ⁻² d ⁻¹	Modified from Saint-Béat et al. (2013)
	BOM	10.066	18.694	mg C m ⁻² d ⁻¹	Modified from Saint-Béat et al. (2013)
- on BBA	BBA	347.319	645.021	mg C m ⁻² d ⁻¹	Modified from Saint-Béat et al. (2013)
	NBA	8.5	39.8	% of diet	This study (MixSIAR outputs)
	NDF	0.5	6.3	% of diet	This study (MixSIAR outputs)
	NEF	0.5	5.4	% of diet	This study (MixSIAR outputs)
	NOM	0.1	7.8	% of diet	This study (MixSIAR outputs)
	COP	1.9	18.7	% of diet	This study (MixSIAR outputs)
	BDF	68.355	126.945	mg C m ⁻² d ⁻¹	Modified from Saint-Béat et al. (2013)
	SUS	25.48	47.32	mg C m ⁻² d ⁻¹	Modified from Saint-Béat et al. (2013)
- on SPOM	BOM	43.981	81.679	mg C m ⁻² d ⁻¹	Modified from Saint-Béat et al. (2013)
	NBA	0.4	44.8	% of diet	This study (MixSIAR outputs)
	NDF	0.1	7.5	% of diet	This study (MixSIAR outputs)
	NEF	0.1	6.7	% of diet	This study (MixSIAR outputs)
	NOM	0.3	14.9	% of diet	This study (MixSIAR outputs)
	COP	0.2	26.4	% of diet	This study (MixSIAR outputs)
- on NBA	NOM	0.4	20.7	% of diet	This study (MixSIAR outputs)
- on NDF	BFI	0.00079	0.00146	mg C m ⁻² d ⁻¹	Modified from Saint-Béat et al. (2013)
	NOM	1.7	50.4	% of diet	This study (MixSIAR outputs)
	BFI	0.00831	0.01543	mg C m ⁻² d ⁻¹	Modified from Saint-Béat et al. (2013)

- on NEF	NOM	2.3	59.5	% of diet	This study (MixSIAR outputs)
	BFI	0.00277	0.00515	mg C m ⁻² d ⁻¹	Modified from Saint-Béat et al. (2013)
- on NOM	BFI	0.00273	0.00507	mg C m ⁻² d ⁻¹	Modified from Saint-Béat et al. (2013)
- on COP	NOM	0.9	41.2	% of diet	This study (MixSIAR outputs)
	BFI	0.00086	0.00159	mg C m ⁻² d ⁻¹	Modified from Saint-Béat et al. (2013)
- on BGR	BFI	0.00217	0.00403	mg C m ⁻² d ⁻¹	Modified from Saint-Béat et al. (2013)
	CBR	57.72	107.198	mg C m ⁻² d ⁻¹	Modified from Saint-Béat et al. (2013)
- on BDF	BOM	0.56	1.04	mg C m ⁻² d ⁻¹	Modified from Saint-Béat et al. (2013)
	BFI	0.07	0.1326	mg C m ⁻² d ⁻¹	Modified from Saint-Béat et al. (2013)
	CBR	4.2	7.761	mg C m ⁻² d ⁻¹	Modified from Saint-Béat et al. (2013)
- on SUS	BOM	0.35	0.65	mg C m ⁻² d ⁻¹	Modified from Saint-Béat et al. (2013)
	BFI	0.0056	0.0104	mg C m ⁻² d ⁻¹	Modified from Saint-Béat et al. (2013)
	CBR	2.19	4.069	mg C m ⁻² d ⁻¹	Modified from Saint-Béat et al. (2013)
- on BOM	BOM	0.133	0.247	mg C m ⁻² d ⁻¹	Modified from Saint-Béat et al. (2013)
	BFI	0.06853	0.12727	mg C m ⁻² d ⁻¹	Modified from Saint-Béat et al. (2013)
Production	BDF/BGR/SUS/BOM		70	% of assimilation	Calow (1977); Nielsen et al. (1995)
	PBA	0.182	0.338	mg C m ⁻² d ⁻¹	Modified from Saint-Béat et al. (2013)
Assimilation efficiency	BBA	11	61	% of consumption	del Giorgio and Cole (1998)
	NBA/NDF/NEF/ NOM/COP	6	30	% of consumption	van Oevelen et al. (2006)
	BDF/BGR/SUS/BOM	40	75	% of consumption	Arifin and Bendell-Young (1997); Jordana et al. (2001); Loo and Rosenberg (1996)
	BFI		90	% of consumption	Leguerrier et al. (2004); van Oevelen et al. (2006)
Egestion	MPB	5	73	% of GPP	Goto et al. (1999)
	BBA		587.5	mg C m ⁻² d ⁻¹	Modified from Saint-Béat et al. (2013)
	BDF		514.22	mg C m ⁻² d ⁻¹	Modified from Saint-Béat et al. (2013)
	SUS		793.291	mg C m ⁻² d ⁻¹	Modified from Saint-Béat et al. (2013)
	BOM		180.769	mg C m ⁻² d ⁻¹	Modified from Saint-Béat et al. (2013)
	BFI	0.007	0.42	mg C m ⁻² d ⁻¹	Modified from Saint-Béat et al. (2013)
	CBR	9.066	126.92	mg C m ⁻² d ⁻¹	Modified from Saint-Béat et al. (2013)

Appendix 5.6. Inequalities used in the linear inverse modelling of the seagrass bed in the Sylt-Rømø Bight, Germany. PHY = phytoplankton, MPB = microphytobenthos, ZOS = *Zostera noltei* material, NBA = selective deposit feeding nematodes, NDF = non-selective deposit feeding nematodes, NEF = epigrowth feeding nematodes, NOM = omnivorous/predating nematodes, COP = benthic copepods, BDF = benthic deposit feeding macrofauna, BGR = benthic grazing macrofauna, SUS = benthic suspension feeding macrofauna, BOM = benthic omnivorous macrofauna, BFI = benthic fish, CBR = carnivorous birds, BBA = benthic bacteria, PBA = pelagic bacteria, HBR = herbivorous birds, SOM = sediment organic matter, SPOM = suspended particulate organic matter, GPP = growth primary production.

Processes	Compartments	Lower limit	Upper limit	Unit	Sources
Primary production	PHY	213.78	397.02	mg C m ⁻² d ⁻¹	Modified from Saint-Béat et al. (2013)
	MPB	680.82	1264.38	mg C m ⁻² d ⁻¹	Modified from Saint-Béat et al. (2013)
	ZOS	592.41	1100.19	mg C m ⁻² d ⁻¹	Modified from Saint-Béat et al. (2013)
	SPOM	35.021	65.039	mg C m ⁻² d ⁻¹	Modified from Saint-Béat et al. (2013)
Respiration	MPB	5	50	% of GPP	Vézina and Platt (1988)
	ZOS		14	% of GPP	Ouisse et al. (2010)
	BBA	77.76	982.935	mg C m ⁻² d ⁻¹	Saint-Béat et al. (2013)
	NBA	0.361	0.442	mg C m ⁻² d ⁻¹	Saint-Béat et al. (2013)
	NDF	4.808	5.889	mg C m ⁻² d ⁻¹	Saint-Béat et al. (2013)
	NEF	13.093	16.035	mg C m ⁻² d ⁻¹	Saint-Béat et al. (2013)
	NOM	5.000	6.123	mg C m ⁻² d ⁻¹	Saint-Béat et al. (2013)
	COP	0.484	0.593	mg C m ⁻² d ⁻¹	Saint-Béat et al. (2013)
	BDF	51.36	161.28	mg C m ⁻² d ⁻¹	Saint-Béat et al. (2013)
	BGR	28.1	88.24	mg C m ⁻² d ⁻¹	Saint-Béat et al. (2013)
	SUS	64.95	236.02	mg C m ⁻² d ⁻¹	Saint-Béat et al. (2013)
	BOM	3.4	20.73	mg C m ⁻² d ⁻¹	Saint-Béat et al. (2013)
	BFI	0.226	3.619	mg C m ⁻² d ⁻¹	Saint-Béat et al. (2013)
	CBR	0.509	7.134	mg C m ⁻² d ⁻¹	Saint-Béat et al. (2013)
Total consumption	NBA	0.330	32.812	mg C m ⁻² d ⁻¹	Saint-Béat et al. (2013)
	NDF	4.392	436.715	mg C m ⁻² d ⁻¹	Saint-Béat et al. (2013)
	NEF	11.959	1183.161	mg C m ⁻² d ⁻¹	Saint-Béat et al. (2013)
	NOM	4.567	454.099	mg C m ⁻² d ⁻¹	Saint-Béat et al. (2013)
	COP	0.442	43.997	mg C m ⁻² d ⁻¹	Saint-Béat et al. (2013)
	BDF	74.94	6520	mg C m ⁻² d ⁻¹	Saint-Béat et al. (2013)
	SUS	52.644	4580	mg C m ⁻² d ⁻¹	Saint-Béat et al. (2013)
	BOM	10.6	875	mg C m ⁻² d ⁻¹	Saint-Béat et al. (2013)
	BFI	0.739	9.222	mg C m ⁻² d ⁻¹	Saint-Béat et al. (2013)

	CBR	1.911	26.753	mg C m ⁻² d ⁻¹	Saint-Béat et al. (2013)
Consumption					
- on PHY	BOM	1.12	2.08	mg C m ⁻² d ⁻¹	Modified from Saint-Béat et al. (2013)
- on MPB	NBA	23.5	62.7	% of diet	This study (MixSIAR outputs)
	NDF	57.9	93.0	% of diet	This study (MixSIAR outputs)
	NEF	48.7	87.9	% of diet	This study (MixSIAR outputs)
	NOM	0.7	38.7	% of diet	This study (MixSIAR outputs)
	COP	37.6	84.0	% of diet	This study (MixSIAR outputs)
	BGR	149.94	278.46	mg C m ⁻² d ⁻¹	Modified from Saint-Béat et al. (2013)
	BDF	40.25	74.75	mg C m ⁻² d ⁻¹	Modified from Saint-Béat et al. (2013)
	SUS	54.11	100.49	mg C m ⁻² d ⁻¹	Modified from Saint-Béat et al. (2013)
	BOM	1.47	2.73	mg C m ⁻² d ⁻¹	Modified from Saint-Béat et al. (2013)
- on ZOS	BOM	0.84	1.56	mg C m ⁻² d ⁻¹	Modified from Saint-Béat et al. (2013)
	HBR	29.26	54.34	mg C m ⁻² d ⁻¹	Modified from Saint-Béat et al. (2013)
- on SOM	NBA	1.1	38.8	% of diet	This study (MixSIAR outputs)
	NDF	0.3	28.7	% of diet	This study (MixSIAR outputs)
	NEF	0.3	40.4	% of diet	This study (MixSIAR outputs)
	NOM	0.3	16.1	% of diet	This study (MixSIAR outputs)
	COP	0.4	46.5	% of diet	This study (MixSIAR outputs)
	BGR	24.99	46.41	mg C m ⁻² d ⁻¹	Modified from Saint-Béat et al. (2013)
	BOM	22.61	41.99	mg C m ⁻² d ⁻¹	Modified from Saint-Béat et al. (2013)
- on BBA	BBA	425.866	790.894	mg C m ⁻² d ⁻¹	Modified from Saint-Béat et al. (2013)
	NBA	2.8	42.5	% of diet	This study (MixSIAR outputs)
	NDF	0.7	15.2	% of diet	This study (MixSIAR outputs)
	NEF	0.8	17.3	% of diet	This study (MixSIAR outputs)
	NOM	0.2	7.7	% of diet	This study (MixSIAR outputs)
	COP	1.1	22.6	% of diet	This study (MixSIAR outputs)
	BDF	186.375	346.125	mg C m ⁻² d ⁻¹	Modified from Saint-Béat et al. (2013)
	SUS	30.044	55.796	mg C m ⁻² d ⁻¹	Modified from Saint-Béat et al. (2013)
	BOM	2.45	4.55	mg C m ⁻² d ⁻¹	Modified from Saint-Béat et al. (2013)
- on SPOM	NBA	0.9	52.2	% of diet	This study (MixSIAR outputs)
	NDF	0.3	22.3	% of diet	This study (MixSIAR outputs)
	NEF	0.3	27.7	% of diet	This study (MixSIAR outputs)
	NOM	0.2	13.0	% of diet	This study (MixSIAR outputs)
	COP	0.3	36.7	% of diet	This study (MixSIAR outputs)

- on NBA	NOM	0.6	26.2	% of diet	This study (MixSIAR outputs)
	BFI	0.01208	0.02244	mg C m ⁻² d ⁻¹	Modified from Saint-Béat et al. (2013)
- on NDF	NOM	3.7	65.6	% of diet	This study (MixSIAR outputs)
	BFI	0.16081	0.29865	mg C m ⁻² d ⁻¹	Modified from Saint-Béat et al. (2013)
- on NEF	NOM	1.1	43.3	% of diet	This study (MixSIAR outputs)
	BFI	0.43789	0.81323	mg C m ⁻² d ⁻¹	Modified from Saint-Béat et al. (2013)
- on NOM	BFI	0.16722	0.31054	mg C m ⁻² d ⁻¹	Modified from Saint-Béat et al. (2013)
- on COP	NOM	0.8	43.4	% of diet	This study (MixSIAR outputs)
	BFI	0.01620	0.03009	mg C m ⁻² d ⁻¹	Modified from Saint-Béat et al. (2013)
- on BGR	BFI	0.00217	0.00403	mg C m ⁻² d ⁻¹	Modified from Saint-Béat et al. (2013)
	CBR	0.567	1.053	mg C m ⁻² d ⁻¹	Modified from Saint-Béat et al. (2013)
- on BDF	BOM	0.21	0.39	mg C m ⁻² d ⁻¹	Modified from Saint-Béat et al. (2013)
	BFI	0.0518	0.0962	mg C m ⁻² d ⁻¹	Modified from Saint-Béat et al. (2013)
	CBR	0.336	0.624	mg C m ⁻² d ⁻¹	Modified from Saint-Béat et al. (2013)
- on SUS	BOM	0.28	0.52	mg C m ⁻² d ⁻¹	Modified from Saint-Béat et al. (2013)
	BFI	0.23310	0.43290	mg C m ⁻² d ⁻¹	Modified from Saint-Béat et al. (2013)
	CBR	1.19	2.21	mg C m ⁻² d ⁻¹	Modified from Saint-Béat et al. (2013)
- on BOM	BOM	0.56	1.04	mg C m ⁻² d ⁻¹	Modified from Saint-Béat et al. (2013)
	BFI	0.70077	1.30143	mg C m ⁻² d ⁻¹	Modified from Saint-Béat et al. (2013)
Production	BDF/BGR/SUS/BOM		70	% of assimilation	Calow (1977); Nielsen et al. (1995)
	PBA	1.386	2.574	mg C m ⁻² d ⁻¹	Modified from Saint-Béat et al. (2013)
Assimilation efficiency	BBA		61	% of consumption	del Giorgio and Cole (1998)
	NBA/NDF/NEF/ NOM/COP	6	30	% of consumption	van Oevelen et al. (2006)
	BDF/BGR/SUS/BOM	40	75	% of consumption	Jordana et al. (2001); Loo and Rosenberg (1996)
	BFI		90	% of consumption	Leguerrier et al. (2004); van Oevelen et al. (2006)
Egestion	MPB	5	73	% of primary production	Goto et al. (1999)
- loss to DOC	ZOS		5	% of production	Saint-Béat et al. (2013)
- loss to SOM	ZOS	5	50	% of primary prod	Saint-Béat et al. (2013)
	BDF	0.75	5150.8	mg C m ⁻² d ⁻¹	Modified from Saint-Béat et al. (2013)
	BGR	0.37	2512.2	mg C m ⁻² d ⁻¹	Modified from Saint-Béat et al. (2013)
	SUS	0.53	3618.2	mg C m ⁻² d ⁻¹	Modified from Saint-Béat et al. (2013)
	BOM	0.1	691.25	mg C m ⁻² d ⁻¹	Modified from Saint-Béat et al. (2013)
	BFI	0.074	4.61	mg C m ⁻² d ⁻¹	Modified from Saint-Béat et al. (2013)
	CBR	0.382	5.351	mg C m ⁻² d ⁻¹	Modified from Saint-Béat et al. (2013)

Appendix 5.7. Formulas of the ecological network analysis indices. Calculations start from the balanced matrix T with n flows, with source compartments in rows (i) and sink compartments in columns (j).

Index	Formula
Total system throughput (T..)	$\sum_{ij} T_{ij}$
Finn's cycling index (FCI)	$\frac{TST_c}{T..} = \sum_j \frac{\sum_i T_{ij} + Imports_j}{T..}$
Relative redundancy (R/C)	$\frac{\sum_{i,j=1}^n T_{ij} * \log\left(\frac{T_{ij}^2}{T_i * T_j}\right)}{\sum_{i=1}^{n+2} \sum_{j=0}^n T_{ij} * \log\frac{T_{ij}}{T..}}$
System omnivory index (SOI)	$\frac{\sum_i OI_i * \log(Q_i)}{\sum_i \log(Q_i)}$
Trophic levels (TL)	$TL_i = 1 + \sum_{j=1}^n DC_{ij} TL_j$
Omnivory index of each consumer group	$OI_i = \sum_{j=1}^N (TL_j - (TL_i - 1))^2 * DC_{ij}$

DC_{ij} is the fraction of the prey item (j) in the diet of predator (i), and assuming a TL of 1 for primary producers and detritus.

Appendix 5.8. MixSIAR derived dietary contributions (% of total diet, lower and upper boundaries of 90% credibility intervals) for meiofauna in the mudflats, seagrass beds and sandflat in the Marennes-Oléron Bay (MO) and Sylt-Rømø Bight (SR). SOM = sediment organic matter; SPOM = suspended particulate organic matter; NBA = selective deposit feeders; NDF = non-selective deposit feeders; NEF = epigrowth feeders; NOM = omnivores/predators; COP = benthic copepods.

Food sources	Mudflat MO					Seagrass MO				
	NBA	NDF	NEF	NOM	COP	NBA	NDF	NEF	NOM	COP
Bacteria	72.8–88.2	4.7–16.5	7.7–18.8	0.1–7.3	4.2–17.1	38.6–61.3	2.1–12.0	0.8–5.4	0.2–9.2	1.5–9.6
SPOM	0.1–7.6	0.0–8.0	0.1–11.0	0.2–10.8	0.1–8.3	0.2–21.1	0.1–9.0	0.0–4.2	0.2–12.8	0.0–6.7
SOM	0.2–7.4	0.1–9.9	0.1–13.9	0.3–15.8	0.1–11.2	0.3–15.9	0.1–14.5	0.0–6.5	0.4–19.5	0.1–10.2
Microphytobenthos	8.3–21.1	75.0–92.7	70.0–87.9	2.4–45.4	73.8–93.3	26.3–49.1	76.0–94.9	88.9–98.1	0.6–26.6	81.7–96.5
Selective deposit feeding nematodes	-	-	-	0.1–6.3	-	-	-	-	0.3–16.0	-
Non-selective deposit feeding nematodes	-	-	-	2.5–56.2	-	-	-	-	5.8–61.3	-
Epigrowth feeding nematodes	-	-	-	0.9–43.8	-	-	-	-	1.3–49.1	-
Benthic copepods	-	-	-	1.8–54.5	-	-	-	-	1.0–44.9	-

Food sources	Mudflat SR					Seagrass SR				
	NBA	NDF	NEF	NOM	COP	NBA	NDF	NEF	NOM	COP
Bacteria	8.5–39.8	0.5–6.3	0.5–5.4	0.1–7.8	1.9–18.7	2.8–42.5	0.7–15.2	0.8–17.3	0.2–7.7	1.1–22.6
SPOM	0.4–44.8	0.1–7.5	0.1–6.7	0.3–14.9	0.2–26.4	0.9–52.2	0.3–22.3	0.3–27.7	0.2–13.0	0.3–36.7
SOM	0.4–29.8	0.1–8.7	0.0–7.5	0.4–19.2	0.1–32.0	1.1–38.8	0.3–28.7	0.3–40.4	0.3–16.1	0.4–46.5
Microphytobenthos	32.8–65.5	85.0–97.8	86.5–98.1	0.8–29.4	55.3–86.6	23.5–62.7	57.9–93.0	48.7–87.9	0.7–38.7	37.6–84.0
Selective deposit feeding nematodes	-	-	-	0.4–20.7	-	-	-	-	0.6–26.2	-
Non-selective deposit feeding nematodes	-	-	-	1.7–50.4	-	-	-	-	3.7–65.6	-
Epigrowth feeding nematodes	-	-	-	2.3–59.5	-	-	-	-	1.1–43.3	-
Benthic copepods	-	-	-	0.9–41.2	-	-	-	-	0.8–43.4	-

Food sources	Sandflat SR				
	NBA	NDF	NEF	NOM	COP
Bacteria	-	0.1–10.6	0.1–15.5	0.1–7.9	0.3–13.8
SPOM	-	0.2–16.0	0.3–24.8	0.2–11.8	0.5–21.2
SOM	-	1.2–45.9	1.7–61.7	0.5–25.7	3.3–54.3
Microphytobenthos	-	50.1–89.9	35.2–78.4	1.0–58.4	40.4–78.8
Non-selective deposit feeding nematodes	-	-	-	2.3–65.9	-
Epigrowth feeding nematodes	-	-	-	0.8–47.9	-
Benthic copepods	-	-	-	0.9–49.0	-

Appendix 5.9. Estimated flows (in $\text{mgC m}^{-2} \text{d}^{-1}$, mean \pm standard deviation) in the food webs of the mudflats, seagrass beds and sandflat in the Marennes-Oléron Bay (MO) and Sylt-Rømø Bight (SR). BBA = benthic bacteria, BDF = benthic deposit feeding macrofauna, BGR = benthic grazing macrofauna, BOM = benthic omnivorous macrofauna, BFI = benthic fish, COP = benthic copepods, CO₂ = loss due respiration, CBR = carnivorous birds, Export = flow being exported from the system, FIX = growth primary production, HBR = herbivorous birds, Input = flow coming from outside the system, MPB = microphytobenthos, MZO = microzooplankton, NBA = selective deposit feeding nematodes, NDF = non-selective deposit feeding nematodes, NEF = epigrowth feeding nematodes, NOM = omnivorous/predating nematodes, PBA = pelagic bacteria, PHY = phytoplankton, SPOM = suspended particulate organic matter, SOM = sediment organic matter, SUS = benthic suspension feeding macrofauna, ZOO = mesozooplankton, ZOS = *Zostera noltei* material.

		Mudflat MO	Mudflat SR	Seagrass MO	Seagrass SR	Sandflat SR
FIX	mpb	1215.2 \pm 71.9	1023.1 \pm 178.0	1043.1 \pm 48.9	857.8 \pm 86.6	774.4 \pm 68.8
FIX	zos	-	-	45.1 \pm 2.4	792.8 \pm 161.3	-
FIX	phy	604.9 \pm 178.2	-	44.8 \pm 10.7	-	-
Input	pba	-	0.3 \pm 0.0	88.0 \pm 5.0	2.0 \pm 0.3	4.0 \pm 0.7
Input	pom	308.0 \pm 187.5	52.9 \pm 8.4	574.4 \pm 29.1	54.0 \pm 7.6	39.2 \pm 24.5
Input	phy	-	237.4 \pm 43.3	149.3 \pm 6.8	247.5 \pm 30.4	446.5 \pm 75.2
Input	zoo	-	-	94.2 \pm 4.3	-	0.0 \pm 0.0
Input	bfi	-	-	162.0 \pm 28.7	-	-
Input	hbr	-	-	0.6 \pm 0.1	-	-
Input	cbr	-	-	3.9 \pm 0.7	-	-
Input	doc	-	-	971.8 \pm 21.6	-	-
phy	mzo	204.8 \pm 70.9	-	-	-	-
phy	zoo	26.8 \pm 22.2	-	14.3 \pm 11.3	-	274.6 \pm 43.4
phy	sus	0.0 \pm 0.0	224.2 \pm 43.4	2.8 \pm 1.6	245.9 \pm 30.4	171.5 \pm 68.5
phy	bfi	1.3 \pm 1.2	-	-	-	-
phy	bom	-	13.3 \pm 2.3	-	1.6 \pm 0.3	0.4 \pm 0.1
mpb	nba	6.8 \pm 1.8	16.1 \pm 3.9	5.7 \pm 1.3	11.4 \pm 3.5	0.5 \pm 0.4
mpb	ndf	290.8 \pm 37.4	198.8 \pm 79.8	74.9 \pm 21.6	177.8 \pm 45.4	15.4 \pm 3.6
mpb	nef	314.1 \pm 45.4	103.6 \pm 19.4	115.4 \pm 17.1	153.6 \pm 76.3	9.9 \pm 3.2
mpb	nom	56.3 \pm 21.9	17.2 \pm 9.6	7.8 \pm 3.4	29.2 \pm 19.0	7.7 \pm 3.6
mpb	cop	22.9 \pm 3.8	24.6 \pm 4.9	1.8 \pm 0.2	20.8 \pm 5.8	29.3 \pm 7.5
mpb	bba	-	-	16.2 \pm 9.3	-	-
mpb	phy	0.6 \pm 0.1	-	-	-	-
mpb	bdf	0.1 \pm 0.1	12.2 \pm 2.1	0.8 \pm 0.4	54.3 \pm 9.6	30.1 \pm 5.3
mpb	bgr	17.6 \pm 11.6	253.7 \pm 30.5	86.6 \pm 11.2	162.8 \pm 11.3	1.2 \pm 0.2
mpb	sus	1.8 \pm 1.5	117.6 \pm 22.0	4.1 \pm 2.1	72.5 \pm 13.0	65.8 \pm 10.7
mpb	bom	1.3 \pm 1.2	14.6 \pm 2.5	0.1 \pm 0.1	2.1 \pm 0.4	0.4 \pm 0.1
mpb	bfi	0.1 \pm 0.1	-	39.7 \pm 2.3	-	-
mpb	hbr	-	-	21.3 \pm 16.3	-	-
zos	bgr	-	-	18.8 \pm 2.1	-	-
zos	bdf	-	-	0.6 \pm 0.4	-	-
zos	bom	-	-	0.1 \pm 0.1	1.2 \pm 0.2	-

zos	hbr	-	-	13.8 ± 2.0	43.8 ± 7.1	-
doc	pba	-	-	188.2 ± 38.5	-	-
doc	bba	-	-	361.9 ± 43.3	-	-
pom	nba	1.7 ± 1.0	5.6 ± 3.7	1.4 ± 0.9	5.3 ± 3.4	0.5 ± 0.4
pom	ndf	14.6 ± 7.7	6.8 ± 5.0	3.8 ± 2.7	11.9 ± 8.7	1.7 ± 1.1
pom	nef	25.3 ± 12.3	3.4 ± 2.2	2.5 ± 1.6	13.3 ± 9.5	2.1 ± 1.4
pom	nom	10.1 ± 6.0	7.9 ± 4.7	3.7 ± 1.7	8.4 ± 5.7	1.4 ± 0.8
pom	cop	1.1 ± 0.7	3.8 ± 2.6	0.1 ± 0.0	4.9 ± 3.6	5.0 ± 3.0
pom	pba	624.3 ± 66.0	-	24.4 ± 23.3	-	-
pom	mzo	143.4 ± 127.5	-	-	-	-
pom	zoo	29.2 ± 25.3	-	28.2 ± 21.0	-	-
pom	sus	0.3 ± 0.0	13.8 ± 9.7	3.3 ± 1.8	9.8 ± 8.3	65.0 ± 12.8
pom	bfi	1.3 ± 1.2	-	-	-	-
pom	bom	-	11.6 ± 8.7	-	0.3 ± 0.1	1.5 ± 1.4
som	nba	1.7 ± 1.0	4.7 ± 2.9	1.2 ± 0.7	5.3 ± 3.0	0.5 ± 0.4
som	ndf	19.3 ± 8.5	9.6 ± 7.1	6.0 ± 3.9	44.0 ± 24.7	4.3 ± 2.6
som	nef	36.3 ± 12.7	3.9 ± 2.5	3.7 ± 2.2	65.3 ± 54.6	4.5 ± 2.6
som	nom	16.3 ± 8.8	10.9 ± 6.2	6.1 ± 2.5	13.5 ± 7.9	3.2 ± 1.8
som	cop	1.5 ± 0.9	4.6 ± 3.1	0.1 ± 0.1	7.0 ± 4.6	11.6 ± 6.1
som	bba	286.1 ± 34.2	572.3 ± 41.2	7.6 ± 6.3	661.9 ± 103.0	306.2 ± 22.8
som	bgr	25.6 ± 13.7	40.8 ± 6.9	28.2 ± 8.6	33.9 ± 5.9	-
som	bdf	0.1 ± 0.1	23.4 ± 16.9	0.4 ± 0.3	44.8 ± 36.0	12.2 ± 10.0
som	sus	0.1 ± 0.1	294.0 ± 116.3	4.5 ± 2.4	52.4 ± 39.9	132.6 ± 57.3
som	bom	-	14.3 ± 2.5	0.1 ± 0.0	26.9 ± 3.7	20.5 ± 1.4
som	bfi	1.3 ± 1.1	-	-	-	-
pba	mzo	70.3 ± 46.9	-	-	-	-
pba	sus	0.0 ± 0.0	0.3 ± 0.0	-	2.0 ± 0.3	4.0 ± 0.7
pba	zoo	-	-	59.9 ± 25.4	-	-
bba	nba	34.9 ± 4.6	7.5 ± 3.1	8.2 ± 1.7	5.7 ± 3.1	0.5 ± 0.4
bba	ndf	18.9 ± 3.6	6.9 ± 4.8	8.5 ± 3.6	19.6 ± 12.1	1.2 ± 0.7
bba	nef	33.0 ± 5.0	3.2 ± 1.7	4.7 ± 1.7	21.8 ± 18.2	1.3 ± 0.9
bba	nom	3.4 ± 2.7	4.1 ± 2.6	3.0 ± 1.2	5.9 ± 3.7	0.9 ± 0.6
bba	cop	2.5 ± 1.0	3.4 ± 1.8	0.1 ± 0.0	4.0 ± 2.3	3.3 ± 2.0
bba	bdf	0.0 ± 0.0	85.0 ± 13.0	0.2 ± 0.1	225.5 ± 35.7	105.6 ± 9.9
bba	bgr	2.8 ± 2.4	110.0 ± 31.5	16.6 ± 2.4	13.1 ± 11.3	2.8 ± 1.4
bba	sus	0.1 ± 0.0	34.9 ± 6.1	-	40.8 ± 7.3	31.5 ± 5.5
bba	bom	1.3 ± 1.2	58.2 ± 9.8	-	3.4 ± 0.6	0.7 ± 0.1
nba	nom	1.6 ± 1.1	3.7 ± 2.3	0.5 ± 0.2	3.6 ± 1.8	0.2 ± 0.1
ndf	nom	32.5 ± 13.5	28.5 ± 17.2	7.6 ± 2.4	40.2 ± 21.5	1.6 ± 0.9
nef	nom	45.6 ± 19.3	15.4 ± 8.2	17.8 ± 3.9	25.6 ± 17.3	1.4 ± 1.0
cop	nom	4.8 ± 1.2	13.9 ± 8.4	0.5 ± 0.1	19.0 ± 9.9	7.0 ± 3.2
mzo	zoo	65.4 ± 36.2	-	-	-	-
mzo	sus	0.0 ± 0.0	-	-	-	-
zoo	sus	0.0 ± 0.0	-	-	-	-
nba	bom	0.9 ± 0.8	3.0 ± 2.2	0.0 ± 0.0	1.8 ± 1.5	0.2 ± 0.1

ndf	bom	1.9 ± 1.6	12.4 ± 9.9	0.0 ± 0.0	4.1 ± 3.8	1.0 ± 0.9
nef	bom	1.9 ± 1.7	7.8 ± 6.3	0.1 ± 0.0	3.8 ± 3.5	1.1 ± 1.0
nom	bom	1.8 ± 1.4	16.3 ± 8.1	0.0 ± 0.0	7.1 ± 4.3	1.1 ± 0.9
cop	bom	1.0 ± 0.9	9.6 ± 7.6	0.0 ± 0.0	3.6 ± 3.3	35.7 ± 8.0
zoo	bom	22.3 ± 1.7	-	0.1 ± 0.0	-	-
bdf	bom	0.0 ± 0.0	0.5 ± 0.1	0.0 ± 0.0	0.3 ± 0.1	0.4 ± 0.1
bgr	bom	4.8 ± 3.0	-	0.1 ± 0.0	7.2 ± 5.5	-
sus	bom	0.1 ± 0.1	0.8 ± 0.1	0.1 ± 0.0	0.4 ± 0.1	0.1 ± 0.0
bom	bom	-	0.2 ± 0.0	-	0.8 ± 0.1	1.3 ± 0.2
bfi	bom	-	-	0.1 ± 0.0	-	-
nba	bfi	0.7 ± 0.7	0.0 ± 0.0	0.3 ± 0.2	0.0 ± 0.0	0.0 ± 0.0
ndf	bfi	1.2 ± 1.1	0.0 ± 0.0	3.0 ± 2.2	0.2 ± 0.0	0.0 ± 0.0
nef	bfi	1.2 ± 1.1	0.0 ± 0.0	7.1 ± 4.9	0.6 ± 0.1	0.0 ± 0.0
nom	bfi	1.2 ± 1.0	0.0 ± 0.0	9.1 ± 1.5	0.2 ± 0.0	0.0 ± 0.0
cop	bfi	0.8 ± 0.7	0.0 ± 0.0	-	0.0 ± 0.0	0.0 ± 0.0
zoo	bfi	2.2 ± 1.7	-	19.4 ± 9.3	-	0.0 ± 0.0
bdf	bfi	0.0 ± 0.0	0.1 ± 0.0	0.1 ± 0.1	0.1 ± 0.0	0.2 ± 0.0
bgr	bfi	0.9 ± 0.9	0.0 ± 0.0	9.7 ± 6.8	0.0 ± 0.0	-
sus	bfi	0.1 ± 0.1	0.0 ± 0.0	1.5 ± 0.1	0.3 ± 0.1	0.1 ± 0.0
bom	bfi	1.0 ± 0.9	0.1 ± 0.0	0.1 ± 0.0	1.0 ± 0.2	0.1 ± 0.0
bfi	bfi	-	-	-	3.1 ± 1.9	-
bdf	cbr	0.0 ± 0.0	6.0 ± 1.0	0.1 ± 0.1	0.5 ± 0.1	1.4 ± 0.2
bgr	cbr	4.8 ± 3.0	90.1 ± 11.7	18.5 ± 7.0	0.8 ± 0.1	0.1 ± 0.0
sus	cbr	0.1 ± 0.1	3.1 ± 0.5	-	1.7 ± 0.3	8.1 ± 1.4
bom	cbr	6.6 ± 3.1	36.3 ± 17.9	-	6.6 ± 1.7	9.3 ± 4.8
bfi	cbr	0.2 ± 0.1	-	-	-	-
mpb	CO2	196.1 ± 71.9	128.3 ± 70.1	177.1 ± 12.8	92.1 ± 36.9	179.8 ± 97.1
phy	CO2	65.1 ± 27.1	-	7.7 ± 3.8	-	-
zos	CO2	-	-	4.2 ± 1.7	520.6 ± 100.0	-
nba	CO2	8.8 ± 0.7	0.5 ± 0.0	0.3 ± 0.1	0.4 ± 0.0	0.0 ± 0.0
ndf	CO2	62.8 ± 5.4	5.1 ± 0.3	3.1 ± 0.8	5.3 ± 0.3	3.5 ± 0.2
nef	CO2	76.1 ± 6.7	1.7 ± 0.1	7.9 ± 2.0	14.5 ± 0.9	2.0 ± 0.1
nom	CO2	27.8 ± 14.4	1.7 ± 0.1	3.0 ± 0.8	5.6 ± 0.3	5.2 ± 0.3
cop	CO2	12.4 ± 1.0	0.5 ± 0.0	0.7 ± 0.0	0.5 ± 0.0	4.4 ± 0.3
bba	CO2	157.1 ± 34.1	155.9 ± 55.2	305.0 ± 41.3	267.5 ± 78.6	103.8 ± 30.0
pba	CO2	430.7 ± 45.5	-	84.3 ± 20.6	-	-
zoo	CO2	49.1 ± 0.0	-	52.1 ± 5.0	-	93.4 ± 71.5
bdf	CO2	0.1 ± 0.0	50.9 ± 6.8	1.0 ± 0.1	145.1 ± 12.2	62.7 ± 4.3
bgr	CO2	12.5 ± 4.1	81.2 ± 12.1	74.3 ± 5.3	82.3 ± 4.8	2.0 ± 0.6
sus	CO2	0.1 ± 0.1	315.0 ± 29.1	7.5 ± 0.2	205.0 ± 21.6	246.6 ± 57.9
bom	CO2	11.2 ± 0.7	56.8 ± 20.6	0.3 ± 0.0	19.0 ± 1.5	16.2 ± 2.7
mzo	CO2	96.7 ± 84.8	-	-	-	-
cbr	CO2	5.0 ± 3.0	63.8 ± 34.4	11.7 ± 4.7	5.6 ± 1.4	10.8 ± 4.0
hbr	CO2	-	-	22.1 ± 10.8	24.3 ± 13.5	-
bfi	CO2	8.0 ± 1.8	0.1 ± 0.1	58.1 ± 22.6	1.1 ± 0.5	0.2 ± 0.1

mpb	doc	-	-	491.7 ± 25.1	-	-
phy	doc	-	-	5.8 ± 1.4	-	-
mpb	som	306.7 ± 49.3	136.4 ± 74.9	-	81.3 ± 33.5	434.3 ± 135.8
phy	pom	124.8 ± 39.2	-	24.0 ± 12.9	-	-
zos	doc	-	-	1.5 ± 0.6	7.0 ± 5.1	-
zos	som	-	-	1.9 ± 1.7	220.2 ± 113.9	-
nba	doc	-	-	7.1 ± 4.5	-	-
ndf	doc	-	-	21.5 ± 18.0	-	-
nef	doc	-	-	29.3 ± 24.0	-	-
nom	doc	-	-	15.5 ± 10.1	-	-
cop	doc	-	-	0.7 ± 0.2	-	-
bba	doc	-	-	39.4 ± 17.3	-	-
pba	doc	-	-	65.7 ± 22.7	-	-
zoo	doc	-	-	25.2 ± 12.3	-	-
nba	som	33.2 ± 5.1	26.6 ± 4.4	8.3 ± 4.6	21.9 ± 3.9	1.6 ± 0.3
ndf	som	245.3 ± 36.3	176.1 ± 73.1	57.8 ± 29.4	203.4 ± 52.5	16.5 ± 3.1
nef	som	283.8 ± 46.2	89.2 ± 18.0	64.1 ± 28.6	209.3 ± 128.1	13.2 ± 3.2
nom	som	139.7 ± 34.4	83.8 ± 22.0	19.4 ± 10.6	132.4 ± 35.5	17.1 ± 2.9
cop	som	9.0 ± 3.8	12.3 ± 8.6	0.1 ± 0.0	13.5 ± 9.1	2.0 ± 1.9
som	pom	416.2 ± 67.9	-	131.8 ± 13.6	-	-
pom	som	188.0 ± 114.6	-	110.3 ± 21.5	-	-
bba	som	32.0 ± 3.2	103.2 ± 61.9	-	54.5 ± 40.7	54.6 ± 28.4
pba	pom	123.2 ± 56.8	-	-	-	-
mzo	pom	110.0 ± 32.8	-	-	-	-
zoo	pom	47.7 ± 18.9	-	11.9 ± 8.4	-	38.1 ± 25.0
bdf	som	0.1 ± 0.0	62.7 ± 16.1	0.8 ± 0.2	178.7 ± 30.1	83.2 ± 10.5
bgr	som	23.1 ± 9.1	233.2 ± 0.0	47.7 ± 10.2	119.6 ± 12.2	1.9 ± 0.9
sus	som	0.2 ± 0.0	366.1 ± 110.0	5.6 ± 1.3	216.0 ± 50.8	215.5 ± 72.3
bom	som	19.1 ± 1.8	69.2 ± 18.2	0.3 ± 0.0	37.1 ± 4.5	37.6 ± 6.3
bfi	pom	3.8 ± 1.6	0.1 ± 0.1	30.7 ± 9.6	1.4 ± 0.5	0.2 ± 0.1
cbr	som	1.7 ± 0.3	69.7 ± 37.1	7.0 ± 3.0	3.9 ± 1.2	7.9 ± 3.1
hbr	som	-	-	13.0 ± 6.5	19.1 ± 13.0	-
phy	Export	182.7 ± 130.5	-	139.5 ± 6.6	-	-
som	Export	477.4 ± 85.5	450.0 ± 197.4	146.4 ± 36.1	557.7 ± 174.6	390.0 ± 138.6
pom	Export	94.5 ± 86.6	-	595.1 ± 43.3	-	-
zos	Export	-	-	4.2 ± 1.7	-	-
doc	Export	-	-	1125.3 ± 33.6	7.0 ± 5.1	-
sus	Export	0.1 ± 0.1	-	0 ± 0	-	-
cbr	Export	4.9 ± 3.0	2.1 ± 0.0	3.9 ± 0.7	0.1 ± 0.0	0.2 ± 0.0
bfi	Export	2.6 ± 1.8	0.0 ± 0.0	163.2 ± 30.1	0.1 ± 0.0	0.1 ± 0.1
mzo	Export	146.4 ± 129.2	-	-	-	-
som	Export	-	-	88.0 ± 4.3	-	143.0 ± 54.3
zoo	Export	-	-	90.6 ± 5.1	-	-
pba	Export	-	-	0.6 ± 0.1	0.3 ± 0.0	-
hbr	Export	-	-	0.6 ± 0.1	0.3 ± 0.0	-

Appendix 5.10. Statistical comparison of ecological network analysis indices between the mudflats, seagrass beds and sandflat in the Marennes-Oléron Bay (MO) and Sylt-Rømø Bight (SR) using Cliff's delta statistic. Effects are described as “negligible”, “small”, “medium” and “large” after Romano et al. (2006). T.. = total system throughput, FCI = Finn cycling index, SOI = system omnivory index, R/C = relative redundancy.

T..	Mudflat MO	Mudflat SR	Seagrass MO	Seagrass SR	Sandflat SR
Mudflat MO	-				
Mudflat SR	0.911 (large)	-			
Seagrass MO	0.049 (negligible)	1.0 (large)	-		
Seagrass SR	0.497 (large)	0.630 (large)	0.661 (large)	-	
Sandflat SR	1.0 (large)	0.868 (large)	1.0 (large)	1.0 (large)	-
FCI	Mudflat MO	Mudflat SR	Seagrass MO	Seagrass SR	Sandflat SR
Mudflat MO	-				
Mudflat SR	0.938 (large)	-			
Seagrass MO	1.0 (large)	1.0 (large)	-		
Seagrass SR	0.139 (negligible)	0.901 (large)	1.0 (large)	-	
Sandflat SR	0.475 (large)	0.968 (large)	1.0 (large)	0.598 (large)	-
SOI	Mudflat MO	Mudflat SR	Seagrass MO	Seagrass SR	Sandflat SR
Mudflat MO	-				
Mudflat SR	0.923 (large)	-			
Seagrass MO	0.871 (large)	0.474 (large)	-		
Seagrass SR	0.237 (small)	0.855 (large)	0.751 (large)	-	
Sandflat SR	0.981 (large)	0.753 (large)	0.911 (large)	0.969 (large)	-
R/C	Mudflat MO	Mudflat SR	Seagrass MO	Seagrass SR	Sandflat SR
Mudflat MO	-				
Mudflat SR	0.066 (negligible)	-			
Seagrass MO	1.0 (large)	1.0 (large)	-		
Seagrass SR	0.342 (medium)	0.728 (large)	1.0 (large)	-	
Sandflat SR	0.982 (large)	1.0 (large)	1.0 (large)	0.998 (large)	-
D/H	Mudflat MO	Mudflat SR	Seagrass MO	Seagrass SR	Sandflat SR
Mudflat MO	-				
Mudflat SR	0.991 (large)	-			
Seagrass MO	1.0 (large)	1.0 (large)	-		
Seagrass SR	0.979 (large)	0.234 (large)	1.0 (large)	-	
Sandflat SR	0.914 (large)	0.113 (negligible)	1.0 (large)	0.069 (negligible)	-
D/H of meiofauna	Mudflat MO	Mudflat SR	Seagrass MO	Seagrass SR	Sandflat SR
Mudflat MO	-				
Mudflat SR	0.155 (small)	-			
Seagrass MO	0.691 (large)	0.526 (large)	-		
Seagrass SR	0.993 (large)	0.993 (large)	0.999 (large)	-	
Sandflat SR	0.999 (large)	0.998 (large)	1.0 (large)	0.412 (medium)	-

B/H	Mudflat MO	Mudflat SR	Seagrass MO	Seagrass SR	Sandflat SR
Mudflat MO	-				
Mudflat SR	0.994 (large)	-			
Seagrass MO	1.0 (large)	1.0 (large)	-		
Seagrass SR	1.0 (large)	0.527 (large)	1.0 (large)	-	
Sandflat SR	0.969 (large)	0.335 (medium)	1.0 (large)	0.751 (large)	-
B/H of meiofauna	Mudflat MO	Mudflat SR	Seagrass MO	Seagrass SR	Sandflat SR
Mudflat MO	-				
Mudflat SR	0.987 (large)	-			
Seagrass MO	0.569 (large)	0.924 (large)	-		
Seagrass SR	0.134 (negligible)	0.846 (large)	0.349 (medium)	-	
Sandflat SR	0.348 (medium)	0.669 (large)	0.081 (negligible)	0.342 (medium)	-

Appendix 5.11. Mean trophic levels, export dependency, detritivory/herbivory (D/H) and bacterivory/herbivory (B/H) ratios of the food web in the mudflats, seagrass beds, and sandflat in the Marennes-Oléron Bay (MO) and the Sylt-Rømø Bight (SR). Letters displayed next to ratios indicate groups of samples with similar indices using Cliff's delta statistics.

	Mean trophic level	Export dependency (%)	B/H ratio	D/H ratio
Mudflat MO	2.4	12.0	0.15 ^A (± 0.03)	1.32 ^A (± 0.12)
Mudflat SR	2.4	7.6	0.28 ^B (± 0.05)	0.91 ^B (± 0.09)
Seagrass MO	2.1	4.1	0.04 ^C (± 0.00)	0.38 ^C (± 0.05)
Seagrass SR	2.3	6.2	0.32 ^B (± 0.04)	0.95 ^D (± 0.09)
Sandflat SR	2.2	13.0	0.25 ^B (± 0.04)	0.96 ^E (± 0.15)

Appendix 5.12. Production ($\text{mgC m}^{-2} \text{d}^{-1}$) and production/biomass ratios (d^{-1}) of meiofauna and macrofauna trophic groups and total meiofauna and total macrofauna in the mudflats, seagrass beds, and sandflat in the Marennes-Oléron Bay (MO) and the Sylt-Rømø Bight (SR).

	Production ($\text{mgC m}^{-2} \text{d}^{-1}$)					Production/biomass ratio (d^{-1})				
	Mudflat		Seagrass		Sandflat	Mudflat		Seagrass		Sandflat
	MO	SR	MO	SR	SR	MO	SR	MO	SR	SR
Selective deposit feeding nematodes	3.2	6.7	0.9	5.4	0.4	0.04	1.22	0.19	1.18	1.20
Non-selective deposit feeding nematodes	35.5	40.9	10.7	44.6	2.6	0.07	0.70	0.18	0.73	0.06
Epigrowth feeding nematodes	48.7	23.2	25.0	30.0	2.6	0.08	1.19	0.15	0.18	0.11
Omnivorous/predating nematodes	3.1	16.3	9.1	7.4	1.1	0.04	0.85	0.14	0.12	0.02
Benthic copepods	6.7	23.6	0.6	22.7	42.8	0.07	3.93	0.01	3.70	0.85
Meiofauna	35.8	30.6	14.5	27.7	13.6	0.03	0.28	0.04	0.09	0.08
Benthic deposit feeding macrofauna	10.5	90.1	28.2	8.0	0.1	0.015	0.011	0.007	0.001	0.002
Benthic grazing macrofauna	0.1	6.9	0.2	0.9	2.0	0.015	0.002	0.002	< 0.001	< 0.001
Suspension feeding macrofauna	2.0	3.6	1.6	2.4	8.3	0.047	0.001	0.001	< 0.001	< 0.001
Benthic omnivorous macrofauna	7.0	36.5	0.1	8.5	10.7	0.012	0.013	0.002	0.008	0.015
Macrofauna	8.7	41.3	19.8	3.2	6.8	0.005	0.003	0.001	< 0.001	< 0.001

Appendix 5.13. Transfer efficiency of benthic copepods and trophic groups of nematodes in the mudflats, seagrass beds, and sandflat in the Marennes-Oléron Bay (MO) and the Sylt-Rømø Bight (SR).

	Mudflat MO	Mudflat SR	Seagrass MO	Seagrass SR	Sandflat SR
Selective deposit feeding nematodes	7.0	19.9	5.3	19.4	19.8
Non-selective deposit feeding nematodes	10.3	18.4	10.2	17.6	11.5
Epigrowth feeding nematodes	11.9	20.3	20.1	11.8	14.4
Omnivorous/predating nematodes	1.8	16.0	22.7	5.1	4.7
Benthic copepods	23.8	64.8	28.0	61.7	87.0

Appendix 5.14. Detritivory/herbivory (D/H), bacterivory/herbivory (B/H) and bacterivory/detritivory (B/D) ratios for macrofauna in the mudflats, seagrass beds, and sandflat in the Marennes-Oléron Bay (MO) and the Sylt-Rømø Bight (SR).

	D/H ratio	B/H ratio	B/D ratio
Mudflat MO	1.26	0.20	0.16
Mudflat SR	0.63	0.45	0.72
Seagrass MO	0.32	0.15	0.46
Seagrass SR	0.31	0.53	1.69
Sandflat SR	0.86	0.54	0.62

Appendix 5.15. Dependency ratios of meiofauna (benthic copepods and trophic groups of nematodes) on food web compartments (benthic bacteria, suspended particulate organic matter (SPOM), sediment organic matter (SOM), microphytobenthos and seagrass material) in the mudflats, seagrass beds and sandflat in the Marennes-Oléron Bay (MO) and Sylt-Rømø Bight (SR).

	Nematodes –selective deposit feeders					Nematodes – non-selective deposit feeders				
	Mudflat MO	Mudflat SR	Seagrass MO	Seagrass SR	Sandflat SR	Mudflat MO	Mudflat SR	Seagrass MO	Seagrass SR	Sandflat SR
Benthic bacteria	0.86	0.34	0.52	0.31	0.35	0.07	0.06	0.10	0.14	0.10
SPOM	0.29	0.18	0.13	0.21	0.28	0.09	0.03	0.07	0.06	0.09
SOM	1.07	0.58	0.11	0.58	0.68	0.17	0.12	0.08	0.37	0.33
Microphytobenthos	0.87	0.77	0.59	0.65	0.66	0.96	0.96	0.88	0.85	0.88
Seagrass material	0.00	0.00	0.01	0.09	0.00	0.00	0.00	0.00	0.06	0.00

	Nematodes – epigrowth feeders					Nematodes – omnivores/predators				
	Mudflat MO	Mudflat SR	Seagrass MO	Seagrass SR	Sandflat SR	Mudflat MO	Mudflat SR	Seagrass MO	Seagrass SR	Sandflat SR
Benthic bacteria	0.10	0.05	0.04	0.17	0.14	0.09	0.15	0.11	0.18	0.13
SPOM	0.13	0.03	0.03	0.07	0.14	0.17	0.12	0.16	0.12	0.12
SOM	0.25	0.10	0.04	0.50	0.44	0.30	0.36	0.20	0.46	0.42
Microphytobenthos	0.94	0.96	0.95	0.81	0.82	0.92	0.85	0.79	0.77	0.84
Seagrass material	0.00	0.00	0.00	0.08	0.00	0.00	0.00	0.01	0.07	0.00

Benthic copepods					
	Mudflat MO	Mudflat SR	Seagrass MO	Seagrass SR	Sandflat SR
Benthic bacteria	0.11	0.17	0.06	0.18	0.13
SPOM	0.10	0.11	0.05	0.15	0.12
SOM	0.21	0.35	0.06	0.44	0.41
Microphytobenthos	0.96	0.86	0.92	0.75	0.84
Seagrass material	0.00	0.00	0.00	0.07	0.00

Appendix 5.16. Dependency ratios of macrofauna (benthic grazers, benthic deposit feeders, suspension feeders and benthic omnivores) on food web compartments (benthic bacteria, suspended particulate organic matter (SPOM), sediment organic matter (SOM), microphytobenthos and seagrass material) in the mudflats, seagrass beds and sandflat in the Marennes-Oléron Bay (MO) and Sylt-Rømø Bight (SR).

	Benthic grazers					Benthic deposit feeders				
	Mudflat	Mudflat	Seagrass	Seagrass	Sandflat	Mudflat	Mudflat	Seagrass	Seagrass	Sandflat
	MO	SR	MO	SR	SR	MO	SR	MO	SR	SR
Benthic bacteria	0.15	0.39	0.13	0.24	1.03	0.18	0.63	0.12	0.77	0.85
SPOM	0.12	0.01	0.08	0.01	0.08	0.13	0.04	0.09	0.04	0.08
SOM	0.73	0.66	0.23	0.46	1.41	0.78	1.79	0.26	1.45	1.42
Microphytobenthos	0.95	0.94	0.72	0.87	0.86	0.95	0.83	0.55	0.60	0.86
Seagrass material	0.00	0.00	0.13	0.08	0.00	0.00	0.00	0.30	0.25	0.00

	Suspension feeders					Benthic omnivores				
	Mudflat	Mudflat	Seagrass	Seagrass	Sandflat	Mudflat	Mudflat	Seagrass	Seagrass	Sandflat
	MO	SR	MO	SR	SR	MO	SR	MO	SR	SR
Benthic bacteria	0.15	0.18	0.02	0.16	0.22	0.13	0.49	0.08	0.22	0.15
SPOM	0.68	0.07	0.36	0.03	0.12	0.46	0.09	0.12	0.08	0.12
SOM	0.70	0.49	0.39	0.34	1.04	0.44	0.81	0.20	0.61	0.58
Microphytobenthos	0.71	0.45	0.48	0.28	0.64	0.56	0.78	0.59	0.76	0.85
Seagrass material	0.00	0.00	0.02	0.06	0.00	0.00	0.00	0.14	0.11	0.00

CHAPTER 6

General discussion

Interest of marine ecologists in the role of meiofauna in intertidal soft-bottom food webs originated from the following reasons: (1) their high abundance and cosmopolitan distribution (Heip et al. 1985; Giere 2009), (2) their high production (Escaravage et al. 1989; Chardy and Dauvin 1992; Danovaro et al. 2002b) and short turnover time (Kuipers et al. 1981), and (3) their intermediate trophic position connecting microalgae and bacteria (Pascal et al. 2008; Rzeznik-Orignac et al. 2008; Moens et al. 2014; Vafeiadou et al. 2014) to higher trophic levels (e.g. benthic fish, shrimps) (Coull 1999). Determining the biomass and feeding ecology of meiofauna in soft-bottom habitats and thereby exposing the linkage between potential food sources (e.g. primary producers, bacteria) and meiofauna significantly improves our understanding of the energy flows in food web functioning of coastal ecosystems.

This thesis aims at determining how changes of food sources (i.e., benthic diatoms, bacteria, detrital matter, and phytoplankton), and therefore of the properties (quantity, quality, availability) of the organic matter available to consumers, affect carbon fluxes from food sources to meiofauna in soft bottom coastal habitats. Such an assessment was carried out by comparing food web functioning of different habitats (seagrass beds, mudflats, sandflat) from two different ecosystems (five food webs in total). These different food web studies provided a range of cases which could be compared within each other to define how the food web functioning changes depending on available food sources. These comparisons were carried out following three steps, each step corresponding to a chapter of this thesis (Fig. 1.3).

The first part of this thesis aims at defining the temporal and spatial variations of food sources and meiobenthic assemblages in the five studied habitats, and at determining how food sources in soft-bottom intertidal food webs drive meiofauna community structure (Fig. 1.3: green section). To reach this objective, biomass of food sources and community structure of meiofauna (i.e., abundance, biomass and population structure) were determined to define the relationship between the different groups of meiofauna and their potential food sources. The effect of changes in availability, quality and quantity of food sources on the meiofauna community structure was determined by habitat comparisons.

Secondly, this thesis investigates the feeding ecology of the meiofauna in the different studied habitats (Fig. 1.3: blue section). Stable isotope compositions, fatty acid profiles and compound-specific stable isotope compositions of fatty acids of the food sources as well as of the two major groups of meiofauna (i.e., nematodes and benthic copepods) were combined to describe the trophodynamics of selected habitats.

Finally, this thesis aims at determining the flows of carbon in these different soft-bottom intertidal food webs (Fig. 1.3: orange section). Results from chapters 3 and 4 (i.e., biomass and contributions of food sources to major trophic groups of meiofauna) were included into pre-existing food web models of these soft-bottom intertidal habitats. This permitted improving the knowledge about the role of meiofauna in soft-bottom ecosystems as well as determining the fluctuations of this role within habitats dominated by different primary producers.

1. MAJOR RESULTS OF THIS THESIS

1.1. Flows of organic matter from food sources to meiofauna

1.1.1. *Microphytobenthos as the main food source for meiofauna*

This thesis highlights the importance of microphytobenthos as a food source for meiofauna in soft-bottom intertidal habitats by implementing information about community structure (Chapter 3) and food sources of meiofauna (Chapter 4) into food web models (Chapter 5). Carbon flows towards meiofauna were indeed dominated by the fluxes originating from microphytobenthos in the five studied intertidal habitats (Chapter 5), besides the large differences of food source biomass and abiotic factors between these habitats (Fig. 6.1: indicated in orange). Assessments of food sources, meiofauna biomass and taxonomy (Chapter 3) emphasized microphytobenthos to be one of the major drivers of meiofauna community structure (Fig. 6.1: indicated in green). The combination of trophic markers (e.g. stable isotopes and fatty acids) revealed that microphytobenthos is the main food source used by meiofauna in all studied food webs (Chapter 4, Fig. 6.1: indicated in blue).

The importance of microphytobenthos as a food source for meiofauna has been revealed before in intertidal habitats after studies on trophic markers (Rzeznik-Orignac et al. 2008; Leduc et al. 2009; Cnudde et al. 2015) and food web models (Chanton and Lewis 2002; Pinckney et al. 2003; van Oevelen et al. 2006). Like in this thesis, these studies highlighted low contributions of food sources such as detrital material, phytoplankton and seagrass, despite high biomass (i.e., seagrass) and/or production (i.e., phytoplankton). This demonstrates the selective feeding mode of meiofauna towards a food resource of high-quality: the microphytobenthos, as already observed by van Oevelen et al. (2006).

Selective feeding was also demonstrated for different trophic groups of nematodes and benthic copepods, as their main consumption flows originated from microphytobenthos, either directly (i.e., non-selective deposit feeding nematodes, epigrowth feeding nematodes, benthic copepods) or indirectly (omnivorous/predating nematodes). The important role of microphytobenthos as a food source for these trophic groups has been demonstrated before based on feeding experiment and trophic marker studies (Moens and Vincx 1997b; Moens et al. 1999a; Rzeznik-Orignac et al. 2008; Rzeznik-Orignac and Fichet 2012; Vafeiadou et al. 2014). Merely selective deposit feeding nematodes had a wider range of food sources with high contributions of microphytobenthos, bacteria and SOM. The important role of bacteria as a food source for this trophic group was highlighted in this thesis thanks to the integration of isotope compositions in food web models. The reliance of selective deposit feeders on bacteria was also pointed out by Vafeiadou et al. (2014) using stable isotope analyses, and it was further demonstrated that the type of food ingestion corresponds with their mouth morphology (Wieser 1953). However, the role of bacteria as a food source for meiofauna remains under debate and will be discussed later in section 3 “Role of bacteria as a food source to meiofauna?”.

Low seasonal and spatial variation in food source uses of nematodes and benthic copepods confirmed the importance of microphytobenthos as prevalent food source in soft-bottom intertidal habitats. Seasonal variation in contributions of microphytobenthos as a food source was low, most likely related to the constant biomass (Lebreton et al., 2009; Chapter 3), production and quality of microphytobenthos (Cebrián 1999). These parameters are generally more variable for other potential food sources, e.g. higher biomass of seagrass material in spring compared to autumn, higher amounts of detrital material in autumn than in spring (Chapter 3), and spring blooms increasing phytoplankton biomass and production (Héral et al. 1986; Galois et al. 1996). Contribution of microphytobenthos to the diet of meiofauna also displayed low to moderate variations between habitats, with flows from microphytobenthos to meiofauna ranging from 60–80% of their total consumption.

The second most important food source used by meiofauna differed between habitats, with varying contributions of SOM (7–23%), bacteria (7–10%) and SPOM (4–10%). Lowest contributions of microphytobenthos to meiofauna were observed in the seagrass bed and sandflat of the Sylt-Rømø Bight, where the contributions of SOM were relatively higher when compared to other habitats. But it is worth noting that SOM is very likely made of a large quantity of benthic microalgae. Quality of SOM was indeed high in these habitats, with a relatively higher amount of carbon originating from fresh microalgae (Chapter 3), which thus increases indirectly the contribution of microphytobenthos to meiofauna. The relatively higher amount of diatom fatty acid markers observed in SOM from the seagrass bed and sandflat of the Sylt-Rømø Bight confirmed this hypothesis. The outcomes of this thesis demonstrate the interest in studying multiple habitats with different characteristics (i.e., abiotic and biotic) over different seasons. Despite observing seasonal or spatial variation in availability and production of food sources, microphytobenthos remains the most important food source used by meiofauna. However, models could be improved for an even better understanding of the role of meiofauna and the importance of microphytobenthos as a food source. One method to improve model inputs (constraints) of food source contributions to meiofauna would be to combine trophic markers, e.g. stable isotopes and FAs, in mixing models. A much higher accuracy would be reached by estimating food source contributions using the stable isotope and FA compositions of trophic groups, which can provide more detailed information about the differences in feeding behavior (see section 3 “Recommendations for future research” for more details).

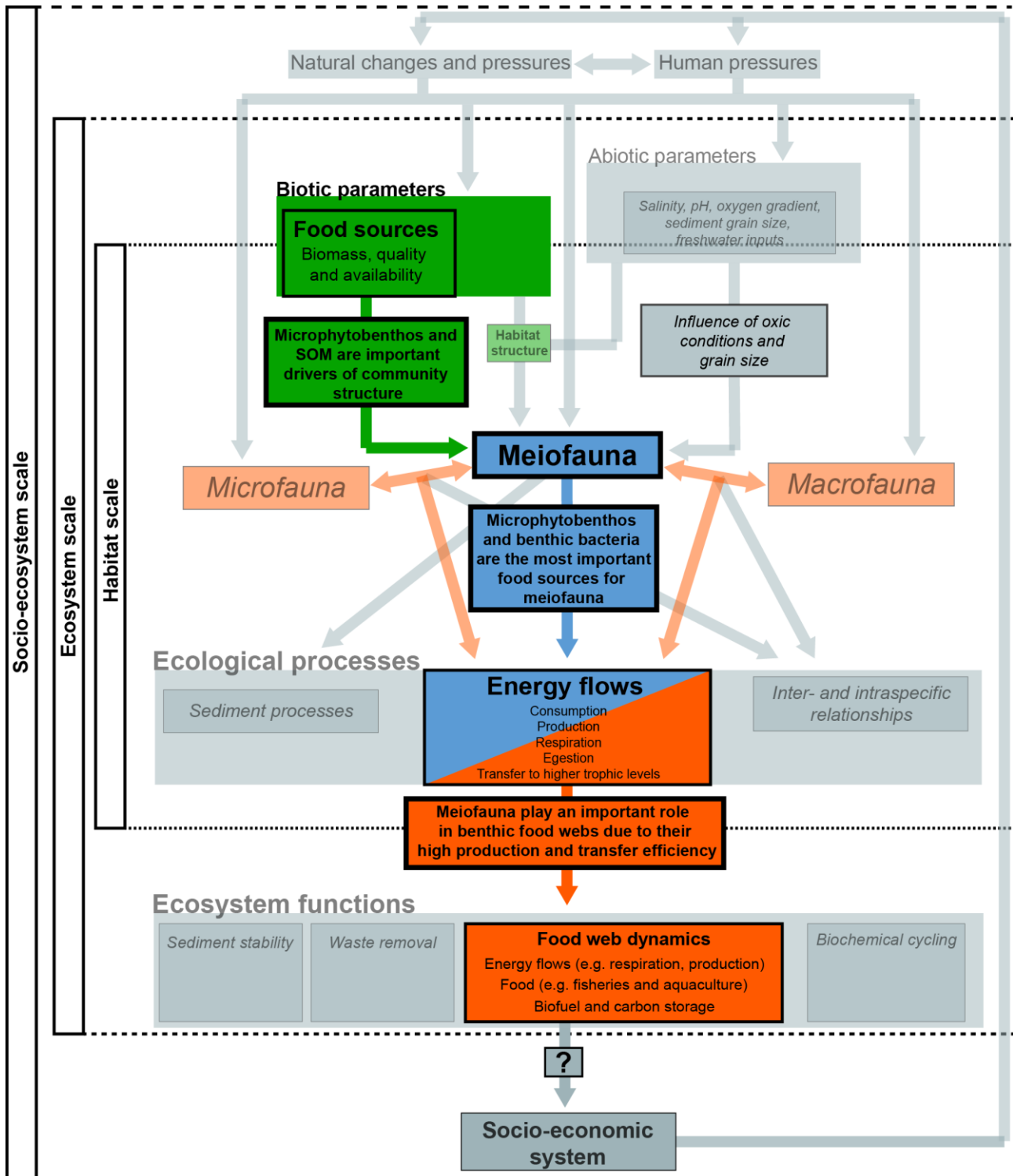

Figure 6.1. Conceptual diagram illustrating the influence of human and natural pressures on meiofauna community structure and the role of meiofauna in ecological processes and functions. The different observation scales (i.e., socio-ecosystem, ecosystem and habitat) are described on the left side of the diagram. Compartments and connections studied in the different chapters to address the questions of this thesis are colored in green (Chapter 3), blue (Chapter 4) and orange (Chapter 5). **Main conclusions of this thesis are highlighted in the colored boxes, with summarizing conclusions of chapters 3, 4, and 5, in green, blue and orange, respectively.** SOM = sediment organic matter

1.1.2. Role of bacteria as a food source for meiofauna?

The role of bacteria as a food source for meiofauna is highlighted in this thesis, as similar contributions of diatom and bacteria FA markers were observed in FA profiles of nematodes and benthic copepods (Chapter 4 and Fig. 6.1; indicated in blue). Carbon flow from bacteria to meiofauna ($7\text{--}93 \text{ mgC m}^{-2} \text{ d}^{-1}$) is, however, relatively low compared to the flow from microphytobenthos to meiofauna ($63\text{--}691 \text{ mgC m}^{-2} \text{ d}^{-1}$) (Chapter 5). The highest flow of carbon from bacteria to meiofauna was observed for selective deposit feeding nematodes, which depend on bacteria (Pascal et al. 2008, 2009; Vafeiadou et al. 2014). This is related to their buccal cavity that is mostly suitable for digestion of small particles (Wieser 1953). However, the role of bacteria as a food source for meiofauna remains under debate (Giere 2009), related to methodological challenges in determining bacteria isotope compositions.

Bacteria are challenging to implement in trophic ecology studies because they are difficult to isolate for isotope analyses (Coffin et al. 1990; Pelz et al. 1997) and their isotope compositions generally correspond to that of their substrate (Boschker et al. 2000). Vafeiadou et al. (2014) used the isotope composition of sulfide-oxidizing bacteria in their models, combining some of their own data with data from another study (Robinson and Cavanaugh 1995). In this thesis, compound specific isotope analyses of diatom and bacteria FA markers from meiofauna revealed that bacteria, ingested by these consumers, mainly use SOM and microphytobenthos as a substrate in the studied habitats. This confirmed that several groups of bacteria can occur in the sediment (e.g. sulfide-oxidizing bacteria, cyanobacteria, heterotrophic bacteria) (Gray and Herwig 1996; Spring et al. 2000; Gribben et al. 2017), leading to different isotope compositions, and that the reliance of consumers on these groups can vary, probably depending on feeding types, but maybe also due to other parameters: biotic (e.g., biomass, production, biofilm formation) and abiotic (e.g., oxygen concentration, hydrogen sulfide concentration). In this thesis, isotope compositions of sulfide-oxidizing bacteria (Vafeiadou et al. 2014) were used in mixing models to estimate food source contributions for meiofauna and thus underestimation of food source contributions of bacteria might have occurred.

Therefore, additional information is required on the various bacteria groups occurring in soft-bottom habitats. Determining the isotope compositions of these bacteria groups and their trophic fractionation factors would also provide very relevant information specifically to meiofauna feeding ecology, as well as for food web assessments in general. Another potential method in tackling this issue is to use multiple trophic markers (e.g. combination of stable isotope and FA analyses) which have been proven useful in determining the feeding behavior of bulk nematodes and benthic copepods (Chapter 4, Braeckman et al. 2015). Combining the information that is provided by these two trophic markers in mixing models would provide more accurate information about food source contributions to consumers, especially for bacteria in this case. CSIA of FAs can be used to determine the origin of bacteria and the substrate that they are relying on.

1.1.3. Fate of seagrass material and suspended particulate organic matter

Contribution of SPOM and seagrass material as food source to nematodes and benthic copepods was very low, as highlighted by trophic marker approaches (Chapter 4) and confirmed by food web models (Chapter 5). A low contributions is evident in all habitats (i.e., vegetated and unvegetated), even in seagrass beds where loads of seagrass and detrital material were high (Chapter 3) and where sedimentation of SPOM is favored (Asmus and Asmus 2000; Koch et al. 2006; Ouisse et al. 2012).

A low contribution of SPOM as a food source to meiofauna could be related to phytoplankton dynamics, as this primary producer is generally characterized by higher fluctuations in biomass and production compared to other food sources (Galois et al. 1996). More generally, the outcomes of trophic marker approaches (Chapter 4) and food web models (Chapter 5) demonstrated relatively low flows of SPOM to benthic consumers, highlighting a low coupling from the pelagos to the benthos in all habitats. Meiofauna have the ability to be more selective for food sources (Moens and Vincx 1997b), and thus generally select locally produced benthic diatoms over marine pelagic food sources (Maria et al. 2011), whereas macrofauna are known to rely on SPOM in benthic food webs (Asmus and Asmus 1991; Maria et al. 2011, 2012). These small flows of SPOM to meiofauna and to macrofauna raise questions about the fate of this organic matter in benthic food webs. It is likely that SPOM is used by benthic consumers in these systems, particularly suspension feeders (Asmus and Asmus 1991; Malet et al. 2008; Lebreton et al. 2011b), but the role of microphytobenthos is so high that the role of the SPOM is probably marginalized.

The very low contribution of fresh and detrital seagrass material (*Z. noltei*) as a food source to nematodes and benthic copepods is most likely related to the poor nutritional value and high lignocellulose content of vascular plants (Vizzini et al. 2002). Previous studies—based on stable isotope measurements only—demonstrated a relatively higher contribution of seagrass material as food source to meiofauna (Leduc et al. 2009; Lebreton et al. 2012; Vafeiadou et al. 2014) when compared to other potential food sources. As in pre-cited studies, the outcomes of mixing models in this thesis, that were based on stable isotope data, highlighted that contributions of seagrass material to nematodes and benthic copepods diets were non negligible. However, FA profiles of nematodes and benthic copepods had very low proportions of vascular plant FA markers, demonstrating the very low uses of seagrass material by meiofauna. This highlights that the role of seagrass material for meiofauna is probably generally overestimated due to some flaws in stable isotope methods. A major flaw is related to the overlapping isotope compositions of microphytobenthos and seagrass material which led to possible overestimations in the use of seagrass by meiofauna, when estimating contributions with isotope mixing models. Using stable isotope and fatty acid data in mixing models might provide a better assessment of the role of seagrass material.

The poor use of seagrass material by meiofauna (Chapter 4 and 5) and macrofauna (Jaschinski et al. 2008; Lebreton et al. 2011b) raises questions about the fate of seagrass material in coastal ecosystems. This material

may be buried into the deeper sediment layers (Duarte and Cebrián 1996), exported (McLusky and Elliott 2004; Mateo et al. 2006) and/or consumed by herbivorous birds (Baird et al. 2007; Pacella et al. 2013). Isotope compositions and fatty acid profiles of SOM from deep sediment layers would be helpful in determining the fate of this material. Besides its low role as a food source for meiofauna and macrofauna, it is worth nothing that seagrass provides a higher habitat complexity, leading to a higher biodiversity (Austen et al. 1998; Steyaert et al. 2003; Giere 2009).

1.2. Role and fate of meiofauna in benthic food webs

1.2.1. Meiofauna vs. macrofauna

Meiofauna and macrofauna are two important compartments in the food webs of soft-bottom coastal ecosystems, but have different roles in the functioning of these food webs. Meiofauna is characterized by a high production and has a very important role in the energy flows from microphytobenthos towards higher trophic levels. Macrofauna have much slower growth rates and a stronger energy storage due to their high biomass. Also, macrofauna relies on a much larger diversity of food sources.

Meiofauna play an important role in soft-bottom intertidal habitats as demonstrated by their high production ($15\text{--}36 \text{ mgC m}^{-2} \text{ d}^{-1}$), high transfer efficiency (23–28%) and short turnover time (4–37 days) (Chapter 5), despite their generally low biomass. In the studied habitats, production of meiofauna was in range with or higher than estimations by Chardy and Dauvin (1992), Danovaro et al. (2002) and Escaravage et al. (1989) ($10 \text{ to } 80 \text{ mgC m}^{-2} \text{ d}^{-1}$). Slightly higher production of meiofauna compared to macrofauna ($3\text{--}41 \text{ mgC m}^{-2} \text{ d}^{-1}$) is most likely related to their relatively higher weight-specific metabolic rate (Kuipers et al. 1981), shorter turn-over time (Gerlach 1971; Kuipers et al. 1981; Chapter 5) and higher number of annual generations (Vranken and Heip 1986; Moens and Vincx 1997a). Turnover times of meiofauna (4–37 days) were much lower than those of macrofauna (150–10,000 days), which can be allocated to a high throughput per gram of consumer (0.7–4.7), which was between 10 and 70 times higher than those of macrofauna (Chapter 5). Especially the consumption rate on microphytobenthos in relation to body weight is high for meiofauna when compared to that for macrofauna, with meiofauna consuming between 35 and 330% of their bodyweight on microphytobenthos, whereas macrofauna consumes less than 2% of their bodyweight on microphytobenthos. A lot of the energy that meiofauna obtains from microphytobenthos is transferred towards higher trophic levels (Danovaro et al., 2007).

Meiofauna, with their high carbon transfer from microphytobenthos to higher trophic levels, high production and short turn-over time, can play an important role in the ecosystem processes of soft-bottom intertidal ecosystems, such as participating in food web functioning and channeling flows of organic matter (Fig. 6.1). These ecosystem processes related to meiofauna are at the base of fisheries and aquaculture, and therefore benefits to human societies, as was highlighted by Schratzberger and Ingels (2017).

1.2.2. *Fate of meiofauna?*

Meiofauna is important for higher trophic levels in the studied habitats, as demonstrated by the flows towards their predators ($13\text{--}49 \text{ mgC m}^{-2} \text{ d}^{-1}$). Meiofauna are known to be of interest for higher trophic levels, even in aquaculture (Fleeger 2005), due to their high nutritional value (Sikora et al. 1977; Couch 1989; Coull 1999) and ability to biosynthesize highly unsaturated fatty acids (Rothstein and Gotz 1968; Bolla 1980). The flows of meiofauna towards higher trophic levels can even be higher than those of macrofauna (i.e., in the sandflat of the Sylt-Rømø Bight and the two seagrass beds). Meiofauna are a food source for benthic fish (e.g. mullets, gobies, flatfish, grunts and croakers) in intertidal habitats, such as mudflats (Lassere et al. 1975; Gordon and Duncan 1979; Smith et al. 1984; Smith and Coull 1987; Carpentier et al. 2014), sandflats (Castel and Lassere 1982; Hicks 1984; Pihl 1985; Gee 1987; Pockberger et al. 2014) and salt marshes (Lebreton et al. 2011a, 2013). These benthic fish benefit from the high production and short turnover time of meiofauna (Coull 1999), which can result in positive effects for human societies relying on fisheries (Schratzberger and Ingels 2017). However, the fate of meiofauna remains under debate (Giere 2009) and future research should focus on better assessing the flows from meiofauna to higher trophic levels.

2. RECOMMENDATIONS FOR FUTURE RESEARCH

This study provided some information about the role of meiofauna in soft-bottom ecosystems, and particularly about the importance of the carbon flows originating from microphytobenthos and transiting to higher trophic levels via meiofauna. Nevertheless, several improvements could be done to better assess the role of this compartment. Some of these improvements are mostly related to methodological issues while some other ones are more related to knowledge gaps.

Improving models could result in a better understanding of the role of meiofauna and the importance of microphytobenthos as a food source. Model inputs (constraints) of contributions of food sources to meiofauna could indeed be refined by **combining several trophic markers**, e.g. stable isotopes and FA analyses, which has been proven to be useful in determining the feeding behavior of meiofauna (Chapter 4, Braeckman et al. 2015). Using the outcomes provided by these **two trophic markers in mixing models** could provide more accurate contributions of food sources to consumers. For an even better understanding of food source contributions to meiofauna, the **stable isotope and fatty acid compositions of trophic groups** could be determined which could provide even more precise information on the differences in feeding behavior. Such measurements will need some fine tuning of isotope ratio mass spectrometers and gas chromatographs which could probably be done in a couple of years.

Additional information is also required on the **various bacteria groups** occurring in these habitats (e.g. sulfide-oxidizing, heterotrophic bacteria, cyanobacteria). Determining the **isotope compositions** of these bacteria groups could provide more detailed information on the meiofauna feeding ecology. However, bacteria are difficult to isolate, a required step to conduct stable isotope analyses (Coffin et al. 1990; Pelz et al. 1997). Therefore, **mixing models with stable isotope and fatty acid data** should be used, which can result in a higher precision on the role of bacteria within these food webs. **CSIA of FA markers** can then be used to determine the substrate of bacteria, and thus their origin.

Taking into account less abundant meiofauna taxa would also provide more detailed information on the global role of meiofauna within intertidal habitats. Because nematodes and benthic copepods are generally the most dominant meiofauna taxa (Herman et al. 1985; Giere 2009), this thesis focuses mainly on these taxa. However, future research should determine the **role of the less abundant meiofauna taxa (e.g. turbellarians, foraminifera, kinorhynchs) and their feeding ecology**, especially the larger predating species (even species between 500 µm and 1mm). Integrating these groups would probably not change the major flows measured in this thesis, but could result in **more diverse flows** of energy from food sources towards meiofauna and an elucidation of the **predation within the meiofauna compartment** (Giere 2009) which could affect the food web properties. For example, more diverse flows from food resources to meiofauna could result in more similar parallel pathways resulting in a higher redundancy, and thereby a higher stability of the food web.

Expanding the knowledge and methodology gained in this thesis to **other habitats** would provide more detailed information on the global role of meiofauna within intertidal habitats, as well as on the **fate of organic material** (i.e., seagrass, SPOM) in different intertidal habitats. This thesis demonstrated that the role of seagrass material as a food source for meiofauna was negligible. Determination of the food resources of meiofauna in a larger range of **vegetated habitats**, such as mangroves, salt marshes and other seagrass meadows (e.g. *Posidonia*), could provide more information on changes in meiofauna feeding ecology in relation to the food source availability. Combination of trophic markers would be of high importance in such case, since the isotope compositions of food sources overlap, e.g. as in salt marshes (Currin et al. 1995), and seagrass beds (Lebreton et al. 2011b). With such information on the meiofauna feeding ecology in vegetated habitats, knowledge about the food webs of these habitats would then be improved, providing description of the **potential fate of detrital organic matter** in these systems dominated by vascular plants.

A better assessment of the **fate of meiofauna** within benthic ecosystems would also provide a better understanding of the role of meiofauna in the functioning of coastal habitats. Due to their high nutritional value (Sikora et al. 1977; Couch 1989; Coull 1999) and their ability to biosynthesize highly unsaturated fatty acids (Rothstein and Gotz 1968; Bolla 1980), nematodes can represent an important food source for fish and crustaceans in benthic food webs (Gee 1989; Coull 1999). Thanks to the development of new methods to determine flows of organic matter (i.e., stable isotopes, fatty acids), a good amount of information has been gained about food resources used by these consumers. But the role of meiofauna as a food resource for higher trophic levels still needs to be better assessed, with a focus on how this role may change depending on spatial and temporal variations.

Stomach content analyses, that are generally used for the determination of consumption on meiofauna (Alheit and Scheibel 1982; Hicks 1984; Gee 1987, 1989; Smith and Coull 1987; Coull 1999), may lead to underestimation of the **contribution of nematodes as a food source to fish**, because of a quicker digestion of nematodes compared to benthic copepods (Scholz et al. 1991). The development of new methods (i.e., trophic markers) during the last years may help at reducing this uncertainty related to differences in digestion. To better assess the fate of meiofauna, **the combination of several techniques**, e.g. molecular techniques, trophic markers and stomach content analyses, would be very useful. **Implementation of the outcomes into existing food web models**, could result in a more detailed elucidation of the role of meiofauna in benthic intertidal food webs.

References

References

- Admiraal W, Peletier H, Zomer H (1982) Observations and experiments on the population dynamics of epipelagic diatoms from an estuarine mudflat. *Estuar Coast Shelf Sci* 14:471–487. doi: 10.1016/S0302-3524(82)80071-6
- Agogue H, Mallet C, Orvain F, De Crignis M, Mornet F, Dupuy C (2014) Bacterial dynamics in a microphytobenthic biofilm: A tidal mesocosm approach. *J Sea Res* 92:36–45. doi: 10.1016/j.seares.2014.03.003
- Alheit J, Scheibel W (1982) Benthic harpacticoids as a food source for fish. *Mar Biol* 70:141–147. doi: 10.1007/BF00397678
- Alongi DM (1998) Coastal ecosystem processes. CRC Press, Boca Raton, USA
- Anesio AM, Abreu PC, Biddanda BA (2003) The role of free and attached microorganisms in the decomposition of estuarine macrophyte detritus. *Estuar Coast Shelf Sci* 56:197–201. doi: 10.1016/S0272-7714(02)00152-X
- Arifin Z, Bendell-Young LI (1997) Feeding response and carbon assimilation by the blue mussel *Mytilus trossulus* exposed to environmentally relevant seston matrices. *Mar Ecol Prog Ser* 160:241–253.
- Armonies W, Hellwig-Armonies M (1987) Synoptic patterns of meiofaunal and macrofaunal abundances and specific composition in littoral sediments. *Helgoländer Meeresuntersuchungen* 41:83–111. doi: 10.1007/BF02365101
- Asmus H (1987) Secondary production of an intertidal mussel bed community related to its storage and turnover compartments. *Mar Ecol Prog Ser* 39:251–266. doi: 10.3354/meps039251
- Asmus H (2011) Functioning of intertidal ecosystems of the Wadden Sea material exchange of the Sylt-Rømø Bight and its relation to habitat and species diversity. Christian Albrechts University, Kiel, Germany
- Asmus H, Asmus RM (1985) The importance of grazing food chain for energy flow and production in three intertidal sand bottom communities of the northern Wadden Sea. *Helgoländer Meeresuntersuchungen* 39:273–301. doi: 10.1007/BF01992775
- Asmus H, Asmus RM (1993) Phytoplankton-mussel bed interactions in intertidal ecosystems. In: Dame RF (ed) *Bivalve Filter Feeders*. Springer, Berlin, Germany, pp 57–84
- Asmus H, Asmus RM (1998) The role of macrobenthic communities for sediment-water material exchange in the Sylt-Rømø tidal basin. *Mar Biodivers* 29:111–119. doi: 10.1007/bf03043949
- Asmus H, Asmus RM (2000) Material exchange and food web of seagrass beds in the Sylt-Rømø Bight: how significant are community changes at the ecosystem level? *Helgol Mar Res* 54:137–150. doi: 10.1007/s101520050012
- Asmus H, Asmus RM (2005) Significance of suspension-feeder systems on different spatial scales. In: Dame RF, Olenin S (eds) *The Comparative Roles of Suspension-Feeders in Ecosystems*. Springer, Amsterdam, Netherlands, pp 199–219
- Asmus RM (1983) Benthische und pelagische Primärproduktion und Nährsalzbilanz. Eine Freilanduntersuchung im Watt der Nordsee. *Ber. Inst. Meereskunde, Univ. Kiel, Germany*
- Asmus RM, Asmus H (1991) Mussel beds: limiting or promoting phytoplankton? *J Exp Mar Bio Ecol* 148:215–232. doi: 10.1016/0022-0981(91)90083-9
- Asmus RM, Bauerfeind E (1994) The microphytobenthos of Königshafen—spatial and seasonal distribution on a sandy tidal flat. *Helgoländer Meeresuntersuchungen* 48:257–276. doi: 10.1007/BF02367040
- Asmus RM, Jensen MH, Murphy D, Doerffer R (1998) Primary production of microphytobenthos, phytoplankton and the annual yield of macrophytic biomass in the Sylt-Rømø Wadden Sea. In: Gaetje C, Reise K (eds) *The Wadden Sea Ecosystem-Exchange, Transport and Transformation Processes*. Springer, Berlin, pp 367–391
- Auel H, Harjes M, Rocha R, Stübing D, Hagen W (2002) Lipid biomarkers indicate different ecological niches and trophic relationships of the Arctic hyperiid amphipods *Themisto abyssorum* and *T. libellula*. *Polar Biol* 25:374–383. doi: 10.1007/s00300-001-0354-7
- Austen MC, Wibdom B (1991) Changes in and slow recovery of a meiobenthic nematode assemblage following a

- hypoxic period in the Gullmar Fjord basin, Sweden. *Mar Biol* 111:139–145. doi: 10.1007/BF01986355
- Austen MC, Widdicombe S, Villano-Pitacco N (1998) Effects of biological disturbance on diversity and structure of meiobenthic nematode communities. *Mar Ecol Prog Ser* 174:233–246. doi: 10.3354/meps174233
- Azovsky AI, Chertoproud ES, Saburova MA, Polikarpov IG (2004) Spatio-temporal variability of micro- and meiobenthic communities in a White Sea intertidal sandflat. *Estuar Coast Shelf Sci* 60:663–671. doi: 10.1016/j.ecss.2004.03.005
- Baeta A, Niquil N, Marques JC, Patrício J (2011) Modelling the effects of eutrophication, mitigation measures and an extreme flood event on estuarine benthic food webs. *Ecol Modell* 222:1209–1221. doi: 10.1016/j.ecolmodel.2010.12.010
- Baines SB, Pace ML (1991) The production of dissolved organic matter by phytoplankton and its importance to bacteria: patterns across marine and freshwater systems. *Limnol Oceanogr* 36:1078–1090. doi: 10.4319/lo.1991.36.6.1078
- Baird D, Ulanowicz RE (1989) The seasonal dynamics of the Chesapeake Bay ecosystem. *Ecol Monogr* 59:329–364.
- Baird D, Luczkovich J, Christian RR (1998) Assessment of spatial and temporal variability in ecosystem attributes of the St Marks national wildlife refuge, Apalachee Bay, Florida. *Estuar. Coast. Shelf Sci.* 47:329–349.
- Baird D, Christian RR, Peterson CH, Johnson GA (2004a) Consequences of hypoxia on estuarine ecosystem function : Energy diversion from consumers to microbes. *Ecol Appl* 14:805–822. doi: 10.1890/02-5094
- Baird D, Asmus H, Asmus RM (2004b) Energy flow of a boreal intertidal ecosystem, the Sylt-Rømø Bight. *Mar Ecol Prog Ser* 279:45–61. doi: 10.3354/meps279045
- Baird D, Asmus H, Asmus RM (2007) Trophic dynamics of eight intertidal communities of the Sylt-Rømø Bight ecosystem, northern Wadden Sea. *Mar Ecol Prog Ser* 351:25–41. doi: 10.3354/meps07137
- Baird D, Fath BD, Ulanowicz RE, Asmus H, Asmus RM (2009) On the consequences of aggregation and balancing of networks on system properties derived from ecological network analysis. *Ecol Modell* 220:3465–3471. doi: 10.1016/j.ecolmodel.2009.09.008
- Baird D, Asmus H, Asmus RM (2012) Effect of invasive species on the structure and function of the Sylt-Rømø Bight ecosystem, northern Wadden Sea, over three time periods. *Mar Ecol Prog Ser* 462:143–162. doi: 10.3354/meps09837
- Banse K, Mosher S (1980) Adult body mass and annual production/biomass relationships of field populations. *Ecol Monogr* 50:355–379.
- Barbier EB, Hacker SD, Kennedy C, Koch EW, Stier C, Silliman BR (2011) The value of estuarine and coastal ecosystem services. *Ecol Monogr* 81:169–193.
- Benner R, Fogel ML, Sprague EK, Hodson RE (1987) Depletion of C in lignin and its implications for stable carbon isotope studies. *Nature* 329:708–710. doi: 10.1038/329708a0
- Bergamaschi BA, Tsamakidis E, Keil RG, Eglinton TI, Montluçon DB, Hedges JI (1997) The effect of grain size and surface area on organic matter, lignin and carbohydrate concentration, and molecular compositions in Peru Margin sediments. *Geochim Cosmochim Acta* 61:1247–1260. doi: 10.1016/S0016-7037(96)00394-8
- Beukema JJ, Cadee GC (1991) Growth rates of the bivalve *Macoma balthica* in the Wadden Sea during a period of eutrophication: relationships with concentrations of pelagic diatoms and flagellates. *Mar Ecol Prog Ser* 68:249–256. doi: 10.3354/meps068249
- Blanchard GF (1991) Measurement of meiofauna grazing rates on microphytobenthos: is primary production a limiting factor? *J Exp Mar Bio Ecol* 147:37–46. doi: 10.1016/0022-0981(91)90035-U
- Blanchard GF, Guarini J-M, Gros P, Richard P (1997) Seasonal effect on the relationship between the photosynthetic

References

- capacity of intertidal microphytobenthos and temperature. *J Phycol* 33:723–728. doi: DOI 10.1111/j.0022-3646.1997.00723.x
- Blanchard GF, Guarini J-M, Orvain F, Sauriau P-G (2001) Dynamic behaviour of benthic microalgal biomass in intertidal mudflats. *J Exp Mar Bio Ecol* 264:85–100. doi: 10.1016/S0022-0981(01)00312-4
- Bocher P, Piersma T, Dekinga A, Kraan C, Yates MG, Guyot T, Folmer EO, Radenac G (2007) Site- and species-specific distribution patterns of molluscs at five intertidal soft-sediment areas in northwest Europe during a single winter. *Mar Biol* 151:577–594. doi: 10.1007/s00227-006-0500-4
- Bolla R (1980) Nematode energy metabolism. In: Zuckermann BM (ed) *Nematodes as Biological Models*, Volume 2. Academic Press, New York, USA, pp 165–192
- Bonaglia S, Nascimento FJA, Bartoli M, Klawonn I, Brüchert V (2014) Meiofauna increases bacterial denitrification in marine sediments. *Nat Commun*. doi: 10.1038/ncomms6133
- Borowitzka MA, Lavery PS, van Keulen M (2006) Epiphytes of seagrasses. In: Larkum AWD, Orth RJ, Duarte CM (eds) *Seagrasses: Biology, Ecology and Conservation*. Springer, Dordrecht, Netherlands, pp 441–461
- Borrett SR, Lau MK (2014) enaR: An R package for Ecosystem Network Analysis. *Methods Ecol Evol* 5:1206–1213. doi: 10.1111/2041-210X.12282
- Boschker HTS, Middelburg JJ (2002) Stable isotopes and biomarkers in microbial ecology. *FEMS Microbiol Ecol* 40:85–95. doi: 10.1016/S0168-6496(02)00194-0
- Boschker HTS, Wielemaker A, Schaub BEM, Holmer M (2000) Limited coupling of macrophyte production and bacterial carbon cycling in the sediments of *Zostera* spp. meadows. *Mar Ecol Prog Ser* 203:181–189. doi: 10.3354/meps203181
- Bouillon S, Boschker HTS (2006) Bacterial carbon sources in coastal sediments: a cross-system analysis based on stable isotope data of biomarkers. *Biogeosciences* 3:175–185. doi: 10.5194/bg-3-175-2006
- Bradshaw C, Kumblad L, Fagrell A (2006) The use of tracers to evaluate the importance of bioturbation in remobilising contaminants in Baltic sediments. *Estuar Coast Shelf Sci* 66:123–134. doi: 10.1016/j.ecss.2005.08.002
- Braeckman U, Provoost P, Sabbe K, Soetaert K, Middelburg JJ, Vincx M, Vanaverbeke J (2015) Temporal dynamics in a shallow coastal benthic food web: insights from fatty acid biomarkers and their stable isotopes. *Mar Environ Res* 108:55–68. doi: 10.1016/j.marenvres.2015.04.010
- Breckling B, Müller F, Reuter H, Hölker F, Fränzle O (2005) Emergent properties in individual-based ecological models—introducing case studies in an ecosystem research context. *Ecol Modell* 186:376–388. doi: 10.1016/j.ecolmodel.2005.02.008
- Brussaard CP, Riegman R, Noordeloos AA, Cadee GC, Witte H, Kop a. J, Nieuwland G, Van Duyl FC, Bak RP (1995) Effects of grazing, sedimentation and phytoplankton cell lysis on the structure of a coastal pelagic food web. *Mar Ecol Prog Ser* 123:259–272. doi: 10.3354/meps123259
- Burke L, Kura Y, Kassem K, Revenga C, Spalding M, McAllister D (2001) *Pilot analysis of global ecosystems: Coastal ecosystems*. World Resource Institute, Washington, DC, USA
- Calbet A, Landry MR (2004) Phytoplankton growth, microzooplankton grazing, and carbon cycling in marine systems. *Limnol Oceanogr* 49:51–57. doi: 10.4319/lo.2004.49.1.0051
- Calow P (1977) Conversion efficiencies in heterotrophic organisms. *Biol Rev Camb Philos Soc* 52:385–409. doi: 10.1111/j.1469-185X.1977.tb00840.x
- Cammen LM (1991) Annual bacterial production in relation to benthic microalgal production and sediment oxygen uptake in an intertidal sandflat and an intertidal mudflat. *Mar Ecol Prog Ser* 71:13–25. doi: 10.3354/meps071013
- Carey AG (1967) Energetics of the benthos of Long Island Sound I. Oxygen utilization of sediment. *Bull Bingham*

- Oceanogr Collect 19:136–144.
- Carman KR, Fry B (2002) Small-sample methods for $\delta^{13}\text{C}$ and $\delta^{15}\text{N}$ analysis of the diets of marsh meiofaunal species using natural-abundance and tracer-addition isotope techniques. *Mar Ecol Prog Ser* 240:85–92. doi: 10.3354/meps240085
- Carpentier A, Como S, Dupuy C, Lefrançois C, Feunteun E (2014) Feeding ecology of *Liza* spp. in a tidal flat: Evidence of the importance of primary production (biofilm) and associated meiofauna. *J Sea Res* 92:86–91. doi: 10.1016/j.seares.2013.10.007
- Castel J, Lassere P (1982) Régulation biologique du meiobenthos d'un écosystème lagunaire par un alevinage expérimental en soles (*Solea vulgaris*). *Oceanol acta* 243–251.
- Castel J, Labourg P-J, Escaravage V, Auby I, Garcia ME (1989) Influence of seagrass beds and oyster parks on the abundance and biomass patterns of meio- and macrobenthos in tidal flats. *Estuar Coast Shelf Sci* 28:71–85.
- Cebrián J (1999) Patterns in the fate of production in plant communities. *Am Nat* 154:449–468. doi: 10.1086/303244
- Chanton J, Lewis FG (2002) Examination of coupling between primary and secondary production in a river dominated estuary: Apalachicola Bay, Florida (USA). *Limnol Oceanogr* 47:683–697.
- Chapin III FS, Zavaleta ES, Eviner VT, Naylor RL, Vitousek PM, Reynolds HL, Hooper DU, Lavorel S, Sala OE, Hobbie SE, Mack MC, Diaz S (2000) Ecosystem consequences of changing biodiversity. *Nature* 405:235–242.
- Chardy P, Dauvin JC (1992) Carbon flows in a subtidal fine sand community from the western English Channel: a simulation analysis. *Mar Ecol Prog Ser* 81:147–161. doi: 10.3354/meps081147
- Chardy P, Gros P, Mercier H, Monbet Y (1993) Benthic carbon budget for the Bay of Saint-Brieuc (Western Channel). Application of inverse method. *Oceanol Acta* 16:687–694.
- Christensen V (1995) Ecosystem maturity - towards quantification. *Ecol Modell* 77:3–32. doi: 10.1016/0304-3800(93)E0073-C
- Christian RR, Baird D, Luczkovich J, Johnson JC, Scharler UM, Ulanowicz RE (2005) Role of network analysis in comparative ecosystem ecology of estuaries. In: Belgrano A, Scharler UM, Dunne JA, Ulanowicz RE (eds) *Aquatic Food Webs: An ecosystem approach*. Oxford University Press, New York, USA, pp 25–40
- Cliff N (1993) Dominance statistics: Ordinal analyses to answer ordinal questions. *Psychol Bull* 114:494–509.
- Cnudde C, Werbrouck E, Lepoint G, Vangansbeke D, Moens T, De Troch M (2015) Trophodynamics of intertidal harpacticoid copepods based on stable isotopes and fatty acid profiling. *Mar Ecol Prog Ser* 524:225–239. doi: 10.3354/meps11161
- Coffin RB, Velinsky DJ, Devereux R, Price WA, Cifuentest LA (1990) Stable carbon isotope analysis of nucleic acids to trace sources of dissolved substrates used by estuarine bacteria. *Appl Environ Microbiol* 56:2012–2020.
- Como S, Lefrançois C, Maggi E, Antognarelli F, Dupuy C (2014) Behavioral responses of juvenile golden gray mullet *Liza aurata* to changes in coastal temperatures and consequences for benthic food resources. *J Sea Res* 92:66–73. doi: 10.1016/j.seares.2013.10.004
- Consalvey M, Paterson DM, Underwood GJC (2004) The ups and downs of life in a benthic biofilm: Migration of benthic diatoms. *Diatom Res* 19:181–202. doi: 10.1080/0269249X.2004.9705870
- Couch CA (1989) Carbon and nitrogen stable isotopes of meiobenthos and their food resources. *Estuar Coast Shelf Sci* 28:433–441. doi: 10.1016/0272-7714(89)90090-5
- Coull BC (1970) Shallow water meiobenthos of the Bermuda platform. *Oecologia* 4:325–357.
- Coull BC (1985) Long-term variability of estuarine meiobenthos: an 11 year study. *Mar Ecol Prog Ser* 24:205–218. doi: 10.3354/meps024205
- Coull BC (1990) Are members of the meiofauna food for higher trophic levels? *Trans Am Microsc Soc* 109:233–246.

References

- Coull BC (1999) Role of meiofauna in estuarine soft-bottom habitats. *Aust J Ecol* 24:327–343. doi: 10.1046/j.1442-9993.1999.00979.x
- Cullen DJ (1973) Bioturbation of superficilar marine sediments by interstitial meiobenthos. *Nature* 242:323–324.
- Currin CA, Newell SY, Paerl HW (1995) The role of standing dead *Spartina alterniflora* and benthic microalgae in salt marsh food webs: Considerations based on multiple stable isotope Analysis. *Mar Ecol Prog Ser* 121:99–116.
- Daehnick AE, Sullivan MJ, Moncreiff CA (1992) Primary production of the sand microflora in seagrass beds of Mississippi Sound. *Bot Mar* 35:131–139. doi: 10.3354/meps087161
- Dale NG (1974) Bacteria in intertidal sediment: Factors related to their distribution. *Limnol Oceanogr* 19:509–519.
- Dalsgaard J, St. John M, Kattner G, Müller-Navarra D, Hagen W (2003) Fatty acid trophic markers in the pelagic marine environment. *Adv Mar Biol* 46:225–340. doi: 10.1016/S0065-2881(03)46005-7
- Dame RF, Patten BC (1981) Analysis of energy flows in an intertidal oyster reef. *Mar Ecol Prog Ser* 5:115–124. doi: 10.3354/meps005115
- Dame RF, Prins TC (1998) Bivalve carrying capacity in coastal ecosystems. *Aquat Ecol* 31:409–421. doi: 10.1023/A:1009997011583
- Danovaro R (1996) Detritus-bacteria-meiofauna interactions in a seagrass bed (*Posidonia oceanica*) of the NW Mediterranean. *Mar Biol* 127:1–13. doi: 10.1007/BF00993638
- Danovaro R, Gambi C (2002) Biodiversity and trophic structure of nematode assemblages in seagrass systems: evidence for a coupling with changes in food availability. *Mar Biol* 141:667–677. doi: 10.1007/s00227-002-0857-y
- Danovaro R, Gambi C, Della Croce N (2002a) Meiofauna hotspot in the Atacama Trench, eastern South Pacific Ocean. *Deep Res Part I Oceanogr Res Pap* 49:843–857. doi: 10.1016/S0967-0637(01)00084-X
- Danovaro R, Gambi C, Mirto S (2002b) Meiofaunal production and energy transfer efficiency in a seagrass *Posidonia oceanica* bed in the western Mediterranean. *Mar Ecol Prog Ser* 234:95–104. doi: 10.3354/meps234095
- Danovaro R, Scopa M, Gambi C, Fraschetti S (2007) Trophic importance of subtidal metazoan meiofauna: Evidence from in situ exclusion experiments on soft and rocky substrates. *Mar Biol* 152:339–350. doi: 10.1007/s00227-007-0696-y
- Davis RA, Fitzgerald DM (2004) *Beaches and coasts*. Blackwell Publishing, Oxford, U.K.
- Day JWJ, Hall CAS, Kemp MW, Yáñez-Arancibia A (eds) (1989) *Estuarine ecology*. Wiley, New York, USA
- de Deckere EMGT, Tolhurst TJ, de Brouwer JFC (2001) Destabilization of cohesive intertidal sediments by infauna. *Estuar Coast Shelf Sci* 53:665–669. doi: 10.1006/ecss.2001.0811
- de Jong DJ, de Jonge VN (1995) Dynamics and distribution of microphytobenthic chlorophyll-a in the Western Scheldt estuary (SW Netherlands). *Hydrobiologia* 311:21–30. doi: 10.1007/BF00008568
- de Jonge VN (1980) Fluctuations in the organic carbon to chlorophyll-*a* ratios for estuarine benthic diatom populations. *Mar Ecol Prog Ser* 2:345–353. doi: 10.3354/meps002345
- de Jonge VN, Bouwman LA (1977) A simple density separation technique for quantitative isolation of microphytobenthos using the colloidal silica Ludox™. *Mar Biol* 42:143–148. doi: 10.1007/BF00391564
- de la Vega C, Schückel U, Horn S, Kröncke I, Asmus RM, Asmus H (2018a) How to include ecological network analysis results in management? A case study of three tidal basins of the Wadden Sea, south-eastern North Sea. *Ocean Coast Manag* 163:401–416. doi: 10.1016/j.ocecoaman.2018.07.019
- de la Vega C, Horn S, Baird D, Hines D, Borrett S, Jensen LF, Schwemmer P, Asmus RM, Siebert U, Asmus H (2018b) Seasonal dynamics and functioning of the Sylt-Rømø Bight, northern Wadden Sea. *Estuar Coast Shelf Sci* 203:100–118. doi: 10.1016/j.ecss.2018.01.021

- de Mesel I, Derycke S, Moens T, van der Gucht K, Vincx M, Swings J (2004) Top-down impact of bacterivorous nematodes on the bacterial community structure: A microcosm study. *Environ Microbiol* 6:733–744. doi: 10.1111/j.1462-2920.2004.00610.x
- de Troch M, Gurdebeke S, Fiers F, Vincx M (2001) Zonation and structuring factors of meiofauna communities in a tropical seagrass bed (Gazi Bay, Kenya). *J Sea Res* 45:45–61. doi: 10.1016/S1385-1101(00)00055-1
- de Troch M, Steinarsdóttir MB, Chepurnov V, Ólafsson E (2005) Grazing on diatoms by harpacticoid copepods: Species-specific density-dependent uptake and microbial gardening. *Aquat Microb Ecol* 39:135–144. doi: 10.3354/ame039135
- de Troch M, Houthoofd L, Chepurnov V, Vanreusel A (2006a) Does sediment grain size affect diatom grazing by harpacticoid copepods? *Mar Environ Res* 61:265–277. doi: 10.1016/j.marenvres.2005.10.004
- de Troch M, Chepurnov V, Gheerardyn H, Vanreusel A, Ólafsson E (2006b) Is diatom size selection by harpacticoid copepods related to grazer body size? *J Exp Mar Bio Ecol* 332:1–11. doi: 10.1016/j.jembe.2005.10.017
- Dechambenoy CL, Pointier F, Sirou F, Vouvé J (1977) Apport de la thermographie infrarouge aéroportée à la connaissance de la dynamique superficielle des estuaires (système Charente-Seudre-Anse de l'Aiguillon). *Acad des Sci* 284:1269–1272.
- Degré D, Leguerrier D, Armynot du Chatelet E, Rzeznik J, Auguet J-C, Dupuy C, Marquis E, Fichet D, Struski C, Joyeux E, Sauriau P-G, Niquil N (2006) Comparative analysis of the food webs of two intertidal mudflats during two seasons using inverse modelling: Aiguillon Cove and Brouage Mudflat, France. *Estuar Coast Shelf Sci* 69:107–124. doi: 10.1016/j.ecss.2006.04.001
- del Giorgio PA, Cole JJ (1998) Bacterial growth efficiency in natural aquatic systems. *Annu Rev Ecol Syst* 29:503–541.
- DeNiro MJ, Epstein S (1978) Influence of diet on the distribution of carbon isotopes in animals. *Geochim. Cosmochim. Acta* 42:495–506.
- Dolbeth M, Cardoso PG, Ferreira SM, Verdelhos T, Raffaelli D, Pardal MA (2007) Anthropogenic and natural disturbance effects on a macrobenthic estuarine community over a 10-year period. *Mar Pollut Bull* 54:576–585. doi: 10.1016/j.marpolbul.2006.12.005
- Dolch T, Hass HC (2008) Long-term changes of intertidal and subtidal sediment compositions in a tidal basin in the northern Wadden Sea (SE North Sea). *Helgol Mar Res* 62:3–11. doi: 10.1007/s10152-007-0090-7
- Dolch T, Reise K (2010) Long-term displacement of intertidal seagrass and mussel beds by expanding large sandy bedforms in the northern Wadden Sea. *J Sea Res* 63:93–101. doi: 10.1016/j.seares.2009.10.004
- Duarte CM (1989) Temporal biomass variability and production/biomass relationships of seagrass communities. *Mar Ecol Prog Ser* 51:269–276. doi: 10.3354/meps051269
- Duarte CM, Cebrián J (1996) The fate of marine autotrophic production. *Limnol Oceanogr* 41:1758–1766. doi: 10.4319/lo.1996.41.8.1758
- Duarte CM, Chiscano CL (1999) Seagrass biomass and production: A reassessment. *Aquat Bot* 65:159–174. doi: 10.1016/S0304-3770(99)00038-8
- Dubois S, Savoye N, Gremare A, Plus M, Charlier K, Beltoise A, Blanchet H (2012) Origin and composition of sediment organic matter in a coastal semi-enclosed ecosystem: An elemental and isotopic study at the ecosystem space scale. *J Mar Syst* 94:64–73.
- Dunstan GA, Sinclair AJ, O'Dea K, Naughton JM (1988) The lipid content and fatty acid composition of various marine species from southern Australian coastal waters. *Comp Biochem Physiol* 91B:165–169. doi: 10.1016/0305-0491(88)90130-7
- Dunstan GA, Volkman JK, Barrett SM, Leroi JM, Jeffrey SW (1994) Essential polyunsaturated fatty acids from 14

References

- species of diatom (Bacillariophyceae). *Phytochemistry* 35:155–161. doi: 10.1016/S0031-9422(00)90525-9
- Dupuy C, Nguyen Thanh H, Mizrahi D, Jourde J, Bréret M, Agogue H, Beauguard L, Bocher P (2015) Structure and functional characteristics of the meiofauna community in highly unstable intertidal mudbanks in Suriname and French Guiana (North Atlantic coast of South America). *Cont Shelf Res* 110:39–47. doi: 10.1016/j.csr.2015.09.019
- El-Sabaawi R, Dower JF, Kainz M, Mazumder A (2009) Characterizing dietary variability and trophic positions of coastal calanoid copepods: Insight from stable isotopes and fatty acids. *Mar Biol* 156:225–237. doi: 10.1007/s00227-008-1073-1
- Ellison RL (1984) Foraminifera and meiofauna on an intertidal mudflat, Cornwall, England: Populations; respiration and secondary production; and energy budget. *Hydrobiologia* 109:131–148. doi: 10.1007/BF00011572
- Eriksson BK, van der Heide T, van de Koppel J, Piersma T, van der Veer HW, Olf H (2010) Major changes in the ecology of the wadden sea: Human impacts, ecosystem engineering and sediment dynamics. *Ecosystems* 13:752–764. doi: 10.1007/s10021-010-9352-3
- Escaravage V, Garcia ME, Castel J (1989) The distribution of meiofauna and its contribution to detritic pathways in tidal flats (Arcachon Bay, France). In: Ros JD (ed) *Topics in Marine Biology*. Instituto de Ciencias del Mar, Barcelona, Spain, pp 551–559
- Fath BD (2015) Quantifying economic and ecological sustainability. *Ocean Coast Manag* 108:13–19. doi: 10.1016/j.ocecoaman.2014.06.020
- Fath BD, Scharler UM, Ulanowicz RE, Hannon B (2007) Ecological network analysis: network construction. *Ecol Modell* 208:49–55. doi: 10.1016/j.ecolmodel.2007.04.029
- Fauchald K, Jumars PA (1979) The diet of worms: a study of polychaete feeding guilds. *Oceanogr Mar Biol Annu Rev* 17:193–284. doi: 10.12691/marine-1-1-6
- Fenchel T (1996) Worm burrows and oxic microniches in marine sediments. 1. Spatial and temporal scales. *Mar Biol* 127:289–295. doi: 10.1007/BF00942114
- Fenchel TM, Jorgensen BB (1977) Detritus food chains of aquatic ecosystems: The role of bacteria. In: Alexander M (ed) *Advances in Microbial Ecology*. Plenum Press, New York, USA, pp 1–58
- Field JG, Moloney CL, Attwood CG (1989) Network Analysis of simulated succession after an upwelling event. In: Wulff F, Field JG, Mann KH (eds) *Network Analysis in Marine Ecology: An Assessment*, *Coast Estuar Stud* 32. Springer, Heidelberg/Berlin, Germany, pp 132–158
- Fisher R, Sheaves MJ (2003) Community structure and spatial variability of marine nematodes in tropical Australian pioneer seagrass meadows. *Hydrobiologia* 495:143–158. doi: 10.1023/A:1025406624390
- Fleeger JW (2005) The potential to mass-culture harpacticoid copepods for use as food for larval fish. In: Lee C-S, O'Bryen PJ, Marcus NH (eds) *Copepods in Aquaculture*. Blackwell Publishing, Ames, USA, pp 11–24
- Folch J, Lees M, Stanley HS (1957) A simple method for the isolation and purification of total lipids from animal tissues. *J. Biol. Chem.* 226:497–509.
- Fonseca G, Hutchings P, Gallucci F (2011) Meiobenthic communities of seagrass beds (*Zostera capricorni*) and unvegetated sediments along the coast of New South Wales, Australia. *Estuar Coast Shelf Sci* 91:69–77. doi: 10.1016/j.ecss.2010.10.003
- Franco MA, Soetaert K, Van Oevelen D, Van Gansbeke D, Costa MJ, Vincx M, Vanaverbeke J (2008a) Density, vertical distribution and trophic responses of metazoan meiobenthos to phytoplankton deposition in contrasting sediment types. *Mar Ecol Prog Ser* 358:51–62. doi: 10.3354/meps07361
- Franco MA, Soetaert K, Costa MJ, Vincx M, Vanaverbeke J (2008b) Uptake of phytodetritus by meiobenthos using ¹³C

- labelled diatoms and Phaeocystis in two contrasting sediments from the North Sea. *J Exp Mar Bio Ecol* 362:1–8. doi: 10.1016/j.jembe.2008.04.010
- Frontalini F, Semprucci F, du Châtelet EA, Francescangeli F, Margaritelli G, Rettori R, Spagnoli F, Balsamo M, Coccioni R (2014) Biodiversity trends of the meiofaunal and foraminiferal assemblages of Lake Varano (southern Italy). *Proc Biol Soc Washingt* 127:7–22. doi: 10.2988/0006-324X-127.1.7
- Fry B (1988) Food web structure on Georges Bank from stable C, N, and S isotopic compositions. *Limnol Oceanogr* 33:1182–1190.
- Fry B (2006) *Stable isotope ecology*. Springer, New York, USA
- Gaedke U, Straile D (1994) Seasonal-changes of trophic transfer efficiencies in a plankton food-web derived from biomass size distributions and network analysis. *Ecol Modell* 75:435–445. doi: 10.1016/0304-3800(94)90038-8
- Gallucci F, Steyaert M, Moens T (2005) Can field distributions of marine predacious nematodes be explained by sediment constraints on their foraging success? *Mar Ecol Prog Ser* 304:167–178. doi: 10.3354/meps304167
- Galois R, Richard P, Fricourt B (1996) Seasonal variations in suspended particulate matter in the Marennes-Oléron Bay, France, using lipids as biomarkers. *Estuar Coast Shelf Sci* 43:335–357. doi: 10.1006/ecss.1996.0074
- Gamito S, Erzini K (2005) Trophic food web and ecosystem attributes of a water reservoir of the Ria Formosa (south Portugal). *Ecol Modell* 181:509–520. doi: 10.1016/j.ecolmodel.2004.02.024
- Garet MJ (1996) Transformation bactérienne de la matière organique dans les sédiments côtiers. Relation entre les métabolismes respiratoires et les activités exoprotéolytiques bactériennes. University of Bordeaux II
- Gätje C, Reise K (1998) *Ökosystem Wattenmeer: Austausch-, Transport-und Stoffumwandlungsprozesse*. Springer, Berlin, Germany
- Gattuso J-P, Frankignoulle M, Wollast R (1998) Carbon and carbonate metabolism in coastal aquatic ecosystems. *Annu Rev Ecol Syst* 29:405–434.
- Gazeau F, Smith SV, Gentili B, Frankignoulle M, Gattuso J-P (2004) The European coastal zone: characterization and first assessment of ecosystem metabolism. *Estuar Coast Shelf Sci* 60:673–694. doi: 10.1016/j.ecss.2004.03.007
- Gee JM (1987) Impact of epibenthic predation on estuarine intertidal harpacticoid copepod populations. *Mar Biol* 96:497–510. doi: 10.1007/BF00397967
- Gee JM (1989) An ecological and economic review of meiofauna as food for fish. *Zool J Linn Soc* 96:243–261.
- Gerlach SA (1971) On the importance of meiofauna for benthos communities. *Oecologia* 6:176–190.
- Gheskiere T, Vincx M, Urban-Malinga B, Rossano C, Scapini F, Degraer S (2005) Nematodes from wave-dominated sandy beaches: Diversity, zonation patterns and testing of the isocommunities concept. *Estuar Coast Shelf Sci* 62:365–375. doi: 10.1016/j.ecss.2004.09.024
- Giere O (1993) *Meiobenthology. The microscopic fauna in aquatic sediments*, 1st edn. Springer-Verlag, Berlin, Germany
- Giere O (2009) *Meiobenthology: the microscopic motile fauna of aquatic sediments*, 2nd edn. Springer, Berlin, Germany
- Gonçalves AMM, Azeiteiro UM, Pardal MA, de Troch M (2012) Fatty acid profiling reveals seasonal and spatial shifts in zooplankton diet in a temperate estuary. *Estuar Coast Shelf Sci* 109:70–80. doi: 10.1016/j.ecss.2012.05.020
- Gordon JDM, Duncan JAR (1979) Some notes on the biology of the snake blenny, *Lumpenus lampretaeformis* on the west coast of Scotland. *J Mar Biol Assoc United Kingdom* 59:413–419.
- Goss-Custard JD, Jones RE, Newberry PE (1977) The ecology of the Wash. I. Distribution and diet of wading birds (*Charadrii*). *J Appl Ecol* 14:681–700.
- Goto N, Kawamura T, Mitamura O, Terai H (1999) Importance of extracellular organic carbon production in the total

References

- primary production by tidal-flat diatoms in comparison to phytoplankton. *Mar Ecol Prog Ser* 190:289–295. doi: 10.3354/meps190289
- Gouleau D, Jouanneau JM, Weber O, Sauriau PGG (2000) Short- and long-term sedimentation on Montportail–Brouage intertidal mudflat, Marennes–Oléron Bay (France). *Cont Shelf Res* 20:1513–1530. doi: 10.1016/S0278-4343(00)00035-2
- Graeve M, Kattner G, Hagen W (1994) Diet-induced changes in the fatty acid composition of Arctic herbivorous copepods: Experimental evidence of trophic markers. *J Exp Mar Bio Ecol* 182:97–110.
- Graeve M, Kattner G, Piepenburg D (1997) Lipids in arctic benthos: Does the fatty acid and alcohol composition reflect feeding and trophic interactions? *Polar Biol* 18:53–61. doi: 10.1007/s003000050158
- Gray JP, Herwig RP (1996) Phylogenetic analysis of the bacterial communities in marine sediments. *Appl Environ Microbiol* 62:4049–4059.
- Grebmeier JM, McRoy CP, Feder HM (1988) Pelagic-benthic coupling on the shelf of the northern Bering and Chukchi Seas. I. Food supply source and benthic biomass. *Mar Ecol Prog Ser* 48:57–67. doi: 10.3354/meps048057
- Greenacre M (2016) Data reporting and visualization in ecology. *Polar Biol* 39:2189–2205. doi: 10.1007/s00300-016-2047-2
- Gribben PE, Nielsen S, Seymour JR, Bradley DJ, West MN, Thomas T (2017) Microbial communities in marine sediments modify success of an invasive macrophyte. *Sci Rep* 7:1–8. doi: 10.1038/s41598-017-10231-2
- Guarini J-M, Blanchard GF, Bacher C, Gros P, Riera P, Richard P, Gouleau D, Prou J, Galois R, Sauriau P-G (1998) Dynamics of spatial patterns of microphytobenthic biomass: inferences from a geostatistical analysis of two comprehensive surveys in Marennes-Oléron Bay (France). *Mar Ecol Prog Ser* 166:131–141.
- Guesnet V, Lassalle G, Chaalali A, Kearney K, Saint-Béat B, Karimi B, Grami B, Tecchio S, Niquil N, Lobry J (2015) Incorporating food-web parameter uncertainty into Ecopath-derived ecological network indicators. *Ecol Modell* 313:29–40. doi: 10.1016/j.ecolmodel.2015.05.036
- Guilini K, Levin LA, Vanreusel A (2012) Cold seep and oxygen minimum zone associated sources of margin heterogeneity affect benthic assemblages, diversity and nutrition at the Cascadian margin (NE Pacific Ocean). *Prog Oceanogr* 96:77–92. doi: 10.1016/j.pocean.2011.10.003
- Guilini K, Veit-Köhler G, de Troch M, van Gansbeke D, Vanreusel A (2013) Latitudinal and temporal variability in the community structure and fatty acid composition of deep-sea nematodes in the Southern Ocean. *Prog Oceanogr* 110:80–92. doi: 10.1016/j.pocean.2013.01.002
- Guillaumont B (1991) Utilisation de l'imagerie satellitaire pour des comparaisons spatiales et temporelles en zone intertidale. In: Elliott M, Ducrotoy J-P (eds) *Estuaries and Coasts: Spatial and Temporal Intercomparisons*. ECSA19 Symposium. Olsen & Olsen Press, Fredensborg, Denmark, pp 63–68
- Halpern BS, Walbridge S, Selkoe KA, Kappel CV, Micheli F, D'Agrosa C, Bruno JF, Casey KS, Ebert C, Fox HE, Fujita R, Heinemann D, Lenihan HS, Madin EMP, Perry MT, Selig ER, Spalding M, Steneck R, Watson R (2008) A global map of human impact on marine ecosystems. *Science* (80-) 319:948–952. doi: 10.1126/science.1149345
- Haubois AG, Guarini JM, Richard P, Fichet D, Radenac G, Blanchard GF (2005a) Ingestion rate of the deposit-feeder *Hydrobia ulvae* (Gastropoda) on epipellic diatoms: Effect of cell size and algal biomass. *J Exp Mar Bio Ecol* 317:1–12. doi: 10.1016/j.jembe.2004.11.009
- Haubois AG, Sylvestre F, Guarini JM, Richard P, Blanchard GF (2005b) Spatio-temporal structure of the epipellic diatom assemblage from an intertidal mudflat in Marennes-Oléron Bay, France. *Estuar Coast Shelf Sci* 64:385–394. doi: 10.1016/j.ecss.2005.03.004
- Heip CHR, Vincx M, Vranken G (1985) The ecology of marine nematodes. *Oceanogr Mar Biol Annu Rev* 23:399–489.

- Hemminga M, Duarte CM (2000) Seagrass ecology, 1st edn. Cambridge University Press, Cambridge, U.K.
- Héral M, Deslous-Paoli JM, Prou J (1986) Dynamiques des productions et des biomasses des huîtres creuses cultivées (*Crassostrea angulata* et *Crassostrea gigas*) dans le bassin de Marennes-Oléron depuis un siècle. *Cons Int pour l'Exploration la Mer* 8:13–32.
- Herlory O, Guarini JM, Richard P, Blanchard GF (2004) Microstructure of microphotobenthic biofilm and its spatio-temporal dynamics in an intertidal mudflat (Aiguillon Bay, France). *Mar Ecol Prog Ser* 282:33–44.
- Herlory O, Richard P, Blanchard GF (2007) Methodology of light response curves: application of chlorophyll fluorescence to microphytobenthic biofilms. *Mar Biol* 153:91–101. doi: 10.1007/s00227-007-0787-9
- Herman PMJ, Vranken G (1988) Studies of the life-history and energetics of marine and brackish-water nematodes - II. Production, respiration and food uptake by *Monhystera disjuncta*. *Oecologia* 77:457–463. doi: 10.1007/BF00377260
- Herman PMJ, Middelburg JJ, van de Koppel J, Heip CHR (1999) Ecology of estuarine macrobenthos. *Adv Ecol Res* 29:195–240. doi: 10.1016/S0065-2504(08)60194-4
- Herman PMJ, Middelburg JJ, Widdows J, Lucas CH, Heip CHR (2000) Stable isotopes as trophic tracers: Combining field sampling and manipulative labelling of food resources for macrobenthos. *Mar Ecol Prog Ser* 204:79–92. doi: 10.3354/meps204079
- Herman R, Vincx M, Heip CHR (1985) Meiofauna of the Belgian coastal waters: spatial and temporal variability and productivity. In: Heip C, Polk P (eds) *Concerted Actions Oceanography. Final Report, vol. 3. Biological Processes and Translocations, Concerted*. Ministry of Scientific Policy, Brussels, Belgium, pp 65–80
- Hicks GRF (1984) Spatio-temporal dynamics of a meiobenthic copepod and the impact of predation-disturbance. *J Exp Mar Bio Ecol* 81:47–72. doi: 10.1016/0022-0981(84)90223-5
- Hicks GRF, Coull BC (1983) The ecology of marine meiobenthic harpacticoid copepods. *Oceanogr Mar Biol Annu Rev* 21:67–175. doi: 10.1234/2013/999990.
- Higgins RP, Thiel H (1988) *Introduction to the study of meiofauna*. Smithsonian Institution Press, Washington DC
- Hill MO (1973) Diversity and evenness: a unifying notation and its consequences. *Ecology* 54:427–432. doi: 10.2307/1934352
- Hobson KA, Piattt JF, Pitocchelli J (1994) Using stable isotopes to determine seabird trophic relationships. *J Anim Ecol* 63:786–798.
- Höfmann H, Hörschelmann H (1969) Nahrungsuntersuchungen bei Limikolen durch Mageninhaltsanalysen. *Corax* 3:7–22.
- Holland AF, Zingmark RG, Dean JM (1974) Quantitative evidence concerning the stabilization of sediments by marine benthic diatoms. *Mar Biol* 27:191–196. doi: 10.1007/BF00391943
- Holmer M, Duarte CM, Boschker HTS, Barrón C (2004) Carbon cycling and bacterial carbon sources in pristine and impacted Mediterranean seagrass sediments. *Aquat Microb Ecol* 36:227–237. doi: 10.3354/ame036227
- Horn S, de la Vega C, Asmus RM, Schwemmer P, Enners L, Garthe S, Binder K, Asmus H (2017) Interaction between birds and macrofauna within food webs of six intertidal habitats of the Wadden Sea. *PLoS One* 12:1–23. doi: 10.1371/journal.pone.0176381
- Hoshika A, Sarker MJ, Ishida S, Mishima Y, Takai N (2006) Food web analysis of an eelgrass (*Zostera marina* L.) meadow and neighbouring sites in Mitsukuchi Bay (Seto Inland Sea, Japan) using carbon and nitrogen stable isotope ratios. *Aquat Bot* 85:191–197. doi: 10.1016/j.aquabot.2006.03.005
- Hyndes GA, Lavery PS (2005) Does transported seagrass provide an important trophic link in unvegetated, nearshore areas? *Estuar Coast Shelf Sci* 63:633–643. doi: 10.1016/j.ecss.2005.01.008

References

- Iken K, Brey T, Wand U, Voigt J, Junghans P (2001) Food web structure of the benthic community at the Porcupine Abyssal Plain (NE Atlantic): A stable isotope analysis. *Prog Oceanogr* 50:383–405. doi: 10.1016/S0079-6611(01)00062-3
- Ingole BS, Parulekar AH (1998) Role of salinity in structuring the intertidal meiofauna of a tropical estuarine beach: Field evidence. *Indian J Mar Sci* 27:356–361.
- Jackson GA (1980) Phytoplankton growth and zooplankton grazing in oligotrophic oceans. *Nature* 284:439–441. doi: 10.1038/284439a0
- Jacobsen VH (1967) The feeding of the lugworm *Arenicola marine* (L.). Quantitative studies. *Ophelia* 4:91–109.
- Jaschinski S, Brepohl DC, Sommer U (2008) Carbon sources and trophic structure in an eelgrass *Zostera marina* bed, based on stable isotope and fatty acid analyses. *Mar Ecol Prog Ser* 358:103–114. doi: 10.3354/meps07327
- Jensen KT, Siegismund HR (1980) The importance of diatoms and bacteria in the diet of *Hydrobia ulvae*. *Ophelia* 1:193–199.
- Jensen P (1983) Meiofaunal abundance and vertical zonation in a sublittoral soft bottom, with a test of the Haps corer. *Mar Biol* 74:319–326. doi: 10.1007/BF00403458
- Jensen P (1996) Burrows of marine nematodes as centres for microbial growth. *Nematologica* 42:320–329.
- Jensen SI, Kühl M, Priemé A (2007) Different bacterial communities associated with the roots and bulk sediment of the seagrass *Zostera marina*. *FEMS Microbiol Ecol* 62:108–117. doi: 10.1111/j.1574-6941.2007.00373.x
- Johnson GA, Niquil N, Asmus H, Bacher C, Asmus RM, Baird D (2009) The effects of aggregation on the performance of the inverse method and indicators of network analysis. *Ecol Modell* 220:3448–3464. doi: 10.1016/j.ecolmodel.2009.08.003
- Jordana E, Francois C, Gremare A, Amouroux J-M, Chretiennot-Dinet M-J (2001) Food sources, ingestion and absorption in the suspension-feeding polychaete, *Ditrupa arietina* (O.F. Muller). *J Exp Mar Bio Ecol* 266:219–236. doi: 10.1016/S0022-0981(01)00357-4
- Jørgensen SE, Müller F (eds) (2000) Handbook of ecosystem theories and management. CRC Press, Boca Raton, USA
- Josefson AB, Widbom B (1988) Differential response of benthic macrofauna and meiofauna to hypoxia in the Gullmar Fjord basin. *Mar Biol* 100:31–40. doi: 10.1007/BF00392952
- Kaldy JE, Onuf CP, Eldridge PM, Cifuentes LA (2002) Carbon budget for a subtropical seagrass dominated coastal lagoon: How important are seagrasses to total ecosystem net primary production? *Estuaries* 25:528–539. doi: 10.1007/BF02804888
- Kang CK, Kim JB, Lee KS, Kim JB, Lee PY, Hong JS (2003) Trophic importance of benthic microalgae to macrozoobenthos in coastal bay systems in Korea: Dual stable C and N isotope analyses. *Mar Ecol Prog Ser* 259:79–92. doi: 10.3354/meps259079
- Kang CK, Park HJ, Choy EJ, Choi KS, Hwang K, Kim JB (2015) Linking intertidal and subtidal food webs: Consumer-mediated transport of intertidal benthic microalgal carbon. *PLoS One* 10:1–26. doi: 10.1371/journal.pone.0139802
- Kaufman AG, Borrett SR (2010) Ecosystem network analysis indicators are generally robust to parameter uncertainty in a phosphorus model of Lake Sidney Lanier, USA. *Ecol Modell* 221:1230–1238. doi: 10.1016/j.ecolmodel.2009.12.018
- Kay JJ, Graham LA, Ulanowicz RE (1989) A detailed guide to Network Analysis. In: Wulff F, Field JG, Mann KH (eds) *Network Analysis in Marine Ecology: An Assessment*, *Coast Estuar Stud* 32. Springer, Berlin/Heidelberg, Germany, pp 15–61
- Kelly JR, Scheibling RE (2012) Fatty acids as dietary tracers in benthic food webs. *Mar Ecol Prog Ser* 446:1–22. doi:

10.3354/meps09559

- Kemp PF (1990) The fate of benthic bacterial production. *Rev Aquat Sci* 2:109–124.
- Kervella S (2009) Dynamique des sédiments fins et mixtes des zones intertidales de la baie de Marennes-Oléron. Université de La Rochelle
- Kharlamenko VI, Zhukova NV, Khotimchenko SV, Svetashev VI, Kamenev GM (1995) Fatty acids as markers of food sources in a shallow-water hydrothermal ecosystem (Kraternaya Bight, Yankich Island, Kurile Islands). *Mar Ecol Prog Ser* 120:231–242. doi: 10.3354/meps120231
- Kharlamenko VI, Kiyashko SI, Imbs a. B, Vyshkvartzev DI (2001) Identification of food sources of invertebrates from the seagrass *Zostera marina* community using carbon and sulfur stable isotope ratio and fatty acid analyses. *Mar Ecol Prog Ser* 220:103–117. doi: 10.3354/meps220103
- Kleiber M (1932) Body size and metabolism. *Hilgardia A J. Agric. Sci.* 6:315–353.
- Koch EW, Ackerman JD, Verduin J, van Keulen M (2006) Fluid dynamics in seagrass ecology - from molecules to ecosystems. In: Larkum AWD, Orth RJ, Duarte CM (eds) *Seagrasses: Biology, Ecology and Conservation*. Springer, Dordrecht, Netherlands, pp 193–225
- Koch EW, Barbier EB, Silliman BR, Reed DJ, Perillo GME, Hacker SD, Granek EF, Primavera JH, Muthiga N, Polasky S, Halpern BS, Kennedy CJ, Kappel CV, Wolanski E (2009) Non-linearity in ecosystem services: Temporal and spatial variability in coastal protection. *Front Ecol Environ* 7:29–37. doi: 10.1890/080126
- Kones JK, Soetaert K, van Oevelen D, Owino JO, Mavuti K (2006) Gaining insight into food webs reconstructed by the inverse method. *J Mar Syst* 60:153–166. doi: 10.1016/j.jmarsys.2005.12.002
- Kotwicki L, de Troch M, Urban-Malinga B, Gheskiere T, Weslawski JM (2005a) Horizontal and vertical distribution of meiofauna on sandy beaches of the North Sea (The Netherlands, Belgium, France). *Helgol Mar Res* 59:255–264. doi: 10.1007/s10152-005-0001-8
- Kotwicki L, Szymelfenig M, de Troch M, Urban-Malinga B, Węśławski JM (2005b) Latitudinal biodiversity patterns of meiofauna from sandy littoral beaches. *Biodivers Conserv* 14:461–474. doi: 10.1007/10531-004-6272-6
- Kristensen E, Penha-Lopes G, Delefosse M, Valdemarsen T, Quintana CO, Banta GT (2012) What is bioturbation? The need for a precise definition for fauna in aquatic sciences. *Mar Ecol Prog Ser* 446:285–302. doi: 10.3354/meps09506
- Kuipers BR, de Wilde PAWJ, Creutzberg F (1981) Energy flow in a tidal flat ecosystem. *Mar Ecol Prog Ser* 5:215–221. doi: 10.3354/meps005215
- Lacoste É, Piot A, Archambault P, McKindsey CW, Nozais C (2018) Bioturbation activity of three macrofaunal species and the presence of meiofauna affect the abundance and composition of benthic bacterial communities. *Mar Environ Res* 136:62–70. doi: 10.1016/j.marenvres.2018.02.024
- Landry MR, Hassett RP (1982) Estimating the grazing impact of marine micro-zooplankton. *Mar Biol* 67:283–288. doi: 10.1007/BF00397668
- Lassere P, Renaud-Mornant J (1973) Resistance and respiratory physiology of intertidal meiofauna to oxygen-deficiency. *Netherlands J Sea Res* 7:290–302.
- Lassere P, Renaud-Mornant J, Castel J (1975) Metabolic activities of meiofaunal communities in a semi-enclosed lagoon. Possibilities of trophic competition between meiofauna and mugilid fish. In: Personne G, Jaspers E (eds) *Tenth European Symposium on Marine Biology, Ostend, Belgium, September 1975, 2*. Universal Press, Wetteren, Belgium, pp 393–414
- Lavelle P, Dugdale R, Scholes R, Berhe AA, Carpenter E, Codispoti L, Izac A-M, Lemoalle J, Luizao F, Scholes M, Treguer P, Ward B (2005) Nutrient cycling. In: Hassan R, Scholes R, Ash N (eds) *Ecosystems and human well-*

- being; Vol. 1. Current state and trends: findings of the Condition and Trends Working Group. Island Press, Washington, DC, USA, pp 333–353
- Lavergne C, Beaugeard L, Dupuy C, Courties C, Agogu  H (2014) An efficient and rapid method for the enumeration of heterotrophic prokaryotes in coastal sediments by flow cytometry. *J Microbiol Methods* 105:31–38. doi: 10.1016/j.mimet.2014.07.002
- Lebreton B (2009) Analyse de la structure et du fonctionnement du r seau trophique d'un herbier par approche multi-traceurs: tracement isotopique naturel et profils acides gras. Universit  de La Rochelle, France
- Lebreton B, Richard P, Radenac G, Bordes M, Br ret M, Arnaud C, Mornet F, Blanchard GF (2009) Are epiphytes a significant component of intertidal *Zostera noltii* beds? *Aquat Bot* 91:82–90. doi: 10.1016/j.aquabot.2009.03.003
- Lebreton B, Richard P, Parlier EP, Guillou G, Blanchard GF (2011a) Trophic ecology of mullets during their spring migration in a European saltmarsh: A stable isotope study. *Estuar Coast Shelf Sci* 91:502–510. doi: 10.1016/j.ecss.2010.12.001
- Lebreton B, Richard P, Galois R, Radenac G, Pfl ger C, Guillou G, Mornet F, Blanchard GF (2011b) Trophic importance of diatoms in an intertidal *Zostera noltii* seagrass bed: Evidence from stable isotope and fatty acid analyses. *Estuar Coast Shelf Sci* 92:140–153. doi: 10.1016/j.ecss.2010.12.027
- Lebreton B, Richard P, Galois R, Radenac G, Brahmia A, Colli G, Grouazel M, Andr  C, Guillou G, Blanchard GF (2012) Food sources used by sediment meiofauna in an intertidal *Zostera noltii* seagrass bed: A seasonal stable isotope study. *Mar Biol* 159:1537–1550. doi: 10.1007/s00227-012-1940-7
- Lebreton B, Richard P, Guillou G, Blanchard GF (2013) Trophic shift in young-of-the-year Mugilidae during salt-marsh colonization. *J Fish Biol* 82:1297–1307. doi: 10.1111/jfb.12069
- Leduc D (2009) Description of *Oncholaimus moanae* sp. nov. (Nematoda: Oncholaimidae), with notes on feeding ecology based on isotopic and fatty acid composition. *J Mar Biol Assoc United Kingdom* 89:337–344. doi: 10.1017/S0025315408002464
- Leduc D, Probert PK (2011) Small-scale effect of intertidal seagrass (*Zostera muelleri*) on meiofaunal abundance, biomass, and nematode community structure. *J Mar Biol Assoc United Kingdom* 91:579–591. doi: 10.1017/S0025315410001645
- Leduc D, Probert PK, Duncan A (2009) A multi-method approach for identifying meiofaunal trophic connections. *Mar Ecol Prog Ser* 383:95–111. doi: 10.3354/meps07991
- Lee S, Fuhrman JA (1987) Relationships between biovolume and biomass of naturally derived marine bacterioplankton. *Appl Environ Microbiol* 53:1298–1303. doi: 10.1016/0198-0254(87)96080-8
- Legendre L, Rassoulzadegan F (1996) Food-web mediated export of biogenic carbon in oceans: Hydrodynamic control. *Mar Ecol Prog Ser* 145:179–193. doi: 10.3354/meps145179
- Leguerrier D, Niquil N, Boileau N, Rzeznik J, Sauriau P-G, Le Moine O, Bacher C (2003) Numerical analysis of the food web of an intertidal mudflat ecosystem on the Atlantic coast of France. *Mar Ecol Prog Ser* 246:17–37. doi: 10.3354/meps246017
- Leguerrier D, Niquil N, Petiau A, Bodoy A (2004) Modeling the impact of oyster culture on a mudflat food web in Marennes-Ol ron Bay (France). *Mar Ecol Prog Ser* 273:147–161. doi: 10.3354/meps273147
- Leguerrier D, Degr  D, Niquil N (2007) Network analysis and inter-ecosystem comparison of two intertidal mudflat food webs (Brouage Mudflat and Aiguillon Cove, SW France). *Estuar Coast Shelf Sci* 74:403–418. doi: 10.1016/j.ecss.2007.04.014
- Lercari D, Bergamino L, Defeo O (2010) Trophic models in sandy beaches with contrasting morphodynamics: Comparing ecosystem structure and biomass flow. *Ecol Modell* 221:2751–2759. doi:

- 10.1016/j.ecolmodel.2010.08.027
- Loo LO, Rosenberg R (1996) Production and energy budget in marine suspension feeding populations: *Mytilus edulis*, *Cerastoderma edule*, *Mya arenaria* and *Amphiura filiformis*. *J Sea Res* 35:199–207.
- Lorenzen CJ (1966) A method for the continuous measurement of *in vivo* chlorophyll concentration. *Deep Sea Res Oceanogr Abstr* 13:223–227. doi: 10.1016/0011-7471(66)91102-8
- Lotze HK, Lenihan HS, Bourque BJ, Bradbury RH, Cooke RG, Kay MC, Kidwell SM, Kirby MX, Peterson CH, Jackson JBC (2006) Depletion, degradation and recovery potential of estuaries and coastal seas. *Science* (80-) 312:1806–1809. doi: 10.1126/science.1128035
- Louati H, Ben Said O, Soltani A, Got P, Mahmoudi E, Cravo-Laureau C, Duran R, Aissa P, Pringault O (2013) The roles of biological interactions and pollutant contamination in shaping microbial benthic community structure. *Chemosphere* 93:2535–2546. doi: 10.1016/j.chemosphere.2013.09.069
- Lü S, Wang X, Han B (2009) A field study on the conversion ratio of phytoplankton biomass carbon to chlorophyll-*a* in Jiaozhou Bay, China. *Chinese J Oceanol Limnol* 27:793–805. doi: 10.1007/s00343-009-9221-0
- Lubarsky HV, Hubas C, Chocholek M, Larson F, Manz W, Paterson DM, Gerbersdorf SU (2010) The stabilisation potential of individual and mixed assemblages of natural bacteria and microalgae. *PLoS One* 5:e13794. doi: 10.1371/journal.pone.0013794
- Lucas CH, Banham C, Holligan PM (2001) Benthic-pelagic exchange of microalgae at a tidal flat. 2. Taxonomic analysis. *Mar Ecol Prog Ser* 212:39–52. doi: 10.3354/meps212039
- MacBeth G, Razumiejczyk E, Ledsema R (2012) Cliff’s Delta Calculator: A non-parametric effect size program for two groups of observations. *Univ Psychol* 10:545–555.
- Machás R, Santos R (1999) Sources of organic matter in Ria Formosa revealed by stable isotope analysis. *Acta Oecologica* 20:463–469. doi: 10.1016/S1146-609X(99)00122-8
- MacIntyre HL, Geider RJ, Miller DC (1996) Microphytobenthos: The ecological role of the “Secret garden” of unvegetated, shallow-water marine habitats. I. Distribution, abundance and primary production. *Estuaries* 19:202. doi: 10.2307/1352225
- Majdi N, Tackx M, Traunspurger W, Buffan-Dubau E (2012) Feeding of biofilm-dwelling nematodes examined using HPLC-analysis of gut pigment contents. *Hydrobiologia* 680:219–232. doi: 10.1007/s10750-011-0920-0
- Majdi N, Hette-Tronquart N, Auclair E, Bec A, Chouvelon T, Cognie B, Danger M, Decottignies P, Dessier A, Desvilletes C, Dubois S, Dupuy C, Fritsch C, Gaucherel C, Hedde M, Jabot F, Lefebvre S, Marzloff MP, Peyrard N, Powolny T, Sabbadin R, Thebault E, Perga M-E (2018) There’s no harm in having too much: A comprehensive toolbox of methods in trophic ecology. *Food Webs* 16:0–22. doi: 10.13140/RG.2.1.3702.8566
- Malet N, Sauriau P-G, Ryckaert M, Malestroit P, Guillou G (2008) Dynamics and sources of suspended particulate organic matter in the Marennes-Oléron oyster farming bay: Insights from stable isotopes and microalgae ecology. *Estuar Coast Shelf Sci* 78:576–586. doi: 10.1016/j.ecss.2007.11.001
- Mallet AL, Carver CE, Landry T (2006) Impact of suspended and off-bottom Eastern oyster culture on the benthic environment in eastern Canada. *Aquaculture* 255:362–373. doi: 10.1016/j.aquaculture.2005.11.054
- Marbà N, Holmer M, Gacia E (2006) Seagrass beds and coastal biogeochemistry. In: Larkum AWD, Orth RJ, Duarte CM (eds) *Seagrasses: Biology, Ecology and Conservation*. Springer, Dordrecht, Netherlands, pp 159–192
- Maria TF, de Troch M, Vanaverbeke J, Esteves AM, Vanreusel A (2011) Use of benthic vs planktonic organic matter by sandy-beach organisms: A food tracing experiment with ¹³C labelled diatoms. *J Exp Mar Bio Ecol* 407:309–314. doi: 10.1016/j.jembe.2011.06.028
- Maria TF, Vanaverbeke J, Esteves AM, de Troch M, Vanreusel A (2012) The importance of biological interactions for

- the vertical distribution of nematodes in a temperate ultra-dissipative sandy beach. *Estuar Coast Shelf Sci* 97:114–126. doi: 10.1016/j.ecss.2011.11.030
- Mateo MA, Cebrián J, Dunton K, Mutchler T (2006) Carbon flux in seagrass ecosystems. In: Larkum AWD, Orth RJ, Duarte CM (eds) *Seagrasses: Biology, Ecology and Conservation*. Springer, Dordrecht, Netherlands, pp 159–192
- Materatski P, Vafeiadou AM, Ribeiro R, Moens T, Adão H (2015) A comparative analysis of benthic nematode assemblages from *Zostera noltii* beds before and after a major vegetation collapse. *Estuar Coast Shelf Sci* 167:256–268. doi: 10.1016/j.ecss.2015.07.001
- Materatski P, Ribeiro R, Moreira-Santos M, Sousa JP, Adão H (2018) Nematode biomass and morphometric attributes as descriptors during a major *Zostera noltii* collapse. *Mar Biol* 165:1–17. doi: <http://dx.doi.org/10.1007/s00227-018-3283-5>
- Mayer LM (1994) Relationships between mineral surfaces and organic carbon concentrations in soil and sediments. *Chem Geol* 114:347–363. doi: 10.1016/0009-2541(94)90063-9
- McCann KS, Hastings A (1997) Re-evaluating the omnivory – stability relationship in food webs. *Proc R Soc B Biol Sci* 264:1249–1254.
- McLusky DS, Elliott M (2004) *The estuarine ecosystem: ecology, threats and management*. OUP, Oxford, U.K.
- Méléder V, Barillé L, Rincé Y, Morançais M, Rosa P, Gaudin P (2005) Spatio-temporal changes in microphytobenthos structure analysed by pigment composition in a macrotidal flat (Bourgneuf Bay, France). *Mar Ecol Prog Ser* 297:83–99. doi: 10.3354/meps297083
- Menn I (2002) Ecological comparison of two sandy shores with different wave energy and morphodynamics in the North Sea. *Ber Polarforsch Meeresforsch* 417:1–170.
- Middelburg JJ (2014) Stable isotopes dissect aquatic food webs from the top to the bottom. *Biogeosciences* 11:2357–2371. doi: 10.5194/bg-11-2357-2014
- Middelburg JJ, Barranguet C, Boschker HTS, Herman PMJ, Moens T, Heip CHR (2000) The fate of intertidal microphytobenthos carbon: An in situ ¹³C-labeling study. *Limnol Oceanogr* 45:1224–1234. doi: 10.4319/lo.2000.45.6.1224
- Mielck F, Holler P, Bürk D, Hass HC (2015) Interannual variability of sorted bedforms in the coastal German Bight (SE North Sea). *Cont Shelf Res* 111:31–41. doi: 10.1016/j.csr.2015.10.016
- Millennium Ecosystem Assessment (MEA) (2005) *Ecosystems and Human Well-being: Synthesis*. Island Press, Washington, DC, USA
- Moens T, Vincx M (1997a) A state of the art on meiofaunal respiration and production. In: Baeyens J, Dehairs F, Goeyens L (eds) *Second network meeting of the European network for integrated marine system analysis*, FWO-Vlaanderen. VUB-University Press, Brussels, Belgium, pp 347–361
- Moens T, Vincx M (1997b) Observations on the feeding ecology of estuarine nematodes. *J Mar Biol Assoc United Kingdom* 77:211–227.
- Moens T, Gansbeke DV, Vincx M (1999a) Linking estuarine nematodes to their suspected food. A case study from the Westerschelde Estuary (south-west Netherlands). *J Mar Biol Assoc United Kingdom* 79:1017–1027. doi: 10.1017/S0025315499001253
- Moens T, Verbeeck L, de Maeyer A, Swings J, Vincx M (1999b) Selective attraction of marine bacterivorous nematodes to their bacterial food. *Mar Ecol Prog Ser* 176:165–178. doi: 10.3354/meps176165
- Moens T, Luyten C, Middelburg JJ, Herman PMJ, Vincx M (2002) Tracing organic matter sources of estuarine tidal flat nematodes with stable carbon isotopes. *Mar Ecol Prog Ser* 234:127–137. doi: 10.3354/meps234127
- Moens T, Dos Santos GAP, Thompson F, Swings J, Fonsêca-Genevois V, Vincx M, de Mesel I (2005a) Do nematode

- mucus secretions affect bacterial growth? *Aquat Microb Ecol* 40:77–83. doi: 10.3354/ame040077
- Moens T, Bouillon S, Gallucci F (2005b) Dual stable isotope abundances unravel trophic position of estuarine nematodes. *J Mar Biol Assoc United Kingdom* 85:1401–1407. doi: 10.1017/S0025315405012580
- Moens T, Braeckman U, Derycke S, Fonseca G, Gallucci F, Gingold R, Guilini K, Ingels J, Leduc D, Vanaverbeke J, Van Colen C, Vanreusel A, Vincx M (2013) Ecology of free-living marine nematodes. In: Schmidt-Rhaesa A (ed) *Nematoda*. De Gruyter, Berlin, Germany, pp 109–152
- Moens T, Vafeiadou A-M, de Geyter E, Vanormelingen P, Sabbe K, de Troch M (2014) Diatom feeding across trophic guilds in tidal flat nematodes, and the importance of diatom cell size. *J Sea Res* 92:125–133. doi: 10.1016/j.seares.2013.08.007
- Monaco ME, Ulanowicz RE (1997) Comparative ecosystem trophic structure of three US mid- Atlantic estuaries. *Mar Ecol Prog Ser* 161:239–254. doi: 10.3354/meps161239
- Moncreiff CA, Sullivan MJ (2001) Trophic importance of epiphytic algae in subtropical seagrass beds: evidence from multiple stable isotope analyses. *Mar Ecol Prog Ser* 215:93–106.
- Monserat JM, Rosa CE, Sandrini JZ, Marins LF, Bianchini A, Geracitano LA (2003) Annelids and nematodes as sentinels of environmental pollution. *Comments Toxicol* 9:289–301.
- Montagna PA (1984) In situ measurement of meiobenthic grazing rates on sediment bacteria and edaphic diatoms. *Mar Ecol Prog Ser* 18:119–130. doi: 10.3354/meps018119
- Montagna PA, Coull BC, Herring TL, Dudley BW (1983) The relationship between abundances of meiofauna and their suspected microbial food (diatoms and bacteria). *Estuar Coast Shelf Sci* 17:381–394. doi: 10.1016/0272-7714(83)90124-5
- Montagna PA, Blanchard GF, Dinet A (1995) Effect of production and biomass of intertidal microphytobenthos on meiofaunal grazing rates. *J Exp Mar Bio Ecol* 185:149–165. doi: 10.1016/0022-0981(94)00138-4
- Moriarty DJW, Iverson RL, Pollard PC (1986) Exudation of organic carbon by the seagrass *Halodule wrightii* Aschers. and its effect on bacterial growth in the sediment. *J Exp Mar Bio Ecol* 96:115–126. doi: 10.1016/0022-0981(86)90237-6
- Murdoch DJ, Chow ED (1996) A graphical display of large correlation matrices. *Am Stat* 50:178–180.
- Mutchler T, Sullivan MJ, Fry B (2004) Potential of ¹⁴N isotope enrichment to resolve ambiguities in coastal trophic relationships. *Mar. Ecol. Prog. Ser.* 266:27–33.
- Nascimento FJA, Naslund J, Elmgren R (2012) Meiofauna enhances organic matter mineralization in soft sediment ecosystems. *Limnol Oceanogr* 57:338–346. doi: 10.4319/lo.2012.57.1.0338
- Näslund J, Nascimento FJA, Gunnarsson JS (2010) Meiofauna reduces bacterial mineralization of naphthalene in marine sediment. *ISME J* 4:1421–1430. doi: 10.1038/ismej.2010.63
- Navarro J, Coll M, Louzao M, Palomera I, Delgado A, Forero MG (2011) Comparison of ecosystem modelling and isotopic approach as ecological tools to investigate food webs in the NW Mediterranean Sea. *J Exp Mar Bio Ecol* 401:97–104. doi: 10.1016/j.jembe.2011.02.040
- Ndaro SGM, Olafsson E (1999) Soft-bottom fauna with emphasis on nematode assemblage structure in a tropical intertidal lagoon in Zanzibar, eastern Africa. I. spatial variability. *Hydrobiologia* 405:133–148. doi: 10.1023/A
- Newell RC, Linley EAS (1984) Significance of microheterotrophs in the decomposition of phytoplankton: estimates of carbon and nitrogen flow based on the biomass of plankton communities. *Mar Ecol Prog Ser* 16:105–119. doi: 10.3354/meps016105
- Nielsen AM, Eriksen NT, Iversen JLL, Riisgard HU (1995) Feeding, growth and respiration in the polychaetes *Nereis diversicolor* (facultative filter feeder) and *N. virens* (omnivorous) - a comparative study. *Mar Ecol Prog Ser*

- 125:149–158. doi: 10.3354/meps125149
- Niquil N, Arias-González JE, Delesalle B, Ulanowicz RE (1999) Characterization of the planktonic food web of Takapoto Atoll lagoon, using network analysis. *Oecologia* 118:232–241. doi: 10.1007/s004420050723
- Niquil N, Bartoli G, Urabe J, Jackson GA, Legendre L, Dupuy C, Kumagai M (2006) Carbon steady-state model of the planktonic food web of Lake Biwa, Japan. *Freshw Biol* 51:1570–1585. doi: 10.1111/j.1365-2427.2006.01595.x
- Niquil N, Saint-Béat B, Johnson GA, Soetaert K, van Oevelen D, Bacher C, Vézina AF (2012) Inverse modeling in modern ecology and application to coastal Ecosystems. In: Wolanski E, McLusky D (eds) *Treatise on Estuarine and Coastal Science*. Academic Press, pp 115–133
- Nugues MM, Kaiser MJ, Spencer BE, Edwards DB (1996) Benthic community changes associated with intertidal oyster cultivation. *Aquac Res* 27:913–924.
- Nyssen F, Brey T, Dauby P, Graeve M (2005) Trophic position of Antarctic amphipods - Enhanced analysis by a 2-dimensional biomarker assay. *Mar Ecol Prog Ser* 300:135–145. doi: 10.3354/meps300135
- Odum EP (1969) The strategy of ecosystem development. *Science* (80-) 164:262–270.
- Oksanen J, Blanchet FG, Friendly M, Kindt R, Legendre P, Mcglinn D, Minchin PR, O'hara RB, Simpson GL, Solymos P, Henry M, Stevens H, Szoecs E, Wagner H (2017) *vegan: community ecology package*. R package version 2.4-1.
- Orth RJ, Carruthers TJB, Dennison W, Duarte CM (2006) A global crisis for seagrass ecosystems. *Bioscience* 56:533–537. doi: 10.1641/0006-3568(2006)56
- Ott JA, Schiemer F (1973) Respiration and anaerobiosis of free living nematodes from marine and limnic sediments. *Netherlands J Sea Res* 7:233–243. doi: 10.1016/0077-7579(73)90047-1
- Ouisse V, Migné A, Davoult D (2010) Seasonal variations of community production, respiration and biomass of different primary producers in an intertidal *Zostera noltii* bed (Western English Channel, France). *Hydrobiologia* 649:3–11. doi: 10.1007/s10750-010-0254-3
- Ouisse V, Riera P, Migné A, Leroux C, Davoult D (2012) Food web analysis in intertidal *Zostera marina* and *Zostera noltii* communities in winter and summer. *Mar Biol* 159:165–175. doi: 10.1007/s00227-011-1796-2
- Pace MC, Carman KR (1996) Interspecific differences among meiobenthic copepods in the use of microalgal food resources. *Mar Ecol Prog Ser* 143:77–86. doi: 10.3354/meps143077
- Pace ML, Glasser JE, Pomeroy LR (1984) A simulation analysis of continental shelf food webs. *Mar Biol* 82:47–63. doi: 10.1007/BF00392763
- Pacella SR, Lebreton B, Richard P, Phillips D, DeWitt TH, Niquil N (2013) Incorporation of diet information derived from Bayesian stable isotope mixing models into mass-balanced marine ecosystem models: A case study from the Marennes-Oléron Estuary, France. *Ecol Modell* 267:127–137. doi: 10.1016/j.ecolmodel.2013.07.018
- Pape E, Bezerra TN, Vanneste H, Heeschen K, Moodley L, Leroux F, van Breugel P, Vanreusel A (2011) Community structure and feeding preference of nematodes associated with methane seepage at the Darwin mud volcano (Gulf of Cádiz). *Mar Ecol Prog Ser* 438:71–83. doi: 10.3354/meps09278
- Parnell AC, Inger R, Bearhop S, Jackson AL (2010) Source partitioning using stable isotopes: coping with too much variation. *PLoS One* 5:e9672. doi: 10.1371/journal.pone.0009672
- Parrish CC (2013) Lipids in marine ecosystems. *Int Sch Res Not* 2013:16.
- Parrish CC, Abrajano TA, Budge SM, Helleur RJ, Hudson ED, Pulchan K, Ramos C (2000) Lipid and phenolic biomarkers in marine ecosystems: analysis and applications. In: Wangersky P (ed) *Marine Chemistry*. Springer, Berlin, Germany, pp 193–223
- Pascal P-Y (2008) Devenir des bacteries dans les reseaux trophiques des vasières intertidales: le cas de Brouage (Baie

- de Marennes-Oléron). University of La Rochelle, France
- Pascal P-Y, Dupuy C, Richard P, Rzeznik-Orignac J, Niquil N (2008) Bacterivory of a mudflat nematode community under different environmental conditions. *Mar Biol* 154:671–682. doi: 10.1007/s00227-008-0960-9
- Pascal P-Y, Dupuy C, Richard P, Mallet C, du Châtelet EA, Niquil N (2009) Seasonal variation in consumption of benthic bacteria by meio- and macrofauna in an intertidal mudflat. *Limnol Oceanogr* 54:1048–1059. doi: 10.4319/lo.2009.54.4.1048
- Pauly D, Soriano-Bartz ML, Palomares MLD (1993) Improved construction, parameterization and interpretation of steady-state ecosystem models. In: Christensen V, Pauly D (eds) *Trophic Models of Aquatic Ecosystems*. ICLARM Conference Proceedings. 26, pp 1–13
- Pedersen O, Borum J, Duarte CM, Fortes MD (1998) Oxygen dynamics in the rhizosphere of *Cymodocea rotundata*. *Mar Ecol Prog Ser* 169:283–288. doi: 10.3354/meps169283
- Pelz O, Hesse C, Tesar M, Coffin RB, Abraham WR (1997) Development of methods to measure carbon isotope ratios of bacterial biomarkers in the environment. *Isotopes Environ Health Stud* 33:131–144. doi: 10.1080/10256019808036364
- Peterson BJ, Fry B (1987) Stable isotopes in ecosystem studies. *Annu Rev Ecol Syst* 18:293–320.
- Phillips DL, Inger R, Bearhop S, Jackson AL, Moore JW, Parnell AC, Semmens BX, Ward EJ (2014) Best practices for use of stable isotope mixing models in food-web studies. *Can J Zool* 835:823–835. doi: 10.1139/cjz-2014-0127
- Pierre G, Graber M, Orvain F, Dupuy C, Maugard T (2010) Biochemical characterization of extracellular polymeric substances extracted from an intertidal mudflat using a cation exchange resin. *Biochem Syst Ecol* 38:917–923. doi: 10.1016/j.bse.2010.09.014
- Pierre G, Graber M, Rafiliposon BA, Dupuy C, Orvain F, De Crignis M, Maugard T (2012) Biochemical composition and changes of extracellular polysaccharides (ECPS) produced during microphytobenthic biofilm development (Marennes-Oléron, France). *Microb Ecol* 63:157–169. doi: 10.1007/s00248-011-9959-8
- Pierre G, Zhao JM, Orvain F, Dupuy C, Klein GL, Graber M, Maugard T (2013) Seasonal dynamics of extracellular polymeric substances (EPS) in surface sediments of a diatom-dominated intertidal mudflat (Marennes-Oléron, France). *J Sea Res* 92:26–35. doi: 10.1016/j.seares.2013.07.018
- Pihl L (1985) Food selection and consumption of mobile epibenthic fauna in shallow marine areas. *Mar Ecol Prog Ser* 22:169–179. doi: 10.3354/meps022169
- Pinckney JL, Zingmark RG (1993) Modeling the annual production of intertidal benthic microalgae in estuarine ecosystems. *J Phycol* 29:396–407. doi: 10.1111/j.1529-8817.1993.tb00140.x
- Pinckney JL, Carman KR, Lumsden SE, Hymel SN (2003) Microalgal-meiofaunal trophic relationships in muddy intertidal estuarine sediments. *Aquat Microb Ecol* 31:99–108. doi: 10.3354/ame031099
- Platt HM, Warwick RM (1983) Free-living marine nematodes. Part I: British enoplids. *Synopsis of the British Fauna (new) No. 28*. Cambridge University Press, Cambridge, U.K.
- Platt HM, Warwick RM (1988) Free-living marine nematodes. Part II: British chromadorids. *Synopsis of the British Fauna (new) No. 38*. Brill, E.J. and Dr. Backhuys, W., Cambridge, U.K.
- Pockberger M, Kellnreiter F, Ahnelt H, Asmus RM, Asmus H (2014) An abundant small sized fish as keystone species? The effect of *Pomatoschistus microps* on food webs and its trophic role in two intertidal benthic communities: A modeling approach. *J Sea Res* 86:86–96. doi: 10.1016/j.seares.2013.11.008
- Pohlert T (2018) PMCMRplus: Calculate pairwise multiple comparisons of mean rank sums extended.
- Post DM (2002) Using stable isotopes to estimate trophic position: models, methods, and assumptions. *Ecology* 83:703–718. doi: Doi 10.2307/3071875

References

- Prather CM, Pelini SL, Laws A, Rivest E, Woltz M, Bloch CP, Del Toro I, Ho CK, Kominoski J, Newbold TAS, Parsons S, Joern A (2013) Invertebrates, ecosystem services and climate change. *Biol Rev* 88:327–348. doi: 10.1111/brv.12002
- Rajendran N, Suwa Y, Urushigawa Y (1993) Distribution of phospholipid ester-linked fatty acid biomarkers for bacteria in the sediment of Ise Bay, Japan. *Mar Chem* 42:39–56. doi: 10.1016/0304-4203(93)90248-M
- Ramos CS, Parrish CC, Quibuyen TAO, Abrajano TA (2003) Molecular and carbon isotopic variations in lipids in rapidly settling particles during a spring phytoplankton bloom. *Org Geochem* 34:195–207. doi: 10.1016/S0146-6380(02)00166-3
- Rau GH, Mearns AJ, Young DR, Olson RJ, Schafer HA, Kaplan IR (1983) Animal $^{13}\text{C}/^{12}\text{C}$ correlates with trophic level in pelagic food webs. *Ecology* 64:1314–1318.
- Ravail B, Héral M, Maestrini S, Robert J-M (1988) Incidence du débit de la Charente sur la capacité biotique du bassin ostréicole du bassin de Marennes-Oléron. *J Rech Océanographique* 13:48–52.
- Reed DJ (1990) The impact of sea-level rise marshes. *Prog Phys Geogr* 14:465–481.
- Reichelt AC (1991) Environmental effects of meiofaunal burrowing. In: Meadows PS, Meadows A (eds) *The Environmental Impact of Burrowing Animals and Animal Burrows*. Oxford Scientific Publications, Oxford, U.K., pp 33–52
- Reise K (1985) *Tidal flat ecology: An experimental approach to species interactions*, Ecological. Springer, Berlin, Germany
- Reise K (2002) Sediment mediated species interaction in coastal waters. *J Sea Res* 48:127–141.
- Reise K, Kohlus J (2008) Seagrass recovery in the Northern Wadden Sea? *Helgol Mar Res* 62:77–84. doi: 10.1007/s10152-007-0088-1
- Richmond CE, Wethey DS, Woodin SA (2007) Climate change and increased environmental variability: Demographic responses in an estuarine harpacticoid copepod. *Ecol Modell* 209:189–202. doi: 10.1016/j.ecolmodel.2007.06.023
- Riera P, Richard P (1996) Isotopic determination of food sources of *Crassostrea gigas* along a trophic gradient in the estuarine Bay of Marennes-Oléron. *Estuar Coast Shelf Sci* 42:347–360. doi: 10.1006/ecss.1996.0023
- Riera P, Richard P, Grémare A, Blanchard GF (1996) Food source of intertidal nematodes in the Bay of Marennes-Oléron (France), as determined by dual stable isotope analysis. *Mar Ecol Prog Ser* 142:303–309. doi: 10.3354/meps142303
- Rivkin RB, Legendre L, Deibel D, Tremblay JE, Klein B, Crocker K, Roy S, Silverberg N, Lovejoy C, Mesplé F, Romero N, Anderson MR, Matthews P, Savenkoff C, Vézina A, Therriault JC, Wesson J, Bérubé C, Ingram RG (1996) Vertical flux of biogenic carbon in the ocean: Is there food web control? *Science* (80-) 272:1163–1166. doi: 10.1126/science.272.5265.1163
- Robinson JJ, Cavanaugh CM (1995) Expression of form I and form II Rubisco in chemoautotrophic symbioses: Implications for the interpretation of stable carbon isotope values. *Limnol Oceanogr* 40:1496–1502.
- Romero J, Lee K-S, Perez M, Mateo MA, Alcoverro T (2006) Nutrient dynamics in seagrass ecosystems. In: Larkum WD, Orth RJ, Duarte CM (eds) *Seagrasses: Biology, Ecology and Conservation*. Springer, Dordrecht, Netherlands, pp 227–254
- Rothstein M, Gotz P (1968) Biosynthesis of fatty acids in the free-living nematode, *Turbatrix aceti*. *Arch Biochem Biophys* 126:131–140.
- Round FE (1971) Benthic marine diatoms. *Oceanogr Mar Biol Annu Rev* 9:83–139.
- Rudnick DT (1989) Time lags between the deposition and meiobenthic assimilation of phytodetritus. *Mar Ecol Prog Ser* 50:231–240. doi: 10.3354/meps050231

- Rudnick DT, Elmgren R, Frithsen JB (1985) Meiofaunal prominence and benthic seasonality in a coastal marine ecosystem. *Oecologia* 67:157–168. doi: 10.1007/BF00384279
- Rybarczyk H, Elkaim B, Ochs L, Loquet N (2003) Analysis of the trophic network of a macrotidal ecosystem: The Bay of Somme (Eastern Channel). *Estuar Coast Shelf Sci* 58:405–421. doi: 10.1016/S0272-7714(02)00294-9
- Rzeznik-Orignac J, Fichet D (2012) Experimental estimation of assimilation rates of meiofauna feeding on ¹⁴C-labelled benthic diatoms. *J Exp Mar Bio Ecol* 432–433:179–185. doi: 10.1016/j.jembe.2012.06.019
- Rzeznik-Orignac J, Fichet D, Boucher G (2003) Spatio-temporal structure of the nematode assemblages of the Brouage mudflat (Marennes-Oléron, France). *Estuar Coast Shelf Sci* 58:77–88. doi: 10.1016/S0272-7714(03)00061-1
- Rzeznik-Orignac J, Boucher G, Fichet D, Richard P (2008) Stable isotope analysis of food source and trophic position of intertidal nematodes and copepods. *Mar Ecol Prog Ser* 359:145–150. doi: 10.3354/meps07328
- Saint-Béat B, Dupuy C, Bocher P, Chalumeau J, De Crignis M, Fontaine C, Guizien K, Lavaud J, Lefebvre S, Montanié H, Mouget J-L, Orvain F, Pascal P-Y, Quaintenne G, Radenac G, Richard P, Robin F, Vézina AF, Niquil N (2013a) Key features of intertidal food webs that support migratory shorebirds. *PLoS One* 8:1–17. doi: 10.1371/journal.pone.0076739
- Saint-Béat B, Vézina AF, Asmus RM, Asmus H, Niquil N (2013b) The mean function provides robustness to linear inverse modelling flow estimation in food webs: A comparison of functions derived from statistics and ecological theories. *Ecol Modell* 258:53–64. doi: 10.1016/j.ecolmodel.2013.01.023
- Saint-Béat B, Dupuy C, Agogue H, Carpentier A, Chalumeau J, Como S, David V, De Crignis M, Duchêne J-C, Fontaine C, Feunteun E, Guizien K, Hartmann H, Lavaud J, Lefebvre S, Lefrançois C, Mallet C, Montanié H, Mouget J-L, Orvain F, Ory P, Pascal P-Y, Radenac G, Richard P, Vézina AF, Niquil N (2014) How does the resuspension of the biofilm alter the functioning of the benthos-pelagos coupled food web of a bare mudflat in Marennes-Oléron Bay (NE Atlantic)? *J Sea Res* 92:144–157. doi: 10.1016/j.seares.2014.02.003
- Saint-Béat B, Baird D, Asmus H, Asmus RM, Bacher C, Pacella SR, Johnson GA, David V, Vézina AF, Niquil N (2015) Trophic networks: How do theories link ecosystem structure and functioning to stability properties? A review. *Ecol Indic* 52:458–471. doi: 10.1016/j.ecolind.2014.12.017
- Sander BC, Kalff J (1993) Factors controlling bacterial production in marine and freshwater sediments. *Microb Ecol* 26:79–99. doi: 10.1007/BF00177045
- Sargent JR (1987) Lipid biomarkers in marine ecology. In: Sleigh M (ed) *Microbes in the Sea*. Ellis Horwood Limited, Chichester, U.K., pp 119–138
- Sargent JR, Whittle KJ (1981) Lipids and hydrocarbons in the marine food web. In: Longhurst AR (ed) *Analysis of Marine Ecosystems*. Academic Press, London, England ; New York, US, pp 491–533
- Sautour B, Castel J (1993a) Distribution of zooplankton populations in Marennes-Oléron Bay (France), structure and grazing impact of copepod communities. *Oceanol Acta* 16:279–290.
- Sautour B, Castel J (1993b) Feeding behaviour of the coastal copepod. *Cah Biol Mar* 1993:239–251.
- Sautour B, Castel J (1998) Importance of microzooplanktonic crustaceans in the coastal food chain: Bay of Marennes-Oléron, France. *Oceanol Acta* 21:105–112. doi: 10.1016/S0399-1784(98)80054-6
- Scharler UM, Baird D (2005) A comparison of selected ecosystem attributes of three South African estuaries with different freshwater inflow regimes, using network analysis. *J Mar Syst* 56:283–308. doi: 10.1016/j.jmarsys.2004.12.003
- Schiemer F, Duncan A, Klekowski RZ (1980) A bioenergetic study of a benthic nematode, *Plectus palustris* de man 1880, throughout its life cycle - II. Growth, fecundity and energy budgets at different densities of bacterial food and general ecological considerations. *Oecologia* 44:205–212. doi: 10.1007/BF00346410

References

- Schmidt JL, Deming JW, Jumars PA, Keil RG (1998) Constancy of bacterial abundance in surficial marine sediments. *Limnol Oceanogr* 43:976–982.
- Scholz DS, Matthews LL, Feller RJ (1991) Detecting selective digestion of meiobenthic prey by juvenile spot *Leiostomus xanthurus* (Pisces) using immunoassays. *Mar Ecol Prog Ser* 72:59–67. doi: 10.3354/meps072059
- Schratzberger M, Ingels J (2017) Meiofauna matters: The roles of meiofauna in benthic ecosystems. *J Exp Mar Bio Ecol* 502:12–25. doi: 10.1016/j.jembe.2017.01.007
- Schratzberger M, Bolam SG, Whomersley P, Warr K, Rees HL (2004) Development of a meiobenthic nematode community following the intertidal placement of various types of sediment. *J Exp Mar Bio Ecol* 303:79–96. doi: 10.1016/j.jembe.2003.11.003
- Schückel U, de Jonge V, Ludovisi A, Giebels D, Horn S, Niquil N, Asmus H, Asmus RM, Eulaers I, Safi G, Scharler UM (2018) Use of coastal and estuarine food web models in policy making and management : The need for an entire ecosystem approach. 26. doi: 10.13140/RG.2.2.35173.09440
- Schwinghamer P, Hargrave B, Peer D, Hawkins CM (1986) Partitioning of production and respiration among size groups of organisms in an intertidal benthic community. *Mar Ecol Prog Ser* 31:131–142. doi: 10.3354/meps031131
- Seinhorst JW (1959) A rapid method for the transfer of nematodes from fixative to anhydrous glycerin. *Nematologica* 4:67–69. doi: 10.1163/187529259X00381
- Semprucci F, Balsamo M (2012) Free-living marine nematodes as bioindicators: Past, present and future perspectives. *Environ Res J* 6:17–36.
- Semprucci F, Boi P, Manti A, Harriague AC, Rocchi M, Colantoni P, Papa S, Balsamo M (2010) Benthic communities along a littoral of the Central Adriatic Sea (Italy). *Helgol Mar Res* 64:101–115. doi: 10.1007/s10152-009-0171-x
- Serôdio J, Vieira S, Cruz S (2008) Photosynthetic activity, photoprotection and photoinhibition in intertidal microphytobenthos as studied in situ using variable chlorophyll fluorescence. *Cont Shelf Res* 28:1363–1375. doi: 10.1016/j.csr.2008.03.019
- Short FT, Wyllie-Echeverria S (1996) Natural and human-induced disturbance of seagrasses. *Environ Conserv* 23:17. doi: 10.1017/S0376892900038212
- Sikora JP, Sikora WB, Erkenbrecher CW, Coull BC (1977) Significance of ATP, carbon, and caloric content of meiobenthic nematodes in partitioning benthic biomass. *Mar Biol* 44:7–14. doi: 10.1007/BF00386899
- Sikora WB, Sikora JP (1982) Ecological implications of the vertical distribution of meiofauna in salt marsh sediments. *Estuar Comp* 269–282. doi: 10.1016/B978-0-12-404070-0.50022-3
- Simas T, Nunes JP, Ferreira JG (2001) Effects of global climate change on coastal salt marshes. *Ecol Modell* 139:1–15. doi: 10.1016/S0304-3800(01)00226-5
- Smidt ELB (1951) Animal production in the Danish Waddensea. *Meddr Kommm Danm Fisk-og Havunders, Ser Fisk* 11:1–151.
- Smith DJ, Underwood GJC (1998) Exopolymer production by intertidal epitellic diatoms. *Limnol Oceanogr* 43:1578–1591.
- Smith LD, Coull BC (1987) Juvenile spot (Pisces) and grass shrimp predation on meiobenthos in muddy and sandy substrata. *J Exp Mar Bio Ecol* 105:123–136. doi: 10.1016/0022-0981(87)90167-5
- Smith SM, Hoff JG, O’Neil SP, Weinsten MP (1984) Community and trophic organization of nekton utilizing shallow marsh habitats, York River, Virginia. *Fish Bull* 82:455–467.
- Smol N, Willems KA, Govaere JCR, Sandee AJJ (1994) Composition, distribution and biomass of meiobenthos in the Oosterschelde estuary (SW Netherlands). *Hydrobiologia* 282–283:197–217. doi: 10.1007/BF00024631

- Snelgrove PVR (1997) The importance of marine sediment biodiversity in ecosystem processes. *Ambio* 26:578–583.
- Snelgrove PVR (1999) Getting to the bottom of marine biodiversity: Sedimentary habitats ocean bottoms are the most widespread habitat on Earth and support high biodiversity and key ecosystem services. *Bioscience* 49:129–138. doi: 10.2307/1313538
- Soetaert K, Vincx M, Wittoeck J, Tulkens M (1995) Meiobenthic distribution and nematode community structure in five European estuaries. *Hydrobiologia* 311:185–206. doi: 10.1007/BF00008580
- Soetaert K, Franco M, Lampadariou N, Muthumbi A, Steyaert M, Vandepitte L, Berghe EV, Vanaverbeke J (2009) Factors affecting nematode biomass, length and width from the shelf to the deep sea. *Mar Ecol Prog Ser* 392:123–132. doi: 10.3354/meps08202
- Sornin JM, Feuillet M, Héral M, Deslous-Paoli JM (1983) Effet des biodepôts de l’huitre *Crassostrea gigas* (Thunberg) sur l’accumulation de matières organiques dans les parcs du bassin de Marennes-Oléron. *J Molluscan Stud* 49:185–197.
- Spring S, Schulze R, Overmann J, Schleifer KH (2000) Identification and characterization of ecologically significant prokaryotes in the sediment of freshwater lakes: Molecular and cultivation studies. *FEMS Microbiol Rev* 24:573–590. doi: 10.1016/S0168-6445(00)00046-2
- Steyaert M, Herman PMJ, Moens T, Widdows J, Vincx M (2001) Tidal migration of nematodes on an estuarine tidal flat (the Molenplaat, Schelde Estuary, SW Netherlands). *Mar Ecol Prog Ser* 224:299–304. doi: 10.3354/meps224299
- Steyaert M, Vanaverbeke J, Vanreusel A, Barranguet C (2003) The importance of fine-scale, vertical profiles in characterising nematode community structure. *Estuar Coast Shelf Sci* 58:353–366. doi: 10.1016/S0272-7714(03)00086-6
- Steyaert M, Moodley L, Nadong T, Moens T, Soetaert K, Vincx M (2007) Responses of intertidal nematodes to short-term anoxic events. *J Exp Mar Bio Ecol* 345:175–184. doi: 10.1016/J.JEMBE.2007.03.001
- Stock B, Semmens B, Ward E, Parnell A, Jackson A, Phillips D (2018) MixSIAR: Bayesian mixing models in R.
- Sundbäck K, Nilsson P, Nilsson C, Jönsson B (1996) Balance between autotrophic and heterotrophic components and processes in microbenthic communities of sandy sediments: A field study. *Estuar Coast Shelf Sci* 43:689–706. doi: 10.1006/ecss.1996.0097
- Sutherland TF, Grant J, Amos CL (1998) The effect of carbohydrate production by the diatom *Nitzschia curvilineata* on the erodibility of sediment. *Limnol Oceanogr* 43:65–72. doi: 10.4319/lo.1998.43.1.0065
- Suzuki R, Shimodaira H (2015) Hierarchical clustering with p-values via multiscale bootstrap resampling. R package version 2.0-0.
- Team RC (2013) R: A language and environment for statistical computing.
- Tecchio S, Rius AT, Dauvin J-C, Lobry J, Lassalle G, Morin J, Bacq N, Cachera M, Chaalali A, Villanueva MC, Niquil N (2015) The mosaic of habitats of the Seine estuary: Insights from food-web modelling and network analysis. *Ecol Modell* 312:91–101. doi: <http://dx.doi.org/10.1016/j.ecolmodel.2015.05.026>
- Tecchio S, Chaalali A, Raoux A, Tous Rius A, Lequesne J, Girardin V, Lassalle G, Cachera M, Riou P, Lobry J, Dauvin J-C, Niquil N (2016) Evaluating ecosystem-level anthropogenic impacts in a stressed transitional environment: The case of the Seine estuary. *Ecol Indic*. doi: 10.1016/j.ecolind.2015.10.036
- Terrados J, Borum J (2004) Why are seagrass important? - Goods and services provided by seagrass meadows. In: Borum J, Duarte CM, Krause-Jensen D, Greve TM (eds) *European Seagrasses: An Introduction to Monitoring and Management*. The M&MS project, pp 8–11
- Thornton DCO, Dong LF, Underwood GJC, Nedwell DB (2002) Factors affecting microphytobenthic biomass, species

References

- composition and production in the Colne Estuary (UK). *Aquat Microb Ecol* 27:285–300. doi: 10.3354/ame027285
- Tietjen JH (1969) The ecology of shallow water meiofauna in two New England estuaries. *Oecologia* 2:251–291. doi: 10.1007/BF00386114
- Tietjen JH, Lee JJ (1977) Feeding behaviour of marine nematodes. In: Coul B (ed) *Ecology of Marine Benthos*. University of South Carolina Press, Columbia, USA, pp 21–35
- Tumbiolo ML, Downing JA (1994) An empirical model for the prediction of secondary production in marine benthic invertebrate populations. *Mar Ecol Prog Ser* 114:165–174. doi: 10.3354/meps114165
- Turner JT (2002) Zooplankton fecal pellets, marine snow and sinking phytoplankton blooms. *Aquat Microb Ecol* 27:57–102. doi: Doi 10.3354/Ame027057
- Turpie JK, Hockey PAR (1984) Foraging ecology and seasonal energy budgets of estuarine grey plovers *Pluvialis squatarola* and whimbrels *Numenius phaeopus* at the southern tip of Africa. *Adea* 1/2:57–74.
- Ubertini M, Lefebvre S, Rakotomalala C, Orvain F (2015) Impact of sediment grain-size and biofilm age on epipelagic microphytobenthos resuspension. *J Exp Mar Bio Ecol* 467:52–64. doi: 10.1016/j.jembe.2015.02.007
- Ulanowicz RE (2004) Quantitative methods for ecological network analysis. *Comput Biol Chem* 28:321–339. doi: 10.1016/j.compbiolchem.2004.09.001
- Ulanowicz RE (2011) Quantitative methods for Ecological Network Analysis and its application to coastal ecosystems. In: Wolanski E, McLusky D (eds) *Treatise on Estuarine and Coastal Science*. Academic Press, pp 35–57
- Ulanowicz RE, Norden JS (1990) Symmetrical overhead in flow networks. *Int J Syst Sci* 21:429–437. doi: 10.1080/00207729008910372
- Ulanowicz RE, Goerner SJ, Lietaer B, Gomez R (2009) Quantifying sustainability: Resilience, efficiency and the return of information theory. *Ecol Complex* 6:27–36. doi: 10.1016/j.ecocom.2008.10.005
- Underwood GJC, Kromkamp J (1999) Primary production by phytoplankton and microphytobenthos in estuaries. *Adv Ecol Res* 29:93–153.
- Underwood GJC, Paterson DM (1993) Recovery of intertidal benthic diatoms after biocide treatment and associated sediment dynamics. *J Mar Biol Assoc United Kingdom* 73:25–45. doi: 10.1017/S002531540003263X
- Underwood GJC, Paterson DM (2003) The importance of extracellular carbohydrate production by marine epipelagic diatoms. *Adv Bot Res* 40:183–240.
- Underwood GJC, Boulcott M, Raines CA, Waldron K (2004) Environmental effects on exopolymer production by marine benthic diatoms: dynamics, changes in composition, and pathways of production. *J Phycol* 61:293–304. doi: 10.1111/j.1529-8817.2004.03076.x
- Vafeiadou A-M, Chintiroglou CC, Moens T (2018) Effects of an increased temperature regime on the population dynamics and species interactions of marine nematodes. *J Exp Mar Bio Ecol* 502:142–152. doi: 10.1016/j.jembe.2017.02.008
- Vafeiadou AM, Materatski P, Adão H, de Troch M, Moens T (2014) Resource utilization and trophic position of nematodes and harpacticoid copepods in and adjacent to *Zostera noltii* beds. *Biogeosciences* 11:4001–4014. doi: 10.5194/bg-11-4001-2014
- Valentine JF, Duffy JE (2006) The central role of grazing in seagrass ecology. In: Larkum AWD, Orth RJ, Duarte CM (eds) *Seagrasses: Biology, Ecology and Conservation*. Springer, Dordrecht, Netherlands, pp 463–501
- Valentine JF, Heck KL (1999) Seagrass herbivory: Evidence for the continued grazing of marine grasses. *Mar Ecol Prog Ser* 176:291–302. doi: 10.3354/meps176291
- Valle M, Chust G, del Campo A, Wisz MS, Olsen SM, Garmendia JM, Borja T (2014) Projecting future distribution of the seagrass *Zostera noltii* under global warming and sea level rise. *Biol Conserv* 170:74–85. doi:

- 10.1016/j.biocon.2013.12.017
- van de Koppel J, Herman PMJ, Thoolen P, Heip CHR (2001) Do alternate stable states occur in natural ecosystems? Evidence from a tidal flat. *Ecology* 82:3449–3461.
- van der Heijden LH, Rzeznik-Orignac J, Asmus R, Fichet D, Bréret M, Kadel P, Beaugeard L, Asmus H, Lebreton B (2018) How do food sources drive meiofauna community structure in soft-bottom coastal food webs? *Mar Biol*. doi: 10.1007/s00227-018-3419-7
- van der Meersche K, Soetaert K, van Oevelen D (2009) xsample (): An R function for sampling linear inverse problems. *J Stat Softw* 30:1–15. doi: 10.1002/wics.10
- van Gaever S, Moodley L, Pasotti F, Houtekamer M, Middelburg JJ, Danovaro R, Vanreusel A (2009) Trophic specialisation of metazoan meiofauna at the Håkon Mosby Mud Volcano: Fatty acid biomarker isotope evidence. *Mar Biol* 156:1289–1296. doi: 10.1007/s00227-009-1170-9
- van Oevelen D, Soetaert K, Middelburg JJ, Herman PMJ, Moodley L, Hamels I, Moens T, Heip CHR (2006) Carbon flows through a benthic food web: Integrating biomass, isotope and tracer data. *J Mar Res* 64:453–482. doi: 10.1357/002224006778189581
- van Oevelen D, van den Meersche K, Meysman FJR, Soetaert K, Middelburg JJ, Vézina AF (2009) Quantifying food web flows using linear inverse models. *Ecosystems* 13:32–45. doi: 10.1007/s10021-009-9297-6
- Vanaverbeke J, Soetaert K, Vincx M (2004) Changes in morphometric characteristics of nematode communities during a spring phytoplankton bloom deposition. *Mar Ecol Prog Ser* 273:139–146. doi: 10.3354/meps273139
- vander Zanden MJ, Rasmussen JB (2001) Variation in $\delta^{13}\text{C}$ and $\delta^{15}\text{N}$ trophic fractionation: Implications for aquatic food web studies. *Limnol Oceanogr* 46:2061–2066. doi: 10.4319/lo.2001.46.8.2061
- Vasconcellos M, Mackinson S, Sloman K, Pauly D (1997) The stability of trophic mass-balanced models of marine ecosystems: a comparative analysis. *Ecol Modell* 100:125–134. doi: 10.1016/S0304-3800(97)00150-6
- Vézina AF, Platt T (1988) Food web dynamics in the ocean. I. Best-estimates of flow networks using inverse methods. *Mar Ecol Prog Ser* 42:269–287. doi: 10.3354/meps042269
- Virgo N, Law R, Emmerson M (2006) Sequentially assembled food webs and extremum principles in ecosystem ecology. *J Anim Ecol* 75:377–386. doi: 10.1111/j.1365-2656.2006.01058.x
- Viso AC, Pesando D, Bernard P, Marty JC (1993) Lipid components of the Mediterranean seagrass *Posidonia oceanica*. *Phytochemistry* 34:381–387. doi: 10.1016/0031-9422(93)80012-H
- Vizzini S, Mazzola A (2003) Seasonal variations in the stable carbon and nitrogen isotope ratios ($^{13}\text{C}/^{12}\text{C}$ and $^{15}\text{N}/^{14}\text{N}$) of primary producers and consumers in a western Mediterranean coastal lagoon. *Mar Biol* 142:1009–1018. doi: 10.1007/s00227-003-1027-6
- Vizzini S, Sarà G, Michener RH, Mazzola A (2002) The role and contribution of the seagrass *Posidonia oceanica* (L.) Delile organic matter for secondary consumers as revealed by carbon and nitrogen stable isotope analysis. *Acta Oecologica* 23:277–285. doi: 10.1016/S1146-609X(02)01156-6
- Volkman JK, Johns RB, Gillan FT, Perry GJ (1980) Microbial lipids of an intertidal sediment - I. Fatty acids and hydrocarbons. *Geochim Cosmochim Acta* 44:1133–1143.
- Volkman JK, Jeffrey SW, Nichols PD, Rogers GI, Garland CD (1989) Fatty acid and lipid composition of 10 species of microalgae used in mariculture. *J Exp Mar Bio Ecol* 128:219–240. doi: 10.1016/0022-0981(89)90029-4
- Vranken G, Heip CHR (1986) The productivity of marine nematodes. *Ophelia* 26:429–442.
- Warwick RM (1971) Nematode associations in the Exe Estuary. *J Mar Biol Assoc United Kingdom* 51:439–454. doi: 10.1017/S0025315400031908
- Warwick RM, Price R (1979) Ecological and metabolic studies on free-living nematodes from an estuarine mud-flat.

- Estuar Coast Mar Sci 9:257–271. doi: 10.1016/0302-3524(79)90039-2
- Warwick RM, Joint IR, Radford PJ (1979) Secondary production of the benthos in an estuarine environment. In: Jefferies RL, Davy AJ (eds) *Ecological Processes in Coastal Environments*. Blackwell Scientific, Oxford, U.K., pp 429–450
- Warwick RM, Platt HM, Somerfield PJ (1998) Freelifving marine nematodes: Part III. Monhysterida. *Synopses of the British Fauna (new) No. 53*. Field Studies Council, Shrewsbury, U.K.
- Waycott M, Duarte CM, Carruthers TJB, Orth RJ, Dennison WC, Olyarnik S, Calladine A, Fourqurean JW, Heck KL, Hughes AR, Kendrick GA, Kenworthy WJ, Short FT, Williams SL (2009) Accelerating loss of seagrasses across the globe threatens coastal ecosystems. *Proc Natl Acad Sci* 106:12377–12381. doi: 10.1073/pnas.0905620106
- Wentworth CK (1922) A scale of grade and class terms for clastic sediments. *J Geol* 30:377–392. doi: 10.1086/622910
- Wetzel MA, Fleeger JW, Powers SP (2001) Effects of hypoxia and anoxia on meiofauna: A review with new data from the Gulf of Mexico. In: Rabalais NN, Turner RE (eds) *Coastal Hypoxia: Consequences for Living Resources and Ecosystems*. American Geophysical Union, Washington, DC, USA, pp 165–184
- Widdows J, Pope ND, Brinsley MD, Asmus H, Asmus RM (2008) Effects of seagrass beds (*Zostera noltii* and *Z. marina*) on near-bed hydrodynamics and sediment resuspension. *Mar Ecol Prog Ser* 358:125–136. doi: 10.3354/meps07338
- Wieringa EBA, Overmann J, Cypionka H (2000) Detection of abundant sulphate-reducing bacteria in marine oxic sediment layers by a combined cultivation and molecular approach. *Environ Microbiol* 2:417–427. doi: 10.1046/j.1462-2920.2000.00123.x
- Wieser W (1953) Die Beziehungen zwischen Mundhohlengestalt, Ernährungsweise und Vorkommen bei freilebenden marinen Nematoden. *Ark Zool (Ser 2)* 4:439–484.
- Wieser W, Kanwisher J (1960) Growth and metabolism in a marine nematode, *Enoplus communis* Bastian. *Z Vgl Physiol* 43:29–36. doi: 10.1007/BF00351200
- Wieser W, Kanwisher J (1961) Ecological and physiological studies on marine nematodes from a small salt marsh near Woods Hole, Massachusetts. *Limnol Oceanogr* 6:262–270.
- Woodin SA, Jackson JBC (1979) Interphyletic competition among marine benthos. *Integr Comp Biol* 19:1029–1043. doi: 10.1093/icb/19.4.1029
- Woombs M, Laybourn-Parry J (1985) Energy partitioning in three species of nematode from polysaprobic environments. *Oecologia* 65:289–295.
- Wulff F, Field JG, Mann KH (1989) *Network analysis in marine ecology: methods and applications*. Springer-Verlag, New York, USA
- Yallop ML, de Winder B, Paterson DM, Stal LJ (1994) Comparative structure, primary production and biogenic stabilization of cohesive and non-cohesive marine sediments inhabited by microphytobenthos. *Estuar Coast Shelf Sci* 39:565–582. doi: 10.1016/S0272-7714(06)80010-7
- Zwarts L, Blomert AM (1992) Why knot *Calidris canutus* take medium-sized *Macoma balthica* when six prey species are available. *Mar Ecol Prog Ser* 83:113–128. doi: 10.3354/meps083113

Curriculum vitae

Name: Luuk Hendrikus van der Heijden
Date of Birth: 29.08.1988
Place of Birth: Hooge- en Lage Mierde, Netherlands
E-mail: luuk.van_der_heijden@univ-lr.fr

Academic education:

10/2015 – 09/2018 PhD thesis, Universit of La Rochelle, France and Alfred Wegener Institute
Helmholtz Center for Polar and Marine Research, Wadden Sea Station Sylt, Germany

Thesis: *Determination of the food sources and of the role of meiofauna in soft-bottom intertidal habitats of the Marennes-Oléron Bay, France, and the Sylt-Rømø Bight, Germany. Importance of the microphytobenthos-meiofauna pathway, highlighted by community structure, trophic markers and linear inverse food web models.*

02/2012 – 08/2014 M.Sc., Environmental Biology, Utrecht University, Netherlands
Track: Biomarine Science and Palaeoecology

09/2007 - 11/2011 B.Sc., Biology, Utrecht University, Netherlands
Track: Marine Biology

Expeditions:

02/2016 – 11/2016 Sampling for PhD thesis in Marennes-Oléron Bay, France
Focus: Feeding ecology of meiofauna in soft-bottom habitats

02/2016 – 12/2016 Sampling for PhD thesis in Sylt-Rømø Bight, Germany
Focus: Feeding ecology of meiofauna in soft-bottom habitats

Teaching experience:

10/2016 – 10/2018 Teaching position at the University of La Rochelle, France
Courses: “Animal Biology”, “Experimental biology of soft-bottom habitats”,
“Oceanography”

Workshops/courses:

09/2017 Ecological Network Analyses workshop
Alfred Wegener Institute, List auf Sylt, Germany

- 07/2016 Summer school in meiofauna, “A dive in a microscopic world”.
Institute Universitaire Européen de la Mer (IUEM), Brest, France
- 01/2016 Course in Stable Isotopes Mixing Models using SIAR, SIBER and MixSIAR (SIMM).
PR Statistics
Scottish Centre for Ecology and the Natural Environment, Loch Lomond, Scotland

Publications:

van der Heijden, L.H., Niquil, N., Asmus, R., Haraldsson, M., Saint-Béat, B., Pacella, S., Graeve, M., Rzeznik-Orignac, J., Asmus, H., Lebreton, B. *In preparation of submission*. Importance of microphytobenthos-meiofauna pathway in soft-bottom intertidal food webs leads to high production and transfer efficiency of meiofauna: A multi-habitat comparison using linear inverse food web modeling.

van der Heijden, L.H., Graeve, M., Asmus, R., Rzeznik-Orignac, J., Niquil, N., Bernier, Q., Guillou, G., Asmus, H., Lebreton, B. *Under review in Marine Environmental Research*. Trophic importance of microphytobenthos and bacteria to meiofauna in soft-bottom intertidal habitats: a combined trophic marker approach.

van der Heijden, L.H., Rzeznik-Orignac, J., Asmus, R., Fichet, D., Bréret, M., Kadel, P., Beauguard, L., Asmus, H., Lebreton, B., 2018. How do food sources drive meiofauna community structure in soft-bottom coastal food webs? *Marine Biology*, 165:166. doi:10.1007/s00227-018-3419-7

van der Heijden, L.H. and Kamenos, N.A., 2015. Reviews and Syntheses: Calculating the global contribution of coralline algae to total carbon burial, *Biogeosciences*, 12, 6429-6441, doi:10.5194/bgd-12-6429-2015, 2015.

Conference presentation:

van der Heijden, L.H., Lebreton, B., Asmus, H., Asmus, R., Rzeznik-Orignac, J., Graeve, M., Niquil, N., Bernier, Q., Fichet, D., Bréret, M., Kadel, P., Beauguard, L. How do food sources drive the meiofauna community structure in soft-bottom coastal ecosystems? 24th Biennial Coastal Estuarine Research Federation Conference, November 2017

Statement of originality

Statement

I, Luuk Hendrikus van der Heijden, declare that the research reported in this thesis is my original research. This thesis has been performed independently with support by my supervisors. It contains no material that has been accepted for the award of a degree in this or any other university. To the best of the candidate's knowledge and belief, this thesis contains no material previously published or written by another person except where due reference is made in the text. The thesis has been prepared subject to the Rules of Good Scientific Practice of the Germany Research Foundation.

Erklärung

Ich, Luuk Hendrikus van der Heijden, erkläre dass die in dieser Dissertation referierte Forschung meine eigene Forschung ist. Hiermit erkläre ich, dass ich die vorliegende Arbeit selbständig und ohne fremde Hilfe angefertigt und keine anderen als die angegebenen Quellen und Hilfsmittel verwendet habe. Die eingereichte schriftliche Fassung der Arbeit entspricht der auf dem elektronischen Speichermedium. Weiterhin versichere ich, dass diese Arbeit noch nicht als Abschlussarbeit an anderer Stelle vorgelegen hat. Diese Dissertation wurde nach den „Rules of Good Scientific Practice of the Germany Research Foundation“ erstellt.

Date/Datum: 17/10/2018

Place/Ort: La Rochelle, France

Signature/Unterschrift:

Contribution by author

I hereby certify that the information provided and the contribution to the publications in this dissertation corresponds to the truth. I refer to the following publications and manuscripts:

How do food sources drive meiofauna community structure in soft-bottom coastal food webs?

L.H. van der Heijden^{1,2}, J. Rzeznik-Orignac³, R. Asmus², D. Fichet¹, M. Bréret¹, P. Kadel², L. Beauguard¹, H. Asmus², B. Lebreton¹

¹UMR 7266 Littoral, Environnement et Sociétés (CNRS - University of La Rochelle), Institut du littoral et de l'environnement, 2 rue Olympe de Gouges, 17000 La Rochelle, France

²Alfred-Wegener-Institut Helmholtz-Zentrum für Polar- und Meeresforschung, Wattenmeerstation Sylt, Hafenstrasse 43, 25992 List/Sylt, Germany

³Sorbonne Universités, UPMC Univ Paris 06, CNRS, Laboratoire d'Ecogéochimie des Environnements Benthiques (LECOB UMR 8222), Observatoire Océanologique, 66650 Banyuls/mer, France

Contribution: 85%

Trophic importance of microphytobenthos and bacteria to meiofauna in soft-bottom intertidal habitats: a combined trophic marker approach.

L.H. van der Heijden^{1,2}, M. Graeve³, R.M. Asmus², J. Rzeznik-Orignac⁴, N. Niquil⁵, Q. Bernier¹, G. Guillou¹, H. Asmus², B. Lebreton¹

¹LIENSs, UMR 7266 University of La Rochelle, CNRS, 2 rue Olympe de Gouges, 17000 La Rochelle, France

²Alfred Wegener Institute Helmholtz Centre for Polar- and Marine Research, Wattenmeerstation Sylt, 25992 List, Sylt, Germany

³Alfred Wegener Institut Helmholtz Centre for Polar- and Marine Research, Bremerhaven, Germany

⁴Laboratoire d'Ecogéochimie des Environnements Benthiques, LECOBI, Sorbonne Université, CNRS, Banyuls-sur-Mer, France

⁵Unité Biologie des Organismes et Ecosystèmes Aquatiques (BOREA), MNHN, CNRS, IRD, Sorbonne Université, Université de Caen Normandie, Université des Antilles, CS 14032, 14000 CAEN, France

Contribution: 90%

Importance of microphytobenthos-meiofauna pathway in soft-bottom intertidal food webs leads to high production and transfer efficiency of meiofauna: A multi-habitat comparison using linear inverse food web modeling.

L.H. van der Heijden^{1,2,*}, N. Niquil³, R. Asmus², M. Haraldsson^{3,4}, B. Saint-Béat⁵, S. Pacella⁶, M. Graeve⁷, J. Rzeznik-Orignac⁸, H. Asmus², B. Lebreton¹

¹UMR 7266 Littoral, Environnement et Sociétés (CNRS - University of La Rochelle), Institut du littoral et de l'environnement, 2 rue Olympe de Gouges, 17000 La Rochelle, France

²Alfred-Wegener-Institut Helmholtz-Zentrum für Polar- und Meeresforschung, Wattenmeerstation Sylt, Hafenstrasse 43, 25992 List/Sylt, Germany

³Centre National de la Recherche Scientifique (CNRS)/University of Caen Normandy, BOREA, Caen, France

⁴Sorbonne Université, Université Paris Est Créteil, Université Paris Diderot, CNRS, INRA, IRD, Institute of Ecology and Environmental sciences - Paris, IEES-Paris, 75005 Paris, France

⁵Québec-Océan and Takuvik, Département de Biologie, Université Laval, Québec City, QC, Canada

⁶College of Earth, Ocean, and Atmospheric Sciences, Oregon State University, 104 Wilkinson Hall, Corvallis, OR 97331, USA

⁷Alfred Wegener Institut Helmholtz Centre for Polar- and Marine Research, Bremerhaven, Germany

⁸Unité Biologie des Organismes et Ecosystèmes Aquatiques (BOREA), MNHN, CNRS, IRD, Sorbonne Université, Université de Caen Normandie, Université des Antilles, CS 14032, 14000 CAEN, France

Contribution: 80%

Determination of the food sources and of the role of meiofauna in soft-bottom intertidal habitats of the Marennes-Oléron Bay, France, and the Sylt-Rømø Bight, Germany.

Importance of the microphytobenthos-meiofauna pathway, highlighted by community structure, trophic markers and linear inverse food web models.

Meiofauna play an important role in ecosystem processes in soft-bottom benthic habitats, e.g. food web dynamics, related to their high production, their intermediate trophic position and the energy they transfer towards higher trophic levels. The trophic linkages and flows of organic matter related to the meiofauna remain poorly known or taken into account. To better assess the role of meiofauna, the community structure and trophic relationships between food sources and meiofauna were determined in five intertidal soft-bottom habitats (i.e., mudflat, seagrass bed, sandflat) of the Marennes-Oléron Bay, France, and the Sylt-Rømø Bight, Germany, taking temporal variations into account.

Meiofauna communities were dominated by nematodes and benthic copepods. Biomass of microphytobenthos and of sediment organic matter were two of the major drivers of community structure. The combination of trophic markers (i.e., stable isotopes, fatty acids) demonstrated that microphytobenthos and bacteria were the major food sources of meiofauna in the five habitats. Information from community structure assessments and trophic marker analyses were implemented in food web models. In all habitats, these models demonstrated that the main flow of carbon to meiofauna originated from microphytobenthos, highlighting negligible changes in meiofauna feeding behavior besides the large differences in availability and productivity of food sources between these habitats. All trophic groups of nematodes, except for selective deposit feeding nematodes, were highly selective and mainly fed on microphytobenthos, resulting in a high production and a short turn-over time of meiofauna. In conclusion, this thesis demonstrated the important role of meiofauna in soft-bottom habitats as well as the importance of the trophic pathway from microphytobenthos to meiofauna in the functioning of these food webs.

Keywords: free-living marine nematodes, benthic copepods, microphytobenthos, community structure, stable isotopes, fatty acids, compound-specific isotope analyses, ecological food web model, seagrass beds, mudflats, sandflats

Détermination des sources trophiques et du rôle de la méiofaune dans les habitats intertidaux à substrat meuble de la baie de Marennes-Oléron, France, et de la baie de Sylt-Rømø, Allemagne.

Mise en évidence de l'importance de la voie trophique microphytobenthos-méiofaune par détermination de la structure des communautés, l'utilisation des traceurs de la matière et les modèles de réseaux trophiques basés sur l'analyse inverse.

La méiofaune joue un rôle important dans le fonctionnement des habitats benthiques à substrat meuble (ex. flux de matière) en relation avec sa production élevée, sa position trophique intermédiaire et les importants transferts d'énergie vers les niveaux trophiques supérieurs qui y sont liés. Les relations trophiques et les flux de matière organique liés à la méiofaune restent néanmoins mal connus ou peu pris en compte. Afin de mieux appréhender le rôle de la méiofaune, la structure des communautés et les relations trophiques entre les sources de nourriture et ces consommateurs ont été déterminées dans cinq habitats à substrat meuble (i.e., vasière nue, herbier, zone à sables) de la baie de Marennes-Oléron, France, et de la baie de Sylt-Rømø, Allemagne, en tenant compte des variations temporelles.

Le peuplement de méiofaune s'est trouvé être dominé par les nématodes et les copépodes benthiques. Les biomasses de microphytobenthos et de matière organique du sédiment sont apparues comme étant deux facteurs structurants pour les communautés. L'utilisation combinée de différents traceurs de la matière (i.e., isotopes stables, acides gras) a démontré que le microphytobenthos et les bactéries étaient les ressources trophiques majeures de la méiofaune dans les cinq habitats étudiés. Les mesures réalisées sur la structure des communautés et les données issues des traceurs de la matière ont été implémentées dans des modèles de réseaux trophiques. Dans tous les habitats, ces modèles ont mis en évidence que le flux de carbone dominant était issu du microphytobenthos, ceci démontrant les très faibles changements de comportements alimentaires malgré les importantes différences de sources trophiques en termes de disponibilité et de production des sources de nourriture entre ces différents habitats. Tous les groupes trophiques de nématodes, à l'exception des dépositivores sélectifs, étaient particulièrement sélectifs et s'alimentaient majoritairement à partir de microphytobenthos, ceci étant à l'origine d'une forte production et d'un court temps de renouvellement de la méiofaune. En conclusion, cette thèse démontre le rôle important de la méiofaune dans les habitats à substrat meuble ainsi que l'importance de la relation trophique entre le microphytobenthos et la méiofaune dans le fonctionnement de ces réseaux trophiques.

Mots clés: nématodes marins libres, copépodes benthiques, microphytobenthos, structure de communautés, isotopes stables, acides gras, analyses isotopiques de composés spécifiques, modèle de réseau trophique, herbiers, vasières, zones à sables.

Rolle der Meiofauna und ihre Nahrungsquellen in intertidalen Habitaten der Marennes-Oléron Bucht, Frankreich, und der Sylt-Rømø Bucht, Deutschland.

Bedeutung der Mikrophytobenthos-Meiofauna-Nahrungskette, dargestellt am Beispiel der Gemeinschaftsstruktur, der trophischen Marker und linearer inverser Nahrungsnetzmodelle.

Meiofauna spielt für ökosystemare Prozesse, wie der Dynamik des Nahrungsnetzes, in Weichboden-Habitaten eine wichtige Rolle durch eine hohe Produktion, eine mittlere trophische Position, und den Energie-Transfer zu höheren trophischen Niveaus. Die trophischen Verknüpfungen mit der Meiofauna und die damit verbundenen Flüsse des organischen Materials sind nur ungenügend bekannt oder berücksichtigt. Um die Rolle der Meiofauna besser abschätzen zu können, wurden die Gemeinschaftsstruktur und die trophischen Verhältnisse zwischen der Meiofauna und ihren Nahrungsquellen in fünf Habitaten des Gezeitenbereichs (i.e., Schlickwatten, Seegraswiesen und Sandwatten) der Marennes-Oléron Bucht, Frankreich, und der Sylt-Rømø Bucht, Deutschland, untersucht unter Berücksichtigung zeitlicher Veränderungen.

Nematoden und benthische Copepoden stellten die Hauptgruppen der untersuchten Meiofauna-Gemeinschaften dar. Die Biomasse des Mikrophytobenthos und das organische Material des Sedimentes waren zwei der Hauptfaktoren, die die Struktur der Gemeinschaft beeinflussten. Die Kombination der trophischen Marker (i.e., stabile C und N-Isotopen, Fettsäuren) bestätigte, dass Mikrophytobenthos und Bakterien die Hauptnahrungsquellen in den fünf untersuchten Habitaten darstellten. Die Information aus Abschätzungen der Gemeinschaftsstruktur und den Analysen der trophischen Marker wurde zur Konstruktion von Nahrungsnetzmodellen angewandt. Diese Modelle zeigen für alle Habitate, dass der Hauptkohlenstofffluss zur Meiofauna aus dem Mikrophytobenthos stammt, und unterstreichen, dass Unterschiede im Fressverhalten der Meiofauna zwischen den Lebensräumen vernachlässigbar gering sind im Vergleich zu den großen Unterschieden, die dort in der Verfügbarkeit und Produktivität der Nahrungsquelle herrschen. Alle trophischen Gruppen der Nematoden ausser den Depositfressern waren selektiv in der Nahrungswahl und ernährten sich hauptsächlich von Mikrophytobenthos, wodurch eine hohe Produktion und ein rascher Turnover der Meiofauna ermöglicht wurden. In der vorgelegten Dissertation wird daher gezeigt, dass die Meiofauna eine wichtige Rolle für die Funktion der untersuchten Nahrungsnetze spielt insbesondere durch die trophische Interaktion zwischen Mikrophytobenthos und Meiofauna.

Schlüsselwörter: Frei-lebende marine Nematoden, benthische Copepoden, Mikrophytobenthos, Gemeinschaftsstruktur, Stabile Isotopen, Fettsäuren, Komponenten-spezifische Isotopenanalyse, Ökologisches Nahrungsnetzmodell, Seegraswiesen, Schlickwatten, Sandwatten