

© 2017 IEEE. Personal use of this material is permitted. Permission from IEEE must be obtained for all other uses, in any current or future media, including reprinting/republishing this material for advertising or promotional purposes, creating new collective works, for resale or redistribution to servers or lists, or reuse of any copyrighted component of this work in other works.

Digital Object Identifier (DOI): 10.1109/ISIE.2017.8001531

26th International Symposium on Industrial Electronics

A quadruple active bridge electrical power distribution system for the more electric aircraft

Giampaolo Buticchi

Levy Ferreira Costa

Marco Liserre

Suggested Citation

G. Buticchi, L. Costa and M. Liserre, "A quadruple active bridge electrical power distribution system for the more electric aircraft," 2017 IEEE 26th International Symposium on Industrial Electronics (ISIE), Edinburgh, 2017, pp. 1851-1855. doi: 10.1109/ISIE.2017.8001531

A Quadruple Active Bridge Electrical Power Distribution System for the More Electric Aircraft

Giampaolo Buticchi, Levy Costa and Marco Liserre
Chair of Power Electronics
University of Kiel, Germany
Email: gibu@tf.uni-kiel.de, lfc@tf.uni-kiel.de, ml@tf.uni-kiel.de

Abstract—New concepts for the More Electric Aircrafts are pushing towards a DC distribution system for the on-board electrical appliances. In the scenario where multiple high-voltage and low-voltage buses are present, a power electronics converter interface is mandatory. In this paper, a 4-port power converter with galvanic isolation and de-centralized control is proposed. The variable virtual resistor control allows to shift the load priority on demand. Simulations and experiments are reported, showing the feasibility and the flexibility of the solution.

I. INTRODUCTION

Aircraft transportation is the enabler of the modern society's globalization and the backbone of mail and goods transportation. Eurostat [1] statistics show that the interest and the number of passengers is steadily growing year after year (4.4% from 2013 to 2014), and air freight and mail showed a 6.4% and 3.3% increase, respectively. In this framework, the reliability and the efficiency of the aircrafts is of paramount importance.

In a conventional aircraft, the fuel is burned to produce the propulsive power and a part of it powers the on-board systems. Gearboxes power a central hydraulic pump, that is used for the actuation system. Hydraulic actuators have the unmistakable advantage of a high power density simple control. However, the infrastructure is composed of pipes, is very bulky and represents a reliability issue, since a leakage impairs the hydraulic actuation and releases at the same time corrosive fluids. Unplanned maintenance due to a fault in the hydraulic system grounds the aircraft [2].

In order to reduce the weight, and consequently the fuel consumption, and increase the reliability, the idea to use more electric power on aircraft was proposed (More Electric Aircraft, MEA [3]). Indeed, the idea to eliminate the hydraulic systems from aircraft dates back to 30 years ago, but only recently the advancement of the technology in conjunction with the investments for the new aircrafts brought this topic in the spotlight.

The basic concept is that hydraulic actuators can be replaced by electromechanical actuators, thus eliminating the hydraulic distribution system. In order to power these actuators, the electric power must be generated and then distributed. A possibility is to have an electric machine connected to the turbine of the engine, so that a variable frequency three-phase system can be distributed [4]. A power converter performs the AC/AC conversion needed for the electric machine driving.

While this solution allows to remove the hydraulic power from the picture, the share of the electric power on the aircraft is greatly increased, making the electric power distribution system (EPDS) design a challenging task. Moreover, the tendency to increase the electrical subsystems (entertainment, auxiliary systems) even in actual aircrafts contributes to make the power consumption even greater.

High efficiency and high reliability are still the main design goals for aerospace applications. In this framework, solutions based on the variable frequency AC transmission or on monolithic DC/DC converters have been proposed, however they present limitations regarding the distribution and the overall efficiency. For these reasons, the newer standard, like MIL-STD-704F, has agreed on a multi-bus transmission system (Figure 1), where a high voltage bus at 270V is used to transmit the power, and a low-voltage 28V distribution feeds the loads. Galvanic isolation for security purpose is mandatory in each interface stage between different buses.

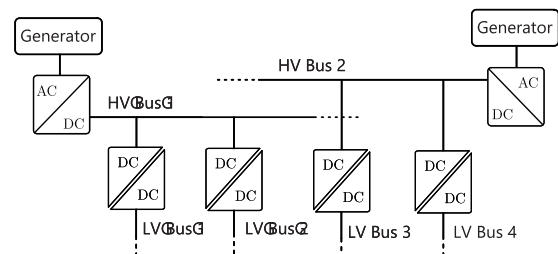

Fig. 1. Multi-bus architecture of More Electric Aircraft grid.

Considering the stringent requirements for reliability, multiple HV and LV buses are envisaged, basically creating a multi-bus DC micro-grid on the aircraft for the EPDS, that has to be resilient and highly efficient. In this framework, the optimal power flow management is missing, the actuator will operate in bi-directional mode, in order to recover the energy during braking, this calls for optimization strategies.

The open problems make the realization of the electric system a very difficult challenge, whose solution would allow developing new aircrafts, more intelligent, more efficient and more economic, with reduced unplanned maintenance. At the moment the events of unplanned maintainability are handled in a statistical way (some studies estimate up to 50% of unplanned maintenance over the total amount of maintenance

events), and an overhead of aircraft and man-hour for the repairs is scheduled from each operator, increasing the total costs.

This paper describes the possibility to realize the aircraft EPDS with a DC distribution system with quadruple-active bridges as interface converter. The possibility to route the power between the different HV and LV buses is an interesting feature to achieve smart-grid operation. A de-centralized control is proposed, and its ability to operate properly in case of multiple bus disconnection and of changing load priority is demonstrated with simulations. Section II describes the state of isolated DC/DC converters

II. STATE OF THE ART OF ISOLATED DC/DC CONVERTERS

In applications where isolation between the input and output voltage is required, with reduced losses and high power density, the isolated high frequency (HF) DC/DC converters are the best choice. Regardless the topology, the isolated converter is composed of a high frequency bridge, used to generate an HF AC waveform, a transformer and a rectifier (unidirectional or bidirectional), used to convert the AC voltage on the transformer's secondary side into a DC voltage. Usually, all topologies of the HF isolated DC/DC converter have the high power density characteristics, since they operate at high frequency.

The first high frequency DC/DC converter employed in isolated application was the Full-Bridge DC/DC converter (FBC), shown in Figure 2. Although it was previously used in its unidirectional version (with diode bridge rectifier on the secondary side), the bidirectional version is also possible [5]. The converter was initially proposed with pulse-width-modulation (PWM) and duty-cycle control, with the advantage of simple and effective control of the output voltage. Nevertheless, the hard-switching operation of the FBC has a great impact on the efficiency of the converter. To avoid the switching losses and improve the efficiency, a phase-shift modulation of the FBC converter has been used, in order to achieve zero voltage during the semiconductors commutation (ZVS) of the primary side bridge [6]. This converter is known in literature as Zero-Voltage-Switching Phase-Shift Full-Bridge converter (ZVS-PS-FB). As main disadvantages can be cited: the requirement of large filters, which contribute to the reduction of the power density, hard-switching on the secondary side devices and circulating current during the off-time, impacting on the efficiency. To overcome the disadvantages of the FBC, resonant switching concepts were investigated. Among the resonant topologies, the series resonant converter introduced in [7] was presented as a remarkable topology. By adding a capacitor in series with the stray inductance of the transformer, as shown in Figure 3, a resonant tank is created and the current waveform on the transformer has a sinusoidal shape. The switches are commutated during the zero crossing of the current, presenting the feature of zero-current-switching (ZCS) in all semiconductors, which greatly contributes to the switching losses reduction. In addition, the sinusoidal waveform of the current has a relatively low root-mean-square (rms) value, contributing to the conduction losses reduction

on the semiconductors and also on the transformer. Therefore, high efficiency is expected from this topology.

During the 90s, the Dual-Active-Bridge (DAB) converter was proposed as a solution for high efficiency and high power density. The topology of the DAB converter is illustrated in Figure 4. Although different modulation strategies are possible, the phase-shift scheme is the most used one, due to its simplicity and effectiveness. With this modulation strategy, the primary and secondary side bridges operate with a fixed duty-cycle of half of the switching period, and the power flow is controlled by a displacement phase among the primary and the secondary side bridges. Besides that, the voltage over the semiconductors is zero during the commutation, featuring soft-switching operation on the semiconductors of both bridges of the converter. In addition, the current waveform on the stray inductance of the transformer has a quasi-square shape (see. Figure 4), leading to low rms values and consequently reduced conduction losses on the semiconductors and transformer. The main advantages of the DAB converter are: soft-switching operation, low energy storage requirements on the magnetics elements and simple control of the power flow and output voltage. On the other hand, the current ripple on the output capacitor of the converter is very high, requiring a bulky capacitance bank and impacting directly on the power density of the converter. If properly designed, the DAB converter offers both high efficiency and high power density. To summarize what was discussed, Figure 5 highlights the advantage and disadvantage of each converter presented.

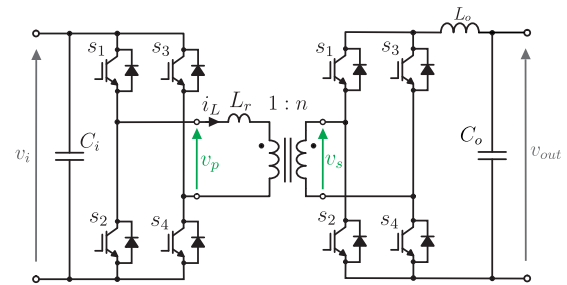

Fig. 2. Full-Bridge Converter (FBC).

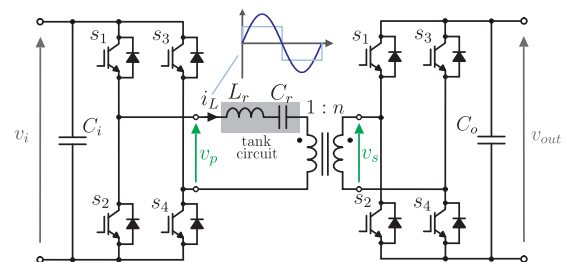

Fig. 3. Series Resonant Converter (SRC).

In applications like smart grid aerospace systems, where multiple loads and/or sources should be interconnected, multiple DC/DC converters are conventionally used. However, to avoid the use of several converters and the necessity of com-

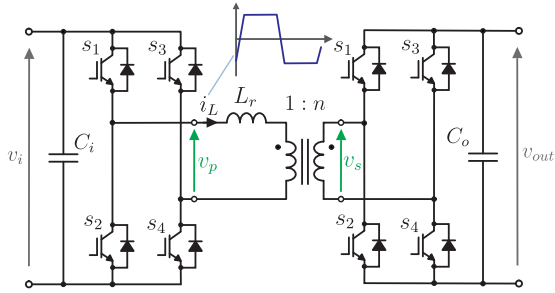

Fig. 4. Dual Active Bridge Converter (DAB).

FBC	SRC	DAB
+ ZVS operation	+ ZCS operation	+ ZVS operation
- High circulating current	+ Low conduction losses	+ Low conduction losses
- Bulky filter	- Difficult power flow	+ Simple power flow control
		- Bulky output capacitor

Fig. 5. Comparison Table.

munication and synchronization among them, a centralized solution based on multi-port converter could be adopted. This would allow for a simpler control and the ability to exchange power among all ports. Figure 6 shows a generalized block diagram of a multi-port converter and the possible sources and loads usually connected to these ports. In particular, a multiple port converter based on multiple active bridges was proposed in 2007 in [8], [9] as a solution to interface a fuel cell generator, a battery storage system and passive loads. In [10] the TAB was extended to the aerospace EPDS to interface multiple HV buses.

This converter is an extension of the Dual-Active-Bridge converter and it has three active bridges connected to the same high frequency multi-winding transformer. Because of its characteristics to have three active bridges, it was named as Triple-Active-Bridge converter (TAB). Similarly, an extended version with four active bridges, called Quad-Active-Bridge (QAB) and depicted in Figure 7, was proposed in [11] to integrate distributed generation system and storage system to a solid-state transformer.

These solutions have the same characteristics and advantages of the DAB converter, with the additional advantage to integrate several power sources or loads with the minimum DC/DC conversion stages, implying a higher power density. Besides that, the power flow on the converter is easily controlled by using the phase-shift angle among the active bridges. For these reasons, the multiple-active-bridge converter is a good choice to be used as a power manager device.

III. PROPOSED ARCHITECTURE AND CONTROL

The working hypothesis is to have a HV bus at 270 V for each generator, so that a minimum of two HV buses are

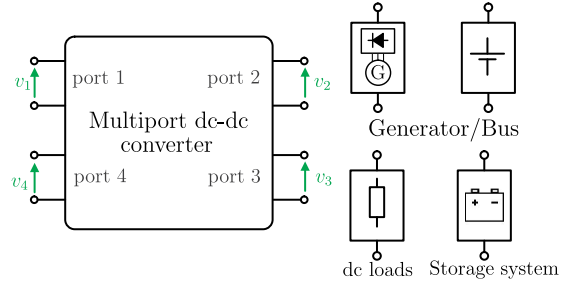

Fig. 6. Block diagram of a multiport converter with the typically sources connected to the ports.

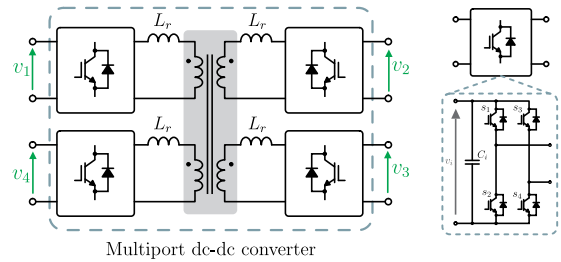

Fig. 7. Topology of the Quad-Active-Bridge (QAB) converter.

present. In the LV side, two buses are present, one with the critical equipment and the other with loads that can be shed upon demand. Figure 8 shows the QAB architecture.

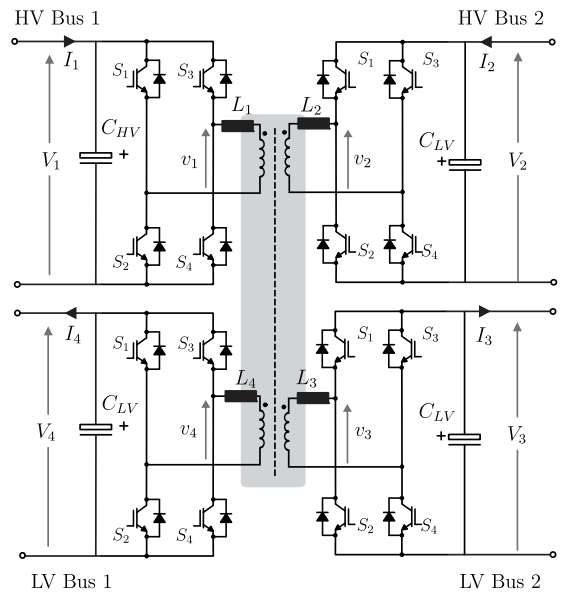

Fig. 8. Quadruple Active Bridge connected to the HV and LV bus.

The adopted control is the phase-shift control, that implies that each full-bridge is driven with a 50% duty cycle and the shifting between the voltage square waves determines the power transfer.

The control priority is to control the LV bus 2 (V_3) at the reference voltage ($V_{LV}^* = 28V$). In order to do this, it is initially assumed that the bridges 1 and 2 transferring power

to LV bus 1. A Proportional-Integral regulator selects the phase shift d_3 between bridge 3 and bridges 1 and 2. The same can be said for d_4 . Considering the power transfer equation, the current that is actually being regulated at the DC output of LV bus 1 is:

$$I_3 = n \frac{V_1 + V_2}{L_{lk} f_{sw}} d_3 (1 - 2d_3) \quad (1)$$

where $n = \frac{270V}{28V}$ is the voltage transfer ratio, f_{sw} is the switching frequency and $L_{lk} = 4L_1 = 4L_2 = 4n^2L_3 = 4n^2L_4$ is the equivalent inductance seen at the HV side.

In order to distribute the load priorities, virtual resistors are used. A PI regulator allows to shift the loads priority by unbalancing d_3 and d_4 . The same can be said for the HV bridges, where an additional control allows to regulate the power transfer between bridges 1 and 2, affecting d_2 . The control structure is shown in Figure 9.

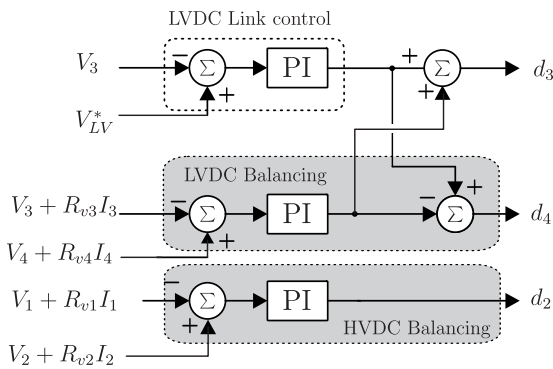

Fig. 9. Control of the Quad-Active-Bridge (QAB) converter.

IV. RESULTS

The proposed virtual-resistor concept was tested in simulations and in a laboratory prototype. The simulations are focused on the system level and show the operation in different scenarios, while the hardware realization presents the high-frequency behavior of the QAB and proves the power sharing capabilities. Both configurations reflect the one shown in Figure 8.

For the simulations the HV buses are emulated by voltage sources $V_1 = V_2 = 270V$, $L_1 = L_2 = 20\mu H$, $f_{sw} = 20kHz$, a the LV buses are regulated at $V_{LV}^* = 28V$, and connected to a equal loads $R_3 = R_4 = 0.3\Omega$. In order to show the flexibility of the control, a series of scenarios are reported in Figure 10, where the HV and LV voltage and current waveform, as well as the duty cycle and the virtual resistors.

- At the beginning, the system is operating in symmetrical conditions, where each LV bus is supplying the same amount of power.
- At $t = 0.15$ s, a virtual resistor change in the HV side unbalances the processed power, while no effect on the LV side is shown. This may be caused by different available power from the two generators.

- At $t = 0.2$ s the virtual resistor of port 4 is increased, effectively reducing the current at that port.
- At $t = 0.25$ s the HV bus 2 is disconnected, as example due to a fault of the generator. The current I_2 goes to zero, and more current is requested from generator 1. The voltage at HV bus 2 has only minimal change and is well regulated. It would also be possible to feed back HV bus 2, as an example to feed HV loads or re-start the generator in case of need.
- at $t = 0.3$ s the LV bus 2 (port 3) is disconnected, and the voltage at LV bus 2 (V_3) is well regulated.

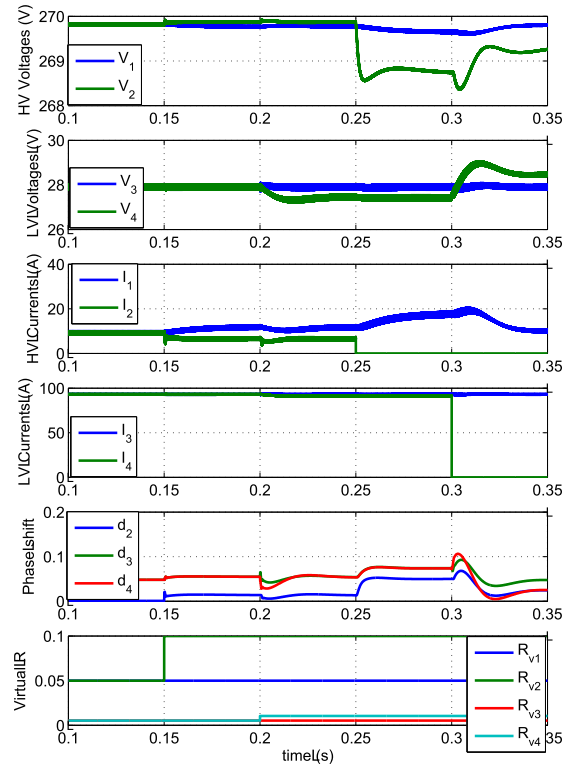

Fig. 10. Simulation results. Balanced operation at $t = 0.1$, imbalance in the HV side at $t = 0.15$ s, imbalance in the LV side at $t = 0.2$ s, disconnection of HV bus at $t = 0.25$ s, disconnection of LV bus at $t = 0.3$ s.

A symmetrical QAB prototype ($n = 1$) was used for preliminary testing to proof the virtual resistor concept. Differently from the simulations, the voltage is reduced $V_1 = V_2 = 200V$, and the switching frequency is increased $f_{sw} = 40kHz$. Figure 11 shows a picture of the laboratory prototype.

The high-frequency waveforms at port 1 and 2 are shown in Figure 12 and Figure 13 for the balanced and unbalanced case. As can be seen, the virtual resistor allows to change the power processed by each port.

V. CONCLUSION

A Quadruple-Active-Bridge (QAB) is proposed to interface HV and LV DC buses in an aircraft EPDS. Virtual resistor-

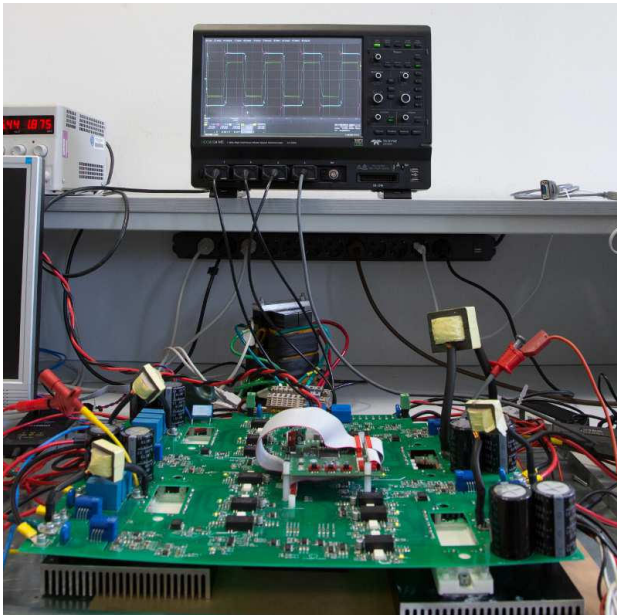

Fig. 11. Picture of the QAB prototype.

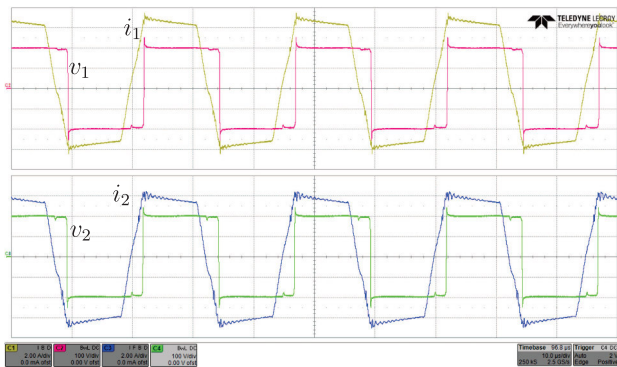

Fig. 12. Primary current and voltage waveforms in the balanced case.

based decentralized control allows to regulate the power transfer depending on the load priority and power availability. Simulations showing different cases and bus disconnection proves the feasibility and the resiliency of the proposed solution. Experimental testing shows the feasibility of the virtual resistor concept.

VI. ACKNOWLEDGEMENT

This work was supported by the European Union/Interreg V-A - Germany-Denmark, under PE:Region Project.

REFERENCES

- [1] Eurostat. (2015) Air transport statistics.
- [2] J. A. Rosero, J. A. Ortega, E. Aldabas, and L. Romeral, "Moving towards a more electric aircraft," *IEEE Aerospace and Electronic Systems Magazine*, vol. 22, no. 3, pp. 3–9, March 2007.
- [3] P. W. Wheeler, J. C. Clare, A. Trentin, and S. Bozhko, "An overview of the more electrical aircraft," *Proceedings of the Institution of Mechanical Engineers, Part G: Journal of Aerospace Engineering*, vol. 227, no. 4, pp. 578–585, 2013.

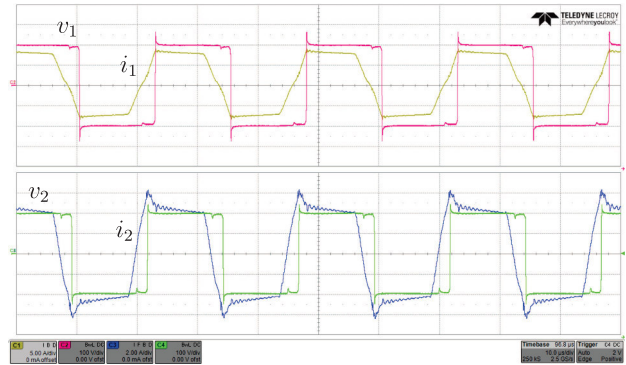

Fig. 13. Primary current and voltage waveforms in the unbalanced case.

- [4] J. Chang, C. LeMond, and A. Wang, "Distributed system and methodology of electrical power regulation, conditioning and distribution on an aircraft," Aug. 17 2004, uS Patent 6,778,414.
- [5] Y. Miura, M. Kaga, Y. Horita, and T. Ise, "Bidirectional isolated dual full-bridge dc-dc converter with active clamp for edlc," in *2010 IEEE Energy Conversion Congress and Exposition*, Sept 2010, pp. 1136–1143.
- [6] R. Steigerwald and K. Ngo, "Full-bridge lossless switching converter," Sept. 5 1989, uS Patent 4,864,479.
- [7] F. C. Schwarz, "A method of resonant current pulse modulation for power converters," *IEEE Transactions on Industrial Electronics and Control Instrumentation*, vol. IECI-17, no. 3, pp. 209–221, May 1970.
- [8] H. Tao, A. Kotsopoulos, J. L. Duarte, and M. A. M. Hendrix, "Family of multiport bidirectional dc-dc converters," *IEE Proceedings - Electric Power Applications*, vol. 153, no. 3, pp. 451–458, May 2006.
- [9] J. L. Duarte, M. Hendrix, and M. G. Simoes, "Three-port bidirectional converter for hybrid fuel cell systems," *IEEE Transactions on Power Electronics*, vol. 22, no. 2, pp. 480–487, March 2007.
- [10] B. Karanayil, M. Ciobotaru, and V. G. Agelidis, "Power flow management of isolated multiport converter for more electric aircraft," *IEEE Transactions on Power Electronics*, vol. 32, no. 7, pp. 5850–5861, July 2017.
- [11] S. Falcones, R. Ayyanar, and X. Mao, "A dc-dc multiport-converter-based solid-state transformer integrating distributed generation and storage," *IEEE Transactions on Power Electronics*, vol. 28, no. 5, pp. 2192–2203, May 2013.