

Plant invasions in high-UV-B environments – Patterns, mechanisms and projections in the context of Global Change

Dissertation

zur Erlangung des Doktorgrades

der Mathematisch-Naturwissenschaftlichen Fakultät

der Christian-Albrechts-Universität zu Kiel

vorgelegt von

Maria Hock

Kiel, 2020

Erste/r Gutachter/in:

Prof. Dr. Alexandra Erfmeier

Zweite/r Gutachter/in:

Prof. Dr. Thorsten Reusch

Tag der mündlichen Prüfung:

30. Oktober 2020

Contents

Summary	7
Zusammenfassung	9
List of Figures.....	11
List of Tables.....	11
Chapter I: General Introduction	13
1. Plant invasions - questions & state of research.....	13
1.1. Terminology & definition	13
1.2. Invasion process & invasion success.....	15
1.3. Plant invasions & global change	16
2. UV-B radiation – impact & evolution of an abiotic factor	18
2.1. Environmental factor UV-B radiation	18
2.2. UV-B radiation & plants	19
2.3. UV-B radiation & global change	21
3. Thesis structure – objectives & approaches.....	24
3.1. Major objective & study descriptions.....	24
3.2. Methodological approaches.....	26
3.3. Study system & study species	27
Chapter II: Native distribution characteristics rather than functional traits explain preadaptation of invasive species to high-UV-B environments.....	31
Chapter III: Exotic plant species are locally adapted but not to high ultraviolet-B radiation: a reciprocal multispecies experiment.	51
Chapter IV: Combined effects of UV-B and drought on native and exotic populations of <i>Verbascum thapsus</i> L.	65

Contents

Chapter V: Synthesis	87
1. Main results	87
2. Overall discussion	89
2.1. Genetic predisposition and adaptation to UV-B.....	89
2.2. Importance of phenotypic plasticity in response to UV-B	91
2.3. Environmental interactions in high-UV-B environments	93
2.4. Current and future impact of global change	95
3. Outlook.....	97
3.1. High-quality quantification of relevant UV-B effects on plants	97
3.2. Common gardens vs. in-situ approaches	97
3.3. Experimental design issues and limitations	98
3.4. Testing for UV-B preadaptation.....	99
4. Conclusion	101
Bibliography.....	103
Supporting Information.....	117
Danksagung	133
Eidesstattliche Erklärung.....	135

Summary

Progressive globalization and continuing human-mediated transports of plant material over long distances facilitated the introduction of a large number of non-native plant species all over the world. The resulting successful plant invasions might have substantial negative impacts on native natural ecosystems and cultural landscapes and, therefore, imply significant ecological and economic harms. To better predict and limit these consequences for humans and ecosystems, a deeper understanding of mechanisms underlying plant invasions is important. Thus, one central question of invasion ecology research refers to traits and conditions that facilitate plant invasion success of species. Environmental matching of non-native species with novel habitats is known to be strongly dependent on macroclimatic conditions as they predominantly determine the species' physiological niche. Especially temperature and precipitation have been previously discussed as most important abiotic filters for species distribution. Radiation, however, displays a so far neglected abiotic environmental factor in the context of plant invasions, although fundamental differences occur at a global scale and plant metabolism strongly relies on light conditions. Nevertheless, biologically active high-energy UV-B radiation might even have negative effects on plant growth and development and, thus, might act as limiting environmental factor during plant invasions.

Local surface UV-B radiation intensities mainly depend on elevation, latitude, daytime and season. Beside the seasonal differences between hemispheres, higher maximum and annual mean UV-B intensities are measured in comparable latitudes of the southern hemisphere. This difference results from the elliptical Earth's orbit around the sun leading to a smaller Sun-Earth distance during the southern hemisphere summer. Several hotspots of plant invasions are located on the southern hemisphere and consequently offer suitable conditions to investigate plant invasions in high UV-B environments. Moreover, UV-B radiation intensity is also affected by human impact and ongoing climate change that will further change local UV-B levels worldwide.

This thesis investigates the importance of high UV-B radiation for plant invasions based on 27 invasive species of New Zealand grasslands. The conducted studies contain common garden experiments comparing native and invasive origins in different UV-B environments, as well as macroecological approaches including species distribution data, trait data and global UV-B

Summary

satellite data. All approaches aimed at assessing the importance of UV-B as selective force during plant invasions and tested for potential UV-B preadaptation of native population, as well as local adaptation of invasive populations as consequence of evolutionary processes in the invaded range.

The results revealed no evidence for genetic post-introduction adaptation to UV-B in high-UV-B environments. However, both origins of the study species responded to UV-B with quantifiable physiological and phenotypic changes that hint at a pronounced plasticity maintaining plant growth in response to UV-B. Moreover, higher UV-B intensities in the native range turned out to be of advantage for alien species under UV-B exposure in novel habitats and indicate an existing UV-B preadaptation of some study species by previous UV-B experience. There was only a medium directly limiting effect of UV-B radiation in comparison to other common environmental stressors of grasslands, e.g. drought. Nevertheless, greater importance of UV-B during plant invasions might originate from the ability to induce physiological cross-protection to oxidative stress caused by other biotic and abiotic environmental factors. This effect constitutes the relevance of UV-B for invasion processes in the context of predicted global and climate change. Therefore, consideration of UV-B radiation in future species distribution models might be especially recommendable for predictions of potential suitable habitats and associated risk assessment.

Zusammenfassung

Aufgrund der anhaltenden Globalisierung und des damit verbundenen Transports von Pflanzenmaterial über große Distanzen erfolgte die Einführung unzähliger nicht heimischer Pflanzenarten durch den Menschen bereits in nahezu allen Teilen der Welt. Die daraus resultierenden erfolgreichen biologischen Invasionen können erhebliche negative Folgen für native natürliche Ökosysteme und Kulturlandschaften haben und somit ökologische und ökonomische Schäden verursachen. Um diese Konsequenzen für Mensch und Natur genauer vorherzusagen und eindämmen zu können, ist es von Bedeutung die zugrundeliegenden Mechanismen biologischer Invasionen zu verstehen. Welche Pflanzenarten unter welchen Umständen invasiv werden können, ist daher eine zentrale Frage der Forschung im Bereich der Invasionsbiologie. Eine entscheidende Rolle für den Invasionserfolg spielt unter anderem das Makroklima im Invasionsgebiet, da dieses zur physiologischen Nische der gebietsfremden Arten passen muss, um eine Etablierung und Verbreitung zu ermöglichen. Temperatur und Niederschlag stellen in diesem Zusammenhang besonders entscheidende abiotische Filter dar. Wenig berücksichtigt wurde bisher allerdings der abiotische Umweltfaktor Strahlung, obwohl auch diesbezüglich große globale Unterschiede vorherrschen und Licht ein essentieller Faktor für den pflanzlichen Stoffwechsel und das Wachstum ist. Insbesondere UV-B-Strahlung wirkt sich als hochenergetische Strahlung mit niedriger Wellenlänge unter Umständen sogar negativ auf die pflanzliche Entwicklung aus und könnte aus diesem Grund auch für biologische Invasionen einen limitierenden Faktor darstellen.

Die Intensität der UV-B-Strahlung an der Erdoberfläche ist unter anderem abhängig von der Höhenlage, dem Breitengrad und der Tages- und Jahreszeit. Zusätzlich zu den saisonalen Unterschieden zwischen der nördlichen und südlichen Hemisphäre werden in vergleichbaren Breitengrade höhere Maximum- und Jahresdurchschnittswerte der UV-B-Intensität auf der Südhalbkugel gemessen. Dieser Unterschied resultiert aus der elliptischen Erdumlaufbahn um die Sonne und der sich ergebenden geringeren Entfernung zwischen Erde und Sonne während des Südhalbkugelsommers. Viele Hotspots biologischer Invasionen befinden sich in der südlichen Hemisphäre und bieten somit geeignete Bedingungen zur Untersuchung pflanzlicher Invasionen in Gebieten mit hoher UV-B-Strahlung. Darüber hinaus unterliegen UV-B-

Zusammenfassung

Intensitäten auch stark dem anthropogenen Einfluss und dem resultierenden Klimawandel, die auch zukünftig für Veränderungen der lokalen UV-B-Level weltweit sorgen werden.

Die vorliegende Dissertation untersucht den Einfluss von hoher UV-B-Strahlung auf gebietsfremde Pflanzenarten am Beispiel von 27 invasiven neuseeländischen Graslandarten. Die verschiedenen Studien dieser Dissertation beinhalten experimentelle Untersuchungen von nativen und invasiven Herkünften dieser Arten in verschiedenen UV-B-Umwelten, sowie makroökologische Analysen unter Einbeziehung artspezifischer Merkmalsdaten, globaler Verbreitungsdaten und UV-B-Satellitendaten. Die unterschiedlichen methodischen Ansätze ermöglichen die Untersuchung der Bedeutung von UV-B-Strahlung als selektiver Umweltfaktor während des Invasionsprozesses durch das Testen auf eine lokale Anpassung invasiver Populationen an hohe UV-B-Intensitäten und auf eine mögliche Voranpassung nativer Populationen an Gebiete mit hoher UV-B-Strahlung.

Die Ergebnisse dieser Arbeit liefern keine Hinweise auf eine erfolgte genetische Anpassung invasiver Populationen an höhere UV-B-Intensitäten seit der Einführung in das Invasionsgebiet. Allerdings reagieren die untersuchten Arten unabhängig von der Herkunft mit messbaren physiologischen und phänotypischen Veränderungen auf UV-B-Strahlung und profitieren daher offenbar von ihrer Plastizität in Bezug auf Wachstum und Entwicklung. Darüber hinaus erweist sich eine höhere UV-B-Strahlung im Heimatgebiet der Arten als vorteilhaft und deutet auf eine existierende Voranpassung einiger Arten an hohe UV-B-Strahlungsintensitäten im Invasionsgebiet hin. Im Vergleich zu anderen limitierenden abiotischen Umweltfaktoren, wie z.B. Trockenheit, hat UV-B auf pflanzliches Wachstum nur einen begrenzten direkten Effekt. Größere Bedeutung kommt UV-B-Strahlung durch den induzierten physiologischen Schutz vor oxidativem Stress zu, der sich im Zusammenhang mit anderen biotischen und abiotischen Stressoren im Invasionsgebiet positiv auszahlen kann. Aus dieser Funktion ergibt sich die Relevanz des abiotischen Faktors UV-B-Strahlung für aktuelle und zukünftige pflanzliche Invasionen vor allem auch im Hinblick auf die prognostizierten globalen Umweltveränderungen und den fortschreitenden Klimawandel. Eine Berücksichtigung von UV-B-Intensitäten für die Modellierung und Vorhersage potentieller Verbreitungsgebiete im Rahmen der Risikobewertung von Pflanzenarten ist daher empfehlenswert.

List of Figures

Figure 1: Global annual mean UV-B radiation intensity based on the gIUV dataset (Beckmann et al. 2014).....	19
Figure 2: Long-term evolution of the annual mean surface all-sky UV-B radiation simulated by MIROC-ESM-CHEM. Relative change to the 1850–1859 average is shown (Watanabe et al. 2012).	22
Figure 3: Conceptual framework of factors affecting plant invasions with indicated focuses of the three publications according to Chapters II to IV.	24
Figure 4: Experimental setups: Reciprocal outdoor common garden experiments (see Chapters II and III) in New Zealand (A) and Germany (B), <i>Verbascum thapsus</i> green-house experiment (C, see Chapter IV)	26
Figure 5: Framework of factors affecting plant invasions in high-UV-B environments based on the conceptual framework (see Fig. 3) and modified in accordance with the findings of Chapters II to IV	96

List of Tables

Table 1: Study species, plant family, the year of recorded naturalization in New Zealand (according to the New Zealand Plant Conservation Network database) and the contribution to the studies of this thesis.	29
---	----

Chapter I: General Introduction

1. Plant invasions - questions & state of research

1.1. Terminology & definition

Plant invasions display a major aspect of global change and a significant threat to biodiversity worldwide (Hejda et al. 2009, Blackburn et al. 2014, Bellard et al. 2016). The research field of invasion ecology developed quickly during the last century, but terminology is still not consistent (Heger et al. 2013 a,b). With increasing globalization, human activity enabled plant species to reach habitats that would have been inaccessible by means of natural dispersal only. Species that are not indigenous in a particular habitat are predominantly called non-native species or alien species. Nevertheless, the term ‘alien species’ is not clearly defined, as it is still unsettled whether human-mediated transport is a necessary criterion (e.g. Richardson et al. 2000, Heger & Trepl 2003) or whether species continuously expanding their range are also called aliens. The latter case might include species range shifts driven by ongoing climate change (Walther et al. 2009). Furthermore, the attribute ‘invasive’ is used in different contexts so far. Some studies claim that invasive species by definition have to have a significant negative impact on human health, natural ecosystems or economy (Davis & Thompson 2000), while others relate invasiveness simply to the invasion success of a species, e.g. in terms of a large distribution or fast spread (Valéry et al. 2008). Some studies even propose to attribute invasiveness not only to alien species but also to extensively spreading native species (Valéry et al. 2008, Catford et al. 2009). The present thesis clearly addresses invasive alien species that reached the invaded range by human transport, successfully colonized and spread with economic and ecological impacts.

To elucidate mechanisms and drivers of plant invasions one has to regard characteristics of invasive species on the one hand and the vulnerability of habitats to invasive plant species on the other hand. In the last decades, many studies have attempted to identify characteristics that explain species’ invasiveness. Frequently evoked characteristics associated with invasiveness are a large native range and the ability of fast dispersal, as induced by short generation times, high

seed production, low seed weight and long seed persistence (Rejmánek and Richardson 1996, Dukes and Mooney 1999). In particular, reproduction-related traits seem to be closely connected to the success of invasive species during the early establishment stage (Cervera and Parra-Tabla 2009, Perglová et al. 2009, Kempel et al. 2013, Carboni et al. 2016). A comparative study including 14 congeneric pairs of species native to Europe and invasive in the US revealed faster germination, higher productivity and a higher proportion of flowering plants of the invasive species than of their native congeners (Schlaepfer et al. 2010). Furthermore, high initial growth rate and competitive abilities to capture light, such as herbivore resistance facilitate exotic species to invade novel environments (Kempel et al. 2013). In this context, Catford et al. (2019) additionally studied the link between lifespan, growth form and nitrogen-fixing abilities with invasion success. Moreover, the 'evolution of increased competitive ability hypothesis' (EICA) is one prominent hypothesis proposed to explain an increased competitive ability of invading species due to higher growth rates at the expense of a reduced investment in defense mechanisms (Blossey & Nötzold 1995).

In contrast, invasibility describes the vulnerability of an ecosystem, habitat or plant community to an invasion of non-native species that might suppress or replace native species subsequent to a successful colonization. Environmental conditions and the characteristics of the native species community equally determine the invasibility of habitats. Sufficient resource availability, low pathogen and herbivore pressure ('enemy release hypothesis', ERH) and especially disturbance facilitate early establishment and successful plant invasion if propagule pressure is adequate (Keane & Crawley 2002, Richardson & Pyšek 2006, Kempel et al. 2013, Catford et al. 2019). These abiotic and biotic conditions are closely associated with the recipient community characteristics. In a highly productive community, light and nutrient availability might be limited due to high levels of competition and establishment of exotic species aggravated (Kempel et al. 2013). In line with that, high-diversity communities are frequently considered resilient against invasion, as higher diversity is often related to increased niche and resource complementarity in a community (see Feng et al. 2019, Smith & Coté 2018). Nevertheless, not only species diversity but also species identity determines invasibility of recipient communities (Feng et al. 2019). Thus, phylogenetic and functional distance of alien species to native species might be crucial for invasion success, but the impact appears to be highly context-dependent. Where environmental filtering applies, similarity of native and exotic species in environmental adaptations would be expected and of advantage, but if competition for resources predominantly drives community assembly, dissimilarity would ensure niche

differences and favouring coexistence (Carboni et al. 2016, Feng et al. 2019). Consequently, importance of dissimilarity of alien and invasive species increases with higher diversity of recipient communities, whereas species diversity of the native community especially matters, if alien species are very similar to the native species (Feng et al. 2019).

Previous studies on invasiveness of species and invasibility of habitats, agree about the fact that the significance of these factors is generally context-dependent, scale-dependent and also subject to residence time in the new range (Kempel et al. 2013, Carboni et al. 2016, Catford et al. 2019).

1.2. Invasion process & invasion success

In the course of globalization, a plethora of species have managed to overcome geographic barriers and to successfully establish wild populations in the new environment. Following the framework for biological invasions proposed by Blackburn et al. (2011), the environmental conditions in the invaded range represent an important barrier a species has to face upon arrival in a new region before it can survive and finally establish locally. Those naturalized species turn into invasive species, if they start to spread over larger distances and form self-sustained populations there (Richardson & Pyšek 2006, Blackburn et al. 2011). While the 'tens rule' (see Williamson & Fitter 1996) assumes only 1% of introduced species to become invasive alien plant pests, Richardson & Pyšek (2006) suggested that this rough estimation might be especially dependent on the alien species' residence time. As latency periods ('lag phases') of indeterminate length can occur between species introductions and the typical exponential spread of invasive alien species, currently observed patterns might be the result of species introductions from over a century ago (Hulme 2003).

Different strategies of alien species to overcome the described barriers and become invasive have been identified and frequently investigated to date. Two mechanisms that might apply non-exclusively have been repeatedly addressed, i.e. the concept of pre-adaptation including species sorting following environmental filtering (Theoharides & Dukes 2007, Shine et al. 2011) and the role of adaptive evolution following natural selection in the invaded range (Prentis et al. 2008, Buswell et al. 2011). In fact, some species are pre-adapted to become invasive, as they have evolved traits in their native range that confer an advantage in the introduced range (Fridley 2013). One result of pre-invasion evolution in the native range might be a large

phenotypic plasticity that is especially beneficial during colonization of novel habitats with unfamiliar environmental conditions (Parker et al. 2003, Ghalambor et al. 2007, Lamarque et al. 2015). Post-invasion evolution in the invaded range could be simply the result of genetic drift or a reduction of genetic diversity by founder effects (Bossdorf et al. 2005). In contrast, some species evolve new traits in response to the novel environments (Erfmeier 2013). Whereas evidence for pre-adaptation can be derived from comparing species with different invasive potential (Schlaepfer et al. 2010, van Kleunen et al. 2011), more recent local adaptation needs to be tested in within-species comparisons of native and exotic origins (Kawecki and Ebert 2004).

1.3. Plant invasions & global change

Global environmental change comprises climate change, as well as anthropogenic nitrogen deposition, air pollution and an increase of disturbance and propagule pressure of alien species in natural habitats (Catford et al. 2017). A phylogenetically controlled meta-analysis on the effect of global change components on the performance of native and invasive species revealed that an increase of temperature and CO₂ concentrations evoked a stronger performance increase in alien species than in natives (Liu et al. 2017). The authors also found a tendency of a stronger positive alien response to nitrogen deposition and increased precipitation, but a slightly more pronounced negative effect of reduced precipitation on non-native species. Thus, especially global warming might accelerate the spread of alien species due to the enhanced provisioning of climatically suitable areas with a higher risk of naturalization of alien species (Walther et al. 2009). This might particularly apply to higher elevations of mountainous ecosystems (Petitpierre et al. 2016) or subsequently to the escape of garden plants from captivity (Dullinger et al. 2017, Klöner et al. 2019). The latter group is favoured by the increasing horticultural trade that has been identified as a major pathway of introduction for vascular plant species (Hulme et al. 2008, van Kleunen et al. 2018). Human transport and the subsequent release of plant species beyond their native range is a serious aspect of global environmental change resulting in an increased propagule pressure of alien species elsewhere (Mack et al. 2000, Chapman et al. 2016). Consequently, multiple introductions display a feature of many successful plant invasions, as they increase genetic diversity and adaptive potential of alien species populations (Gaudeul et al. 2011, Dlugosch & Parker 2008). Chapman et al. (2016) identified climate warming in combination with international trade as joint major drivers of ragweed invasions with high importance of anthropogenic long-distance dispersal within the

invaded range subsequent to the human-mediated introduction from the native range. Moreover, an increasingly suitable climate in combination with disturbance events, e.g. fires, provide chances for alien species to naturalize and spread successfully, especially if they possess high (physiological) plasticity and effective dispersal strategies (Hampe & Petit 2005, Kuhmann et al. 2010, Sharma & Raghubanshi 2011). Hence, interacting effects of plant invasions and land use intensification were recently found to severely reduce taxonomic and functional richness in native plant communities (Gutiérrez-Cánovas et al. 2020).

Species distribution modelling (SDM) is a suitable tool to assess the potential responses of alien plant species to global environmental change and to predict their future distribution (Petitpierre et al. 2016, Mungi et al. 2018, Klöner et al. 2019). Nevertheless, challenges for SDMs remain as, globally, the spread of invasive alien species is an ongoing process and it can be assumed that not all of them have had enough time to colonize all suitable habitats in the non-native range yet. Moreover, native niches do not necessarily have to match non-native niches (Buckley & Csergö 2017). Thus, additional observational studies of ongoing invasions and experimental approaches across multiple species are still essential in invasion ecology.

2. UV-B radiation – impact & evolution of an abiotic factor

2.1. Environmental factor UV-B radiation

Solar radiation naturally contains less than 10% invisible ultraviolet wavelengths (100-400 nm)¹. Whereas UV-A radiation (315-400 nm) reaches the earth's surface to almost the full extent, wavelengths smaller than 315 nm are predominantly absorbed in the atmosphere by stratospheric ozone. Consequently, the complete solar UV-C wavelengths (100-280 nm) and about 90% of solar UV-B radiation (280-315 nm) is filtered on its way to the earth's surface, where only 6% ultraviolet radiation remain among surface radiation. In contrast to UV-A radiation, high-energy UV-B acts biologically effective, i.e. it is able to cause damage to organic material and tissues. In the context of human health, UV-B radiation is especially harmful to eyes, erythemally effective or even carcinogenic (Young 2006).

UV-B radiation intensity varies with season and time of the day depending on solar radiation presence, intensity and duration. Surface UV-B levels are also highly dependent on different factors that operate on a smaller spatial scale. Complete cloud coverage blocks large amounts of UV-B, whereas light cloud appearance or fog might even intensify UV-B radiation. Also water, sand or snow surfaces enhance local UV-B levels due to multiple reflection of radiation. However, local elevation is most important for effective UV-B intensity, as it increases by about 10% per 1000 metres in altitude. An additional increase of UV-B intensity at the earth's surface is induced by stratospheric ozone depletion due to the reduced atmospheric filter effect. In contrast, anthropogenic air pollution by tropospheric aerosol emissions may decrease the regional surface UV-B radiation. On a broader spatial scale, latitude predominantly determines UV-B intensity with generally higher levels of UV-B at lower distance to the equator.

Additionally, there are significant differences in UV-B intensities on a global scale between the northern and southern hemispheres (Godar 2005). Aside from the seasonal shift with the highest UV-B radiation around July in the northern hemisphere and around January in the southern hemisphere, there is also an overall difference in annual and maximum UV-B levels (**Fig.1**). Therefore, comparable latitudes in the northern and southern hemisphere experience

¹ for general information about UV radiation see German Federal Office for Radiation Protection (BfS), https://www.bfs.de/EN/topics/opt/uv/introduction/introduction_node.html

different amounts of UV-B radiation. The closer earth-sun separation during the southern hemisphere summer and the higher solar elevation angle are responsible for up to twofold higher intensities in southern hemisphere. Thus, global UV-B differences are a fundamental phenomenon but also remain subject to change.

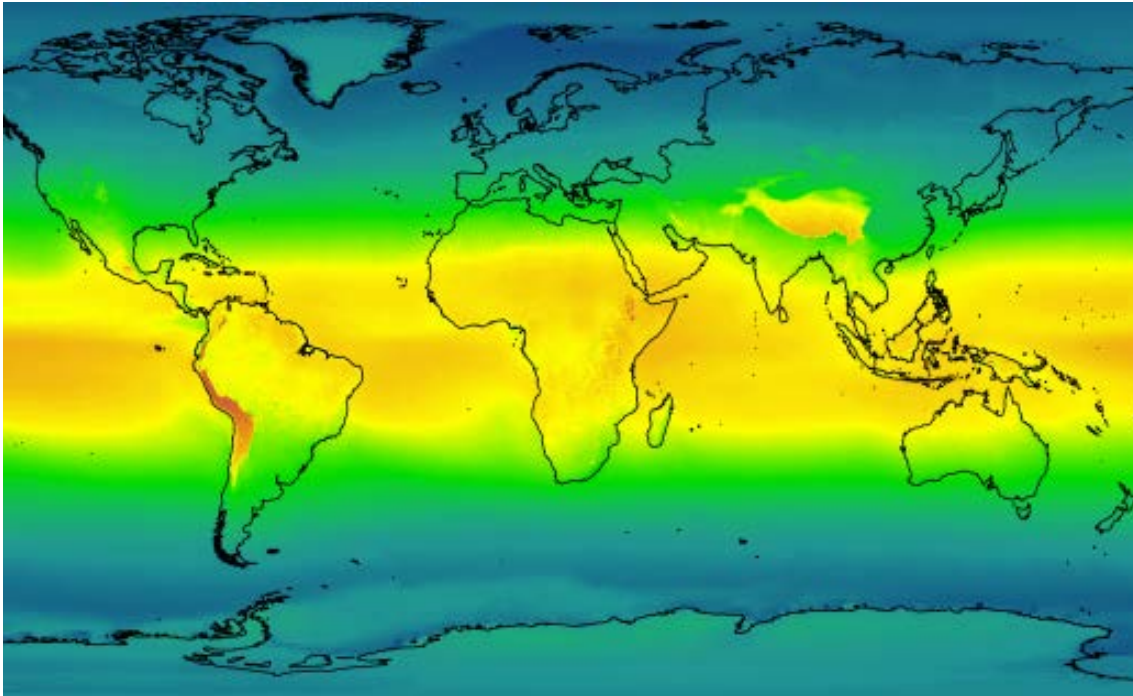

Figure 1: Global annual mean UV-B radiation intensity based on the *glUV* dataset (Beckmann et al. 2014)

2.2. UV-B radiation & plants

Short-wave UV-B is a high-energy radiation that is particularly harmful to organic material and tissues. In general, plants respond to UV-B exposure with changes in productivity, plant architecture and leaf morphology, such as thicker leaves, leaf shape changes, increased branching and altered shoot:root ratios (Kataria et al. 2014, Llorens et al. 2015, Robson et al. 2015, Suchar & Robberecht 2016).

Biologically effective UV-B radiation causes interferences at different organizational levels of plants, including DNA damage and formation of cyclobutane pyrimidine dimers (Rozema et al. 1997, Jansen et al. 1998). Beside nucleic acids, the main targets of UV-B radiation at the cellular level are Calvin cycle enzymes and photosystem II proteins with a considerable potential for an impairment of the photosynthesis apparatus (Kataria et al. 2014). Furthermore, photosynthesis

is affected by membrane destabilization, photosystem II inactivation and decreasing photosynthetic pigment concentrations (Tevini & Teramura 1989, Tosserams et al. 1996). Additionally, decreasing phytohormone concentrations (e.g. IAA), induced by photo-oxidation, lead to morphological changes in plants (Rozema et al. 1997, Jansen et al. 1998). Consequently, UV-B-exposed plants suffer from reductions in biomass, height and leaf area (Jansen et al. 1998, Hofmann et al. 2001) and experience changes in functional leaf traits, such as an increasing leaf dry matter content (Beckmann et al. 2012).

Plants perceive UV-B radiation by the UV-B response locus 8 (UVR8) photoreceptor, that directly triggers activation of UV-B acclimation or tolerance mechanisms, such as biosynthesis of sunscreen metabolites, antioxidants and DNA repair enzymes (Ulm & Jenkins 2015, Coffey et al. 2017). The UVR8 photoreceptor is functionally conserved from green algae to higher plants (Fernández et al. 2016) and induced modulation of UV-B screening properties may happen within minutes (Barnes et al. 2016). Effective UV-B protection could be also achieved by epidermal or cuticular structures and trichomes on the upper leaf surface (Skaltsa et al. 1994, Manetas 2003), as well as by production of UV-B absorbing flavonoids and anthocyanins (Tevini & Teramura 1989, Jansen et al. 1998).

Species differ in their responsiveness to UV-B radiation, e.g. Musil (1995) attributed higher UV-B resilience to monocotyledons compared to dicotyledonous species. UV-B sensitivity was found to be higher in short-lived species (annuals and biennials) than in perennial plant species (Suchar & Robberecht 2018). The authors also assumed a stronger effect of UV-B on biomass production of plants when they are exposed to increased UV-B levels early in the growing season. Furthermore, early stages of plant development and seedling establishment are particularly sensitive to biologically effective UV-B radiation, when appropriate protection measures are not yet fully evolved. In particular, reduced seedling biomass, inhibited hypocotyl or root development and growth abnormalities (e.g. shoot curvature) have been observed in response to high UV-B intensities (Krizek 1975, Tosserams et al. 1997, Gonzalez et al. 1998, Dai & Upadhyaya 2002). Evidence of UV-B-induced inhibition of germination success has been shown in several studies to date (Tosserams et al. 1997, Dai & Upadhyaya 2002, Hock et al. 2015). Suchar & Robberecht (2016, 2018) additionally assumed a competitive advantage of species in high-UV-B conditions due to changes in phenology, e.g. a delayed reproductive timing resulting in higher mature seed production.

UV-B radiation also affects processes at the ecosystem level, e.g. plant litter decomposition is supported by UV-B radiation due to a generally enhanced lignin photodegradation (Austin & Vivanco 2006, Song et al. 2012). Nevertheless, UV-B also affects microbial communities with important functions in nutrient cycling, changes species composition of fungal communities and is known to decrease microbial decomposition rates (Pancotto et al. 2003, 2005, Rinnan et al. 2005). Under UV-B exposure, even mycorrhization was found to decrease by about 20% in Dutch dune grasslands (van de Staaij et al. 2001). In contrast, UV-B radiation appears to induce defense abilities of plants against bacterial leaf pathogens and herbivores due to its impact on jasmonate signaling (Demkura et al. 2010). Beside the indirect effects on leaf tissue quality traits, also direct effects of UV-B on insect herbivores were identified, e.g. increased larvae mortality or behavioral changes in response to UV-B perception (see Ballaré et al. 2011). Thus, UV-B exposed plants often suffer less from folivorous insect herbivores (see Caldwell et al. 2007, Kuhlmann & Müller 2010).

2.3. UV-B radiation & global change

The evolution of surface UV-B radiation between 1850 and today is clearly illustrated for different latitude ranges from the Arctic to the Antarctic by Watanabe et al. (2012, **Fig. 2**): UV-B radiation intensity decreased gradually in the 19th and 20th century. Later on, the decrease was accelerated more rapidly in the industrial regions of the northern hemisphere's midlatitudes due to increasing emissions of tropospheric ozone and aerosol precursors. Nevertheless, an increase of UV-B intensity was observed in the southern hemisphere, mainly due to the rapid stratospheric ozone depletion in the late 20th century. Although ozone depletion currently stagnates or reverses, further UV-B intensity changes are expected in all parts of the world. Watanabe et al. (2012) predict increasing UV-B in the northern hemisphere due to a recovery of air quality and decreasing anthropogenic emissions. In contrast, decreasing UV-B is predicted for the southern hemisphere due to ongoing ozone hole recovery.

However, the particular impact of changes in UV-B intensity on plants and ecosystems should not be evaluated separately, but in the context of interactions with other environmental factors subjected to influences of climate change.

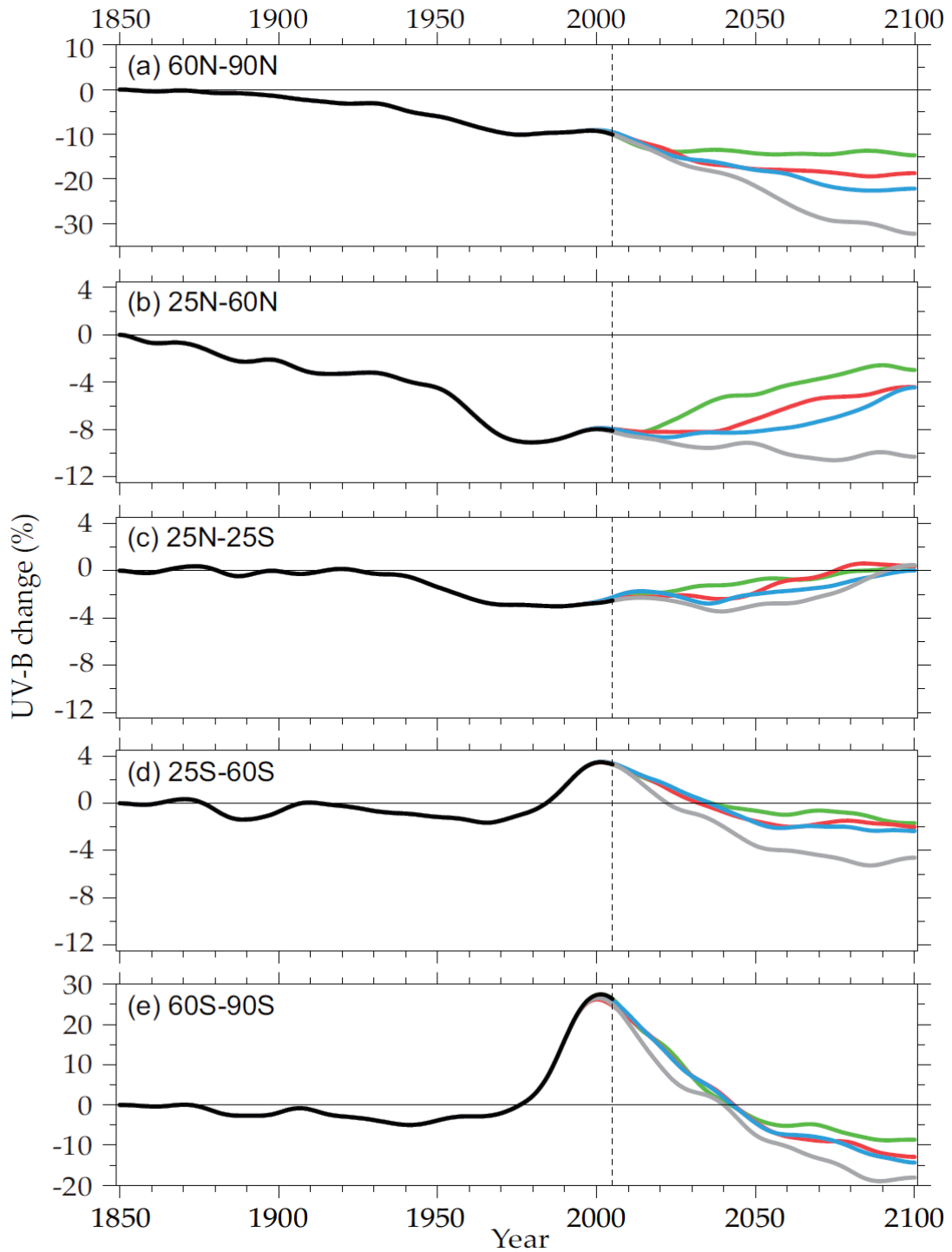

Figure 2: Long-term evolution of the annual mean surface all-sky UV-B radiation simulated by MIROC-ESM-CHEM. Relative change to the 1850–1859 average is shown (Watanabe et al. 2012).

Bandurska et al. (2013) found evidence for cross-resistance mechanisms of drought and UV-B, i.e. plants appeared to be more resistant to UV-B under drought conditions and vice versa. This effect is due to a common metabolic plant response to both stresses, which individually cause considerable reductions in growth with a more pronounced effect of water deficit on plant productivity (Ballaré et al. 2011). Similar cross-protection effects of UV-B and frost were found in *Rhododendron* and *Pinus* species, based on UV-B-induced phenolics (Chalker-Scott & Scott 2004, Teklemariam & Blake 2004). The authors assume that UV-B exposed plants might be generally more resistant to other environmental stresses, especially if these induce oxidative stress in plant cells. In contrast, there is no clear interaction pattern of high temperatures and UV-B radiation, as heat tolerance did not increase with UV-B exposure in all studied species (see Caldwell et al. 2007). Furthermore, there is only little evidence of interactive effects of UV-B radiation and predicted warming (Ballaré et al. 2011). However, the meta-analysis by Caldwell et al. (2007) outlines the clear counteractive effect of UV-B radiation and CO₂. The study revealed the small stimulating effects of increased CO₂ on growth responses to be considerably depleted or mostly even reversed by elevated UV-B. Increasing nitrogen deposition mainly occurs in inhabited areas with agricultural and industrial activity. The interacting effects of elevated UV-B radiation and supplementary nitrogen were found to be rather species-specific with evidence for an increasing UV-B sensitivity under nitrogen addition for some species and an alleviation of UV-B induced growth inhibition by biologically available nitrogen in other species (Caldwell et al. 2007, Belnap et al. 2008, Ballaré et al. 2011).

In addition, the expected changes in abiotic environmental conditions are likely to affect current and future plant invasions as one major aspect of global change. To date, the impact of UV-B radiation intensity on the spread of alien species has been subject of only a few single-species studies (Qaderi et al. 2008, Beckmann et al. 2012, Hock et al. 2015, Wang et al. 2016). Since detrimental effects of UV-B radiation on plant performance are common ecological knowledge and fundamental differences in UV-B radiation intensities exists on a global scale with expected regional changes in the context of global change, UV-B radiation might be an influencing factor for the invasion success of alien plant species. Thereby, the importance of high UV-B radiation for plant invasions might be especially dependent on the ability of alien species to either respond plastically to this environmental factor or to already possess or rather evolve appropriate UV-B adaptation.

3. Thesis structure – objectives & approaches

3.1. Major objective & study descriptions

The thesis aims at assessing the impact of the environmental factor UV-B radiation on plant invasions in high-UV-B environments. Both, non-native plant individuals and the novel environment, generally contribute to progress and success of plant invasions (see **Fig. 3**). As explained above, a plant's characteristics determined by its genotype and to a certain extent also expressed in its phenotype, define the invasiveness of an individual. Additionally, the novel environment directly **influences** plant invasion processes not only by displaying the first selective filter for alien species after introduction, but also beyond initial establishment local environmental factors can actively impinge on genotype and/or phenotype of non-native individuals. At the same time, most environments are also subject to constant change due to human impact and/or its consequences, such as climate change. In the present thesis, the general framework of factors affecting invasion success is applied to plant invasions in high-UV-B environments. Nevertheless, not all influencing factors are equally addressed but a focus on the effects of genotype and environment were set (**Fig. 3**). Although the effect of phenotype was not directly tested, it is discussed as a potentially applicable alternative hypothesis.

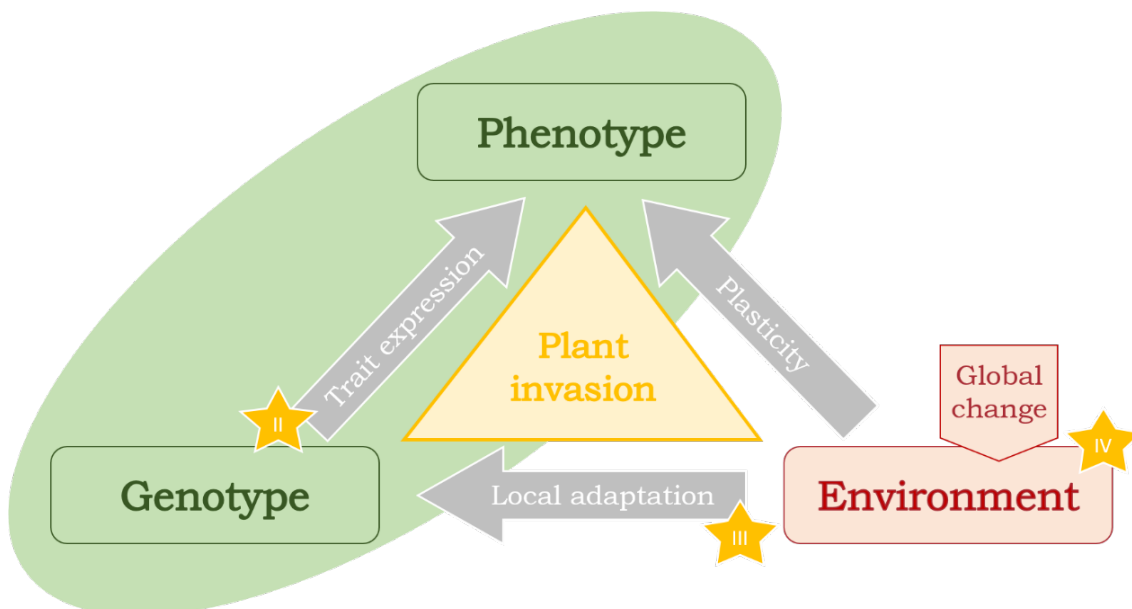

Figure 3: Conceptual framework of factors affecting plant invasions with indicated focuses of the three publications according to Chapters II to IV.

Furthermore, it is of specific interest what relevance UV-B radiation exhibits during plant invasions, under which circumstances an UV-B effect applies and which underlying mechanisms operate. Thus, this thesis intends to address the following research questions:

- Is there any evidence for a predisposition of exotic species to high levels of UV-B and, if so, what trait or ability would explain this specific aptitude? Moreover, is it even possible to derive information about species' invasive potential in high-UV-B environments that might be useful in the context of risk assessment?
- Does UV-B act as a selective force during plant invasions and consequently cause specific adaptation to high UV-B levels in exotic populations?
- How does UV-B radiation affect plant performance in interaction with other environmental factors that are also closely associated with global change and is it possible to assess the relative importance of UV-B radiation for invasion processes among macroclimatic factors?

The present thesis combines three studies representing different methodical approaches (see **Fig. 4**) to answer the defined research questions in the context of plant invasions in high-UV-B environments:

Chapter II

This chapter addresses potential predisposition of plant species to successfully colonize high-UV-B environments due to **UV-B preadaptation by specific functional plant traits or biogeographical characteristics of the native range**. The performance of native European populations of 25 study species was determined under different UV-B regimes in the native and the invaded range. The combination of the multispecies experimental data with database information about species traits and native distribution characteristics allows the identification of general pre-adaptation patterns among the entire species pool.

Chapter III

The study investigates the potential **local adaptation of exotic populations to high UV-B radiation in the invaded range**. Recent evolutionary processes after introduction to the invaded range were tested for eight species in two multispecies reciprocal common garden experiments in Germany and New Zealand. The chapter aims at assessing the impact of UV-B radiation as selective force during plant invasions in New Zealand.

Chapter IV

To evaluate the role of **combined effects of drought and high UV-B radiation on plants** a single-species experiment was conducted in a greenhouse. Native and exotic populations of *Verbascum thapsus* were exposed to UV-B radiation and drought separately and in combination to test for potential cross-resistance effects in response to two concomitant limiting environmental factors.

3.2. Methodological approaches

To answer the described research questions, different methods were used combining single-species and multi-species experimental approaches (**Fig. 4**) with global UV-B satellite data and information from species trait and species distribution databases.

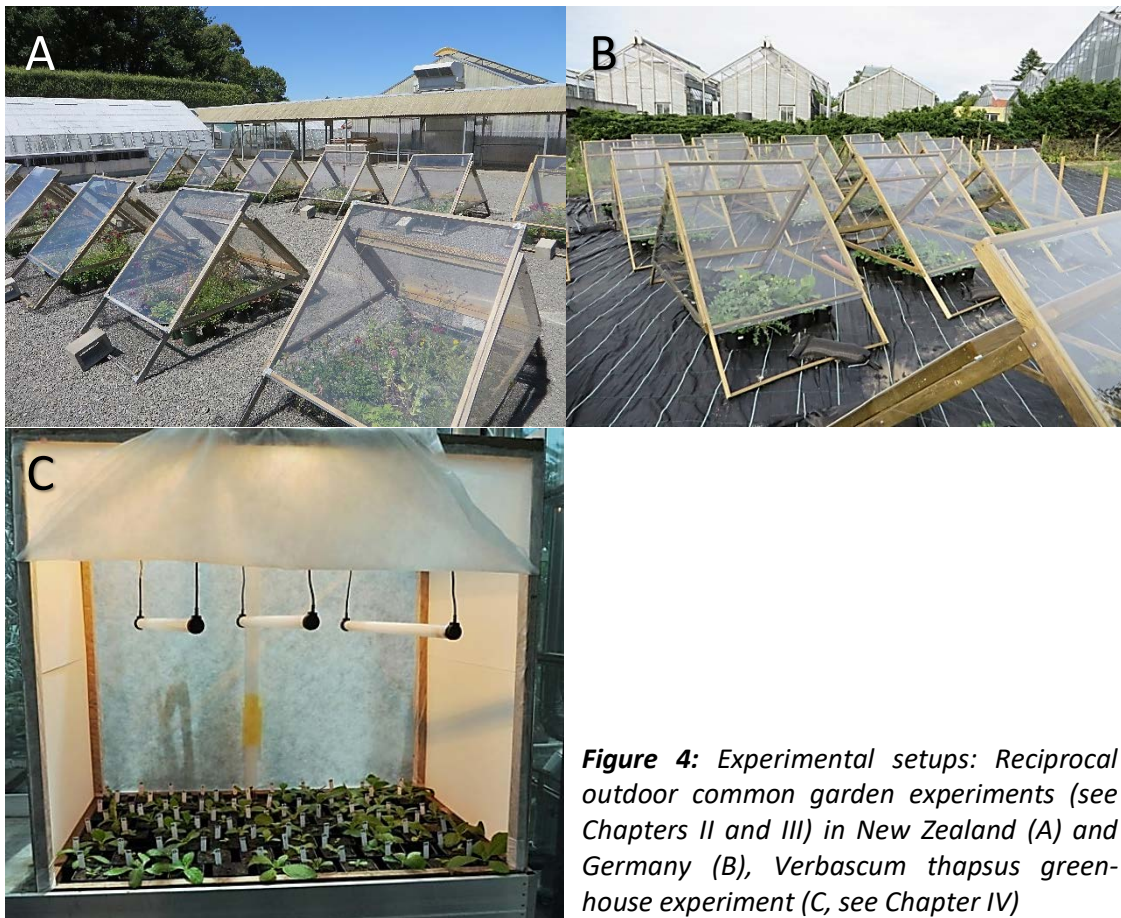

Figure 4: Experimental setups: Reciprocal outdoor common garden experiments (see Chapters II and III) in New Zealand (A) and Germany (B), *Verbascum thapsus* greenhouse experiment (C, see Chapter IV)

Common garden experiments are frequently used in the field of invasion ecology to compare the performance of different genotypes, e.g. native and exotic populations, in a common and controlled environment and to identify potential genotypic or phenotypic differentiation (e.g. see Moloney et al. 2009, Oduor et al. 2016, Jagodziński et al. 2019). In this thesis, reciprocal common garden experiments in the native and invaded range were conducted to additionally assess the performance of native populations in the high-UV-B invaded range and to furthermore derive information about the general aptitude of species. In addition to the reciprocal common garden environments with ambient light conditions as provided by their respective locations, artificial UV-B radiation was applied in a greenhouse experiment in combination with drought, as more controlled conditions were necessary to clearly separate effects of the abiotic factors UV-B and drought.

Moreover, functional trait data from the TRY plant trait database² (Kattge et al. 2011, 2020) were used to characterize the study species. Species distribution data from GBIF³ (The Global Biodiversity Information Facility) and the respective information about species status obtained from GloNAF⁴ (van Kleunen et al. 2019) provided macroecological information about total native and exotic distribution and general species' ability to spread extensively on a global scale. To define the realized native and exotic UV-B niche, species distribution data was matched with global UV-B satellite data from glUV⁵ (Beckmann et al. 2014). All derived data were used to identify species attributes and requirements that might be beneficial for successful colonization of high-UV-B environments.

3.3. Study system & study species

The strong impact of anthropogenic land use changes on invasibility of native plant communities has become very clear in long time isolated systems, such as New Zealand. Before human settlement, more than 75% of the island was covered with forest (King 1990). Polynesians colonized New Zealand in the 13th century and started burning big forest areas, especially in the South Island (Ogden et al. 1998, Hobbs et al. 2006). In consequence, one third of native forest got lost and extended tussock grasslands developed due to regular use of fire (Duncan et al.

² <https://www.try-db.org>

³ <https://www.gbif.org>

⁴ <https://glonaf.org>

⁵ <https://www.ufz.de/glufv>

2001). With the arrival of European settlers in the 18th century, a second forest clearing period set in to provide space for farms and pastures. Today, only 30% of the native forest has been retained and exotic tree plantations of *Pinus radiata* and *Pseudotsuga menziesii* cover more than 5% of the country, as those species display the foundation of New Zealand forestry (New Zealand Ministry for Primary Industries⁶). Open habitats in New Zealand are, in turn, predominantly being used as pastures for cattle and sheep. Concomitantly with over 200 years of grazing, composition of tussock grasslands changed from tall-growing *Chionochloa* species to a dominance of shorter grasses of the genera *Festuca* and *Poa* (Rose et al. 1995, Duncan et al. 2001). Due to the persistent disturbance of grasslands by grazing, multiple exotic plant species (e.g. *Trifolium repens*) have successfully colonized these cultivated ecosystems and almost completely replaced the native vegetation (Clout & Lowe 2000, Hobbs et al. 2006). Thus, the biosecurity strategy of the New Zealand government is predominantly based on three main priorities: improvement of risk assessment, strict import regulations and local pest management. Biosecurity is a central responsibility of the New Zealand Ministry for Primary Industries⁵ that represents the interests of fishery, forestry and agriculture. At the end of the 19th century, quarantine officers started to check any organic imports to New Zealand⁷ but until today, it is hard to set meaningful criteria to predict species endangering the endemic biodiversity. According to the New Zealand Department of Conservation⁸, 46% of vascular plants are classified as threatened with or at risk of extinction.

New Zealand grasslands display an especially suitable study system to investigate the impact of UV-B radiation on plant invasions for several reasons: New Zealand's location on the southern hemisphere leads to historically higher UV-B radiation intensities compared to the northern hemisphere native ranges of the majority of introduced species. However, the large grasslands of the New Zealand South Island experience temperate climatic conditions that allow quantification of effects of high UV-B on plants against the backdrop of an otherwise comparable climatic setting. Since the European colonization, a huge number of diverse alien species of different growth forms and from several plant families have been introduced from all over the world. The establishment and naturalization of many of these species in New Zealand already date back more than 150 years, providing the opportunity for genotypic and phenotypic adaptation to high UV-B intensities. The 27 herbaceous study species of this thesis belong to

⁶ <https://www.mpi.govt.nz>

⁷ <https://nzhistory.govt.nz/politics/plant-and-animal-quarantine>

⁸ <https://www.stats.govt.nz>, last update: 18.04.2019

eleven plant families, are all native to Europe and naturalized in New Zealand (Ngā Tipu o Aotearoa - New Zealand Plant Names Database⁹, Howell & Sawyer 2006, **Tab. 1**).

Table 1: Study species, plant family, the year of recorded naturalization in New Zealand (according to the New Zealand Plant Conservation Network database¹⁰) and the contribution to the studies of this thesis.

Species	Family	Year of NZ naturalization	Chapter		
			II	III	IV
<i>Antirrhinum majus</i>	Scrophulariaceae	1946	x		
<i>Artemisia absinthium</i>	Asteraceae	1872	x	x	
<i>Aurinia saxatilis</i>	Brassicaceae	1988	x		
<i>Centranthus ruber</i>	Valerianaceae	1878	x		
<i>Cerintho major</i>	Boraginaceae	1980	x		
<i>Cichorium intybus</i>	Asteraceae	1867	x		
<i>Dianthus barbatus</i>	Caryophyllaceae	1872	x		
<i>Diplotaxis muralis</i>	Brassicaceae	1899	x		
<i>Erysimum cheiri</i>	Brassicaceae	1875		x	
<i>Inula helenium</i>	Asteraceae	1958	x		
<i>Leontodon autumnalis</i>	Asteraceae	1867	x		
<i>Linaria purpurea</i>	Scrophulariaceae	1875	x	x	
<i>Lobularia maritima</i>	Brassicaceae	1840	x	x	
<i>Malva neglecta</i>	Malvaceae	1867	x		
<i>Origanum vulgare</i>	Lamiaceae	1944	x	x	
<i>Potentilla recta</i>	Rosaceae		x		
<i>Prunella laciniata</i>	Lamiaceae		x		
<i>Prunella vulgaris</i>	Lamiaceae	1867	x		
<i>Silene dioica</i>	Caryophyllaceae	1904	x		
<i>Silene latifolia</i>	Caryophyllaceae	1896	x		
<i>Tanacetum parthenium</i>	Asteraceae	1875	x		
<i>Tragopogon porrifolius</i>	Asteraceae	1870	x	x	
<i>Trifolium medium</i>	Fabaceae	1870	x		
<i>Trifolium pratense</i>	Fabaceae	1867	x	x	
<i>Trifolium repens</i>	Fabaceae	1864	x	x	
<i>Verbascum thapsus</i>	Scrophulariaceae	1867			x
<i>Veronica serpyllifolia</i>	Plantaginaceae	1864	x		

⁹ <http://nzflora.landcareresearch.co.nz>

¹⁰ <https://www.nzpcn.org.nz/flora/vascular>

Chapter II: Native distribution characteristics rather than functional traits explain preadaptation of invasive species to high-UV-B environments.

M. Hock, R. W. Hofmann, F. Essl, P. Pyšek, H. Bruelheide & A. Erfmeier
published in *Diversity and Distributions* 26(10), 1421-1438 (2020),

DOI: 10.1111/ddi.13113

Abstract:

Aim: Alien species successfully colonize new ranges if they encounter favourable environmental conditions there and possess traits that match new challenges. Climate matching approaches comparing native and exotic ranges mostly consider temperature and precipitation niches of alien species, but have largely ignored UV-B radiation. UV-B fundamentally differs between hemispheres, with much higher levels at southern than at northern latitudes. Consequently, UV-B might act at the global scale and present a so far neglected filter that species need to overcome when invading high-UV-B environments.

Location: We performed two multi-species common-garden experiments, conducted in the native European range (Germany) and the high-UV-B exotic range (New Zealand) to test for preadaptation to UV-B.

Methods: We used 25 herbaceous species from open habitats, which we exposed in each range to three UV radiation treatments: (i) natural sunlight, (ii) exclusion of UV-B while allowing natural UV-A, and (iii) exclusion of UV-B and UV-A. We additionally used plant traits (TRY), global distribution data (GBIF, GloNAF) and global UV-B satellite data (glUV) to determine species-specific characteristics as fostering agents of UV-B tolerance. The joint analysis of experimental and macroecological data allowed quantification of species plasticity and identification of beneficial species traits in high-UV-B environments.

Results: Our results showed an overall limiting effect of UV-B in both common gardens but the UV stress response tended to be more pronounced in the invaded range. Across all species, we found little evidence for preadaptation by functional plant traits. In contrast, preadaptation to climatic conditions related to the species' native UV-B niche was of greater importance for plant performance in the presence of UV-B radiation.

Main conclusions: For predicting alien species' ability to expand into high-UV-B environments, macroclimatic niche characteristics of the species' native range might be better predictors than functional traits and should be more considered in future projection models.

Native distribution characteristics rather than functional traits explain preadaptation of invasive species to high-UV-B environments

Maria Hock^{1,2}  | Rainer Hofmann³  | Franz Essl⁴  | Petr Pyšek^{5,6}  |
Helge Bruelheide^{2,7}  | Alexandra Erfmeier^{1,7} 

¹Institute for Ecosystem Research/
Geobotany, Kiel University, Kiel, Germany

²Institute of Biology/Geobotany and
Botanical Garden, Martin Luther University
Halle-Wittenberg, Halle, Germany

³Faculty of Agriculture and Life Sciences,
Lincoln University, Lincoln, New Zealand

⁴Department of Botany and Biodiversity
Research, University Vienna, Vienna,
Austria

⁵Institute of Botany, Department of Invasion
Ecology, Czech Academy of Sciences,
Průhonice, Czech Republic

⁶Department of Ecology, Faculty of Science,
Charles University, Prague, Czech Republic

⁷German Centre for Integrative Biodiversity
Research (iDiv) Halle-Jena-Leipzig, Leipzig,
Germany

Correspondence

Maria Hock, Institute for Ecosystem
Research/Geobotany, Kiel University,
Olshausenstr. 75, 24118, Kiel, Germany.
Email: mhock@ecology.uni-kiel.de

Funding information

State Postgraduate Scholarship Programme
of Saxony-Anhalt; DAAD (German Academic
Exchange Service); Austrian Science
Foundation FWF, Grant/Award Number:
I2086-B16; FAZIT Stiftung

Editor: Marta Carboni

Abstract

Aim: Alien species successfully colonize new ranges if they encounter favourable environmental conditions there and possess traits that match new challenges. Climate-matching approaches comparing native and exotic ranges mostly consider temperature and precipitation niches of alien species, but have largely ignored UV-B radiation. UV-B fundamentally differs between hemispheres, with much higher levels at southern than at northern latitudes. Consequently, UV-B might act at the global scale and present a so far neglected filter that species need to overcome when invading high-UV-B environments.

Location: We performed two multi-species common garden experiments, conducted in the native European range (Germany) and the high-UV-B exotic range (New Zealand) to test for preadaptation to UV-B.

Methods: We used 25 herbaceous species from open habitats, which we exposed in each range to three UV radiation treatments: (a) natural sunlight, (b) exclusion of UV-B while allowing natural UV-A, and (c) exclusion of UV-B and UV-A. We additionally used plant traits (TRY), global distribution data (GBIF, GloNAF) and global UV-B satellite data (gIUV) to determine species-specific characteristics as fostering agents of UV-B tolerance. The joint analysis of experimental and macroecological data allowed quantification of species plasticity and identification of beneficial species traits in high-UV-B environments.

Results: Our results showed an overall limiting effect of UV-B in both common gardens but the UV-stress response tended to be more pronounced in the invaded range. Across all species, we found little evidence for preadaptation by functional plant traits. In contrast, preadaptation to climatic conditions related to the species' native UV-B niche was of greater importance for plant performance in the presence of UV-B radiation.

Main conclusions: For predicting alien species' ability to expand into high-UV-B environments, macroclimatic niche characteristics of the species' native range might

This is an open access article under the terms of the Creative Commons Attribution License, which permits use, distribution and reproduction in any medium, provided the original work is properly cited.

© 2020 The Authors. *Diversity and Distributions* published by John Wiley & Sons Ltd

be better predictors than functional traits and should be more considered in future projection models.

KEYWORDS

alien species, climatic preadaptation, common garden, functional preadaptation, Germany, multi-species experiment, New Zealand, plant traits, species distribution, UV-B radiation

1 | INTRODUCTION

Alien species reach novel habitats due to human-mediated transport and expand into new ranges with sometimes severe consequences for indigenous plant communities and ecosystems and/or the local economy (see Blackburn et al., 2011; Heger, Saul, & Trepl, 2013; Richardson et al., 2000). Gaining a deeper understanding of mechanisms underlying the colonization of alien species in novel ranges is a major aim of invasion science. Thus, one research focus still addresses invasiveness of species including the identification of traits and characteristics that might be beneficial during establishment and spread into new habitats. While beneficial traits might already exist prior to the introduction elsewhere (e.g. DeWalt, Denslow, & Hamrick, 2004; Dlugosch & Parker, 2007; Elst et al., 2016), they might also be the outcome of evolutionary changes during colonization in the novel environment (e.g. Maron, Vilà, Bommarco, Elmendorf, & Beardsley, 2004; Qing et al., 2011). Favourable traits and mechanisms existing prior to invasion that may convey high aptitude for a particular environmental factor in a new region could result from evolution in the native range either (a) randomly ("drift"), (b) for a different purpose ("exaptation," Gould & Vrba, 1982) or (c) in consequence of selection by this particular environmental factor in the home range ("adaptation"). All these processes together are addressed as "preadaptation" in the present study (Agosta & Klemens, 2008; Pearson, Ortega, Eren, & Hierro, 2018). In fact, one of the most fundamental theories explaining plant invasions initially suggested that species preadapted to colonize a broad range of habitats may be considered "general-purpose-genotypes" (Baker, 1974; Parker, Rodriguez, & Loik, 2003).

Although it has become apparent that species traits alone only partly explain invasion success (Pyšek et al., 2009, 2015; Pyšek & Richardson, 2007), traits associated with high reproductive capacity (e.g. high seed number and seed persistence, short generation time) and vigorous growth (e.g. high specific leaf area and photosynthetic rate) have been shown to increase the likelihood of successful invasions (e.g. Baker, 1974; van Kleunen, Weber, & Fischer, 2010; Moravcová, Pyšek, Jarošík, Havlíčková, & Zákrevský, 2010; Moravcová, Pyšek, Jarošík, & Pergl, 2015; Pyšek & Richardson, 2007; Whitney & Gabler, 2008). In *Centaurea stoebe*, for instance, a higher ploidy level was associated with increased invasive potential, probably due to a broader tolerance of environmental conditions and greater potential to rapidly evolve in the invaded range (Henery et al., 2010; see also Te Beest et al., 2011). Furthermore, invasiveness of species might be also attributable to

high phenotypic plasticity in response to changing environmental conditions (Richards, Bossdorf, Muth, Gurevitch, & Pigliucci, 2006; Ghalambor et al., 2007; Lamarque, Lortie, Porté, & Delzon, 2015), for example, plastic root-foraging due to alterations in nutrient availability (Keser et al., 2015). Accordingly, species might evolve a high phenotypic plasticity after the introduction to a novel range (e.g. Moroney, Rundel, & Sork, 2013) or benefit from preadaptation by exhibiting high phenotypic plasticity already during establishment (e.g. Lamarque et al., 2013).

Beside these intrinsic (functional) plant traits, Curnutt (2000) distinguishes "extrinsic traits" associated with niche space that might preadapt species to establish more easily and to become invasive. For instance, a large native range might imply climatic preadaptation to a wide range of broad-scale abiotic conditions (Kalusová et al., 2017; Pyšek et al., 2009, 2015). It has been shown that invasion success of alien species is positively correlated with the level of climate—or more broadly environmental—matching between native and exotic range (e.g. Ricciardi, Hoopes, Marchetti, & Lockwood, 2013). So far, modelling of alien species distributions has been largely based on climatic variables such as precipitation and temperature (e.g. Ahmad, Khuroo, Hamid, Charles, & Rashid, 2019; Petitpierre et al., 2012; Sheppard, Burns, & Stanley, 2016). While UV-B radiation is another macroclimatic factor that significantly differs at large scales and is subject to human impact, it has been rarely considered a potentially selective environmental filter in plant invasions to date. Notably, some experimental studies already addressed the impact of UV-B radiation on germination or growth of selected invasive species (Beckmann, Hock, Bruelheide, & Erfmeier, 2012; Hock, Beckmann, Hofmann, Bruelheide, & Erfmeier, 2015; Hock, Hofmann, Müller, & Erfmeier, 2019; Qaderi, Yeung, & Reid, 2008; Wang, Ma, Zhang, Siemann, & Zou, 2016).

Northern and southern hemispheres fundamentally differ in overall annual and maximum UV-B levels, in particular, when considering UV-B intensities in temperate regions at comparable latitudes, for example Central Europe and New Zealand representing two major donor and recipient areas of naturalized alien species (Seckmeyer & McKenzie, 1992; Godar, 2007; van Kleunen et al., 2015; Pyšek et al., 2017). UV-B intensities are not simply dependent on latitude and elevation but are also determined by the shorter earth-to-sun distance during the southern hemisphere summer and the higher solar elevation angle yielding in up to twofold higher UV-B intensities in the southern hemisphere compared to the northern one (McKenzie, Aucamp, Bais, Björn, & Ilyas, 2007; McKenzie et al., 2011). Global UV-B differences are thus

a fundamental phenomenon affecting plant life but remain subject to change, as UV-B levels are also influenced by anthropogenic impact, for example tropospheric aerosol emission levels (Watanabe, Takemura, Sudo, Yokohata, & Kawase, 2012). In general, plants respond to elevated UV-B radiation with delayed reproduction, decreased productivity, altered plant architecture and leaf morphology, such as thicker leaves, changes of leaf shape, reduced stem length, increased branching and altered root:shoot ratios (Kataria, Jajoo, & Guruprasad, 2014; Llorens et al., 2015; Robson, Klem, Urban, & Jansen, 2015; Suchar & Robberecht, 2016). At the cellular level, the main targets of biologically effective, high-energy UV-B radiation are nucleic acids, Calvin cycle enzymes and photosystem II proteins, which may result in photosynthesis apparatus damage (Kataria et al., 2014). Even though detrimental UV-B effects on plants have been comprehensively studied at the autecological level, this factor has been largely neglected as a potentially selective force for plant invasions.

To assess the relevance of UV-B radiation for plant invasions in high-UV-B environments, the present study aims at revealing whether the species' response to UV-B is driven by plant traits, climatic preadaptation acquired in the species' native range and the UV-B history in the native range. This approach is based on the assumption that functional preadaptation by plant traits and/or climatic preadaptation associated with species distribution and/or native UV-B niche characteristics might be important for species during colonization of high-UV-B environments. To test for potential preadaptation, plant performance has to be compared in the native and exotic ranges (Schlaepfer, Glaettli, Fischer, & van Kleunen, 2010). Ideally, plant responses to UV-B radiation should be studied under natural radiation conditions characterized by a typical relation of photosynthetically active radiation (PAR), UV-A and UV-B (Kuhlmann & Müller, 2011). Closely associated with UV-B, in particular, UV-A radiation is known for its mitigating effect under abiotic stress conditions (e.g. high UV B, drought), as it induces protective responses of the photosynthetic apparatus and therefore increases physiological resilience (Escobar-Bravo, Klinkhamer, & Leiss, 2017; Štroch et al., 2015; Verdagner, Jansen, Llorens, Morales, & Neugart, 2017). Furthermore, the differences in the level of UV radiation between native and exotic ranges allow disentangling the effect of UV radiation on plant growth and development in the context of the local environments (Hock et al., 2019).

In two common garden experiments, we studied the role of preadaptation to UV-B radiation on 25 herbaceous species from open habitats and eleven families, both in the native northern hemisphere (Central Europe) and the invaded southern hemisphere (New Zealand). We established an UV radiation gradient in both common gardens to directly test for plant responses to this abiotic factor. We tested for preadaptation to elevated UV-B levels and addressed the following hypotheses: (a) Functional preadaptation to UV-B is modulated by functional plant traits. (b) Native range (UV-B) characteristics serve as suitable proxies for climatic preadaptation to high-UV-B environments. (c) Plant responses to the applied UV treatments within both common gardens are additionally reflected

in the differences between the experimental sites Germany and New Zealand due to the existing differences in natural UV-B intensity between hemispheres. To our knowledge, this is the first study addressing preadaptation of alien species to elevated UV-B levels via multi-species common garden experiments in the native and invaded range.

2 | METHODS

2.1 | Experimental data

We conducted two multi-species common garden experiments in the native European range (Germany) and in the invaded range (New Zealand). In Germany, the experiment took place at the Botanical Garden of Kiel University (EPSG:3857 coordinates: N54.34583°, E10.11632°) during the northern hemisphere summer season 2015 (July–October), whereas the New Zealand common garden was established at Lincoln University (EPSG:3857 coordinates: S43.64506°, E172.4620°) and ran during the southern hemisphere summer season 2014/2015 (December–March). Common garden experiments are especially suitable to control for phenotypic plasticity effects and to consequently assess genetic differentiation and local adaptation of genotypes within species in a common environment (Kawecki & Ebert, 2004; Villemereuil, Gaggiotti, Mouterde, & Till-Bottraud, 2016). In the present study, the northern and southern hemisphere common gardens furthermore allowed investigating the impact of the naturally diverging environmental factor UV-B radiation on genotypes in an otherwise standardized environment to determine the UV-B preadaptation of this genotype (see “home vs. away” in Kawecki & Ebert, 2004).

In total, 25 herbaceous plant species were included in each experiment ($n = 751$ individuals), all native to Europe and naturalized in New Zealand (Allan Herbarium, 2000; Howell & Sawyer, 2006). Since we were interested in the role of preadaptation acquired in the species' native range, only seed material from the native Northern hemisphere was used for all species, resulting in 377 plant individuals tested in the German common garden and 374 in the New Zealand common garden. Seeds were either obtained from commercial seed companies or botanical gardens in 2014, and under similar conditions grown in both common gardens (see Table 1 for species list and seed origin information). We especially ensured that all seeds derived from outdoor populations, as growth and reproduction under natural radiation is the basic requirement for adaptation to UV radiation. All individuals were germinated in the greenhouse under controlled conditions in seedling trays and transferred to pots (2 litre) about 6–8 weeks later. Subsequently, 10-week old plants were assigned to experimental treatments.

In both common gardens, the plants were exposed to three UV treatments, including (a) full exposure to ambient, that is, natural UV-A and UV-B radiation (+UV-A/+UV-B), (b) exclusion of UV-B while allowing natural UV-A (+UV-A/-UV-B), and (c) total exclusion of both UV-A and UV-B wavelengths (-UV-A/-UV-B). To apply these

TABLE 1 Species list, seed origin information and species-specific experimental duration in the New Zealand and German common garden experiments, respectively. All species are listed as “naturalized” in New Zealand (Allan Herbarium, 2000; Howell & Sawyer, 2006)

Species	Family	Experimental duration [d]		Source	Year of collection	Location
		NZ	DE			
<i>Antirrhinum majus</i>	Scrophulariaceae	75	72	Botanical Gardens of MLU, Halle	2014	Halle, Sachsen-Anhalt
<i>Artemisia absinthium</i>	Asteraceae	102	75	Botanical Gardens of MLU, Halle	2013	Halle, Sachsen-Anhalt
<i>Aurinia saxatilis</i>	Brassicaceae	104	74	Botanical Gardens of MLU, Halle	2013	Halle, Sachsen-Anhalt
<i>Centranthus ruber</i>	Valerianaceae	73	73	Botanical Gardens of MLU, Halle	2012	Halle, Sachsen-Anhalt
<i>Cerintho major</i>	Boraginaceae	75	72	Saatgut-Vielfalt	2013	Unspecified ^a
<i>Cichorium intybus</i>	Asteraceae	103	72	Botanical Gardens of MLU, Halle	2013	Wormsleben, Sachsen-Anhalt
<i>Dianthus barbatus</i>	Caryophyllaceae	109	76	Botanical Gardens of MLU, Halle	2013	Halle, Sachsen-Anhalt
<i>Diploxys muralis</i>	Brassicaceae	73	75	Botanical Gardens of MLU, Halle	2012	Halle, Sachsen-Anhalt
<i>Inula helenium</i>	Asteraceae	107	71	Botanical Gardens of MLU, Halle	2013	Halle, Sachsen-Anhalt
<i>Leontodon autumnalis</i>	Asteraceae	77	73	Rieger-Hofmann® GmbH	2013	Unspecified ^a
<i>Linaria purpurea</i>	Scrophulariaceae	77	76	Botanical Gardens of MLU, Halle	2014	Friedeburg, Sachsen-Anhalt
<i>Lobularia maritima</i>	Brassicaceae	73	77	Saatgut-Vielfalt	2013	Unspecified ^a
<i>Malva neglecta</i>	Malvaceae	77	75	Botanical Gardens of MLU, Halle	2011	Luckau, Brandenburg
<i>Origanum vulgare</i>	Lamiaceae	78	77	Rieger-Hofmann® GmbH	2013	unspecified ^a
<i>Potentilla recta</i>	Rosaceae	103	72	Botanical Gardens of MLU, Halle	2014	Halle, Sachsen-Anhalt
<i>Prunella laciniata</i>	Lamiaceae	110	72	Botanical Gardens of MLU, Halle	2012	Halle, Sachsen-Anhalt
<i>Prunella vulgaris</i>	Lamiaceae	111	75	Botanical Gardens of MLU, Halle	2013	Halle, Sachsen-Anhalt
<i>Silene dioica</i>	Caryophyllaceae	75	71	Botanical Gardens of MLU, Halle	2012	Halle, Sachsen-Anhalt
<i>Silene latifolia</i>	Caryophyllaceae	74	74	Botanical Gardens of MLU, Halle	2013	Halle, Sachsen-Anhalt
<i>Tanacetum parthenium</i>	Asteraceae	106	75	Botanical Gardens of MLU, Halle	2013	Halle, Sachsen-Anhalt
<i>Tragopogon porrifolius</i>	Asteraceae	104	74	Botanical Gardens of MLU, Halle	2014	Friedeburg, Sachsen-Anhalt
<i>Trifolium medium</i>	Fabaceae	100	75	Rieger-Hofmann® GmbH	2013	Unspecified ^a
<i>Trifolium pratense</i>	Fabaceae	78	73	Botanical Gardens of MLU, Halle	2012	Halle, Sachsen-Anhalt
<i>Trifolium repens</i>	Fabaceae	79	74	Botanical Gardens of MLU, Halle	2012	Halle, Sachsen-Anhalt
<i>Veronica serpyllifolia</i>	Plantaginaceae	77	76	Botanical Gardens of MLU, Halle	2013	Leipzig, Sachsen

^aSeeds purchased by the companies “Saatgut-Vielfalt” and “Rieger-Hofmann® GmbH” originate from outdoor propagation areas in Germany and trace back to regional genotypes from wild populations.

UV treatments to the plants we used 18 experimental units (see Figure S1.1), of which six were equipped with Acrylic (PLEXIGLAS® GS 2,458 clear, Evonik Industries AG), PETG (Polycasa® PETG clear B1, ThyssenKrupp Plastics) or Polycarbonate sheets (Makrolon® GP clear 099, ThyssenKrupp Plastics), respectively. At maximum, one individual of each species was randomly assigned to each experimental unit, resulting in 3–6 replicates per species and treatment. In each experimental unit, about 25 individuals were randomly placed in a grid of 5 × 6 possible pot positions within an area of 1.2 m × 1.5 m. To counteract undesired shading effects of neighbouring plants, we randomly rearranged all individuals within the experimental units every other week. As the experimental units provided full shielding from precipitation, all plants were regularly watered during the experiments.

Plant height and maximum horizontal plant expansion, leaf number, maximum leaf width and maximum leaf length were monitored prior to the start of the experiment and, thereafter, on a monthly basis

and at the harvest date. All individuals were harvested species-wise depending on the species-specific developmental climax, that is, the life-cycle stage of maximum biomass production. Therefore, the species were grown in the common gardens for different periods of time ranging from 73 to 77 days in the German experiment and from 73 to 107 days in the New Zealand experiment (see Table 1). During harvest, aboveground biomass and belowground biomass were separated and dried at 80°C for 48 hr. For each individual, leaf area, specific leaf area (SLA) and leaf dry matter content (LDMC) were determined as leaf functional traits. Depending on the species-specific sizes of the plants, several healthy and fully developed leaves were sampled per individual and traits were quantified based on leaf area, fresh weight and dry weight. These variables were experimentally determined for all 751 individuals in both common garden experiments in response to the different UV environments and served as response variables in the statistical analysis, hereafter indicated by the subscript “ind”. Belowground biomass was determined for all

individuals in the German common garden, but only for 250 individuals in the New Zealand common garden, and thus, not further analysed as response variable.

To characterize climatic conditions at both experimental sites, we used official climate data for Germany from the Climate Data Center of the Deutscher Wetterdienst (DWD, http://www.dwd.de/EN/climate_environment/cdc/cdc.html) and the Federal Office for Radiation Protection (Bfs, www.bfs.de). New Zealand climate data were obtained from the National Climate Database (NIWA, <https://cliflo.niwa.co.nz/>) and the UV Atlas (Version 2.2). During their respective runtimes, both experiments had similar temperature conditions with a maximum temperature of about 30°C but a slightly lower minimum temperature in New Zealand (DE: 4.1–4.7°C, NZ: 2.1°C). Depending on the species-specific experimental runtime, plants experienced in total up to 495 sunshine hours in Germany and 760 hr of sun in New Zealand, resulting on average in one more sunshine hour per experimental day in New Zealand. The mean daily global radiation dose was about twice as high in the New Zealand

experiment compared to the native range common garden. UV-B intensities showed a significant difference between both sites with about 2.5 times higher daily UV-B dose in the New Zealand experiment and, consequently, a maximum UV-B radiation sum of 974 kJ/m² in Germany compared to 3,454 kJ/m². All climate data information with specification of data source and respective measuring stations is listed in supplementary Table S2.1.

2.2 | Species' trait data—functional preadaptation

As plant species traits with the potential to indicate functional preadaptation to UV radiation, we chose plant height, seed dry weight and several functional leaf traits (leaf area, leaf persistence, leaf shape, specific leaf area (SLA), leaf dry matter content (LDMC)). Especially, leaf traits are considered to be strongly responsive to UV-B and are therefore assumed to play a major role in photoprotection abilities of plants (Chen et al., 2013; Robson & Aphalo, 2012;

TABLE 2 Preadaptation indicators: Species traits and biogeographic (i.e. native and exotic range) characteristics used to test for functional preadaptation and for climatic preadaptation, respectively. Range refers to the raw data range describing the diversity of the investigated species pool

Predictor	Description/calculation	Source of information	Range
Species traits			
SLA _{spec} [m ² /kg]	Specific leaf area (leaf area/leaf dry weight)	Experimental data	7.75–30.74
LDMC _{spec} [%]	Leaf dry matter content (leaf dry weight/ leaf fresh weight)	Experimental data	12.96–34.08
Leaf area [cm ²]		Experimental data	0.59–116.46
Leaf shape	2 levels: simple versus pinnate/small	Personal observation	factorial
Leaf persistence	2 levels: persistent versus short-lived (during summer or over-wintering)	TRY database ^{1–6}	factorial
Seed dry weight [mg]		TRY database ^{1–19}	0.05–50.40
Plant height _{spec} [cm]		Experimental data	8.67–55.17
Biogeographic characteristics			
Native range size [grid cells]	Number of native gIUV grid cells	GRIN/KEW native range information	13–4916
Exotic range size [regions]	Number of exotic GloNAF regions	GloNAF information	2–211
Expansion index	= exotic range size/ native range size based on respective gIUV grid cell numbers	GRIN/KEW native range information, GloNAF information	0.005–83.563
Native UV-B niche maximum [J m ⁻² day ⁻¹]	Native range maximum of mean UV-B of the highest month	gIUV (UVB3)	5457–10221
Native UV-B niche mean [J m ⁻² day ⁻¹]	Native range mean of sum of monthly mean UV-B during highest quarter (summer)	gIUV (UVB5)	8804–14763
Native UV-B niche width [J m ⁻² day ⁻¹]	= native range maximum sum of monthly mean UV-B during highest quarter (summer) - native range minimum sum of monthly mean UV-B during highest quarter (summer)	gIUV (UVB5)	2098–25053
UV-B novelty index	= exotic range annual mean UV-B/ native range annual mean UV-B	gIUV (UVB1)	0.57–1.44

Note: TRY data set references: ¹Kühn, Durka, and Klotz (2004), ²Kleyer et al. (2008), ³Campetella et al. (2011), ⁴Gachet, Véla, and Taton (2005), ⁵Green (2009), ⁶Royal Botanical Gardens KEW (2008), ⁷Wright et al. (2004), ⁸Fitter and Peat (1994), ⁹Kirkup, Malcolm, Christian, and Paton (2005), ¹⁰Meziane and Shipley (1999), ¹¹Dainese and Bragazza (2012), ¹²Hickler (1999), ¹³Garnier et al. (2007), ¹⁴Everwand, Fry, Eggers, and Manning (2014), ¹⁵Hill, Preston, and Roy (2004), ¹⁶Fry, Power, and Manning (2014), ¹⁷Shipley and Vu (2002), ¹⁸Kattge, Knorr, Raddatz, and Wirth (2009), and ¹⁹Reich, Oleksyn, and Wright (2009).

Václavík, Beckmann, Cord, & Bindewald, 2017). Plant height and seed dry weight were further included, as they correlate with plant fitness and reproduction strategies, but also differ among life forms (He, Zhang, & Dong, 2004). To characterize each of the 25 species included in the experimental species pool of both common garden experiments, we used a subset of some experimental response variables from the native common garden experiment to calculate species-specific mean trait values, hereafter indicated by the subscript “spec.” In general, we considered the full UV exclusion treatment in the native common garden as a reference to derive baseline information on species-specific traits. We thus calculated plant height_{spec}, leaf area, SLA_{spec} and LDMC_{spec} from the experimental performance data as species-specific trait mean of all individuals in the German experiment under full UV exclusion conditions. Additionally, seed dry weight and leaf persistence data of all 25 species were obtained from the Plant Trait Database TRY (Kattge et al., 2011). Leaf shape was identified and assigned to categories by visual inspection. Thus, for all eight species traits 25 species-specific values were derived from different sources and served as predictors in the statistical analysis. Information about all traits used in the analyses and the respective data source is summarized in Table 2.

2.3 | Biogeographic characteristics—climatic preadaptation

We defined biogeographic characteristics for our study species, to depict species’ native distribution patterns and the resulting native

UV-B niche as proxies for a general preadaptation to a broad range of abiotic conditions or even direct UV-B preadaptation. For all study species, occurrence data were requested from the Global Biodiversity Information Facility database (GBIF, available from: <https://www.gbif.org/>, see Table S3.2 for list of obtained data sets) in June 2017 via R (Version 3.5.3, R Core Team, 2019) using the function “occ_search” (package “rgbif,” Chamberlain et al., 2019; Chamberlain & Boettinger, 2017) to obtain all occurrences with latitude/longitude reference (“hasCoordinate = TRUE”) and without spatial issues (“hasGeospatialIssue = FALSE”). The Global Naturalized Alien Flora (GloNAF, <https://glonaf.org/>) provided information about the naturalized range of all study species based their distribution in 843 GloNAF regions; only species reported as naturalized in the invaded range (following the definition of Blackburn et al., 2011; Richardson et al., 2000) are included in the database (van Kleunen et al., 2015, 2019; Pyšek et al., 2017). Additional information about the native range was obtained from the Germplasm Resource Information Network (GRIN, <https://www.grin-global.org/>) and Kew World Checklist (<http://apps.kew.org/wcsp/home.do>) based on the World Geographical Scheme for Recording Plant Distributions developed by the international Biodiversity Information Standards (TDWG, <http://www.tdwg.org/>). Subsequently, we merged species distribution data with TDWG/GloNAF information by a spatial overlay of shapefiles using the function “over” in R (package “sp,” Bivand, Pebesma, & Gomez-Rubio, 2013; Pebesma & Bivand, 2005) to assign status information (native, exotic) to each GBIF species occurrence. Occurrence-specific information on UV-B characteristics was added by

TABLE 3 Significance table of model selection analysis—significance levels ($p < .001$ ***, $p < .01$ **, $p < .05$ *) are given for effects of the experimental main factors Exp = experimental site (DE versus. NZ), UV = UV treatment (+UV-A|+UV-B versus. +UV-A|-UV-B versus. -UV-A|-UV-B), their interaction, exp. dur. = experimental duration, the biogeographic characteristics in interaction with “Exp” and “UV,” and the (functional) plant traits in interaction with “Exp” and “UV” on the experimental response variables. Terms dropped during model selection are marked in dark grey, and all remaining terms of the final model are marked in light grey

Experimental response	Exp. predictors				Climatic preadaptation indicators/ interactions											
	Exp	UV	Exp:UV	exp. dur.	Nat. range		Ex. range		Expansion		UVB max		UVB mean		UVB width	
					Exp	UV	Exp	UV	Exp	UV	Exp	UV	Exp	UV	Exp	UV
Abovegr. biomass		**					*	*					**			**
Plant height _{ind}				***	*											
Max. expansion		***		**	***						*			***		*
Leaf number	***			***	**		***				**		*		***	**
Max. leaf length	***	*							**				*			
Max. leaf width	*	*														
SLA _{ind}	***	*					***		***		***		***		***	
LDMC _{ind}	*	*					**		*		**			*		***

Note: Climatic and functional “preadaptation indicators”: Nat. range = native range size, Ex. range = exotic range size, Expansion = expansion index, UVB max = native UV-B niche maximum, UVB mean = native UV-B niche mean, UVB width = native UV-B niche width, Novelty = UV-B novelty index, SLA_{spec} = specific leaf area, LDMC_{spec} = leaf dry matter content, Leaf persist = leaf persistence.

matching (function “extract,” package “raster,” Hijmans, 2019) species’ occurrence data with global UV-B satellite data with a spatial resolution of 15 arc-minutes (glUV, Beckmann et al., 2014).

From the merged occurrence data, we calculated the following biogeographic characteristics of exotic and native range that are supposed to be indicative for climatic preadaptation: native range size, exotic range size, native UV-B niche maximum, native UV-B niche mean, and native UV-B niche width (Table 2). We calculated two indices: (a) “Expansion index” describes the exotic range size in relation to the native range size as an indicator for species’ ability to spread extensively beyond their native range. (b) “UV-B novelty index” indicates whether, and to what degree, UV-B intensity level in the exotic range is higher than in the native range and consequently represents a novel environmental factor. The “UV-B novelty index” is calculated as the ratio of the exotic range annual mean UV-B and the native range annual mean UV-B (for detailed description of indices see Table 2).

2.4 | Statistical analysis

As we were not interested in species-specific differences, but overall effects across the entire species pool, we standardized all experimental response variables within species by z-transformation and analysed the resulting z-scores. The standardization of absolute changes in response variables (raw scores) results in a comparable expression of the within-species response to different environments as number of species-specific standard deviations (z-scores)

and thus accounts for absolute species-inherent differences. Thus, we jointly analysed the experimental plant responses of all 751 individuals of 25 different species from both common garden experiments in Germany and New Zealand. While the experimental data derived at the individual level (subscript “ind”) served as response variables, species distribution data and functional trait data obtained at the species level (subscript “spec”) were considered as species-specific traits that potentially promote alien species spread to high-UV-B environments and thus may be considered as “preadaptation indicators.” These “preadaptation indicators” could either be plant (functional) traits or biogeographic characteristics associated with species distribution patterns and the respective native UV-B niche (Table 2).

To identify preadaptation, we tested for significant effects of “preadaptation indicators” on experimental response variables in different UV environments. For best models identification, the “step” function (package: “lmerTest”) was applied to linear mixed models (function “lmer,” package: “lmerTest”) in R (Version 3.5.3, R Core Team, 2019). “Step” performs automatic backward elimination of effects of linear mixed effect models one at a time. Elimination of the fixed part is done by the principle of marginality, that is, the highest order interactions are tested first and if significant, the lower order effects are not tested for significance (according to “lmerTest” package description, Kuznetsova, Brockhoff, & Christensen, 2017).

Prior to model selection, we set up the “full models” to explain our experimental plant response in different UV-B environments: We used the z-scores of our experimental data from both common gardens as response variables to test for effects of “experimental

Functional preadaptation indicators/ interactions															
Novelty		SLA _{spec}		LDMC _{spec}		Leaf area		Leaf persist		Leaf shape		Seed mass		Plant height _{spec}	
Exp	UV	Exp	UV	Exp	UV	Exp	UV	Exp	UV	Exp	UV	Exp	UV	Exp	UV
*	*			*		***		**	*			***			
						**	***					***		*	
							*							***	
		***												**	**
		**	*	**								**			

TABLE 4 Fixed-effect results of final mixed-model analysis. Degrees of freedom (df_N = numerator, df_D = denominator), F -statistics (F) and significance values (p) are provided for all remaining predictors after model selection. For random effect results, see Table S5.4

Predictor	Aboveground biomass			Plant height			Max. plant expansion			Leaf number									
	df_N	df_D	p	F	df_D	p	Predictor	df_N	df_D	p	Predictor	df_N	df_D	F	p				
Exp	1	33.5	1.272	.268	Exp	1	43.6	0.343	.561	Exp	1	42.4	1.624	.210	34.7	15.239	<.001***		
UV	2	672.3	5.871	.003**	UV	2	692.6	0.703	.495	UV	2	682.9	8.137	<.001***	2	31.9	1.676	.203	
Exp: UV	2	103.8	1.447	.240	Exp: UV	2	692.6	0.684	.505	Exp: UV	2	85.7	0.074	.929	Exp: UV	2	107.8	0.717	.490
exp. duration	1	30.7	1.012	.322	exp. duration	1	41.6	20.437	<.001***	exp. duration	1	41.3	7.824	.008**	exp. duration	1	30.9	28.859	<.001***
Ex. range	1	31.4	0.015	.903	Nat. range	1	43.0	0.678	.415	Nat. range	1	46.0	3.083	.086	Ex. range	1	33.0	0.682	.415
Ex. range: Exp	1	30.2	6.985	.013*	Nat. range: Exp	1	43.4	4.950	.031*	Nat. range: Exp	1	41.2	24.401	<.001***	Ex. range: Exp	1	33.5	24.829	<.001***
LDMC	1	31.7	0.001	.980	Plant height	1	39.7	5.829	.020*	UVB max	1	41.7	1.098	.301	Leaf area	1	29.9	9.576	.004**
LDMC: Exp	1	30.6	6.476	.016*						UVB max: Exp	1	42.6	5.356	.026*	Leaf area: Exp	1	28.4	51.704	<.001***
Leaf area	1	29.3	1.101	.303						UVB mean	1	40.2	0.014	.908	Nat. range	1	38.0	8.088	.007**
Leaf area: Exp	1	31.6	21.258	<.001***						UVB mean: UV	2	667.4	7.416	<.001***	Plant height	1	32.7	20.931	<.001***
Leaf persist.	1	29.6	0.824	.372						UVB width	1	42.9	1.567	.217	Seed mass	1	30.2	2.937	.097
Leaf persist.: Exp	1	30.8	8.376	.007**						UVB width: UV	2	673.8	3.666	.026*	Seed mass: Exp	1	36.4	28.930	<.001***
Leaf persist.: UV	2	669.0	4.167	.016*										UVB max	1	38.7	12.600	.001**	
Nat. range	1	33.7	2.979	.094										UVB mean	1	34.7	5.835	.021*	
Nat. range: UV	2	671.7	3.842	.022*										UVB width	1	39.8	14.034	<.001***	
Novelty	1	28.5	0.063	.804										UVB width: Exp	1	36.0	11.317	.002**	
Novelty: Exp	1	31.0	4.375	.045*															
Novelty: UV	2	668.5	3.990	.019*															
Seed mass	1	29.2	0.207	.653															
Seed mass: Exp	1	28.5	20.314	<.001***															
UVB max	1	31.3	0.501	.484															
UVB max: UV	2	670.1	4.772	.009**															
UVB width	1	32.1	1.186	.284															
UVB width: UV	2	671.8	5.172	.006**															

(Continues)

TABLE 4 (Continued)

Max. leaf length				Max. leaf width				Specific leaf area				Leaf dry matter content				
Predictor	df _N	df _D	p	F	df _N	df _D	p	F	df _N	df _D	p	F	df _N	df _D	p	
Exp	1	43.2	<.001***	38.532	1	45.7	.034*	4.753	1	24.0	<.001***	22.412	1	23.6	5.159	.033*
UV	2	683.6	.027*	3.619	2	22.9	.045*	3.576	2	24.3	.017*	4.819	2	666.7	4.486	.012*
Exp: UV	2	24.1	.334	1.150	2	29.6	.210	1.645	2	90.6	.873	0.137	2	20.4	0.190	.828
exp. duration	1	39.3	.141	2.254	1	39.2	.561	0.344	1	27.9	.723	0.128	1	23.6	1.759	.197
exp. duration																
Expansion	1	35.1	.789	0.073	1	39.1	.880	0.023	1	28.8	.915	0.012	1	27.3	0.671	.420
Leaf area																
Expansion: UV	2	659.7	.008**	4.891	1	41.4	.022*	5.692	1	30.0	<.001***	18.851	1	27.7	9.050	.006**
Leaf area: Exp																
Leaf shape	1	40.9	.904	0.015	1	40.9	.904	0.015	1	23.4	.470	0.539	1	22.2	0.024	.879
Expansion																
Leaf shape: Exp	1	41.3	<.001***	19.894	1	24.1	<.001***	29.735	1	24.1	<.001***	29.735	1	21.9	7.899	.010*
Expansion: Exp																
UVB mean	1	37.1	.768	0.088	1	37.1	.768	0.088	1	25.4	.213	1.631	1	26.1	1.007	.325
Leaf shape																
UVB mean: UV	2	1.0	.041*	3.199	1	26.1	.006**	9.105	1	26.1	.006**	9.105	1	25.4	9.295	.005**
Leaf shape: Exp																
Plant height	1	25.6	.746	0.107	1	25.6	.746	0.107	1	25.6	.746	0.107	1	23.1	0.086	.772
Seed mass																
Plant height: Exp	1	26.6	.001**	13.529	1	26.6	.001**	13.529	1	26.6	.001**	13.529	1	22.4	13.530	.001**
Seed mass: Exp																
SLA	1	23.1	.556	0.356	1	23.1	.556	0.356	1	23.1	.556	0.356	1	23.7	0.171	.683
SLA: Exp																
SLA: Exp	1	23.4	<.001***	25.732	1	23.4	<.001***	25.732	1	23.4	<.001***	25.732	1	23.8	10.885	.003**
UVB max	1	28.4	.481	0.510	1	28.4	.481	0.510	1	28.4	.481	0.510	1	26.1	0.780	.022*
SLA: UV																
UVB max: Exp	1	29.3	<.001***	22.625	1	29.3	<.001***	22.625	1	29.3	<.001***	22.625	1	25.9	10.509	.385
UVB max																
UVB mean	1	28.0	.452	0.581	1	28.0	.452	0.581	1	28.0	.452	0.581	1	23.8	0.213	.004**
UVB max: Exp																
UVB mean: Exp	1	28.9	<.001***	14.127	1	28.9	<.001***	14.127	1	28.9	<.001***	14.127	1	25.4	0.213	.648
UVB mean																
UVB width	1	28.1	.437	0.623	1	28.1	.437	0.623	1	28.1	.437	0.623	1	647.5	4.397	.013*
UVB width: UV																
UVB width: Exp	1	29.0	<.001***	26.088	1	29.0	<.001***	26.088	1	29.0	<.001***	26.088	1	25.8	0.740	.398
UVB width																
UVB width: Exp	1	24.1	<.001***	16.252	1	24.1	<.001***	16.252	1	24.1	<.001***	16.252	1	16.252	16.252	<.001***
UVB width: Exp																

site" (DE, NZ), "UV treatment" (-UV-A|-UV-B, +UV-A|-UV-B, +UV-A|+UV-B) and all 14 "preadaptation indicators." We also included the interaction effect of "UV treatment" and "experimental site." For each "preadaptation indicator," also the interaction effects with "experimental site" and with "UV treatment," respectively, were considered to particularly test for the importance of species characteristics on plant performance in different UV environments displayed by either global UV intensity differences between Germany and New Zealand or the different UV treatments applied within the experimental sites. Consequently, the "full model" contained 45 fixed (interaction) effects and we additionally included "day of harvest" as covariate to consider species-specific differences in experimental duration. Furthermore, we defined five nested random effects to correct for the block effect of UV treatment units ("unit") and for identity effects of species or family: "unit \times experimental site," "unit \times UV treatment," "species \times experimental site," "species \times UV treatment" and "family \times species." We applied a model selection to the full model but strictly kept "experimental site," "UV treatment" and their interaction as well as "day of harvest" by definition in the final model. Interaction plots provide predicted values of z-scores obtained by the function "Effect" from package "effects" (Fox & Weisberg, 2019).

3 | RESULTS

3.1 | Effects of "UV treatment" and "experimental site" on plant performance

Aboveground biomass ($p = .003$) and maximum horizontal plant expansion ($p < .001$, see Tables 3 and 4) were significantly reduced by the presence of UV-A and/or UV-B radiation. We found a significantly reduced maximum leaf length ($p = .027$), maximum leaf width ($p = .045$) and specific leaf area_{ind} ($p = .017$) under full solar radiation compared to the filter treatments in both experiments. In contrast, leaf dry matter content_{ind} was highest in presence of UV-B radiation ($p = .012$). Plants in the New Zealand experiment produced more leaves ($p < .001$) than individuals in the German common garden. Maximum leaf length ($p < .001$) and width ($p = .034$), as well as specific leaf area_{ind} ($p < .001$) were lower in the New Zealand experiment compared to the German common garden. Leaf dry matter content_{ind} was significantly higher in the New Zealand common garden than in the German experiment ($p = .033$). We did not observe any significant interaction effects of "experimental site" and "UV treatment" among all response variables.

3.2 | Interaction effects of "preadaptation indicators" with "UV treatment" and "experimental site"

Regarding the study aim to identify suitable traits in the context of appropriate preadaptation to high-UV-B environments, corresponding interaction effects of preadaptation indicators with the

experimental predictors "UV treatment" and "experimental site"—both representing different UV-B environments—are most interesting and will be described and discussed in the following.

3.2.1 | i) Species' traits—functional preadaptation

Leaf persistence displayed significant interaction effects with UV and the experimental site (see Tables 3 and 4): Species with persistent leaves showed higher aboveground biomass in the presence of UV-B radiation than species with short-lived leaves ($p = .016$, Figure 1a). A similar effect of leaf persistence on aboveground biomass was found in the New Zealand experiment compared to the German common garden ($p = .007$, Figure 1b). In the presence of UV-B radiation species with higher specific leaf area_{spec} responded with a stronger increase in LDMC_{ind}, whereas at reduced levels of UV there was a negative relationship between SLA_{spec} and LDMC_{ind} ($p = .022$, Figure 1c). Those species also showed higher LDMC_{ind} in the New Zealand experiment ($p = .003$, Figure 1d). All other plant traits showed no interaction effects with "UV treatment."

3.2.2 | ii) Biogeographic characteristics—climatic preadaptation

Six of the seven biogeographic characteristics showed significant interactions with "UV treatment" on the experimental response variables. Among them, especially the native UV-B niche mean turned out to be most important for three response variables. Across response variables, aboveground biomass was the most responsive to the biogeographic characteristics (Tables 3 and 4).

Species experiencing a much higher UV-B intensity in the exotic than in the native range (high "UV-B novelty index") showed a higher aboveground biomass in the UV-B exposure treatment ($p = .019$, Figure 2a) and, regardless of the UV treatments, were more productive in the New Zealand common garden than in the German one ($p = .045$, Figure 2b). Under UV-B radiation aboveground biomass showed a negative relationship with the species' native range UV-B niche width ($p = .006$), but a positive relationship with native range maximum UV-B of the highest month ($p = .009$). In the presence of UV-B radiation higher aboveground biomass was achieved by species with larger native range size ($p = .022$, Figure 2c). A strong positive relationship between the native UV-B niche mean and leaf dry matter content was observed in presence of UV-B ($p = .013$, Figure 2d). Higher native range mean UV-B intensity of the highest quarter ($p < .001$, Figure 3a) was significantly linked to an increase in maximum horizontal plant expansion in an UV-B environment. The general decrease of maximum horizontal plant expansion with native range UV-B niche width was lowest in presence of UV-B radiation ($p = .026$, Figure 3b). Compared to the full UV exposure

(+UV-A|+UV-B) and full UV exclusion (-UV-A|-UV-B), in the "UV-A only" treatment (+UVA|-UVB) maximum leaf length and native range mean UV-B intensity of the highest quarter showed a negative relationship ($p = .041$, Figure 3c). Leaves were significantly reduced in size in response to UV-B radiation with increasing "expansion index" of a species ($p = .008$, Figure 3d).

Furthermore, the statistical analysis revealed several other significant interactions of "preadaptation indicators" with "experimental site," which are not being discussed in the following. These interactions showed no evidence for a corresponding interaction effect of "preadaptation indicator" with "UV treatment" and, therefore, are likely to arise from UV-independent differences between Germany and New Zealand (see Tables 3 and 4).

4 | DISCUSSION

4.1 | Plant performance in different UV environments

The present study allows to assess the effects of UV radiation at two scales—within and between the two experimental sites—as the three UV treatments were applied in both experiments. The UV treatments significantly affected productivity, plant architecture and leaf traits, and allowed for the comparison of ambient solar radiation with two artificial UV environments to disentangle the ecologically inseparable effects of UV-A and UV-B. Most differences in plant responses occurred from presence/absence of UV-B radiation; however, a few significant "UV treatment" effects highlight the additional impact of UV-A radiation. The "UV-A only" treatment (+UV-A|-UV-B) mostly caused plant responses with absolute values between the "full solar radiation" level (+UV-A|+UV-B) and the "full UV exclusion" level (-UV-A|-UV-B). UV-A radiation is less detrimental for plant metabolism and has been even associated with a not fully understood mitigation effect in combination with UV-B in previous studies (Verdaguer et al., 2017).

Aboveground biomass, maximum horizontal plant expansion, maximum leaf length and leaf width were significantly lower in the presence of UV-B radiation, as previously shown in several studies (e.g. Bacelar, Moutinho-Pereira, Ferreira, & Correia, 2015; Hock et al., 2019; Robson et al., 2015; Suchar & Robberecht, 2014). Leaves exposed to full solar radiation were overall characterized by reduced specific leaf area but increased leaf dry matter content. Decreased UV-B sensitivity of smaller and thicker leaves has been repeatedly described for several plant species, due to UV-B shielding of the upper cell layers and a consequently better protected photosynthetic apparatus in the subjacent leaf tissue (e.g. Chen et al., 2016; Qaderi et al., 2008; Robson & Aphalo, 2012).

Higher leaf number of plants in the New Zealand experiment either indicates a generally more productive environment in comparison to the German common garden (see Hock et al., 2019) or a functional response to different environmental conditions that could

not be controlled for in the experiments. Such differences might be a result of several biotic and abiotic factors, most notably those related to higher temperature or more sunshine hours, but might also derive from altered biotic interactions. However, in line with the effects of the UV treatments, individuals in the New Zealand experiment showed significantly reduced maximum leaf length, maximum leaf width and specific leaf area_{ind}, accompanied by higher leaf dry matter content_{ind}, very likely due to higher UV-B intensities in the southern hemisphere common garden. These results highlight the significance of prevailing differences in global UV intensity between native and exotic ranges of the plant species studied (Beckmann et al., 2012; Hock et al., 2019).

Although it is most notable that these effects were consistent across multiple species and regions with different overall UV radiation intensity, UV radiation appears to similarly affect plant performance in both common garden experiments, as we did not find any significant interaction effects of "UV treatment" and "experimental site." However, if the overall effect of UV-B radiation is similar by trend independent of the region but different in the intensity, it may hold that preadaptation to UV-B radiation can significantly pay-off for invasion success of species and help explaining the differences between successful colonization and invasion failure (see Gallien, Thornhill, Zurell, Miller, & Richardson, 2019). Admittedly, we cannot directly relate the experimentally determined plant performance under UV-B exposure to the invasive potential of the study species in high-UV-B environments (see Table S4.3). The artificial experimental settings in both common gardens do not display the complex interplay of biotic and abiotic factors under natural conditions. Nevertheless, UV-B preadaptation might be one important factor during species colonization of high-UV-B environments and, thus, may be worth to be additionally considered in future risk assessment.

4.2 | Evidence for functional preadaptation to high-UV-B environments

We found only little evidence for preadaptation at the functional plant trait level of the studied species to UV-B. Interestingly, leaf persistence and specific leaf area_{spec} were important for plant responses to UV-B radiation and the respective effects indicate the fundamental role in the photoprotection measures of leaves. Our study revealed a general advantage of plant species with persistent leaves under UV-B exposure, whereas species with short-lived leaves experienced a pronounced aboveground biomass reduction under these conditions. This effect confirms preliminary findings of generally more efficient photoprotection in persistent leaves due to a higher investment in structures and mechanisms to avoid photodamage by high-energy UV radiation (Mason & Donovan, 2015; Wright et al., 2004). Higher leaf dry matter content_{ind} in response to UV-B indicates denser multilayered leaf tissue with higher resilience to photodamage (Bacelar et al., 2015; Hock et al., 2019; Robson et al., 2015). At the global level, high irradiance environments are usually characterized by plants with

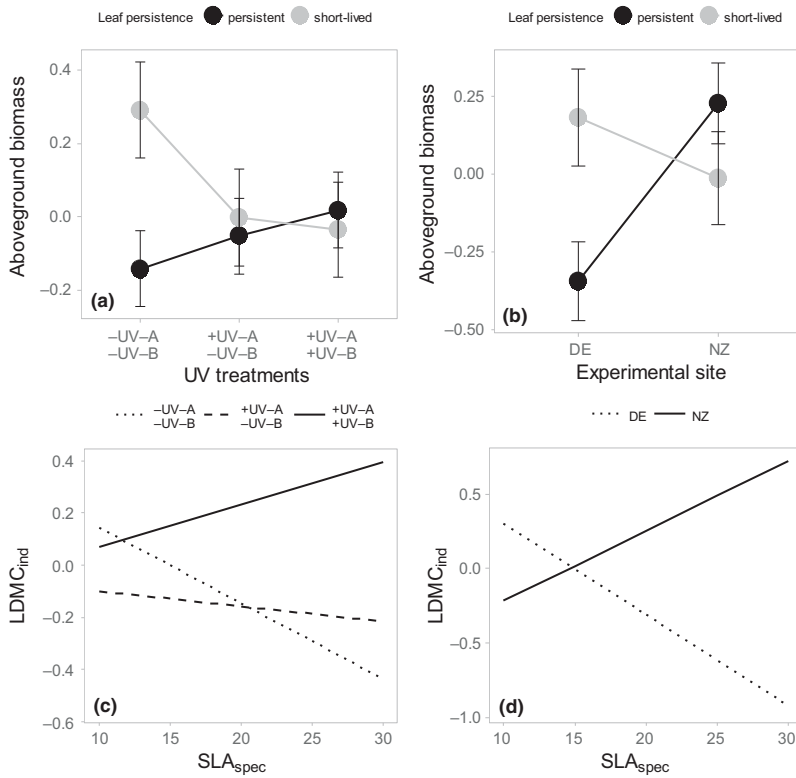

FIGURE 1 (a-d): Test for functional preadaptation: Reaction norms for aboveground biomass of species with persistent leaves (black) and species with short-lived leaves (grey) (a) across the different UV treatments and (b) across the experimental sites Germany (DE) and New Zealand (NZ); effects of species-specific specific leaf area (SLA_{spec} , [m^2/kg]) on leaf dry matter content ($LDMC_{ind}$) (c) across the different UV treatments and (d) across the experimental sites Germany (DE) and New Zealand (NZ). Predicted values of z-scores ($\pm SE$) from the respective full statistical model identified by model selection are shown for experimentally determined dependent variables

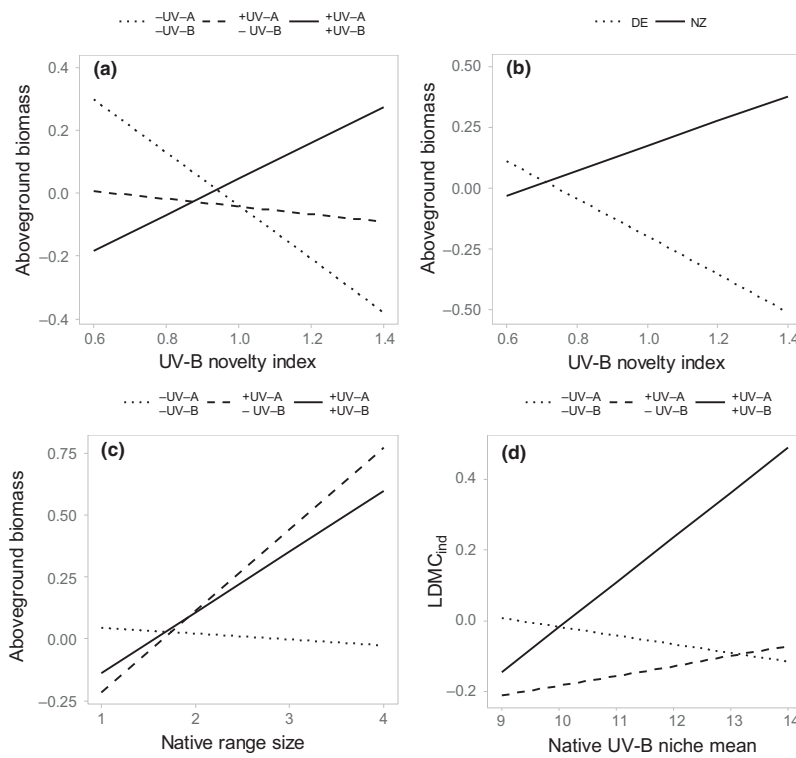
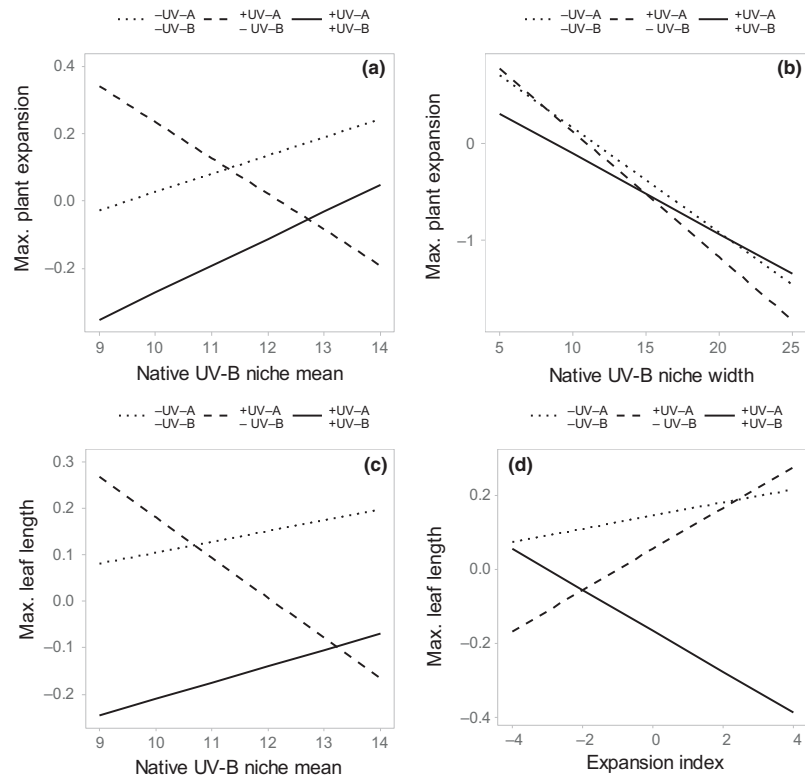

FIGURE 2 (a-d): Test for climatic preadaptation: Effects of the "UV-B novelty index" on aboveground biomass (a) across the different UV treatments and (b) across the experimental sites Germany (DE) and New Zealand (NZ); effects of (c) the native range size on aboveground biomass and (d) the native UV-B niche mean [$kJ m^{-2} day^{-1}$] on leaf dry matter content ($LDMC_{ind}$) across the different UV treatments. Predicted values of z-scores from the respective full statistical model identified by model selection are shown for experimentally determined dependent variables

FIGURE 3 (a-d): Test for climatic preadaptation: Effects of (a) the native UV-B niche mean on maximum [$\text{kJ m}^{-2} \text{day}^{-1}$] horizontal plant expansion, (b) the native UV-B niche width [$\text{kJ m}^{-2} \text{day}^{-1}$] on maximum horizontal plant expansion, (c) the native UV-B niche mean [$\text{kJ m}^{-2} \text{day}^{-1}$] on maximum leaf length, and (d) the “expansion index” on maximum leaf length across the different UV treatments. Predicted values of z-scores from the respective full statistical model identified by model selection are shown for experimentally determined dependent variables



lower SLA and higher LDMC (Yang et al., 2019). In our study, this classical trade-off of SLA and LDMC in the leaf economics spectrum was confirmed under UV exclusion at both experimental sites (Poorter & Garnier, 1999). However, only in the presence of UV-B radiation, we observed a positive relationship of specific leaf area_{spec} with leaf dry matter content_{ind}, thereby indicating that an increase of leaf tissue density took place to a greater extent in large-SLA_{spec} leaves when exposed to UV-B (Shipley & Vu, 2002). This effect underlines the widespread occurrence of leaf morphological plasticity in foliar adaptation to high irradiance environments (Niinemets, Kull, & Tenhunen, 1998), and in particular for plant species with a lower SLA. As SLA is a compound trait that is not only responding to the underlying LDMC but is also affected by the light-dependent trait leaf thickness, we infer that the most responsive species under UV-B radiation suffer from photoinhibition due to insufficient leaf thickness and/or leaf tissue density (Hodgson et al., 2011).

Regarding the study aim to identify suitable traits in the context of appropriate preadaptation to high-UV-B environments, especially significant interaction effects of the tested “preadaptation indicators” with “UV treatment” and “experimental site” are of high importance. Interaction effects with “UV treatments” directly point at the importance of respective “preadaptation indicators” for plant performance in particular UV-B environments as applied by the different UV treatments within both experimental sites. Additional corresponding interaction effects of the particular “preadaptation

indicator” with “experimental site” can be ascribed to differences in overall UV-B intensities between Germany and New Zealand, but may also indicate other differences in environmental conditions. Nevertheless, corresponding interaction effects of preadaptation indicators with both experimental predictors representing different UV-B environments are most interesting as they might support the effect of UV filter treatments at a larger scale.

The observed effects of persistent leaves and high specific leaf area_{spec} across the UV treatments were confirmed by the experimental site comparison, as both recur in the “high-UV-B” environment New Zealand. This consistency additionally underpins the importance of the UV-B intensity differences between the experimental sites.

Overall, there was only little evidence of a sufficient preadaptation of our study species to UV-B by functional (leaf) traits. Instead, there rather might be indirect effects of functional leaf traits in terms of facilitating cross-resistance effects in association with other environmental stresses, for example drought or herbivory (Kergunteuil, Descombes, Glauser, Pellissier, & Rasmann, 2018). Herbaceous species of grasslands might be specifically adapted to low water availability or water loss from high transpiration, for example, by smaller leaves with predicted higher UV-B resistance (Bandurska, Niedziela, & Chadzinikolau, 2013). Moreover, leaves equipped with secondary metabolites, for example phenolics, are at the same time resistant to herbivory and photodamage by high-UV-B intensities (Kuhlmann & Müller, 2011).

4.3 | Evidence for climatic preadaptation to high-UV-B environments

Within the tested group of biogeographic characteristics, we can distinguish between traits that may predominantly convey an indirect preadaptation to a broad range of climatic conditions, such as range size and “expansion index,” and traits that may be rather directly associated to already experienced UV-B intensities, such as native range UV-B niche characteristics. In the present study, the latter group of traits appeared to be of greater importance in the context of UV-B preadaptation, as one would expect (Thuiller et al., 2005).

Species with a large native range and experiencing high maximum UV-B intensities in their native ranges produced more biomass in the presence of UV radiation than species with a different native range history (Pyšek et al., 2009). In principle, both indirect and direct preadaptation appeared to prevail in our study species. Against our expectations, species with a wider native UV-B niche did not display a general advantage although it may be likely to indicate higher levels of experienced UV-B intensities in the native range. This effect was probably not observed because using one population per species only can hardly serve as a reference for the entire range of UV-B intensities experienced in the native range. We have to assume that each population in our experiment is rather adapted to the local UV-B conditions of the particular population origin. Interestingly, we found a positive relationship between “UV-B novelty index” and aboveground biomass in UV-B environments, that is, relatively higher exotic than native annual mean UV-B coincided with increased productivity. This unexpected result rather opposed our hypothesis of species being preadapted by native range UV-B intensities and might indicate higher importance of cross-resistance mechanisms in herbaceous species compared to prior UV-B experience. An alternative explanation might be the unsuitability of the preadaptation indicator “UV-B novelty index,” as it is based on the annual mean UV-B intensities of the native and exotic range, that are likely to be not as important for physiological processes in plants as summer mean UV-B intensities or maximum UV-B intensities during the year (see Hideg, Jansen, & Strid, 2013).

The higher “expansion index” (size of exotic range related to native range size) of species affected maximum leaf length only, above all also in negative direction in presence of UV-B, and, therefore, appeared not to be of advantage in high-UV-B environments. On the one hand, this effect might confirm the assumption of higher phenotypic plasticity of alien species with a large exotic range in response to UV-B and the necessity of that particular ability to successfully colonize novel habitats (Oplaat & Verhoeven, 2015; Ruprecht, Fenesi, & Nijs, 2014; Turner, Fréville, & Rieseberg, 2015). On the other hand, a higher “expansion index” could also be the result of a very confined native range that might display a disadvantage in the context of climatic preadaptation to high-UV-B radiation intensity (Pyšek et al., 2009). $LDMC_{ind}$ was the only functional plant response that showed an interaction effect of UV treatments with the tested

biogeographic characteristics. The higher the mean UV-B intensities in their native range, the higher was the $LDMC_{ind}$ under UV-B radiation exposure. As $LDMC$ is known for its ability to respond plastically and its protective effect against high-energy radiation, one could expect a more pronounced response of preadapted species as observed in the experiment (Hock et al., 2019; Robson et al., 2015).

We found further indication for the mitigating effect of UV-A radiation on the growth variables maximum horizontal plant expansion and maximum leaf length. In presence of UV-A radiation only, existing positive relationships between maximum horizontal plant expansion and maximum leaf length with native range mean UV-B intensity were abrogated or even reversed. In consequence, plant species without direct UV-B preadaptation by higher native range mean UV-B intensity profited from UV-A exposure, that is known to stimulate plant growth (Escobar-Bravo et al., 2017; Štroch et al., 2015; Verdaguer et al., 2017). Potentially well-preadapted species, on the other hand, appeared to be disadvantaged by UV-A radiation for any reason. One explanation may be found in well-developed shielding abilities of preadapted species that might also block UV-A wavelength and their facilitative effects on plant growth.

5 | CONCLUSIONS

With regard to UV-B preadaptation, we found strong evidence for the importance of biogeographic characteristics, whereas functional preadaptation by plant traits played a moderate role (see also Chen, Peng, & Yang, 2015). Especially, biogeographic characteristics with a direct link to the native range UV-B niche were crucial for plant responses to UV-B. Our results call for explicitly considering the native UV-B niche as a proxy for species' UV-B tolerance when making species distribution predictions in high-UV environments. Furthermore, our findings support the assumption that high phenotypic plasticity across differing UV-B environments is an important factor that might also affect the performance of alien species. We conclude that explicitly considering UV-B radiation in native and exotic ranges is important for improving the understanding of the factors modulating invasion success and should also be taken into account in models of biological invasions.

ACKNOWLEDGEMENTS

Seed import to New Zealand could be managed via the International Plant Exchange Network (IPEN), handled by E. Grimm (Botanical Garden of Martin Luther University Halle-Wittenberg) and S. Molloy (Christchurch Botanic Gardens). M. Korver (Manaaki Whenua—Landcare Research) realized leaf sample shipping to Germany. We thank L.-M. Beckmann, N. Bieker, K. Borisova, R. Franke, C. Küver, T. Martens, S. Merseburger and L. Watermann for helping with plant monitoring and harvest and M. Bahns (Kiel University) and S. Stilwell (Lincoln University) for technical support. We thank A. Cord and M. Beckmann (Helmholtz Centre for Environmental Research—UFZ) for helpful comments in an early stage of the study and their assistance in processing

of climate data and distribution data in R. We are grateful to the GloNAF core team members for provision of alien plant species distribution data (van Kleunen et al., 2019). The study was supported by the TRY initiative on plant traits (<http://www.try-db.org>). The TRY initiative and database are hosted, developed and maintained by J. Kattge and G. Bönisch (Max Planck Institute for Biogeochemistry, Jena, Germany). TRY is currently supported by DIVERSITAS/Future Earth and the German Centre for Integrative Biodiversity Research (iDiv) Halle-Jena-Leipzig. The study was financially supported by doctoral scholarships from the State Postgraduate Scholarship Programme of Saxony-Anhalt and the FAZIT foundation, as well as a DAAD (German Academic Exchange Service) travel grant awarded to MH. FE appreciates funding by the Austrian Science Foundation FWF (grant I2086-B16). We appreciate the helpful comments of three anonymous reviewers and the handling editor, Marta Carboni, to a previous version of this manuscript.

DATA AVAILABILITY STATEMENT

Plant trait data (TRY) and native/exotic distribution data (GBIF, GloNAF) used in this study were obtained from third parties, either through open access digital repositories or through formal data sharing agreements. The authors do not have permission to distribute these data without explicit consent from its contributors. The experimental data of the two conducted common garden experiments and the used statistical models will be made available via the Dryad Digital Repository <https://doi.org/10.5061/dryad.b5mkkwh9g>.

ORCID

Maria Hock  <https://orcid.org/0000-0001-8401-7309>

Rainer Hofmann  <https://orcid.org/0000-0002-1804-2319>

Franz Essl  <https://orcid.org/0000-0001-8253-2112>

Petr Pyšek  <https://orcid.org/0000-0001-8500-442X>

Helge Bruelheide  <https://orcid.org/0000-0003-3135-0356>

Alexandra Erfmeier  <https://orcid.org/0000-0002-1002-9216>

REFERENCES

- Agosta, S. J., & Klemens, J. A. (2008). Ecological fitting by phenotypically flexible genotypes: Implications for species associations, community assembly and evolution. *Ecology Letters*, *11*(11), 1123–1134. <https://doi.org/10.1111/j.1461-0248.2008.01237.x>
- Ahmad, R., Khuroo, A. A., Hamid, M., Charles, B., & Rashid, I. (2019). Predicting invasion potential and niche dynamics of *Parthenium hysterophorus* (Congress grass) in India under projected climate change. *Biodiversity and Conservation*, *28*, 2319–2344. <https://doi.org/10.1007/s10531-019-01775-y>
- Allan Herbarium (2000). *Ngā Tipu o Aotearoa - New Zealand Plant Names Database*. Landcare Research, New Zealand. Retrieved from <http://nzflora.landcareresearch.co.nz/> (Accessed 30 August 2017).
- Bacelar, E., Moutinho-Pereira, J., Ferreira, H., & Correia, C. (2015). Enhanced ultraviolet-B radiation affect growth, yield and physiological processes on triticale plants. *Procedia Environmental Sciences*, *29*, 219–220. <https://doi.org/10.1016/j.proenv.2015.07.281>
- Baker, H. G. (1974). The evolution of weeds. *Annual Review of Systematics and Evolution*, *5*, 1–24. <https://doi.org/10.1146/annurev.ev.es.05.110174.000245>
- Bandurska, H., Niedziela, J., & Chadzinikolau, T. (2013). Separate and combined responses to water deficit and UV-B radiation. *Plant Science*, *213*, 98–105. <https://doi.org/10.1016/j.plantsci.2013.09.003>
- Beckmann, M., Hock, M., Bruelheide, H., & Erfmeier, A. (2012). The role of UV-B radiation in the invasion of *Hieracium pilosella* – A comparison of German and New Zealand plants. *Environmental and Experimental Botany*, *75*, 173–180. <https://doi.org/10.1016/j.envexpbot.2011.09.010>
- Beckmann, M., Václavík, T., Manceur, A. M., Šprtová, L., von Wehrden, H., Welk, E., & Cord, A. F. (2014). gLUV: A global UV-B radiation dataset for macroecological studies. *Methods in Ecology and Evolution*, *5*, 372–383. <https://doi.org/10.1111/2041-210X.12168>
- Bivand, R. S., Pebesma, E., & Gomez-Rubio, V. (2013). *Applied spatial data analysis with R*, 2nd ed.. New York, NY: Springer.
- Blackburn, T. M., Pyšek, P., Bacher, S., Carlton, J. T., Duncan, R. P., Jarošík, V., ... Richardson, D. M. (2011). A proposed unified framework for biological invasions. *Trends in Ecology and Evolution*, *26*, 333–339. <https://doi.org/10.1016/j.tree.2011.03.023>
- Campetella, G., Botta-Dukát, Z., Wellstein, C., Canullo, R., Gatto, S., Chelli, S., ... Bartha, S. (2011). Patterns of plant trait-environment relationships along a forest succession chronosequence. *Agriculture, Ecosystems & Environment*, *145*(1), 38–48. <https://doi.org/10.1016/j.agee.2011.06.025>
- Chamberlain, S., Barve, V., Mcglinn, D., Oldoni, D., Desmet, P., Geffert, L., & Ram, K. (2019). *rgbif: Interface to the Global Biodiversity Information Facility API*. R package version 1.3.0. Retrieved from <https://CRAN.R-project.org/package=rgbif>
- Chamberlain, S., & Boettiger, C. (2017). R Python, and Ruby clients for GBIF species occurrence data. *PeerJ PrePrints*, *3304v1*, 1–32. <https://doi.org/10.7287/peerj.preprints.3304v1>
- Chen, L., Niu, K., Wu, Y., Geng, Y., Mi, Z., Flynn, D. F., & He, J. S. (2013). UV radiation is the primary factor driving the variation in leaf phenolics across Chinese grasslands. *Ecology and Evolution*, *3*(14), 4696–4710. <https://doi.org/10.1002/ece3.862>
- Chen, L., Peng, S., & Yang, B. (2015). Predicting alien herb invasion with machine learning models: Biogeographical and life-history traits both matter. *Biological Invasions*, *17*(7), 2187–2198. <https://doi.org/10.1007/s10530-015-0870-y>
- Chen, M., Huang, Y., Liu, G., Qin, F., Yang, S., & Xu, X. (2016). Effects of enhanced UV-B radiation on morphology, physiology, biomass, leaf anatomy and ultrastructure in male and female mulberry (*Morus alba*) saplings. *Environmental and Experimental Botany*, *129*, 85–93. <https://doi.org/10.1016/j.envexpbot.2016.03.006>
- Core Team, R. (2019). *R: A language and environment for statistical computing*. Vienna, Austria: R Foundation for Statistical Computing. <https://www.R-project.org/>
- Curnutt, J. L. (2000). Host-area specific climatic-matching: Similarity breeds exotics. *Biological Conservation*, *94*(3), 341–351. [https://doi.org/10.1016/S0006-3207\(99\)00186-X](https://doi.org/10.1016/S0006-3207(99)00186-X)
- Dainese, M., & Bragazza, L. (2012). Plant traits across different habitats of the Italian Alps: A comparative analysis between native and alien species. *Alpine Botany*, *122*(1), 11–21. <https://doi.org/10.1007/s00035-012-0101-4>
- de Villedemereuil, P., Gaggiotti, O. E., Mouterde, M., & Till-Bottraud, I. (2016). Common garden experiments in the genomic era: New perspectives and opportunities. *Heredity*, *116*(3), 249–254. <https://doi.org/10.1038/hdy.2015.93>
- DeWalt, S. J., Denslow, J. S., & Hamrick, J. L. (2004). Biomass allocation, growth, and photosynthesis of genotypes from native and introduced ranges of the tropical shrub *Clidemia hirta*. *Oecologia*, *138*(4), 521–531. <https://doi.org/10.1007/s00442-003-1462-6>
- Dlugosch, K. M., & Parker, I. M. (2007). Molecular and quantitative trait variation across the native range of the invasive species *Hypericum canariense*: Evidence for ancient patterns of colonization via pre-adaptation? *Molecular Ecology*, *16*(20), 4269–4283.

- Elst, E. M., Acharya, K. P., Dar, P. A., Reshi, Z. A., Tufto, J., Nijs, I., & Graae, B. J. (2016). Pre-adaptation or genetic shift after introduction in the invasive species *Impatiens glandulifera*? *Acta Oecologica*, 70, 60–66. <https://doi.org/10.1016/j.actao.2015.12.002>
- Escobar-Bravo, R., Klinkhamer, P. G., & Leiss, K. A. (2017). Interactive effects of UV-B light with abiotic factors on plant growth and chemistry, and their consequences for defense against arthropod herbivores. *Frontiers in Plant Science*, 8, 1–14. <https://doi.org/10.3389/fpls.2017.00278>
- Everwand, G., Fry, E. L., Eggers, T., & Manning, P. (2014). Seasonal variation in the relationship between plant traits and grassland carbon and water fluxes. *Ecosystems*, 17, 1095–1108.
- Fitter, A. H., & Peat, H. J. (1994). The ecological flora database. *Journal of Ecology*, 82, 415–425. <https://doi.org/10.2307/2261309>
- Fox, J., & Weisberg, S. (2019). *An R companion to applied regression*, 3rd ed. Thousand Oaks, CA: Sage.
- Fry, E. L., Power, S. A., & Manning, P. (2014). Trait based classification and manipulation of functional groups in biodiversity-ecosystem function experiments. *Journal of Vegetation Science*, 25, 248–261.
- Gachet, S., Vela, E., & Taton, T. (2005). BASECO: A floristic and ecological database of Mediterranean French flora. *Biodiversity and Conservation*, 14(4), 1023–1034. <https://doi.org/10.1007/s10531-004-8411-5>
- Gallien, L., Thornhill, A. H., Zurell, D., Miller, J. T., & Richardson, D. M. (2019). Global predictors of alien plant establishment success: Combining niche and trait proxies. *Proceedings of the Royal Society B: Biological Sciences*, 286(1897), 20182477. <https://doi.org/10.1098/rspb.2018.2477>
- Garnier, E., Lavorel, S., Ansquer, P., Castro, H., Cruz, P., Dolezal, J., ... Zarovali, M. P. (2007). Assessing the effects of land-use change on plant traits, communities and ecosystem functioning in grasslands: A standardized methodology and lessons from an application to 11 European sites. *Annals of Botany*, 99, 967–985.
- Ghalambor, C. K., McKay, J. K., Carroll, S. P., & Reznick, D. N. (2007). Adaptive versus non-adaptive phenotypic plasticity and the potential for contemporary adaptation in new environments. *Functional Ecology*, 21(3), 394–407. <https://doi.org/10.1111/j.1365-2435.2007.01283.x>
- Godar, D. E. (2007). UV doses worldwide. *Photochemistry and Photobiology*, 81, 736–749. <https://doi.org/10.1111/j.1751-1097.2005.tb01438.x>
- Gould, S. J., & Vrba, E. S. (1982). Exaptation – a missing term in the science of form. *Paleobiology*, 8(1), 4–15. <https://doi.org/10.1017/S0094837300004310>
- Green, W. (2009). *USDA PLANTS Compilation, version 1, 09-02-02*. (<http://bricol.net/downloads/data/PLANTSdatabase/>) NRCS: The PLANTS Database (<http://plants.usda.gov>, 1 Feb 2009). National Plant Data Center.
- He, W. M., Zhang, H., & Dong, M. (2004). Plasticity in fitness and fitness-related traits at ramet and genet levels in a tillering grass *Panicum miliaceum* under patchy soil nutrients. *Plant Ecology*, 172(1), 1–10. <https://doi.org/10.1023/B:VEGE.0000026043.27342.e2>
- Heger, T., Saul, W. C., & Trepl, L. (2013). What biological invasions 'are' is a matter of perspective. *Journal for Nature Conservation*, 21(2), 93–96. <https://doi.org/10.1016/j.jnc.2012.11.002>
- Henery, M. L., Bowman, G., Mraz, P., Treier, U. A., Gex-Fabry, E., Schaffner, U., & Müller-Schärer, H. (2010). Evidence for a combination of pre-adapted traits and rapid adaptive change in the invasive plant *Centaurea stoebe*. *Journal of Ecology*, 98(4), 800–813. <https://doi.org/10.1111/j.1365-2745.2010.01672.x>
- Hickler, T. (1999). *Plant functional types and community characteristics along environmental gradients on Öland's Great Alvar (Sweden) Master thesis*. University of Lund, Sweden.
- Hideg, É., Jansen, M. A., & Strid, Å. (2013). UV-B exposure, ROS, and stress: Inseparable companions or loosely linked associates? *Trends in Plant Science*, 18(2), 107–115. <https://doi.org/10.1016/j.tplants.2012.09.003>
- Hijmans, R. J. (2019). *raster: Geographic Data Analysis and Modeling. R package version 2.9-5*. Retrieved from <https://CRAN.R-project.org/package=raster>
- Hill, M. O., Preston, C. D., & Roy, D. B. (2004). *PLANTATT - attributes of British and Irish Plants: Status, size, life history, geography and habitats*. Huntingdon: Centre for Ecology and Hydrology.
- Hock, M., Beckmann, M., Hofmann, R., Bruelheide, H., & Erfmeier, A. (2015). Effects of UV-B radiation on germination characteristics in invasive plants in New Zealand. *NeoBiota*, 26, 21–37. <https://doi.org/10.3897/neobiota.26.4405>
- Hock, M., Hofmann, R. W., Müller, C., & Erfmeier, A. (2019). Exotic plant species are locally adapted but not to high ultraviolet-B radiation: A reciprocal multispecies experiment. *Ecology*, 100(5), e02665. <https://doi.org/10.1002/ecy.2665>
- Hodgson, J. G., Montserrat-Martí, G., Charles, M., Jones, G., Wilson, P., Shipley, B., ... de Torres Espuny, L. (2011). Is leaf dry matter content a better predictor of soil fertility than specific leaf area? *Annals of Botany*, 108(7), 1337–1345. <https://doi.org/10.1093/aob/mcr225>
- Howell, C. J., & Sawyer, J. W. D. (2006). *New Zealand naturalised vascular plant checklist*. Wellington, New Zealand: New Zealand Plant Conservation Network.
- Kalusová, V., Chytrý, M., van Kleunen, M., Mucina, L., Dawson, W., Essl, F., ... Pyšek, P. (2017). Naturalization of European plants on other continents: The role of donor habitats. *Proceedings of the National Academy of Sciences of the United States of America*, 114(52), 13756–13761. <https://doi.org/10.1073/pnas.1705487114>
- Kataria, S., Jajoo, A., & Guruprasad, K. N. (2014). Impact of increasing Ultraviolet-B (UV-B) radiation on photosynthetic processes. *Journal of Photochemistry and Photobiology B: Biology*, 137, 55–66. <https://doi.org/10.1016/j.jphotobiol.2014.02.004>
- Kattge, J., Díaz, S., Lavorel, S., Prentice, I. C., Leadley, P., Bönsch, G., ... Wirth, C. (2011). TRY – a global database of plant traits. *Global Change Biology*, 17, 2905–2935. <https://doi.org/10.1111/j.1365-2486.2011.02451.x>
- Kattge, J., Knorr, W., Raddatz, T., & Wirth, C. (2009). Quantifying photosynthetic capacity and its relationship to leaf nitrogen content for global-scale terrestrial biosphere models. *Global Change Biology*, 15, 976–991. <https://doi.org/10.1111/j.1365-2486.2008.01744.x>
- Kawecki, T. J., & Ebert, D. (2004). Conceptual issues in local adaptation. *Ecology Letters*, 7(12), 1225–1241. <https://doi.org/10.1111/j.1461-0248.2004.00684.x>
- Kergunteuil, A., Descombes, P., Glauser, G., Pellissier, L., & Rasmann, S. (2018). Plant physical and chemical defence variation along elevation gradients: A functional trait-based approach. *Oecologia*, 187(2), 561–571. <https://doi.org/10.1007/s00442-018-4162-y>
- Keser, L. H., Visser, E. J., Dawson, W., Song, Y. B., Yu, F. H., Fischer, M., ... van Kleunen, M. (2015). Herbaceous plant species invading natural areas tend to have stronger adaptive root foraging than other naturalized species. *Frontiers in Plant Science*, 6, 273. <https://doi.org/10.3389/fpls.2015.00273>
- Kirkup, D., Malcolm, P., Christian, G., & Paton, A. (2005). Towards a digital African Flora. *Taxon*, 54, 457–466. <https://doi.org/10.2307/25065373>
- Kleyer, M., Bekker, R. M., Knevel, I. C., Bakker, J. P., Thompson, K., Sonnenschein, M., ... Peco, B. (2008). The LEDA Traitbase: A database of life-history traits of the Northwest European flora. *Journal of Ecology*, 96, 1266–1274. <https://doi.org/10.1111/j.1365-2745.2008.01430.x>
- Kuhlmann, F., & Müller, C. (2011). Impact of ultraviolet radiation on interactions between plants and herbivorous insects: A chemo-ecological perspective. In U. E. Lüttge, W. Beyschlag, B. Budel, & D. Francis (Eds.), *Progress in botany 72* (pp. 305–347). Berlin, Germany: Springer Science + Business Media.

- Kühn, I., Durka, W., & Klotz, S. (2004). BioFlor - a new plant-trait database as a tool for plant invasion ecology. *Diversity and Distributions*, 10, 363–365.
- Kuznetsova, A., Brockhoff, P. B., & Christensen, R. H. B. (2017). lmerTest Package: Tests in linear mixed effects models. *Journal of Statistical Software*, 82(13), 1–26.
- Lamarque, L. J., Lortie, C. J., Porté, A. J., & Delzon, S. (2015). Genetic differentiation and phenotypic plasticity in life-history traits between native and introduced populations of invasive maple trees. *Biological Invasions*, 17(4), 1109–1122. <https://doi.org/10.1007/s10530-014-0781-3>
- Lamarque, L. J., Porté, A. J., Eymeric, C., Lasnier, J. B., Lortie, C. J., & Delzon, S. (2013). A test for pre-adapted phenotypic plasticity in the invasive tree *Acer negundo* L. *PLoS One*, 8(9), e74239. <https://doi.org/10.1371/journal.pone.0074239>
- Llorens, L., Badenes-Perez, F. R., Julkunen-Tiitto, R., Zidorn, C., Fereres, A., & Jansen, M. A. (2015). The role of UV-B radiation in plant sexual reproduction. *Perspectives in Plant Ecology, Evolution and Systematics*, 17, 243–254. <https://doi.org/10.1016/j.ppees.2015.03.001>
- Maron, J. L., Vilà, M., Bommarco, R., Elmendorf, S., & Beardsley, P. (2004). Rapid evolution of an invasive plant. *Ecological Monographs*, 74(2), 261–280. <https://doi.org/10.1890/03-4027>
- Mason, C. M., & Donovan, L. A. (2015). Does investment in leaf defenses drive changes in leaf economic strategy? A Focus on whole-plant Ontogeny. *Oecologia*, 177(4), 1053–1066. <https://doi.org/10.1007/s00442-014-3177-2>
- McKenzie, R. L., Aucamp, P. J., Bais, A. F., Björn, L. O., & Ilyas, M. (2007). Changes in biologically-active ultraviolet radiation reaching the Earth's surface. *Photochemical & Photobiological Sciences*, 6, 218–231. <https://doi.org/10.1039/B700017K>
- McKenzie, R. L., Aucamp, P. J., Bais, A. F., Björn, L. O., Ilyas, M., & Madronich, S. (2011). Ozone depletion and climate change: Impacts on UV radiation. *Photochemical & Photobiological Sciences*, 10, 182–198. <https://doi.org/10.1039/c0pp90034f>
- Meziane, D., & Shipley, B. (1999). Interacting determinants of specific leaf area in 22 herbaceous species: Effects of irradiance and nutrient availability. *Plant, Cell and Environment*, 22, 447–459. <https://doi.org/10.1046/j.1365-3040.1999.00423.x>
- Moravcová, L., Pyšek, P., Jarošík, V., Havlíčková, V., & Zákavský, P. (2010). Reproductive characteristics of neophytes in the Czech Republic: Traits of invasive and non-invasive species. *Preslia*, 82, 365–390.
- Moravcová, L., Pyšek, P., Jarošík, V., & Pergl, J. (2015). Getting the right traits: Reproductive and dispersal characteristics predict the invasiveness of herbaceous plant species. *PLoS One*, 10, e0123634. <https://doi.org/10.1371/journal.pone.0123634>
- Moroney, J. R., Rundel, P. W., & Sork, V. L. (2013). Phenotypic plasticity and differentiation in fitness-related traits in invasive populations of the Mediterranean forb *Centaurea melitensis* (Asteraceae). *American Journal of Botany*, 100, 2040–2051.
- Niinemets, Ü., Kull, O., & Tenhunen, J. D. (1998). An analysis of light effects on foliar morphology, physiology, and light interception in temperate deciduous woody species of contrasting shade tolerance. *Tree Physiology*, 18, 681–696. <https://doi.org/10.1093/treephys/18.10.681>
- Oplaat, C., & Verhoeven, K. J. (2015). Range expansion in asexual dandelions: Selection for general-purpose genotypes? *Journal of Ecology*, 103, 261–268. <https://doi.org/10.1111/1365-2745.12347>
- Parker, I. M., Rodriguez, J., & Loik, M. E. (2003). An evolutionary approach to understanding the biology of invasions: Local adaptation and general-purpose genotypes in the weed *Verbascum thapsus*. *Conservation Biology*, 17(1), 59–72. <https://doi.org/10.1046/j.1523-1739.2003.02019.x>
- Pearson, D. E., Ortega, Y. K., Eren, Ö., & Hierro, J. L. (2018). Community assembly theory as a framework for biological invasions. *Trends in Ecology & Evolution*, 33(5), 313–325. <https://doi.org/10.1016/j.tree.2018.03.002>
- Pebesma, E. J., & Bivand, R. S. (2005). Classes and methods for spatial data in R. *R News*, 5(2). <https://cran.r-project.org/doc/Rnews/>
- Petitpierre, B., Kueffer, C., Broennimann, O., Randin, C., Daehler, C., & Guisan, A. (2012). Climatic niche shifts are rare among terrestrial plant invaders. *Science*, 335(6074), 1344–1348.
- Poorter, H., & Garnier, E. (1999). Ecological significance of inherent variation in relative growth rate and its components. In F. I. Pugnaire, & F. Valladares (Eds.), *Handbook of Functional Plant Ecology* (pp. 81–120). New York, NY: Marcel Dekker Inc.
- Pyšek, P., Jarošík, V., Pergl, J., Randall, R., Chytrý, M., Kühn, I., ... Sádlo, J. (2009). The global invasion success of Central European plants is related to distribution characteristics in their native range and species traits. *Diversity and Distributions*, 15(5), 891–903. <https://doi.org/10.1111/j.1472-4642.2009.00602.x>
- Pyšek, P., Manceur, A. M., Alba, C., McGregor, K. F., Pergl, J., Stajerová, K., ... Kühn, I. (2015). Naturalization of central European plants in North America: Species traits, habitats, propagule pressure, residence time. *Ecology*, 96, 762–774. <https://doi.org/10.1890/14-1005.1>
- Pyšek, P., Pergl, J., Essl, F., Lenzen, B., Dawson, W., Kreft, H., ... van Kleunen, M. (2017). Naturalized alien flora of the world: Species diversity, taxonomic and phylogenetic patterns, geographic distribution and global hotspots of plant invasion. *Preslia*, 89, 203–274. <https://doi.org/10.23855/preslia.2017.203>
- Pyšek, P., & Richardson, D. M. (2007). Traits associated with invasiveness in alien plants: Where do we stand? *Ecological Studies*, 193, 97.
- Qaderi, M. M., Yeung, E. C., & Reid, D. M. (2008). Growth and physiological responses of an invasive alien species, *Silene noctiflora*, during two developmental stages to four levels of ultraviolet-B radiation. *Ecoscience*, 15(2), 150–159.
- Qing, H., Yao, Y., Xiao, Y., Hu, F., Sun, Y., Zhou, C., & An, S. (2011). Invasive and native tall forms of *Spartina alterniflora* respond differently to nitrogen availability. *Acta Oecologica*, 37, 23–30. <https://doi.org/10.1016/j.actao.2010.11.002>
- Reich, P. B., Oleksyn, J., & Wright, I. J. (2009). Leaf phosphorus influences the photosynthesis-nitrogen relation: A cross-biome analysis of 314 species. *Oecologia*, 160, 207–212. <https://doi.org/10.1007/s00442-009-1291-3>
- Ricciardi, A., Hoopes, M. F., Marchetti, M. P., & Lockwood, J. L. (2013). Progress toward understanding the ecological impacts of nonnative species. *Ecological Monographs*, 83(3), 263–282. <https://doi.org/10.1890/13-0183.1>
- Richards, C. L., Bossdorf, O., Muth, N. Z., Gurevitch, J., & Pigliucci, M. (2006). Jack of all trades, master of some? On the role of phenotypic plasticity in plant invasions. *Ecology Letters*, 9, 981–993. <https://doi.org/10.1111/j.1461-0248.2006.00950.x>
- Richardson, D. M., Pyšek, P., Rejmánek, M., Barbour, M. G., Panetta, F. D., & West, C. J. (2000). Naturalization and invasion of alien plants: Concepts and definitions. *Diversity and Distributions*, 6, 93–107. <https://doi.org/10.1046/j.1472-4642.2000.00083.x>
- Robson, T. M., & Aphalo, P. J. (2012). Species-specific effect of UV-B radiation on the temporal pattern of leaf growth. *Physiologia Plantarum*, 144(2), 146–160. <https://doi.org/10.1111/j.1399-3054.2011.01546.x>
- Robson, T. M., Klem, K., Urban, O., & Jansen, M. A. (2015). Re-interpreting plant morphological responses to UV-B radiation. *Plant, Cell & Environment*, 38(5), 856–866. <https://doi.org/10.1111/pce.12374>
- Royal Botanical Gardens KEW (2008). *Seed Information Database (SID). Version 7.1*. Retrieved from <http://data.kew.org/sid/> (May 2011).
- Ruprecht, E., Fenesi, A., & Nijs, I. (2014). Are plasticity in functional traits and constancy in performance traits linked with invasiveness? An experimental test comparing invasive and naturalized plant species. *Biological Invasions*, 16, 1359–1372. <https://doi.org/10.1007/s10530-013-0574-0>

- Schlaepfer, D. R., Glaetli, M., Fischer, M., & van Kleunen, M. (2010). A multi-species experiment in their native range indicates pre-adaptation of invasive alien plant species. *New Phytologist*, 185, 1087–1099. <https://doi.org/10.1111/j.1469-8137.2009.03114.x>
- Seckmeyer, G., & McKenzie, R. L. (1992). Increased ultraviolet radiation in New Zealand (45° S) relative to Germany (48° N). *Nature*, 359(6391), 135–137. <https://doi.org/10.1038/359135a0>
- Sheppard, C. S., Burns, B. R., & Stanley, M. C. (2016). Future-proofing weed management for the effects of climate change: Is New Zealand underestimating the risk of increased plant invasions? *New Zealand Journal of Ecology*, 40(3), 398–405. <https://doi.org/10.20417/nzjecol.40.45>
- Shipley, B., & Vu, T. T. (2002). Dry matter content as a measure of dry matter concentration in plants and their parts. *New Phytologist*, 153, 359–364. <https://doi.org/10.1046/j.0028-646X.2001.00320.x>
- Štroch, M., Materová, Z., Vrábl, D., Karlický, V., Šigut, L., Nezval, J., & Špunda, V. (2015). Protective effect of UV-A radiation during acclimation of the photosynthetic apparatus to UV-B treatment. *Plant Physiology and Biochemistry*, 96, 90–96. <https://doi.org/10.1016/j.plaphy.2015.07.017>
- Suchar, V. A., & Robberecht, R. (2014). Integration and scaling of UV-B radiation effects on plants: From DNA to leaf. *Ecology and Evolution*, 5, 2544–2555. <https://doi.org/10.1002/ece3.1332>
- Suchar, V. A., & Robberecht, R. (2016). Integration and scaling of UV-B radiation effects on plants: From molecular interactions to whole plant responses. *Ecology and Evolution*, 6, 4866–4884. <https://doi.org/10.1002/ece3.2064>
- Te Beest, M., Le Roux, J. J., Richardson, D. M., Brysting, A. K., Suda, J., Kubešová, M., & Pyšek, P. (2011). The more the better? The role of polyploidy in facilitating plant invasions. *Annals of Botany*, 109(1), 19–45. <https://doi.org/10.1093/aob/mcr277>
- Thuiller, W., Richardson, D. M., Pyšek, P., Midgley, G. F., Hughes, G. O., & Rouget, M. (2005). Niche-based modelling as a tool for predicting the risk of alien plant invasions at a global scale. *Global Change Biology*, 11(12), 2234–2250. <https://doi.org/10.1111/j.1365-2486.2005.001018.x>
- Turner, K. G., Fréville, H., & Rieseberg, L. H. (2015). Adaptive plasticity and niche expansion in an invasive thistle. *Ecology and Evolution*, 5, 3183–3197. <https://doi.org/10.1002/ece3.1599>
- Václavík, T., Beckmann, M., Cord, A. F., & Bindewald, A. M. (2017). Effects of UV-B radiation on leaf hair traits of invasive plants - Combining historical herbarium records with novel remote sensing data. *PLoS One*, 12(4), e0175671. <https://doi.org/10.1371/journal.pone.0175671>
- van Kleunen, M., Dawson, W., Essl, F., Pergl, J., Winter, M., Weber, E., ... Pyšek, P. (2015). Global exchange and accumulation of non-native plants. *Nature*, 525(7567), 100. <https://doi.org/10.1038/nature14910>
- van Kleunen, M., Pyšek, P., Dawson, W., Essl, F., Kreft, H., Pergl, J., ... Winter, M. (2019). The Global Naturalized Alien Flora (GloNAF) database. *Ecology*, 100(1), e02542.
- van Kleunen, M., Weber, E., & Fischer, M. (2010). A meta-analysis of trait differences between invasive and non-invasive plant species. *Ecology Letters*, 13, 235–245. <https://doi.org/10.1111/j.1461-0248.2009.01418.x>
- Verdaguer, D., Jansen, M. A., Llorens, L., Morales, L. O., & Neugart, S. (2017). UV-A radiation effects on higher plants: Exploring the known unknown. *Plant Science*, 255, 72–81. <https://doi.org/10.1016/j.plantsci.2016.11.014>
- Wang, H., Ma, X., Zhang, L., Siemann, E., & Zou, J. (2016). UV-B has larger negative impacts on invasive populations of *Triadica sebifera* but ozone impacts do not vary. *Journal of Plant Ecology*, 9(1), 61–68.
- Watanabe, S., Takemura, T., Sudo, K., Yokohata, T., & Kawase, H. (2012). Anthropogenic changes in the surface all-sky UV-B radiation through 1850–2005 simulated by an Earth system model. *Atmospheric Chemistry and Physics*, 12, 5249–5257. <https://doi.org/10.5194/acp-12-5249-2012>
- Whitney, K. D., & Galber, C. A. (2008). Rapid evolution in introduced species, 'invasive traits' and recipient communities: Challenges for predicting invasive potential. *Diversity and Distributions*, 14, 569–580. <https://doi.org/10.1111/j.1472-4642.2008.00473.x>
- Wright, I. J., Reich, P. B., Westoby, M., Ackerly, D. D., Baruch, Z., Bongers, F., ... Villar, R. (2004). The worldwide leaf economics spectrum. *Nature*, 428(6985), 821. <https://doi.org/10.1038/nature02403>
- Yang, Y., Wang, H., Harrison, S. P., Prentice, I. C., Wright, I. J., Peng, C., & Lin, G. (2019). Quantifying leaf-trait covariation and its controls across climates and biomes. *New Phytologist*, 221(1), 155–168. <https://doi.org/10.1111/nph.15422>

BIOSKETCH

Maria Hock is currently a PhD candidate at Kiel University, and her main research focus is on adaptability of invasive grassland species to high levels of UV-B radiation and the impact of UV-B radiation as a potentially selective environmental filter during plant invasions in New Zealand.

Author contributions: A.E., H.B., R.H. and M.H. conceived the study design. M.H. gathered experimental data and conducted data analysis. F.E. and P.P. provided data of native and invaded distribution range. All co-authors contributed to the writing of the manuscript led by M.H.

SUPPORTING INFORMATION

Additional supporting information may be found online in the Supporting Information section.

How to cite this article: Hock M, Hofmann R, Essl F, Pyšek P, Bruehlheide H, Erfmeier A. Native distribution characteristics rather than functional traits explain preadaptation of invasive species to high-UV-B environments. *Divers Distrib*. 2020;26:1421–1438. <https://doi.org/10.1111/ddi.13113>

Chapter III: Exotic plant species are locally adapted but not to high ultraviolet-B radiation: a reciprocal multispecies experiment.

M. Hock, R. W. Hofmann, C. Müller & A. Erfmeier

published in *Ecology* 100(5), e02665 (2019), DOI: 10.1002/ecy.2665

Abstract:

Ultraviolet (UV) radiation intensities differ among global regions, with significantly higher levels in the southern hemisphere. UV-B may act as an environmental filter during plant invasions, which might particularly apply to plant species from Europe introduced to New Zealand. Just like for any other abiotic or biotic filter, successful invaders can cope with novel environmental conditions via plastic responses and/or through rapid adaptation by natural selection in the exotic range. We conducted a multispecies experiment with herbaceous plants in two common gardens located in the species' native and exotic ranges, in Germany and New Zealand, respectively. We used plants of German and New Zealand origin of eight species to test for adaptation to higher UV-B radiation in their new range. In each common garden, all plants were exposed to three radiation treatments: (1) ambient sunlight, (2) exclusion of UV-B while transmitting ambient UV-A, and (3) combined exclusion of UV-B and UVA. Linear mixed-effect models revealed significant effects of UV-B on growth and leaf traits and an indication for UV-B-induced biomass reduction in both common gardens pointing to an impact of natural, ambient UV radiation intensities experienced by plants in the northern and in the southern hemisphere. In both common gardens, the respective local plants (i.e., German origins in Germany, New Zealand origins in New Zealand) displayed enhanced productivity and aboveground biomass allocation, thus providing evidence for recent evolutionary processes in the exotic range. Genetic differentiation between different origins in consequence of divergent local selection pressures was found for specific leaf area. This differentiation particularly hints at different selective forces in both ranges while only little evidence was found for an immediate selective effect of high UV-B intensities in the exotic range. However, reaction norm slopes across ranges revealed higher plasticity of exotic individuals in functional leaf traits that might allow for a more sensitive regulation of photoprotection measures in response to UV-B. During the colonization, New Zealand populations might have been selected for the observed higher phenotypic plasticity and a consequently increased ability to successfully spread in the exotic range.

Exotic plant species are locally adapted but not to high ultraviolet-B radiation: a reciprocal multispecies experiment

MARIA HOCK ^{1,2,6}, RAINER W. HOFMANN,³ CAROLINE MÜLLER,⁴ AND ALEXANDRA ERFMEIER^{1,5}

¹Institute for Ecosystem Research/Geobotany, Kiel University, Olshausenstrasse 75, Kiel 24118 Germany

²Institute of Biology/Geobotany and Botanical Garden, Martin Luther University Halle-Wittenberg, Am Kirchtor 1, Halle 06108 Germany

³Faculty of Agriculture and Life Sciences, Lincoln University, Ellesmere Junction Road/Springs Road, Lincoln 7647 New Zealand

⁴Faculty of Biology/Chemical Ecology, Bielefeld University, Universitätsstraße 25, Bielefeld 33615 Germany

⁵German Centre for Integrative Biodiversity Research (iDiv) Halle-Jena-Leipzig, Deutscher Platz 5E, Leipzig 04103 Germany

Citation: Hock, M., R. W. Hofmann, C. Müller, and A. Erfmeier. 2019. Exotic plant species are locally adapted but not to high ultraviolet-B radiation: a reciprocal multispecies experiment. *Ecology* 100(5):e02665. 10.1002/ecy.2665

Abstract. Ultraviolet (UV) radiation intensities differ among global regions, with significantly higher levels in the southern hemisphere. UV-B may act as an environmental filter during plant invasions, which might particularly apply to plant species from Europe introduced to New Zealand. Just like for any other abiotic or biotic filter, successful invaders can cope with novel environmental conditions via plastic responses and/or through rapid adaptation by natural selection in the exotic range. We conducted a multispecies experiment with herbaceous plants in two common gardens located in the species' native and exotic ranges, in Germany and New Zealand, respectively. We used plants of German and New Zealand origin of eight species to test for adaptation to higher UV-B radiation in their new range. In each common garden, all plants were exposed to three radiation treatments: (1) ambient sunlight, (2) exclusion of UV-B while transmitting ambient UV-A, and (3) combined exclusion of UV-B and UV-A. Linear mixed-effect models revealed significant effects of UV-B on growth and leaf traits and an indication for UV-B-induced biomass reduction in both common gardens pointing to an impact of natural, ambient UV radiation intensities experienced by plants in the northern and in the southern hemisphere. In both common gardens, the respective local plants (i.e., German origins in Germany, New Zealand origins in New Zealand) displayed enhanced productivity and aboveground biomass allocation, thus providing evidence for recent evolutionary processes in the exotic range. Genetic differentiation between different origins in consequence of divergent local selection pressures was found for specific leaf area. This differentiation particularly hints at different selective forces in both ranges while only little evidence was found for an immediate selective effect of high UV-B intensities in the exotic range. However, reaction norm slopes across ranges revealed higher plasticity of exotic individuals in functional leaf traits that might allow for a more sensitive regulation of photoprotection measures in response to UV-B. During the colonization, New Zealand populations might have been selected for the observed higher phenotypic plasticity and a consequently increased ability to successfully spread in the exotic range.

Key words: environmental filter; multispecies experiment; native and exotic populations; phenotypic plasticity; plant invasions; recent evolutionary changes; reciprocal common garden; UV-A and UV-B exclusion.

INTRODUCTION

Plant invasions are globally an increasingly striking and frequent phenomenon mainly fostered by extensive human activity and enhanced economic development (Lodge et al. 2006, Hulme 2009). Most notably, they occur in previously isolated systems, such as islands, with serious consequences for native biodiversity and

ecosystem functioning (Kueffer et al. 2010). In consequence, aiming at a better understanding of underlying mechanisms controlling the success or failure of invasions and thereby the identification of plant species and traits that have the potential to respond successfully to novel environmental conditions in new habitats are central research goals in invasion ecology.

The ability of exotic species to cope with novel abiotic and biotic factors is crucial and can be explained by several mechanisms. Release from native biotic and abiotic stressors (Blossey and Nötzold 1995, Lin et al. 2015), pre-adaptation that might match conditions in the new

Manuscript received 27 February 2018; revised 21 December 2018; accepted 16 January 2019. Corresponding Editor: Samantha K. Chapman.

⁶E-mail: mhock@ecology.uni-kiel.de

range (Schlaepfer et al. 2010, Elst et al. 2016), high phenotypic plasticity in response to a broad environmental range (Ruprecht et al. 2014, Oplaat and Verhoeven 2015), or occupation of a vacant ecological niche (Dlugosch et al. 2015) can be considered classical ecological mechanisms enhancing invasion success. Furthermore, approaches based on the comparison of native and exotic genotypes point to the importance of rapid adaptive evolution for the successful colonization of the exotic range (Ziska et al. 2015). While for some plant invasions it is possible to specifically test and identify single mechanisms as predominant keys, most of the mechanisms are not necessarily mutually exclusive but may act subsequently or even simultaneously in different stages of invasions (Dietz and Edwards 2006, Si et al. 2014, Zenni et al. 2014, Lamarque et al. 2015).

Rapid adaptive evolution in the exotic range has mostly been tested by reciprocal transplant or common garden experiments, since comparing native and exotic populations in (multiple) common environments allows to uncover genetic differentiation of origins in measurable phenotypic traits (Maron et al. 2004, Flory et al. 2011, Müller 2018). According to Kawecki and Ebert (2004), local adaptation can ideally be assessed by testing the “local vs. foreign” criterion among different environments, which hypothesizes a better performance of the local population compared to a foreign population within a particular environment.

Local adaptation was found to occur in invasive species as frequently and as strongly as in native plant species as depicted in a recent meta-analysis on 130 studies (Oduor et al. 2016). Thus, adaptive evolution in consequence of natural selection in the exotic range may apply to many plant species world-wide. Thereby, local adaptation in the novel habitat can be driven by either an environmental constraint or a release: Whereas conditions of constraints mostly lead to specialization by classical natural selection, evolutionary responses to release from stresses might be more often accompanied by phenotypic plasticity (Erfmeier 2013). Nevertheless, there is evidence for phenotypic plasticity to facilitate local adaptation during plant invasions or even be adaptive itself (Nicotra et al. 2010). Especially plant populations with a wide geographic distribution range may display local adaptation to climatic factors correlated with latitude (Felker-Quinn et al. 2013), and there is a high number of such examples for several variables, e.g., day length (Vandepitte et al. 2014), length of growing season (Colautti and Barrett 2013) and temperature (Molina-Montenegro et al. 2013).

Beyond those, also ultraviolet (UV) radiation is a climatic factor that significantly differs in intensity at a global scale and that is largely subjected to effects of global change (Watanabe et al. 2012). Nonetheless, UV radiation has been widely ignored to date as potentially selective environmental filter during plant invasions (but see Beckmann et al. 2012, Hock et al. 2015, Wang et al. 2015). Due to the lower earth-to-sun distance and the

higher solar altitude during the southern hemisphere summer, fundamental overall differences in annual and maximum intensities of UV-A (spectral range: 315–380 nm) and UV-B radiation (spectral range: 280–315 nm) occur between hemispheres. Up to twofold higher UV intensities are observed in the southern hemisphere, in particular, when regions at similar latitude are compared, e.g., temperate Central Europe with temperate New Zealand (Seckmeyer and McKenzie 1992, Godar 2007, McKenzie et al. 2007, 2011). Plants can respond to elevated UV-B radiation with changes in phenology (e.g., a delayed reproductive timing), decreased productivity, a more compact plant architecture and changes in leaf morphology, i.e., reduced stem length, increased branching, thicker leaves with modified leaf shape and altered root:shoot ratios in various directions (Kataria et al. 2014, Llorens et al. 2015, Robson et al. 2015, Suchar and Robberecht 2016). At the cellular level, the main targets of high-energy UV-B radiation are nucleic acids, Calvin cycle enzymes and photosystem II proteins with a significant potential for photosynthesis apparatus damage (Kataria et al. 2014). Thus, UV-B also triggers biosynthesis of sunscreen metabolites, such as phenolics, antioxidants, and DNA repair enzymes (Ulm and Jenkins 2015, Barnes et al. 2016). Due to potential costs involved in these responses, increased UV-B radiation may consequently result in decreased competitive ability and reduced fitness of individuals with potentially negative implications for establishment and colonization in novel environments. UV-A radiation is highly related to UV-B and known for its mitigating effect, as it induces protection measures of the photosynthetic apparatus under abiotic stress conditions (e.g., high UV-B, drought) and therefore increases physiological resilience (Štroch et al. 2015, Escobar-Bravo et al. 2017, Verdaguer et al. 2017). Thus, investigation of UV-B radiation effects on individual plants performance and population fitness should be conducted under natural radiation conditions to ensure ecologically relevant UV environments characterized by a particular relation of UV-A, UV-B, and photosynthetically active radiation (PAR: 380–700 nm; Kuhlmann and Müller 2011).

Here, we studied variation in growth traits of individuals from German and New Zealand origins of eight herbaceous plant species exotic in New Zealand in response to UV radiation. We compared performance under each of three UV treatments additionally implemented in two common gardens reciprocally established in the species’ “native” (Germany) and exotic range (New Zealand, Fig. 1). Based on the known detrimental effects of UV-B radiation on plants, we tested for evidence of UV-B as a driver of recent adaptive evolution during plant invasions in high-UV-B environments. We, specifically, hypothesized that (1) natural UV-B radiation generally constrains plant performance with stronger growth-limiting effects in the exotic range New Zealand, (2) divergent natural selection has already resulted in differentiation between plant individuals of

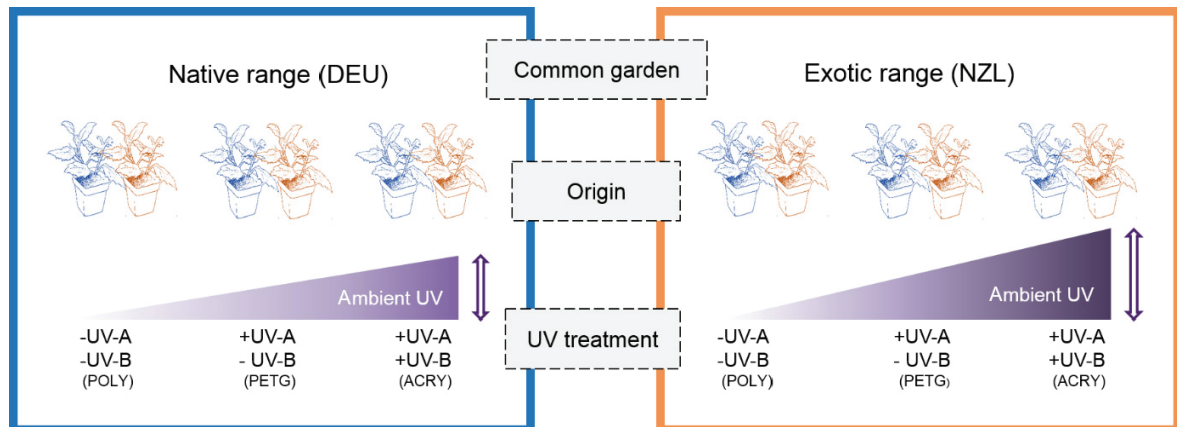

FIG. 1. Experimental design of common garden experiments indicating the factors of common garden, i.e., experimental setting in the two ranges, origin, i.e., population origin of either German or New Zealand provenance, and levels of experimental ultraviolet (UV) treatments. This setting was conducted for each of the eight study species (Appendix S1) in a common design. DEU, Germany; NZL, New Zealand; POLY, polycarbonate (–UV-A|–UV-B); PETG, polyethylene terephthalate glycol (+UV-A|–UV-B); ACRY, acrylic (+UV-A|+UV-B).

German and New Zealand origins due to different local selection pressures, and (3) local populations in the exotic range New Zealand have specifically adapted to elevated UV-B and therefore show higher UV-B tolerance. Alternatively, higher UV-B tolerance may be a result of selection for high phenotypic plasticity during colonization. To our knowledge, this is the first study addressing local adaptation of exotic species to elevated UV-B intensities in the exotic range via a multispecies reciprocal common garden approach.

METHODS

Experimental design

We conducted a common garden experiment including individuals of eight herbaceous species (Table 1) in, both, the native range (Germany) and the exotic range (New Zealand). In Germany, the experiment was performed in the Botanical Garden of Kiel University (54.34583° N, 10.11632° E) during the northern hemisphere summer season 2015 (July–October), whereas the New Zealand common garden was established at Lincoln University (43.64506° S, 172.4620° E) during the southern hemisphere summer season 2014–2015 (December–March).

In both common gardens, German and New Zealand individuals of all study species were grown. The investigated species represent a subset of a larger species pool included in another experimental approach within the described setting (M. Hock et al., *unpublished data*) and were selected based on seed availability for both ranges. All eight species prefer open, unshaded habitats, are fully naturalized in New Zealand (Allan Herbarium 2000, Howell and Sawyer 2006) and, hereafter, considered to be native to Europe although they comprise different

TABLE 1. Study species, the year of recorded naturalization in New Zealand (according to the New Zealand Plant Conservation Network database), and their experimental duration in days in both common garden experiments in New Zealand (NZ) and Germany (DE).

Species	Family	Year naturalized	Experimental duration (d)	
			NZ	DE
<i>Artemisia absinthium</i> L.	Asteraceae	1872	102†	75†
<i>Erysimum cheiri</i> (L.) Crantz	Brassicaceae	1875	107	75
<i>Linaria purpurea</i> (L.) Mill	Scrophulariaceae	1875	77†	76†
<i>Lobularia maritima</i> (L.) Desv.	Brassicaceae	1840	73†	77†
<i>Origanum vulgare</i> L.	Lamiaceae	1944	78†	77†
<i>Tragopogon porrifolius</i> L.	Asteraceae	1870	104	74
<i>Trifolium pratense</i> L.	Fabaceae	1867	78†	73†
<i>Trifolium repens</i> L.	Fabaceae	1864	79†	74†

† Species that reached the reproductive stage during the experiments.

degrees of nativeness (Germplasm Resource Information Network [GRIN]; data *available online*).⁷ In the present study, the status and term native was allocated to species native to Germany in the strict sense (*Trifolium repens*, *Trifolium pratense*, *Origanum vulgare*), German

⁷ <https://www.grin-global.org/>

archaeophytes (*Artemisia absinthium*, *Erysimum cheiri*) and species that are native only to other parts of Europe but that also occur in Germany (*Linaria purpurea*, *Tragopogon porrifolius*, *Lobularia maritima*). German and New Zealand seeds were either purchased from commercial seed companies and botanical gardens or provided by the Lincoln University (New Zealand seeds of *Trifolium pratense* and *Trifolium repens*), and jointly cultivated in both common gardens (Table 1 and Appendix S1 for species list and seed origin information). All seeds originated either from established ex situ outdoor populations or from propagation areas of regional genotypes to ensure that the plants had experienced growth under natural solar radiation and were able to adapt to ambient conditions. All seeds were germinated in the greenhouse (either in New Zealand or in Germany) under controlled conditions in seedling trays. In the following, we distinguish seeds of local populations (i.e., German populations tested in Germany, New Zealand populations tested in New Zealand) and seeds of foreign populations (i.e., German populations tested in New Zealand and New Zealand populations tested in Germany). Individuals were transferred to 2-L pots about six to eight weeks after sowing. Legal import regulations precluded the use of identical substrate and thereby the use of standardized soils across experiments. We therefore made use of local common usage substrates at the two gardens: New Zealand substrate was based on bark and pumice, supplemented with horticultural lime and slow-release fertilizer (3 kg/m³). In Germany, we used a peat substrate with natural clay, supplemented with directly soluble mineral nutrients and slow-release fertilizer (3 kg/m³). Plants were assigned to the experimental settings when they were 10 weeks old.

In both common gardens, the plants were exposed to three UV treatments, including (1) full exposure to ambient, natural UV-A, and UV-B radiation, (2) exclusion of UV-B while allowing natural UV-A, and (3) total exclusion of both UV-A and UV-B wavelengths (Fig. 1). These three UV environments allowed for the comparison of ambient solar radiation conditions and two artificial UV environments to derive the ecologically inseparable effects of UV-A and UV-B, such as the not fully understood UV-A mitigation effect (Verdaguer et al. 2017). To apply these UV treatments to the plants, we used in both common gardens each six UV cabinets (Appendix S2) per UV treatment, equipped with acrylic (PLEXIGLAS GS 2458 clear; Evonik Industries AG, Essen, Germany), polyethylene terephthalate glycol (Polycasa PETG clear B1; thyssenkrupp Plastics GmbH, Essen, Germany) and polycarbonate sheets (Makrolon GP clear 099; thyssenkrupp Plastics GmbH), respectively. One individual of each species was randomly assigned and positioned in each UV cabinet, resulting in six replicates per species and treatment (totaling 18 individuals per species). Each three of the six replicates per species and treatment originated from either a local or a foreign seed source, resulting in three replicates per

species, treatment and origin. In total, six local and foreign individuals of each species were randomly allocated to the six UV cabinets representing one UV treatment level. In consequence, each UV cabinet contained only one individual per species (either local or foreign), but, in total, eight individuals of different species and of randomized mixed origin. In order to counteract potential undesired shading effects of neighboring plants, we randomly repositioned all plants within the UV cabinets every other week during the experimental runtime.

To characterize climate conditions at the experimental sites, we obtained official climate data for Germany from the Climate Data Centre of Deutscher Wetterdienst (DWD; data *available online*) and the Federal Office for Radiation Protection (BfS; data *available online*).^{8,9} New Zealand climate data was obtained from the National Climate Database (NIWA; data *available online*) and the UV Atlas Version 2.2 (Bodeker et al. 2006).¹⁰ Both experiments had comparable temperature conditions during their respective runtime with a maximum temperature of about 30°C but a slightly lower minimum temperature in New Zealand during that period (DEU, 4.1°C; NZL, 2.1°C). Dependent on species-specific experimental duration (see Data collection), plants experienced in total up to 495 sunshine hours in Germany and 760 h of sun in New Zealand, resulting on average in one sunshine hour by experimental day more in New Zealand than in Germany. The mean daily global radiation dose was about twice as high in the New Zealand common garden compared to the common garden in Germany. UV-B intensities showed a significant difference between both sites with 2.5 times higher daily UV-B dose in New Zealand and, consequently, a maximum UV-B radiation sum of 3,454 kJ/m² compared to 974 kJ/m² in Germany (Appendix S3). All information on climate data including the specification of data source and the distance of the respective measuring stations to the common garden locations is listed in the appendix (Appendix S3).

Data collection

To address plant responses to UV-B with respect to photoprotection ability and individual performance, such as fitness-relevant traits, we determined responses at different organizational levels ranging from leaf traits, through whole-plant responses, to measures of reproduction. All 287 individuals were harvested species-wise depending on the species-specific developmental climax, i.e., the moment of maximum biomass production prior to seasonal wilting of inflorescences or leaves (see Table 1 for species-specific experimental duration). Accordingly, the species remained for different periods in the common gardens ranging from 73 to 107 d in the

⁸ http://www.dwd.de/EN/climate_environment/cdc/cdc.html

⁹ <http://www.bfs.de>

¹⁰ <https://cliflo.niwa.co.nz/>

New Zealand experiment and from 73 to 77 d in the German experiment. Persistently stable late summer climatic conditions in New Zealand in March 2015 allowed for an extended experimental runtime, whereas harsher climatic conditions in early October 2015 in Germany resulted in an earlier termination of the common garden experiment due to an earlier induced senescence.

Especially leaf traits, such as specific leaf area (SLA) and leaf dry matter content (LDMC) have proven to be strongly sensitive to UV radiation (Robson et al. 2015). Therefore, at the harvest day, we determined maximum leaf length of all individuals, sampled fresh material of several fully developed and healthy leaves in a standardized way and determined leaf area with WinFOLIA 2015 software (Regent Instruments Inc., Québec, Canada). For each individual, the functional leaf traits SLA and LDMC were subsequently calculated. Based on freeze-dried leaf material, we used elemental analyzer measurements (Euro EA 3000; HEKAtech GmbH, Wegberg, Germany) for determination of total foliar carbon content and nitrogen content, as in previous studies a wider C:N ratio turned out to be an indicator for stressful environmental conditions (Chen et al. 2015). Furthermore, secondary metabolites have shown to be a good indicator for high UV levels at lower organizational levels (Kataria et al. 2014). Thus, to determine the concentration of total phenolics, 0.01 mg homogenized leaf material was extracted twofold in 80% methanol. After centrifugation, the absorption of the supernatants was measured at 765 nm in a plate reader after addition of Folin-Ciocalteu reagent (following Austel et al. 2016). A concentration series of gallic acid was measured in parallel and the total phenolics concentration per sample was calculated as gallic acid equivalent.

In order to assess the reproductive effort of all flowering individuals, we counted the number of inflorescences. As characteristic growth traits that may be affected by UV radiation, plant height and maximum plant expansion were determined at the harvest day. Aboveground and belowground biomass were separated, dried at 80°C for 48 h and subsequently weighed. Finally, the root:shoot ratio was calculated for each individual as allocation variable.

Statistical analysis

As we were more interested in identifying overall effects across the species of the entire species pool rather than in particular species-specific differences, all data were standardized by z -transformation within species and the resulting z scores were used for subsequent analysis (according to Haider et al. 2012). The standardization of absolute changes in response variables (raw scores) results in a comparable expression of the within-species response to different environments. The z scores represent the number of species-specific standard deviations and, thus, allow accounting for absolute species-inherent differences (see Appendix S4 for species-specific variance in raw data). For data analysis, linear mixed models were applied

in R (Version 3.2.3; R Core Team 2017) using the function `lmer` (packages `lme4` [Bates et al. 2015], `lmerTest` [Kuznetsova et al. 2016]) and type 3 sum of squares. We tested for effects of experimental site, addressed as range in the following (native DEU, exotic NZL), UV treatment ($-UV-A|-UV-B$, $+UV-A|-UV-B$, $+UV-A|+UV-B$), and origin (DEU, NZL), as well as all their interactions. We additionally included specific experimental duration of individuals dependent on species and experimental site as a covariate. Furthermore, we defined three nested random effects (according to Zuur et al. [2009]) to correct for the block effect of UV cabinets, that did not display true replicates of each other, and included `cabinet : range`, `cabinet : UV treatment`, and `cabinet : origin`. To correct for potential species identity effects in the multispecies approach, e.g., due to functional trait differences between species, `origin : species` and `UV treatment : species` were additionally included as random effects in the model. Separate analyses on initial plant height and leaf numbers revealed no significant difference between treatments or origins prior to the experimental UV treatment (data not shown).

RESULTS

For most of the variables tested, we found significant range effects and range \times origin interactions, indicating a different outcome due to the location of the common gardens, whereas main effects of origin and UV treatments were of importance only for selected variables (Table 2).

Range effects

In the exotic range in New Zealand, plants had generally higher values in total biomass, plant height, and number of inflorescences than in the native range in Germany (Figs. 2a, 3b, Table 2). Leaves of plants grown in the exotic range were characterized by a wider C:N ratio, as well as a higher LDMC and total phenolic concentrations compared to plants grown in the native range (Figs. 2e, g, 3a, Table 3). In contrast, plants grew significantly larger leaves with higher maximum leaf length in the native range common garden (Fig. 2d, Table 3).

Effects of UV treatment

Across all species in both common gardens, UV treatment effects were clearly expressed in maximum plant expansion and phenolic concentrations (Tables 2, 3; Appendix S5). Maximum plant expansion was significantly reduced under full solar UV-B radiation compared to UV filter treatments with a tendency to a stronger reduction in New Zealand individuals (Fig. 4b, Table 2). Leaf phenolic concentrations were significantly increased in the presence of UV (Fig. 3a, Table 3). Although not displaying overall significance, total biomass and maximum leaf length tended to be lower under

TABLE 2. Fixed-effect results of the mixed model analysis of growth and reproduction traits across both common garden experiments (range).

Source	df _N	Total biomass			Plant height			Max. plant expansion			Root:shoot ratio			No. inflorescences		
		df _D	<i>F</i>	<i>P</i>	df _D	<i>F</i>	<i>P</i>	df _D	<i>F</i>	<i>P</i>	df _D	<i>F</i>	<i>P</i>	df _D	<i>F</i>	<i>P</i>
Range	1	148.7	19.418	<0.001***	49.8	40.081	<0.001***	257.9	0.321	0.572	259.6	1.679	0.196	191.4	47.768	<0.001***
UV	2	27.8	2.555	<i>0.096</i>	19.0	1.327	0.289	113.8	3.120	0.048*	99.9	0.310	0.734	11.5	0.017	0.984
Origin	1	13.3	0.784	0.392	13.9	0.114	0.741	14.5	0.080	0.781	14.4	0.027	0.871	9.0	0.140	0.717
Experiment duration	1	86.4	0.114	0.736	243.7	38.013	<0.001***	199.7	15.439	<0.001***	209.0	5.564	0.019*	195.6	17.070	<0.001***
Range × UV	2	93.8	1.654	0.197	18.0	0.744	0.489	115.9	0.753	0.473	103.3	1.421	0.246	181.1	6.182	0.003**
Range × origin	1	266.4	9.104	0.003**	257.5	0.357	0.551	254.3	4.628	0.032*	253.8	5.772	0.017*	184.4	0.959	0.329
UV × origin	2	257.2	0.725	0.485	254.7	0.587	0.557	113.6	2.635	<i>0.076</i>	99.6	0.062	0.940	185.9	0.787	0.457
Range × UV × origin	2	256.9	0.380	0.684	254.7	0.147	0.863	115.8	0.116	0.891	103.3	0.215	0.807	185.9	0.428	0.653

Notes: UV (ultraviolet) depicts the effect of additional UV treatments, origin refers to the effect of German vs. New Zealand provenance. Harvest traits were standardized by *z*-transformation within species. Degrees of freedom (df_N = numerator, df_D = denominator), *F* statistics (*F*), and significance values (*P*) are provided. Values in boldface type indicate significant *P* values (**P* < 0.05; ***P* < 0.01; ****P* < 0.001) and values in italic typeface indicate marginal effects. (*P* < 0.1).

UV-B exposition (Fig. 4a, c, Tables 2, 3). In the German common garden, the number of inflorescences was highest in environments with total UV exclusion and lowest in presence of UV-A but absence of UV-B. The trend across UV environments was the opposite for plants grown in the exotic range common garden, while the number of inflorescences was generally higher when plants were grown in New Zealand (Fig. 3b, Table 2).

Differences between origins

Across all species, SLA was significantly higher in individuals from New Zealand populations (Figs. 2f, 4d). This difference was accompanied by a significant range × origin interaction, displaying increased SLA for New Zealand individuals when grown in the German common garden, whereas the range had no significant effect on the SLA of German individuals (Fig. 2f, Table 3). In addition, there were numerous interaction effects of range and origin across all groups of variables indicating increased responses in their respective home common garden: the local individuals concordantly showed higher total biomass as well as maximum expansion in the German and in the New Zealand common garden, compared to the respective foreign individuals (Fig. 2a, c, Table 2). Significant origin × range interaction effects indicate a narrow root:shoot ratio of New Zealand plants in their home range and a wider root:shoot ratio in plants grown in the German common garden, whereas German individuals did not show substantially modified allocation patterns across ranges (Fig. 2b, Table 2). While in the exotic range common garden, maximum leaf length was at a similar level for plants of both local and foreign origins, plants of local origins responded with much longer leaves than those of foreign origins when tested in the native range common garden, thus displaying a significant range × origin interaction (Fig. 2d, Table 3). Also for LDMC and the C:N ratio plants of both origins displayed similarly high values in the exotic range common garden but tended to diverge in the native range only (Fig. 2e, g, Table 3).

We did not find any significant origin × treatment interaction effects pointing at differentiated origin-specific responses to UV radiation, although plants of both origins at least tended to respond differently to the UV treatments in terms of maximum plant expansion and SLA area (Fig. 4b, d, Table 3).

DISCUSSION

To test for the general effects of UV-B radiation on plants and for the impact of different natural UV-B radiation intensities in Germany and New Zealand, we specifically evaluated the significant effects of the applied UV treatments and respective UV treatment × experimental site interaction effects. We furthermore aimed to identify origin differentiation between local and foreign individuals in both common garden experiments according to the second hypothesis by interpretation of origin effects and interaction effects of origin with experimental sites. Finally, we wanted to assess, whether there is even evidence of origin differentiation caused by local adaptation to UV-B radiation regimes in high-UV-B environments as stated in the third hypothesis and supported by UV treatment × origin interaction effects.

Across all variables studied, leaf traits consistently displayed the strongest responses to most of the predictors of range, origin and UV. In contrast, allocation and growth traits were more triggered by range and range × origin interactions, while the number of inflorescences was responsive to range × UV treatment interactions only.

UV effects on plants

The reduction of maximum plant expansion, as well as an overall increase of leaf phenolic concentrations due to solar UV radiation across both ranges confirms previously observed changes in plant morphology and leaf compounds in response to UV radiation (Suchar and Robberecht 2014, Coffey et al. 2017). However, it is most

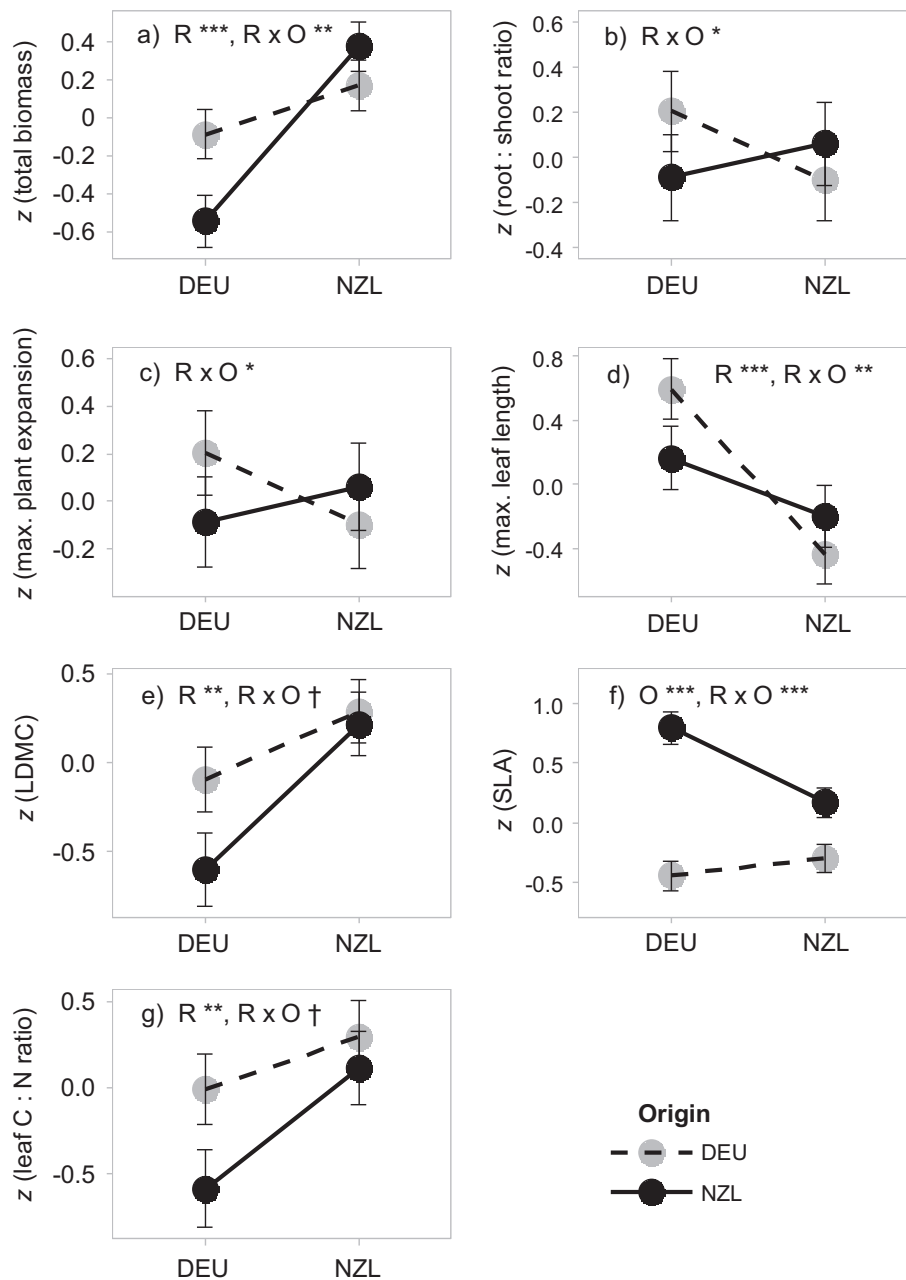

FIG. 2. (a–g) Effects of origins across common gardens. Reaction norms (predicted means \pm SE) of German (gray, dashed line) and New Zealand (black, solid line) populations across the native (DEU) and exotic range (NZL) for (a) total biomass ($n = 287$), (b) root : shoot ratio ($n = 284$), (c) maximum plant expansion ($n = 286$), (d) maximum leaf length ($n = 287$), (e) leaf dry matter content ($n = 264$), (f) specific leaf area ($n = 264$) and (g) leaf carbon : nitrogen ratio ($n = 248$ of 7 species). The number of species included was 8 if not stated differently. Significance levels ($\dagger P < 0.1$, $*P < 0.05$, $**P < 0.01$, $***P < 0.001$) are given for effects of range (R), origin (O) and their interaction (R \times O).

notable that these effects were consistent across multiple species, origins and in different regions. In line with these effects, also total biomass and maximum leaf length tended to be reduced by exposure to full solar wavelengths including all UV components. While phenolics are known to be easily induced by low UV-B doses, only

higher doses additionally trigger a more generic stress response that may involve changes in cell cycle activity and result in biomass/leaf area loss (Robson et al. 2015). This difference in trait responses at different organizational levels ranging from accumulation of a class of compounds within plant cells up to whole-plant responses is

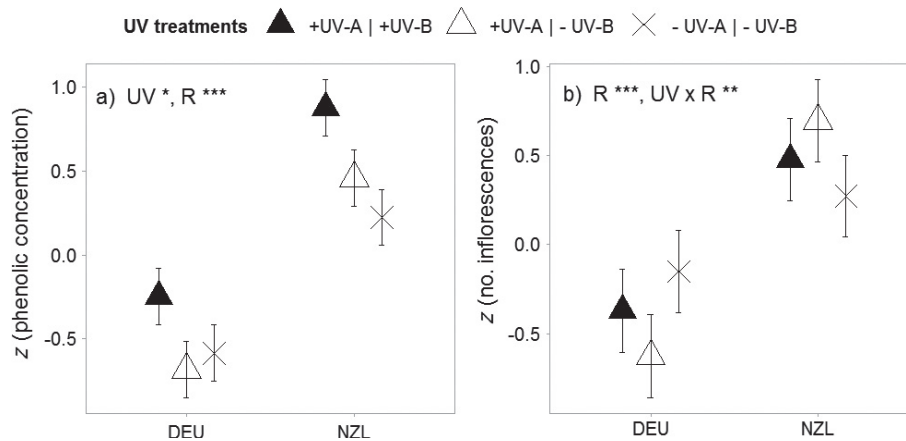

FIG. 3. (a, b) Effects of ultraviolet (UV) treatments in common gardens. Predicted values \pm SE of (a) phenolic concentration ($n = 247$ of 7 species) and (b) the number of inflorescences ($n = 215$ of 6 species) across the native (DEU) and exotic range (NZL) for the UV treatments (+UV-A|+UV-B, +UV-A|-UV-B, -UV-A|-UV-B). Significance levels (* $P < 0.05$, ** $P < 0.01$, *** $P < 0.001$) are given for effects of range (R), UV treatments (UV) and their interaction (UV \times R).

partly reflected in the patterns and in the strength of significance effects encountered in our data set. In contrast to our first hypothesis, the absence of range \times UV treatment interaction effects in leaf and growth traits indicates that UV radiation affected plants similarly in both ranges, despite significant differences in ambient UV intensities between the two experimental sites (Appendix S3). Nevertheless, shorter leaves with higher LDMC and narrower C:N ratio, as well as clearly increased levels of phenolic concentration in plants grown in the New Zealand common garden hint at less favorable environmental conditions as, e.g., caused by higher UV radiation intensities in the exotic range (Bacelar et al. 2015, Robson et al. 2015). However, our results provide evidence for differences in plant responses between the common garden experiments even in the full UV exclusion treatment and, therefore, point at the existence of further local factors that affect plant phenotypes in both ranges in addition to UV radiation. Accordingly, enhanced productivity as expressed in increased plant height and higher total biomass in the exotic range may also be induced by co-varying conditions that are more beneficial in the New Zealand common garden than in the German one, e.g., higher global radiation intensity (as indicated, e.g., by higher global total radiation and higher number of total sun hours in NZ, see Appendix S3), longer day length due to shorter distance to the equator, and consequently higher photosynthesis. In line with these thoughts, in the exotic range common garden only, highest maximum leaf length and number of inflorescences was observed under UV-A exposure in combination with simultaneous UV-B exclusion, pointing at the potentially facilitative effects of high UV-A radiation intensities (Verdaguer et al. 2017) as they might exclusively occur in the southern hemisphere. According to our first hypothesis, plant growth and development were significantly affected by natural UV-B radiation but the effect appeared to be predominantly

independent of experimental site. The observed UV effects on plant physiology and morphology generally emphasize the fundamental importance of this environmental factor for plant growth and development and indicate that differences in both UV-A and UV-B intensities may be involved in explaining differences in performance in plant invasions.

Genetic differentiation and local adaptation in the exotic range

According to the second hypothesis, we expected an origin-dependent differentiation in consequence of divergent selection pressures in the two ranges that might hint at local adaptation. Specific leaf area was the only trait to display an overall difference between origins consistently across all UV levels or ranges tested, with smaller SLA in German than in New Zealand plants. This response obviously suggests genetically fixed differentiation in SLA across different environments as result of a divergent natural selection in the native and exotic range (see also Mozdzer and Ziemann 2010, Leishman et al. 2014). Specific leaf area of New Zealand individuals was furthermore strongly increased when plants were grown in the native range, possibly indicating a release from high-energy wavelengths and hence a lack of necessity for leaf thickening to provide photoprotection. Consistent with SLA responses in plants from New Zealand, there tended to be generally a lower LDMC and a narrower C:N ratio that further decreased when plants were grown in the native range, whereas German individuals did not substantially modify their leaf traits between ranges ($p_{\text{origin:range}} < 0.1$). The development of thinner leaves with reduced LDMC is a syndrome of lower-cost products and might be a useful strategy for New Zealand individuals under elevated UV-B radiation, especially if DNA photorepair works well and epidermal

TABLE 3. Fixed-effect results of the mixed model analysis of leaf traits across both common garden experiments (range).

Source	df _N	Maximum leaf length			Specific leaf area			Leaf dry matter content			C:N			Phenolic concentration		
		df _D	F	P	df _D	F	P	df _D	F	P	df _D	F	P	df _D	F	P
Range	1	258.0	28.180	<0.001***	46.0	2.669	0.109	58.6	11.096	0.002**	205.1	8.808	0.003**	63.0	48.702	<0.001***
UV	2	16.9	3.239	<i>0.064</i>	30.2	0.292	0.749	29.4	0.233	0.794	89.7	0.205	0.815	11.9	4.805	0.030*
Origin	1	13.0	0.158	0.697	14.8	57.949	<0.001***	12.3	2.050	0.177	10.6	2.075	0.179	10.3	0.164	0.693
Experiment duration	1	233.0	0.304	0.582	49.3	0.127	0.723	94.8	6.141	0.015*	155.3	6.202	0.014*	84.1	8.277	0.005**
Range × UV	2	100.5	0.763	0.469	30.2	0.649	0.529	29.4	0.046	0.955	93.6	0.419	0.659	91.8	0.811	0.447
Range × origin	1	239.6	10.936	0.001**	245.5	12.576	<0.001***	245.7	3.541	<i>0.061</i>	222.1	2.810	<i>0.095</i>	213.8	2.698	0.102
UV × origin	2	98.8	0.385	0.681	236.6	2.758	<i>0.065</i>	229.6	0.477	0.621	89.7	1.989	0.143	50.8	1.5180.229	
Range × UV × origin	2	102.2	1.724	0.183	236.7	0.360	0.698	229.6	1.345	0.263	93.6	0.114	0.893	53.8	0.056	0.946

Notes: UV depicts the effect of additional UV treatments, origin refers to the effect of German vs. New Zealand provenance. Harvest traits were standardized by z -transformation within species. Degrees of freedom (df_N = numerator, df_D = denominator), F statistics (F), and significance values (P) are provided. Values in boldface indicate significant P values (* P < 0.05, ** P < 0.01, *** P < 0.001) and values in italic typeface indicate marginal effects. (P < 0.1).

absorbance by secondary metabolites is simultaneously enhanced (Feng et al. 2008, Suchar and Robberecht 2014). This would be worth to be tested in a future study, as following the third hypothesis, New Zealand individuals were expected to evolve such specific adaptations to higher UV-B intensities in the exotic range. In the present study, we were able to show patterns of local adaptation following the “local vs. foreign” criterion (Kawecki and Ebert 2004) by crossed origin × range interactions for several variables of productivity (total biomass), biomass allocation (root:shoot ratio), plant architecture (maximum plant expansion), and leaf traits (leaf length). For these variables, the local individuals reached higher performance in their respective home common gardens, although the “home vs. away” criterion (Kawecki and Ebert 2004) was not met simultaneously in most cases, i.e., performance across ranges might still result in a better performance away from home (Leimu and Fischer 2008). Thus, we found evidence for adaptation of populations to local environmental conditions, resulting in more productive individuals with enhanced competitive ability due to higher investment in aboveground biomass and consequently enhanced space occupation. However, while the discussed local adaptation might be associated with differences in UV intensities between ranges, it may additionally induced by other differences in local selection pressures, e.g., herbivory, pathogens, or macroclimatic factors (Kuhlmann and Müller 2009, Escobar-Bravo et al. 2017).

Although the observed origin differentiation was not clearly attributable to selection by high UV-B intensities (contrary to our third hypothesis), we found a crossed reaction norm of German and New Zealand individuals for maximum plant expansion along the three UV treatments ($p_{\text{origin:treatment}} < 0.1$). Under full solar UV radiation, individuals from the exotic range were characterized by smaller maximum plant expansion compared to the German individuals, whereas the relationship was reversed under total exclusion of UV wavelength. The reduction in size could be either

interpreted as an immediate consequence of UV-B-induced growth inhibition or, as an alternative, might indicate a morphological adaptation of New Zealand individuals to high UV-B radiation intensities in New Zealand, as photodamage might be efficiently prevented by downsizing the UV-B-exposed plant surface area. To elucidate the causal dependency here, one would have to additionally compare fitness traits, e.g., investment in reproductive biomass or number of fertile seeds, and thus test whether fitness is also reduced or being maintained. In contrast to previous studies (Robson et al. 2015, Fraser et al. 2017), German individuals did not show any plant architecture change in response to UV radiation that might hint at a lack of necessity regarding strong photoprotection in their home range. However, both strategies might be a consequence of local selection due to ambient UV-B radiation intensities in the respective home range, as different UV response patterns of German and New Zealand individuals across the UV treatments clearly displayed differentiation of origins within species that is less likely to be affected by other local environmental factors.

Phenotypic plasticity

The various significant interaction effects of origin with range in the present study, but only few general differences between German and New Zealand individuals hint at the importance of trait plasticity, rather than genetic differentiation due to divergent natural selection in the native and exotic range.

The comparison of reaction norm slopes in traits from plants of both origins among different environments allows assessing the role of plasticity by traits (Schlichting and Pigliucci 1998, Kawecki and Ebert 2004, Chun et al. 2007). In the present study, several traits showed notably steeper reaction norm slopes of plants from New Zealand in both common gardens (e.g., SLA, LDMC, C:N ratio) and therefore New Zealand individuals might be considered more plastic in functional leaf traits, which play a major role in photoprotection

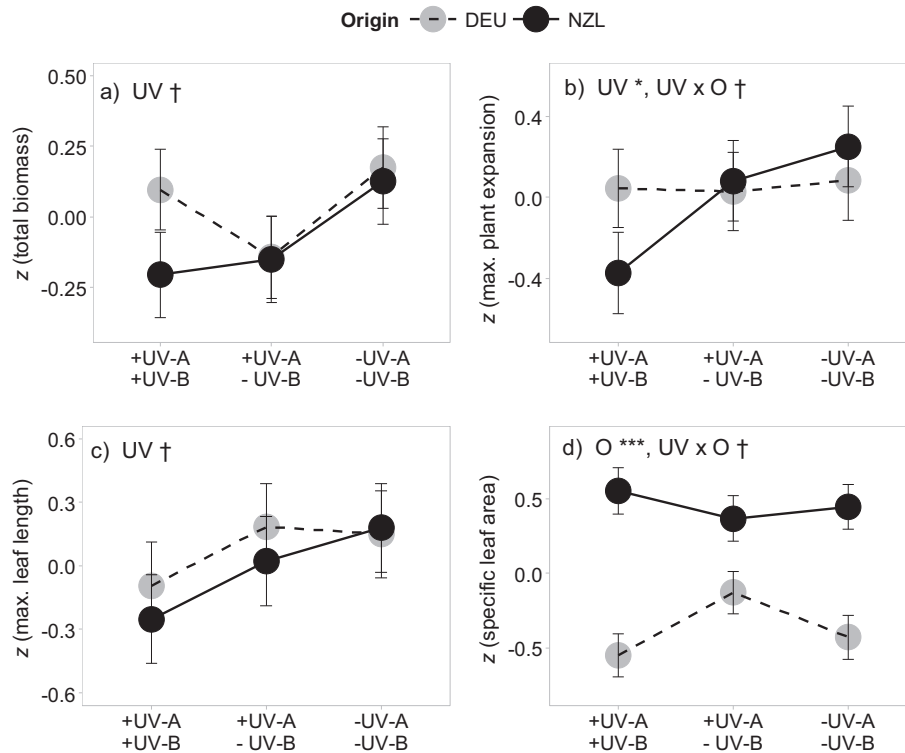

FIG. 4. (a–d) Effects of origin across ultraviolet (UV) treatments. Reaction norms (predicted means \pm SE) of German (gray, dashed line) and New Zealand (black, solid line) populations across the UV treatments (+UV-A|+UV-B, +UV-A|–UV-B, –UV-A|–UV-B) for (a) total biomass ($n = 287$), (b) maximum plant expansion ($n = 286$), (c) maximum leaf length ($n = 287$) and (d) specific leaf area ($n = 264$). The number of species included was 8 if not stated differently. Significance levels ($\dagger P < 0.1$, $*P < 0.05$, $***P < 0.001$) are given for effects of UV treatments (UV), origin (O) and their interaction (UV \times O).

measures of plants and most likely facilitate a higher UV-B tolerance. Accordingly, during colonization, exotic genotypes might also have been selected for high phenotypic plasticity in the exotic range New Zealand (Oplaat and Verhoeven 2015, Turner et al. 2015). Resulting enhanced UV-B tolerance furthermore explains higher plasticity in terms of a stronger increase in productivity (total biomass) in the exotic range. High plasticity of genotypes in traits across different environments (“general-purpose-genotype” according to Parker et al. 2003) has been frequently considered beneficial in the context of colonization of new habitats (Richards et al. 2006, Hulme 2008). It might display a regulatory response of plants to increase their tolerance to changing conditions and therefore adjust their phenotype to site-specific requirements (“adaptive plasticity” according to Donohue et al. 2000, Ghalambor et al. 2007). On the other hand, phenotypic plasticity could just represent the plant’s sensitivity to environmental factors and, thus, moves individuals away from the optimal phenotype (“non-adaptive plasticity” according to van Kleunen and Fischer 2005, Ghalambor et al. 2007). In the present study, enhanced UV-B tolerance combined with a higher performance under moderate or even demanding radiation conditions in high-UV-B environments rather support the concept of “adaptive plasticity” according to

Ghalambor et al. (2007) as a valuable strategy to cope with high UV-B intensities.

In the present study, German individuals were found to be more plastic in leaf length and phenolic concentration, i.e., in variables that are more likely to display photodamage responses to higher UV-B intensities and therefore hint at insufficient physiological photoprotection. One of the rare studies that compared the photoprotective strategies of an invasive species and a coexisting native species (Fenollosa et al. 2017), described an interesting pattern: whereas the native species showed a “saving strategy” by restricting physiological variation to the minimum and only adapted morphologically, the invasive species used an “all-in strategy” by stimulation of multiple photoprotection mechanisms. The authors assume that an all-in strategy would be especially suitable in environments with less predictable climatic conditions. Based on this finding, New Zealand individuals in the present study might have changed their photoprotective strategy to higher physiological plasticity during colonization, similarly as described for an invasive species by Fenollosa et al. (2017).

However, the relative importance of phenotypic plasticity to local adaptation is often assumed to decrease in the course of the colonization process (Dietz and

Edwards 2006, Si et al. 2014, Zenni et al. 2014, Lamarque et al. 2015), and may largely depend also on the cost of plasticity, the mean variance and predictability of the new environment and on whether the novel range actually requires a new optimal phenotype (Lande 2015). Evolution of greater phenotypic plasticity during plant invasions is generally assumed to be costly for species and even more likely constrained in stressful environments, whereas any relief from stressful factors (e.g., enemy release) in the exotic range may facilitate evolution of phenotypic plasticity (Huang et al. 2015). Regarding UV-B, Suchar and Robberecht (2014, 2016) did not find an indication for a direct link between cost for epidermal UV-B absorbing compounds and inhibition of growth. Accordingly, investment in photoprotection by secondary metabolites can be considered a very efficient plant response in high-UV-B environments and might enable evolution of phenotypic plasticity.

CONCLUSIONS

In the present multispecies study, we found evidence for population differentiation of German and New Zealand individuals that allows for some generalization: recent adaptations consequently contributed to better performance of local individuals compared to foreign individuals in both common garden experiments in the native and exotic range, respectively. The observed local adaptation during colonization of high-UV-B environments did not reveal to be directly attributable to selection by UV-B radiation, but might rather be the consequence of selection for genotypes with high phenotypic plasticity. In the present study, the resulting origin differentiation became even evident in response to different UV-B regimes. The importance of well-adapted photoprotection abilities in high-UV-B environments should be more explicitly investigated in future studies, particularly, including long-term approaches to assess plant fitness across generations. In general, the observed combined mechanisms of local adaptation and phenotypic plasticity might enable exotic species to spread farther than it would be expected by their native distribution even into high-UV-B environments.

ACKNOWLEDGMENTS

We thank the Timaru Botanic Gardens and the Southland Seed Savers Network for provision of seeds from New Zealand populations. The seed import to New Zealand could be managed via the International Plant Exchange Network (IPEN), handled by E. Grimm (Botanical Garden of Martin Luther University Halle-Wittenberg) and S. Molloy (Christchurch Botanic Gardens). M. Korver (Manaaki Whenua—Landcare Research) realized leaf sample shipping to Germany. We thank L.-M. Beckmann, N. Bieker, K. Borisova, R. Franke, C. Küver, T. Martens, S. Merseburger, and L. Watermann for helping with plant monitoring and harvest and M. Bahns (Kiel University) and S. Stilwell (Lincoln University) for technical support. The study was financially supported by doctoral scholarships from

the State Postgraduate Scholarship Programme of Saxony-Anhalt and the FAZIT foundation, as well as a DAAD (German Academic Exchange Service) travel grant awarded to M. Hock.

LITERATURE CITED

- Allan Herbarium. 2000. Ngā Tipu o Aotearoa, New Zealand Plant Names Database. Landcare Research, New Zealand. <http://nzflora.landcareresearch.co.nz/>
- Austel, N., E. J. Eilers, T. Meiners, and M. Hilker. 2016. Elm leaves 'warned' by insect egg deposition reduce survival of hatching larvae by a shift in their quantitative leaf metabolite pattern. *Plant, Cell & Environment* 39:366–376.
- Bacelar, E., J. Moutinho-Pereira, H. Ferreira, and C. Correia. 2015. Enhanced ultraviolet-B radiation affect growth, yield and physiological processes on triticale plants. *Procedia Environmental Sciences* 29:219–220.
- Barnes, P. W., M. A. Tobler, K. Keefover-Ring, S. D. Flint, A. E. Barkley, R. J. Ryel, and R. L. Lindroth. 2016. Rapid modulation of ultraviolet shielding in plants is influenced by solar ultraviolet radiation and linked to alterations in flavonoids. *Plant, Cell & Environment* 39:222–230.
- Bates, D., M. Maechler, B. Bolker, and S. Walker. 2015. Fitting linear mixed-effects models using lme4. *Journal of Statistical Software* 67:1–48.
- Beckmann, M., M. Hock, H. Bruelheide, and A. Erfmeier. 2012. The role of UV-B radiation in the invasion of *Hieracium pilosella*—a comparison of German and New Zealand plants. *Environmental and Experimental Botany* 75:173–180.
- Blossey, B., and R. Nötzold. 1995. Evolution of increased competitive ability in invasive non-indigenous plants: a hypothesis. *Journal of Ecology* 83:887–889.
- Bodeker, G. E., H. Shiona, R. Scott-Weekley, K. Oltmanns, P. King, H. Chisholm, and R. L. McKenzie. 2006. UV Atlas version 2: What you get for your money. UV radiation and its effects: an update 8-9 https://www.niwa.co.nz/our-services/online-services/uv-and-ozone/uv-atlasproj_desc
- Chen, D., S. Wang, B. Xiong, B. Cao, and X. Deng. 2015. Carbon/nitrogen imbalance associated with drought-induced leaf senescence in *Sorghum bicolor*. *PLoS ONE* 10:1–17.
- Chun, Y. J., M. L. Collyer, K. A. Moloney, and J. D. Nason. 2007. Phenotypic plasticity of native vs. invasive purple loosestrife: a two-state multivariate approach. *Ecology* 88:1499–1512.
- Coffey, A., E. Prinsen, M. A. K. Jansen, and J. Conway. 2017. The UVB photoreceptor UVR8 mediates accumulation of UV-absorbing pigments, but not changes in plant morphology, under outdoor conditions. *Plant, Cell & Environment* 40:2250–2260.
- Colautti, R. I., and S. C. Barrett. 2013. Rapid adaptation to climate facilitates range expansion of an invasive plant. *Science* 342:364–366.
- Dietz, H., and P. J. Edwards. 2006. Recognition that causal processes change during plant invasion helps explain conflicts in evidence. *Ecology* 87:1359–1367.
- Dlugosch, K. M., F. A. Cang, B. S. Barker, K. Andonian, S. M. Swope, and L. H. Rieseberg. 2015. Evolution of invasiveness through increased resource use in a vacant niche. *Nature Plants* 1:1–5.
- Donohue, K., D. Messiqua, E. Hammond Pyle, M. S. Heschel, and J. Schmitt. 2000. Evidence of adaptive divergence in plasticity: density- and site-dependent selection on shade-avoidance responses in *Impatiens capensis*. *Evolution* 54:1956–1968.
- Elst, E. M., K. P. Acharya, P. A. Dar, Z. A. Reshi, J. Tufto, I. Nijs, and B. J. Graae. 2016. Pre-adaptation or genetic shift

- after introduction in the invasive species *Impatiens glandulifera*? *Acta Oecologica* 70:60–66.
- Erfmeier, A. 2013. Constraints and release at different scales—the role of adaptation in biological invasions. *Basic and Applied Ecology* 14:281–288.
- Escobar-Bravo, R., P. G. Klinkhamer, and K. A. Leiss. 2017. Interactive effects of UV-B light with abiotic factors on plant growth and chemistry, and their consequences for defense against arthropod herbivores. *Frontiers in Plant Science* 8:1–14.
- Felker-Quinn, E., J. A. Schweitzer, and J. K. Bailey. 2013. Meta-analysis reveals evolution in invasive plant species but little support for Evolution of Increased Competitive Ability (EICA). *Ecology and Evolution* 3:739–751.
- Feng, Y. L., G. L. Fu, and Y. L. Zheng. 2008. Specific leaf area relates to the differences in leaf construction cost, photosynthesis, nitrogen allocation, and use efficiencies between invasive and noninvasive alien congeners. *Planta* 228:383–390.
- Fenollosa, E., S. Munné-Bosch, and M. Pintó-Marijuan. 2017. Contrasting phenotypic plasticity in the photoprotective strategies of the invasive species *Carpobrotus edulis* and the coexisting native species *Crithmum maritimum*. *Physiologia Plantarum* 160:185–200.
- Flory, S. L., F. Long, and K. Clay. 2011. Invasive *Microstegium* populations consistently outperform native range populations across diverse environments. *Ecology* 92:2248–2257.
- Fraser, D. P., A. Sharma, T. Fletcher, S. Budge, C. Moncrieff, A. N. Dodd, and K. A. Franklin. 2017. UV-B antagonises shade avoidance and increases levels of the flavonoid quercetin in coriander (*Coriandrum sativum*). *Scientific Reports* 7:17758.
- Ghalambor, C. K., J. K. McKay, S. P. Carroll, and D. N. Reznick. 2007. Adaptive versus non-adaptive phenotypic plasticity and the potential for contemporary adaptation in new environments. *Functional Ecology* 21:394–407.
- Godar, D. E. 2007. UV doses worldwide. *Photochemistry and Photobiology* 81:736–749.
- Haider, S., C. Kueffer, P. J. Edwards, and J. M. Alexander. 2012. Genetically based differentiation in growth of multiple non-native plant species along a steep environmental gradient. *Oecologia* 170:89–99.
- Hock, M., M. Beckmann, R. W. Hofmann, H. Bruelheide, and A. Erfmeier. 2015. Effects of UV-B radiation on germination characteristics in invasive plants in New Zealand. *NeoBiota* 26:21–37.
- Howell, C. J., and J. W. D. Sawyer. 2006. New Zealand naturalised vascular plant checklist. New Zealand Plant Conservation Network, Wellington, New Zealand.
- Huang, Q. Q., X. Y. Pan, Z. W. Fan, and S. L. Peng. 2015. Stress relief may promote the evolution of greater phenotypic plasticity in exotic invasive species: a hypothesis. *Ecology and Evolution* 5:1169–1177.
- Hulme, P. E. 2008. Phenotypic plasticity and plant invasions: Is it all Jack? *Functional Ecology* 22:3–7.
- Hulme, P. E. 2009. Trade, transport and trouble: managing invasive species pathways in an era of globalization. *Journal of Applied Ecology* 46:10–18.
- Kataria, S., A. Jajoo, and K. N. Guruprasad. 2014. Impact of increasing Ultraviolet-B (UV-B) radiation on photosynthetic processes. *Journal of Photochemistry and Photobiology B: Biology* 137:55–66.
- Kawecki, T. J., and D. Ebert. 2004. Conceptual issues in local adaptation. *Ecology Letters* 7:1225–1241.
- Kueffer, C., C. C. Daehler, C. W. Torres-Santana, C. Lavergne, J. Y. Meyer, R. Otto, and L. Silva. 2010. A global comparison of plant invasions on oceanic islands. *Perspectives in Plant Ecology, Evolution and Systematics* 12:145–161.
- Kuhlmann, F., and C. Müller. 2009. Development-dependent effects of UV radiation exposure on broccoli plants and interactions with herbivorous insects. *Environmental and Experimental Botany* 66:61–68.
- Kuhlmann, F., and C. Müller. 2011. Impact of ultraviolet radiation on interactions between plants and herbivorous insects: a chemo-ecological perspective. Pages 305–347 in U. E. Lüttge, W. Beyschlag, B. Büdel, and D. Francis, editors. *Progress in botany* 72. Springer Science + Business Media, Berlin, Germany.
- Kuznetsova, A., P. B. Brockhoff, and R. H. B. Christensen. 2016. lmerTest: tests in linear mixed effects models. R package version 2.0-33. <https://CRAN.R-project.org/package=lmerTest>
- Lamarque, L. J., C. J. Lortie, A. J. Porté, and S. Delzon. 2015. Genetic differentiation and phenotypic plasticity in life-history traits between native and introduced populations of invasive maple trees. *Biological Invasions* 17:1109–1122.
- Lande, R. 2015. Evolution of phenotypic plasticity in colonizing species. *Molecular Ecology* 24:2038–2045.
- Leimu, R., and M. Fischer. 2008. A meta-analysis of local adaptation in plants. *PLoS ONE* 3:1–8.
- Leishman, M. R., J. Cooke, and D. M. Richardson. 2014. Evidence for shifts to faster growth strategies in the new ranges of invasive alien plants. *Journal of Ecology* 102:1451–1461.
- Lin, T., P. G. Klinkhamer, and K. Vrieling. 2015. Parallel evolution in an invasive plant: effect of herbivores on competitive ability and regrowth of *Jacobaea vulgaris*. *Ecology Letters* 18:668–676.
- Llorens, L., F. R. Badenes-Pérez, R. Julkunen-Tiitto, C. Zidorn, A. Fereres, and M. A. Jansen. 2015. The role of UV-B radiation in plant sexual reproduction. *Perspectives in Plant Ecology, Evolution and Systematics* 17:243–254.
- Lodge, D. M., et al. 2006. Biological invasions: recommendations for U.S. policy and management. *Ecological Applications* 16:2035–2054.
- Maron, J. L., M. Vilà, R. Bommarco, S. Elmendorf, and P. Beardsley. 2004. Rapid evolution of an invasive plant. *Ecological Monographs* 74:261–280.
- McKenzie, R. L., P. J. Aucamp, A. F. Bais, L. O. Björn, and M. Ilyas. 2007. Changes in biologically-active ultraviolet radiation reaching the Earth's surface. *Photochemical & Photobiological Sciences* 6:218–231.
- McKenzie, R. L., P. J. Aucamp, A. F. Bais, L. O. Björn, M. Ilyas, and S. Madronich. 2011. Ozone depletion and climate change: impacts on UV radiation. *Photochemical & Photobiological Sciences* 10:182–198.
- Molina-Montenegro, M. A., C. Palma-Rojas, Y. Alcayaga-Olivares, R. Oses, L. J. Corcuera, L. A. Cavieres, and E. Gianoli. 2013. Ecophysiological plasticity and local differentiation help explain the invasion success of *Taraxacum officinale* (dandelion) in South America. *Ecography* 36:718–730.
- Mozdzer, T. J., and J. C. Zieman. 2010. Ecophysiological differences between genetic lineages facilitate the invasion of non-native *Phragmites australis* in North American Atlantic coast wetlands. *Journal of Ecology* 98:451–458.
- Müller, C. 2018. Evolution of increased competitive ability and shifting defence hypotheses. Pages 103–123 in J. M. Jeschke and T. Heger, editors. *Invasion biology: hypotheses and evidence*. CAB International, Wallingford, UK.
- Nicotra, A. B., et al. 2010. Plant phenotypic plasticity in a changing climate. *Trends in Plant Science* 15:684–692.
- Oduor, A. M., R. Leimu, and M. van Kleunen. 2016. Invasive plant species are locally adapted just as frequently and at least as strongly as native plant species. *Journal of Ecology* 104:957–968.

- Oplaat, C., and K. J. Verhoeven. 2015. Range expansion in asexual dandelions: Selection for general-purpose genotypes? *Journal of Ecology* 103:261–268.
- Parker, I. M., J. Rodriguez, and M. E. Loik. 2003. An evolutionary approach to understanding the biology of invasions: local adaptation and general-purpose genotypes in the weed *Verbascum thapsus*. *Conservation Biology* 17:59–72.
- R Core Team. 2017. R: a language and environment for statistical computing. R Foundation for Statistical Computing, Vienna, Austria. <https://www.R-project.org/>
- Richards, C. L., O. Bossdorf, N. Z. Muth, J. Gurevitch, and M. Pigliucci. 2006. Jack of all trades, master of some? On the role of phenotypic plasticity in plant invasions. *Ecology Letters* 9:981–993.
- Robson, T., K. Klem, O. Urban, and M. A. Jansen. 2015. Re-interpreting plant morphological responses to UV-B radiation. *Plant, Cell & Environment* 38:856–866.
- Ruprecht, E., A. Fenesi, and I. Nijs. 2014. Are plasticity in functional traits and constancy in performance traits linked with invasiveness? An experimental test comparing invasive and naturalized plant species. *Biological Invasions* 16:1359–1372.
- Schlaepfer, D. R., M. Glättli, M. Fischer, and M. van Kleunen. 2010. A multi-species experiment in their native range indicates pre-adaptation of invasive alienplant species. *New Phytologist* 185:1087–1099.
- Schlichting, C. D., and M. Pigliucci. 1998. Phenotypic evolution: a reaction norm perspective. Sinauer Associates, Sunderland, Massachusetts, USA.
- Seckmeyer, G., and R. L. McKenzie. 1992. Increased ultraviolet radiation in New Zealand (45 S) relative to Germany (48 N). *Nature* 359:135–137.
- Si, C. C., Z. C. Dai, Y. Lin, S. S. Qi, P. Huang, S. L. Miao, and D. L. Du. 2014. Local adaptation and phenotypic plasticity both occurred in *Wedelia trilobata* invasion across a tropical island. *Biological Invasions* 16:2323–2337.
- Štroch, M., Z. Materová, D. Vrábl, V. Karlický, L. Šigut, J. Nežval, and V. Špunda. 2015. Protective effect of UV-A radiation during acclimation of the photosynthetic apparatus to UV-B treatment. *Plant Physiology and Biochemistry* 96:90–96.
- Suchar, V. A., and R. Robberecht. 2014. Integration and scaling of UV-B radiation effects on plants: from DNA to leaf. *Ecology and Evolution* 5:2544–2555.
- Suchar, V. A., and R. Robberecht. 2016. Integration and scaling of UV-B radiation effects on plants: from molecular interactions to whole plant responses. *Ecology and Evolution* 6:4866–4884.
- Turner, K. G., H. Fréville, and L. H. Rieseberg. 2015. Adaptive plasticity and niche expansion in an invasive thistle. *Ecology and Evolution* 5:3183–3197.
- Ulm, R., and G. I. Jenkins. 2015. Q&A: How do plants sense and respond to UV-B radiation? *BMC Biology* 13:1–6.
- van Kleunen, M., and M. Fischer. 2005. Constraints on the evolution of adaptive phenotypic plasticity in plants. *New Phytologist* 166:49–60.
- Vandepitte, K., T. Meyer, K. Helsen, K. Acker, I. Roldán-Ruiz, J. Mergeay, and O. Honnay. 2014. Rapid genetic adaptation precedes the spread of an exotic plant species. *Molecular Ecology* 23:2157–2164.
- Verdaguer, D., M. A. Jansen, L. Llorens, L. O. Morales, and S. Neugart. 2017. UV-A radiation effects on higher plants: exploring the known unknown. *Plant Science* 255:72–81.
- Wang, H., X. Ma, L. Zhang, E. Siemann, and J. Zou. 2015. UV-B has larger negative impacts on invasive populations of *Triadica sebifera* but ozone impacts do not vary. *Journal of Plant Ecology* 9:61–68.
- Watanabe, S., T. Takemura, K. Sudo, T. Yokohata, and H. Kawase. 2012. Anthropogenic changes in the surface all-sky UV-B radiation through 1850–2005 simulated by an Earth system model. *Atmospheric Chemistry and Physics* 12:5249–5257.
- Zenni, R. D., J. B. Lamy, L. J. Lamarque, and A. J. Porté. 2014. Adaptive evolution and phenotypic plasticity during naturalization and spread of invasive species: implications for tree invasion biology. *Biological Invasions* 16:635–644.
- Ziska, L. H., M. B. Tomecek, M. Valerio, and J. P. Thompson. 2015. Evidence for recent evolution in an invasive species, *Microstegium vimineum*, Japanese stiltgrass. *Weed Research* 55:260–267.
- Zuur, A. F., E. N. Ieno, N. J. Walker, A. A. Saveliev, and G. M. Smith. 2009. Mixed effects modelling for nested data. Pages 101–142 in M. Gail, K. Krickeberg, J. M. Samet, A. Tsiatis, and W. Wong, editors. *Mixed effects models and extensions in ecology with R*. Statistics for biology and health. Springer, New York, New York, USA.

SUPPORTING INFORMATION

Additional supporting information may be found in the online version of this article at <http://onlinelibrary.wiley.com/doi/10.1002/ecy.2665/supinfo>

DATA AVAILABILITY

Data are available from the Dryad Digital Repository: <https://doi.org/10.5061/dryad.g2n986g>

Chapter IV: Combined effects of UV-B and drought on native and exotic populations of *Verbascum thapsus* L.

M. Hock, C. Plos, M. Sporbert & A. Erfmeier

published in *Plants* 9(2), 269 (2020), DOI: 10.3390/plants9020269

Abstract:

During plant invasions, exotic species have to face new environmental challenges and are affected by interacting components of global change, which may include more stressful environmental conditions. We investigated an invasive species of New Zealand grasslands, commonly exposed to two concomitant and limiting abiotic factors—high levels of ultraviolet-B radiation and drought. The extent to which *Verbascum thapsus* may respond to these interacting stress factors via adaptive responses was assessed in a greenhouse experiment comprising native German plants and plants of exotic New Zealand origins. Plants from both origins were grown within four treatments resulting from the crossed combinations of two levels of UV-B and drought. Over twelve weeks, we recorded growth, morphological characteristics, physiological responses and productivity. The results showed that drought stress had the strongest effect on biomass, morphology and physiology. Significant effects of UV-B radiation were restricted to variables of leaf morphology and physiology. We found neither evidence for additive effects of UV-B and drought nor origin-dependent stress responses that would indicate local adaptation of native or exotic populations. We conclude that drought-resistant plant species might be predisposed to handle high UV-B levels, but emphasize the importance of setting comparable magnitudes in stress levels when testing experimentally for antagonistic interaction effects between two manipulated factors.

Article

Combined Effects of UV-B and Drought on Native and Exotic Populations of *Verbascum thapsus* L.

Maria Hock ^{1,2,*} , Carolin Plos ^{2,3}, Maria Sporbert ^{2,3,4}  and Alexandra Erfmeier ^{1,3} 

¹ Kiel University, Institute for Ecosystem Research/Geobotany, Olshausenstr. 75, 24118 Kiel, Germany; aerfmeier@ecology.uni-kiel.de

² Martin Luther University Halle-Wittenberg, Institute of Biology/Geobotany and Botanical Garden, Am Kirchtor 1, 06108 Halle, Germany; carolin.plos@botanik.uni-halle.de (C.P.); maria.sporbert@botanik.uni-halle.de (M.S.)

³ German Centre for Integrative Biodiversity Research (iDiv) Halle-Jena-Leipzig, Deutscher Platz 5E, 04103 Leipzig, Germany

⁴ Friedrich Schiller University Jena, Institute of Ecology and Evolution/Plant Biodiversity, Philosophenweg 16, 07743 Jena, Germany

* Correspondence: mhock@ecology.uni-kiel.de

Received: 17 January 2020; Accepted: 14 February 2020; Published: 18 February 2020



Abstract: During plant invasions, exotic species have to face new environmental challenges and are affected by interacting components of global change, which may include more stressful environmental conditions. We investigated an invasive species of New Zealand grasslands, commonly exposed to two concomitant and limiting abiotic factors—high levels of ultraviolet-B radiation and drought. The extent to which *Verbascum thapsus* may respond to these interacting stress factors via adaptive responses was assessed in a greenhouse experiment comprising native German plants and plants of exotic New Zealand origins. Plants from both origins were grown within four treatments resulting from the crossed combinations of two levels of UV-B and drought. Over twelve weeks, we recorded growth, morphological characteristics, physiological responses and productivity. The results showed that drought stress had the strongest effect on biomass, morphology and physiology. Significant effects of UV-B radiation were restricted to variables of leaf morphology and physiology. We found neither evidence for additive effects of UV-B and drought nor origin-dependent stress responses that would indicate local adaptation of native or exotic populations. We conclude that drought-resistant plant species might be predisposed to handle high UV-B levels, but emphasize the importance of setting comparable magnitudes in stress levels when testing experimentally for antagonistic interaction effects between two manipulated factors.

Keywords: additive effect; common mullein; cross-resistance; environmental filter; greenhouse experiment; local adaptation; plant invasions; native vs. non-native populations; New Zealand; synergistic effect

1. Introduction

Biological plant invasions are a key aspect of global change [1] and their mechanisms and preconditions have been frequently investigated to date [2–4]. A species has to overcome a number of barriers before it can be considered invasive elsewhere [5], among them biotic and abiotic conditions in the invaded range (see also [6]). Several mechanisms, including plastic and adaptive responses, which enable plant species to handle novel environmental conditions, have been repeatedly addressed. High phenotypic plasticity allows a genotype to develop different phenotypes in response to heterogeneous environments and is an often-observed advantageous property of invasive species, e.g., [7,8]. By contrast, pre-adaptation to particular environmental factors represented in single populations in the native range [9], as well as

more recent adaptive evolution to novel environments following natural selection in the invaded range, can strongly contribute to a species' invasive potential [10,11].

Addressing the role of large-scale abiotic factors as environmental barriers during plant invasions has so far mostly dealt with climatic conditions in native and invaded ranges and associated climatic niches of invasive species based on temperature and humidity tolerance [12,13]. Overall irradiation and biologically active UV-B radiation levels are equally subjected to climate change and are becoming more important for both resident plant communities and plant invasions [14]. However, these factors have been largely neglected in plant invasion research (see however: [15–17]). The effects of global change have largely been under consideration to date as 'one-factor-only' approaches. However, more recent research ambitions have identified the importance of testing for the role of interacting environmental factors [18–21].

The single effects of two environmental factors might be more or less linked so that their combined effect on plants cannot be directly extrapolated from plant response to each stress applied individually [22]. Two abiotic factors generally interact either in an additive, synergistic or antagonistic way [21,23]. A detrimental synergy of two limiting factors occurs, for instance, if the magnitude of the combined effect of both stressors exceeds the sum of the single stressor effects, as it has been observed, e.g., for jointly applied drought and heat stress on plants (see [22]). Another presumable scenario is an antagonistic interaction of stressors—a so-called cross-resistance—to both stresses by a decrease of sensitivity to one environmental factor during exposure to the other as it was previously described, e.g., in the field of biotic interactions of plants with herbivores and pathogens [24]. In natural habitats, some climatic factors are typically coupled, e.g., high solar radiation and high temperature [25]. The individual and combined contributions of these factors to plant responses can only be quantified experimentally in controlled environments.

High radiation levels and high growing season temperatures are characteristic for temperate grasslands at the global scale and they often occur in combination with low water availability. Distinctively higher levels of UV-B radiation additionally apply to the Southern hemisphere when compared to comparable sites in the Northern hemisphere where many invasive plants originate [26]. High levels of UV-B affect several plant responses more rapidly and with stronger effects in herbaceous plant species than in woody species [27]. Therefore, in particular, grassland ecosystems can be supposed to show strong responses to UV-B and should receive more attention as UV-B radiation levels continue to vary and thus to be a component of global change [28].

UV-B radiation causes interferences at different organizational levels of plants, including DNA damage, limitation of photosynthesis and morphological changes due to decreasing phytohormone concentrations (e.g., IAA [29]). Consequently, UV-B-exposed plants suffer from reductions in biomass, height and leaf area [29–31] and experience changes in functional leaf traits, e.g., an increasing leaf dry matter content [16]. Effective UV-B protection can be provided by strengthening epidermal or cuticular structures and trichomes on the upper leaf surface [32,33], as well as by the incorporation of UV-B absorbing flavonoids and anthocyanins [29]. These protection measures can also be advantageous in regulating plants' water balance [34]. In their review of effects of drought stress in plants, Jaleel et al. [35] identified drought as one of the most important abiotic environmental stress factors and described several effects on plants that are similar to consequences of UV-B, including biomass reduction, decreases in plant height and leaf area and changes in dry matter content and photosynthetic pigments.

The effects of drought and high UV-B intensities on plants have been frequently investigated individually, but have been addressed in combination less often. Additive detrimental effects of UV-B radiation and drought were shown, for example, for *Populus cathayana* [36] in terms of plant height and leaf area reduction, such as for total biomass decrease of the shrub *Hippophae rhamnoides* [37]. In a soybean (*Glycine max*) study, there was no evidence for additive effects of both abiotic factors in growth response and seed yield [38]. However, results of other studies indicated antagonistic effects of UV-B and drought in crops [39], in European heathland species [40] and even in conifer species [41,42]. Both environmental factors provoke an oxidative burst and, thus, can jointly induce protective measures.

Moreover, several studies even revealed different adaptive responses of congeneric species or distinct populations within species dependent on local conditions of their origin. Comparing high altitude and low altitude *Populus* species (*P. kangdingensis*, *P. cathayana*) or *Hippophae rhamnoides* populations, respectively, high altitude individuals exhibited higher tolerance to drought in the presence of UV-B, whereas low altitude individuals showed additive damaging effects [36,37]. Consistent with these results, Hofmann et al. [43] found higher physiological acclimation capacity of stress-adapted slow growing *Trifolium repens* ecotypes under high UV-B radiation compared to other populations. UV-B × drought interactions have been predominantly examined for crops and woody species, but not yet considered with regard to plant invasions into grasslands.

In the present study, we compared native (German) and invasive (New Zealand) populations of the grassland species *Verbascum thapsus* L. in response to combined drought stress and UV-B radiation in a greenhouse experiment (Figure 1). We tested for pre-adaptation to UV-B radiation in native populations from Germany as being induced by high drought tolerance, and for recent local adaptation of exotic populations from New Zealand in growth and physiological responses. We addressed the hypotheses that i) the combined stress of UV-B and drought has an antagonistic effect on plants and ii) New Zealand populations are better adapted to high UV-B levels providing evidence of recent adaptation. To the best of our knowledge, this is the first study addressing the role of combined environmental stress of UV-B and drought for native and exotic origins in the context of plant invasion processes in the southern hemisphere.

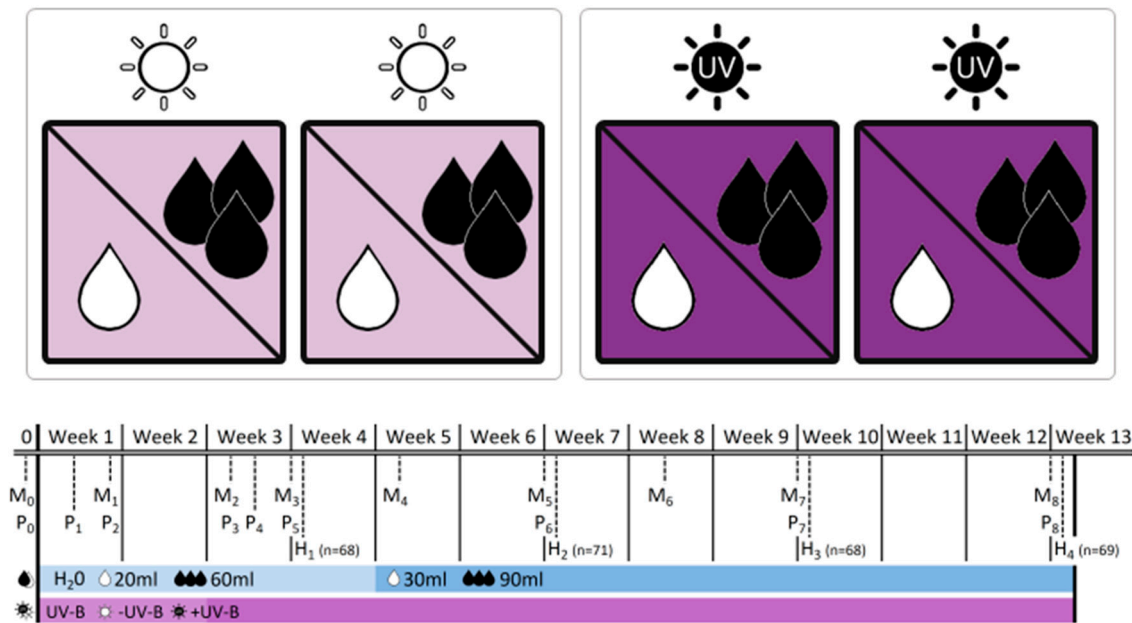

Figure 1. Experimental design of the greenhouse experiment indicating the four experimental boxes and the crossed application of ultraviolet-B (UV-B levels: ☀ -UV-B/☀ +UV-B) and water treatment (water levels: ● low/●●● well-watered). The table provides information on the dates of monitoring (M_x), physiological measurements (P_x) and biomass harvests (H_x) during the 12-week experimental period, and adds information on the treatment intensity applied. Note that levels of water addition were adjusted after 4 weeks to account for rapid initial increase in plant size.

2. Results

2.1. Biomass Data (Harvest Data H_x)

At the first harvest, aboveground, belowground and total biomasses of German individuals were significantly higher (+26% on average), than biomass of exotic individuals ($p < 0.05$, Table 1 and Table S1). Overall, productivity was not significantly affected by UV-B radiation at any time point. Aboveground, belowground and total biomass were significantly reduced by about 40%–50% due to limited water availability at all four harvest dates ($p < 0.001$, Table 1 and Table S1). By contrast, water limitation significantly increased the shoot:mass ratio among all harvest dates, as well as root dry matter content at the first and the third harvest (Table 1). At the fourth harvest, German individuals showed a more pronounced decrease in belowground and total biomass, and a consequently stronger increase in the shoot:mass ratio under limited water availability conditions compared with New Zealand individuals, as evidenced by a significant origin \times water treatment interaction ($p < 0.05$, Table 1 and Table S1). Significant interaction effects of UV-B treatment and water treatment occurred only at the second harvest date (Table 1): when averaging over native and exotic origin, an UV-B-induced reduction of belowground biomass was less apparent under additional water limitation ($p = 0.012$, Figure 2a, Table S1). In well-watered conditions, a decrease of root dry matter content (−9% on average) was observed under UV-B exposure, whereas an increase of root dry matter content (+6% on average) was caused by the combined application of UV-B and limited water availability ($p = 0.032$, Figure 2b, Table S1).

Table 1. Fixed-effect results of the harvest data analysis. “UV-B” and “Water” depict the effect of treatments and “Origin” refers to the effect of German vs. New Zealand provenance. Degrees of freedom (df_N = numerator, df_D = denominator), F statistics (F) and significance values (p) are provided. Significant p-values (* $p < 0.05$; ** $p < 0.01$; *** $p < 0.001$) and marginal effects ($p < 0.1$) are indicated.

Variable/Source	df_N	1st Harvest (3 Weeks)			2nd Harvest (6 Weeks)			3rd Harvest (9 Weeks)			4th Harvest (12 Weeks)			
		df_D	F	p	df_D	F	p	df_D	F	p	df_D	F	p	
Total biomass														
Origin	1	57.1	5.449	0.023	*	17.9	2.415	0.138	23.2	0.146	0.706	18.9	2.929	0.103
UV-B	1	1.3	0.001	0.984		2.0	0.483	0.560	44.5	2.448	0.125	45.2	0.064	0.801
Water	1	58.3	30.522	<0.001	***	43.6	156.263	<0.001	***	44.7	85.480	<0.001	***	123.432
Initial leaf number (Covariate)	1	57.2	30.682	<0.001	***	34.6	18.697	<0.001	***	58.6	14.589	<0.001	***	16.040
Origin × UV-B	1	57.0	0.185	0.669		44.2	0.047	0.829	44.6	0.250	0.619	45.1	0.318	0.575
Origin × Water	1	26.6	0.797	0.380		44.0	3.692	0.061	44.6	0.164	0.688	45.2	4.241	0.045
UV-B × Water	1	58.3	0.001	0.975		44.5	0.809	0.373	44.7	0.762	0.387	45.1	0.617	0.436
Origin × UV-B × Water	1	26.2	0.238	0.629		43.3	0.098	0.755	44.6	0.020	0.888	46.7	0.195	0.661
Aboveground biomass														
Origin	1	57.1	5.281	0.025	*	18.5	1.777	0.199	23.2	0.064	0.802	18.5	1.430	0.247
UV-B	1	1.3	0.036	0.875		43.6	0.118	0.733	44.7	0.628	0.432	44.8	0.075	0.786
Water	1	58.3	26.053	<0.001	***	45.3	82.856	<0.001	***	44.8	58.462	<0.001	***	49.639
Initial leaf number (Covariate)	1	57.2	28.713	<0.001	***	37.8	12.078	0.001	**	58.2	16.458	<0.001	***	7.827
Origin × UV-B	1	57.0	0.504	0.480		46.2	0.000	0.988	44.7	0.316	0.577	44.7	0.441	0.510
Origin × Water	1	25.4	0.297	0.590		46.3	0.926	0.341	44.7	0.078	0.782	44.8	0.088	0.768
UV-B × Water	1	58.3	0.004	0.952		46.3	0.000	0.988	44.8	0.175	0.678	44.8	1.862	0.179
Origin × UV-B × Water	1	25.1	0.464	0.502		45.7	0.011	0.918	44.7	0.055	0.816	46.1	0.051	0.823
Belowground biomass														
Origin	1	57.1	4.137	0.047	*	17.8	2.915	0.105	23.9	0.100	0.755	18.9	4.035	0.059
UV-B	1	1.2	0.471	0.602		2.0	2.905	0.232	1.7	1.413	0.374	1.7	0.353	0.620
Water	1	58.6	33.416	<0.001	***	44.3	250.101	<0.001	***	44.8	83.539	<0.001	***	135.924
Initial leaf number (Covariate)	1	57.3	26.224	<0.001	***	28.5	29.625	<0.001	***	57.0	9.803	0.003	**	51.3
Origin × UV-B	1	57.0	0.160	0.691		45.0	0.574	0.453	42.8	0.109	0.742	43.8	0.126	0.724
Origin × Water	1	16.5	3.488	0.080		45.0	12.119	0.001	**	44.8	2.071	0.157	45.7	11.764
UV-B × Water	1	58.6	0.084	0.773		45.0	6.936	0.012	*	44.9	0.347	0.559	45.7	0.015
Origin × UV-B × Water	1	16.2	0.091	0.766		44.3	0.462	0.500	44.9	0.008	0.928	47.6	0.649	0.424

Table 1. Cont.

Shoot:mass ratio														
Origin	1	17.1	0.195	0.664		20.0	0.946	0.342		57.4	0.837	0.364	0.870	0.365
UV-B	1	44.9	3.788	0.058		1.9	8.108	0.108		1.8	1.405	0.368	6.740	0.141
Water	1	45.9	4.413	0.041	*	45.8	69.580	<0.001	***	59.0	95.446	<0.001	463.820	<0.001
Initial leaf number (Covariate)	1	47.2	1.465	0.232		38.8	0.421	0.520		57.9	0.0225	0.637	14.310	<0.001
Origin × UV-B	1	44.8	0.765	0.386		46.2	0.007	0.933		57.0	0.217	0.643	1.700	0.200
Origin × Water	1	44.9	2.113	0.153		46.0	0.028	0.868		59.0	0.319	0.575	4.660	0.037
UV-B × Water	1	45.5	0.005	0.944		46.7	0.714	0.402		59.0	0.045	0.833	0.040	0.845
Origin × UV-B × Water	1	44.7	0.437	0.512		45.3	0.086	0.771		59.0	0.281	0.598	44.2	0.062
Root dry matter content														
Origin	1	57.1	0.085	0.772		61.2	4.562	0.037	*	59.0	0.912	0.344	0.011	0.919
UV-B	1	1.2	0.856	0.503		1.9	0.057	0.835		59.0	0.964	0.330	3.427	0.069
Water	1	58.5	17.623	<0.001	***	61.7	1.998	0.162		59.0	4.820	0.032	0.791	0.377
Initial leaf number (Covariate)	1	57.3	5.020	0.029	*	61.9	0.002	0.961		59.0	0.602	0.441	5.606	0.021
Origin × UV-B	1	57.0	0.893	0.349		60.4	1.354	0.249		59.0	0.234	0.630	0.562	0.456
Origin × Water	1	17.6	0.002	0.966		60.0	0.037	0.848		59.0	3.678	0.060	0.823	0.368
UV-B × Water	1	58.5	0.001	0.974		61.7	4.828	0.032	*	59.0	0.610	0.438	0.832	0.365
Origin × UV-B × Water	1	17.2	0.929	0.349		60.0	0.002	0.961		59.0	0.004	0.984	1.349	0.250
Leaf dry matter content														
Origin	1	56.1	5.683	0.021	*	62.0	14.119	<0.001	***	21.3	0.044	0.836	0.623	0.441
UV-B	1	1.0	4.180	0.294		62.0	0.977	0.327		1.2	0.000	0.994	0.004	0.957
Water	1	57.4	56.591	<0.001	***	62.0	19.869	<0.001	***	31.4	16.113	<0.001	8.474	0.006
Initial leaf number (Covariate)	1	55.9	44.973	<0.001	***	62.0	5.653	0.021	*	54.2	4.123	0.047	4.903	0.031
Origin × UV-B	1	56.1	0.577	0.451		62.0	0.030	0.863		41.8	0.173	0.680	0.050	0.824
Origin × Water	1	10.3	0.102	0.756		62.0	0.405	0.527		31.8	0.321	0.576	2.840	0.099
UV-B × Water	1	57.4	0.907	0.345		62.0	2.773	0.101		30.2	0.452	0.506	0.656	0.422
Origin × UV-B × Water	1	10.1	1.161	0.306		62.0	0.173	0.679		30.0	0.818	0.373	0.037	0.849
Specific leaf area														
Origin	1	59.0	0.402	0.528		20.4	0.080	0.780		20.8	3.013	0.097	1.193	0.289
UV-B	1	59.0	0.110	0.741		46.6	1.327	0.255		1.8	0.560	0.540	0.005	0.944
Water	1	59.0	2.638	0.110		46.6	4.553	0.038	*	42.5	6.955	0.012	3.259	0.078
Initial leaf number (Covariate)	1	59.0	19.424	<0.001	***	42.1	0.762	0.388		52.9	5.081	0.028	0.157	0.694
Origin × UV-B	1	59.0	0.062	0.805		47.5	0.003	0.957		41.0	1.401	0.243	0.993	0.324
Origin × Water	1	59.0	0.165	0.686		47.6	0.552	0.461		42.6	0.405	0.528	10.525	0.002
UV-B × Water	1	59.0	0.569	0.454		47.6	0.099	0.755		42.8	1.647	0.206	2.822	0.100
Origin × UV-B × Water	1	59.0	1.626	0.207		47.0	0.059	0.810		42.9	0.520	0.475	1.662	0.204

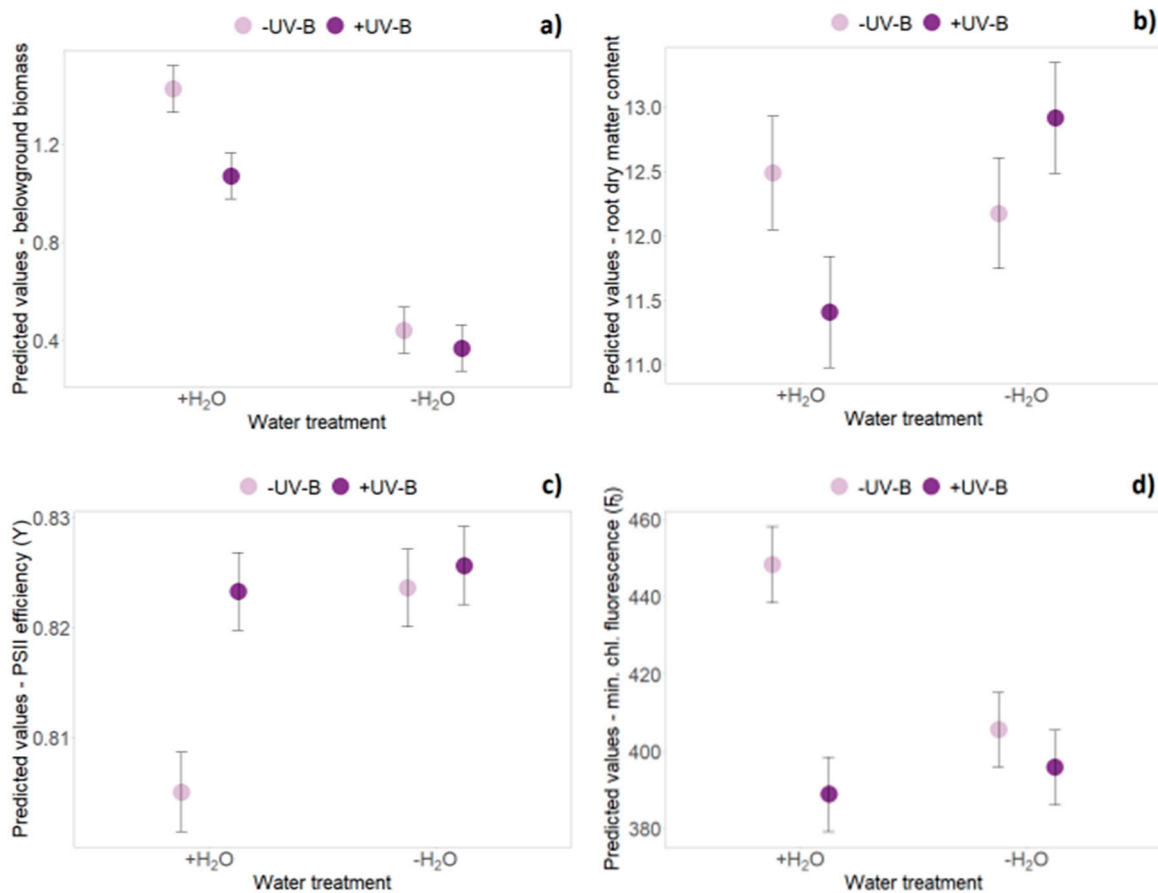

Figure 2. Interaction effects of UV-B and water treatment when averaging over origin. Predicted values \pm SE of (a) belowground biomass, (b) root dry matter content, (c) PSII efficiency (Y) and (d) minimum chlorophyll fluorescence (F₀) are shown across all treatment combinations (+H₂O|-UV-B, +H₂O|+UV-B, -H₂O|-UV-B, -H₂O|+UV-B).

2.2. Growth Data (Monitoring Data)

The repeated measures analysis across all monitoring dates during the experiment revealed an overall significantly higher leaf number, longer and wider leaves and bigger rosettes in German individuals compared to New Zealand plants (Table 2 and Table S2). Significant origin \times time interactions revealed relatively faster leaf growth and rosette expansion of New Zealand individuals during the course of the experiment, whereas German plants were bigger in the beginning of the experiment (Table 2 and Table S2). The repeated measures analysis did not reveal significant main effects of “UV-B treatment” on any of the tested variables, but did reveal significant interaction effects with “time” for leaf number and leaf width. Leaf number and leaf width showed a stronger increase in the presence of UV-B radiation during the experiment (Table 2 and Table S2, Figure 3a,b). Single UV-B effects (e.g., reduced maximum leaf length (H₁), rosette area (H₁) and leaf number (H₂)) or interaction effects with the origin (percentage of dead leaves (H₁) and leaf number (H₃)) were not consistent over time (see Tables S1 and S3).

Table 2. Fixed-effect results of the repeated measures analysis. “UV-B” and “Water” depict the effect of treatments and “Origin” refers to the effect of German vs. New Zealand provenance. Degrees of freedom (df_N = numerator, df_D = denominator), F statistics (F) and significance values (p) are provided. Significant p-values ($* p < 0.05$; $** p < 0.01$; $*** p < 0.001$) and marginal effects ($. p < 0.1$) are indicated.

Source	df_N	Leaf Number			Leaf Length			Leaf Width			Proportion of Dead Leaves						
		df_D	F	p	df_D	F	p	df_D	F	p	df_D	F	p				
Origin	1	15.61	10.01	0.0062	**	34.3	<0.001	***	18.601	20.91	<0.001	***	15.9	3.120	0.096		
UV-B	1	2.911	0.05	0.8427		4.9	0.196		3.059	2.33	0.2228		2.7	0.990	0.401		
Water	1	236.17	26.89	<0.001	***	231.8	<0.001	***	248.68	41.32	<0.001	***	252.9	11.510	<0.001	***	
Time	1	200.54	1524.66	<0.001	***	115.5	<0.001	***	147.23	686.36	<0.001	***	169.2	2727.47	<0.001	***	
Origin × UV-B	1	236.96	0.19	0.6646		232.4	0.160	0.693	249.35	1.77	0.185		253.6	0.360	0.547		
Origin × Water	1	236.14	0.27	0.6069		231.8	0.410	0.520	248.55	0.06	0.812		252.9	1.230	0.2684		
UV-B × Water	1	236.7	0.06	0.8051		232.2	0.750	0.389	249.18	0.82	0.3659		253.3	0.770	0.3811		
Origin × Time	1	200.54	0.2	0.657		115.5	38.860	<0.001	***	147.24	13.99	<0.001	***	169.2	0.040	0.8368	
UV-B × Time	1	200.55	6.4	0.0122	*	115.5	0.070	0.7947	147.18	15.7	<0.001	***	169.2	0.320	0.570		
Water × Time	1	200.55	33.43	<0.001	***	115.6	36.070	<0.001	***	147.3	42.43	<0.001	***	169.2	20.530	<0.001	***
Origin × UV-B × Water	1	236.66	2.77	0.0975		232.2	0.530	0.467	249.05	0.09	0.7702		253.4	0.310	0.577		
Origin × UV-B × Time	1	200.55	0.04	0.8459		115.5	0.510	0.478	147.2	2.16	0.1435		169.2	2.930	0.089		
Origin × Water × Time	1	200.54	1.3	0.2554		116.1	1.700	0.195	147.96	2.03	0.1564		169.2	0.150	0.703		
UV-B × Water × Time	1	200.55	0.05	0.8263		115.6	0.050	0.823	147.29	2.97	0.0871		169.2	0.070	0.785		
Origin × UV-B × Water × Time	1	200.54	0.01	0.9082		116.1	0.870	0.353	147.95	0.17	0.6786		169.2	0.050	0.817		

Source	df_N	Rosette Area			PSII Efficiency (Y)			Min. Chlorophyll Fluorescence			Max. Chlorophyll Fluorescence						
		df_D	F	p	df_D	F	p	df_D	F	p	df_D	F	p				
Origin	1	20.841	26.55	<0.001	***	21.6	10.259	0.004	**	20.5	10.079	0.005	**	27.5	1.770	0.195	
UV-B	1	3.879	1.51	0.2889		217.0	2.368	0.125		3.0	0.115	0.756		2.3	1.240	0.367	
Water	1	255	43.67	<0.001	***	215.9	0.461	0.498		226.5	5.354	0.022	*	234.6	5.690	0.018	
Time	1	202.01	1351.2	<0.001	***	138.7	0.670	0.414		148.1	257.314	<0.001	***	170.9	420.720	<0.001	***
Origin × UV-B	1	255.72	0.08	0.7768		217.2	1.239	0.267		228.1	0.52	0.472		235.9	6.490	0.011	
Origin × Water	1	254.9	0.35	0.5528		215.9	0.472	0.493		226.3	2.293	0.131		234.2	2.330	0.128	
UV-B × Water	1	255.53	2.79	0.0961		216.5	0.015	0.903		227.2	2.295	0.131		235.2	3.040	0.082	
Origin × Time	1	202.02	21.99	<0.001	***	138.7	2.588	0.110		148.1	2.839	0.361		170.9	8.300	0.004	
UV-B × Time	1	202.01	0.18	0.6752		138.6	5.691	0.018	*	148.0	15.478	<0.001	***	170.8	9.030	0.003	
Water × Time	1	202.06	176.111	<0.001	***	138.6	16.625	<0.001	***	148.0	0.222	0.638		170.8	14.080	<0.001	
Origin × UV-B × Water	1	255.44	0.44	0.5059		216.5	2.947	0.087		227.0	0.823	0.365		234.8	0.820	0.367	
Origin × UV-B × Time	1	202.01	0.69	0.4085		138.6	0.067	0.797		148.0	0.004	0.949		170.8	0.400	0.530	
Origin × Water × Time	1	202.3	3.82	0.0519		138.6	1.301	0.256		148.0	3.853	0.052		170.7	1.450	0.230	
UV-B × Water × Time	1	202.06	0.12	0.733		138.6	1.778	0.185		148.0	6.593	0.011	*	170.8	2.120	0.147	
Origin × UV-B × Water × Time	1	202.3	1.01	0.3152		138.6	0.434	0.511		148.0	1.119	0.292		170.7	0.170	0.679	

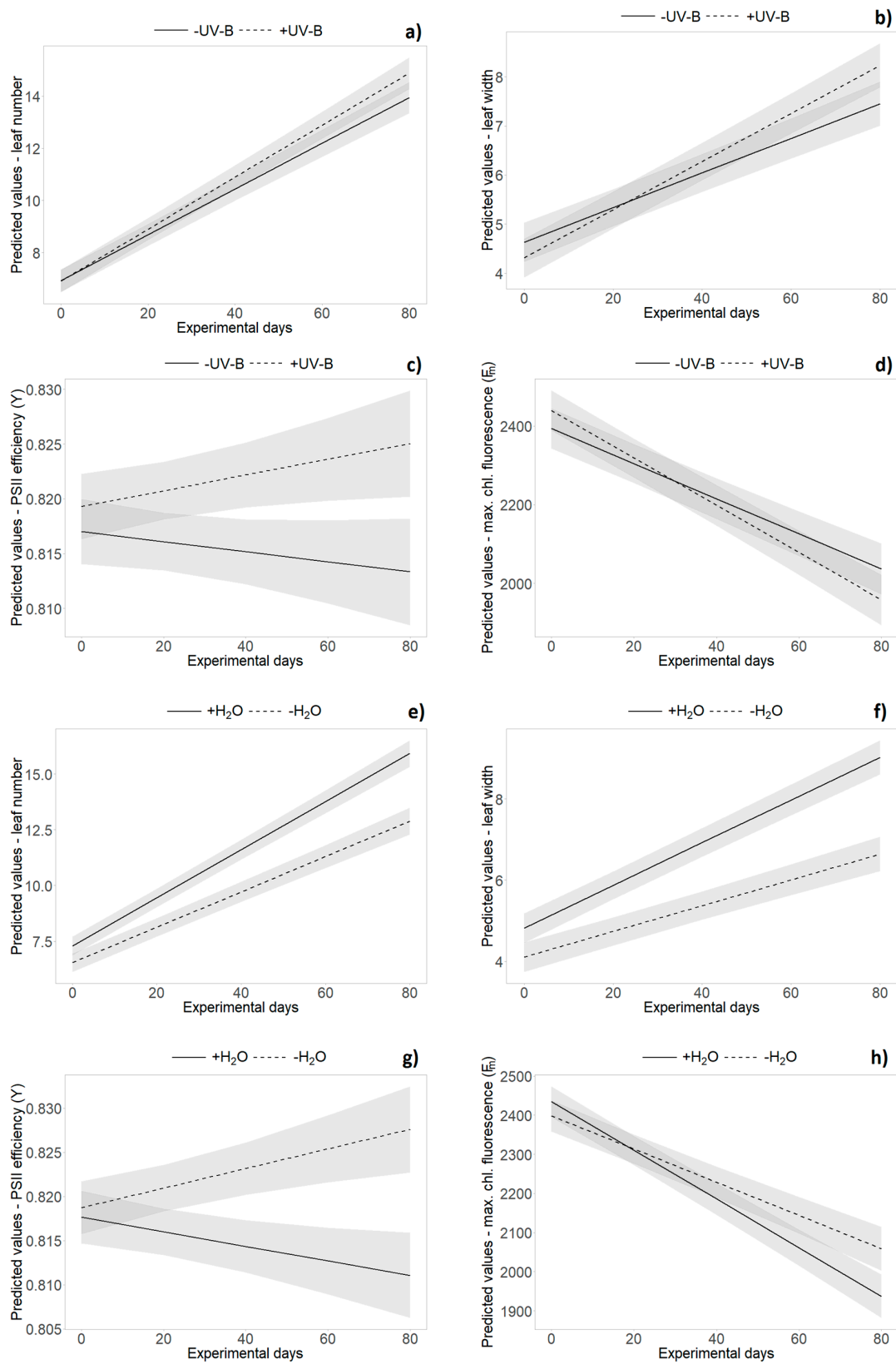

Figure 3. Effects of UV-B (a–d) and water treatment (e–h) over time. Predicted values \pm SE of (a,e) leaf number, (b,f) leaf width, (c,g) PSII efficiency (Y) and (d,h) maximum chlorophyll fluorescence (F_m) are shown in (a–d) absence of UV-B (solid line) and in presence of UV-B (dashed line), as well as under (e–h) well-watered conditions (solid line) and under drought (dashed line).

Overall, leaf number and the proportions of dead leaves, leaf length and leaf width, as well as rosette size, were significantly decreased by the water limitation treatment ($p < 0.001$, Table 2 and Table S2, Figure 3e,f). Water level \times origin interaction effects were only found at separate monitoring dates for various variables (e.g., leaf length (H_2 , H_4), leaf width (H_3) and leaf number (H_4), see Table S3). The repeated measures analysis did not reveal significant interaction effects of “UV-B treatment” and “water treatment”, nor was there a three-way interaction with “origin” or “time” (Table 2).

2.3. Functional Leaf Traits and Physiology

Significant origin effects were found at separate harvest dates and as consistent effects evidenced over time: leaves of German individuals showed an about 10% higher leaf dry matter content (LDMC) than leaves of New Zealand individuals at the first two harvests (Table 1 and Table S1). Overall, PSII efficiency (Y) was significantly higher in German individuals ($p = 0.004$, Table 2 and Table S2), while minimum chlorophyll fluorescence (F_0) was higher in New Zealand individuals ($p = 0.005$, Table 2 and Table S2). Maximum chlorophyll fluorescence (F_m) decreased during the experiment with a stronger decline in German plants ($p = 0.004$, Table 2 and Table S2).

UV-B effects were found in PSII efficiency (Y) that decreased in the absence of UV-B but increased for plants under UV-B exposure ($p = 0.018$, Table 2 and Table S2, Figure 3c). The decrease of minimum and maximum chlorophyll fluorescence over time was more pronounced in presence of UV-B radiation (Table 2 and Table S2, Figure 3d). In presence of UV-B, overall higher maximum chlorophyll fluorescence (F_m) of New Zealand individuals (slightly) decreased, whereas an increase was found for German plants ($p = 0.011$, Table 2 and Table S2, Figure 4). Further UV-B \times origin interaction effects were found for single harvest dates (see Tables S1 and S3).

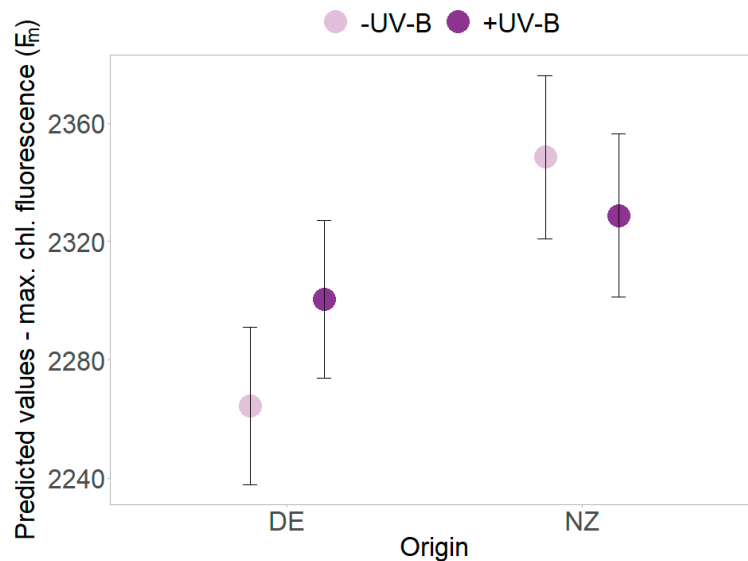

Figure 4. Interaction effects of UV-B and origin. Predicted values \pm SE of maximum chlorophyll fluorescence (F_m) are shown in the absence of UV-B (pale violet) and in the presence of UV-B (dark violet) for native German (DE) and exotic New Zealand individuals.

Water limitation significantly increased leaf dry matter content and PSII efficiency among all harvests. Overall, maximum chlorophyll fluorescence (F_m) was increased under dry conditions, whereas higher values of minimum chlorophyll fluorescence (F_0) were found for well-watered plants ($p < 0.05$, Table 2 and Table S2). PSII efficiency (Y) decreased with sufficient water availability but increased for plants under water limitation ($p < 0.001$, Table 2 and Table S2, Figure 3g). The decrease of maximum chlorophyll fluorescence (F_m) over time was more pronounced in well-watered individuals ($p < 0.001$, Table 2 and Table S2, Figure 3h). For most of the variables, there was no significant interaction effect of

origin and water, while insufficient water supply induced an increase of specific leaf area (H_4) in New Zealand individuals only (see Table S3).

The threefold interaction effect of “UV-B treatment”, “water treatment” and “time” revealed a significant difference in minimum chlorophyll fluorescence (F_0): the strongest decrease of F_0 was found in the presence of UV-B radiation and the decrease was lessened by limited water availability, applied separately or in combination with UV-B radiation ($p = 0.011$, Table 2, Figure 5). At the second harvest, PSII efficiency (Y) was significantly increased and minimum chlorophyll fluorescence (F_0) significantly decreased by UV-B radiation and low water availability individually, but this effect was not additionally enhanced by the joint presence of both factors ($p < 0.01$, Figure 2c,d).

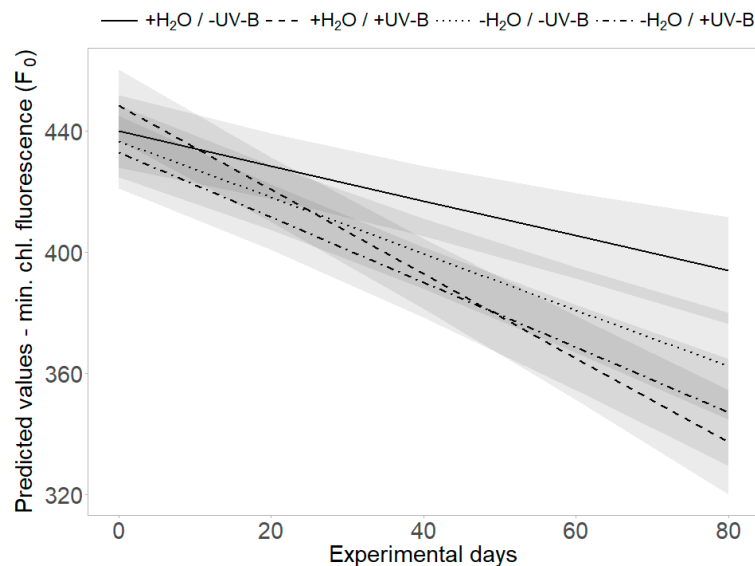

Figure 5. Interaction effects of UV-B and water treatment. Predicted values of minimum chlorophyll fluorescence (F_0) are shown across all treatment combinations (+H₂O|-UV-B, +H₂O|+UV-B, -H₂O|-UV-B, -H₂O|+UV-B). Shaded areas depict the respective SE confidence intervals.

3. Discussion

3.1. Single and Combined Effects of UV-B and Drought

The applied UV-B radiation treatment to both origins of *V. thapsus* aimed at simulating midsummer UV-B levels of the invaded range in New Zealand. In consequence, the applied UV-B intensity was familiar to the level exotic populations experience but novel to native individuals only. The observed limiting effects of UV-B radiation on leaf number, leaf length and rosette area confirm previous studies, which also reported UV-B-induced growth and biomass reduction [17,19,29,44]. A UV-B-induced increase in PSII efficiency was determined in the present study and caused by a decrease of minimum and maximum chlorophyll fluorescence (see also [45]). PSII efficiency response to UV-B has been previously identified for several species and was mostly found to decrease as a result of increasing minimum and maximum chlorophyll fluorescence [30,33,46] (but see also [47]). Especially an increase of minimum chlorophyll indicates photoinhibition and direct damage or an inactivation of PSII reaction centers as a result of a disconnection of light-harvesting antennae from their reaction centers [48–50]. A concomitant decrease of maximum and minimum chlorophyll fluorescence, as observed in the present study, was previously linked to thermal dissipation in PSII reaction centers, which displays a key photoprotective process [48]. In consequence, reactive oxygen species (ROS) production in response to a moderate dose of UV-B radiation in our experiment might be avoided and might even explain a temporary increase of PSII efficiency in the context of efficient repair mechanisms.

The applied water treatment presumably induced drought stress in the individuals of the “low” water treatment level, as those regularly responded with wilting of leaves at the latest on the day

of watering. We therefore assume that a physiological stress response was provoked in the plants by water limitation. An overall reduced biomass, leaf number, leaf area and higher leaf dry matter content confirm this assumption and have been previously observed in response to water limitation (e.g., [35,44,51]). In line with the effects of UV-B, the maximum photosynthetic quantum yield of all plants was higher under drought conditions. This effect was initially caused by a decrease of minimum chlorophyll fluorescence, and in the later experimental phase due to an increase of maximum chlorophyll fluorescence. Previous studies on drought effects predominantly revealed decreasing PSII efficiency due to water limitation [52,53]. The opposite effect in the present study might be the consequence of the existing drought tolerance and resulting protection measures of *Verbascum thapsus*, that are known to naturally occur on very dry and disturbed sites [54].

We found no evidence for detrimental synergy effects or generally additive effects of drought and UV-B radiation as they had been reported before [36,37]. Other studies found enhanced drought tolerance in the presence of UV-B radiation, since certain stress avoidance mechanisms turned out to be of advantage under both abiotic stresses, e.g., leaf area reduction, increase of leaf cuticle thickness or stomatal closure [38,40,55]. Relevant antagonistic effects can be also provoked at the physiological level by common metabolic responses to drought and UV-B, e.g., an increase of anthocyanins, phenolics, prolin and other antioxidants to decrease ROS production and consequently maintain photosynthetic capacity and carbon assimilation rate [39,41–43].

In the present study, the only significant interaction effects of UV-B and drought were found after six weeks of the experiment (H_2) and might have been the temporary consequence of the UV-B radiation dose increase after the initial two-week UV-B acclimation phase. Belowground biomass moderately decreased in response to UV-B radiation [16,56] but was highly sensitive to drought with a strong overall decrease [44] that was not additionally aggravated by supplementary UV-B exposure. By contrast, root dry matter content did not change significantly with drought in the absence of UV-B, but increased under combined stress application and decreased under UV-B exposure in well-watered conditions, thus displaying strong interaction effects. Dry matter distribution towards the roots has been previously shown for plant species under abiotic stress conditions [57,58], and might be only induced in response to the combined application of drought and UV-B in our study. Furthermore, the PSII efficiency was increased by UV-B and drought to a similar extent, whether applied separately or jointly. This points to a similar and non-additive effect size of both abiotic stresses at the physiological level. Interestingly, the minimum chlorophyll fluorescence (F_0) appeared to be more sensitive in response to UV-B radiation at the second harvest (H_2) and in the repeated measures analysis. The only explanation for a decrease of F_0 might be a higher number of unimpaired PSII reaction centers that could be provided by activation of efficient photoprotection and repair mechanisms. Those might be induced to a higher level by UV-B compared to drought, as radiation displays the more immediate trigger for PSII damage. Therefore, we could conclude that the plant physiology of *V. thapsus* is affected by both UV-B and drought to a similar extent, but the respective effect is induced by different underlying mechanisms.

3.2. Origin Differentiation and Origin-Specific Response to UV-B and Drought

Differences in plant performance or functional plant traits between native and exotic origins might hint at genetic differentiation as a result of founder effects or evolutionary processes during the invasion of novel habitats in New Zealand [59]. As the set of investigated German and New Zealand populations does not represent the entire native and invaded range, respectively, other sources of variation among populations may have also contributed to significant differences between origins: among them are population-specific differences in elevation, microclimate or other environmental factors that are able to induce geographical clines within ranges [54,60]. Thus, complementary experiments with further seed material from other parts of the native and invaded range along larger latitudinal gradients would be necessary to draw more general conclusions.

In the present study, native individuals from Germany started with higher biomass and larger leaves, but exotic individuals showed stronger increase in time regarding leaf area and respective size of rosettes. Therefore, the initial advantage of native plants disappeared during the experimental runtime. Higher productivity/relative growth rates of exotic populations in comparison to native origins has been repeatedly reported in the past, especially in the context of altered resource allocation as a result of the release from native biotic and abiotic stresses [2,54,61]. Nevertheless, in our study, the New Zealand populations of *V. thapsus* appeared to be less successful in the early establishment (personal observation). The difference in seed age of the German and New Zealand populations and the conditions during seed transfer from New Zealand to Germany might be a reason for differences in germination and establishment success. Further explanations for the initial disadvantage of exotic populations may comprise a potentially reduced genetic diversity of exotic populations due to founder effects or the importance of range identity with regard to covarying effects of different biotic and abiotic conditions, as discussed by Dieskau et al. [62]. This might be particularly important, since other native–invasive comparisons revealed early invasive superiority when testing *V. thapsus* performance in other parts of the species' exotic range [54,63,64]. PSII efficiency was found to be generally higher in native plants with a stronger decrease of maximum chlorophyll fluorescence (F_m) in German individuals during the experiment and higher values of minimum chlorophyll fluorescence (F_0) in New Zealand plants since the second harvest (H_2) independent of water availability and UV-B treatment. Higher physiological performance of native individuals could also be a consequence of their early establishment success prior to the application of environmental stress by drought and UV-B radiation, which might have led to stronger and more resilient plants.

In the presence of UV-B, New Zealand plants showed the described reduction of maximum chlorophyll fluorescence, whereas an observed increase of maximum chlorophyll fluorescence in German individuals might be linked to an impaired electron transfer or secondary electron acceptor of PSII [49]. In contrast to German plants, New Zealand individuals also showed a pronounced decrease of minimum chlorophyll fluorescence and an increase of leaf number and dead leaf proportion in the early stage of the experiment. Therefore, the higher photoprotection abilities and growth of exotic individuals under UV-B radiation might indicate an evolved reduced sensitivity to UV-B in consequence to the experienced higher radiation levels in New Zealand.

Drought stress is known to limit invasibility of habitats, as drier sites appear to be less invaded and non-natives turned out to be more abundant in wetter years [65]. Nevertheless, previous studies did not agree on the question if drought tolerance of native and non-native species differs and thus is subject to evolutionary changes in plant invasions [66–68]. In the present study, non-native plants from New Zealand responded with measurable changes in leaf morphology to low water availability, whereas native German plants experienced a stronger decrease in growth estimates in the late experimental phase. We could therefore assume that non-native genotypes are able to respond with functional changes at the leaf level in order to sustain overall growth under drought conditions. This ability might be the result of evolutionary processes in response to environmental conditions in the invaded range or overall higher phenotypic plasticity [69]. Interestingly, previous studies on drought tolerance of native and non-native populations of grassland species assumed a trade-off between rapid growth and drought tolerance, since they revealed more resilient native populations under drought conditions, although non-native populations appeared to be more vigorous and fast-growing in other environments [61,70].

Furthermore, we found no evidence for the importance of population origin to the combined stress effects on plants. Previous studies on different woody plant species revealed different resistance of low and high altitude populations to a treatment combining UV-B radiation and drought [36,37]: whereas low altitude populations experienced additive detrimental effects of both abiotic stressors on productivity and growth traits, high altitude populations responded with higher tolerance to the combined application of drought and UV-B, and thus appeared to be better adapted. By contrast, testing for adaptation to elevational constraints in multiple exotic plant species gradient, Watermann

et al. [31] did not find any evidence for combined UV-B × drought interactions with low and high altitude populations. However, neither native nor non-native populations of *Verbascum thapsus* had an advantage in the presence of combined abiotic stress by drought and UV-B radiation in the present experiment. As both origins are expected to be similarly adapted to drought but experience different levels of UV-B in their home ranges, we assume that origin differences in stress response may be more precisely carved out by moderate water limitation and moderate or elevated UV-B intensity. While severe levels of stress usually lead to direct negative effects on plant metabolism and growth, moderate abiotic stress triggers physiological and biochemical defense mechanisms, which are of advantage under harmful conditions [44].

4. Materials and Methods

4.1. Study Species

Verbascum thapsus L. (Scrophulariaceae) is a typical component of temperate dry grasslands and ruderal habitats in the investigated ranges in Germany and New Zealand, and is characterized by high drought tolerance and a strong prevalence in open, unshaded habitats [71]. The species is monocarpic, generally biennial and develops a long tap root to access remote nutrient and water resources in deeper soil layers [72]. The plant's surface is typically piliferous, i.e., leaves and stems are densely covered with woolly, branched stellate trichomes, which provide a reliable protection against herbivory, frost and drought [73] and may be also advantageous under high radiation levels. The native distribution of *V. thapsus* ranges from Europe to Central Asia. To date, it is furthermore naturalized in North America, Hawaii, Australia and New Zealand. In the present study, we used ten native and eight invasive populations of *V. thapsus* from Germany and New Zealand, respectively (for population details see Table S4).

4.2. Experimental Design

The experiment was conducted in the summer of 2013 in the greenhouse cabinets of the Martin Luther University Halle–Wittenberg. Seeds were germinated in the greenhouse under standard conditions within seedling trays on a soil-sand mixture (2:1) and transferred into pots (9 × 9 × 10 cm) with the same substrate about six weeks later. At the age of ten weeks, plants were assigned to the experimental setting: four treatments resulting from fully crossed combinations of two water levels (“low” vs. “well-watered”) and two UV-B levels (“–UV-B” vs. “+UV-B”) were applied to four individuals of all 18 populations (totaling 288 individuals). Therefore, plants were arranged within four identical boxes (120 × 120 × 70 cm), which served as self-contained UV-B environments (Figure 1). All boxes were equipped with white chipboard to the left and the right side and with white fleece at the front and the back, allowing the implementation of a UV-B radiation source from the top to the plants and to ensure ventilation within the boxes to minimize uncontrolled microclimatic effects. Each of the four boxes was equipped with a greenhouse PAR lamp (HQI 400 W, Philips) on the top. Additionally, in two boxes, three UV-B tubes (TL 20W/12 RS SLV, Philips) were implemented. The two boxes without UV-B tubes served as a “no UV-B” control. Photosynthetically active radiation (PAR) was applied 16 h a day, whereas UV-B lamps were switched on for eight hours within this period. Initially, UV-B lamps had a distance of 80 cm to the plant individuals, resulting in a UV-B intensity of 0.014–0.052 mW cm^{−2} dependent on pot position. After two weeks we reduced the distance between the lamps and the plants in order to increase UV-B radiation to 0.096–0.159 mW cm^{−2}, thereby approaching the midsummer UV-B level on the South Island, New Zealand [17].

Half of the plants in each box received sufficient water supply, whereas the other half was exposed to drought (Figure 1). Both treatment groups were watered every second day with water amounts in a ratio of 3:1 (week 1–4: 60 mL/20 mL, week 5–12: 90 mL/30 mL, for well-watered and drought treatments, respectively). Measurements of soil moisture using a time-domain reflectometer (TDR) revealed water contents of 15%–20% in well-watered pots and 3%–8% in pots mimicking situations of

drought. Based on a visual assessment, the latter group generally reached the wilting point within 48 h but was kept from being permanently damaged.

Individuals of each population were equally represented at each UV-B level and water level. Initially, all individuals were randomly assigned to and positioned within the boxes, but within-box randomization was subsequently repeated every 7–10 days during the experiment. Due to the occurrence of some mortality in the early phase of the study, we received data of 276 individuals of 18 populations (10 DE, 8 NZ) within an experimental period of 12 weeks.

4.3. Data Collection

Biometrical variables were determined for each individual on a weekly basis in the beginning, and later every ten days (Figure 1): rosette diameter, length and width of the longest leaf and the number of intact and dead leaves were recorded ten times during the experiment. Rosette area (A) was calculated for each individual as an ellipse using measured rosette diameters (d_1 , d_2):

$$A = \pi \times (d_1/2) \times (d_2/2), \quad (1)$$

In order to assess repeated productivity data and growth rates, one individual per population and treatment was harvested every three weeks, resulting in four harvests during the experimental period ($n = 68$ –71, Figure 1). We determined aboveground, belowground and dead biomass, leaf dry matter content (LDMC), root dry matter content (RDMC), specific leaf area (SLA) and the shoot:root ratio for each individual harvested in the different subsets. The selective sampling for harvest reduced the total amount of individuals available for monitoring of biometrical variables over time.

At the physiological level, we recorded maximum quantum yield of photochemical energy conversion (Y) as a measure of photosystem II efficiency, such as minimum and maximum fluorescence yield (F_0 , F_m) in response to the initial UV-B application and the enhancement of UV-B intensity after a two-week acclimatization, totaling eight times during the experiment (Figure 1). Therefore, one fully developed and healthy leaf per individual was dark-adapted for about ten minutes and subsequently measured once with a hand-held fluorometer (Mini-PAM, Heinz Walz GmbH) without removal from the experimental boxes or interruption of the UV-B treatment.

4.4. Statistical Analysis

A repeated measures analysis of the monitoring data was done to test for the effects of origin, UV-B treatment and water treatment on plant performance over time in R (Version 3.5.3, R CORE TEAM 2019). We therefore applied a linear mixed effect model (function “lmer”, package “lmerTest”, [74]) containing “origin” (DE vs. NZ), “UV-B” (-UV-B vs. +UV-B) and “water” (low vs. well-watered) as fixed factors and “time” (eight dates of monitoring and physiological measurements), as well as all of their interactions. The following nested random effect terms were additionally included in the repeated measures analysis: “box:UV-B” and “population:origin”, while fitting a random slope model with “time|plant ID:UV-B:water:origin”. Due to the partial harvests during the experiment, the repeated measures analysis of the monitoring data naturally experienced a decrease in sample size over time. Thereby, the number of replicates within populations was reduced from four to one during the experimental duration. As the statistical analyses aim to test for differences between origins (DE vs. NZ), all remaining individuals of the ten German populations served as replicates for the origin level “DE” and all remaining individuals of the eight New Zealand populations were considered replicates for the origin level “NZ”.

Furthermore, data of the four partial biomass harvests was separately analyzed per date by linear mixed effect models containing “origin” (DE vs. NZ), “UV-B” (-UV-B vs. +UV-B) and “water” (low vs. well-watered), as well as their interactions as fixed factors. We additionally included the individual leaf number at the time of the experimental start as a covariate and again determined “box:UV-B” and “population:origin” as nested random effect terms in the separate mixed effects models.

5. Conclusions

Generally, interaction effects of UV-B and drought depend on species-specific sensitivity, stress factor intensity, exposure duration and operation mode [44]. In our study, the strong effect of water treatment might potentially mask UV-B effects on plants, as the induced water limitation level is likely to display a more restrictive condition for plant metabolism than the applied UV-B radiation level. This observation points at the importance of setting comparable stress levels in abiotic interaction experiments, as otherwise one of the abiotic environmental factors dominates the results and potential antagonistic effects are difficult to detect. Moreover, application of artificial UV-B under greenhouse conditions partly excludes photosynthetically active radiation (PAR) that is known to have a mitigating effect on plants under UV-B and might have additionally induced mechanisms of drought resistance [44,75]. Nevertheless, our results point at similar physiological responses to drought and UV-B radiation and an absence of detrimental synergy effects of both environmental factors. Therefore, we assume that drought-tolerant plant species might also be more resilient to higher levels of UV-B radiation. To adequately test and identify cross-resistance mechanisms in plant invasions and the potential impact of local adaptation on this characteristic, we recommend attaching great importance to the application of suitable and relevant environmental stress gradients derived from respective native and/or invaded ranges in future experimental studies.

Supplementary Materials: The following are available online at <http://www.mdpi.com/2223-7747/9/2/269/s1>, Table S1: Effect directions of harvest data analysis; Table S2: Effect directions of repeated measures analysis; Table S3: Fixed-effect results of the harvest data analysis; Table S4: Location and sampling information of native (German) and exotic (New Zealand) populations included in the experiment.

Author Contributions: Conceptualization, M.H. and A.E.; Data curation, C.P. and M.S.; Formal analysis, M.H.; Investigation, C.P. and M.S.; Methodology, M.H. and A.E.; Project administration, M.H.; Supervision, A.E.; Writing—original draft, M.H.; Writing—review and editing, C.P., M.S. and A.E. All authors have read and agreed to the published version of the manuscript.

Funding: We acknowledge financial support by Land Schleswig-Holstein within the funding programme Open Access Publikationsfonds.

Acknowledgments: We thank Susanne Both and Julia Dieskau for seed sampling of New Zealand and German *Verbascum thapsus* populations. Additional seeds from the Botanical Garden of Martin Luther University Halle-Wittenberg were provided by E. Grimm. We thank three reviewers for their valuable comments.

Conflicts of Interest: The authors declare no conflict of interest.

References

- Pereira, M.G.; Calado, T.J.; DaCamara, C.C.; Calheiros, T. Effects of regional climate change on rural fires in Portugal. *Clim. Res.* **2013**, *57*, 187–200. [CrossRef]
- Keane, R.M.; Crawley, M.J. Exotic plant invasions and the enemy release hypothesis. *Trends Ecol. Evol.* **2002**, *17*, 164–170. [CrossRef]
- Theoharides, K.A.; Dukes, J.S. Plant invasion across space and time: Factors affecting nonindigenous species success during four stages of invasion. *New Phytol.* **2007**, *176*, 256–273. [CrossRef] [PubMed]
- Erfmeier, A. Constraints and release at different scales—The role of adaptation in biological invasions. *Basic Appl. Ecol.* **2013**, *14*, 281–288. [CrossRef]
- Blackburn, T.M.; Pyšek, P.; Bacher, S.; Carlton, J.T.; Duncan, R.P.; Jarošík, V.; Wilson, J.R.U.; Richardson, D.M. A proposed unified framework for biological invasions. *Trends Ecol. Evol.* **2011**, *26*, 333–339. [CrossRef]
- Richardson, D.M.; Pyšek, P.; Rejmánek, M.; Barbour, M.G.; Panetta, F.D.; West, C.J. Naturalization and invasion of alien plants: Concepts and definitions. *Divers. Distrib.* **2000**, *6*, 93–107. [CrossRef]
- Sharma, G.P.; Esler, K.J. Phenotypic plasticity among *Echium plantagineum* populations in different habitats of Western Cape, South Africa. *S. Afr. J. Bot.* **2008**, *74*, 746–749. [CrossRef]
- Davidson, A.M.; Jennions, M.; Nicotra, A.B. Do invasive species show higher phenotypic plasticity than native species and, if so, is it adaptive? A meta-analysis. *Ecol. Lett.* **2011**, *14*, 419–431. [CrossRef]
- Schlaepfer, D.R.; Glättli, M.; Fischer, M.; van Kleunen, M. A multi-species experiment in their native range indicates pre-adaptation of invasive alien plant species. *New Phytol.* **2010**, *185*, 1087–1099. [CrossRef]

10. Colautti, R.I.; Eckert, C.G.; Barrett, S.C.H. Evolutionary constraints on adaptive evolution during range expansion in an invasive plant. *Proc. R. Soc. B Biol. Sci.* **2010**, *277*, 1799–1806. [[CrossRef](#)]
11. Buswell, J.M.; Moles, A.T.; Hartley, S. Is rapid evolution common in introduced plant species? *J. Ecol.* **2011**, *99*, 214–224. [[CrossRef](#)]
12. Broennimann, O.; Treier, U.A.; Müller-Schärer, H.; Thuiller, W.; Peterson, A.T.; Guisan, A. Evidence of climatic niche shift during biological invasion. *Ecol. Lett.* **2007**, *10*, 701–709. [[CrossRef](#)] [[PubMed](#)]
13. Petitpierre, B.; Kueffer, C.; Broennimann, O.; Randin, C.; Daehler, C.; Guisan, A. Climatic niche shifts are rare among terrestrial plant invaders. *Science* **2012**, *335*, 1344–1348. [[CrossRef](#)] [[PubMed](#)]
14. Phoenix, G.K.; Gwynn-Jones, D.; Callaghan, T.V.; Sleep, D.; Lee, J.A. Effects of global change on a sub-Arctic heath: Effects of enhanced UV-B radiation and increased summer precipitation. *J. Ecol.* **2001**, *89*, 256–267. [[CrossRef](#)]
15. Qaderi, M.M.; Yeung, E.C.; Reid, D.M. Growth and physiological responses of an invasive alien species, *Silene noctiflora*, during two developmental stages to four levels of ultraviolet-B radiation. *Ecoscience* **2008**, *15*, 150–159. [[CrossRef](#)]
16. Beckmann, M.; Hock, M.; Bruelheide, H.; Erfmeier, A. The role of UV-B radiation in the invasion of *Hieracium pilosella*—A comparison of German and New Zealand plants. *Environ. Exp. Bot.* **2012**, *75*, 173–180. [[CrossRef](#)]
17. Hock, M.; Hofmann, R.W.; Müller, C.; Erfmeier, A. Exotic plant species are locally adapted but not to high ultraviolet-B radiation: A reciprocal multispecies experiment. *Ecology* **2019**, *100*, e02665. [[CrossRef](#)]
18. Norby, R.J.; Luo, Y. Evaluating ecosystem responses to rising atmospheric CO₂ and global warming in a multi-factor world. *New Phytol.* **2004**, *162*, 281–293. [[CrossRef](#)]
19. Caldwell, M.M.; Bornman, J.F.; Ballaré, C.L.; Flint, S.D.; Kulandaivelu, G. Terrestrial ecosystems, increased solar ultraviolet radiation, and interactions with other climate change factors. *Photochem. Photobiol. Sci.* **2007**, *6*, 252–266. [[CrossRef](#)]
20. Alba, C.; Fahey, C.; Flory, S.L. Global change stressors alter resources and shift plant interactions from facilitation to competition over time. *Ecology* **2019**, *100*, e02859. [[CrossRef](#)]
21. Côté, I.M.; Darling, E.S.; Brown, C.J. Interactions among ecosystem stressors and their importance in conservation. *Proc. R. Soc. B Biol. Sci.* **2016**, *283*, 20152592. [[CrossRef](#)] [[PubMed](#)]
22. Mittler, R. Abiotic stress, the field environment and stress combination. *Trends Plant Sci.* **2006**, *11*, 15–19. [[CrossRef](#)] [[PubMed](#)]
23. Galic, N.; Sullivan, L.L.; Grimm, V.; Forbes, V.E. When things don't add up: Quantifying impacts of multiple stressors from individual metabolism to ecosystem processing. *Ecol. Lett.* **2018**, *21*, 568–577. [[CrossRef](#)] [[PubMed](#)]
24. Pieterse, C.M.; Dicke, M. Plant interactions with microbes and insects: From molecular mechanisms to ecology. *Trends Plant Sci.* **2007**, *12*, 564–569. [[CrossRef](#)]
25. Mauro, R.P.; Monaco, A.L.; Lombardo, S.; Restuccia, A.; Mauromicale, G. Eradication of *Orobanche/Phelipanche* spp. seedbank by soil solarization and organic supplementation. *Sci. Hort.* **2015**, *193*, 62–68. [[CrossRef](#)]
26. McKenzie, R.L.; Aucamp, P.J.; Bais, A.F.; Björn, L.O.; Ilyas, M. Changes in biologically-active ultraviolet radiation reaching the Earth's surface. *Photochem. Photobiol. Sci.* **2007**, *6*, 218–231. [[CrossRef](#)]
27. Li, F.R.; Peng, S.L.; Chen, B.M.; Hou, Y.P. A meta-analysis of the responses of woody and herbaceous plants to elevated ultraviolet-B radiation. *Acta Oecol.* **2010**, *36*, 1–9. [[CrossRef](#)]
28. Watanabe, S.; Sudo, K.; Nagashima, T.; Takemura, T.; Kawase, H.; Nozawa, T. Future projections of surface UV-B in a changing climate. *J. Geophys. Res. Atmos.* **2011**, *116*. [[CrossRef](#)]
29. Jansen, M.A.K.; Gaba, V.; Greenberg, B.M. Higher plants and UV-B radiation: Balancing damage, repair and acclimation. *Trends Plant Sci.* **1998**, *3*, 131–135. [[CrossRef](#)]
30. Hofmann, R.W.; Campbell, B.D.; Fountain, D.W.; Jordan, B.R.; Greer, D.H.; Hunt, D.Y.; Hunt, C.L. Multivariate analysis of intraspecific responses to UV-B radiation in white clover (*Trifolium repens* L.). *Plant Cell Environ.* **2001**, *24*, 917–927. [[CrossRef](#)]
31. Watermann, L.Y.; Hock, M.; Blake, C.; Erfmeier, A. Plant invasions into high elevations implies adaptation to high UV-B environments—A multi-species experiment. *Biol. Invasions* **2019**. [[CrossRef](#)]
32. Holmes, M.G.; Keiller, D.R. Effects of pubescence and waxes on the reflectance of leaves in the ultraviolet and photosynthetic wavebands: A comparison of a range of species. *Plant Cell Environ.* **2002**, *25*, 85–93. [[CrossRef](#)]

33. Manetas, Y. The importance of being hairy: The adverse effects of hair removal on stem photosynthesis of *Verbascum speciosum* are due to solar UV-B radiation. *New Phytol.* **2003**, *158*, 503–508. [[CrossRef](#)]
34. Micco, V.D.; Aronne, G. Morpho-Anatomical Traits for Plant Adaptation to Drought. In *Plant Responses to Drought Stress*; Aroca, R., Ed.; Springer: Berlin/Heidelberg, Germany, 2012; pp. 37–61.
35. Jaleel, C.A.; Manivannan, P.; Wahid, A.; Farooq, M.; Al-Juburi, H.J.; Somasundaram, R.; Panneerselvam, R. Drought stress in plants: A review on morphological characteristics and pigments composition. *Int. J. Agric. Biol.* **2009**, *11*, 100–105.
36. Ren, J.; Dai, W.; Xuan, Z.; Yao, Y.; Korpelainen, H.; Li, C. The effect of drought and enhanced UV-B radiation on the growth and physiological traits of two contrasting poplar species. *For. Ecol. Manag.* **2007**, *239*, 112–119. [[CrossRef](#)]
37. Yang, Y.; Yao, Y.; Xu, G.; Li, C. Growth and physiological responses to drought and elevated ultraviolet-B in two contrasting populations of *Hippophae rhamnoides*. *Physiol. Plant.* **2005**, *124*, 431–440. [[CrossRef](#)]
38. Sullivan, J.H.; Teramura, A.H. Field Study of the Interaction between Solar Ultraviolet-B Radiation and Drought on Photosynthesis and Growth in Soybean. *Plant Physiol.* **1990**, *92*, 141–146. [[CrossRef](#)]
39. Alexieva, V.; Sergiev, I.; Mapelli, S.; Karanov, E. The effect of drought and ultraviolet radiation on growth and stress markers in pea and wheat. *Plant Cell Environ.* **2001**, *24*, 1337–1344. [[CrossRef](#)]
40. Björn, L.O.; Callaghan, T.V.; Johnsen, I.; Lee, J.A.; Manetas, Y.; Paul, N.D.; Sonesson, M.; Wellburn, A.R.; Coop, D.; Heide-Jørgensen, H.S.; et al. The effects of UV-B radiation on European heathland species. In *UV-B and Biosphere. Advances in Vegetation Science*; Rozema, J., Gieskes, W.W.C., Van De Geijn, S.C., Nolan, C., De Boois, H., Eds.; Springer: Dordrecht, The Netherlands, 1997; Volume 17, pp. 252–264.
41. Manetas, Y.; Petropoulou, Y.; Stamatakis, K.; Nikolopoulos, D.; Levizou, E.; Psaras, G.; Karabourniotis, G. Beneficial effects of enhanced UV-B radiation under field conditions: Improvement of needle water relations and survival capacity of *Pinus pinea* L. seedlings during the dry Mediterranean summer. In *UV-B and Biosphere. Advances in Vegetation Science*; Rozema, J., Gieskes, W.W.C., Van De Geijn, S.C., Nolan, C., De Boois, H., Eds.; Springer: Dordrecht, The Netherlands, 1997; Volume 17, pp. 100–108.
42. Poulson, M.E.; Donahue, R.A.; Konvalinka, J.; Boeger, M.R.T. Enhanced tolerance of photosynthesis to high-light and drought stress in *Pseudotsuga menziesii* seedlings grown in ultraviolet-B radiation. *Tree Physiol.* **2002**, *22*, 829–838. [[CrossRef](#)]
43. Hofmann, R.W.; Campbell, B.D.; Bloor, S.J.; Swinny, E.E.; Markham, K.R.; Ryan, K.G.; Fountain, D.W. Responses to UV-B radiation in *Trifolium repens* L.—Physiological links to plant productivity and water availability. *Plant Cell Environ.* **2003**, *26*, 603–612. [[CrossRef](#)]
44. Bandurska, H.; Niedziela, J.; Chadzinikolau, T. Separate and combined responses to water deficit and UV-B radiation. *Plant Sci.* **2013**, *213*, 98–105. [[CrossRef](#)] [[PubMed](#)]
45. Hofmann, R.W.; Campbell, B.D. Leaf-level responses to ultraviolet-B radiation in *Trifolium repens* populations under defoliation pressure. *Environ. Exp. Bot.* **2012**, *78*, 64–69. [[CrossRef](#)]
46. Bacelar, E.; Moutinho-Pereira, J.; Ferreira, H.; Correia, C. Enhanced ultraviolet-B radiation affect growth, yield and physiological processes on triticale plants. *Procedia Environ. Sci.* **2015**, *29*, 219–220. [[CrossRef](#)]
47. Newsham, K.K.; Robinson, S.A. Responses of plants in polar regions to UVB exposure: A meta-analysis. *Glob. Chang. Biol.* **2009**, *15*, 2574–2589. [[CrossRef](#)]
48. Porcar-Castell, A.; Juurola, E.; Nikinmaa, E.; Berninger, F.; Ensminger, I.; Hari, P. Seasonal acclimation of photosystem II in *Pinus sylvestris*. I. Estimating the rate constants of sustained thermal energy dissipation and photochemistry. *Tree Physiol.* **2008**, *28*, 1475–1482. [[CrossRef](#)] [[PubMed](#)]
49. Ranjbarfordoei, A.; Samson, R.; Van Damme, P. Photosynthesis performance in sweet almond [*Prunus dulcis* (Mill) D. Webb] exposed to supplemental UV-B radiation. *Photosynthetica* **2011**, *49*, 107. [[CrossRef](#)]
50. Osório, J.; Osório, M.L.; Correia, P.J.; de Varennes, A.; Pestana, M. Chlorophyll fluorescence imaging as a tool to understand the impact of iron deficiency and resupply on photosynthetic performance of strawberry plants. *Sci. Hortic.* **2014**, *165*, 148–155. [[CrossRef](#)]
51. Anjum, S.; Xie, X.; Wang, L.; Saleem, M.S.; Man, C.; Lei, W. Morphological, physiological and biochemical responses of plants to drought stress. *Afr. J. Agric. Res.* **2011**, *6*, 2026–2032.
52. Li, R.H.; Guo, P.G.; Michael, B.; Stefania, G.; Salvatore, C. Evaluation of chlorophyll content and fluorescence parameters as indicators of drought tolerance in barley. *Agric. Sci. China* **2006**, *5*, 751–757. [[CrossRef](#)]

53. Yao, J.; Sun, D.; Cen, H.; Xu, H.; Weng, H.; Yuan, F.; He, Y. Phenotyping of *Arabidopsis* drought stress response using kinetic chlorophyll fluorescence and multicolor fluorescence imaging. *Front Plant Sci.* **2018**, *9*, 603. [[CrossRef](#)]
54. Alba, C.; Hufbauer, R. Exploring the potential for climatic factors, herbivory, and co-occurring vegetation to shape performance in native and introduced populations of *Verbascum thapsus*. *Biol. Invasions* **2012**, *14*, 2505–2518. [[CrossRef](#)]
55. Hideg, É.; Nagy, T.; Oberschall, A.; Dudits, D.; Vass, I. Detoxification function of aldose/aldehyde reductase during drought and ultraviolet-B (280–320 nm) stresses. *Plant Cell Environ.* **2003**, *26*, 513–522. [[CrossRef](#)]
56. Rinnan, R.; Keinänen, M.M.; Kasurinen, A.; Asikainen, J.; Kekki, T.K.; Holopainen, T.; Ro-Poulsen, H.; Mikkelsen, T.N.; Michelsen, A. Ambient ultraviolet radiation in the Arctic reduces root biomass and alters microbial community composition but has no effects on microbial biomass. *Glob. Chang. Biol.* **2005**, *11*, 564–574. [[CrossRef](#)]
57. Jouili, H.; El Ferjani, E. Changes in antioxidant and lignifying enzyme activities in sunflower roots (*Helianthus annuus* L.) stressed with copper excess. *C. R. Biol.* **2003**, *326*, 639–644. [[CrossRef](#)]
58. Claussen, W. Proline as a measure of stress in tomato plants. *Plant Sci.* **2005**, *168*, 241–248. [[CrossRef](#)]
59. Lachmuth, S.; Durka, W.; Schurr, F.M. The making of a rapid plant invader: Genetic diversity and differentiation in the native and invaded range of *Senecio inaequidens*. *Mol. Ecol.* **2010**, *19*, 3952–3967. [[CrossRef](#)] [[PubMed](#)]
60. Colautti, R.I.; Maron, J.L.; Barrett, S.C. Common garden comparisons of native and introduced plant populations: Latitudinal clines can obscure evolutionary inferences. *Evol. Appl.* **2009**, *2*, 187–199. [[CrossRef](#)] [[PubMed](#)]
61. Hodgins, K.A.; Rieseberg, L. Genetic differentiation in life-history traits of introduced and native common ragweed (*Ambrosia artemisiifolia*) populations. *J. Evol. Biol.* **2011**, *24*, 2731–2749. [[CrossRef](#)]
62. Dieskau, J.; Bruelheide, H.; Gutknecht, J.; Erfmeier, A. Biogeographic differences in plant-soil biota relationships contribute to the invasion of *Verbascum thapsus*. *Ecol. Evol.* under review.
63. Alba, C.; Bowers, D.M.; Blumenthal, D.M.; Hufbauer, R. Evolution of growth but not structural or chemical defense in *Verbascum thapsus* (common mullein) following introduction to North America. *Biol. Invasions* **2011**, *13*, 2379–2389. [[CrossRef](#)]
64. Endriss, S.B.; Alba, C.; Norton, A.P.; Pyšek, P.; Hufbauer, R.A. Breakdown of a geographic cline explains high performance of introduced populations of a weedy invader. *J. Ecol.* **2018**, *106*, 699–713. [[CrossRef](#)]
65. Alpert, P.; Bone, E.; Holzapfel, C. Invasiveness, invasibility and the role of environmental stress in the spread of non-native plants. *Perspect Plant Ecol.* **2000**, *3*, 52–66. [[CrossRef](#)]
66. te Beest, M.; Elschot, K.; Olf, H.; Etienne, R.S. Invasion success in a marginal habitat: An experimental test of competitive ability and drought tolerance in *Chromolaena odorata*. *PLoS ONE* **2013**, *8*, e68274. [[CrossRef](#)] [[PubMed](#)]
67. Ashbacher, A.C.; Cleland, E.E. Native and exotic plant species show differential growth but similar functional trait responses to experimental rainfall. *Ecosphere* **2015**, *6*, 1–14. [[CrossRef](#)]
68. Antunes, C.; Pereira, A.J.; Fernandes, P.; Ramos, M.; Ascensão, L.; Correia, O.; Máguas, C. Understanding plant drought resistance in a Mediterranean coastal sand dune ecosystem: Differences between native and exotic invasive species. *J. Plant Ecol.* **2018**, *11*, 26–38. [[CrossRef](#)]
69. Erfmeier, A.; Böhnke, M.; Bruelheide, H. Secondary invasion of *Acer negundo*: The role of phenotypic responses versus local adaptation. *Biol. Invasions* **2011**, *13*, 1599–1614. [[CrossRef](#)]
70. Kumschick, S.; Hufbauer, R.A.; Alba, C.; Blumenthal, D.M. Evolution of fast-growing and more resistant phenotypes in introduced common mullein (*Verbascum thapsus*). *J. Ecol.* **2013**, *101*, 378–387. [[CrossRef](#)]
71. Hubbard, J.C.; Wilson, J.B. A survey of the lowland vegetation of the Upper Clutha District of Otago, New Zealand. *N. Z. J. Bot.* **1988**, *26*, 21–35. [[CrossRef](#)]
72. Turker, A.U.; Gurel, E. Common mullein (*Verbascum thapsus* L.): Recent advances in research. *Phytother. Res.* **2005**, *19*, 733–739. [[CrossRef](#)]
73. Gross, K.L.; Werner, P.A. The biology of Canadian weeds: 28. *Verbascum thapsus* L. and *V. blattaria* L. *Can. J. Plant Sci.* **1978**, *58*, 401–413. [[CrossRef](#)]
74. Kuznetsova, A.; Brockhoff, P.B.; Christensen, R.H.B. lmerTest Package: Tests in Linear Mixed Effects Models. *J. Stat. Softw.* **2017**, *82*. [[CrossRef](#)]

75. Alexieva, V.; Ivanov, S.; Sergiev, I.; Karanov, E. Interaction between stresses. *Bulg. J. Plant Physiol.* **2003**, *29*, 1–17.



© 2020 by the authors. Licensee MDPI, Basel, Switzerland. This article is an open access article distributed under the terms and conditions of the Creative Commons Attribution (CC BY) license (<http://creativecommons.org/licenses/by/4.0/>).

Chapter V: Synthesis

1. Main results

This thesis combines single-species and multi-species experimental approaches in greenhouse and outdoor common gardens with macroecological analyses based on global UV-B and climate data, as well as species distribution data to gain some knowledge about mechanisms of plant invasions in high-UV-B environments. The conducted studies as evidenced in Chapters II to IV revealed the following main results:

Chapter II

The multi-species comparison revealed **high importance of biogeographic characteristics of the native range for plant responses to UV-B**. Thus, we recommend to consider the native UV-B niche in future species distribution predictions. However, a **functional UV-B preadaptation due to different plant traits appeared to play a subordinate role** in this study, whereas our results support the **importance of high phenotypic plasticity** during colonization of high-UV-B environments.

Chapter III

The comparison of native and exotic origins of eight species in two reciprocal common gardens in Germany and New Zealand revealed clear evidence for **origin differentiation due to divergent natural selection**. This local adaptation resulted in a higher performance of local individuals compared to foreign individuals in both common garden experiments, respectively, when tested on a multi-species basis. Although origin differentiation became evident in response to the applied UV-B regimes, it was **not found to be directly attributable to selection by elevated UV-B radiation** in New Zealand, but might rather be the result of **selection for genotypes with high phenotypic plasticity** during the invasion.

Chapter IV

Investigation of combined drought and UV-B effects on native and exotic *Verbascum thapsus* populations pointed at similar physiological plant responses to both abiotic factors and, therefore, support the idea of **UV-B pre-adaptation as being induced by high drought tolerance**. Additionally, we found no evidence for a detrimental synergy of drought and UV-B radiation, but rather **antagonistic effects** of the two environmental factors. Against our expectations we **did not find evidence for local adaptation of exotic populations** from New Zealand to UV-B in growth and physiological responses.

2. Overall discussion

Each chapter of this thesis is dedicated to one particular aspect of plant invasions in high-UV-B environments, but together they offer the opportunity to derive more comprehensive insights in existing mechanisms and coherences. In the following, all results are jointly discussed according to the conceptual framework of factors affecting invasion success (**Fig. 3**) and thereby highlighting the different impacts of (1) genotype, (2) phenotype, (3) environment and (4) global change on plant invasions in high-UV-B environments.

2.1. Genetic predisposition and adaptation to UV-B

The effect of genotype on plant invasions in high-UV-B environments was addressed in all publications of this thesis from a variety of perspectives. An exotic genotype might be either predisposed to colonize habitats with higher UV-B intensities (see **Chapter II**) or might adapt to UV-B conditions in the invaded range as consequence of local selection by UV-B (see **Chapters III and IV**).

Regarding potential predisposition of native genotypes to high-UV-B environments our findings support the idea of the ‘environmental matching hypothesis’ (Ricciardi et al. 2013) due to pre-experienced higher UV-B intensities as native range (UV-B niche) characteristics were linked to exotic species’ UV-B response (see **Fig. 5**). Environmental matching provides the basis for ‘climate envelope modelling’ that is an accepted and often-used method to predict patterns of species distribution also in the context of plant invasions (Hijmans & Graham 2006). The underlying mechanism might be a previous adaptation to higher UV-B radiation levels in the native range prior to invasion that provide benefits during colonization of the invaded range. However, a functional pre-adaptation by leaf or fitness-related traits turned out to only play a subordinate role in the investigated pool of herbaceous grassland species. It may still apply that species of other habitat types are more responsive towards differentiation in response to UV-B due to species’ life span, life form, reproductive mode or phenology (see Suchar & Robberecht 2018). Nevertheless, identification of single traits or trait syndromes that characterize invasive species is likely to be highly context-dependent since invasion success displays a complex interaction of species’ physiological capacity and environmental conditions (Higgins & Richardson 2014).

Regardless of a species' potential predisposition to high-UV-B environments, we hypothesized recent evolutionary processes that took place after introduction and establishment in the novel habitat. The evolution of geographic clines in response to local climatic conditions has been observed in several invasive plant species to date (Moran & Alexander 2014, Seipel et al. 2015, Helliwell et al. 2018). For species invading New Zealand we did not find any evidence for local adaptation that could be directly attributed to selection by high UV-B intensities. One explanation might be that other exotic genotypes than those considered may be more suitable to test for local adaptation to UV-B. Multi-species approaches are often limited in terms of replication on the population level and therefore might not always be representative for the genetic diversity of study species in the native and invaded range. However, the several single-species studies conducted did also not reveal evidence for recent evolutionary processes explicitly linked to high UV-B levels (see **Chapter IV**, Beckmann et al. 2012, Wang et al. 2016, Hock et al. 2020). In contrast, Watermann et al. (2020) found a divergent response to artificial UV-B for different elevational origins of invasive alien species in South Africa indicating a stronger UV-B selection pressure in this specific scenario compared to plant invasions in New Zealand grasslands.

Moreover, species' residence time is likely to be related to evolutionary processes, as a number of about 50-150 generations is usually required to adapt to local environmental conditions appropriately (Moran & Alexander 2014). Since recorded naturalization in New Zealand dates back more than 120 years for the majority of study species, evolution is likely to have occurred and a general UV-B-independent origin differentiation was found among different species (see Tab. 1). However, in this context also the stage of invasion is important to detect local adaptation, as especially the need to adapt to the novel environment as well as a potential lack of genetic diversity of founder populations might be the reason for longer lag phases during the invasion process (Crooks 2005, Schierenbeck & Ellstrand 2009, Oduor et al. 2016). These constraints might be mitigated by multiple introductions from diverse native sources (Colautti & Barrett 2013, Moran & Alexander 2014), but individual circumstances of introduction are mostly untraceable for many alien species in New Zealand.

Furthermore, the choice of response variable might be important to find UV-B-induced local adaptation. To test reproductive and fitness-related traits is generally recommended, since they are more likely to have direct implications for next generations and to drive long-term effects than performance traits (Moran & Alexander 2014, Zenni et al. 2014). In this thesis

predominantly growth variables and productivity served as response variables reducing the chance to detect the selective potential of UV-B radiation. These performance traits might also be unsuitable to assess evolutionary processes in response to UV-B radiation as they might be under different conflicting selection pressures, e.g. climate, biotic interactions and resource availability, or existing correlations between traits could impair single trait selection processes (Colautti & Barrett 2013, Felker-Quinn et al. 2013, Moran & Alexander 2014). According to this, Wang et al. (2016) found invasive populations of *Triadica sebifera* to be less resilient in response to UV-B radiation than native provenances, probably due to reduced secondary metabolite production in consequence of a rapidly evolved trade-off between defense and growth during the invasion process. Thus, increased competitive ability by reduced investment in defense measures might contradict improvement of photoprotection in response to high UV-B levels. Conclusively, despite the various quantifiable limiting effects of UV-B on plant performance and physiology, there was no striking evidence for UV-B radiation acting as selective force during plant invasions in high-UV-B environments (see **Fig. 5**).

2.2. Importance of phenotypic plasticity in response to UV-B

UV-B radiation generally affect phenotypic expressions of leaf traits or plant habit in different ways: Some modifications of phenotype indicate plant damage or degradation as consequence of stressful conditions induced by high-energy radiation, e.g. reductions in biomass and reproductive capacity. Other phenotypic changes, e.g. smaller and thicker leaves, increased branching and reduced plant height often result in functional adaptations with the aim to partially avoid UV-B exposure or to shield essential structures, such as the photosynthesis apparatus (see Suchar & Robberecht 2015, 2016). These phenotypic changes, which modify the plant towards the new necessary phenotypic optimum, imply an improvement in high-UV-B environments and plasticity in these plant traits in response to UV-B is of high importance (Ghalambor et al. 2007).

Phenotypic plasticity is likely to play an important role for the investigated plant species, not least because no evidence was found for recent adaptation to UV-B but quantifiable phenotypic effects in response to UV-B radiation have been determined for the majority of study species (see **Chapters II to IV**, see **Fig. 5**). Early in the history of invasion ecology, a broad native range had been associated with the species' ability to cope with a broad range of climatic conditions

and consequently display a larger potential distribution area (Higgins & Richardson 2014, Pyšek et al. 2015, Kalusová et al. 2017). It is hard to disentangle whether this skill was either acquired in consequence of a wide distribution or the broader physiological niche rather served as requirement (i.e. predictor) for a successful spread. For several plant invasions, it has been assumed that an initial selection of more plastic genotypes during introduction in the invaded range is considered a driver for post-introduction evolution (e.g. Ghalambor et al. 2007, Si et al. 2014, Zenni et al. 2014). However, the ability to plastically respond to changes in environmental conditions might be to a certain extent determined by the genotype and consequently may also be adaptive itself (e.g. Matesanz et al. 2010, Oplaat & Verhoeven 2015, Turner et al. 2015, Molina-Montenegro et al. 2016).

Regarding the investigated pool of species invading New Zealand we confirm plastic responses to UV-B radiation in several traits whereas we did not reveal evidence for adaptive plasticity as we found plasticity to occur to a similar extent both in native and exotic individuals. Selection of highly plastic 'general-purpose-genotypes' during invasions is favored by asexual reproduction and selfing in alien species, since recent genetic adaptation requires outcrossing during the invasion process (Oplaat & Verhoeven 2015, Oduor et al. 2016). Some of the most important invasive alien species in New Zealand are known for their clonal reproduction (see Beckmann et al. 2009), but this thesis is based on a quite heterogeneous species pool in terms of their reproductive strategies. Moreover, Huang et al. (2015) hypothesized that evolution of greater plasticity is especially constrained in stressful environments as phenotypic plasticity might be associated with additional costs for plant species. During plant invasions in high-UV-B environments, invasive species are exposed to an additional growth-limiting factor that might suppress potentially costly evolution of higher phenotypic plasticity. In addition to the potential costs involved, high phenotypic plasticity during plant invasions is assumed to depend on the difference between the optimal native and invasive phenotype, the predictability of the novel environment and the time since introduction (Lande 2015). According to this, the lack of adaptive phenotypic plasticity in high-UV-B environments observed in this thesis might be explained by an only medium phenotype modification that is necessary to cope with the constant exposure to elevated UV-B intensities across all life stages. If phenotypic plasticity of native genotypes is already sufficient to colonize high-UV-B environments, one would rather expect to observe slow genetic assimilation during the ongoing invasion process.

Nevertheless, it is conceivable that species invading high-UV-B environments display higher phenotypic plasticity in response to UV-B than non-invasive species. Previous studies revealed higher physiological but not morphological plasticity of invasive species compared to phylogenetically related native species in response to different light conditions (Hou et al. 2015, Fenollosa et al. 2017). Different photoprotective strategies for coexisting native and invasive species indicate an ‘all-in strategy’ of physiological plasticity for invasive species and a native ‘saving strategy’ rather associated with morphological changes (Molina-Montenegro et al. 2016, Fenollosa et al. 2017). These findings support the idea of ‘fitness homeostasis’ claiming phenotypic plasticity in functional traits and constancy in performance traits to be the most promising strategy for invasive species to keep plant fitness high under changing environmental conditions (see Ruprecht et al. 2014).

2.3. Environmental interactions in high-UV-B environments

The contribution of environmental conditions to successful plant invasions has been observed in diverse manners. Especially the abiotic factors temperature and precipitation set the basic conditions for establishment and spread of alien species, since they vary at larger spatial scales and determine fundamental climate zones and species’ physiological niches (Petitpierre et al. 2012, Ahmad et al. 2019). Furthermore, soil fertility and light conditions display a subordinate role at the local scale, and here biotic interactions come into play additionally. In view of this, the present thesis aimed at an impact classification of UV-B radiation that on the one hand fundamentally differs at the global scale and with seasonal fluctuations, such as the macroclimatic factors temperature and precipitation. On the other hand, UV-B radiation is closely associated with local light conditions and shading, as well as elevation that might substantially change at a smaller spatial scale. This thesis indicates a measurable impact of UV-B on plants but a medium effect size compared to other more harmful abiotic factors, such as water availability (see **Chapter IV**, see **Fig. 5**). This assessment might be confirmed by the lack of evidence for selective power of UV-B radiation and the repeated findings of plastic plant responses to the limiting environmental factor. Nevertheless, interaction effects of UV-B and other environmental factors may be of importance during plant invasions.

Even though natural high-UV-B intensities are not a serious threat to grassland species, UV-B exposure triggers essential physiological plant responses that are meaningful in the context of other environmental stresses. UV-B radiation directly induces production of antioxidants and DNA repair mechanisms and, thus, provokes a mitigation of any oxidative stress in plant cells that might be caused by several environmental factors (Bandurska et al. 2013, Suchar & Robberecht 2015). In consequence, plants exposed to UV-B are, e.g., less sensitive to high levels of photosynthetically active radiation (PAR, Wargent et al. 2015), limited water availability and drought events (Basahi et al. 2014, Araújo et al. 2016) or elevated ozone concentrations (Wang et al. 2016) due to cross-protection effects (see **Fig. 5**). However, interaction effects of UV-B radiation and temperature imply a broad range of patterns and range from cross-resistance effects to detrimental synergistic effects of both stressors (Caldwell et al. 2007, Suchar & Robberecht 2015, 2016, Martel & Qaderi 2016). Moreover, biotic interactions are expected to be of importance during the invasion process, even if the release from specific enemies after introduction to a novel range is a valid assumption for many plant invasions. Thus, an UV-B induced resistance to general herbivores and pathogens due to secondary metabolites with defense abilities might display an effective prevention from biotic damage to alien species (see Caldwell et al. 2007, Kuhlmann & Müller 2010).

This thesis especially addressed New Zealand grasslands, representative for strongly invaded high-UV-B environments. These investigated systems are particularly characterized by high solar radiation intensities, limited water availability or regular drought events, as well as high temperatures during the day and occasionally very low night temperatures. Thus, reduced sensitivity to common biotic and abiotic stresses induced by UV-B radiation during establishment and colonization of high-UV-B environments is likely to facilitate invasion success. Although direct UV-B effects on plants are manageable, the resulting release from ambient environmental stresses could have higher impact on survival and spread of alien species. Therefore, the importance of high UV-B for plant invasions results from its role in the interplay of environmental factors rather than from its direct effect on plant growth and physiology.

2.4. Current and future impact of global change

Human impact generally has great influence on plant invasions worldwide and also directly and indirectly affects plant invasions in high-UV-B environments. The most direct anthropogenic influences on plant invasions are the still ongoing transport of plant material over long distances and the associated effects of multiple introductions and locally increased propagule pressure of alien species. The northern hemisphere was identified as the major donor region for alien species, whereas the Pacific islands and Australasia accommodate the highest number of naturalized species (van Kleunen et al. 2015). Temperate high-UV-B environments are located in southern hemisphere mid-latitudes that typically look back on a relatively short history of intensive land use and industrialization. Due to a long-lasting period of previous isolation or at least conservation of these regions, sudden intense anthropogenic disturbance led to an immense increase of alien species in quickly changing ecosystems. In this context, phenotypic plasticity might be especially beneficial not only for colonizing novel habitats but also in response to global change and associated increasing climatic unpredictability (Matesanz et al. 2010, Nicotra et al. 2010, Fenolosa et al. 2017). Especially Central European plant species from more productive native habitats or with a wide native tolerance range regarding habitat productivity have been considered preadapted to become invasive (Dostál et al. 2013). Thus, invasion success of these species might be promoted by the increasing global nitrogen deposition associated with anthropogenic land use.

Moreover, human induced climate change further modifies high-UV-B environments. Merilä (2012) revealed that most plant responses to climate change so far rely on species plasticity rather than genetic adaptation. Some previous studies show a mitigating effect of UV-B on expected climate change consequences, such as higher temperatures, increasing ozone concentrations or limited water availability, and an additionally facilitating effect of increasing CO₂ on plant growth (e.g. Lavola et al. 2013, Bornman et al. 2015, Wang et al. 2016). These studies indicate reduced severity of climate change consequences for alien species in high-UV-B environments.

In addition, surface UV-B intensities are further changing due to human impact in direct consequence of long-term changes in ozone levels, aerosol emissions and cloud patterns (McKenzie et al. 2007). Ozone levels in turn affect climate factors, such as wind patterns, precipitation and temperature, which again interact with UV-B radiation (Bornman et al. 2015). Especially in urban areas and regions of industrialization air pollution and aerosol loads

significantly reduce surface UV-B radiation (McKenzie et al. 2007). UV-B exposure on plants is furthermore directly impacted by anthropogenic changes in land use and vegetation cover (Bornman et al. 2015). Therefore, predictions of future surface UV-B levels have to include varying socioeconomic scenarios simulating different land use intensities and levels of greenhouse gas concentrations, ozone precursor and aerosol emissions. Using such simulations, Watanabe et al. (2011) predict pronounced changes in UV-B radiation in the northern and southern extratropics until 2100. While in current high-UV-B environments in the southern hemisphere mid-latitudes UV-B radiation will decrease by at least 5% due to stratospheric ozone increases, reductions in tropospheric ozone and aerosols will lead to an improvement of air quality and consequently increasing UV-B radiation intensities in the northern hemisphere mid-latitudes.

Given the number of potentially changing environmental factors – just as their interactions – in the context of global change, reliable predictions on present or future plant invasions in high-UV-B environments are difficult to make (see Fig. 5). In the long term, global UV-B evolution might even question the current classification of high-UV-B environments, as local solar UV-B radiation intensities and even global maximum UV-B levels might further increase or decrease depending on human impact.

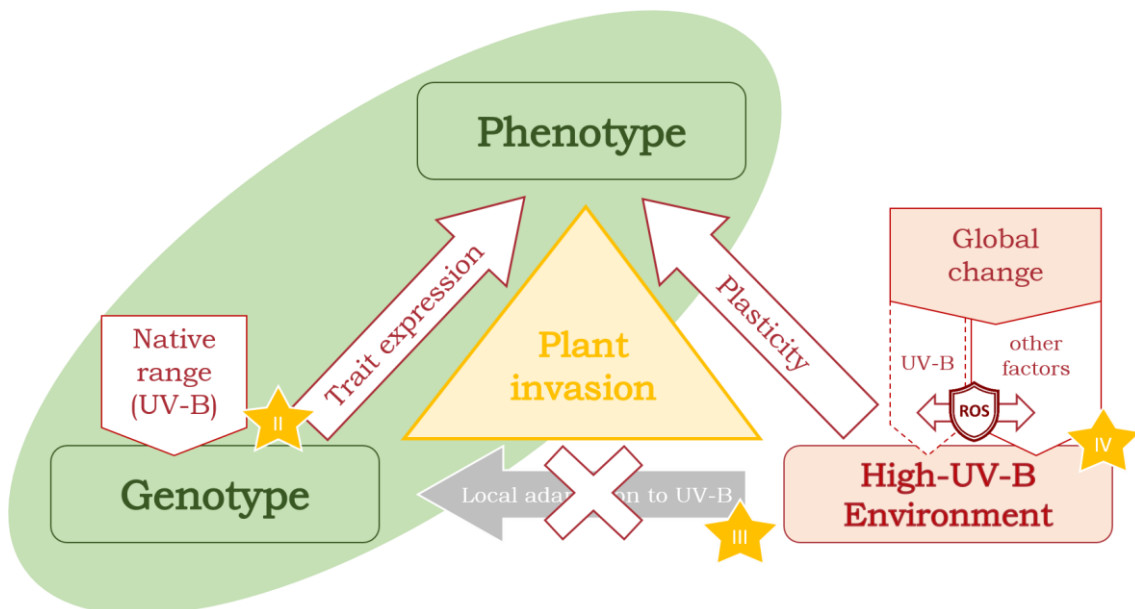

Figure 5: Framework of factors affecting plant invasions in high-UV-B environments based on the conceptual framework (see Fig. 3) and modified in accordance with the findings of Chapters II to IV

3. Outlook

To further improve the understanding of plant invasions in high-UV-B environments and underlying mechanisms some additional aspects have to be addressed more explicitly or with modified methodological approaches in future research.

3.1. High-quality quantification of relevant UV-B effects on plants

UV-B effects on plant fitness and growth can be best quantified in natural ambient UV-B environments with UV filters serving as comparative treatments. Solar radiation is a complex natural component providing not only a particular composition of different wavelengths but also determining microclimatic conditions due to unpredictable presence and intensity. In contrast, static application of artificial UV-B in controlled environments is more appropriate to investigate UV-B perception and induced physiological responses, e.g. DNA damage and repair rates or production of secondary metabolites. However, the usage of artificial UV-B radiation often leads to unrealistic proportions of UV-A, UV-B and visible light (PAR) wavelengths and consequently results in plant responses that are not representative for natural effect sizes. Accompanying temperature conditions always affect UV-B effects on plants, either directly by the known interaction effects on plant physiology or even due to temperature sensitivity of some measuring instruments. Independent of the nature of experiments (i.e. indoor or outdoor), it is important to pay attention to spectral properties, filters and accurate UV-B measurements ideally realized by spectroradiometers that allow quantification at discrete wavelength (Bornman et al. 2015).

3.2. Common gardens vs. in-situ approaches

The major strength of common garden experiments is the possibility to quantify the genetic component of phenotypic variation by comparing trait variation among different genotypes (Kawecki & Ebert 2004, Zenni et al. 2014). Thereby, it is easy to control most biotic and abiotic conditions and to focus on particular environmental factors or gradients. Common garden approaches are also suitable to investigate specific interaction effects of environmental factors but might involve the danger of setting artificial and therefore inappropriate conditions that do not apply in natural environments. In consequence, it can be difficult to determine how

environmental factors affect habitat invasiveness and whether in combination they effectively act synergistically, antagonistically or imply cross-protection effects for plants. However, to elucidate consequences of ambient UV-B for alien species more complex natural settings should be investigated to observe interaction effects of relevant local biotic and abiotic environmental factors. Monitoring of wild populations allows for the assessment of plant responses and simultaneous in-situ measurements of local UV-B radiation and other environmental factors. Especially biotic interactions are usually difficult to simulate in artificial environments but might be crucial for alien species in different stages of invasion. Investigations of the effects of pathogens, herbivores or competition might be most accurately observed in field experiments and is assumed to be affected in the context of high UV-B radiation (e.g. Caldwell et al. 2007, Kuhlmann & Müller 2010, Escobar-Bravo et al. 2017). Environmental interactions with UV-B radiation in general and interactions of UV-B with biotic environmental factors in particular display a recent knowledge gap in the light of further climate change and human impact (Bornman et al. 2015).

3.3. Experimental design issues and limitations

There are some limitations of experimental settings used to investigate particular plant invasions. Relying on only one common garden experiment only allows estimation of differentiation between included genotypes, but no information is gained on the experimental environment or genotype x environment interaction. Therefore, reciprocal transplants or common garden experiments are typically conducted in invasion ecology research to consider the effects of the respective donor environments on the response of tested genotypes (Kawecki & Ebert 2004, de Villemereuil et al. 2016). Reciprocal common gardens offer the opportunity to test for local adaptation of genotypes, but direct measurement of fitness traits is desirable to assess the evolutionary importance (Moran & Alexander 2014). However, reciprocal transplant experiments cannot unequivocally distinguish between contribution of recent natural selection after introduction and introduced preadapted genotypes to observed local adaptation (Colautti & Lau 2015). Moreover, genetic and epigenetic effects cannot be clearly differentiated by common garden experiments and could be more specifically addressed in multigenerational common garden experiments (Moran & Alexander 2014). The latter would be additionally interesting with regard to long-term UV-B effects on plant fitness. Ideally, common gardens should be furthermore replicated within the native and invaded range to cover a broader range

of environmental variation of the respective regions (Moloney et al. 2009). Multiple common gardens in one region further provide the opportunity to disentangle effects of genetic and environmental factors as populations often develop geographical clines and exhibit significant trait variation along latitudinal or environmental gradients (Colautti et al. 2009, Zenni et al. 2014). Since UV-B radiation intensities naturally change with latitude, implications of potentially existing geographic clines in response to other environmental factors might provide valuable insights in environmental interaction effects. Furthermore, it is also recommendable to focus on more than one high-UV-B invaded range of alien species, as local environmental situations might be rather individual and general UV-B effect patterns are more likely to be detected among several environments (Taylor et al. 2016, Hierro et al. 2017).

3.4. Testing for UV-B preadaptation

Identification of species with distinct invasiveness in high-UV-B environments based on a general predisposition to cope with elevated UV-B or even previous experience of elevated UV-B levels in their native range requires a good choice of target species and suitable comparative groups. In this thesis evidence for UV-B preadaptation of species was derived from comparisons within a pool of already invasive species representing alien species of New Zealand grasslands (see **Chapter II**). In this context, it might be furthermore meaningful to compare species with different invasion success in high-UV-B environments ranging from failed alien species to intrusive invaders in their response to UV-B radiation. Different levels of invasiveness are not independent of time since introduction and propagule pressure, generally difficult to define in meaningful categories and even harder to describe as continuous variable (Schlaepfer et al. 2010). Furthermore, those experiments might involve some logistic challenges especially if they are conducted in the invaded range, since the import of native genetic plant material always offers risks to already invaded regions and is therefore often strictly regulated. To reliably assess the impact of particular target traits on UV-B predisposition one might consider more homogeneous species pools regarding other traits (e.g. life form, life span, habit). Comparisons of congeneric species could even allow conclusions about their aptitude for high-UV-B environments independent of omnipresent phylogenetic effects (see van Kleunen & Johnson 2007, Schlaepfer et al. 2010). Leaf traits, leaf anatomy, physiological traits or even plasticity in these traits display potential target traits or species characteristics that might have a key function in UV-B preadaptation and are therefore worth some experimental testing.

Furthermore, testing of different locally adapted ecotypes within single species might give further insights in the importance of pre-experienced UV-B radiation levels prior to introduction to high-UV-B environments. In this context, investigations along elevational gradients might be especially suitable to deepen our understanding (see Watermann et al. 2020).

4. Conclusion

The present thesis assessed mechanisms of plant invasions in high-UV-B environments and the impact of the abiotic environmental factor UV-B on alien plant species. The conducted approaches revealed a medium overall direct impact of UV-B on plant growth and development compared to drought that also represents a common abiotic stress of grassland ecosystems. Higher importance of UV-B radiation to alien species during invasions is likely to arise from its capability to induce physiological cross-protection to other environmental stresses that might limit plant performance in novel habitats. Moreover, there was no evidence for UV-B acting as selective force during colonization of high-UV-B environments. Nevertheless, native range UV-B niche characteristics were associated with plant performance in different UV regimes and therefore indicated a useful preadaptation by prior-introduction experience of elevated UV-B intensities. Thus, future consideration of native UV-B niches might be meaningful to model species physiological niches and to predict potential species distribution. Phenotypic plasticity turned out to be a beneficial characteristic for species facing unfamiliar high UV-B intensities among all approaches and is likely to display an essential advantage concerning ongoing global environmental change. Current and future human impact on climate and ecosystems will further directly change surface UV-B radiation levels at global scale, thereby reducing the present overall mean UV-B difference between the hemispheres and potentially creating novel high-UV-B environments elsewhere. Nevertheless, global change will result in various effects on other biotic and abiotic components of habitats that will certainly interact with each other and also with UV-B. Thus, plant invasions in high-UV-B environments already face complex environmental conditions, whose interplay and consequences for alien species is worth to be addressed in more natural settings and field studies in the future.

Bibliography

Bibliography

- Ahmad, R., Khuroo, A. A., Hamid, M., Charles, B., & Rashid, I. (2019). Predicting invasion potential and niche dynamics of *Parthenium hysterophorus* (Congress grass) in India under projected climate change. *Biodiversity and Conservation*, *28*(8-9), 2319-2344.
- Araújo, M., Santos, C., Costa, M., Moutinho-Pereira, J., Correia, C., & Dias, M. C. (2016). Plasticity of young *Moringa oleifera* L. plants to face water deficit and UVB radiation challenges. *Journal of Photochemistry and Photobiology B: Biology*, *162*, 278-285.
- Austin, A. T., & Vivanco, L. (2006). Plant litter decomposition in a semi-arid ecosystem controlled by photodegradation. *Nature*, *442*(7102), 555-558.
- Ballaré, C. L., Caldwell, M. M., Flint, S. D., Robinson, S. A., & Bornman, J. F. (2011). Effects of solar ultraviolet radiation on terrestrial ecosystems. Patterns, mechanisms, and interactions with climate change. *Photochemical & Photobiological Sciences*, *10*(2), 226-241.
- Bandurska, H., Niedziela, J., & Chadzinikolau, T. (2013). Separate and combined responses to water deficit and UV-B radiation. *Plant Science*, *213*, 98-105.
- Barnes, P. W., Tobler, M. A., Keefover-Ring, K., Flint, S. D., Barkley, A. E., Ryel, R. J., & Lindroth, R. L. (2016). Rapid modulation of ultraviolet shielding in plants is influenced by solar ultraviolet radiation and linked to alterations in flavonoids. *Plant, Cell & Environment*, *39*(1), 222-230.
- Basahi, J. M., Ismail, I. M., & Hassan, I. A. (2014). Effects of enhanced UV-B radiation and drought stress on photosynthetic performance of lettuce (*Lactuca sativa* L. Romaine) plants. *Annual Research & Review in Biology*, 1739-1756.
- Beckmann, M., Erfmeier, A., & Bruehlheide, H. (2009). A comparison of native and invasive populations of three clonal plant species in Germany and New Zealand. *Journal of Biogeography*, *36*(5), 865-878.
- Beckmann, M., Václavík, T., Manceur, A. M., Šprtová, L., von Wehrden, H., Welk, E., & Cord, A. F. (2014). gUV: a global UV-B radiation data set for macroecological studies. *Methods in Ecology and Evolution*, *5*(4), 372-383.
- Bellard, C., Cassey, P., & Blackburn, T. M. (2016). Alien species as a driver of recent extinctions. *Biology Letters*, *12*(2), 20150623.
- Belnap, J., Phillips, S. L., Flint, S., Money, J., & Caldwell, M. (2008). Global change and biological soil crusts: effects of ultraviolet augmentation under altered precipitation regimes and nitrogen additions. *Global Change Biology*, *14*(3), 670-686.

Bibliography

- Blackburn, T. M., Essl, F., Evans, T., Hulme, P. E., Jeschke, J. M., Kühn, I., Kumschick, S., Marková, Z., Mrugała, A., Nentwig, W., Pergl, J., Pyšek, P., Rabitsch, W., Ricciardi, A., Richardson, D. M., Sendek, A., Vilà, M., Wilson, J. R. U., Winter, M., Genovesi, P., & Bacher, S. (2014). A unified classification of alien species based on the magnitude of their environmental impacts. *PLoS Biology*, *12*(5), e1001850.
- Blackburn, T. M., Pyšek, P., Bacher, S., Carlton, J. T., Duncan, R. P., Jarošík, V., Wilson, J. R. U., & Richardson, D. M. (2011). A proposed unified framework for biological invasions. *Trends in Ecology & Evolution*, *26*(7), 333-339.
- Blossey, B., & Notzold, R. (1995). Evolution of increased competitive ability in invasive nonindigenous plants: a hypothesis. *Journal of Ecology*, *83*(5), 887-889.
- Bornman, J. F., Barnes, P. W., Robinson, S. A., Ballare, C. L., Flint, S. D., & Caldwell, M. M. (2015). Solar ultraviolet radiation and ozone depletion-driven climate change: effects on terrestrial ecosystems. *Photochemical & Photobiological Sciences*, *14*(1), 88-107.
- Bossdorf, O., Auge, H., Lafuma, L., Rogers, W. E., Siemann, E., & Prati, D. (2005). Phenotypic and genetic differentiation between native and introduced plant populations. *Oecologia*, *144*(1), 1-11.
- Buckley, Y. M., & Csergő, A. M. (2017). Predicting invasion winners and losers under climate change. *Proceedings of the National Academy of Sciences*, *114*(16), 4040-4041.
- Buswell, J. M., Moles, A. T., & Hartley, S. (2011). Is rapid evolution common in introduced plant species? *Journal of Ecology*, *99*(1), 214-224.
- Caldwell, M. M., Bornman, J. F., Ballaré, C. L., Flint, S. D., & Kulandaivelu, G. (2007). Terrestrial ecosystems, increased solar ultraviolet radiation, and interactions with other climate change factors. *Photochemical & Photobiological Sciences*, *6*(3), 252-266.
- Carboni, M., Münkemüller, T., Lavergne, S., Choler, P., Borgy, B., Violle, C., Essl, F., Roquet, C., Munoz, F., DivGrass Consortium, & Thuiller, W. (2016). What it takes to invade grassland ecosystems: traits, introduction history and filtering processes. *Ecology Letters*, *19*(3), 219-229.
- Catford, J. A., Jansson, R., & Nilsson, C. (2009). Reducing redundancy in invasion ecology by integrating hypotheses into a single theoretical framework. *Diversity and Distributions*, *15*(1), 22-40.
- Catford, J. A., Kalisz, S., Simberloff, D., & Wardle, D. A. (2017). A framework for understanding human-driven vegetation change. *Oikos*, *126*(12), 1687-1698.
- Catford, J. A., Smith, A. L., Wragg, P. D., Clark, A. T., Kosmala, M., Cavender-Bares, J., Reich, P. B., & Tilman, D. (2019). Traits linked with species invasiveness and community invasibility vary with time, stage and indicator of invasion in a long-term grassland experiment. *Ecology Letters*, *22*(4), 593-604.

- Cervera, J. C., & Parra-Tabla, V. (2009). Seed germination and seedling survival traits of invasive and non-invasive congeneric *Ruellia* species (*Acanthaceae*) in Yucatan, Mexico. *Plant Ecology*, *205*(2), 285-293.
- Chalker-Scott, L., & Scott, J. D. (2004). Elevated ultraviolet-B radiation induces cross-protection to cold in leaves of rhododendron under field conditions. *Photochemistry and Photobiology*, *79*(2), 199-204.
- Chapman, D. S., Makra, L., Albertini, R., Bonini, M., Páldy, A., Rodinkova, V., Šikoparija, B., Weryszko-Chmielewska, E., & Bullock, J. M. (2016). Modelling the introduction and spread of non-native species: International trade and climate change drive ragweed invasion. *Global Change Biology*, *22*(9), 3067-3079.
- Clout, M. N., & Lowe, S. J. (2000). Invasive species and environmental changes in New Zealand. In: Mooney, H. A., Hobbs, R. J. (eds) *Invasive species in a changing world*. Island Press, Washington D.C., 369-383.
- Coffey, A., Prinsen, E., Jansen, M. A. K., & Conway, J. (2017). The UVB photoreceptor UVR8 mediates accumulation of UV-absorbing pigments, but not changes in plant morphology, under outdoor conditions. *Plant, Cell & Environment*, *40*(10), 2250-2260.
- Colautti, R. I., & Barrett, S. C. (2013). Rapid adaptation to climate facilitates range expansion of an invasive plant. *Science*, *342*(6156), 364-366.
- Colautti, R. I., & Lau, J. A. (2015). Contemporary evolution during invasion: evidence for differentiation, natural selection, and local adaptation. *Molecular Ecology*, *24*(9), 1999-2017.
- Colautti, R. I., Maron, J. L., & Barrett, S. C. (2009). Common garden comparisons of native and introduced plant populations: latitudinal clines can obscure evolutionary inferences. *Evolutionary Applications*, *2*(2), 187-199.
- Crooks, J. A. (2005). Lag times and exotic species: The ecology and management of biological invasions in slow-motion. *Ecoscience*, *12*(3), 316-329.
- Dai, Q., & Upadhyaya, M. K. (2002). Seed germination and seedling growth response of selected weedy species to ultraviolet-B radiation. *Weed Science*, *50*(5), 611-615.
- Davis, M. A., & Thompson, K. (2000). Eight ways to be a colonizer; two ways to be an invader: a proposed nomenclature scheme for invasion ecology. *Bulletin of the Ecological Society of America*, *81*(3), 226-230.
- Demkura, P. V., Abdala, G., Baldwin, I. T., & Ballaré, C. L. (2010). Jasmonate-dependent and-independent pathways mediate specific effects of solar ultraviolet B radiation on leaf phenolics and antiherbivore defense. *Plant Physiology*, *152*(2), 1084-1095.

Bibliography

- de Villemereuil, P., Gaggiotti, O. E., Mouterde, M., & Till-Bottraud, I. (2016). Common garden experiments in the genomic era: new perspectives and opportunities. *Heredity*, *116*(3), 249-254.
- Dlugosch, K. M., & Parker, I. M. (2008). Founding events in species invasions: genetic variation, adaptive evolution, and the role of multiple introductions. *Molecular Ecology*, *17*(1), 431-449.
- Dostál, P., Dawson, W., van Kleunen, M., Keser, L. H., & Fischer, M. (2013). Central European plant species from more productive habitats are more invasive at a global scale. *Global Ecology and Biogeography*, *22*(1), 64-72.
- Dukes, J. S., & Mooney, H. A. (1999). Does global change increase the success of biological invaders? *Trends in Ecology & Evolution*, *14*(4), 135-139.
- Dullinger, I., Wessely, J., Bossdorf, O., Dawson, W., Essl, F., Gatringer, A., Klöner, G., Kreft, H., Kuttner, M., Moser, D., Pergl, J., Pyšek, P., Thuiller, W., van Kleunen, M., Weigelt, P., Winter, M., & Dullinger, S. (2017). Climate change will increase the naturalization risk from garden plants in Europe. *Global Ecology and Biogeography*, *26*(1), 43-53.
- Duncan, R. P., Webster, R. J., & Jensen, C. A. (2001). Declining plant species richness in the tussock grasslands of Canterbury and Otago, South Island, New Zealand. *New Zealand Journal of Ecology*, 35-47.
- Erfmeier, A. (2013). Constraints and release at different scales—The role of adaptation in biological invasions. *Basic and Applied Ecology*, *14*(4), 281-288.
- Escobar-Bravo, R., Klinkhamer, P. G., & Leiss, K. A. (2017). Interactive effects of UV-B light with abiotic factors on plant growth and chemistry, and their consequences for defense against arthropod herbivores. *Frontiers in Plant Science*, *8*, 278.
- Felker-Quinn, E., Schweitzer, J. A., & Bailey, J. K. (2013). Meta-analysis reveals evolution in invasive plant species but little support for Evolution of Increased Competitive Ability (EICA). *Ecology and Evolution*, *3*(3), 739-751.
- Feng, Y., Fouqueray, T. D., & van Kleunen, M. (2019). Linking Darwin's naturalisation hypothesis and Elton's diversity–invasibility hypothesis in experimental grassland communities. *Journal of Ecology*, *107*(2), 794-805.
- Fenollosa, E., Munné-Bosch, S., & Pintó-Marijuan, M. (2017). Contrasting phenotypic plasticity in the photoprotective strategies of the invasive species *Carpobrotus edulis* and the coexisting native species *Crithmum maritimum*. *Physiologia plantarum*, *160*(2), 185-200.
- Fernández, M. B., Tossi, V., Lamattina, L., & Cassia, R. (2016). A comprehensive phylogeny reveals functional conservation of the UV-B photoreceptor UVR8 from green algae to higher plants. *Frontiers in Plant Science*, *7*, 1698.

- Fridley, J. D. (2013). Plant invasions across the Northern Hemisphere: a deep-time perspective. *Annals of the New York Academy of Sciences*, 1293(1), 8-17.
- Gaudeul, M., Giraud, T., Kiss, L., & Shykoff, J. A. (2011). Nuclear and chloroplast microsatellites show multiple introductions in the worldwide invasion history of common ragweed, *Ambrosia artemisiifolia*. *PLoS one*, 6(3), e17658.
- Ghalambor, C. K., McKay, J. K., Carroll, S. P., & Reznick, D. N. (2007). Adaptive versus non-adaptive phenotypic plasticity and the potential for contemporary adaptation in new environments. *Functional Ecology*, 21(3), 394-407.
- Godar, D. E. (2005). UV doses worldwide. *Photochemistry and Photobiology*, 81(4), 736-749.
- Gonzalez, R., Wellburn, A. R., & Paul, N. D. (1998). Dose responses of two pea lines to ultraviolet-B radiation (280–315 nm). *Physiologia plantarum*, 104(3), 373-378.
- Gutiérrez-Cánovas, C., Sánchez-Fernández, D., González-Moreno, P., Mateos-Naranjo, E., Castro-Díez, P., & Vilà, M. (2020). Combined effects of land-use intensification and plant invasion on native communities. *Oecologia*, 1-14.
- Hampe, A., & Petit, R. J. (2005). Conserving biodiversity under climate change: the rear edge matters. *Ecology Letters*, 8(5), 461-467.
- Heger, T., Pahl, A. T., Botta-Dukát, Z., Gherardi, F., Hoppe, C., Hoste, I., Jax, K., Lindström, L., Boets, P., Haider, S., Kollmann, J., Wittmann, M. J., & Jeschke, J. M. (2013a). Conceptual frameworks and methods for advancing invasion ecology. *Ambio*, 42(5), 527-540.
- Heger, T., Saul, W. C., & Trepl, L. (2013b). What biological invasions 'are' is a matter of perspective. *Journal for Nature Conservation*, 21(2), 93-96.
- Heger, T., & Trepl, L. (2003). Predicting biological invasions. *Biological Invasions*, 5(4), 313-321.
- Hejda, M., Pyšek, P., & Jarošík, V. (2009). Impact of invasive plants on the species richness, diversity and composition of invaded communities. *Journal of Ecology*, 97(3), 393-403.
- Helliwell, E. E., Faber-Hammond, J., Lopez, Z. C., Garoutte, A., von Wettberg, E., Friesen, M. L., & Porter, S. S. (2018). Rapid establishment of a flowering cline in *Medicago polymorpha* after invasion of North America. *Molecular Ecology*, 27(23), 4758-4774.
- Hierro, J. L., Khetsuriani, L., Andonian, K., Eren, Ö., Villarreal, D., Janoian, G., Reinhart, K. O., & Callaway, R. M. (2017). The importance of factors controlling species abundance and distribution varies in native and non-native ranges. *Ecography*, 40(8), 991-1002.
- Higgins, S. I., & Richardson, D. M. (2014). Invasive plants have broader physiological niches. *Proceedings of the National Academy of Sciences*, 111(29), 10610-10614.
- Hijmans, R. J., & Graham, C. H. (2006). The ability of climate envelope models to predict the effect of climate change on species distributions. *Global Change Biology*, 12(12), 2272-2281.

Bibliography

- Hobbs, R. J., Arico, S., Aronson, J., Baron, J. S., Bridgewater, P., Cramer, V. A., Epstein, P. R., Ewel, J. J., Klink, C. A., Lugo, A. E., Norton, D., Ojima, D., Richardson, D. M., Sanderson, E. W., Valladares, F., Vilà, M., Zamora, R., & Zobel, M. (2006). Novel ecosystems: theoretical and management aspects of the new ecological world order. *Global Ecology and Biogeography*, *15*(1), 1-7.
- Hock, M., Beckmann, M., Hofmann, R., Bruelheide, H., & Erfmeier, A. (2015). Effects of UV-B radiation on germination characteristics in invasive plants in New Zealand. *NeoBiota*, *26*, 21–37.
- Hock, M., Beckmann, M., Hofmann, R., Bruelheide, H., & Erfmeier, A. (2020). UV-B adaptability of the invasive weed *Echium vulgare*. *New Zealand Journal of Ecology* (under review).
- Hofmann, R. W., Campbell, B. D., Fountain, D. W., Jordan, B. R., Greer, D. H., Hunt, D. Y., & Hunt, C. L. (2001). Multivariate analysis of intraspecific responses to UV-B radiation in white clover (*Trifolium repens* L.). *Plant, Cell & Environment*, *24*(9), 917-927.
- Hou, Y. P., Peng, S. L., Lin, Z. G., Huang, Q. Q., Ni, G. Y., & Zhao, N. (2015). Fast-growing and poorly shade-tolerant invasive species may exhibit higher physiological but not morphological plasticity compared with non-invasive species. *Biological Invasions*, *17*(5), 1555-1567.
- Howell, C. J., & Sawyer, J. W. D. (2006). *New Zealand naturalised vascular plant checklist* (pp. 1-60). Wellington: New Zealand Plant Conservation Network.
- Huang, Q. Q., Pan, X. Y., Fan, Z. W., & Peng, S. L. (2015). Stress relief may promote the evolution of greater phenotypic plasticity in exotic invasive species: a hypothesis. *Ecology and Evolution*, *5*(6), 1169-1177.
- Hulme, P. E. (2003). Biological invasions: winning the science battles but losing the conservation war? *Oryx*, *37*(2), 178-193.
- Hulme, P. E., Bacher, S., Kenis, M., Klotz, S., Kühn, I., Minchin, D., Nentwig, W., Olenin, S., Panov, V., Pergl, J., Pyšek, P., Roques, A., Sol, D., Solarz, W., & Vilà, M. (2008). Grasping at the routes of biological invasions: a framework for integrating pathways into policy. *Journal of Applied Ecology*, *45*(2), 403-414.
- Jagodziński, A. M., Dyderski, M. K., Horodecki, P., Knight, K. S., Rawlik, K., & Szmyt, J. (2019). Light and propagule pressure affect invasion intensity of *Prunus serotina* in a 14-tree species forest common garden experiment. *NeoBiota*, *46*, 1-21.
- Jansen, M. A., Gaba, V., & Greenberg, B. M. (1998). Higher plants and UV-B radiation: balancing damage, repair and acclimation. *Trends in Plant Science*, *3*(4), 131-135.

- Kalusová, V., Chytrý, M., Van Kleunen, M., Mucina, L., Dawson, W., Essl, F., Kreft, H., Pergl, J., Weigelt, P., Winter, M., & Pyšek, P. (2017). Naturalization of European plants on other continents: The role of donor habitats. *Proceedings of the National Academy of Sciences*, *114*(52), 13756-13761.
- Kataria, S., Jajoo, A., & Guruprasad, K. N. (2014). Impact of increasing Ultraviolet-B (UV-B) radiation on photosynthetic processes. *Journal of Photochemistry and Photobiology B: Biology*, *137*, 55-66.
- Kattge, J., Bönisch, G., Díaz, S., Lavorel, S., Prentice, I. C., Leadley, P., ... & Wirth, C. (2020). TRY plant trait database—enhanced coverage and open access. *Global Change Biology*.
- Kattge, J., Diaz, S., Lavorel, S., Prentice, I. C., Leadley, P., Bönisch, G., ... & Wirth, C. (2011). TRY—a global database of plant traits. *Global Change Biology*, *17*(9), 2905-2935.
- Kawecki, T. J., & Ebert, D. (2004). Conceptual issues in local adaptation. *Ecology Letters*, *7*(12), 1225-1241.
- Keane, R. M., & Crawley, M. J. (2002). Exotic plant invasions and the enemy release hypothesis. *Trends in Ecology & Evolution*, *17*(4), 164-170.
- Kempel, A., Chrobock, T., Fischer, M., Rohr, R. P., & van Kleunen, M. (2013). Determinants of plant establishment success in a multispecies introduction experiment with native and alien species. *Proceedings of the National Academy of Sciences*, *110*(31), 12727-12732.
- King, C. M. (1990). *The handbook of New Zealand mammals*. Oxford University Press.
- Klonner, G., Wessely, J., Gattringer, A., Moser, D., Dullinger, I., Hülber, K., Rumpf, S. B., Block, S., Bossdorf, O., Carboni, M., Conti, L., Dawson, W., Haeuser, E., Hermy, M., Münkemüller, T., Parepa, M., Thuiller, W., van der Veken, S., Verheyen, K., van Kleunen, M., Essl, F., & Dullinger, S. (2019). Effects of climate change and horticultural use on the spread of naturalized alien garden plants in Europe. *Ecography*, *42*(9), 1548-1557.
- Krizek, D. T. (1975). Influence of ultraviolet radiation on germination and early seedling growth. *Physiologia plantarum*, *34*(3), 182-186.
- Kuhlmann, F., & Müller, C. (2010). Impacts of ultraviolet radiation on interactions between plants and herbivorous insects: a chemo-ecological perspective. In *Progress in Botany* 72 (pp. 305-347). Springer, Berlin, Heidelberg.
- Kuhman, T. R., Pearson, S. M., & Turner, M. G. (2010). Effects of land-use history and the contemporary landscape on non-native plant invasion at local and regional scales in the forest-dominated southern Appalachians. *Landscape Ecology*, *25*(9), 1433-1445.
- Lamarque, L. J., Lortie, C. J., Porté, A. J., & Delzon, S. (2015). Genetic differentiation and phenotypic plasticity in life-history traits between native and introduced populations of invasive maple trees. *Biological Invasions*, *17*(4), 1109-1122.

Bibliography

- Lande, R. (2015). Evolution of phenotypic plasticity in colonizing species. *Molecular Ecology*, *24*(9), 2038-2045.
- Lavola, A., Nybakken, L., Rousi, M., Pusenius, J., Petrelius, M., Kellomäki, S., & Julkunen-Tiitto, R. (2013). Combination treatment of elevated UVB radiation, CO₂ and temperature has little effect on silver birch (*Betula pendula*) growth and phytochemistry. *Physiologia plantarum*, *149*(4), 499-514.
- Liu, Y., Oduor, A. M., Zhang, Z., Manea, A., Tooth, I. M., Leishman, M. R., Xu, X., & van Kleunen, M. (2017). Do invasive alien plants benefit more from global environmental change than native plants? *Global Change Biology*, *23*(8), 3363-3370.
- Llorens, L., Badenes-Pérez, F. R., Julkunen-Tiitto, R., Zidorn, C., Fereres, A., & Jansen, M. A. (2015). The role of UV-B radiation in plant sexual reproduction. *Perspectives in Plant Ecology, Evolution and Systematics*, *17*(3), 243-254.
- Mack, R. N., Simberloff, D., Mark Lonsdale, W., Evans, H., Clout, M., & Bazzaz, F. A. (2000). Biotic invasions: causes, epidemiology, global consequences, and control. *Ecological Applications*, *10*(3), 689-710.
- Manetas, Y. (2003). The importance of being hairy: the adverse effects of hair removal on stem photosynthesis of *Verbascum speciosum* are due to solar UV-B radiation. *New Phytologist*, 503-508.
- Martel, A. B., & Qaderi, M. M. (2016). Does salicylic acid mitigate the adverse effects of temperature and ultraviolet-B radiation on pea (*Pisum sativum*) plants? *Environmental and Experimental Botany*, *122*, 39-48.
- Matesanz, S., Gianoli, E., & Valladares, F. (2010). Global change and the evolution of phenotypic plasticity in plants. *Annals of the New York Academy of Sciences*, *1206*(1), 35-55.
- McKenzie, R. L., Aucamp, P. J., Bais, A. F., Björn, L. O., & Ilyas, M. (2007). Changes in biologically-active ultraviolet radiation reaching the Earth's surface. *Photochemical & Photobiological Sciences*, *6*(3), 218-231.
- Merilä, J. (2012). Evolution in response to climate change: in pursuit of the missing evidence. *BioEssays*, *34*(9), 811-818.
- Molina-Montenegro, M. A., Galleguillos, C., Oses, R., Acuña-Rodríguez, I. S., Lavín, P., Gallardo-Cerda, J., Torres-Díaz, C., Diez, B., Pizarro, G. E., & Atala, C. (2016). Adaptive phenotypic plasticity and competitive ability deployed under a climate change scenario may promote the invasion of *Poa annua* in Antarctica. *Biological Invasions*, *18*(3), 603-618.
- Moloney, K. A., Holzappel, C., Tielbörger, K., Jeltsch, F., & Schurr, F. M. (2009). Rethinking the common garden in invasion research. *Perspectives in Plant Ecology, Evolution and Systematics*, *11*(4), 311-320.

- Moran, E. V., & Alexander, J. M. (2014). Evolutionary responses to global change: lessons from invasive species. *Ecology Letters*, *17*(5), 637-649.
- Mungi, N. A., Coops, N. C., Ramesh, K., & Rawat, G. S. (2018). How global climate change and regional disturbance can expand the invasion risk? Case study of *Lantana camara* invasion in the Himalaya. *Biological Invasions*, *20*(7), 1849-1863.
- Musil, C. F. (1995). Differential effects of elevated ultraviolet-B radiation on the photochemical and reproductive performances of dicotyledonous and monocotyledonous arid-environment ephemerals. *Plant, Cell & Environment*, *18*(8), 844-854.
- Nicotra, A. B., Atkin, O. K., Bonser, S. P., Davidson, A. M., Finnegan, E. J., Mathesius, U., Poot, P., Purugganan, M. D., Richards, C. L., Valladares, F., & van Kleunen, M. (2010). Plant phenotypic plasticity in a changing climate. *Trends in Plant Science*, *15*(12), 684-692.
- Oduor, A. M., Leimu, R., & van Kleunen, M. (2016). Invasive plant species are locally adapted just as frequently and at least as strongly as native plant species. *Journal of Ecology*, *104*(4), 957-968.
- Ogden, J., Basher, L., & McGlone, M. (1998). Botanical briefing fire, forest regeneration and links with early human habitation: evidence from New Zealand. *Annals of Botany*, *81*(6), 687-696.
- Oplaat, C., & Verhoeven, K. J. (2015). Range expansion in asexual dandelions: selection for general-purpose genotypes? *Journal of Ecology*, *103*(1), 261-268.
- Pancotto, V. A., Sala, O. E., Cabello, M., López, N. I., Robson, T. M., Ballaré, C. L., Caldwell, M. M., & Scopel, A. L. (2003). Solar UV-B decreases decomposition in herbaceous plant litter in Tierra del Fuego, Argentina: potential role of an altered decomposer community. *Global Change Biology*, *9*(10), 1465-1474.
- Pancotto, V. A., Sala, O. E., Robson, T. M., Caldwell, M. M., & Scopel, A. L. (2005). Direct and indirect effects of solar ultraviolet-B radiation on long-term decomposition. *Global Change Biology*, *11*(11), 1982-1989.
- Parker, I. M., Rodriguez, J., & Loik, M. E. (2003). An evolutionary approach to understanding the biology of invasions: local adaptation and general-purpose genotypes in the weed *Verbascum thapsus*. *Conservation Biology*, *17*(1), 59-72.
- Perglova, I., Pergl, J., Skalova, H., Moravcova, L., Jarošík, V., & Pyšek, P. (2009). Differences in germination and seedling establishment of alien and native *Impatiens* species. *Preslia*, *81*(4), 357-375.
- Petitpierre, B., Kueffer, C., Broennimann, O., Randin, C., Daehler, C., & Guisan, A. (2012). Climatic niche shifts are rare among terrestrial plant invaders. *Science*, *335*(6074), 1344-1348.

Bibliography

- Petitpierre, B., McDougall, K., Seipel, T., Broennimann, O., Guisan, A., & Kueffer, C. (2016). Will climate change increase the risk of plant invasions into mountains? *Ecological Applications*, 26(2), 530-544.
- Prentis, P. J., Wilson, J. R., Dormontt, E. E., Richardson, D. M., & Lowe, A. J. (2008). Adaptive evolution in invasive species. *Trends in Plant Science*, 13(6), 288-294.
- Pyšek, P., Manceur, A. M., Alba, C., McGregor, K. F., Pergl, J., Štajerová, K., Chytrý, M., Danihelka, J., Kartesz, J., Klimešová, J., Lučanová, M., Moravcová, L., Nishino, M., Sádlo, J., Suda, J., Tichý, L., & Kühn, I. (2015). Naturalization of central European plants in North America: species traits, habitats, propagule pressure, residence time. *Ecology*, 96(3), 762-774.
- Qaderi, M. M., Yeung, E. C., & Reid, D. M. (2008). Growth and physiological responses of an invasive alien species, *Silene noctiflora*, during two developmental stages to four levels of ultraviolet-B radiation. *Ecoscience*, 15(2), 150-159.
- Rejmánek, M., & Richardson, D. M. (1996). What attributes make some plant species more invasive? *Ecology*, 77(6), 1655-1661.
- Ricciardi, A., Hoopes, M. F., Marchetti, M. P., & Lockwood, J. L. (2013). Progress toward understanding the ecological impacts of nonnative species. *Ecological Monographs*, 83(3), 263-282.
- Richardson, D. M., & Pyšek, P. (2006). Plant invasions: merging the concepts of species invasiveness and community invasibility. *Progress in Physical Geography*, 30(3), 409-431.
- Richardson, D. M., Pyšek, P., Rejmánek, M., Barbour, M. G., Panetta, F. D., & West, C. J. (2000). Naturalization and invasion of alien plants: concepts and definitions. *Diversity and Distributions*, 6(2), 93-107.
- Rinnan, R., Keinänen, M. M., Kasurinen, A., Asikainen, J., Kekki, T. K., Holopainen, T., Ro-Poulsen, H., Mikkelsen, T. N., & Michelsen, A. (2005). Ambient ultraviolet radiation in the Arctic reduces root biomass and alters microbial community composition but has no effects on microbial biomass. *Global Change Biology*, 11(4), 564-574.
- Robson, T. M., Klem, K., Urban, O., & Jansen, M. A. (2015). Re-interpreting plant morphological responses to UV-B radiation. *Plant, Cell & Environment*, 38(5), 856-866.
- Rose, A. B., Platt, K. H., & Frampton, C. M. (1995). Vegetation change over 25 years in a New Zealand short-tussock grassland: effects of sheep grazing and exotic invasions. *New Zealand Journal of Ecology*, 163-174.
- Rozema, J., van de Staaij, J., Björn, L. O., & Caldwell, M. (1997). UV-B as an environmental factor in plant life: stress and regulation. *Trends in Ecology & Evolution*, 12(1), 22-28.

- Ruprecht, E., Fenesi, A., & Nijs, I. (2014). Are plasticity in functional traits and constancy in performance traits linked with invasiveness? An experimental test comparing invasive and naturalized plant species. *Biological Invasions*, *16*(7), 1359-1372.
- Schierenbeck, K. A., & Ellstrand, N. C. (2009). Hybridization and the evolution of invasiveness in plants and other organisms. *Biological Invasions*, *11*(5), 1093.
- Schlaepfer, D. R., Glättli, M., Fischer, M., & van Kleunen, M. (2010). A multi-species experiment in their native range indicates pre-adaptation of invasive alien plant species. *New Phytologist*, *185*(4), 1087-1099.
- Seipel, T., Alexander, J. M., Daehler, C. C., Rew, L. J., Edwards, P. J., Dar, P. A., McDougall, K., Naylor, B., Parks, C., Pollnac, F. W., Reshi, Z. A., Schroder, M., & Kueffer, C. (2015). Performance of the herb *Verbascum thapsus* along environmental gradients in its native and non-native ranges. *Journal of Biogeography*, *42*(1), 132-143.
- Sharma, G. P., & Raghubanshi, A. S. (2011). *Lantana camara* L. invasion and impact on herb layer diversity and soil properties in a dry deciduous forest of India. *Applied Ecology and Environmental Research*, *9*(3), 253-264.
- Shine, R., Brown, G. P., & Phillips, B. L. (2011). An evolutionary process that assembles phenotypes through space rather than through time. *Proceedings of the National Academy of Sciences*, *108*(14), 5708-5711.
- Si, C. C., Dai, Z. C., Lin, Y., Qi, S. S., Huang, P., Miao, S. L., & Du, D. L. (2014). Local adaptation and phenotypic plasticity both occurred in *Wedelia trilobata* invasion across a tropical island. *Biological Invasions*, *16*(11), 2323-2337.
- Skaltsa, H., Verykokidou, E., Harvala, C., Karabourniotis, G., & Manetasi, Y. (1994). UV-B protective potential and flavonoid content of leaf hairs of *Quercus ilex*. *Phytochemistry*, *37*(4), 987-990.
- Smith, N. S., & Côté, I. M. (2019). Multiple drivers of contrasting diversity–invasibility relationships at fine spatial grains. *Ecology*, *100*(2), e02573.
- Song, X. Z., Zhang, H. L., Chang, S. X., Jiang, H., Peng, C. H., & Shuquan, Q. Y. (2012). Elevated UV-B radiation increased the decomposition of *Cinnamomum camphora* and *Cyclobalanopsis glauca* leaf litter in subtropical China. *Journal of Soils and Sediments*, *12*(3), 307-311.
- Suchar, V. A., & Robberecht, R. (2015). Integration and scaling of UV-B radiation effects on plants: from DNA to leaf. *Ecology and Evolution*, *5*(13), 2544-2555.
- Suchar, V. A., & Robberecht, R. (2016). Integration and scaling of UV-B radiation effects on plants: from molecular interactions to whole plant responses. *Ecology and Evolution*, *6*(14), 4866-4884.

Bibliography

- Suchar, V. A., & Robberecht, R. (2018). Integration and scaling of UV-B radiation effects on plants: the relative sensitivity of growth forms and interspecies interactions. *Journal of Plant Ecology*, *11*(4), 656-670.
- Taylor, K. T., Maxwell, B. D., Pauchard, A., Nuñez, M. A., Peltzer, D. A., Terwei, A., & Rew, L. J. (2016). Drivers of plant invasion vary globally: evidence from pine invasions within six ecoregions. *Global Ecology and Biogeography*, *25*(1), 96-106.
- Teklemariam, T. A., & Blake, T. J. (2004). Phenylalanine ammonia-lyase-induced freezing tolerance in jack pine (*Pinus banksiana*) seedlings treated with low, ambient levels of ultraviolet-B radiation. *Physiologia plantarum*, *122*(2), 244-253.
- Tevini, M., & Teramura, A. H. (1989). UV-B effects on terrestrial plants. *Photochemistry and Photobiology*, *50*(4), 479-487.
- Theoharides, K.A., & Dukes, J.S. (2007). Plant invasion across space and time: Factors affecting nonindigenous species success during four stages of invasion. *New Phytologist*, *176*, 256–273.
- Tosserams, M., de Sà, A. P., & Rozema, J. (1996). The effect of solar UV radiation on four plant species occurring in a coastal grassland vegetation in The Netherlands. *Physiologia Plantarum*, *97*(4), 731-739.
- Tosserams M., Bolink E., Rozema J. (1997) The effect of enhanced ultraviolet-B radiation on germination and seedling development of plant species occurring in a dune grassland ecosystem. In: Rozema J., Gieskes W.W.C., Van De Geijn S.C., Nolan C., De Boois H. (eds) UV-B and Biosphere. Advances in Vegetation Science, vol 17. Springer, Dordrecht
- Turner, K. G., Fréville, H., & Rieseberg, L. H. (2015). Adaptive plasticity and niche expansion in an invasive thistle. *Ecology and Evolution*, *5*(15), 3183-3197.
- Ulm, R., & Jenkins, G. I. (2015). Q&A: How do plants sense and respond to UV-B radiation? *BMC Biology*, *13*(1), 45.
- Valéry, L., Fritz, H., Lefeuvre, J. C., & Simberloff, D. (2008). In search of a real definition of the biological invasion phenomenon itself. *Biological Invasions*, *10*(8), 1345-1351.
- Van de Staaij, J., Rozema, J., Van Beem, A., & Aerts, R. (2001). Increased solar UV-B radiation may reduce infection by arbuscular mycorrhizal fungi (AMF) in dune grassland plants: evidence from five years of field exposure. *Plant Ecology*, *154*(1-2), 169-177.

- van Kleunen, M., Dawson, W., Essl, F., Pergl, J., Winter, M., Weber, E., Kreft, H., Weigelt, P., Kartesz, J., Nishino, M., Antonova, L. A., Barcelona, J. F. Cabezas, F. J., Cárdenas, D., Cárdenas-Toro, J., Castaño, N., Chacón, E., Chatelain, C., Ebel, A. L., Figueiredo, E., Fuentes, N., Groom, Q. J., Henderson, L., Inderjit, Kupriyanov, A., Masciadri, S., Meerman, J., Morozova, O., Moser, D., Nickrent, D. L., Patzelt, A., Pelsler, P. B., Baptiste, M. P., Poopath, M., Schulze, M., Seebens, H., Shu, W., Thomas, J., Velayos, M., Wieringa, J. J., & Pyšek, P. (2015). Global exchange and accumulation of non-native plants. *Nature*, *525*(7567), 100-103.
- van Kleunen, M., Essl, F., Pergl, J., Brundu, G., Carboni, M., Dullinger, S., Early, R., González-Moreno, P., Groom, Q. J., Hulme, P. E., Kueffer, C., Kühn, I., Máguas, C., Maurel, N., Novoa, A., Parepa, M., Pyšek, P., Seebens, H., Tanner, R., Touza, J., Verbrugge, L., Weber, E., Dawson, W., Kreft, H., Weigelt, P., Winter, M., Klöner, G., Talluto, M. V., & Dehnen-Schmutz K. (2018). The changing role of ornamental horticulture in alien plant invasions. *Biological Reviews*, *93*(3), 1421-1437.
- van Kleunen, M., & Johnson, S. D. (2007). South African Iridaceae with rapid and profuse seedling emergence are more likely to become naturalized in other regions. *Journal of Ecology*, *95*(4), 674-681.
- van Kleunen, M., Pyšek, P., Dawson, W., Essl, F., Kreft, H., Pergl, J., Weigelt, P., Stein, A., Dullinger, S., König, C., Lenzner, B., Maurel, N., Moser, D., Seebens, H., Kartesz, J., Nishino, M., Aleksanyan, A., Ansong, M., Antonova, L. A., Barcelona, J. F., Breckle, S. W., Brundu, G., Cabezas, F. J., Cárdenas, D., Cárdenas-Toro, J., Castaño, N., Chacón, E., Chatelain, C., Conn, B., de Sá Dechoum, M., Dufour-Dror, J.-M., Ebel, A. L., Figueiredo, E., Fragman-Sapir, O., Fuentes, N., Groom, Q. J., Henderson, L., Inderjit, Jogan, N., Krestov, P., Kupriyanov, A., Masciadri, S., Meerman, J., Morozova, O., Nickrent, D., Nowak, A., Patzelt, A., Pelsler, P. B., Shu, W., Thomas, J., Uludag, A., Velayos, M., Verkhosina, A., Villaseñor, J. L., Weber, E., Wieringa, J. J., Yazlık, A., Zeddám, A., Zykova, E., & Winter, M. (2019). The Global Naturalized Alien Flora (GloNAF) database. *Ecology*, *100*(1), e02542.
- van Kleunen, M., Schlaepfer, D. R., Glaetli, M., & Fischer, M. (2011). Preadapted for invasiveness: do species traits or their plastic response to shading differ between invasive and non-invasive plant species in their native range? *Journal of Biogeography*, *38*(7), 1294-1304.
- Walther, G.-R., Roques, A., Hulme, P. E., Sykes, M. T., Pyšek, P., Kühn, I., Zobel, M., Bacher, S., Botta-Dukát, Z., Bugmann, H., Czúcz, B., Dauber, J., Hickler, T., Jarošík, V., Kenis, M., Klotz, S., Minchin, D., Moora, M., Nentwig, W., Ott, J., Panov, V. E., Reineking, B., Robinet, C., Semchenko, V., Solarz, W., Thuiller, W., Vilà, M., Vohland, K., & Settele, J. (2009). Alien species in a warmer world: risks and opportunities. *Trends in Ecology & Evolution*, *24*(12), 686-693.
- Wang, H., Ma, X., Zhang, L., Siemann, E., & Zou, J. (2016). UV-B has larger negative impacts on invasive populations of *Triadica sebifera* but ozone impacts do not vary. *Journal of Plant Ecology*, *9*(1), 61-68.

Bibliography

- Wargent, J. J., Nelson, B. C. W., McGhie, T. K., & Barnes, P. W. (2015). Acclimation to UV-B radiation and visible light in *Lactuca sativa* involves up-regulation of photosynthetic performance and orchestration of metabolome-wide responses. *Plant, Cell & Environment*, *38*(5), 929-940.
- Watanabe, S., Sudo, K., Nagashima, T., Takemura, T., Kawase, H., & Nozawa, T. (2011). Future projections of surface UV-B in a changing climate. *Journal of Geophysical Research: Atmospheres*, *116*(D16).
- Watanabe, S., Takemura, T., Sudo, K., Yokohata, T., & Kawase, H. (2012). Anthropogenic changes in the surface all-sky UV-B radiation through 1850-2005 simulated by an Earth system model. *Atmospheric Chemistry & Physics Discussions*, *12*(2).
- Watermann, L. Y., Hock, M., Blake, C., & Erfmeier, A. (2020). Plant invasion into high elevations implies adaptation to high UV-B environments: a multi-species experiment. *Biological Invasions*, *22*(3), 1203-1218.
- Williamson, M., & Fitter, A. (1996). The varying success of invaders. *Ecology*, *77*(6), 1661-1666.
- Young, A. R. (2006). Acute effects of UVR on human eyes and skin. *Progress in Biophysics and molecular Biology*, *92*(1), 80-85.
- Zenni, R. D., Lamy, J. B., Lamarque, L. J., & Porté, A. J. (2014). Adaptive evolution and phenotypic plasticity during naturalization and spread of invasive species: implications for tree invasion biology. *Biological Invasions*, *16*(3), 635-644.

Supporting Information

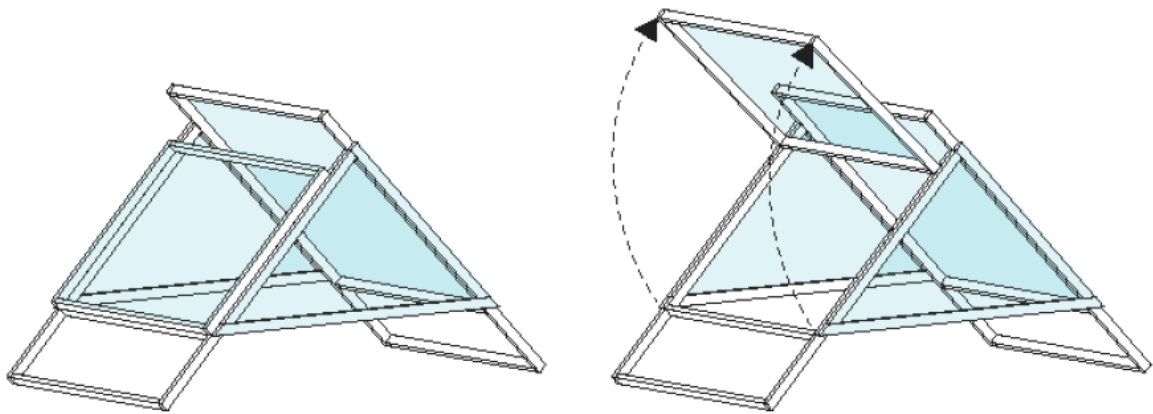

Figure II.S1.1: Technical drawing of experimental units equipped with plastic filter sheets

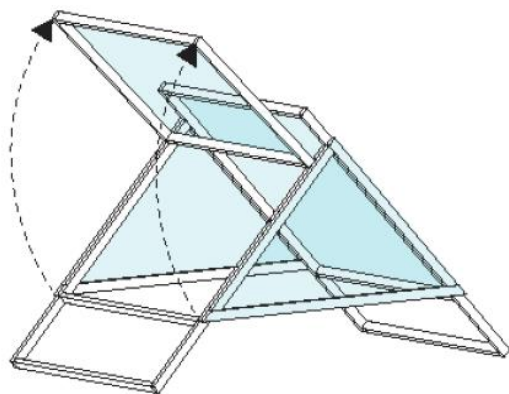

Figure III.S2: Technical drawing of UV cabinets equipped with plastic filter sheets (blue) and photo of the experimental setting in the New Zealand common garden

Table II.S2.1: Climatic conditions during the respective run times of both common garden experiments in Germany and New Zealand. Distance provides the geographic distance of measuring station to the location of the common garden.

	Germany			
	climate data	data source	measuring station	distance [km]
minimum temperature [°C]	4.1 - 4.7	DWD	Kiel-Holtenau	3.8
maximum temperature [°C]	30.4	DWD	Kiel-Holtenau	3.8
total sun hours [h]	470 - 495	DWD	Kiel-Holtenau	3.8
sun hours per day [h]	6.4	DWD	Kiel-Holtenau	3.8
total global radiation [kJ/m ²]	972 620 - 1 012 780	DWD	Schleswig	41.9
global radiation per day [kJ/m ² d]	13 152 - 13 324	DWD	Schleswig	41.9
total UV-B radiation [kJ/m ²]	944 - 974	BfS	Westerland, Sylt	130.2
UV-B radiation per day [kJ/m ² d]	12.7 - 12.9	BfS	Westerland, Sylt	130.2
	New Zealand			
	climate data	data source	measuring station	distance [km]
minimum temperature [°C]	2.1	NIWA	Lincoln, Broadfield Ews	2.2
maximum temperature [°C]	30.8	NIWA	Lincoln, Broadfield Ews	2.2
total sun hours [h]	537 - 760	NIWA	Christchurch Aero	18.0
sun hours per day [h]	7.1 - 7.4	NIWA	Christchurch Aero	18.0
total global radiation [kJ/m ²]	1 694 700 - 2 284 880	NIWA	Lincoln, Broadfield Ews	2.2
global radiation per day [kJ/m ² d]	21 354 - 23 215	NIWA	Lincoln, Broadfield Ews	2.2
total UV-B radiation [kJ/m ²]	2622 - 3454	UV Atlas	Lincoln, Broadfield Ews	2.2
UV-B radiation per day [kJ/m ² d]	32.3 - 35.8	UV Atlas	Lincoln, Broadfield Ews	2.2

Table II.S3.2: List of obtained GBIF download and dataset DOIs

GBIF download DOI for <i>Prunella vulgaris</i> :	https://doi.org/10.15468/dl.z6sd91
GBIF download DOI for <i>Trifolium pratense</i> :	https://doi.org/10.15468/dl.ti2lfg
GBIF download DOI for <i>Trifolium repens</i> :	https://doi.org/10.15468/dl.rhj4wa
GBIF dataset DOIs for all other species:	
https://doi.org/10.15468/smdvdo	https://doi.org/10.15468/jvupsl
https://doi.org/10.15468/slqqt8	https://doi.org/10.15468/dlblr
https://doi.org/10.15468/i46are	https://doi.org/10.15468/kllkyl
https://doi.org/10.15468/5v5pvk	https://doi.org/10.15468/zjbzel
https://doi.org/10.15468/hcgqsi	https://doi.org/10.15468/jxbhqx
https://doi.org/10.15468/vnkxjn	https://doi.org/10.15468/2g6i0v
https://doi.org/10.15468/2dohar	https://doi.org/10.15468/wtlymk
https://doi.org/10.15468/esxc9a	https://doi.org/10.3897/phytokeys.12.2849
https://doi.org/10.15468/mopwow	https://doi.org/10.15468/14jd9g
https://doi.org/10.15468/fyuklz	https://doi.org/10.15468/ab3s5x
https://doi.org/10.15468/h1ln5p	https://doi.org/10.15468/g1zohr
https://doi.org/10.15468/mnjkvv	https://doi.org/10.15468/rydcn2
https://doi.org/10.15468/osi63h	https://doi.org/10.15468/af24d8
https://doi.org/10.15468/rvjdu1	https://doi.org/10.15468/c4w4co
https://doi.org/10.15468/ykstli	https://doi.org/10.15468/bkzv1l
https://doi.org/10.15468/omae84	https://doi.org/10.15468/u5wjib
https://doi.org/10.15468/gg0o1b	https://doi.org/10.15468/ucmdjy
https://doi.org/10.15468/gi6aum	https://doi.org/10.15468/s2iu7d
https://doi.org/10.15468/ofn0lf	https://doi.org/10.15468/c7c9qa
https://doi.org/10.15468/9ll2gz	https://doi.org/10.15468/htptzr
https://doi.org/10.15468/rhzrxw	https://doi.org/10.15468/fdzzal
https://doi.org/10.15468/uc1apo	https://doi.org/10.15468/siye1z
https://doi.org/10.15468/kiosdm	https://doi.org/10.15468/mug7kr
https://doi.org/10.15468/tnj8wm	https://doi.org/10.15468/hja69f
https://doi.org/10.15468/dlwwhz	https://doi.org/10.15468/5sl7sh

Table II.S4.3: Results of a linear model analysis testing the effects of species-specific UV-B adaptation and residence time on the invasion success of study species. In all models, as measure of invasion success the logarithmized number of New Zealand *glUV* grid cells occupied by each study species based on available *GBIF* occurrence data served as response variable. ‘UV-B effect size’ depicts the effect of species-specific Hedge’s *g* calculated from the experimental treatment level difference (+UVA|-UVB vs. +UV-A|+UV-B) in plant performance for leaf dry matter content, leaf length, maximum horizontal plant expansion and aboveground biomass. ‘Residence time’ refers to the effect of species-specific years since recorded naturalization obtained from the *New Zealand Plant Conservation Network* (www.nzpcn.org.nz/flora). Degrees of freedom (df), F statistics (F) and significance values (p) are provided for the fixed effect terms.

<i>Leaf dry matter content</i>				<i>Leaf length</i>			
Fixed effect	df	F	p	Fixed effect	df	F	p
UV-B effect size	1	1.289	0.268	UV-B effect size	1	0.183	0.673
Residence time	1	10.845	0.003 **	Residence time	1	8.825	0.007 **

<i>Max. plant expansion</i>				<i>Aboveground biomass</i>			
Fixed effect	df	F	p	Fixed effect	df	F	p
UV-B effect size	1	1.340	0.259	UV-B effect size	1	2.870	0.104
Residence time	1	8.332	0.009 **	Residence time	1	8.410	0.008 **

Table II.S5.4: Random effect results of final mixed model analysis. Degrees of freedom (df), chi-squared statistic (Chi²), and significance values (p) are provided for all nested random effect terms.

<i>Aboveground biomass</i>				<i>Plant height</i>			
Random effect	df	Chi ²	p	Random effect	df	Chi ²	p
Unit : Exp	1	<0.001	1.000	Unit : Exp	1	<0.001	1.000
Unit : UV	1	0.013	0.900	Unit : UV	1	<0.001	1.000
Species : Exp	1	38.300	<0.001 ***	Species : Exp	1	33.800	<0.001 ***
Species : UV	1	<0.001	1.000	Species : UV	1	<0.001	1.000
Family : Species	1	<0.001	1.000	Family : Species	1	<0.001	1.000
<i>Max. plant expansion</i>				<i>Leaf number</i>			
Random effect	df	Chi ²	p	Random effect	df	Chi ²	p
Unit : Exp	1	<0.001	1.000	Unit : Exp	1	0.000	1.000
Unit : UV	1	1.130	0.300	Unit : UV	1	0.417	0.520
Species : Exp	1	51.300	<0.001 ***	Species : Exp	1	4.160	0.040 *
Species : UV	1	0.000	1.000	Species : UV	1	<0.001	1.000
Family : Species	1	<0.001	1.000	Family : Species	1	0.000	1.000
<i>Max. leaf length</i>				<i>Max. leaf width</i>			
Random effect	df	Chi ²	p	Random effect	df	Chi ²	p
Unit : Exp	1	0.295	0.6	Unit : Exp	1	1.061	0.300
Unit : UV	1	0.447	0.500	Unit : UV	1	0.000	1.000
Species : Exp	1	11.800	<0.001 ***	Species : Exp	1	37.695	<0.001 ***
Species : UV	1	<0.001	1.000	Species : UV	1	0.001	1.000
Family : Species	1	<0.001	1.000	Family : Species	1	0.000	1.000
<i>Specific leaf area</i>				<i>Leaf dry matter content</i>			
Random effect	df	Chi ²	p	Random effect	df	Chi ²	p
Unit : Exp	1	<0.001	1.000	Unit : Exp	1	0.171	0.680
Unit : UV	1	0.827	0.400	Unit : UV	1	1.280	0.260
Species : Exp	1	2.490	0.100	Species : Exp	1	6.171	0.010 *
Species : UV	1	0.540	0.500	Species : UV	1	0.000	1.000
Family : Species	1	<0.001	1.000	Family : Species	1	0.000	1.000

Table III.S1: Seed origin information: seeds originate either from ex-situ populations (°) or propagation areas (*)

species	family	German seeds		New Zealand seeds	
		source	year	source	year
<i>Artemisia absinthium</i>	Asteraceae	Botanical Gardens of MLU, Halle°	2013	Timaru Botanical Gardens°	2014
<i>Erysimum cheiri</i>	Brassicaceae	Botanical Gardens of MLU, Halle°	2014	Timaru Botanical Gardens°	2014
<i>Linaria purpurea</i>	Plantaginaceae	Botanical Gardens of MLU, Halle°	2014	Timaru Botanical Gardens°	2014
<i>Lobularia maritima</i>	Brassicaceae	Saatgut-Viefalt, Weilheim *	2013	Timaru Botanical Gardens°	2013
<i>Origanum vulgare</i>	Lamiaceae	Rieger-Hofmann® GmbH *	2013	Timaru Botanical Gardens°	2013
<i>Tragopogon porrifolius</i>	Asteraceae	Botanical Gardens of MLU, Halle°	2014	Southland Seed Savers Network°	2013
<i>Trifolium pratense</i>	Fabaceae	Botanical Gardens of MLU, Halle°	2012	Lincoln University*	2012
<i>Trifolium repens</i>	Fabaceae	Botanical Gardens of MLU, Halle°	2012	Lincoln University*	2012

Table III.S3: Climatic conditions during the respective run times of both common garden experiments in Germany and New Zealand. Distance provides the geographic distance of measuring station to the location of the common garden.

	Germany			
	climate data	data source	measuring station	distance [km]
minimum temperature [°C]	4.1 - 4.7	DWD	Kiel-Holtenau	3.8
maximum temperature [°C]	30.4	DWD	Kiel-Holtenau	3.8
total sun hours [h]	470 - 495	DWD	Kiel-Holtenau	3.8
sun hours per day [h]	6.4	DWD	Kiel-Holtenau	3.8
total global radiation [kJ/m ²]	972 620 - 1 012 780	DWD	Schleswig	41.9
global radiation per day [kJ/m ² d]	13 152 - 13 324	DWD	Schleswig	41.9
total UV-B radiation [kJ/m ²]	944 - 974	BfS	Westerland, Sylt	130.2
UV-B radiation per day [kJ/m ² d]	12.7 - 12.9	BfS	Westerland, Sylt	130.2
	New Zealand			
	climate data	data source	measuring station	distance [km]
minimum temperature [°C]	2.1	NIWA	Lincoln, Broadfield Ews	2.2
maximum temperature [°C]	30.8	NIWA	Lincoln, Broadfield Ews	2.2
total sun hours [h]	537 - 760	NIWA	Christchurch Aero	18.0
sun hours per day [h]	7.1 - 7.4	NIWA	Christchurch Aero	18.0
total global radiation [kJ/m ²]	1 694 700 - 2 284 880	NIWA	Lincoln, Broadfield Ews	2.2
global radiation per day [kJ/m ² d]	21 354 - 23 215	NIWA	Lincoln, Broadfield Ews	2.2
total UV-B radiation [kJ/m ²]	2622 - 3454	UV Atlas	Lincoln, Broadfield Ews	2.2
UV-B radiation per day [kJ/m ² d]	32.3 - 35.8	UV Atlas	Lincoln, Broadfield Ews	2.2

Table III.S4: Information about species-specific raw data variance of all response variables

variables	variance	ArtAbs	EryChe	LinPur	LobMar	OriVul	TraPor	TriPra	TriRep
total biomass [g]	Min.	18.27	0.61	1.38	0.95	0.12	8.68	19.26	26.36
	1st Qu.	25.50	9.33	8.99	4.47	9.95	17.45	43.70	34.85
	Median	29.50	11.56	18.20	8.20	17.40	27.16	50.77	38.56
	Mean	31.47	11.05	19.18	8.92	19.07	24.86	53.63	39.48
	3rd Qu.	38.87	14.42	24.49	10.58	26.63	29.07	57.41	44.40
	Max.	53.01	21.33	59.40	23.29	52.01	51.98	145.71	52.07
	sd	8.53	4.81	13.79	5.58	12.51	9.16	21.07	6.10
root:shoot ratio	Min.	0.22	0.10	0.42	0.02	0.27	1.52	0.14	0.12
	1st Qu.	0.72	0.27	0.70	0.05	0.96	2.77	0.25	0.30
	Median	1.13	0.86	1.02	0.10	1.53	8.30	0.35	0.46
	Mean	461.79	152.96	327.98	26.40	314.85	1684.87	205.84	80.98
	3rd Qu.	961.50	309.75	653.00	47.50	454.25	3269.00	382.25	166.00
	Max.	1969.00	525.00	1748.00	133.00	2691.00	5728.00	1382.00	315.00
	sd	0.40	0.17	0.33	0.03	0.64	1.46	0.40	0.11
plant height [cm]	Min.	8.50	9.00	8.00	10.00	4.50	9.00	9.00	5.00
	1st Qu.	16.38	12.38	21.38	18.50	11.75	20.12	29.00	12.50
	Median	25.50	15.00	47.50	23.50	24.75	29.75	37.25	18.00
	Mean	40.10	15.90	44.69	22.30	22.78	28.40	35.68	17.14
	3rd Qu.	60.38	18.25	65.00	26.00	31.00	36.25	44.00	20.00
	Max.	92.00	32.00	92.00	32.50	46.00	48.00	60.00	31.00
	sd	27.97	5.09	25.47	5.46	11.77	11.42	11.94	5.74
maximum plant expansion [cm]	Min.	19.50	12.50	12.50	17.50	4.00	47.00	39.50	31.00
	1st Qu.	25.75	14.88	23.00	33.25	27.00	53.00	48.88	37.50
	Median	37.50	20.00	27.00	42.00	31.25	60.00	65.00	46.00
	Mean	38.92	20.21	29.44	41.59	35.58	61.08	73.19	45.79
	3rd Qu.	43.25	24.25	34.00	50.50	40.75	66.00	99.00	52.00
	Max.	96.00	30.00	64.00	80.00	77.00	81.00	138.00	70.00
	sd	16.50	5.37	10.90	13.75	15.67	9.13	28.07	9.77
maximum leaf length [cm]	Min.	5.50	5.50	3.00	2.00	2.00	25.50	12.00	10.50
	1st Qu.	11.00	7.00	3.88	2.50	3.50	36.00	14.88	14.00
	Median	13.75	8.25	4.50	3.50	4.00	41.25	19.50	17.00
	Mean	15.90	8.56	4.64	3.66	4.11	40.94	19.61	17.31
	3rd Qu.	21.25	10.00	5.13	4.50	4.50	47.12	22.00	18.62
	Max.	36.00	15.50	7.00	6.00	6.00	57.00	35.50	38.00
	sd	7.02	2.17	1.17	1.15	0.90	7.53	5.21	4.75
specific leaf area [m ² /kg]	Min.	5.90	4.68	11.11	14.93	8.35	10.12	14.68	15.78
	1st Qu.	8.70	7.18	14.02	15.65	15.01	12.44	15.93	17.86
	Median	11.95	8.80	15.55	17.22	18.44	13.76	17.37	19.62
	Mean	12.21	9.17	15.34	17.47	18.31	13.48	17.62	19.91
	3rd Qu.	14.38	10.43	17.08	18.48	20.05	14.57	18.93	22.11
	Max.	22.71	17.37	18.84	21.56	28.95	16.16	22.41	26.10
	sd	4.02	2.65	2.13	2.05	5.19	1.59	1.96	2.73
leaf dry matter content [%]	Min.	19.72	17.95	17.33	16.43	21.55	13.58	17.48	15.47
	1st Qu.	24.65	23.30	19.39	19.84	24.52	17.32	21.68	18.39
	Median	26.72	26.41	20.52	22.16	28.32	18.17	24.14	19.41
	Mean	27.00	26.08	21.04	22.35	29.68	18.24	24.19	19.93
	3rd Qu.	29.73	28.86	22.87	24.12	35.02	19.22	26.88	21.25
	Max.	33.85	36.54	25.27	32.61	42.70	21.45	31.31	34.46
	sd	3.70	4.17	2.26	3.74	5.81	1.49	3.46	3.18
leaf carbon:nitrogen ratio	Min.	13.50	7.00	23.14		5.58	14.15	8.18	7.69
	1st Qu.	21.23	14.90	29.90		25.90	18.89	14.93	12.79
	Median	27.30	18.00	34.42		31.17	21.52	16.17	13.90
	Mean	27.46	21.93	34.26		33.02	21.55	16.06	13.71
	3rd Qu.	31.51	26.42	37.23		43.15	23.86	17.14	14.56
	Max.	45.91	50.06	50.35		65.06	29.90	25.94	18.08
	sd	7.13	10.32	5.84		14.05	3.54	2.91	1.86
phenolic concentration [mg/l]	Min.	43.24	11.35	29.72		113.90	137.00	47.34	8.90
	1st Qu.	136.13	34.53	46.51		220.00	169.40	116.22	36.12
	Median	168.78	39.35	83.57		229.90	194.40	159.98	46.16
	Mean	159.29	40.80	76.96		225.70	192.00	154.83	50.01
	3rd Qu.	182.46	45.33	101.05		240.30	206.10	195.73	61.31
	Max.	230.77	65.55	135.49		270.60	255.90	238.32	90.36
	sd	43.47	10.55	29.89		30.74	25.99	47.96	20.84
no. inflorescences	Min.	0.00	0.00	0.00	9.00	0.00	0.00	0.00	0.00
	1st Qu.	0.00	0.00	0.00	50.50	0.00	0.00	29.25	0.75
	Median	0.00	0.00	3.50	74.00	4.50	0.00	59.50	9.00
	Mean	17.86	0.00	21.11	90.40	34.81	0.00	62.14	25.89
	3rd Qu.	22.25	0.00	48.25	118.50	71.50	0.00	93.25	39.00
	Max.	142.00	0.00	108.00	203.00	149.00	0.00	155.00	125.00
	sd	35.60	0.00	30.21	51.95	44.38	0.00	43.82	34.93

Table III.55: Calculated percentage trait change (decrease/increase) under full solar radiation (+UV-A|+UV-B) in comparison to full UV enclosure (-UV-A|-UV-B) based on estimates of the applied linear mixed model (lmer) for all individuals (UV) and individuals from German (UV_{DEU}) or New Zealand (UV_{NZL}) origins, respectively. Percentage change in response variables was only calculated in case of significant ($p < 0.1$) overall UV treatment effects (UV) or origin \times UV treatment interaction effects (UV_{DEU}/UV_{NZL}).

variables	z-score estimate			UV-induced trait value change [%]														
	UV	UV _{DEU}	UV _{NZL}	<i>A. absinthium</i>			<i>E. cheiri</i>			<i>L. purpurea</i>			<i>L. maritima</i>					
	UV	UV _{DEU}	UV _{NZL}	UV	UV _{DEU}	UV _{NZL}	UV	UV _{DEU}	UV _{NZL}	UV	UV _{DEU}	UV _{NZL}	UV	UV _{DEU}	UV _{NZL}	UV	UV _{DEU}	UV _{NZL}
total biomass [g]	-0.197			-5.3			-8.6			-14.2			-12.3					
maximum plant expansion [cm]	-0.312	-0.039	-0.621	-13.2	-1.3	-28.8	-8.3	-1.2	-13.9	-11.5	-1.1	-21.8	-10.3	-1.0	-23.7			
maximum leaf length [cm]	-0.332			-14.6			-8.4			-8.4			-10.4					
specific leaf area [m ² /kg]		-0.120	0.105		-3.8	3.0		-2.1	2.5		-1.8	1.0		-1.3	1.3			
phenolic concentration [mg/l]	0.495			13.5			12.8			19.2			NA					
variables	UV	UV _{DEU}	UV _{NZL}	<i>O. vulgare</i>			<i>T. porrifolius</i>			<i>T. pratense</i>			<i>T. repens</i>					
	UV	UV _{DEU}	UV _{NZL}	UV	UV _{DEU}	UV _{NZL}	UV	UV _{DEU}	UV _{NZL}	UV	UV _{DEU}	UV _{NZL}	UV	UV _{DEU}	UV _{NZL}	UV	UV _{DEU}	UV _{NZL}
total biomass [g]	-0.197			-12.9			-7.3			-7.7			-3.0					
maximum plant expansion [cm]	-0.312	-0.039	-0.621	-13.7	-1.3	-20.8	-4.7	-0.5	-9.4	-11.9	-1.3	-24.1	-6.6	-0.7	-14.2			
maximum leaf length [cm]	-0.332			-7.3			-6.1			-8.8			-9.1					
specific leaf area [m ² /kg]		-0.120	0.105		-3.3	2.0		-1.3	1.2		-1.0	1.1		-1.7	1.4			
phenolic concentration [mg/l]	0.495			6.7			6.7			15.3			20.6					

Supporting Information

Table IV.S1: Effect directions of harvest data analysis. Predicted values ('fit'), standard error ('SE') and confidence interval ('lower' and 'upper' limits) are given for all significant main and twofold interaction effects of 'Origin', 'UV-B', and 'Water' in the harvest data analysis. Significance levels of effects are indicated by asterisks (*P < 0.05; **P < 0.01; ***P < 0.001).

	1st harvest (3 weeks)				2nd harvest (6 weeks)				3rd harvest (9 weeks)				4th harvest (12 weeks)			
Total biomass																
Origin	fit	se	lower	upper	*											
DE	1.523	0.098	1.327	1.720												
NZ	1.205	0.114	0.977	1.432												
Water	fit	se	lower	upper	***	fit	se	lower	upper	***	fit	se	lower	upper	***	
well	1.756	1.102	1.552	1.961		3.716	0.156	3.404	4.027		5.667	0.252	5.163	6.171		
low	1.028	1.102	0.824	1.233		1.758	0.155	1.449	2.067		2.892	0.259	2.375	3.409		
Origin x Water																
DE well												fit	se	lower	upper	*
NZ well												8.858	0.500	7.858	9.858	
DE low												6.907	0.561	5.784	8.030	
NZ low												3.601	0.497	2.607	4.595	
												3.281	0.578	2.125	4.436	
Aboveground biomass																
Origin	fit	se	lower	upper	*											
DE	1.155	0.074	1.007	1.303												
NZ	0.915	0.086	0.743	1.088												
Water	fit	se	lower	upper	***	fit	se	lower	upper	***	fit	se	lower	upper	***	
well	1.311	0.077	1.156	1.465		2.468	0.100	2.268	2.668		3.746	0.164	3.417	4.075		
low	0.802	0.077	0.648	0.957		1.357	0.099	1.159	1.554		2.314	0.169	1.977	2.652		
Origin x Water																
DE well												fit	se	lower	upper	***
NZ well												4.157	0.230	3.696	4.618	
DE low												2.674	0.232	2.210	3.139	
NZ low																
Belowground biomass																
Origin	fit	se	lower	upper	*											
DE	0.368	0.025	0.318	0.418												
NZ	0.289	0.030	0.230	0.349												
Water	fit	se	lower	upper	***	fit	se	lower	upper	***	fit	se	lower	upper	***	
well	0.446	0.026	0.394	0.499		1.245	0.067	1.111	1.379		1.935	0.154	1.627	2.243		
low	0.225	0.026	0.173	0.278		0.404	0.067	0.271	0.538		0.571	0.156	0.259	0.882		
Origin x Water																
DE well						fit	se	lower	upper	**						
NZ well						1.375	0.076	1.223	1.527			fit	se	lower	upper	**
DE low						1.078	0.082	0.915	1.241			4.505	0.269	3.966	5.043	
NZ low						0.377	0.077	0.222	0.531			2.997	0.300	2.395	3.598	
UV-B x Water																
- UV-B well						fit	se	lower	upper	*						
+ UV-B well						1.425	0.095	1.236	1.615			0.705	0.267	0.171	1.239	
- UV-B low						1.070	0.094	0.882	1.259			0.913	0.312	0.290	1.537	
+ UV-B low						0.441	0.094	0.253	0.629							
						0.368	0.094	0.180	0.557							
Shoot:mass ratio																
Water	fit	se	lower	upper	*	fit	se	lower	upper	***	fit	se	lower	upper	***	
well	0.753	0.008	0.737	0.769		0.664	0.013	0.639	0.689		0.667	0.017	0.633	0.701		
low	0.779	0.008	0.762	0.795		0.774	0.012	0.749	0.798		0.800	0.017	0.767	0.834		
Origin x Water																
DE well												fit	se	lower	upper	*
NZ well												0.510	0.017	0.475	0.545	
DE low												0.557	0.019	0.518	0.596	
NZ low												0.784	0.017	0.749	0.819	
												0.781	0.020	0.741	0.821	
Root dry matter content																
Origin						fit	se	lower	upper	*						
DE						12.740	0.323	12.094	13.386							
NZ						11.616	0.374	10.867	12.364							
Water	fit	se	lower	upper	***						fit	se	lower	upper	*	
well	10.501	0.559	9.383	11.619							23.938	1.891	20.154	27.721		
low	13.693	0.559	12.575	14.811							29.064	1.948	25.166	32.961		
UV-B x Water																
- UV-B well						fit	se	lower	upper	*						
+ UV-B well						12.487	0.441	11.607	13.368							
- UV-B low						11.407	0.431	10.545	12.269							
+ UV-B low						12.174	0.429	11.317	13.032							
						12.915	0.431	12.055	13.776							
Leaf dry matter content																
Origin	fit	se	lower	upper	*	fit	se	lower	upper	***						
DE	17.221	0.356	16.508	17.934		19.461	0.321	18.820	20.102							
NZ	15.867	0.436	14.994	16.741		17.391	0.376	16.639	18.143							
Water	fit	se	lower	upper	***	fit	se	lower	upper	***	fit	se	lower	upper	**	
well	14.668	0.376	13.916	15.420		19.510	0.304	18.902	20.117		28.482	0.719	27.044	29.921		
low	18.744	0.381	17.980	19.507		17.631	0.299	17.032	18.230		32.743	0.740	31.262	34.224		
Specific leaf area																
Water						fit	se	lower	upper	*	fit	se	lower	upper	*	
well						16.499	1.289	13.922	19.076		13.976	0.841	12.293	15.658		
low						19.844	1.276	17.294	22.394		11.979	0.848	10.282	13.675		
Origin x Water																
DE well												fit	se	lower	upper	**
NZ well												18.610	0.930	16.749	20.471	
DE low												17.105	1.045	15.456	19.634	
NZ low												17.569	0.924	15.720	19.417	
												21.314	1.075	19.165	23.464	

Table IV.S1 continued

	1st harvest (3 weeks)				2nd harvest (6 weeks)				3rd harvest (9 weeks)				4th harvest (12 weeks)			
Leaf number																
UV-B																
- UV-B					fit	se	lower	upper	**							
+ UV-B					15.187	0.317	14.553	15.821								
					16.062	0.314	15.434	16.691								
Water																
	fit	se	lower	upper	***	fit	se	lower	upper	***	fit	se	lower	upper	***	
well	11.811	0.219	11.373	12.249		16.888	0.317	16.254	17.522		19.198	0.442	18.314	20.082		
low	10.689	0.219	10.251	11.127		14.409	0.315	13.780	15.038		16.717	0.451	15.816	17.619		
Origin x UV-B																
DE - UV-B										fit	se	lower	upper	*		
NZ - UV-B										18.732	0.605	17.522	19.942			
DE + UV-B										17.342	0.716	15.908	18.775			
NZ + UV-B										17.702	0.603	16.496	18.909			
										18.009	0.711	16.587	19.432			
Origin x Water																
DE well										fit	se	lower	upper	**		
NZ well										24.565	0.750	23.065	26.065			
DE low										21.817	0.833	20.152	23.483			
NZ low										19.114	0.745	17.624	20.604			
										18.814	0.846	17.121	20.506			
Proportion of dead leaves																
Water																
well										fit	se	lower	upper	*		
low										29.530	1.652	26.226	32.834			
										33.391	1.664	30.062	36.719			
Origin x UV-B																
DE - UV-B	fit	se	lower	upper	**											
NZ - UV-B	22.798	3.341	16.112	29.484												
DE + UV-B	17.054	3.690	9.669	24.438												
NZ + UV-B	17.674	3.335	11.000	24.348												
	26.486	3.734	19.013	33.958												
Origin x Water																
DE well					fit	se	lower	upper	*							
NZ well					26.070	2.338	21.397	30.743								
DE low					29.248	2.665	23.921	34.575								
NZ low					27.735	2.394	22.949	32.521								
					22.635	2.835	16.968	28.302								
Leaf length																
UV-B																
- UV-B	fit	se	lower	upper	*					fit	se	lower	upper	*		
+ UV-B	15.91784	0.447	15.02325	16.81244						14.251	0.282	13.687	14.815			
	10.80275	0.447	9.908	11.69734						13.393	0.282	12.829	13.956			
Water																
	fit	se	lower	upper	*	fit	se	lower	upper	***	fit	se	lower	upper	***	
well	13.962	0.399	13.163	14.761		16.905	0.273	16.360	17.451		15.733	0.278	15.177	16.289		
low	12.759	0.399	11.960	13.557		12.544	0.269	12.007	13.082		11.795	0.286	11.223	12.367		
Origin x Water																
DE well					fit	se	lower	upper	**	fit	se	lower	upper	*		
NZ well					16.442	0.380	15.682	17.202		15.133	0.386	14.360	15.905			
DE low					17.504	0.434	16.635	18.372		15.562	0.433	14.695	16.429			
NZ low					13.031	0.389	12.254	13.809		12.510	0.384	11.743	13.278			
					11.916	0.460	10.995	12.836		11.377	0.445	10.487	12.267			
Leaf width																
Origin																
DE	fit	se	lower	upper	*	fit	se	lower	upper	*						
NZ	6.208	0.239	5.730	6.686		6.575	0.155	6.266	6.885							
	5.649	0.261	5.128	6.171		6.008	0.179	5.650	6.367							
Water																
	fit	se	lower	upper	***	fit	se	lower	upper	***	fit	se	lower	upper	***	
well	6.440	0.239	5.962	6.918		7.208	0.124	6.960	7.456		6.862	0.187	6.489	7.236		
low	5.516	0.239	5.038	5.993		5.472	0.123	5.226	5.718		5.605	0.190	5.225	5.985		
											fit	se	lower	upper	*	
DE well										6.877	0.249	6.378	7.376			
NZ well										6.841	0.287	6.267	7.416			
DE low										5.910	0.248	5.414	6.406			
NZ low										5.170	0.301	4.567	5.773			
Rosette area																
UV-B																
- UV-B	fit	se	lower	upper	*											
+ UV-B	446.187	28.721	388.716	503.659												
	206.260	28.721	148.788	263.731												
Water																
well					fit	se	lower	upper	***	fit	se	lower	upper	***		
low					556.943	17.94022	521.081	592.805		642.2073	20.5646	601.0577	683.3568			
					303.375	17.71059	267.972	338.778		367.8283	21.1644	325.4784	410.1783			
										fit	se	lower	upper	***		
										269.643	20.956	227.724	311.561			
PSII efficiency (Y)																
UV-B																
- UV-B	fit	se	lower	upper	**											
+ UV-B	0.825	0.002	0.821	0.829												
	0.834	0.002	0.830	0.838												
Water																
	fit	se	lower	upper	**	fit	se	lower	upper	***	fit	se	lower	upper	**	
well	0.825	0.002	0.821	0.830		0.814	0.003	0.809	0.820		0.802	0.004	0.795	0.809		
low	0.834	0.002	0.830	0.838		0.825	0.003	0.819	0.830		0.818	0.004	0.811	0.825		
						fit	se	lower	upper	**						
UV-B x Water						0.805	0.004	0.798	0.812							
- UV-B well						0.823	0.004	0.816	0.830							
+ UV-B well						0.824	0.004	0.817	0.831							
- UV-B low						0.826	0.004	0.819	0.833							
+ UV-B low																
Min. chlorophyll fluorescence (F_o)																
Origin																
DE	fit	se	lower	upper	*	fit	se	lower	upper	*	fit	se	lower	upper	**	
NZ	394.810	8.499	377.822	411.799		378.2706	11.9998	354.2591	402.2822		354.963	15.473	324.012	385.914		
	427.996	9.802	408.401	447.590		414.4455	13.7182	386.9955	441.8955		388.209	15.966	356.272	420.147		
Water																
	fit	se	lower	upper	**	fit	se	lower	upper	*	fit	se	lower	upper	***	
well	418.098	7.248	403.594	432.601		418.183	7.363	403.465	432.901		354.120	15.267	323.581	384.659		
low	389.344	7.248	374.840	403.847		400.663	7.290	386.090	415.236		385.165	15.311	354.538	415.793		
Origin x UV-B																
DE - UV-B	fit	se	lower	upper	*											
NZ - UV-B	405.511	9.782	385.937	425.085												
DE + UV-B	426.437	11.016	404.394	448.480												
NZ + UV-B	399.024	9.761	379.493	418.555												
	385.156	11.170	362.805	407.507												
UV-B x Water																
- UV-B well					fit	se	lower	upper	**							
+ UV-B well					448.308	9.873	428.571	468.045								
- UV-B low					388.895	9.688	369.529	408.262								
+ UV-B low					405.610	9.635	386.351	424.870								
					395.853	9.676	376.511	415.194								
Max. chlorophyll fluorescence (F_m)																
Water																
well					fit	se	lower	upper	**	fit	se	lower	upper	***		
low					1995.441	78.317	1838.728	2152.153		1734.201	85.130	1563.916	1904.486			
					2154.388	78.750	1996.809	2311.966		1965.041	85.261	1794.493	2135.588			
Origin x UV-B																
DE - UV-B	fit	se	lower	upper	*											
NZ - UV-B	2334.922	45.296	2244.285	2425.560												
DE + UV-B	2431.805	53.113	2325.527	2538.083												
NZ + UV-B	2431.648	45.158	2341.288	2522.008												
	2293.737	54.066	2185.550	2401.923												

Table IV.S2: Effect directions of repeated measures analysis. Predicted values ('fit') and confidence interval ('SE') and confidence interval ('lower' and 'upper' limits) are given for all significant main and twofold interaction effects of 'Origin', 'UV-B', 'Water' and 'Time' in the repeated measures analysis. Significance levels of effects are indicated by asterisks (* $p < 0.05$; ** $p < 0.01$; *** $p < 0.001$).

Origin	leaf number			leaf length			leaf width			proportion of dead leaves			
	fit	se	upper	fit	se	upper	fit	se	upper	fit	se	upper	
DE	9.942	0.246	10.426	12.959	0.252	13.454	6.076	0.587	7.227	2.650	0.133	2.389	
NZ	8.755	0.276	9.296	11.590	0.278	12.137	4.956	0.615	6.162	2.552	0.133	2.290	
Water	fit	se	upper	fit	se	upper	fit	se	upper	fit	se	upper	
well	10.185	0.203	10.583	14.091	0.224	14.531	6.231	0.536	7.283	5.180	0.133	2.389	
low	8.675	0.203	9.074	10.628	0.225	11.069	4.955	0.536	6.006	2.552	0.133	2.290	
Time	fit	se	upper	fit	se	upper	fit	se	upper	fit	se	upper	
0	6.924	0.191	7.298	9.376	0.235	9.836	4.465	0.537	5.518	0	0.309	0.067	
20	8.797	0.189	9.167	11.614	0.206	12.018	5.311	0.535	6.260	20	2.017	1.775	
40	10.670	0.198	11.059	13.851	0.222	14.285	6.156	0.535	7.206	40	3.725	3.468	
60	12.544	0.218	12.971	16.088	0.273	16.622	7.002	0.538	8.056	60	5.434	5.147	
80	14.417	0.245	14.898	18.325	0.344	19.001	7.847	0.542	8.910	80	7.142	6.816	
UV-B x Time	fit	se	upper	fit	se	upper	fit	se	upper	fit	se	upper	
- UV-B	0	6.938	0.217	7.363	0	4.626	0.710	3.234	6.018	- UV-B	0	3.234	
+ UV-B	0	6.910	0.216	7.333	0	4.307	0.710	2.916	5.699	+ UV-B	0	2.916	
- UV-B	20	8.691	0.213	9.108	5.333	0.707	3.946	6.720	6.676	- UV-B	20	3.902	
+ UV-B	20	8.902	0.212	9.318	5.289	0.707	3.902	6.676	6.676	+ UV-B	20	3.902	
- UV-B	40	10.443	0.229	10.893	6.040	0.708	4.651	7.428	7.428	- UV-B	40	4.651	
+ UV-B	40	10.895	0.229	11.343	6.271	0.708	4.883	7.659	7.659	+ UV-B	40	4.883	
- UV-B	60	12.196	0.263	12.711	6.746	0.711	5.351	8.142	8.142	- UV-B	60	5.351	
+ UV-B	60	12.887	0.262	13.400	7.253	0.711	5.858	8.648	8.648	+ UV-B	60	5.858	
- UV-B	80	13.948	0.308	14.552	7.453	0.718	6.045	8.861	8.861	- UV-B	80	6.045	
+ UV-B	80	14.880	0.306	15.480	8.235	0.718	6.827	9.643	9.643	+ UV-B	80	6.827	
Origin x Time	fit	se	upper	fit	se	upper	fit	se	upper	fit	se	upper	
DE	0	10.658	0.291	10.087	11.230	11.230	0	5.082	6.238	DE	0	5.082	
NZ	0	7.643	0.327	7.002	8.284	8.284	0	3.632	4.845	NZ	0	3.632	
DE	20	12.373	0.252	11.880	12.867	12.867	20	5.823	6.974	DE	20	5.823	
NZ	20	10.586	0.278	10.040	11.132	11.132	20	4.619	5.825	NZ	20	4.619	
DE	40	14.089	0.273	13.553	14.625	14.625	40	6.564	7.716	DE	40	6.564	
NZ	40	13.529	0.304	12.932	14.125	14.125	40	5.606	6.813	NZ	40	5.606	
DE	60	15.804	0.345	15.128	16.480	16.480	60	7.304	8.465	DE	60	7.304	
NZ	60	16.472	0.390	15.707	17.237	17.237	60	6.592	7.810	NZ	60	6.592	
DE	80	17.519	0.443	16.651	18.387	18.387	80	8.045	9.219	DE	80	8.045	
NZ	80	19.415	0.506	18.422	20.408	20.408	80	7.579	8.813	NZ	80	7.579	
Water x Time	fit	se	upper	fit	se	upper	fit	se	upper	fit	se	upper	
well	0	10.332	0.273	9.796	10.868	10.868	well	0	4.821	5.879	well	0	4.821
low	0	8.401	0.274	7.863	8.939	8.939	low	0	4.103	5.161	low	0	4.103
well	20	13.134	0.224	12.695	13.573	13.573	well	20	5.872	6.924	well	20	5.872
low	20	10.061	0.224	9.622	10.501	10.501	low	20	4.738	5.790	low	20	4.738
well	40	11.179	0.209	10.729	11.579	11.579	well	40	6.924	7.977	well	40	6.924
low	40	9.718	0.217	9.292	10.144	10.144	low	40	5.373	6.426	low	40	5.373
well	60	13.760	0.251	13.267	14.252	14.252	well	60	7.975	9.037	well	60	7.975
low	60	11.303	0.253	10.808	11.798	11.798	low	60	6.008	7.071	low	60	6.008
well	80	15.915	0.297	15.333	16.498	16.498	well	80	9.027	10.105	well	80	9.027
low	80	12.888	0.299	12.301	13.475	13.475	low	80	6.643	7.723	low	80	6.643
Water x Time	fit	se	upper	fit	se	upper	fit	se	upper	fit	se	upper	
well	0	0.163	0.130	-0.091	0.418	0.418	well	0	0.163	0.130	well	0	0.163
low	0	0.457	0.130	0.202	0.712	0.712	low	0	0.457	0.130	low	0	0.457
well	20	2.016	0.130	1.762	2.27	2.27	well	20	2.016	0.130	well	20	2.016
low	20	2.018	0.130	1.764	2.272	2.272	low	20	2.018	0.130	low	20	2.018
well	40	3.869	0.144	3.586	4.152	4.152	well	40	3.869	0.144	well	40	3.869
low	40	3.579	0.144	3.295	3.862	3.862	low	40	3.579	0.144	low	40	3.579
well	60	5.722	0.170	5.389	6.056	6.056	well	60	5.722	0.170	well	60	5.722
low	60	5.139	0.171	4.803	5.475	5.475	low	60	5.139	0.171	low	60	5.139
well	80	7.575	0.203	7.177	7.973	7.973	well	80	7.575	0.203	well	80	7.575
low	80	6.700	0.205	6.298	7.102	7.102	low	80	6.700	0.205	low	80	6.700

Table IV.S2 continued

rosette area				PSII efficiency (V)				min. chlorophyll fluorescence				max. chlorophyll fluorescence							
Origin	fit	se	upper ***	Origin	fit	se	upper **	Origin	fit	se	upper **	Origin	fit	se	upper **				
DE	355.742	18.738	318.992	392.493	DE	0.822	0.002	0.818	DE	407.458	5.431	396.808	418.108	0	2393.358	127.066	2144.163	2642.554	
NZ	285.245	20.375	245.285	325.204	NZ	0.814	0.002	0.811	NZ	434.476	5.992	422.724	446.228	0	2438.760	127.059	2189.579	2687.942	
Water	fit	se	upper ***	fit	se	upper ***	fit	se	fit	se	upper *	Water	fit	se	upper ***	fit	se	upper ***	
well	420.729	16.101	389.150	452.307	well	0.814	0.002	0.811	well	423.606	4.556	414.671	432.542	well	2303.269	89.985	2126.794	2479.743	
low	228.859	16.112	197.260	260.459	low	0.814	0.002	0.811	low	413.801	4.561	404.857	422.745	low	2308.768	89.989	2132.285	2485.250	
Time	fit	se	upper ***	fit	se	upper ***	fit	se	fit	se	upper ***	Time	fit	se	upper ***	fit	se	upper ***	
0	158.289	16.121	126.671	189.907	0	0.814	0.002	0.811	0	439.693	4.578	430.715	448.670	0	2416.228	89.985	2239.755	2592.701	
20	283.143	15.665	252.419	313.866	20	0.814	0.001	0.811	20	419.798	4.385	411.199	428.398	20	2311.483	89.860	2135.254	2487.713	
40	408.000	15.941	376.731	439.260	40	0.814	0.001	0.811	40	399.904	4.520	391.038	408.769	40	2206.739	90.005	2030.227	2383.251	
60	532.849	16.914	499.677	566.021	60	0.814	0.001	0.811	60	380.009	4.957	370.287	389.731	60	2101.995	90.416	1934.676	2279.314	
80	657.702	18.473	621.471	693.932	80	0.825	0.002	0.820	80	360.115	5.626	349.081	371.148	80	1997.250	91.091	1818.608	2175.892	
Origin x Time	fit	se	lower	upper ***	Origin	fit	se	lower	upper *	Origin	fit	se	lower	upper ***	Origin	fit	se	lower	upper **
DE	0	206.761	19.378	168.756	244.766	-UV-B	0	0.817	0.002	0.814	0.820	-UV-B	0	2393.358	127.066	2144.163	2642.554		
NZ	0	92.742	21.184	51.196	134.289	+UV-B	0	0.819	0.002	0.816	0.822	+UV-B	0	2438.760	127.059	2189.579	2687.942		
DE	20	317.822	18.720	281.107	354.537	-UV-B	20	0.816	0.001	0.813	0.818	-UV-B	20	2304.274	126.889	2055.426	2553.123		
NZ	20	236.247	20.355	196.325	276.169	+UV-B	20	0.821	0.001	0.818	0.823	+UV-B	20	2318.586	126.885	2069.746	2567.426		
DE	40	428.882	19.125	391.375	466.390	-UV-B	40	0.815	0.002	0.812	0.818	-UV-B	40	2215.191	127.096	1965.936	2464.445		
NZ	40	379.751	20.848	338.863	420.639	+UV-B	40	0.822	0.002	0.819	0.825	+UV-B	40	2198.412	127.087	1949.175	2447.648		
DE	60	539.943	20.529	499.681	580.205	-UV-B	60	0.814	0.002	0.810	0.818	-UV-B	60	2126.107	127.684	1875.699	2376.515		
NZ	60	523.255	22.575	478.980	567.530	+UV-B	60	0.824	0.002	0.820	0.827	+UV-B	60	2078.237	127.664	1827.869	2328.606		
DE	80	651.004	22.748	606.389	695.619	-UV-B	80	0.813	0.002	0.808	0.818	-UV-B	80	2037.023	128.649	1784.724	2289.323		
NZ	80	666.759	25.285	617.170	716.349	+UV-B	80	0.825	0.002	0.820	0.830	+UV-B	80	1958.063	128.611	1705.838	2210.288		
Origin x Time	fit	se	lower	upper ***	Origin	fit	se	lower	upper ***	Origin	fit	se	lower	upper ***	Origin	fit	se	lower	upper **
DE	0	193.729	16.949	160.488	226.970	well	0	0.818	0.002	0.815	0.821	well	0	2434.017	90.370	2228.389	2582.746		
low	0	122.120	16.970	88.837	155.402	low	0	0.819	0.002	0.816	0.822	low	0	2398.065	90.237	2221.096	2575.034		
DE	20	362.950	16.079	331.415	394.485	well	20	0.816	0.001	0.813	0.819	well	20	2309.785	89.984	2133.313	2486.256		
NZ	20	201.691	16.087	170.140	233.241	low	20	0.821	0.001	0.818	0.824	low	20	2313.218	89.987	2136.739	2489.697		
DE	40	532.171	16.605	499.605	564.738	well	40	0.814	0.002	0.811	0.817	well	40	2185.552	90.267	2008.526	2362.578		
low	40	281.261	16.632	248.641	313.881	low	40	0.823	0.002	0.820	0.826	low	40	2228.371	90.281	2051.316	2405.426		
DE	60	701.392	18.407	665.292	737.492	well	60	0.813	0.002	0.809	0.816	well	60	2061.319	91.072	1882.713	2239.926		
NZ	60	360.832	18.480	324.588	397.076	low	60	0.825	0.002	0.822	0.829	low	60	2143.524	91.113	1964.838	2322.210		
DE	80	870.613	21.151	829.111	912.116	well	80	0.811	0.002	0.806	0.816	well	80	1937.087	92.387	1755.902	2118.272		
NZ	80	440.403	21.294	398.640	482.165	low	80	0.828	0.002	0.823	0.832	low	80	2058.677	92.469	1877.333	2240.022		
Origin x UV-B	fit	se	lower	upper *	Origin	fit	se	lower	upper *	Origin	fit	se	lower	upper *	Origin	fit	se	lower	upper *
DE	-UV-B	0	2264.442	127.168	2513.838	DE	-UV-B	0	0.815	0.821	DE	-UV-B	0	2434.017	90.370	2228.389	2582.746		
NZ	-UV-B	0	2348.535	127.590	2598.365	NZ	-UV-B	0	0.816	0.822	NZ	-UV-B	0	2398.065	90.237	2221.096	2575.034		
DE	+UV-B	20	2300.483	127.165	2549.872	DE	+UV-B	20	0.813	0.819	DE	+UV-B	20	2309.785	89.984	2133.313	2486.256		
NZ	+UV-B	20	2328.705	127.369	2578.495	NZ	+UV-B	20	0.814	0.820	NZ	+UV-B	20	2313.218	89.987	2136.739	2489.697		

Supporting Information

Table IV.S3: Fixed-effect results of the harvest data analysis. ,UV-B’ and ‘Water’ depict the effect of treatments, ‘Origin’ refers to the effect of German vs. New Zealand provenance. Degrees of freedom (dfN = numerator, dfD = denominator), F statistics (F), and significance values (P) are provided. Values in boldface type indicate significant P values (*P < 0.05; **P < 0.01; ***P < 0.001) and values in italic typeface indicate marginal effects. (P < 0.1).

Variable / Source	1st harvest (3 weeks)				2nd harvest (6 weeks)				3rd harvest (9 weeks)				4th harvest (12 weeks)				
	df _N	df _D	F	p	df _N	df _D	F	p	df _N	df _D	F	p	df _N	df _D	F	p	
Leaf number																	
Origin	1	16.5	0.366	0.554	20.7	0.176	0.680		20.8	0.390	0.539		17.9	2.131	0.162		
UV-B	1	44.3	0.050	0.825	46.1	8.537	0.005	**	44.0	0.200	0.657		1.6	0.150	0.743		
Water	1	45.3	15.466	<0.001	***	46.1	60.636	<0.001	***	44.0	40.880	<0.001	***	44.6	111.702	<0.001	***
Initial leaf number (Covariate)	1	49.5	52.319	<0.001	***	52.4	12.779	<0.001	***	53.2	15.095	<0.001	***	55.9	24.796	<0.001	***
Origin x UV-B	1	44.2	0.289	0.594	47.0	0.959	0.332		43.9	4.556	0.038	*	42.2	0.078	0.782		
Origin x Water	1	44.3	0.025	0.875	47.0	0.655	0.422		43.9	0.457	0.503		44.2	9.566	0.003	**	
UV-B x Water	1	44.9	0.225	0.637	47.1	0.000	0.993		44.0	0.116	0.735		44.5	0.549	0.463		
Origin x UV-B x Water	1	44.1	1.865	0.179	46.5	0.244	0.624		43.9	0.219	0.642		45.5	0.244	0.623		
Proportion of dead leaves																	
Origin	1	57.0	0.293	0.590	18.8	0.082	0.778		18.7	0.43487	0.518		17.8	0.885	0.360		
UV-B	1	1.5	0.265	0.671	45.1	2.358	0.132		1.7	0.0033	0.960		44.2	0.382	0.540		
Water	1	58.0	3.368	0.072	45.2	1.677	0.202		41.1	0.14482	0.706		44.3	6.813	0.012	*	
Initial leaf number (Covariate)	1	57.1	19.180	<0.001	***	41.0	0.535	0.469	55.0	3.1216	0.083	.	59.0	0.214	0.645		
Origin x UV-B	1	57.0	7.745	0.007	**	46.1	0.003	0.957	38.9	2.73949	0.106		44.1	0.136	0.714		
Origin x Water	1	41.3	1.283	0.264	46.2	4.581	0.038	*	41.1	0.00291	0.957		44.2	0.026	0.872		
UV-B x Water	1	58.0	0.045	0.832	46.2	0.505	0.481		41.2	0.00179	0.966		44.2	1.002	0.322		
Origin x UV-B x Water	1	41.0	0.997	0.324	45.6	1.426	0.239		41.2	0.81822	0.371		45.4	0.726	0.399		
Leaf length																	
Origin	1	16.0	3.161	0.094	62.0	0.003	0.953		23.2	0.057	0.813		18.9	0.447	0.512		
UV-B	1	1.4	67.862	0.039	*	62.0	0.702	0.405	44.4	6.697	0.013	*	45.2	1.672	0.203		
Water	1	43.9	6.304	0.016	*	62.0	135.225	<0.001	***	44.5	126.87	<0.001	***	45.2	134.029	<0.001	***
Initial leaf number (Covariate)	1	42.1	2.924	0.095	62.0	1.510	0.224		58.9	0.019	0.891		59.9	0.404	0.527		
Origin x UV-B	1	41.8	0.504	0.482	62.0	0.168	0.683		44.4	1.412	0.241		45.1	0.664	0.419		
Origin x Water	1	26.1	0.000	0.987	62.0	7.756	0.007	**	44.4	2.188	0.146		45.2	7.134	0.010	*	
UV-B x Water	1	43.5	0.287	0.595	62.0	1.845	0.179		44.4	0.339	0.562		45.1	0.897	0.349		
Origin x UV-B x Water	1	25.8	0.930	0.344	62.0	0.000	0.985		44.4	0.286	0.595		46.6	0.975	0.329		
Leaf width																	
Origin	1	17.1	5.067	0.038	*	21.8	4.894	0.038	*	21.5	1.218	0.282		19.4	3.744	0.068	.
UV-B	1	1.7	13.612	0.085	.	47.1	0.198	0.659	1.5	0.544	0.560		1.8	19.048	0.058	.	
Water	1	44.3	21.783	<0.001	***	47.1	191.932	<0.001	***	40.2	62.907	<0.001	***	46.8	18.847	<0.001	***
Initial leaf number (Covariate)	1	45.9	0.209	0.649	51.6	1.125	0.294		54.0	1.446	0.234		46.1	0.541	0.466		
Origin x UV-B	1	42.8	0.060	0.808	48.0	0.118	0.733		42.3	2.027	0.162		44.7	1.607	0.212		
Origin x Water	1	42.6	1.121	0.296	48.0	0.438	0.511		40.1	4.486	0.040	*	46.4	0.002	0.963		
UV-B x Water	1	43.9	1.148	0.290	48.1	0.057	0.812		39.1	1.643	0.207		46.5	4.007	0.051	.	
Origin x UV-B x Water	1	42.5	0.551	0.462	47.5	2.187	0.146		38.7	0.627	0.433		48.6	0.443	0.509		
Rosette area																	
Origin	1	16.5	0.717	0.409	17.5	0.538	0.473		17.2	0.384	0.543		19.8	3.123	0.093	.	
UV-B	1	1.5	38.547	0.049	*	45.1	1.458	0.234	1.2	0.479	0.597		1.9	6.899	0.127	.	
Water	1	44.0	3.528	0.067	.	45.2	116.426	<0.001	***	30.0	107.454	<0.001	***	46.1	78.247	<0.001	***
Initial leaf number (Covariate)	1	47.8	0.013	0.909	32.1	0.379	0.542		57.4	2.388	0.128		54.4	0.011	0.917		
Origin x UV-B	1	42.2	0.419	0.521	46.0	1.412	0.241		36.8	1.420	0.241		44.3	2.222	0.143		
Origin x Water	1	32.7	0.741	0.396	46.2	0.148	0.703		30.3	2.909	0.098	.	45.6	0.899	0.348		
UV-B x Water	1	43.7	1.428	0.238	46.1	1.192	0.281		28.9	1.020	0.321		45.9	2.367	0.131		
Origin x UV-B x Water	1	32.4	0.000	0.999	45.5	0.001	0.971		28.6	0.371	0.547		47.9	0.005	0.943		
PSII efficiency (Y)																	
Origin	1	59.0	0.752	0.389	20.6	3.504	0.075	.	22.0	1.128	0.300		18.3	2.246	0.151	.	
UV-B	1	59.0	9.160	0.004	**	1.8	8.962	0.107	1.7	0.068	0.823		1.7	17.498	0.068	.	
Water	1	59.0	8.725	0.005	**	45.4	12.675	0.001	***	43.3	23.580	<0.001	***	44.9	11.329	0.002	**
Initial leaf number (Covariate)	1	59.0	9.242	0.004	**	43.5	0.969	0.330	58.5	3.394	0.071	.	56.8	1.561	0.217		
Origin x UV-B	1	59.0	0.233	0.631	45.3	0.004	0.953		41.2	0.129	0.721		42.7	2.381	0.130		
Origin x Water	1	59.0	0.038	0.847	44.9	0.043	0.827		43.3	0.198	0.659		44.6	0.028	0.869		
UV-B x Water	1	59.0	1.451	0.233	46.3	8.507	0.005	**	43.3	1.444	0.236		44.8	1.565	0.217		
Origin x UV-B x Water	1	59.0	0.001	0.970	44.2	2.289	0.137		43.3	0.095	0.760		45.9	0.674	0.416		
Min. chlorophyll fluorescence (F₀)																	
Origin	1	57.0	0.148	0.702	20.2	5.901	0.025	*	24.1	4.960	0.036	*	18.9	9.213	0.007	**	
UV-B	1	1.4	4.054	0.231	1.9	13.014	0.073	.	1.7	1.562	0.358		2.0	0.529	0.544		
Water	1	58.2	10.856	0.002	**	46.1	4.921	0.032	*	44.5	0.367	0.548		44.4	12.962	0.001	***
Initial leaf number (Covariate)	1	57.2	22.879	<0.001	***	38.5	0.082	0.776	58.3	0.323	0.572		51.0	0.340	0.562		
Origin x UV-B	1	57.0	4.230	0.044	*	46.1	0.208	0.650	43.1	0.961	0.333		43.5	1.740	0.194		
Origin x Water	1	32.5	0.075	0.787	45.8	0.540	0.466		44.5	1.030	0.316		43.8	0.802	0.375		
UV-B x Water	1	58.2	2.272	0.137	47.0	9.555	0.003	**	44.3	0.071	0.791		44.1	0.230	0.634		
Origin x UV-B x Water	1	32.1	0.321	0.575	45.2	1.390	0.245		44.2	1.160	0.287		46.2	2.430	0.126		
Max. chlorophyll fluorescence (F_m)																	
Origin	1	57.3	0.167	0.684	20.5	0.930	0.346		21.9	3.334	0.081	.	19.4	1.546	0.229		
UV-B	1	1.2	0.165	0.746	1.9	1.486	0.353		1.9	0.434	0.581		2.0	1.926	0.300		
Water	1	58.8	0.964	0.330	46.2	1.120	0.295		42.2	9.100	0.004	**	44.0	46.199	<0.001	***	
Initial leaf number (Covariate)	1	57.3	6.320	0.015	*	37.1	0.501	0.483	56.9	0.262	0.610		57.0	0.320	0.574		
Origin x UV-B	1	57.3	6.428	0.014	*	46.6	0.189	0.666	41.1	0.791	0.379		43.4	0.126	0.725		
Origin x Water	1	16.8	0.745	0.400	46.4	0.336	0.565		42.3	0.177	0.676		43.5	0.691	0.411		
UV-B x Water	1	58.8	0.327	0.570	47.0	0.901	0.347		42.5	0.278	0.601		43.9	0.020	0.888		
Origin x UV-B x Water	1	16.5	0.444	0.515	45.8	0.009	0.926		42.6	1.098	0.301		45.7	1.404	0.242		

Table IV.S4: Location and sampling information of native (German) and exotic (New Zealand) populations included in the experiment

<i>Origin</i>	<i>Latitude</i>	<i>Longitude</i>	<i>Locality</i>	<i>Collection year</i>	<i>n</i>
Germany (native)	51.48431	11.90097	Nietleben	2012	16
	51.62067	11.74124	Friedenburg	2012	16
	51.52282	12.00856	Tornau	2012	15
	51.51693	12.01146	Mötzlich	2012	16
	51.74834	11.02791	Thale	2012	16
	51.78530	11.15421	Quedlinburg I	2012	16
	51.77611	11.13432	Quedlinburg II	2012	16
	51.73221	11.21278	Ballenstedt	2012	16
	51.75651	11.09018	Teufelsmauer	2012	16
	54.34805	10.11666	Botanical Garden Kiel	2012	16
New Zealand (exotic)	-44.16828	170.20950	Lake Pukaki East	2012	16
	-44.11396	170.12698	Lake Pukaki West	2012	15
	-43.06517	172.75104	Waipara	2012	15
	-44.59621	170.19031	Lake Aviemore West	2011	16
	-44.00175	170.47316	Lake Tekapo	2011	16
	-44.08105	170.97570	Opuha River	2011	16
	-44.18910	170.11126	Lake Pukaki South	2011	16
	-44.16550	170.21433	Hayman Road	2011	7

Danksagung

Danksagung

Prof. Alexandra Erfmeier danke ich herzlich für die Betreuung meiner Promotion. Seit dem Ökologie-Grundpraktikum sind nun bereits 10 Jahre vergangen, in denen ich unglaublich viel von dir gelernt habe. Danke für deine Unterstützung und dein Vertrauen in mich!

Bei Prof. Thorsten Reusch möchte ich mich ebenfalls herzlich für die Bereitschaft zur Begutachtung dieser Arbeit bedanken.

Besonderer Dank gebührt natürlich auch Rainer und Angelika Hofmann, die mir den Aufenthalt und die Arbeit in Neuseeland so leicht und angenehm wie möglich gemacht. Ich danke euch für die fachliche Unterstützung ebenso wie für die stets offene Tür und die herzliche Aufnahme am anderen Ende der Welt.

An dieser Stelle danke ich außerdem Prof. Helge Bruelheide, der nicht nur maßgeblich zu meiner geobotanischen Grundausbildung beigetragen hat, sondern in dessen Arbeitsgruppe ich auch darüber hinaus immer willkommen war und unterstützt wurde.

Selbstverständlich danke ich der Landesgraduiertenförderung des Landes Sachsen-Anhalt und der FAZIT-Stiftung für die finanzielle Förderung durch Promotionsstipendien, die mir diese Qualifikation überhaupt ermöglicht haben.

Großen Dank möchte ich außerdem allen Mitglieder der Geobotanik-Arbeitsgruppen an der Martin-Luther-Universität Halle-Wittenberg und der Christian-Albrechts-Universität zu Kiel aussprechen. Die Zeit an beiden Universitäten habe ich aufgrund der angenehmen Atmosphäre und der interessanten Menschen sehr genossen. In allen Konstellationen war ich froh über meine Bürogesellschaft, in der Leid und Schokolade immer geteilt wurden.

Für die Unterstützung bei der Vor- und Nachbereitung aller meiner Experimente möchte ich allen studentischen Hilfskräften in Halle, Kiel und Lincoln von Herzen danken. Ohne euch würde ich sicher noch heute Blätter zählen und Wurzeln waschen.

Besonderer Dank geht aber vor allem an all die wichtigen Menschen in meinem Familien- und Freundeskreis, die während der letzten Jahre an meiner Seite waren, mich oft motiviert aber vor allem auch für das richtige Maß an Ablenkung und viele schöne Momente gesorgt

Danksagung

haben. Insbesondere möchte ich meinen Eltern und René auf diesem Weg für die allumfassende Unterstützung während meiner gesamten Ausbildung danken. Wie sehr hätte ich mir gewünscht, dass wir einmal gemeinsam auf diesen Erfolg anstoßen!

Eidesstattliche Erklärung

Hiermit erkläre ich, dass ich die vorliegende Dissertation nach Inhalt und Form – abgesehen von der Beratung durch meine Betreuerin Prof. Dr. Alexandra Erfmeier – selbstständig und ohne fremde Hilfe angefertigt habe. Es wurden keine anderen als die angegebenen Quellen und Hilfsmittel benutzt und die den benutzten Quellen wörtlich oder inhaltlich entnommenen Stellen als solche kenntlich gemacht. Die Arbeit ist unter Einhaltung der Regeln der guten wissenschaftlichen Praxis der Deutschen Forschungsgemeinschaft entstanden. Diese Arbeit hat in gleicher oder ähnlicher Form noch keiner anderen Institution oder Prüfungsbehörde vorgelegen und ich habe bisher keine erfolglosen Promotionsversuche unternommen, noch wurde mir ein akademischer Titel entzogen. Da es sich bei der vorliegenden Arbeit um eine kumulative Dissertation handelt, wurden die einzelnen Kapitel in wissenschaftlichen Fachzeitschriften veröffentlicht. Dies ist entsprechend gekennzeichnet.

Kiel, den 07.07.2020

Maria Hock